

# FCC SAR Test Report

**Equipment** : Barcode Printer  
**Brand Name** : TSC  
**Model No.** : Alpha-4xxxxxxxx,PR4xxxxxxxx,GR4xxxxxxxx,  
44xxxxxxxx,TSC-4xxxxxxxx,CN-4xxxxxxxx  
BP-4xxxxxxxx  
(x=0-9, A-Z, a-z, "-", ".", "/", "\", "\_" or blank)  
**FCC ID** : VTV-RFWRN  
**Standard** : FCC 47 CFR Part 2 (2.1093)  
ANSI/IEEE C95.1-1992  
IEEE 1528-2003  
**Applicant** : TSC Auto ID Technology Co., Ltd.  
**Manufacturer** : No. 35, Sec. 2, Ligong 1st Rd., Wujie Town, I-Lan  
County 26841, TAIWAN

The product sample received on Sep. 04, 2015 and completely tested on Sep. 25, 2015. We, SPORTON INTERNATIONAL INC., would like to declare that the tested sample has been evaluated in accordance with the procedures and shown the compliance with the applicable technical standards.

The test results in this report apply exclusively to the tested model / sample. Without written approval of SPORTON INTERNATIONAL INC., the test report shall not be reproduced except in full.

Reviewed by:

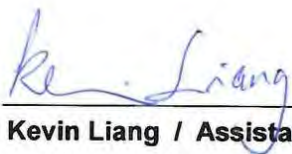
  
Kevin Liang / Assistant Manager



## Table of Contents

<b>STATEMENT OF COMPLIANCE</b>	<b>5</b>
1.1 Guidance Standard	5
1.2 Testing Location Information	5
1.3 Device Category and SAR Limits	6
<b>2 EQUIPMENT UNDER TEST (EUT)</b>	<b>7</b>
2.1 General Information	7
<b>3 MAXIMUM TUNE-UP LIMIT &amp; CONDUCTED RF OUTPUT POWER (UNIT: DBM)</b>	<b>8</b>
<b>4 RF EXPOSURE LIMITS</b>	<b>10</b>
4.1 Uncontrolled Environment	10
4.2 Controlled Environment	10
<b>5 SPECIFIC ABSORPTION RATE (SAR)</b>	<b>11</b>
5.1 Introduction	11
5.2 SAR Definition	11
<b>6 SYSTEM DESCRIPTION AND SETUP</b>	<b>12</b>
6.1 E-Field Probe	13
6.2 E-Field Probe Specification	13
6.3 E-Field Probe Calibration	14
6.4 Data Acquisition Electronics (DAE)	14
6.5 Robot	15
6.6 Measurement Server	16
6.7 Phantom	16
<b>7 MEASUREMENT PROCEDURES</b>	<b>17</b>
7.1 Spatial Peak SAR Evaluation	17
7.2 Power Reference Measurement	18
7.3 Area Scan	18
7.4 Zoom Scan	19
7.5 Volume Scan Procedures	19
7.6 Power Drift Monitoring	19
<b>8 TEST EQUIPMENT LIST</b>	<b>20</b>
<b>9 SYSTEM VERIFICATION</b>	<b>21</b>
9.1 Tissue Simulating Liquids	21
9.2 Tissue Verification	22
9.3 System Performance Check Results	23
<b>10 SAR EXCLUSION CALCULATIONS</b>	<b>24</b>
10.1 Standalone SAR Test Exclusion Considerations	24



---

10.2	SAR Test Exclusion Calculations for WLAN .....	24
10.3	Required Test Configurations.....	25
<b>11</b>	<b>ANTENNA LOCATION .....</b>	<b>26</b>
<b>12</b>	<b>SAR TEST RESULTS.....</b>	<b>27</b>
12.1	Body SAR .....	28
<b>13</b>	<b>UNCERTAINTY ASSESSMENT.....</b>	<b>29</b>
<b>14</b>	<b>REFERENCES.....</b>	<b>33</b>

**APPENDIX A. PLOTS OF SYSTEM PERFORMANCE CHECK**

**APPENDIX B. PLOTS OF SAR MEASUREMENT**

**APPENDIX C. DASY CALIBRATION CERTIFICATE**

**APPENDIX D. TEST SETUP PHOTOS**



## Revision History

Report No.	Version	Description	Issued Date
FA581826	Rev. 01	Initial issue of report	Sep. 25, 2015
FA581826	Rev. 02	Revised EUT Model No.	Oct. 28, 2015

## Statement of Compliance

The maximum results of Specific Absorption Rate (SAR) found during testing as follows.

Exposure Position	Frequency Band	Reported 1g SAR (W/kg)	Equipment Class
Body	WLAN5.2GHz Band	0.055	NII
	WLAN5.8GHz Band	0.03	
	WLAN2.4GHz Band	0.14	DTS

This device is in compliance with Specific Absorption Rate (SAR) for general population/uncontrolled exposure limits (1.6 W/kg) specified in FCC 47 CFR part 2 (2.1093) and ANSI/IEEE C95.1-1992, and had been tested in accordance with the measurement methods and procedures specified in IEEE 1528-2003.

### 1.1 Guidance Standard

The Specific Absorption Rate (SAR) testing specification, method, and procedure for this device is in accordance with the following standards:

- FCC 47 CFR Part 2 (2.1093)
- ANSI/IEEE C95.1-1992
- IEEE 1528-2003
- FCC KDB 865664 D01 SAR Measurement 100 MHz to 6 GHz v01r04
- FCC KDB 865664 D02 SAR Reporting v01r01
- FCC KDB 447498 D01 General RF Exposure Guidance v05r02
- FCC KDB 248227 D01 For IEEE802.11(Wi-Fi)Transmitters v02r01

### 1.2 Testing Location Information

Testing Location	
HWA YA	ADD : No. 52, Hwa Ya 1st Rd., Hwa Ya Technology Park, Kwei-Shan District, Tao Yuan City, Taiwan, R.O.C.
	TEL : 886-3-327-3456 FAX : 886-3-327-0973



### 1.3 Device Category and SAR Limits

This device belongs to portable device category because its radiating structure is allowed to be used within 20 centimeters of the body of the user. Limit for General Population/Uncontrolled exposure should be applied for this device, it is 1.6W/kg as averaged over any 1 gram of tissue.

#### 1.3.1 Test Conditions

Ambient Temperature	20 to 24 °C
Humidity	< 60%

#### 1.3.2 Test Configuration

During WLAN SAR testing EUT is configured with the WLAN continuous TX tool, and the transmission duty factor was monitored on the spectrum analyzer with zero-span setting Duty factor observed as below:

- 802.11b, 1Mbps : 100%
- 802.11g, 6Mbps : 100%
- 802.11n, MCS0 : 100%
- 802.11a, 6Mbps : 100%
- 802.11an, MCS0 : 100%

For WLAN SAR testing, WLAN engineering testing software installed on the Support Notebook can provide continuous transmitting RF signal.



## 2 Equipment Under Test (EUT)

### 2.1 General Information

Product Feature & Specification			
Equipment Name	Barcode Printer		
Brand Name	TSC		
Model No.	Alpha-4xxxxxxx,PR4xxxxxxx,GR4xxxxxxx, 44xxxxxxx,TSC-4xxxxxxx,CN-4xxxxxxx, BP-4xxxxxxx (x=0-9, A-Z, a-z, "-", ".", "/", "\", "_" or blank)		
Model Difference	All models mentioned above are totally identical for marketing purpose.		
EUT Test Model No.	Alpha-4L		
Antenna Type	PIFA	Model No.	RFA-25-P393B-70B140R
Peak Gain(dBi)	2.4G : -0.5 , 5G : 3.3		
FCC ID	VTV-RFWRN		
Frequency Range	WLAN 2.4GHz Band : 2412 MHz ~ 2462 MHz WLAN 5.2GHz Band : 5150 MHz ~ 5250 MHz WLAN 5.8GHz Band : 5725 MHz ~ 5850 MHz		
EUT Stage	Identical Prototype		

Accessories or 2nd Source or Key Part	Specification of Accessory				
	AC Adapter 1	Brand Name	L.T.E	Model Name	LTE12W-S2
		Power Rating	I/P: 100 - 240 Vac, 1 A,O/P: 12 Vdc, 1 A		
		Power Cord	1.9 meter, Shielded cable, with ferrite core		
	AC Adapter 2	Brand Name	CWT	Model Name	2AAJ012F US
		Power Rating	I/P: 100 - 240 Vac, 0.35 A,O/P: 12 Vdc, 1 A		
		Power Cord	1.5 meter, non-shielded cable, w/o ferrite core		
	Battery 1	Brand Name	TSC	Model Name	A3R-52048001
		Power Rating	7.2Vdc 5800mAh	Type	Li-ion
		Brand Name	TSC		
USB Cable 1	Brand Name	TSC	Model Name	TSC	
	Signal Line	1.1 meter, Shielded cable, with ferrite core			



### 3 Maximum Tune-up Limit & Conducted RF Output Power (Unit: dBm)

**<2.4G>**

WLAN 2.4GHz 802.11b Average Power (dBm)			Tune up Limit (dBm)
Power vs. Channel			
Channel	Frequency (MHz)	Data Rate 1Mbps	
CH 1	2412	13.82	14.00
CH 6	2437	16.89	17.00
CH 11	2462	13.53	14.00

WLAN 2.4GHz 802.11g Average Power (dBm)			Tune up Limit (dBm)
Power vs. Channel			
Channel	Frequency (MHz)	Data Rate 6Mbps	
CH 1	2412	10.69	11.00
CH 6	2437	16.38	16.50
CH 11	2462	7.08	7.50

WLAN 2.4GHz 802.11n_HT20 Average Power (dBm)			Tune up Limit (dBm)
Power vs. Channel			
Channel	Frequency (MHz)	Data Rate MCS0	
CH 1	2412	8.93	9.00
CH 6	2437	16.86	17.00
CH 11	2462	5.65	6.00





<5G>

WLAN 5GHz 802.11n Average Power (dBm)			Tune up Limit (dBm)
Power vs. Channel			
Channel	Frequency (MHz)	Data Rate 6Mbps	
CH 36	5180	11.72	12.00
CH 40	5200	12.01	12.50
CH 44	5220	11.71	12.00
CH 48	5240	11.81	12.00

WLAN 5GHz 802.11n_HT20 Average Power (dBm)			Tune up Limit (dBm)
Power vs. Channel			
Channel	Frequency (MHz)	Data Rate MCS0	
CH 36	5180	11.11	11.50
CH 40	5200	11.68	12.00
CH 44	5220	11.57	12.00
CH 48	5240	11.65	12.00

WLAN 5GHz 802.11a Average Power (dBm)			Tune up Limit (dBm)
Power vs. Channel			
Channel	Frequency (MHz)	Data Rate 6Mbps	
CH 149	5745	7.83	8.00
CH 153	5765	9.31	9.50
CH 157	5785	9.64	10.00
CH 161	5805	10.05	10.50
CH 165	5825	10.19	10.50

WLAN 5GHz 802.11n_HT20 Average Power (dBm)			Tune up Limit (dBm)
Power vs. Channel			
Channel	Frequency (MHz)	Data Rate MCS0	
CH 149	5745	7.23	7.50
CH 153	5765	10.21	10.50
CH 157	5785	10.39	10.50
CH 161	5805	10.25	10.50
CH 165	5825	7.90	8.00



## 4 RF Exposure Limits

### 4.1 Uncontrolled Environment

Uncontrolled Environments are defined as locations where there is the exposure of individuals who have no knowledge or control of their exposure. The general population/uncontrolled exposure limits are applicable to situations in which the general public may be exposed or in which persons who are exposed as a consequence of their employment may not be made fully aware of the potential for exposure or cannot exercise control over their exposure. Members of the general public would come under this category when exposure is not employment-related; for example, in the case of a wireless transmitter that exposes persons in its vicinity.

### 4.2 Controlled Environment

Controlled Environments are defined as locations where there is exposure that may be incurred by persons who are aware of the potential for exposure, (i.e. as a result of employment or occupation). In general, occupational/controlled exposure limits are applicable to situations in which persons are exposed as a consequence of their employment, who have been made fully aware of the potential for exposure and can exercise control over their exposure. The exposure category is also applicable when the exposure is of a transient nature due to incidental passage through a location where the exposure levels may be higher than the general population/uncontrolled limits, but the exposed person is fully aware of the potential for exposure and can exercise control over his or her exposure by leaving the area or by some other appropriate means.

Limits for Occupational/Controlled Exposure (W/kg)

Whole-Body	Partial-Body	Hands, Wrists, Feet and Ankles
0.4	8.0	20.0

Limits for General Population/Uncontrolled Exposure (W/kg)

Whole-Body	Partial-Body	Hands, Wrists, Feet and Ankles
0.08	1.6	4.0

Whole-Body SAR is averaged over the entire body, partial-body SAR is averaged over any 1gram of tissue defined as a tissue volume in the shape of a cube. SAR for hands, wrists, feet and ankles is averaged over any 10 grams of tissue defined as a tissue volume in the shape of a cube.

## 5 Specific Absorption Rate (SAR)

### 5.1 Introduction

SAR is related to the rate at which energy is absorbed per unit mass in an object exposed to a radio field. The SAR distribution in a biological body is complicated and is usually carried out by experimental techniques or numerical modeling. The standard recommends limits for two tiers of groups, occupational/controlled and general population/uncontrolled, based on a person's awareness and ability to exercise control over his or her exposure. In general, occupational/controlled exposure limits are higher than the limits for general population/uncontrolled.

### 5.2 SAR Definition

The SAR definition is the time derivative (rate) of the incremental energy (dW) absorbed by (dissipated in) an incremental mass (dm) contained in a volume element (dv) of a given density ( $\rho$ ). The equation description is as below:

$$\mathbf{SAR} = \frac{d}{dt} \left( \frac{dW}{dm} \right) = \frac{d}{dt} \left( \frac{dW}{\rho dv} \right)$$

SAR is expressed in units of Watts per kilogram (W/kg)

$$\mathbf{SAR} = \frac{\sigma |E|^2}{\rho}$$

Where:  $\sigma$  is the conductivity of the tissue,  $\rho$  is the mass density of the tissue and E is the RMS electrical field strength.

## 6 System Description and Setup

The DASY system used for performing compliance tests consists of the following items:

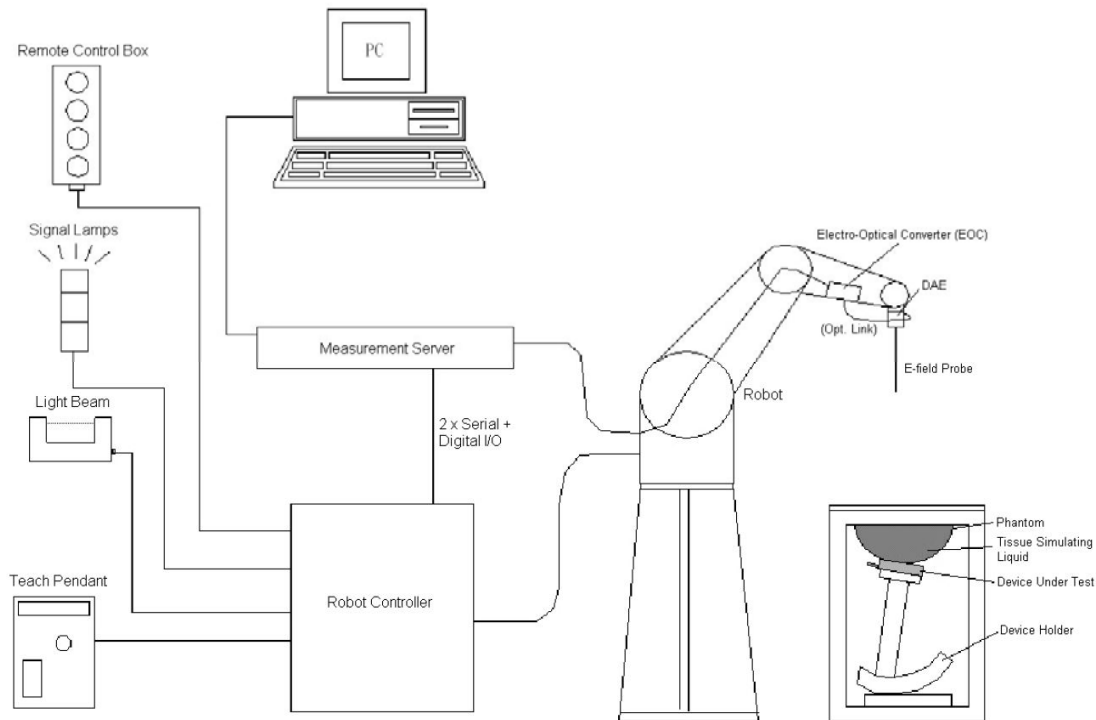

- A standard high precision 6-axis robot with controller, teach pendant and software. An arm extension for accommodating the data acquisition electronics (DAE).
- An isotropic Field probe optimized and calibrated for the targeted measurement.
- A data acquisition electronics (DAE) which performs the signal amplification, signal multiplexing, AD-conversion, offset measurements, mechanical surface detection, collision detection, etc. The unit is battery powered with standard or rechargeable batteries. The signal is optically transmitted to the EOC.
- The Electro-optical converter (EOC) performs the conversion from optical to electrical signals for the digital communication to the DAE. To use optical surface detection, a special version of the EOC is required. The EOC signal is transmitted to the measurement server.
- The function of the measurement server is to perform the time critical tasks such as signal filtering, control of the robot operation and fast movement interrupts.
- The Light Beam used is for probe alignment. This improves the (absolute) accuracy of the probe positioning.
- A computer running WinXP or Win7 and the DASY5 software.
- Remote control and teach pendant as well as additional circuitry for robot safety such as warning lamps, etc.
- The phantom, the device holder and other accessories according to the targeted measurement.

## 6.1 E-Field Probe

The SAR measurement is conducted with the dosimetric probe (manufactured by SPEAG). The probe is specially designed and calibrated for use in liquid with high permittivity. The dosimetric probe has special calibration in liquid at different frequency. This probe has a built in optical surface detection system to prevent from collision with phantom.

## 6.2 E-Field Probe Specification

<EX3DV4 Probe>

<b>Construction</b>	Symmetrical design with triangular core Built-in shielding against static charges PEEK enclosure material (resistant to organic solvents, e.g., DGBE)
<b>Frequency</b>	10 MHz to 6 GHz; Linearity: $\pm 0.2$ dB
<b>Directivity</b>	$\pm 0.3$ dB in HSL (rotation around probe axis) $\pm 0.5$ dB in tissue material (rotation normal to probe axis)
<b>Dynamic Range</b>	10 $\mu$ W/g to 100 mW/g; Linearity: $\pm 0.2$ dB (noise: typically $< 1$ $\mu$ W/g)
<b>Dimensions</b>	Overall length: 330 mm (Tip: 20 mm) Tip diameter: 2.5 mm (Body: 12 mm) Typical distance from probe tip to dipole centers: 1 mm



### 6.3 E-Field Probe Calibration

Each probe needs to be calibrated according to a dosimetric assessment procedure with accuracy better than  $\pm 10\%$ . The spherical isotropy shall be evaluated and within  $\pm 0.25\text{dB}$ . The sensitivity parameters (NormX, NormY, and NormZ), the diode compression parameter (DCP) and the conversion factor (ConvF) of the probe are tested. The calibration data can be referred to appendix C of this report.

### 6.4 Data Acquisition Electronics (DAE)

The data acquisition electronics (DAE) consists of a highly sensitive electrometer-grade preamplifier with auto-zeroing, a channel and gain-switching multiplexer, a fast 16 bit AD-converter and a command decoder and control logic unit. Transmission to the measurement server is accomplished through an optical downlink for data and status information as well as an optical uplink for commands and the clock. The input impedance of the DAE is 200 MOhm; the inputs are symmetrical and floating. Common mode rejection is above 80 dB.



## 6.5 Robot

The SPEAG DASY system uses the high precision robots (DASY4: RX90BL; DASY5: TX90XL) type from Stäubli SA (France). The Stäubli robot series have many features that are important for our application:

- High precision (repeatability  $\pm 0.035$  mm)
- High reliability (industrial design)
- Jerk-free straight movements
- Low ELF interference (the closed metallic construction shields against motor control fields)



### 6.6 Measurement Server

The measurement server is based on a PC/104 CPU board with CPU (DASY5: 400 MHz, Intel Celeron), chipdisk (DASY5: 128 MB), RAM (DASY5: 128 MB). The necessary circuits for communication with the DAE electronic box, as well as the 16 bit AD converter system for optical detection and digital I/O interface are contained on the DASY I/O board, which is directly connected to the PC/104 bus of the CPU board. The measurement server performs all the real-time data evaluation for field measurements and surface detection, controls robot movements and handles safety operations.



### 6.7 Phantom

<b>Shell Thickness</b>	2 ± 0.2 mm (sagging: <1%)
<b>Filling Volume</b>	Approx. 30 liters
<b>Dimensions</b>	Major ellipse axis: 600 mm Minor axis: 400 mm



The ELI4 phantom is intended for compliance testing of handheld and body-mounted wireless devices in the frequency range of 30 MHz to 6 GHz. ELI4 is fully compatible with standard and all known tissue simulating liquids.



## 7 Measurement Procedures

The measurement procedures are as follows:

### <Conducted power measurement>

- (a) For WWAN power measurement, use base station simulator to configure EUT WWAN transmission in conducted connection with RF cable, at maximum power in each supported wireless interface and frequency band.
- (b) Read the WWAN RF power level from the base station simulator.
- (c) For WLAN/BT power measurement, use engineering software to configure EUT WLAN/BT continuously transmission, at maximum RF power in each supported wireless interface and frequency band
- (d) Connect EUT RF port through RF cable to the power meter, and measure WLAN/BT output power

### <SAR measurement>

- (a) Use base station simulator to configure EUT WWAN transmission in radiated connection, and engineering software to configure EUT WLAN/BT continuously transmission, at maximum RF power, in the highest power channel.
- (b) Place the EUT in the positions as Appendix D demonstrates.
- (c) Set scan area, grid size and other setting on the DASY software.
- (d) Measure SAR results for the highest power channel on each testing position.
- (e) Find out the largest SAR result on these testing positions of each band
- (f) Measure SAR results for other channels in worst SAR testing position if the reported SAR of highest power channel is larger than 0.8 W/kg

According to the test standard, the recommended procedure for assessing the peak spatial-average SAR value consists of the following steps:

- (a) Area scan
- (b) Power reference measurement
- (c) Zoom scan
- (d) Power drift measurement

### 7.1 Spatial Peak SAR Evaluation

The procedure for spatial peak SAR evaluation has been implemented according to the test standard. It can be conducted for 1g and 10g, as well as for user-specific masses. The DASY software includes all numerical procedures necessary to evaluate the spatial peak SAR value.

The base for the evaluation is a "cube" measurement. The measured volume must include the 1g and 10g cubes with the highest averaged SAR values. For that purpose, the center of the measured volume is aligned to the interpolated peak SAR value of a previously performed area scan.

The entire evaluation of the spatial peak values is performed within the post-processing engine (SEMCAD). The system always gives the maximum values for the 1g and 10g cubes. The algorithm to find the cube with highest averaged SAR is divided into the following stages:

- (a) Extraction of the measured data (grid and values) from the Zoom Scan
- (g) Calculation of the SAR value at every measurement point based on all stored data (A/D values and measurement parameters)
- (b) Generation of a high-resolution mesh within the measured volume
- (c) Interpolation of all measured values from the measurement grid to the high-resolution grid
- (d) Extrapolation of the entire 3-D field distribution to the phantom surface over the distance from sensor to surface
- (e) Calculation of the averaged SAR within masses of 1g and 10g

## 7.2 Power Reference Measurement

The Power Reference Measurement and Power Drift Measurements are for monitoring the power drift of the device under test in the batch process. The minimum distance of probe sensors to surface determines the closest measurement point to phantom surface. This distance cannot be smaller than the distance of sensor calibration points to probe tip as defined in the probe properties.

## 7.3 Area Scan

The area scan is used as a fast scan in two dimensions to find the area of high field values, before doing a fine measurement around the hot spot. The sophisticated interpolation routines implemented in DASY software can find the maximum found in the scanned area, within a range of the global maximum. The range (in dB) is specified in the standards for compliance testing. For example, a 2 dB range is required in IEEE standard 1528 and IEC 62209 standards, whereby 3 dB is a requirement when compliance is assessed in accordance with the ARIB standard (Japan), if only one zoom scan follows the area scan, then only the absolute maximum will be taken as reference. For cases where multiple maximums are detected, the number of zoom scans has to be increased accordingly.

Area scan parameters extracted from FCC KDB 865664 SAR measurement 100 MHz to 6 GHz

	≤ 3 GHz	> 3 GHz
Maximum distance from closest measurement point (geometric center of probe sensors) to phantom surface	5 ± 1 mm	$\frac{1}{2} \cdot \delta \cdot \ln(2) \pm 0.5$ mm
Maximum probe angle from probe axis to phantom surface normal at the measurement location	30° ± 1°	20° ± 1°
Maximum area scan spatial resolution: $\Delta x_{Area}, \Delta y_{Area}$	≤ 2 GHz: ≤ 15 mm 2 – 3 GHz: ≤ 12 mm	3 – 4 GHz: ≤ 12 mm 4 – 6 GHz: ≤ 10 mm
	When the x or y dimension of the test device, in the measurement plane orientation, is smaller than the above, the measurement resolution must be ≤ the corresponding x or y dimension of the test device with at least one measurement point on the test device.	

## 7.4 Zoom Scan

Zoom scans are used to assess the peak spatial SAR values within a cubic averaging volume containing 1 gram and 10 gram of simulated tissue. The zoom scan measures points (refer to table below) within a cube whose base faces are centered on the maxima found in a preceding area scan job within the same procedure. When the measurement is done, the zoom scan evaluates the averaged SAR for 1 gram and 10 gram and displays these values next to the job's label.

Zoom scan parameters extracted from FCC KDB 865664 SAR measurement 100 MHz to 6 GHz.

		$\leq 3$ GHz	$> 3$ GHz	
Maximum zoom scan spatial resolution: $\Delta x_{Zoom}, \Delta y_{Zoom}$		$\leq 2$ GHz: $\leq 8$ mm 2 – 3 GHz: $\leq 5$ mm*	3 – 4 GHz: $\leq 5$ mm* 4 – 6 GHz: $\leq 4$ mm*	
Maximum zoom scan spatial resolution, normal to phantom surface	uniform grid: $\Delta z_{Zoom}(n)$	$\leq 5$ mm	3 – 4 GHz: $\leq 4$ mm 4 – 5 GHz: $\leq 3$ mm 5 – 6 GHz: $\leq 2$ mm	
	graded grid	$\Delta z_{Zoom}(1)$ : between 1 <sup>st</sup> two points closest to phantom surface	$\leq 4$ mm	3 – 4 GHz: $\leq 3$ mm 4 – 5 GHz: $\leq 2.5$ mm 5 – 6 GHz: $\leq 2$ mm
		$\Delta z_{Zoom}(n>1)$ : between subsequent points	$\leq 1.5 \cdot \Delta z_{Zoom}(n-1)$	
Minimum zoom scan volume	x, y, z	$\geq 30$ mm	3 – 4 GHz: $\geq 28$ mm 4 – 5 GHz: $\geq 25$ mm 5 – 6 GHz: $\geq 22$ mm	
<p>Note: <math>\delta</math> is the penetration depth of a plane-wave at normal incidence to the tissue medium; see draft standard IEEE P1528-2011 for details.</p> <p>* When zoom scan is required and the <i>reported</i> SAR from the <i>area scan based 1-g SAR estimation</i> procedures of KDB 447498 is <math>\leq 1.4</math> W/kg, <math>\leq 8</math> mm, <math>\leq 7</math> mm and <math>\leq 5</math> mm zoom scan resolution may be applied, respectively, for 2 GHz to 3 GHz, 3 GHz to 4 GHz and 4 GHz to 6 GHz.</p>				

## 7.5 Volume Scan Procedures

The volume scan is used to assess overlapping SAR distributions for antennas transmitting in different frequency bands. It is equivalent to an oversized zoom scan used in standalone measurements. The measurement volume will be used to enclose all the simultaneous transmitting antennas. For antennas transmitting simultaneously in different frequency bands, the volume scan is measured separately in each frequency band. In order to sum correctly to compute the 1g aggregate SAR, the EUT remain in the same test position for all measurements and all volume scan use the same spatial resolution and grid spacing. When all volume scan were completed, the software, SEMCAD postprocessor can combine and subsequently superpose these measurement data to calculating the multiband SAR.

## 7.6 Power Drift Monitoring

All SAR testing is under the EUT install full charged battery and transmit maximum output power. In DASYS measurement software, the power reference measurement and power drift measurement procedures are used for monitoring the power drift of EUT during SAR test. Both these procedures measure the field at a specified reference position before and after the SAR testing. The software will calculate the field difference in dB. If the power drifts more than 5%, the SAR will be retested.



## 8 Test Equipment List

Manufacturer	Name of Equipment	Type/Model	Serial Number	Calibration	
				Last Cal.	Due Date
SPEAG	Data Acquisition Electronics	DAE4	1424	2015/2/20	2016/2/19
SPEAG	Dosimetric E-Field Probe	EX3DV4	3976	2015/2/26	2016/2/25
SPEAG	2450MHz System Validation Kit	D2450V2	929	2015/2/25	2016/2/24
SPEAG	5000MHz System Validation Kit	D5GHzV2	1171	2015/2/26	2016/2/25
SPEAG	Device Holder	N/A	N/A	NCR	NCR
Mini-Circuits	Power Amplifier	ZHL-42W+	15542	NCR	NCR
Mini-Circuits	Power Amplifier	ZVE-8G+	605601404	NCR	NCR
Agilent	ENA Series Network Analyzer	E5071C	MY46419201	2015/1/21	2016/1/20
Agilent	EXA Signal Analyzer	N9010A	MY54200432	2015/8/12	2016/8/11
Agilent	MXG-B RF Vector Signal Generator	N5182B	MY53050081	2015/3/30	2016/3/28
SPEAG	Dielectric Probe Kit	SM DAK 040CA	1146	NCR	NCR
Anritsu	Power Meter	ML2495A	1124009	2015/1/29	2016/1/28
Anritsu	Power sensor	MA2411B	1027452	2015/1/29	2016/1/28
Anritsu	Power Meter	ML2495A	0949003	2015/2/17	2016/2/16
Anritsu	Power sensor	MA2411B	0917017	2015/2/17	2016/2/16
SPEAG	Flat Phantom ELI5.0	QD OVA 002 AA	1238	NCR	NCR
Wisewind	Themometer	HTC1	HTC1	2014/12/25	2015/12/24
Wisewind	Themometer	YF-160A	130504609	2014/12/25	2015/12/24

### General Note:

1. The calibration certificate of DASY can be referred to appendix C of this report.
2. The Insertion Loss calibration of Dual Directional Coupler and Attenuator were characterized via the network analyzer and compensated during system check.
3. In system check we need to monitor the level on the power meter, and adjust the power amplifier level to have precise power level to the dipole; the measured SAR will be normalized to 1W input power according to the ratio of 1W to the input power to the dipole. For system check, the calibration of the power amplifier is deemed not critically required for correct measurement; the power meter is critical and we do have calibration for it
4. Attenuator 1 insertion loss is calibrated by the network Analyzer, which the calibration is valid, before system check.
5. NCR: No calibration request.

## 9 System Verification

### 9.1 Tissue Simulating Liquids

For the measurement of the field distribution inside the phantom with DASY, the phantom must be filled with around 25 liters of homogeneous body tissue simulating liquid. For body SAR testing, the liquid height from the center of the flat phantom to the liquid top surface is larger than 15 cm and 10 cm, which is shown in Fig. 8.1. & 8.2.

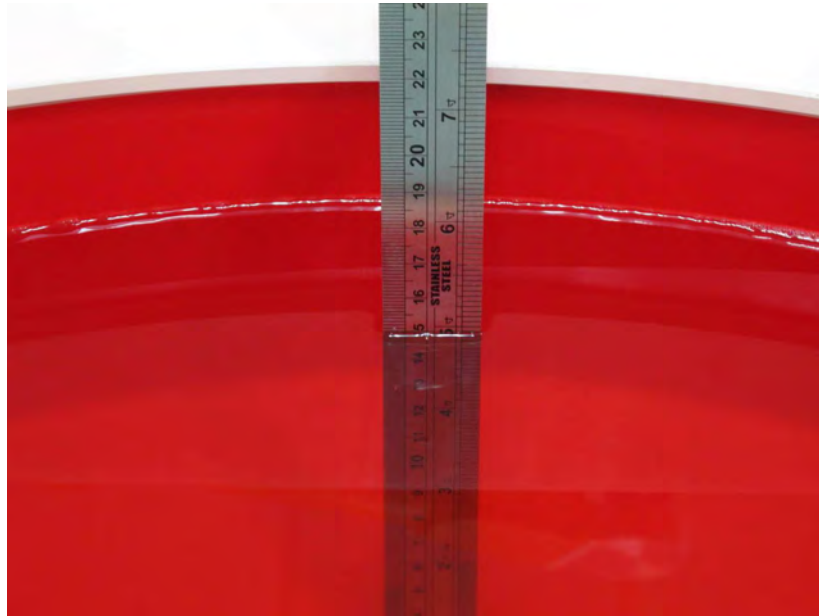

Fig 8.1 Photo of Liquid Height for Body Frequency 2450MHz

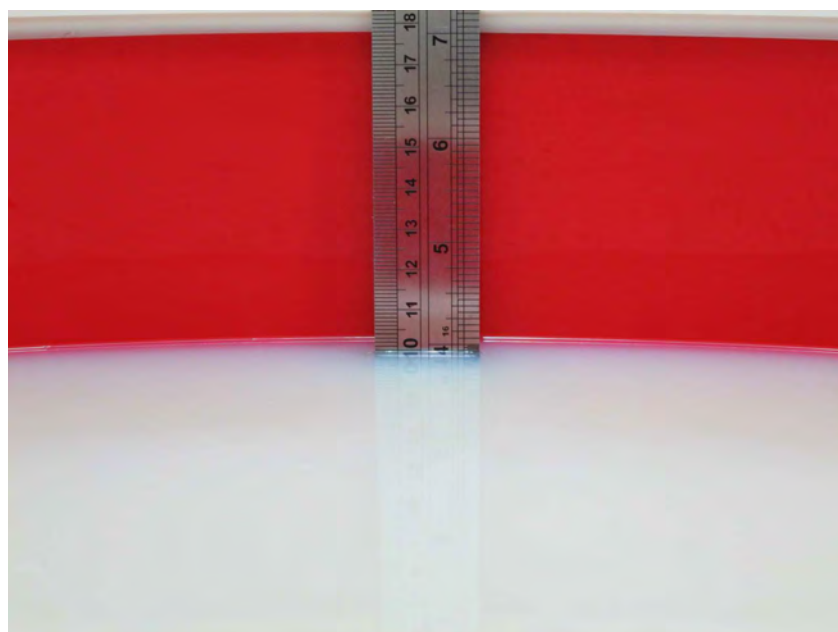

Fig 8.2 Photo of Liquid Height for Body Frequency 5GHz



## 9.2 Tissue Verification

The following tissue formulations are provided for reference only as some of the parameters have not been thoroughly verified. The composition of ingredients may be modified accordingly to achieve the desired target tissue parameters required for routine SAR evaluation.

Frequency (MHz)	Water (%)	Sugar (%)	Cellulose (%)	Salt (%)	Preventol (%)	DGBE (%)	Conductivity ( $\sigma$ )	Permittivity ( $\epsilon_r$ )
<b>For Body</b>								
2450	68.6	0	0	0.1	0	31.8	1.95	52.7

Simulating Liquid for 5GHz, Manufactured by SPEAG

Ingredients	(% by weight)
Water	64~78%
Mineral oil	11~18%
Emulsifiers	9~15%
Additives and Salt	2~3%

### <Tissue Dielectric Parameter Check Results>

Frequency (MHz)	Liquid Temp. (°C)	Conductivity ( $\sigma$ )	Permittivity ( $\epsilon_r$ )	Conductivity Target ( $\sigma$ )	Permittivity Target ( $\epsilon_r$ )	Delta ( $\sigma$ ) (%)	Delta ( $\epsilon_r$ ) (%)	Limit (%)	Date
2450	22.5	2.004	51.279	1.95	52.7	2.77	-2.70	±5	2015/9/15
5200	22.3	5.397	48.089	5.3	49	1.83	-1.86	±5	2015/9/15
5800	22.3	6.228	47.046	6	48.2	3.80	-2.39	±5	2015/9/15

1. The dielectric properties of the tissue is within  $\pm 5\%$  of the target values.
2. Liquid temperature during dielectric property measurement by more than  $\pm 2^\circ\text{C}$
3. The dielectric properties of the tissue-equivalent liquids shall be measured within 24 h before the SAR measurements.

### 9.3 System Performance Check Results

Comparing to the original SAR value provided by SPEAG, the verification data should be within its specification of 10 %. Below table shows the target SAR and measured SAR after normalized to 1W input power. The table below indicates the system performance check can meet the variation criterion and the plots can be referred to Appendix A of this report.

Date	Frequency (MHz)	Input Power (mW)	Dipole S/N	Probe S/N	DAE S/N	Measured SAR (W/kg)	Targeted SAR (W/kg)	Normalized SAR (W/kg)	Deviation (%)
2015/9/15	2450	250mW	929	3976	1424	12.8	51.1	51.20	0.196
2015/9/15	5200	100mW	1171	3976	1424	7.21	71.4	72.10	0.980
2015/9/15	5800	100mW	1171	3976	1424	7.72	73.1	77.20	5.609

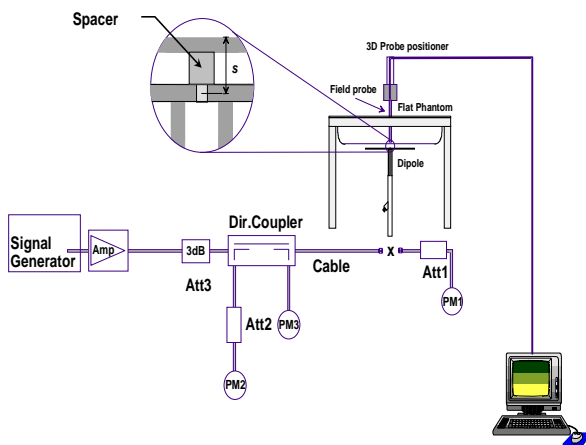

System Performance Check Setup



Setup Photo

## 10 SAR Exclusion Calculations

The 1-g SAR test exclusion thresholds for 100 MHz to 6 GHz at test separation distances  $\leq 50$  mm [(max. pwr. of channel including tune-up tolerance, mW)/(min. test separation distance, mm)] [ $\sqrt{f(\text{GHz})} \leq 3.0$  for 1-g SAR,

Where

- $f(\text{GHz})$  is the RF channel transmit frequency in GHz
- Power and distance are rounded to the nearest mW and mm before calculation
- The result is rounded to one decimal place for comparison

### 10.1 Standalone SAR Test Exclusion Considerations

The standalone SAR test exclusion procedure in KDB 447498) 4.3.1) is applied to determine the minimum test separation distance:

- The separation distance from the antenna to adjacent edge is  $\leq 5$ mm, distance of 5mm is applied to determine SAR test exclusion.
- The Separation distance from the antenna to adjacent edge is  $> 5$ mm, the actual antenna to edge separation distance is applied to determine SAR test exclusion.

### 10.2 SAR Test Exclusion Calculations for WLAN

#### <WLAN Antennas>

##### Antennas $\leq 50$ mm to edges

Radio	Frq. (MHz)	Tune-up Power		Separation distances (mm)						Calculated Threshold(mW)					
		dBm	mW	Front	Rear	Edge 1	Edge 2	Edge 3	Edge 4	Front	Rear	Edge 1	Edge 2	Edge 3	Edge 4
<b>802.11b</b>	2437	16.89	49	33.2	27.9	25.7	110	8.8	179.3	64	54	49	211	17	345
<b>802.11a</b>	5200	12.01	16	33.2	27.9	25.7	110	8.8	179.3	44	37	34	145	12	236
<b>802.11n_HT20</b>	5785	10.39	11	33.2	27.9	25.7	110	8.8	179.3	41	35	32	137	11	224

##### Antennas $> 50$ mm edges

Radio	Frq. (MHz)	Tune-up Power		Separation distances (mm)						Calculated Threshold(mW)					
		dBm	mW	Front	Rear	Edge 1	Edge 2	Edge 3	Edge 4	Front	Rear	Edge 1	Edge 2	Edge 3	Edge 4
<b>802.11b</b>	2437	16.89	49	33.2	27.9	25.7	110	8.8	179.3	$\leq 50$ mm	$\leq 50$ mm	$\leq 50$ mm	696	$\leq 50$ mm	1389
<b>802.11a</b>	5200	12.01	16	33.2	27.9	25.7	110	8.8	179.3	$\leq 50$ mm	$\leq 50$ mm	$\leq 50$ mm	666	$\leq 50$ mm	1359
<b>802.11n_HT20</b>	5785	10.39	11	33.2	27.9	25.7	110	8.8	179.3	$\leq 50$ mm	$\leq 50$ mm	$\leq 50$ mm	662	$\leq 50$ mm	1355





### 10.3 Required Test Configurations

Test Configurations	Front Face	Rear Face	Edge1	Edge2	Edge3	Edge4
802.11b	YES	YES	YES	NO	YES	NO
802.11a	YES	YES	YES	NO	YES	NO
802.11n_HT20	YES	YES	YES	NO	YES	NO

**Note:**

- 1. Yes= SAR is required.
- 2. No= SAR is not required.

## 11 Antenna Location

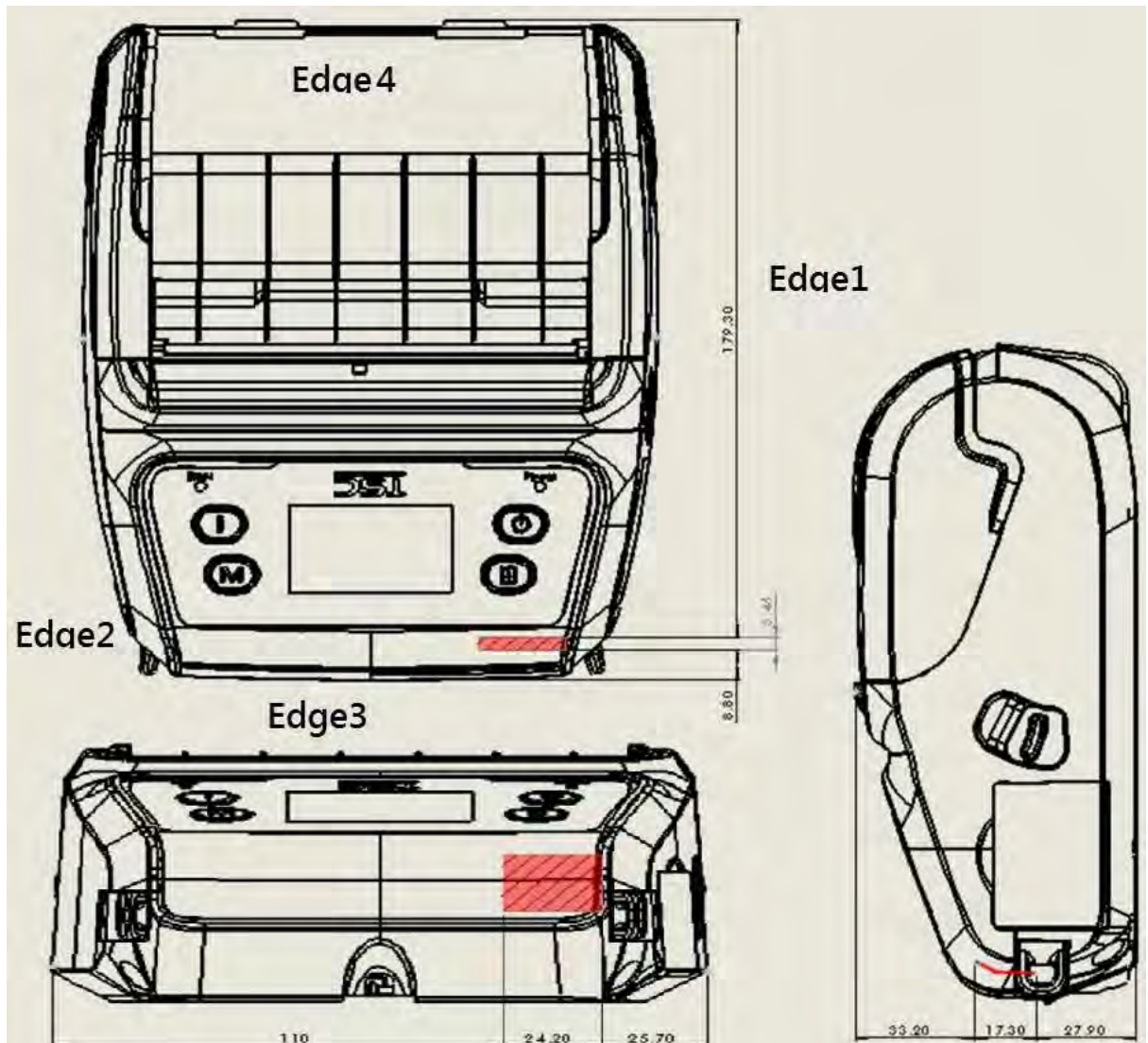

<EUT Front View>

Antenna	Front Face (mm)	Rear Face (mm)	Edge1 (mm)	Edge2 (mm)	Edge3 (mm)	Edge4 (mm)
WIFI_ANT	33.2	27.9	25.7	110	8.8	179.3



## 12 SAR Test Results

**General Note:**

1. Per KDB 447498, the reported SAR is the measured SAR value adjusted for maximum tune-up tolerance.
  - a. Tune-up scaling Factor = tune-up limit power (mW) / EUT RF power (mW), where tune-up limit is the maximum rated power among all production units.
  - b. For SAR testing of WLAN signal with non-100% duty cycle, the measured SAR is scaled-up by the duty cycle scaling factor which is equal to "1/(duty cycle)"
  - c. Reported SAR(W/kg)= Measured SAR(W/kg)\*Tune-up Scaling Factor
  
2. Per KDB 447498 for each exposure position, testing of other required channels within the operating mode of a frequency band is not required when the *reported* 1-g or 10-g SAR for the mid-band or highest output power channel is:
  - $\leq 0.8$  W/kg or 2.0 W/kg, for 1-g or 10-g respectively, when the transmission band is  $\leq 100$  MHz
  - $\leq 0.6$  W/kg or 1.5 W/kg, for 1-g or 10-g respectively, when the transmission band is between 100 MHz and 200 MHz
  - $\leq 0.4$  W/kg or 1.0 W/kg, for 1-g or 10-g respectively, when the transmission band is  $\geq 200$  MHz
  
3. Per KDB 616217, the additional separation introduced by the contour against a flat phantom is  $< 5$  mm and reported SAR is  $< 1.2$  W/kg, a curved or contoured back surface or edge SAR is not required, more detail information please refer to the setup photo.
  
4. Per KDB 248227D01 v02, the Wi-Fi transmission modes include all channel bandwidth, modulation and data rate combinations for the 802.11a/g/n/ac OFDM configurations in a standalone or aggregated frequency band. For 2.4 GHz, 802.11b DSSS and 802.11g/n OFDM configurations are considered separately.
  
5. Per KDB 248227D01 v02 5.1.1 Initial Test Position SAR Test Reduction Procedure.
  
6. When the WLAN transmission was verified using a spectrum analyzer.



## 12.1 Body SAR

### <WLAN2.4G SAR>

Plot No.	Band	Mode	Test Position	Gap (cm)	Ch.	Freq. (MHz)	Holster	Data Rate	Average Power (dBm)	Tune-up Limit (dBm)	Tune-up Scaling Factor	Fast SAR 1g SAR (W/kg)	Measured 1g SAR (W/kg)	Reported 1g SAR (W/kg)
1	802.11b	-	Front Face	0	6	2437	-	1Mbps	16.89	17	1.03	0.058	-	0.06
2	802.11b	-	Rear Face	0	6	2437	-	1Mbps	16.89	17	1.03	0.014	-	0.0144
3	802.11b	-	Edge1	0	6	2437	-	1Mbps	16.89	17	1.03	0.03	-	0.03
4	802.11b	-	Edge3	0	6	2437	-	1Mbps	16.89	17	1.03	0.124	0.136	0.14
5	802.11b	-	Edge3	0	6	2437	V	1Mbps	16.89	17	1.03	0.064	0.071	0.073

**Note:**

1. According to KDB248227 D01 V02r01, 5.2.1, 802.11b DSSS SAR Test Requirements.
2. According to KDB248227 D01 V02r01, 5.2.2, 2.4 GHz 802.11g/n OFDM SAR Test Exclusion Requirements.

### <WLAN5G SAR>

Plot No.	Band	Mode	Test Position	Gap (cm)	Ch.	Freq. (MHz)	Holster	Data Rate	Average Power (dBm)	Tune-up Limit (dBm)	Tune-up Scaling Factor	Fast SAR 1g SAR (W/kg)	Measured 1g SAR (W/kg)	Reported 1g SAR (W/kg)
7	802.11a	-	Front Face	0	40	5200	-	6Mbps	12.01	12.5	1.12	0.06	0.049	0.055
8	802.11a	-	Rear Face	0	40	5200	-	6Mbps	12.01	12.5	1.12	0.00146	-	0.002
9	802.11a	-	Edge1	0	40	5200	-	6Mbps	12.01	12.5	1.12	0.021	-	0.04
10	802.11a	-	Edge3	0	40	5200	-	6Mbps	12.01	12.5	1.12	0.023	-	0.03
11	802.11a	-	Front Face	0	40	5200	V	6Mbps	12.01	12.5	1.12	0.034	0.03	0.034
12	802.11n	HT20	Front Face	0	157	5785	-	MCS0	10.39	10.5	1.03	0.024	0.027	0.03
13	802.11n	HT20	Rear Face	0	157	5785	-	MCS0	10.39	10.5	1.03	0.00000115	-	0.00
14	802.11n	HT20	Edge1	0	157	5785	-	MCS0	10.39	10.5	1.03	0.018	-	0.02
15	802.11n	HT20	Edge3	0	157	5785	-	MCS0	10.39	10.5	1.03	0.000644	-	0.00
16	802.11n	HT20	Front Face	0	157	5785	V	MCS0	10.39	10.5	1.03	0.028	0.022	0.023

### 13 Uncertainty Assessment

The component of uncertainty may generally be categorized according to the methods used to evaluate them. The evaluation of uncertainty by the statistical analysis of a series of observations is termed a Type A evaluation of uncertainty. The evaluation of uncertainty by means other than the statistical analysis of a series of observation is termed a Type B evaluation of uncertainty. Each component of uncertainty, however evaluated, is represented by an estimated standard deviation, termed standard uncertainty, which is determined by the positive square root of the estimated variance.

A Type A evaluation of standard uncertainty may be based on any valid statistical method for treating data. This includes calculating the standard deviation of the mean of a series of independent observations; using the method of least squares to fit a curve to the data in order to estimate the parameter of the curve and their standard deviations; or carrying out an analysis of variance in order to identify and quantify random effects in certain kinds of measurement.

A type B evaluation of standard uncertainty is typically based on scientific judgment using all of the relevant information available. These may include previous measurement data, experience, and knowledge of the behavior and properties of relevant materials and instruments, manufacture’s specification, data provided in calibration reports and uncertainties assigned to reference data taken from handbooks. Broadly speaking, the uncertainty is either obtained from an outdoor source or obtained from an assumed distribution, such as the normal distribution, rectangular or triangular distributions indicated in Table 14.1

Uncertainty Distributions	Normal	Rectangular	Triangular	U-Shape
Multi-plying Factor <sup>(a)</sup>	1/k <sup>(b)</sup>	1/√3	1/√6	1/√2

(a) standard uncertainty is determined as the product of the multiplying factor and the estimated range of variations in the measured quantity

(b)  $\kappa$  is the coverage factor

#### Standard Uncertainty for Assumed Distribution

The combined standard uncertainty of the measurement result represents the estimated standard deviation of the result. It is obtained by combining the individual standard uncertainties of both Type A and Type B evaluation using the usual “root-sum-squares” (RSS) methods of combining standard deviations by taking the positive square root of the estimated variances.

Expanded uncertainty is a measure of uncertainty that defines an interval about the measurement result within which the measured value is confidently believed to lie. It is obtained by multiplying the combined standard uncertainty by a coverage factor. Typically, the coverage factor ranges from 2 to 3. Using a coverage factor allows the true value of a measured quantity to be specified with a defined probability within the specified uncertainty range. For purpose of this document, a coverage factor two is used, which corresponds to confidence interval of about 95 %. The DASY uncertainty Budget is shown in the following tables.



Error Description	Uncertainty Value (±%)	Probability Distribution	Divisor	Ci (1g)	Standard Uncertainty (±%) (1g)
<b>Measurement System</b>					
Probe Calibration	6.0	Normal	1.0	1.0	6.0
Axial Isotropy	4.7	Rectangular	$\sqrt{3}$	0.7	1.9
Hemispherical Isotropy	9.6	Rectangular	$\sqrt{3}$	0.7	3.9
Boundary effects	1.0	Rectangular	$\sqrt{3}$	1.0	0.6
Linearity	4.7	Rectangular	$\sqrt{3}$	1.0	2.7
System Detection Limits	1.0	Rectangular	$\sqrt{3}$	1.0	0.6
Modulation Response	2.4	Rectangular	$\sqrt{3}$	1.0	1.4
Readout Electronics	0.3	Normal	1.0	1.0	0.3
Response Time	0.8	Rectangular	$\sqrt{3}$	1.0	0.5
Integration Time	2.6	Rectangular	$\sqrt{3}$	1.0	1.5
RF Ambient Noise	3.0	Rectangular	$\sqrt{3}$	1.0	1.7
RF Ambient Reflections	3.0	Rectangular	$\sqrt{3}$	1.0	1.7
Probe Positioner	0.4	Rectangular	$\sqrt{3}$	1.0	0.2
Probe Positioning	2.9	Rectangular	$\sqrt{3}$	1.0	1.7
Max. SAR Eval.	2.0	Rectangular	$\sqrt{3}$	1.0	1.2
<b>Dipole Related</b>					
Device Positioning	2.9	Normal	1.0	1.0	2.9
Device Holder	3.6	Normal	1.0	1.0	3.6
Power Drift	5.0	Rectangular	$\sqrt{3}$	1.0	2.9
Power Scaling	0.0	Rectangular	$\sqrt{3}$	1.0	0.0
<b>Phantom and Tissue parameters</b>					
Phantom Uncertainty	6.1	Rectangular	$\sqrt{3}$	1.0	3.5
SAR correction	1.9	Normal	1.0	1.0	1.9
Liquid Conductivity (measurement)	2.0	Normal	1.0	0.8	1.6
Liquid Permittivity (measurement)	2.1	Normal	1.0	0.3	0.5
Temp. unc. - Conduct	3.4	Rectangular	$\sqrt{3}$	0.8	1.5
Temp. unc. - Permittivity	0.4	Rectangular	$\sqrt{3}$	0.2	0.1
<b>Combined Standard Uncertainty</b>					11.2
<b>Coverage Factor for 95 %</b>					Kp=2
<b>Expanded Uncertainty</b>					22.4

Uncertainty Budget for frequency range 30 MHz to 3 GHz



Error Description	Uncertainty Value (±%)	Probability Distribution	Divisor	Ci (1g)	Standard Uncertainty (±%) (1g)
<b>Measurement System</b>					
Probe Calibration	6.6	Normal	1.0	1.0	6.6
Axial Isotropy	4.7	Rectangular	√3	0.7	1.9
Hemispherical Isotropy	9.6	Rectangular	√3	0.7	3.9
Boundary effects	2.0	Rectangular	√3	1.0	1.2
Linearity	4.7	Rectangular	√3	1.0	2.7
System Detection Limits	1.0	Rectangular	√3	1.0	0.6
Modulation Response	2.4	Rectangular	√3	1.0	1.4
Readout Electronics	0.3	Normal	1.0	1.0	0.3
Response Time	0.8	Rectangular	√3	1.0	0.5
Integration Time	2.6	Rectangular	√3	1.0	1.5
RF Ambient Noise	3.0	Rectangular	√3	1.0	1.7
RF Ambient Reflections	3.0	Rectangular	√3	1.0	1.7
Probe Positioner	0.8	Rectangular	√3	1.0	0.5
Probe Positioning	6.7	Rectangular	√3	1.0	3.9
Max. SAR Eval.	4.0	Rectangular	√3	1.0	2.3
<b>Dipole Related</b>					
Device Positioning	2.9	Normal	1.0	1.0	2.9
Device Holder	3.6	Normal	1.0	1.0	3.6
Power Drift	5.0	Rectangular	√3	1.0	2.9
Power Scaling	0.0	Rectangular	√3	1.0	0.0
<b>Phantom and Tissue parameters</b>					
Phantom Uncertainty	6.6	Rectangular	√3	1.0	3.8
SAR correction	1.9	Normal	1.0	1.0	1.9
Liquid Conductivity (measurement)	2.0	Normal	1.0	0.8	1.6
Liquid Permittivity (measurement)	2.1	Normal	1.0	0.3	0.5
Temp. unc. - Conduct	3.4	Rectangular	√3	0.8	1.5
Temp. unc. - Permittivity	0.4	Rectangular	√3	0.2	0.1
<b>Combined Standard Uncertainty</b>					12.3
<b>Coverage Factor for 95 %</b>					Kp=2
<b>Expanded Uncertainty</b>					24.7

Uncertainty Budget for frequency range 3 GHz to 6 GHz



Error Description	Uncertainty Value (±%)	Probability Distribution	Divisor	Ci (1g)	Standard Uncertainty (±%) (1g)
<b>Measurement System</b>					
Probe Calibration	6.0	Normal	1.0	1.0	6.6
Axial Isotropy	4.7	Rectangular	$\sqrt{3}$	0.7	1.9
Hemispherical Isotropy	9.6	Rectangular	$\sqrt{3}$	0.7	3.9
Boundary effects	1.0	Rectangular	$\sqrt{3}$	1.0	0.6
Linearity	4.7	Rectangular	$\sqrt{3}$	1.0	2.7
System Detection Limits	1.0	Rectangular	$\sqrt{3}$	1.0	0.6
Modulation Response	0.0	Rectangular	$\sqrt{3}$	1.0	0.0
Readout Electronics	0.3	Normal	1.0	1.0	0.3
Response Time	0.0	Rectangular	$\sqrt{3}$	1.0	0.0
Integration Time	2.6	Rectangular	$\sqrt{3}$	1.0	1.5
RF Ambient Noise	3.0	Rectangular	$\sqrt{3}$	1.0	1.7
RF Ambient Reflections	3.0	Rectangular	$\sqrt{3}$	1.0	1.7
Probe Positioner	0.4	Rectangular	$\sqrt{3}$	1.0	0.2
Probe Positioning	2.9	Rectangular	$\sqrt{3}$	1.0	1.7
Max. SAR Eval.	2.0	Rectangular	$\sqrt{3}$	1.0	1.2
<b>Dipole Related</b>					
Device Of experimental dipole	5.5	Normal	1.0	1.0	5.5
Dipole Axis to Liquid Distance	2.0	Rectangular	$\sqrt{3}$	1.0	1.2
Input Power & SAR Drift	3.4	Rectangular	$\sqrt{3}$	1.0	2.0
<b>Phantom and Tissue parameters</b>					
Phantom Uncertainty	6.1	Rectangular	$\sqrt{3}$	1.0	3.5
SAR correction	1.9	Normal	$\sqrt{3}$	1.0	1.1
Liquid Conductivity (measurement)	2.0	Normal	1.0	0.8	1.6
Liquid Permittivity (measurement)	2.1	Normal	1.0	0.2	0.5
Temp. unc. - Conduct	3.4	Rectangular	$\sqrt{3}$	0.8	1.5
Temp. unc. - Permittivity	0.4	Rectangular	$\sqrt{3}$	0.2	0.1
<b>Combined Standard Uncertainty</b>					9.2
<b>Coverage Factor for 95 %</b>					Kp=2
<b>Expanded Uncertainty</b>					18.4

Uncertainty Budget for System Validation for the 0.3-6 GHz range



## 14 References

- [1] Federal Communications Commission, "Report and order: Guidelines for evaluating the environmental effects of radiofrequency radiation", Tech. Rep. FCC 96-326, FCC, Washington, D.C. 20554, 1996.
- [2] David L. Means Kwok Chan, Robert F. Cleveland, "Evaluating compliance with FCC guidelines for human exposure to radiofrequency electromagnetic fields", Tech. Rep., Federal Communication Commission, Office of Engineering & Technology, Washington, DC, 1997.
- [3] Thomas Schmid, Oliver Egger, and Niels Kuster, "Automated E-field scanning system for dosimetric assessments", IEEE Transactions on Microwave Theory and Techniques, vol. 44, pp. 105{113, Jan. 1996.
- [4] Niels Kuster, Ralph Kastle, and Thomas Schmid, "Dosimetric evaluation of mobile communications equipment with known precision", IEEE Transactions on communications, vol. E80-B, no. 5, pp. 645{652, May 1997.
- [5] CENELEC, "Considerations for evaluating of human exposure to electromagnetic fields (EMFs) from mobile telecommunication equipment (MTE) in the frequency range 30MHz - 6GHz", Tech. Rep., CENELEC, European Committee for Electro technical Standardization, Brussels, 1997.
- [6] ANSI, ANSI/IEEE C95.1-1992: IEEE Standard for Safety Levels with Respect to Human Exposure to Radio Frequency Electromagnetic Fields, 3 kHz to 300 GHz, The Institute of Electrical and Electronics Engineers, Inc., New York, NY 10017, 1992.
- [7] Katja Pokovic, Thomas Schmid, and Niels Kuster, "Robust setup for precise calibration of E-field probes in tissue simulating liquids at mobile communications frequencies", in ICECOM '97, Dubrovnik, October 15{17, 1997, pp. 120{124.
- [8] Katja Pokovic, Thomas Schmid, and Niels Kuster, "E-field probe with improved isotropy in brain simulating liquids", in Proceedings of the ELMAR, Zadar, Croatia, 23{25 June, 1996, pp. 172{175.
- [9] Volker Hombach, Klaus Meier, Michael Burkhardt, Eberhard Kuhn, and Niels Kuster, "The dependence of EM energy absorption upon human head modeling at 900 MHz", IEEE Transactions on Microwave Theory and Techniques, vol. 44, no. 10, pp. 1865{1873, Oct. 1996.
- [10] Klaus Meier, Ralf Kastle, Volker Hombach, Roger Tay, and Niels Kuster, "The dependence of EM energy absorption upon human head modeling at 1800 MHz", IEEE Transactions on Microwave Theory and Techniques, Oct. 1997, in press.
- [11] W. Gander, Computermathematik, Birkhaeuser, Basel, 1992.
- [12] W. H. Press, S. A. Teukolsky, W. T. Vetterling, and B. P. Flannery, Numerical Recipes in C, The Art of Scientific Computing, Second Edition, Cambridge University Press, 1992..Dosimetric Evaluation of Sample device, month 1998 9.



## Appendix A. Plots of System Performance Check

## System Check\_B2450\_150915

### DUT: Dipole 2450MHz D2450V2\_ SN: 929

Communication System: CW; Frequency: 2450 MHz; Duty Cycle: 1:1

Medium: B2450\_150915 Medium parameters used:  $f = 2450$  MHz;  $\sigma = 2.004$  S/m;  $\epsilon_r = 51.279$ ;  $\rho = 1000$  kg/m<sup>3</sup>

**Ambient Temperature** : 23.4 °C; **Liquid Temperature** : 22.5 °C

DASY5 Configuration:

- Probe: EX3DV4 - SN3976; ConvF(7.26, 7.26, 7.26); Calibrated: 2015/2/26;
- Sensor-Surface: 2mm (Mechanical Surface Detection)
- Electronics: DAE4 Sn1424; Calibrated: 2015/2/20
- Phantom: ELI v5.0; Type: QDOVA002AA; Serial: TP:1238
- Measurement SW: DASY52, Version 52.8 (8); SEMCAD X Version 14.6.10 (7331)

**Pin=250mW/Area Scan (61x61x1):** Interpolated grid: dx=1.200 mm, dy=1.200 mm

Maximum value of SAR (interpolated) = 19.6 W/kg

**Pin=250mW/Zoom Scan (7x7x7)/Cube 0:** Measurement grid: dx=5mm, dy=5mm, dz=5mm

Reference Value = 99.01 V/m; Power Drift = -0.03 dB

Peak SAR (extrapolated) = 27.0 W/kg

**SAR(1 g) = 12.8 W/kg; SAR(10 g) = 5.91 W/kg**

Maximum value of SAR (measured) = 19.6 W/kg

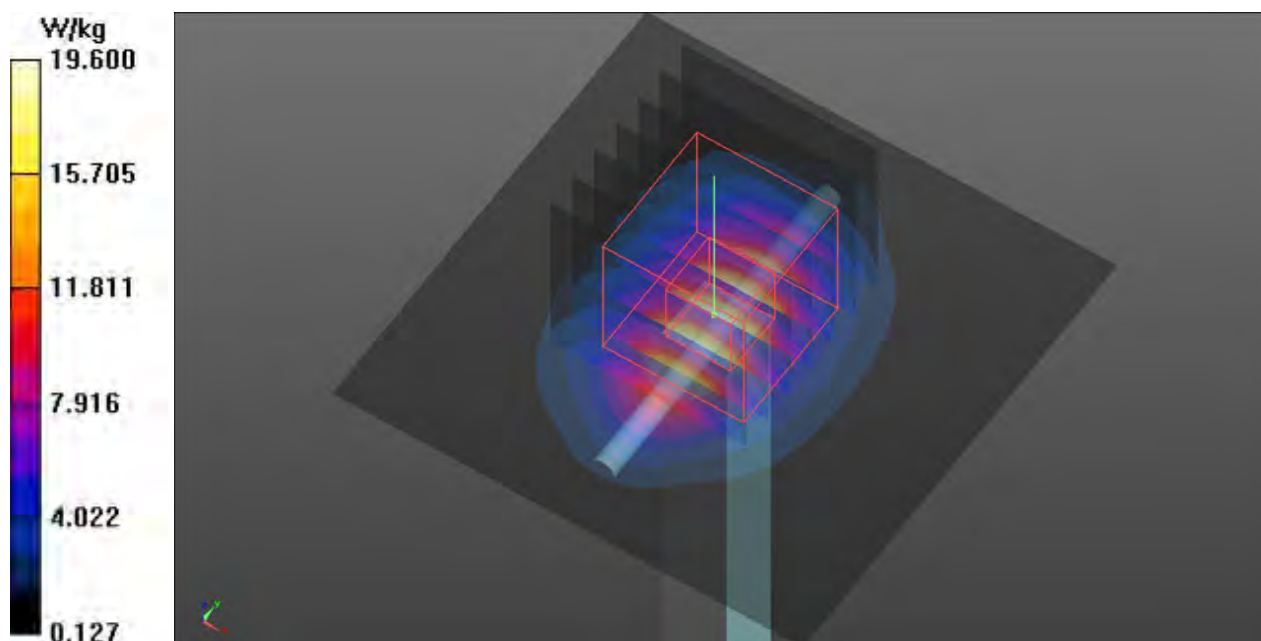

## System Check\_B5200\_150915

### DUT: Dipole D5GHzV2\_ SN: 1171

Communication System: CW; Frequency: 5200 MHz; Duty Cycle: 1:1

Medium: B5G\_150915 Medium parameters used:  $f = 5200$  MHz;  $\sigma = 5.397$  S/m;  $\epsilon_r = 48.089$ ;  $\rho = 1000$  kg/m<sup>3</sup>

**Ambient Temperature : 23.1 °C; Liquid Temperature : 22.3 °C**

DASY5 Configuration:

- Probe: EX3DV4 - SN3976; ConvF(4.52, 4.52, 4.52); Calibrated: 2015/2/26;
- Sensor-Surface: 2mm (Mechanical Surface Detection)
- Electronics: DAE4 Sn1424; Calibrated: 2015/2/20
- Phantom: ELI v5.0; Type: QDOVA002AA; Serial: TP:1238
- Measurement SW: DASY52, Version 52.8 (8); SEMCAD X Version 14.6.10 (7331)

**Pin=100mW/Area Scan (91x91x1):** Interpolated grid: dx=1.000 mm, dy=1.000 mm

Maximum value of SAR (interpolated) = 13.8 W/kg

**Pin=100mW/Zoom Scan (7x7x12)/Cube 0:** Measurement grid: dx=4mm, dy=4mm, dz=2mm

Reference Value = 57.17 V/m; Power Drift = 0.01 dB

Peak SAR (extrapolated) = 30.7 W/kg

**SAR(1 g) = 7.21 W/kg; SAR(10 g) = 2.06 W/kg**

Maximum value of SAR (measured) = 14.9 W/kg

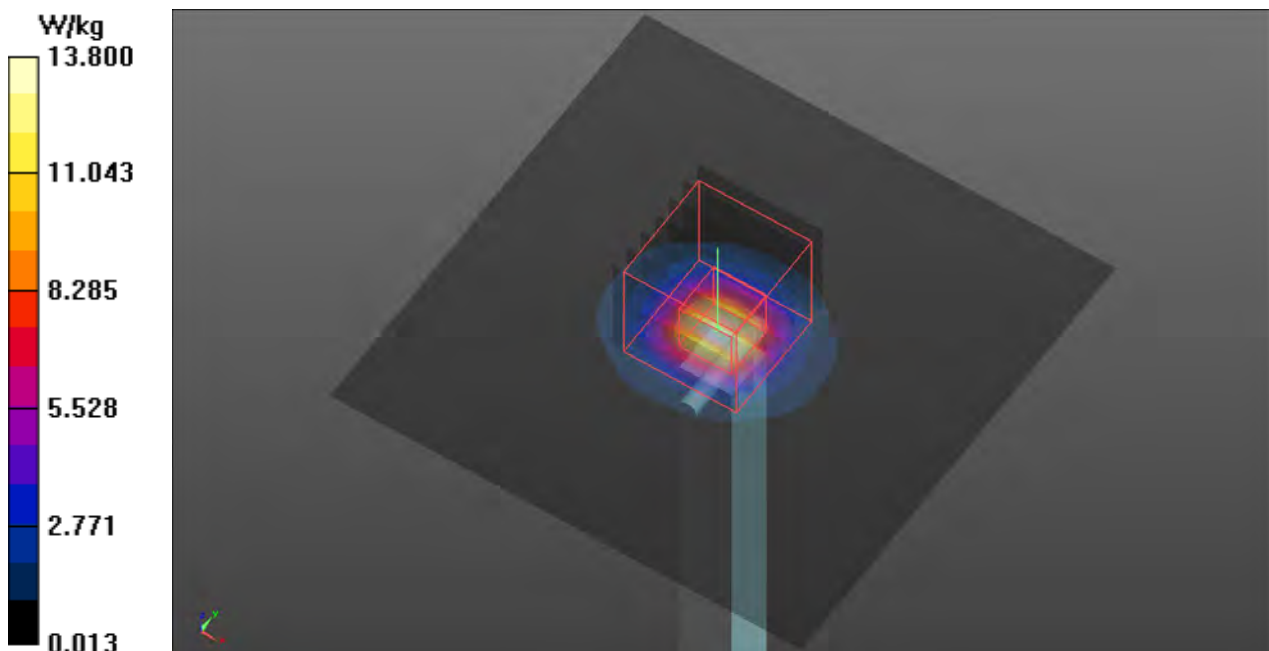

## System Check\_B5800\_150915

**DUT: Dipole D5GHzV2\_ SN: 1171**

Communication System: CW; Frequency: 5800 MHz; Duty Cycle: 1:1

Medium: B5G\_150915 Medium parameters used:  $f = 5800$  MHz;  $\sigma = 6.228$  S/m;  $\epsilon_r = 47.046$ ;  $\rho = 1000$  kg/m<sup>3</sup>

**Ambient Temperature : 23.1 °C; Liquid Temperature : 22.3 °C**

DASY5 Configuration:

- Probe: EX3DV4 - SN3976; ConvF(4.23, 4.23, 4.23); Calibrated: 2015/2/26;
- Sensor-Surface: 2mm (Mechanical Surface Detection)
- Electronics: DAE4 Sn1424; Calibrated: 2015/2/20
- Phantom: ELI v5.0; Type: QDOVA002AA; Serial: TP:1238
- Measurement SW: DASY52, Version 52.8 (8); SEMCAD X Version 14.6.10 (7331)

**Pin=100mW/Area Scan (91x91x1):** Interpolated grid: dx=1.000 mm, dy=1.000 mm

Maximum value of SAR (interpolated) = 14.6 W/kg

**Pin=100mW/Zoom Scan (7x7x12)/Cube 0:** Measurement grid: dx=4mm, dy=4mm, dz=2mm

Reference Value = 52.95 V/m; Power Drift = 0.01 dB

Peak SAR (extrapolated) = 35.1 W/kg

**SAR(1 g) = 7.72 W/kg; SAR(10 g) = 2.15 W/kg**

Maximum value of SAR (measured) = 16.7 W/kg

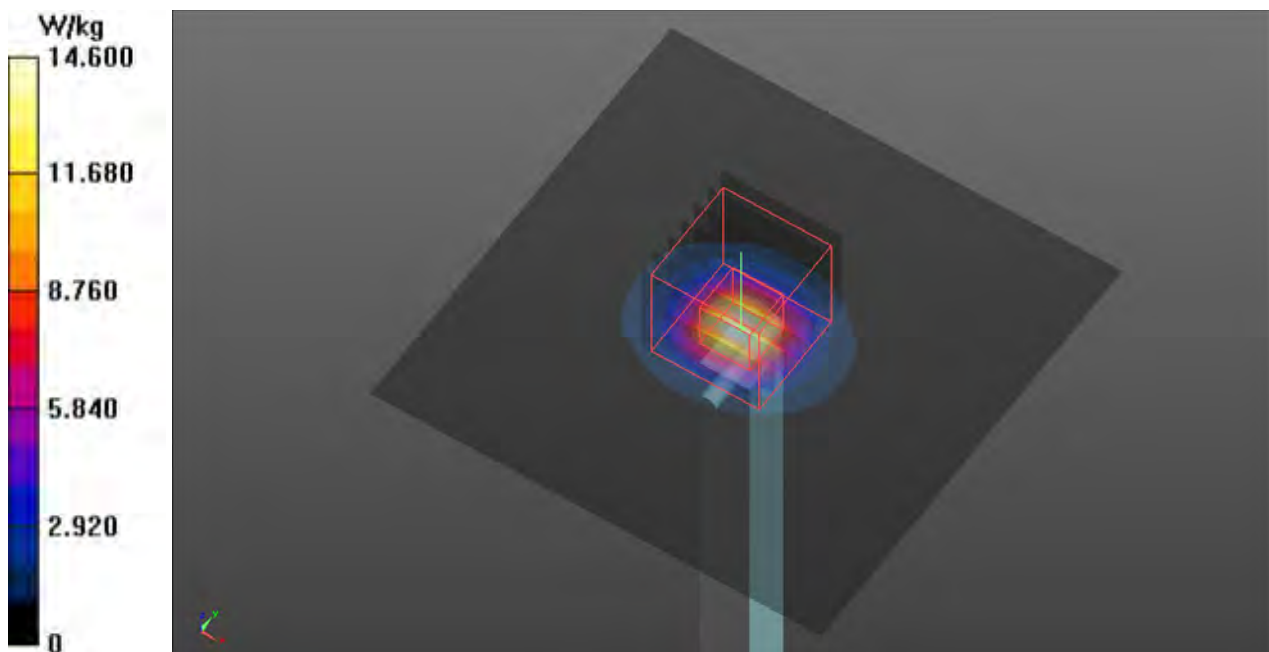



## **APPENDIX B. Plots of SAR Measurement**

## P01 802.11b\_Front Face\_0cm\_Ch6

**DUT: 581826**

Communication System: WLAN\_2.4G; Frequency: 2437 MHz; Duty Cycle: 1:1  
 Medium: B2450\_150915 Medium parameters used:  $f = 2437$  MHz;  $\sigma = 1.988$  S/m;  $\epsilon_r = 51.319$ ;  $\rho = 1000$  kg/m<sup>3</sup>

**Ambient Temperature : 23.4 °C; Liquid Temperature : 22.5 °C**

DASY5 Configuration:

- Probe: EX3DV4 - SN3976; ConvF(7.26, 7.26, 7.26); Calibrated: 2015/2/26;
- Sensor-Surface: 2mm (Mechanical Surface Detection)
- Electronics: DAE4 Sn1424; Calibrated: 2015/2/20
- Phantom: ELI v5.0; Type: QDOVA002AA; Serial: TP:1238
- Measurement SW: DASY52, Version 52.8 (8); SEMCAD X Version 14.6.10 (7331)

**Ch6/Area Scan (151x181x1):** Interpolated grid: dx=1.200 mm, dy=1.200 mm

Reference Value = 5.734 V/m; Power Drift = -0.01 dB

**Fast SAR: SAR(1 g) = 0.058 W/kg; SAR(10 g) = 0.030 W/kg**

Maximum value of SAR (interpolated) = 0.0862 W/kg

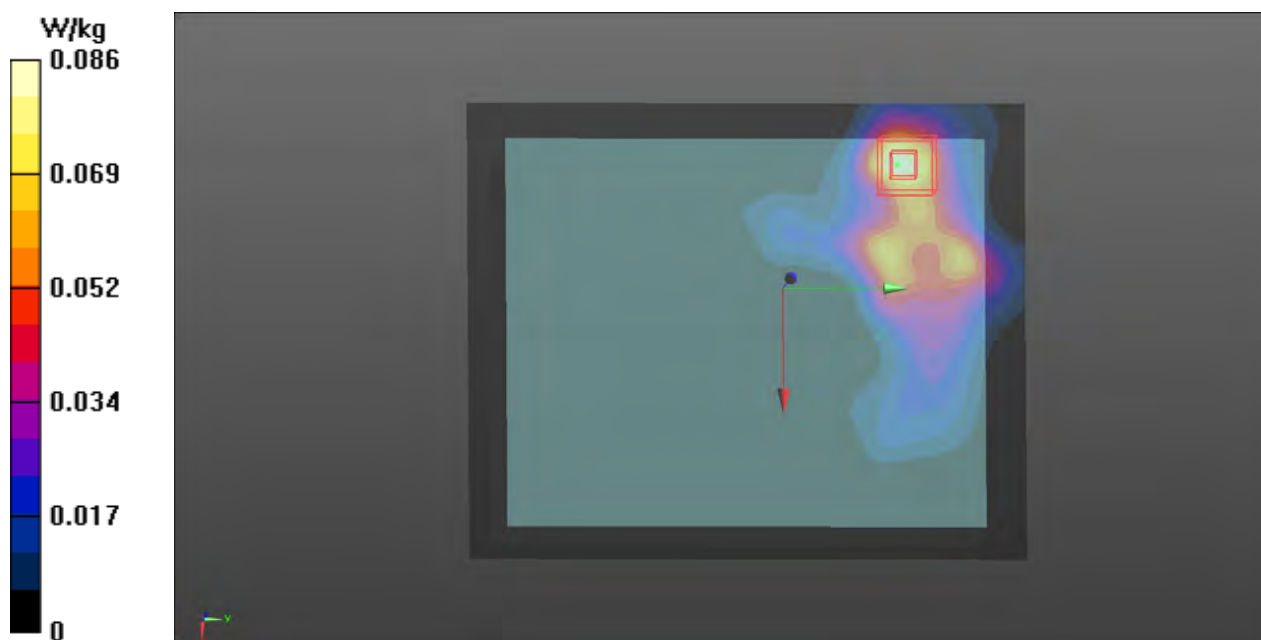

## P02 802.11b\_Rear Face\_0cm\_Ch6

**DUT: 581826**

Communication System: WLAN\_2.4G; Frequency: 2437 MHz; Duty Cycle: 1:1  
 Medium: B2450\_150915 Medium parameters used:  $f = 2437$  MHz;  $\sigma = 1.988$  S/m;  $\epsilon_r = 51.319$ ;  $\rho = 1000$  kg/m<sup>3</sup>

**Ambient Temperature : 23.4 °C; Liquid Temperature : 22.5 °C**

DASY5 Configuration:

- Probe: EX3DV4 - SN3976; ConvF(7.26, 7.26, 7.26); Calibrated: 2015/2/26;
- Sensor-Surface: 2mm (Mechanical Surface Detection)
- Electronics: DAE4 Sn1424; Calibrated: 2015/2/20
- Phantom: ELI v5.0; Type: QDOVA002AA; Serial: TP:1238
- Measurement SW: DASY52, Version 52.8 (8); SEMCAD X Version 14.6.10 (7331)

**Ch6/Area Scan (151x181x1):** Interpolated grid: dx=1.200 mm, dy=1.200 mm

Reference Value = 2.568 V/m; Power Drift = 0.08 dB

**Fast SAR: SAR(1 g) = 0.014 W/kg; SAR(10 g) = 0.00567 W/kg**

Maximum value of SAR (interpolated) = 0.0132 W/kg

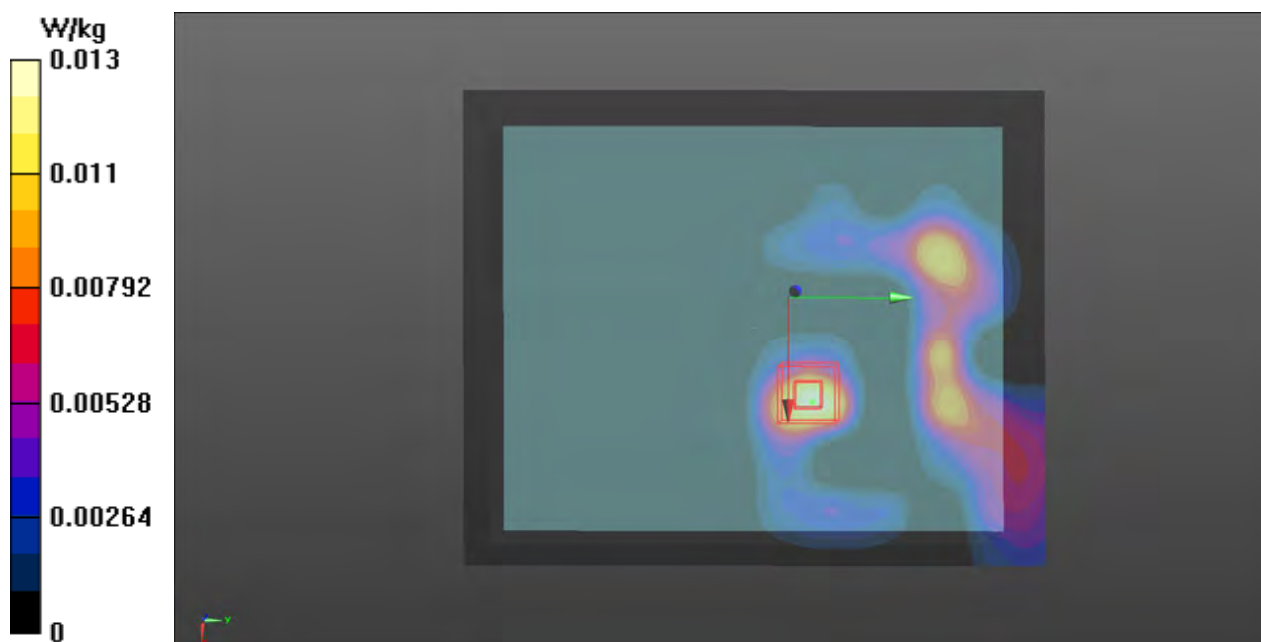



**P03 802.11b\_Edge1\_0cm\_Ch6****DUT: 581826**

Communication System: WLAN\_2.4G; Frequency: 2437 MHz; Duty Cycle: 1:1  
Medium: B2450\_150915 Medium parameters used:  $f = 2437$  MHz;  $\sigma = 1.988$  S/m;  $\epsilon_r = 51.319$ ;  $\rho = 1000$  kg/m<sup>3</sup>

**Ambient Temperature : 23.4 °C; Liquid Temperature : 22.5 °C**

DASY5 Configuration:

- Probe: EX3DV4 - SN3976; ConvF(7.26, 7.26, 7.26); Calibrated: 2015/2/26;
- Sensor-Surface: 2mm (Mechanical Surface Detection)
- Electronics: DAE4 Sn1424; Calibrated: 2015/2/20
- Phantom: ELI v5.0; Type: QDOVA002AA; Serial: TP:1238
- Measurement SW: DASY52, Version 52.8 (8); SEMCAD X Version 14.6.10 (7331)

**Ch6/Area Scan (101x181x1):** Interpolated grid: dx=1.200 mm, dy=1.200 mm

Reference Value = 4.531 V/m; Power Drift = 0.04 dB

**Fast SAR: SAR(1 g) = 0.030 W/kg; SAR(10 g) = 0.016 W/kg**

Maximum value of SAR (interpolated) = 0.0425 W/kg

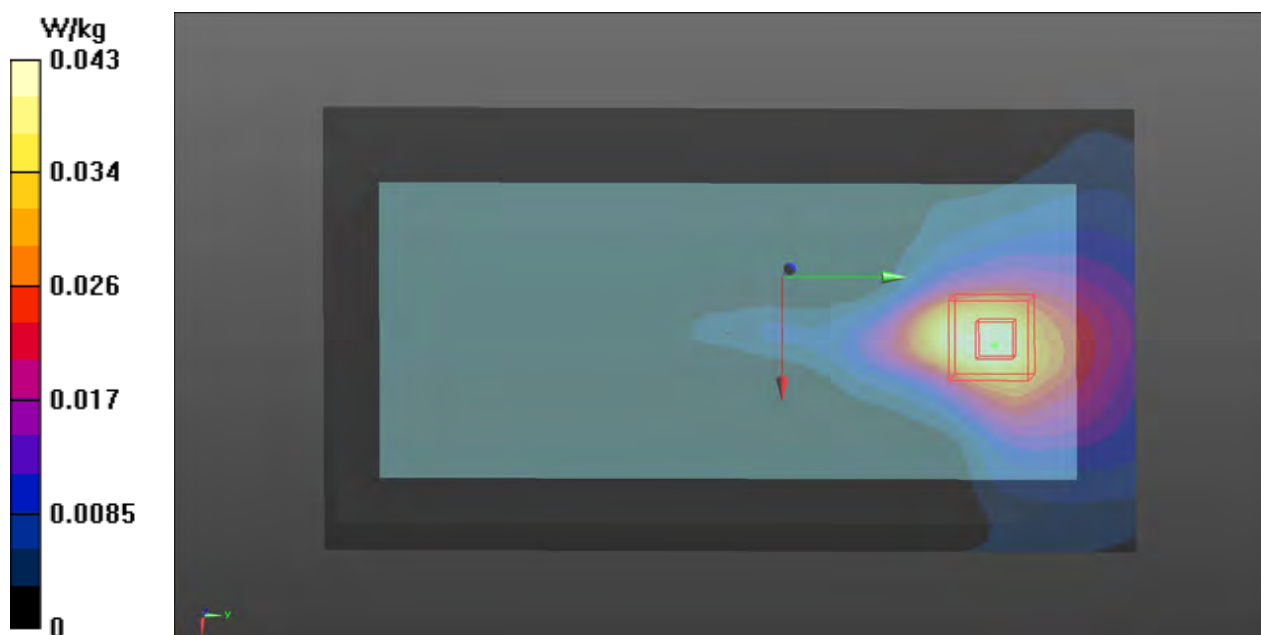

### P04 802.11b\_Edge3\_0cm\_Ch6

**DUT: 581826**

Communication System: WLAN\_2.4G; Frequency: 2437 MHz; Duty Cycle: 1:1  
Medium: B2450\_150915 Medium parameters used:  $f = 2437$  MHz;  $\sigma = 1.988$  S/m;  $\epsilon_r = 51.319$ ;  $\rho = 1000$  kg/m<sup>3</sup>

**Ambient Temperature : 23.4 °C; Liquid Temperature : 22.5 °C**

DASY5 Configuration:

- Probe: EX3DV4 - SN3976; ConvF(7.26, 7.26, 7.26); Calibrated: 2015/2/26;
- Sensor-Surface: 2mm (Mechanical Surface Detection)
- Electronics: DAE4 Sn1424; Calibrated: 2015/2/20
- Phantom: ELI v5.0; Type: QDOVA002AA; Serial: TP:1238
- Measurement SW: DASY52, Version 52.8 (8); SEMCAD X Version 14.6.10 (7331)

**Ch6/Area Scan (101x181x1):** Interpolated grid: dx=1.200 mm, dy=1.200 mm

Maximum value of SAR (interpolated) = 0.216 W/kg

**Ch6/Zoom Scan (5x5x7)/Cube 0:** Measurement grid: dx=8mm, dy=8mm, dz=5mm

Reference Value = 10.17 V/m; Power Drift = 0.02 dB

Peak SAR (extrapolated) = 0.307 W/kg

**SAR(1 g) = 0.136 W/kg; SAR(10 g) = 0.058 W/kg**

Maximum value of SAR (measured) = 0.211 W/kg

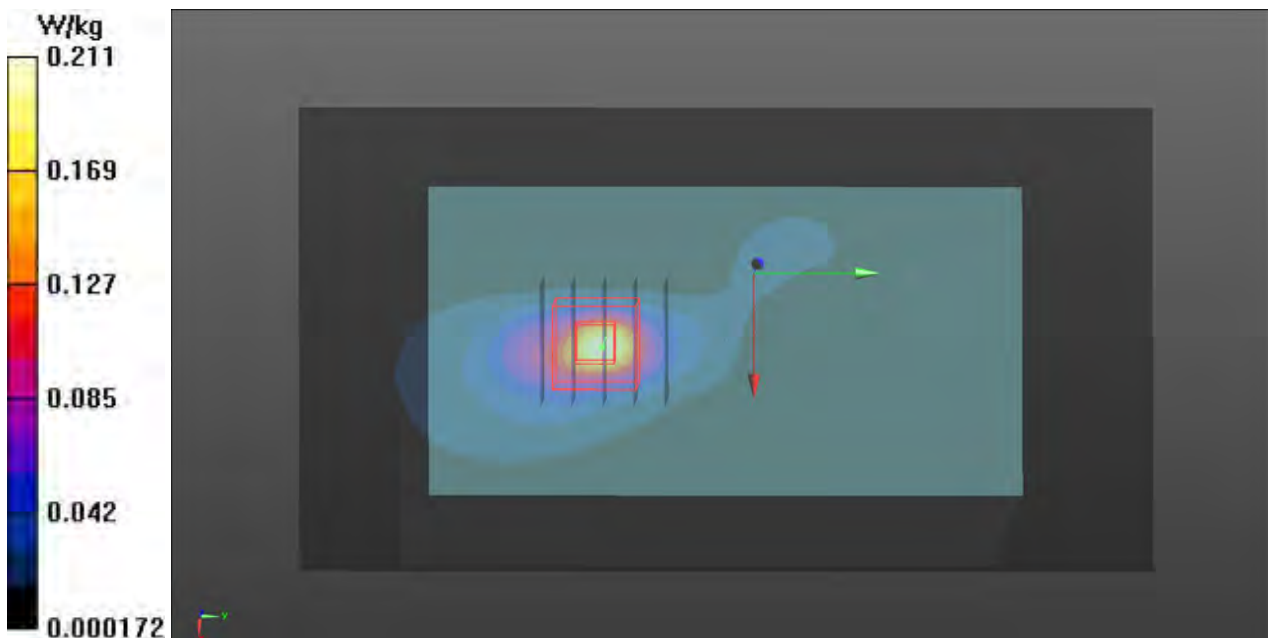

**P05 802.11b\_Edge3\_0cm\_Ch6\_Holster****DUT: 581826**

Communication System: WLAN\_2.4G; Frequency: 2437 MHz; Duty Cycle: 1:1  
Medium: B2450\_150915 Medium parameters used:  $f = 2437$  MHz;  $\sigma = 1.988$  S/m;  $\epsilon_r = 51.319$ ;  $\rho = 1000$  kg/m<sup>3</sup>

**Ambient Temperature : 23.4 °C; Liquid Temperature : 22.5 °C**

DASY5 Configuration:

- Probe: EX3DV4 - SN3976; ConvF(7.26, 7.26, 7.26); Calibrated: 2015/2/26;
- Sensor-Surface: 2mm (Mechanical Surface Detection)
- Electronics: DAE4 Sn1424; Calibrated: 2015/2/20
- Phantom: ELI v5.0; Type: QDOVA002AA; Serial: TP:1238
- Measurement SW: DASY52, Version 52.8 (8); SEMCAD X Version 14.6.10 (7331)

**Ch6/Area Scan (101x181x1):** Interpolated grid: dx=1.200 mm, dy=1.200 mm

Maximum value of SAR (interpolated) = 0.105 W/kg

**Ch6/Zoom Scan (5x5x7)/Cube 0:** Measurement grid: dx=8mm, dy=8mm, dz=5mm

Reference Value = 6.582 V/m; Power Drift = -0.04 dB

Peak SAR (extrapolated) = 0.145 W/kg

**SAR(1 g) = 0.071 W/kg; SAR(10 g) = 0.034 W/kg**

Maximum value of SAR (measured) = 0.107 W/kg

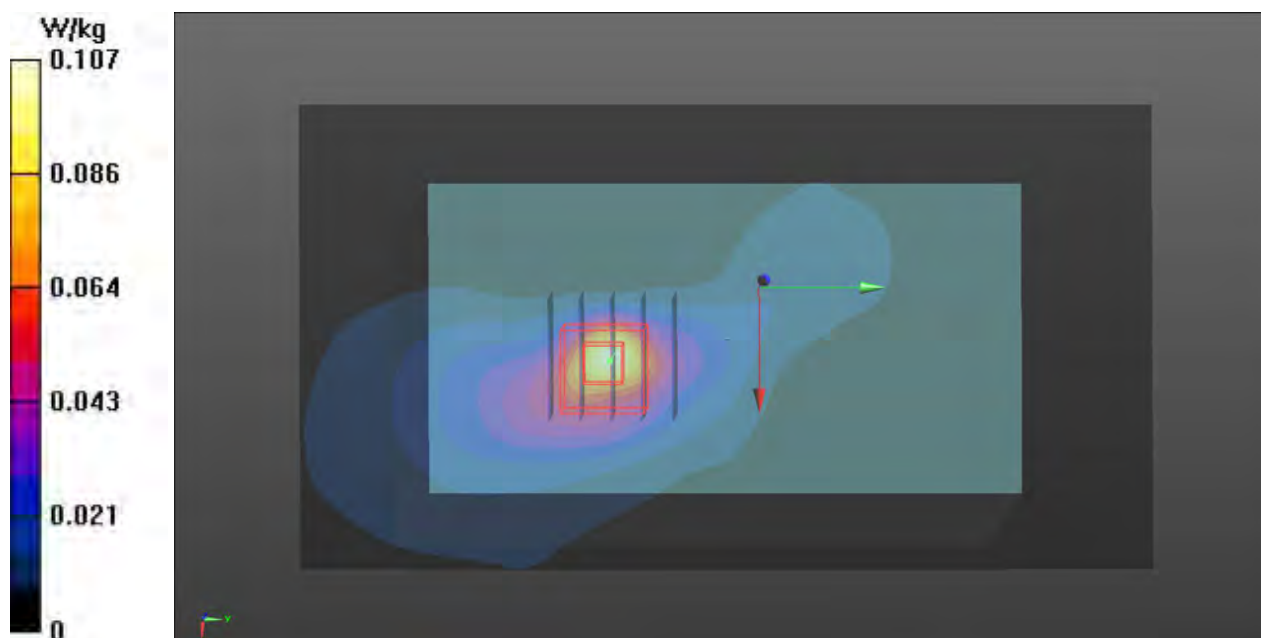

### P07 802.11a\_Front Face\_0cm\_Ch40

**DUT: 581826**

Communication System: WLAN\_5G; Frequency: 5200 MHz; Duty Cycle: 1:1  
Medium: B5G\_150915 Medium parameters used:  $f = 5200$  MHz;  $\sigma = 5.397$  S/m;  $\epsilon_r = 48.089$ ;  $\rho = 1000$  kg/m<sup>3</sup>

**Ambient Temperature : 23.1 °C; Liquid Temperature : 22.3 °C**

DASY5 Configuration:

- Probe: EX3DV4 - SN3976; ConvF(4.52, 4.52, 4.52); Calibrated: 2015/2/26;
- Sensor-Surface: 2mm (Mechanical Surface Detection)
- Electronics: DAE4 Sn1424; Calibrated: 2015/2/20
- Phantom: ELI v5.0; Type: QDOVA002AA; Serial: TP:1238
- Measurement SW: DASY52, Version 52.8 (8); SEMCAD X Version 14.6.10 (7331)

**Ch40/Area Scan (181x221x1):** Interpolated grid: dx=1.000 mm, dy=1.000 mm  
Maximum value of SAR (interpolated) = 0.133 W/kg

**Ch40/Zoom Scan (6x6x12)/Cube 0:** Measurement grid: dx=5mm, dy=5mm, dz=2mm  
Reference Value = 3.320 V/m; Power Drift = 0.07 dB  
Peak SAR (extrapolated) = 0.187 W/kg  
**SAR(1 g) = 0.049 W/kg; SAR(10 g) = 0.017 W/kg**  
Maximum value of SAR (measured) = 0.0944 W/kg

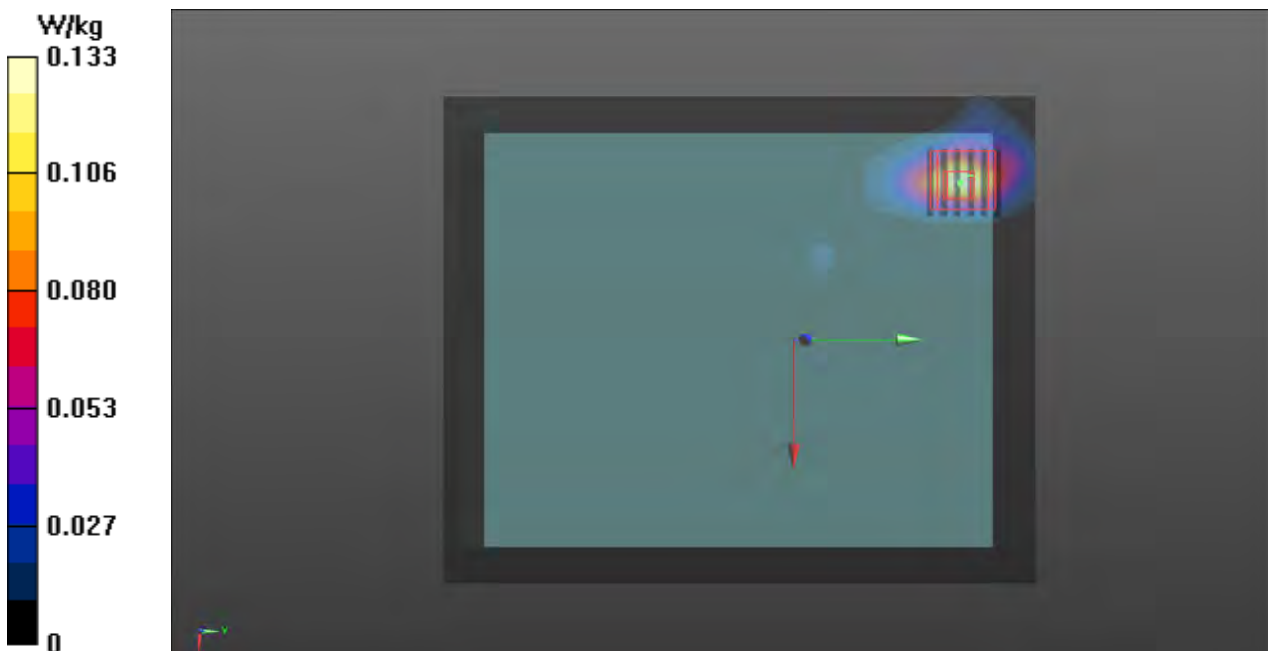

**P08 802.11a\_Rear Face\_0cm\_Ch40****DUT: 581826**

Communication System: WLAN\_5G; Frequency: 5200 MHz; Duty Cycle: 1:1

Medium: B5G\_150915 Medium parameters used:  $f = 5200$  MHz;  $\sigma = 5.397$  S/m;  $\epsilon_r = 48.089$ ;  $\rho = 1000$  kg/m<sup>3</sup>**Ambient Temperature : 23.1 °C; Liquid Temperature : 22.3 °C**

DASY5 Configuration:

- Probe: EX3DV4 - SN3976; ConvF(4.52, 4.52, 4.52); Calibrated: 2015/2/26;
- Sensor-Surface: 2mm (Mechanical Surface Detection)
- Electronics: DAE4 Sn1424; Calibrated: 2015/2/20
- Phantom: ELI v5.0; Type: QDOVA002AA; Serial: TP:1238
- Measurement SW: DASY52, Version 52.8 (8); SEMCAD X Version 14.6.10 (7331)

**Ch40/Area Scan (181x221x1):** Interpolated grid: dx=1.000 mm, dy=1.000 mm

Reference Value = 0.52 V/m; Power Drift = -0.09 dB

**Fast SAR: SAR(1 g) = 0.00146 W/kg; SAR(10 g) = 0.000314 W/kg**

Maximum value of SAR (interpolated) = 0.00568 W/kg

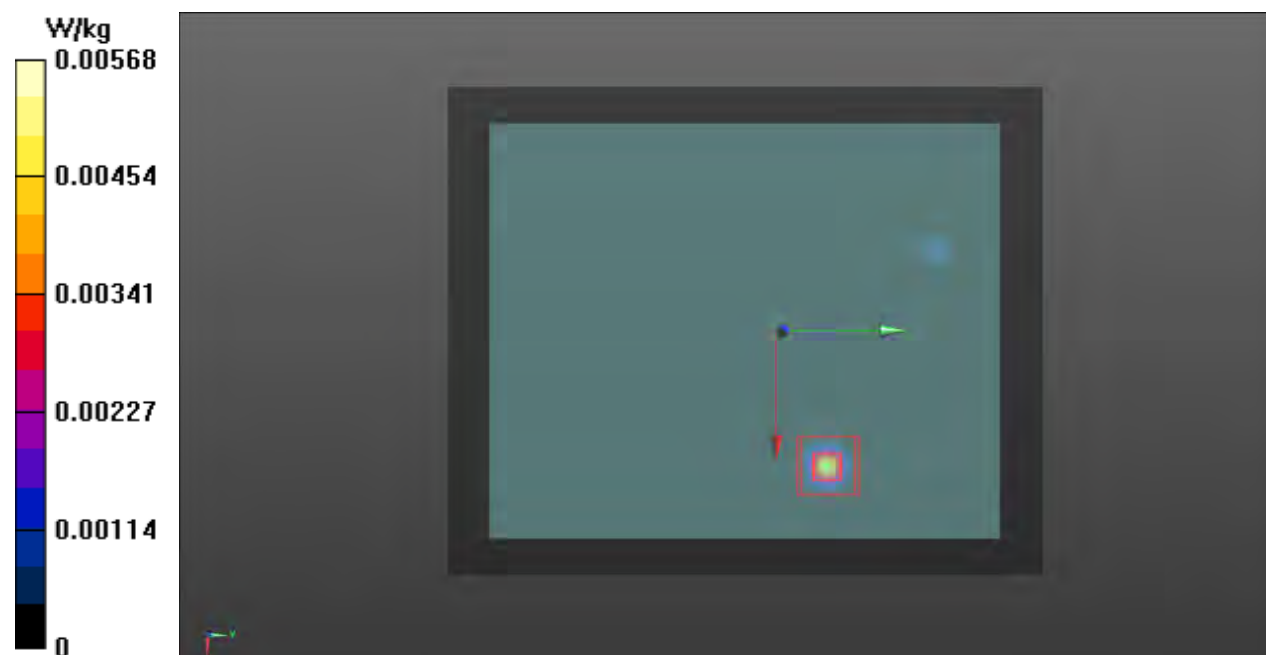

**P09 802.11a\_Edge1\_0cm\_Ch40****DUT: 581826**

Communication System: WLAN\_5G; Frequency: 5200 MHz; Duty Cycle: 1:1

Medium: B5G\_150915 Medium parameters used:  $f = 5200$  MHz;  $\sigma = 5.397$  S/m;  $\epsilon_r = 48.089$ ;  $\rho = 1000$  kg/m<sup>3</sup>**Ambient Temperature : 23.1 °C; Liquid Temperature : 22.3 °C**

DASY5 Configuration:

- Probe: EX3DV4 - SN3976; ConvF(4.52, 4.52, 4.52); Calibrated: 2015/2/26;
- Sensor-Surface: 2mm (Mechanical Surface Detection)
- Electronics: DAE4 Sn1424; Calibrated: 2015/2/20
- Phantom: ELI v5.0; Type: QDOVA002AA; Serial: TP:1238
- Measurement SW: DASY52, Version 52.8 (8); SEMCAD X Version 14.6.10 (7331)

**Ch40/Area Scan (121x221x1):** Interpolated grid: dx=1.000 mm, dy=1.000 mm

Reference Value = 0.74 V/m; Power Drift = 0.00 dB

**Fast SAR: SAR(1 g) = 0.021 W/kg; SAR(10 g) = 0.00769 W/kg**

Maximum value of SAR (interpolated) = 0.0458 W/kg

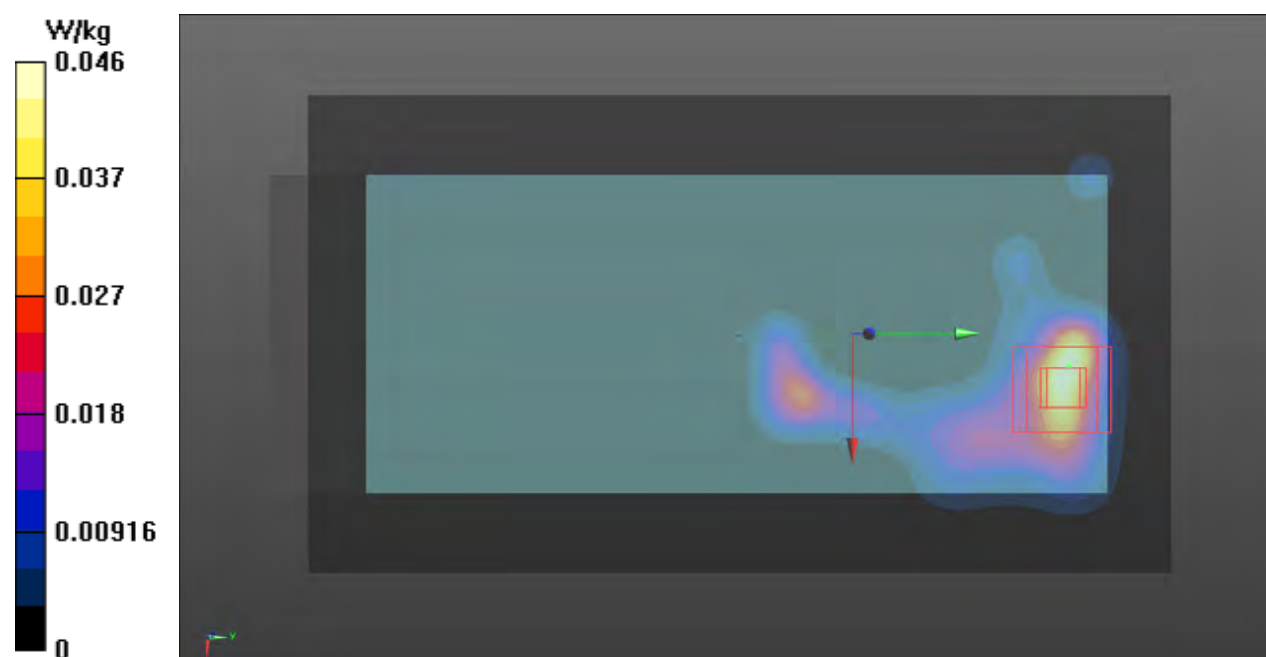

## P10 802.11a\_Edge3\_0cm\_Ch40

**DUT: 581826**

Communication System: WLAN\_5G; Frequency: 5200 MHz; Duty Cycle: 1:1  
 Medium: B5G\_150915 Medium parameters used:  $f = 5200$  MHz;  $\sigma = 5.397$  S/m;  $\epsilon_r = 48.089$ ;  $\rho = 1000$  kg/m<sup>3</sup>

**Ambient Temperature : 23.1 °C; Liquid Temperature : 22.3 °C**

DASY5 Configuration:

- Probe: EX3DV4 - SN3976; ConvF(4.52, 4.52, 4.52); Calibrated: 2015/2/26;
- Sensor-Surface: 2mm (Mechanical Surface Detection)
- Electronics: DAE4 Sn1424; Calibrated: 2015/2/20
- Phantom: ELI v5.0; Type: QDOVA002AA; Serial: TP:1238
- Measurement SW: DASY52, Version 52.8 (8); SEMCAD X Version 14.6.10 (7331)

**Ch40/Area Scan (121x221x1):** Interpolated grid: dx=1.000 mm, dy=1.000 mm

Reference Value = 2.944 V/m; Power Drift = 0.07 dB

**Fast SAR: SAR(1 g) = 0.023 W/kg; SAR(10 g) = 0.00679 W/kg**

Maximum value of SAR (interpolated) = 0.0668 W/kg

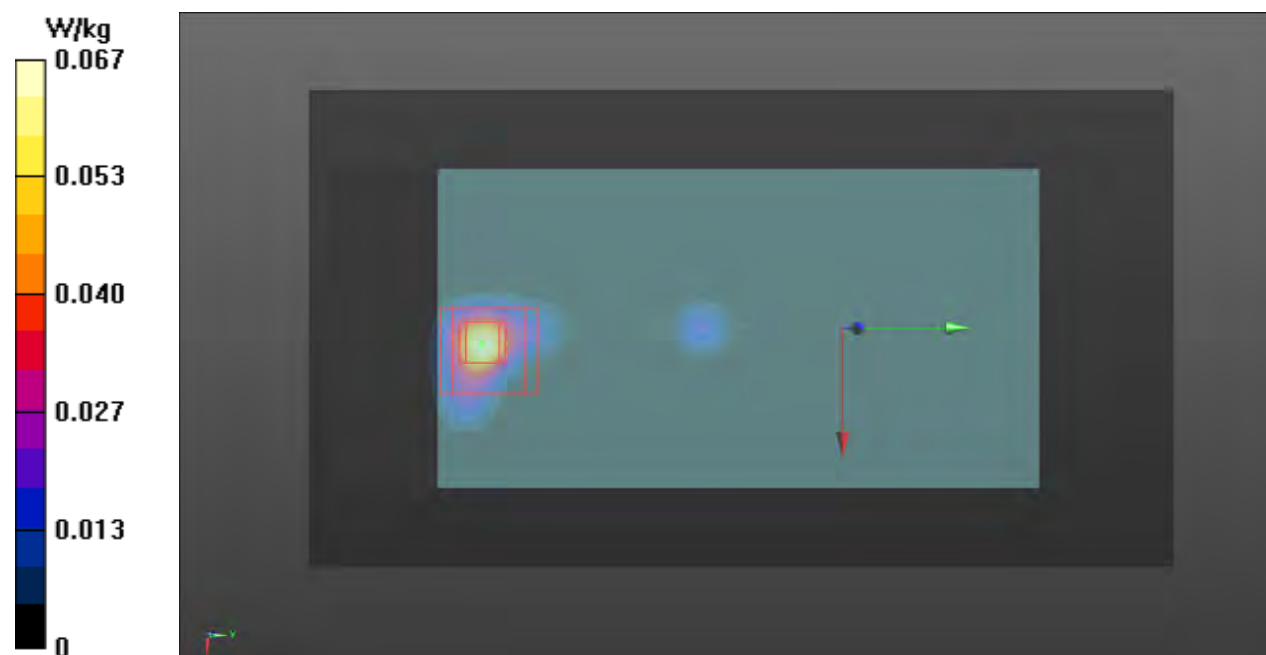

**P11 802.11a\_Front Face\_0cm\_Ch40\_Holster****DUT: 581826**

Communication System: WLAN\_5G; Frequency: 5200 MHz; Duty Cycle: 1:1

Medium: B5G\_150915 Medium parameters used:  $f = 5200$  MHz;  $\sigma = 5.397$  S/m;  $\epsilon_r = 48.089$ ;  $\rho = 1000$  kg/m<sup>3</sup>**Ambient Temperature : 23.1 °C; Liquid Temperature : 22.3 °C**

DASY5 Configuration:

- Probe: EX3DV4 - SN3976; ConvF(4.52, 4.52, 4.52); Calibrated: 2015/2/26;
- Sensor-Surface: 2mm (Mechanical Surface Detection)
- Electronics: DAE4 Sn1424; Calibrated: 2015/2/20
- Phantom: ELI v5.0; Type: QDOVA002AA; Serial: TP:1238
- Measurement SW: DASY52, Version 52.8 (8); SEMCAD X Version 14.6.10 (7331)

**Ch40/Area Scan (181x221x1):** Interpolated grid: dx=1.000 mm, dy=1.000 mm

Maximum value of SAR (interpolated) = 0.0701 W/kg

**Ch40/Zoom Scan (6x6x12)/Cube 0:** Measurement grid: dx=5mm, dy=5mm, dz=2mm

Reference Value = 3.148 V/m; Power Drift = 0.06 dB

Peak SAR (extrapolated) = 0.145 W/kg

**SAR(1 g) = 0.030 W/kg; SAR(10 g) = 0.012 W/kg**

Maximum value of SAR (measured) = 0.0616 W/kg

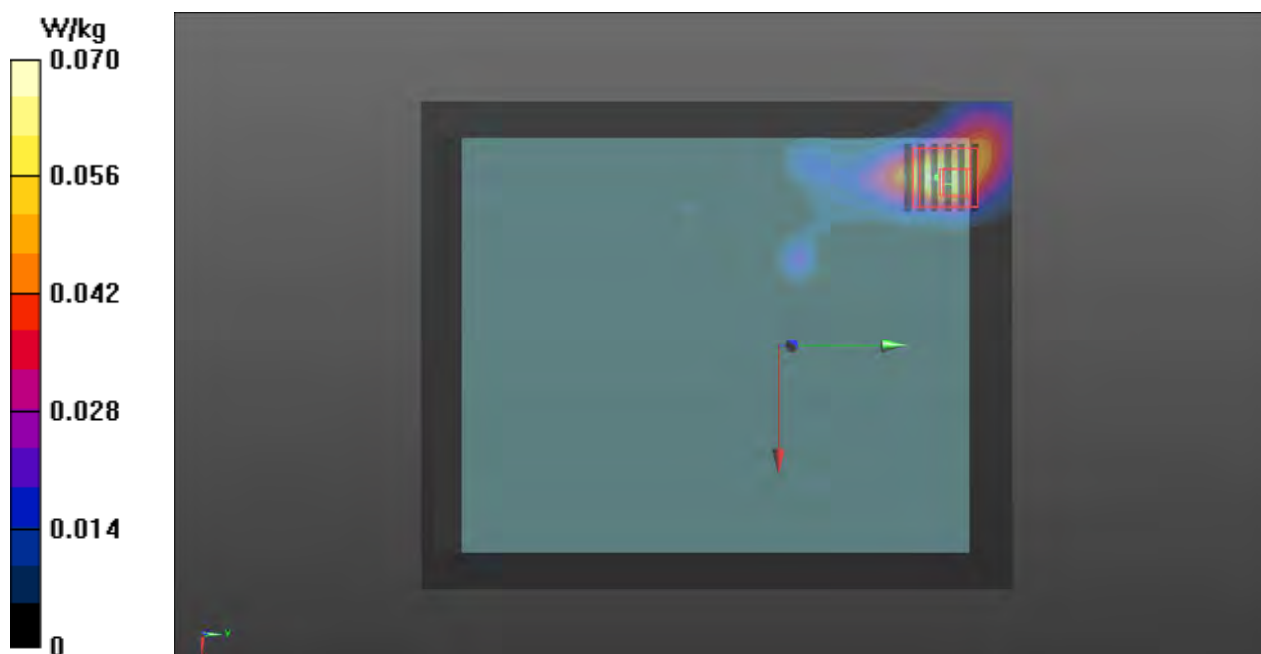



**P12 802.11n\_HT20\_Front Face\_0cm\_Ch157****DUT: 581826**

Communication System: WLAN\_5G; Frequency: 5785 MHz; Duty Cycle: 1:1

Medium: B5G\_150915 Medium parameters used:  $f = 5785$  MHz;  $\sigma = 6.21$  S/m;  $\epsilon_r = 47.029$ ;  $\rho = 1000$  kg/m<sup>3</sup>**Ambient Temperature : 23.1 °C; Liquid Temperature : 22.3 °C**

DASY5 Configuration:

- Probe: EX3DV4 - SN3976; ConvF(4.23, 4.23, 4.23); Calibrated: 2015/2/26;
- Sensor-Surface: 2mm (Mechanical Surface Detection)
- Electronics: DAE4 Sn1424; Calibrated: 2015/2/20
- Phantom: ELI v5.0; Type: QDOVA002AA; Serial: TP:1238
- Measurement SW: DASY52, Version 52.8 (8); SEMCAD X Version 14.6.10 (7331)

**Ch157/Area Scan (181x221x1):** Interpolated grid: dx=1.000 mm, dy=1.000 mm

Maximum value of SAR (interpolated) = 0.0578 W/kg

**Ch157/Zoom Scan (6x6x12)/Cube 0:** Measurement grid: dx=5mm, dy=5mm, dz=2mm

Reference Value = 2.435 V/m; Power Drift = 0.06 dB

Peak SAR (extrapolated) = 0.101 W/kg

**SAR(1 g) = 0.027 W/kg; SAR(10 g) = 0.00931 W/kg**

Maximum value of SAR (measured) = 0.0694 W/kg

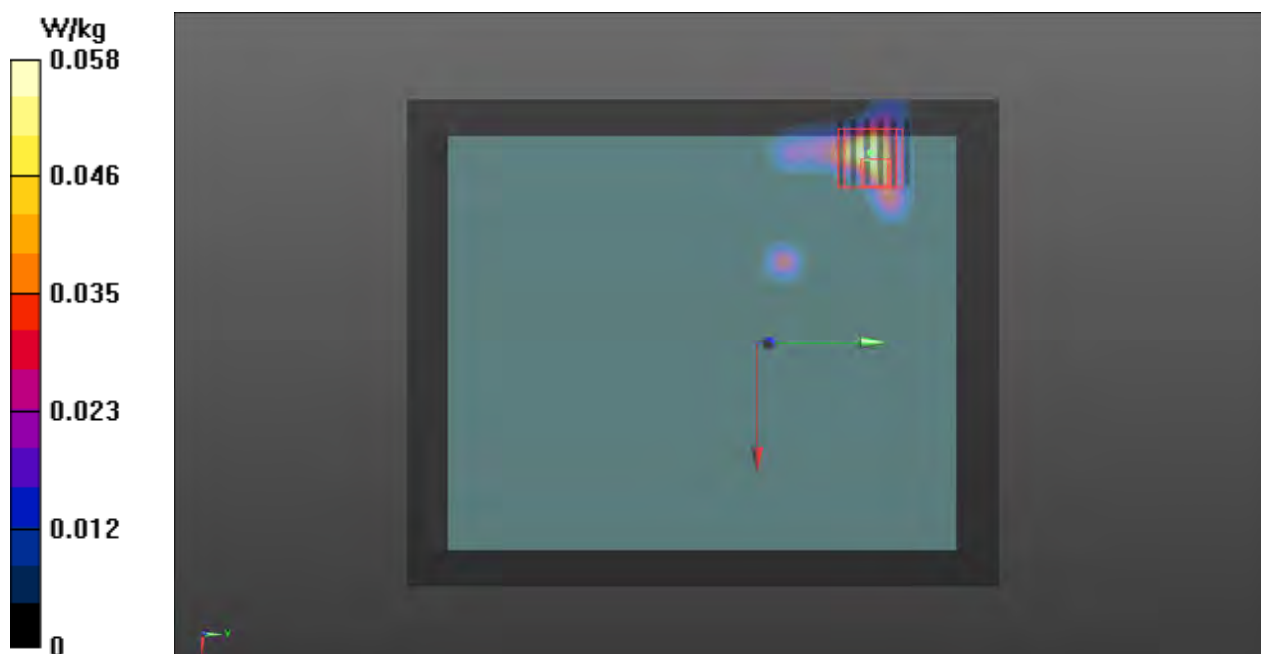

## P13 802.11n\_HT20\_Rear Face\_0cm\_Ch157

**DUT: 581826**

Communication System: WLAN\_5G; Frequency: 5785 MHz; Duty Cycle: 1:1  
 Medium: B5G\_150915 Medium parameters used:  $f = 5785$  MHz;  $\sigma = 6.21$  S/m;  $\epsilon_r = 47.029$ ;  $\rho = 1000$  kg/m<sup>3</sup>

**Ambient Temperature : 23.1 °C; Liquid Temperature : 22.3 °C**

DASY5 Configuration:

- Probe: EX3DV4 - SN3976; ConvF(4.23, 4.23, 4.23); Calibrated: 2015/2/26;
- Sensor-Surface: 2mm (Mechanical Surface Detection)
- Electronics: DAE4 Sn1424; Calibrated: 2015/2/20
- Phantom: ELI v5.0; Type: QDOVA002AA; Serial: TP:1238
- Measurement SW: DASY52, Version 52.8 (8); SEMCAD X Version 14.6.10 (7331)

**Ch157/Area Scan (181x111x1):** Interpolated grid: dx=1.000 mm, dy=1.000 mm

Reference Value = 0.5613 V/m; Power Drift = 0.02 dB

**Fast SAR: SAR(1 g) = 1.15e-006 W/kg; SAR(10 g) = 2.41e-007 W/kg**

Maximum value of SAR (interpolated) = 0.00000460 W/kg

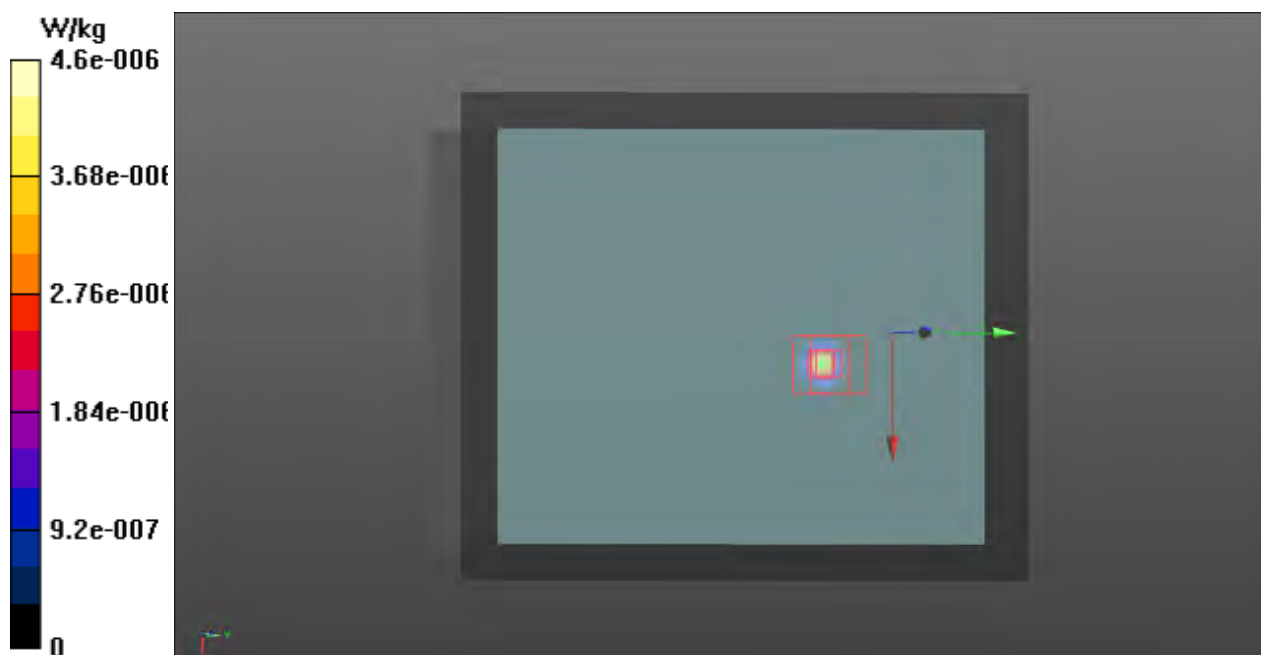

### P14 802.11a\_HT20\_Edge1\_0cm\_Ch157

**DUT: 581826**

Communication System: WLAN\_5G; Frequency: 5785 MHz; Duty Cycle: 1:1  
Medium: B5G\_150915 Medium parameters used:  $f = 5785$  MHz;  $\sigma = 6.21$  S/m;  $\epsilon_r = 47.029$ ;  $\rho = 1000$  kg/m<sup>3</sup>

**Ambient Temperature : 23.1 °C; Liquid Temperature : 22.3 °C**

DASY5 Configuration:

- Probe: EX3DV4 - SN3976; ConvF(4.23, 4.23, 4.23); Calibrated: 2015/2/26;
- Sensor-Surface: 2mm (Mechanical Surface Detection)
- Electronics: DAE4 Sn1424; Calibrated: 2015/2/20
- Phantom: ELI v5.0; Type: QDOVA002AA; Serial: TP:1238
- Measurement SW: DASY52, Version 52.8 (8); SEMCAD X Version 14.6.10 (7331)

**Ch157/Area Scan (121x221x1):** Interpolated grid: dx=1.000 mm, dy=1.000 mm

Reference Value = 0 V/m; Power Drift = 0.00 dB

**Fast SAR: SAR(1 g) = 0.018 W/kg; SAR(10 g) = 0.00557 W/kg**

Maximum value of SAR (interpolated) = 0.0468 W/kg

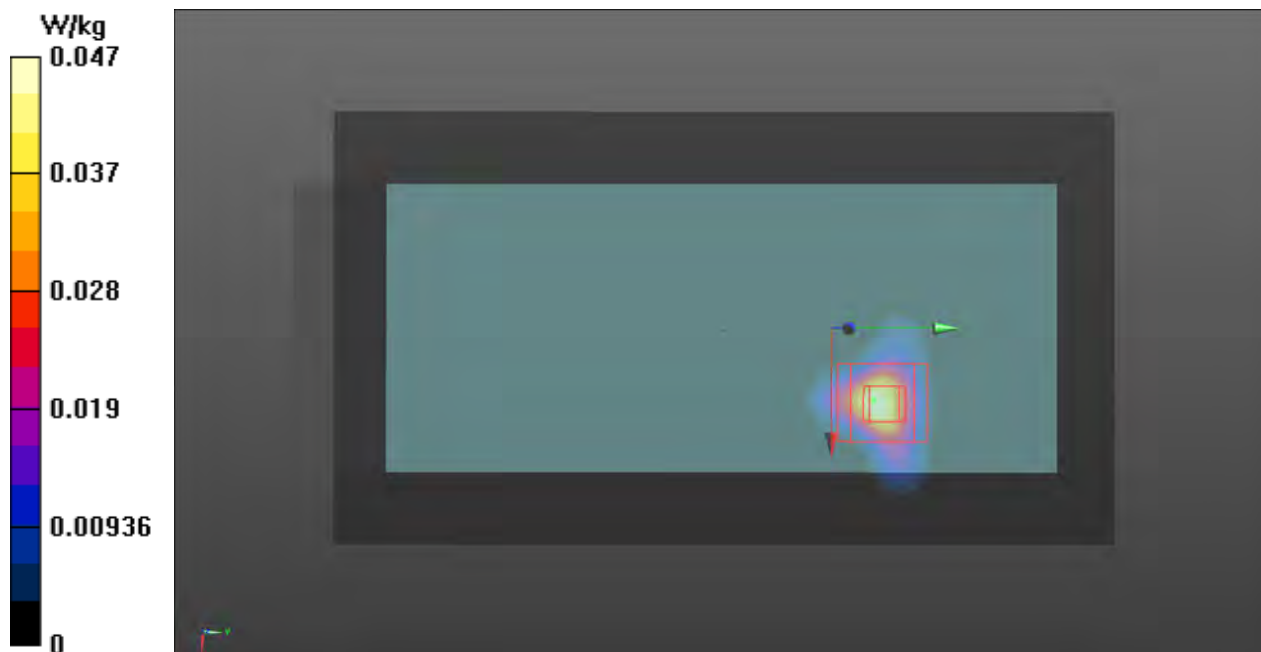

**P15 802.11a\_HT20\_Edge3\_0cm\_Ch157****DUT: 581826**

Communication System: WLAN\_5G; Frequency: 5785 MHz; Duty Cycle: 1:1  
Medium: B5G\_150915 Medium parameters used:  $f = 5785$  MHz;  $\sigma = 6.21$  S/m;  $\epsilon_r = 47.029$ ;  $\rho = 1000$  kg/m<sup>3</sup>

**Ambient Temperature : 23.1 °C; Liquid Temperature : 22.3 °C**

DASY5 Configuration:

- Probe: EX3DV4 - SN3976; ConvF(4.23, 4.23, 4.23); Calibrated: 2015/2/26;
- Sensor-Surface: 2mm (Mechanical Surface Detection)
- Electronics: DAE4 Sn1424; Calibrated: 2015/2/20
- Phantom: ELI v5.0; Type: QDOVA002AA; Serial: TP:1238
- Measurement SW: DASY52, Version 52.8 (8); SEMCAD X Version 14.6.10 (7331)

**Ch157/Area Scan (121x221x1):** Interpolated grid: dx=1.000 mm, dy=1.000 mm

Reference Value = 0.493 V/m; Power Drift = 0.05 dB

**Fast SAR: SAR(1 g) = 0.000644 W/kg; SAR(10 g) = 0.000138 W/kg**

Maximum value of SAR (interpolated) = 0.00249 W/kg

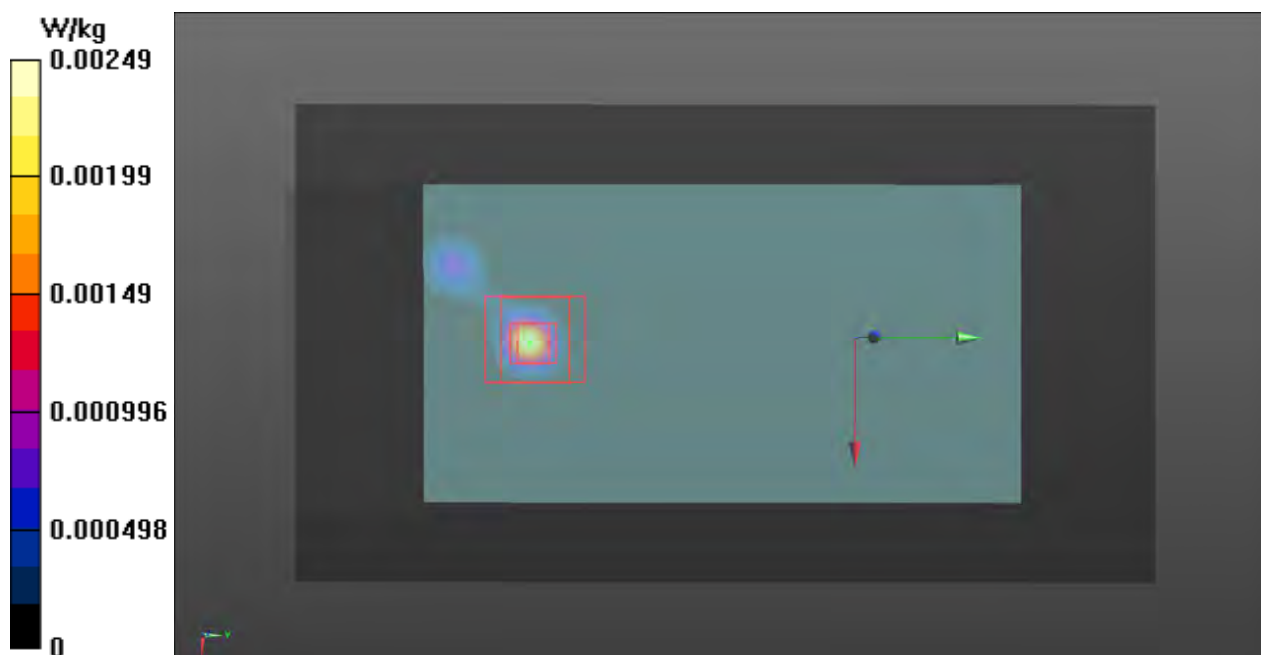

**P16 802.11n\_HT20\_Front Face\_0cm\_Ch157\_Holster****DUT: 581826**

Communication System: WLAN\_5G; Frequency: 5785 MHz; Duty Cycle: 1:1

Medium: B5G\_150915 Medium parameters used:  $f = 5785$  MHz;  $\sigma = 6.21$  S/m;  $\epsilon_r = 47.029$ ;  $\rho = 1000$  kg/m<sup>3</sup>**Ambient Temperature : 23.1 °C; Liquid Temperature : 22.3 °C**

DASY5 Configuration:

- Probe: EX3DV4 - SN3976; ConvF(4.23, 4.23, 4.23); Calibrated: 2015/2/26;
- Sensor-Surface: 2mm (Mechanical Surface Detection)
- Electronics: DAE4 Sn1424; Calibrated: 2015/2/20
- Phantom: ELI v5.0; Type: QDOVA002AA; Serial: TP:1238
- Measurement SW: DASY52, Version 52.8 (8); SEMCAD X Version 14.6.10 (7331)

**Ch157/Area Scan (181x221x1):** Interpolated grid: dx=1.000 mm, dy=1.000 mm

Maximum value of SAR (interpolated) = 0.0671 W/kg

**Ch157/Zoom Scan (6x6x12)/Cube 0:** Measurement grid: dx=5mm, dy=5mm, dz=2mm

Reference Value = 3.127 V/m; Power Drift = -0.03 dB

Peak SAR (extrapolated) = 0.171 W/kg

**SAR(1 g) = 0.022 W/kg; SAR(10 g) = 0.00706 W/kg**

Maximum value of SAR (measured) = 0.0463 W/kg

