

RF Test Report

Applicant : TSC Auto ID Technology Co., Ltd.
Product Type : BT Module
Trade Name : TSC
Model Number : RF-BHS
Applicable Standard : FCC 47 CFR PART 15 SUBPART C
ANSI C63.10:2013
Received Date : Jul. 16, 2019
Test Period : Sep. 10 ~ Nov. 25, 2019
Issued Date : Feb. 07, 2020

Issued by

A Test Lab Techno Corp.
No. 140-1, Changan Street, Bade District,
Taoyuan City 33465, Taiwan (R.O.C.)
Tel : +886-3-2710188 / Fax : +886-3-2710190



Taiwan Accreditation Foundation accreditation number: 1330

Test Firm MRA designation number: TW0010

Note:

- 1.The test results are valid only for samples provided by customers and under the test conditions described in this report.
- 2.This report shall not be reproduced except in full, without the written approval of A Test Lab Technology Corporation.
- 3.The relevant information is provided by customers in this test report. According to the correctness, appropriateness or completeness of the information provided by the customer, if there is any doubt or error in the information which affects the validity of the test results, the laboratory does not take the responsibility.



Revision History

Rev.	Issued Date	Revisions	Revised By
00	Feb. 07, 2020	Initial Issue	Nina. Lin

Verification of Compliance

Issued Date: Feb. 07, 2020

Applicant : TSC Auto ID Technology Co., Ltd.
Product Type : BT Module
Trade Name : TSC
Model Number : RF-BHS
FCC ID : VTV-RFBHS
EUT Rated Voltage : DC 3.3 V
Test Voltage : 120 Vac / 60 Hz, DC 3.3 V
Applicable Standard : FCC 47 CFR PART 15 SUBPART C
ANSI C63.10:2013
Test Result : Complied

Performing Lab. : A Test Lab Techno Corp.
No. 140-1, Changan Street, Bade District,
Taoyuan City 33465, Taiwan (R.O.C.)
Tel : +886-3-2710188 / Fax : +886-3-2710190
Taiwan Accreditation Foundation accreditation number: 1330
<http://www.atl-lab.com.tw/e-index.htm>



A Test Lab Techno Corp. tested the above equipment in accordance with the requirements set forth in the above standards. All indications of Pass/Fail in this report are opinions expressed by A Test Lab Techno Corp. based on interpretations and/or observations of test results. The test results show that the equipment tested is capable of demonstrating compliance with the requirements as documented in this report.

Approved By



(Manager)

(Fly Lu)



TABLE OF CONTENTS

1	General Information	5
	1.1. Summary of Test Result.....	5
	1.2. Measurement Uncertainty.....	6
2	EUT Description	7
3	Test Methodology.....	8
	3.1. Mode of Operation.....	8
	3.2. EUT Test Step.....	8
	3.3. Configuration of Test System Details	9
	3.4. Test Instruments	10
	3.5. Test Site Environment.....	11
4	Measurement Procedure.....	12
	4.1. Maximum Conducted Output Power Measurement.....	12
	4.2. AC Power Line Conducted Emission Measurement.....	13
	4.3. Radiated Emission Measurement	15
	4.4. Antenna Measurement	18
5	Test Results.....	19
	Annex A. Conducted Emission	19
	Annex B. Conducted Test Results	21
	Annex C. Radiated Emission Measurement	22



1 General Information

1.1. Summary of Test Result

Standard	Item	Result	Remark
15.207	AC Power Conducted Emission	PASS	-----
15.203	Antenna Requirement	PASS	-----
15.247(b)(1)	Max. Output Power	PASS	-----
15.247(d)	Transmitter Radiated Emissions	PASS	-----
15.247(a)(1)	20 dB RF Bandwidth	N/A	Note
15.247(a)(1)	Carrier Frequency Separation	N/A	Note
15.247(a)(1)(iii)	Number of Hopping	N/A	Note
15.247(a)(1)(iii)	Time of Occupancy (Dwell Time)	N/A	Note
15.247(d)	Out of Band Conducted Spurious Emission	N/A	Note

Note : Max. Output Power is smaller than the original report, Transmitter Radiated Emissions is larger than the original report but not out of 3 dBm. After evaluation above, C2PC is applicable.

Standard	Description
CFR47, Part 15, Subpart C	Intentional Radiators
ANSI C63. 10: 2013	American National Standard of Procedures for Compliance Testing of Unlicensed Wireless Devices
DA 00-705	Filing and Measurement Guidelines for Frequency Hopping Spread Spectrum Systems



1.2. Measurement Uncertainty

Test Item	Frequency Range	Uncertainty (dB)
Conducted Emission	150 kHz ~ 30 MHz	2.68
Radiated Emission	9 kHz ~ 30 MHz	2.14
	30 MHz ~ 1000 MHz	4.99
	1000 MHz ~ 18000 MHz	4.99
	18000 MHz ~ 26500 MHz	4.23
	26500 MHz ~ 40000 MHz	4.39
Conducted Output Power	0.92 dB	
RF Bandwidth	4.79 %	
Power Spectral Density	0.92 dB	

Decision Rule

- Uncertainty is not included.
- Uncertainty is included.



2 EUT Description

Applicant	TSC Auto ID Technology Co., Ltd. 9F., No. 95, Minguan Rd. Xindian Dist. New Taipei City 23141, Taiwan	
Manufacturer	TSC Auto ID Technology Co., Ltd. 9F., No. 95, Minguan Rd. Xindian Dist. New Taipei City 23141, Taiwan	
Product	BT Module	
Trade Name	TSC	
Model Number	RF-BHS	
FCC ID	VTV-RFBHS	
Class II Permissive Change	PCB board change Internal part location.	
Frequency Range	2402 ~ 2480 MHz	
Modulation Type	GFSK for 1 Mbps	
	$\pi/4$ -DQPSK for 2 Mbps	
	8DPSK for 3 Mbps	
Operate Temp. Range	0 ~ +40 °C	
Antenna information	Type	Max. Gain (dBi)
	Chip Antenna	1

3 Test Methodology

3.1. Mode of Operation

Decision of Test ATL has verified the construction and function in typical operation. All the test modes were carried out with the EUT in normal operation, which was shown in this test report and defined as:

Pre-Test Mode
Mode 1: Transmit mode
Mode 2: GFSK Continuous TX mode
Mode 3: $\pi/4$ -DQPSK Continuous TX mode
Mode 4: 8DPSK Continuous TX mode

After verification, all tests were carried out with the worst case test modes.

By preliminary testing and verifying three axis (X, Y and Z) position of EUT transmitted status, it was found that "X axis" position was the worst, then the final test was executed the worst condition and test data were recorded in this report.

Final-Test Mode
Mode 1: Transmit mode
Mode 2: GFSK Continuous TX mode
Mode 4: 8DPSK Continuous TX mode

Description of Test Modes

Preliminary tests were performed in different modulation to find the worst case. The modulation has shown the worst-case in section 4.5. Investigation has been done on all the possible configurations for searching the worst cases.

3.2. EUT Test Step

1	Setup the EUT shown on "Configuration of Test System Details."
2	Turn on the power of all equipment.
3	Turn on TX function
4	EUT run test program.

Measurement Software			
No.	Description	Software	Version
1	Conducted Emission	EZ EMC	1.1.4.3
2	Radiated Emission	EZ EMC	1.1.4.4

3.3. Configuration of Test System Details

Conducted Emission

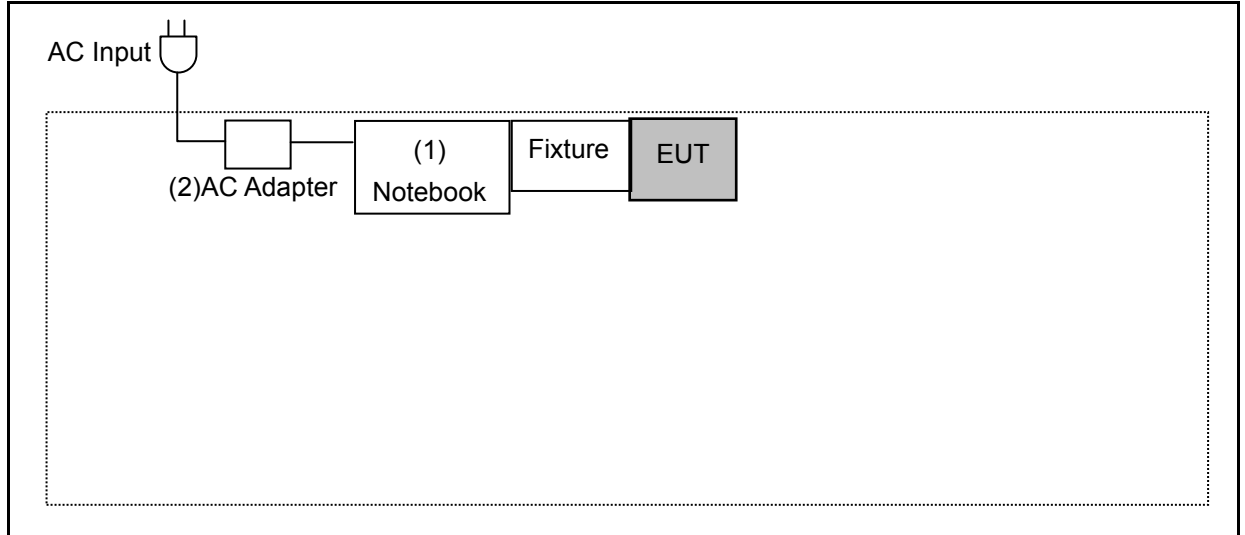

Radiated Emissions

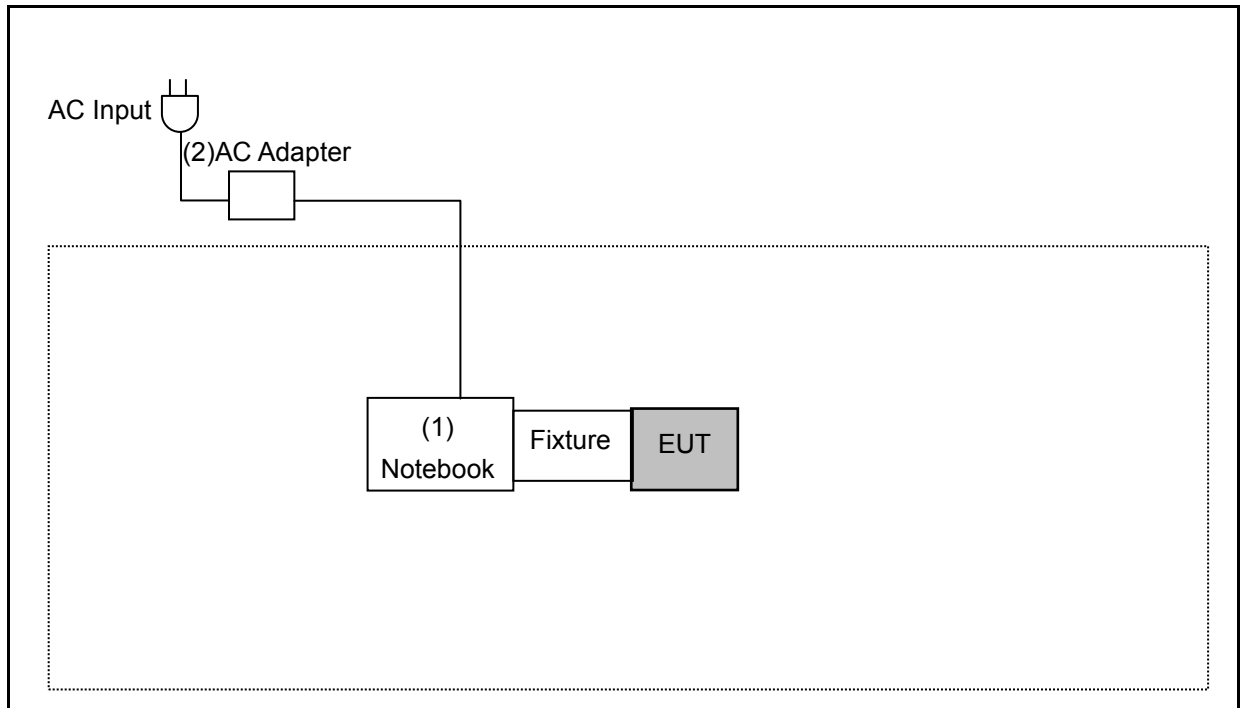

Devices Description					
	Product	Manufacturer	Model Number	Serial Number	Power Cord
(1)	Notebook	DELL	LATITUDE E6440	5HZBD72	---
(2)	AC Adapter	DELL	HA65NM130	---	Non-Shielded, 0.8 m



3.4. Test Instruments

For Conducted Emission

Test Period: Sep. 10, 2019

Testing Engineer: Louis Shen

Equipment	Manufacturer	Model Number	Serial Number	Cal. Date	Cal. Period
Test Receiver	R&S	ESCI	100367	05/23/2019	1 year
LISN	R&S	ENV216	101040	04/03/2019	1 year
LISN	R&S	ENV216	101041	03/28/2019	1 year
RF Cable	Woken	00100D1380194M	TE-02-03	05/23/2019	1 year

For Radiated Emissions

Test Period: Nov. 25, 2019

Testing Engineer: Ricky Liu

Equipment	Manufacturer	Model Number	Serial Number	Cal. Date	Cal. Period
Spectrum Analyzer (10 Hz~44 GHz)	Keysight	N9010A	MY52221312	01/14/2019	1 year
Pre Amplifier (1~26.5 GHz)	Agilent	8449B	3008A02237	10/18/2019	1 year
Pre Amplifier (100 kHz~1.3 GHz)	Agilent	8447D	2944A11119	01/14/2019	1 year
Broadband Antenna	Schwarzbeck	VULB9168	416	10/23/2019	1 year
Horn Antenna (1~18 GHz)	SCHWARZBECK MESS-ELEKTRONIK	BBHA9120D	9120D-550	08/22/2019	1 year
Horn Antenna (18~40 GHz)	SCHWARZBECK MESS-ELEKTRONIK	BBHA9170	9170-320	08/14/2019	1 year
Loop Antenna	COM-POWER CORPORATION	AL-130	121014	03/29/2019	1 year
RF Cable	EMCI	EMC104-N-N-6000	TE01-1	02/20/2019	1 year
Microwave Cable	EMCI	EMC104-SM-SM-1 3000	170814	10/29/2019	1 year
Microwave Cable	EMCI	EMC102-KM-KM-1 4000	151001	02/20/2019	1 year

Note: N.C.R. = No Calibration Request.



For Conducted

Test Period: Nov. 25, 2019

Testing Engineer: Negi.chiu

Equipment	Manufacturer	Model Number	Serial Number	Cal. Date	Cal. Period
Power Sensor	Anritsu	MA2411B	1126022	09/02/2019	1 year
Power Meter	Anritsu	ML2495A	1135009	09/02/2019	1 year
RF Cable	EMCI	EMC102-KM-KM-2000	151033	09/02/2019	1 year
Temperature & Humidity Chamber	TAICHY	MHU-225LA	980729	04/01/2019	1 year
Test Site	ATL	TE05	TE05	N.C.R.	-----

Note: N.C.R. = No Calibration Request.

3.5. Test Site Environment

Items	Required (IEC 60068-1)	Actual
Temperature (°C)	15-35	20-30
Humidity (%RH)	25-75	45-75
Barometric pressure (mbar)	860-1060	990-1005

4 Measurement Procedure

4.1. Maximum Conducted Output Power Measurement

■ Limit

For frequency hopping systems operating in the 2400–2483.5 MHz band employing at least 75 non-overlapping hopping channels < 0.125 watt.

■ Test Setup

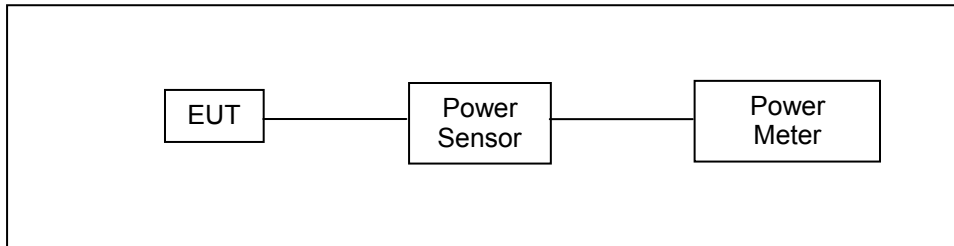

■ Test Procedure

Testing must be done according to this procedure, FCC Public Notice DA 00-705 - Filing and Measurement Guidelines for Frequency Hopping Spread Spectrum Systems. This is the only method recognized by the FCC. The tests below are run with the EUT's transmitter set at high power in TX mode. The EUT is needed to force selection of output power level and channel number. While testing, EUT was set to transmit continuously. Remove the Subjective device's antenna and connect the RF output port to power sensor. The maximum peak output power shall not exceed 1 watt.

Use a direct connection between the antenna port of transmitter and the power sensor, for prevent the power sensor input attenuation 40-50 dB. Set the RBW Bandwidth of the emission or use a channel power meter mode. For antennas with gains of 6 dBi or less, maximum allowed transmitter output is 1 watt (+30 dBm). For antennas with gains greater than 6 dBi, transmitter output level must be decreased by an amount equal to $(\text{GAIN} - 6)/3$ dBm. The antenna port of the EUT was connected to the input of a power sensor. Power was read directly and cable loss correction was added to the reading to obtain power at the EUT antenna terminals.

4.2. AC Power Line Conducted Emission Measurement

■ Limit

Frequency (MHz)	Quasi-peak	Average
0.15 - 0.5	66 to 56	56 to 46
0.50 - 5.0	56	46
5.0 - 30.0	60	50

■ Test Setup

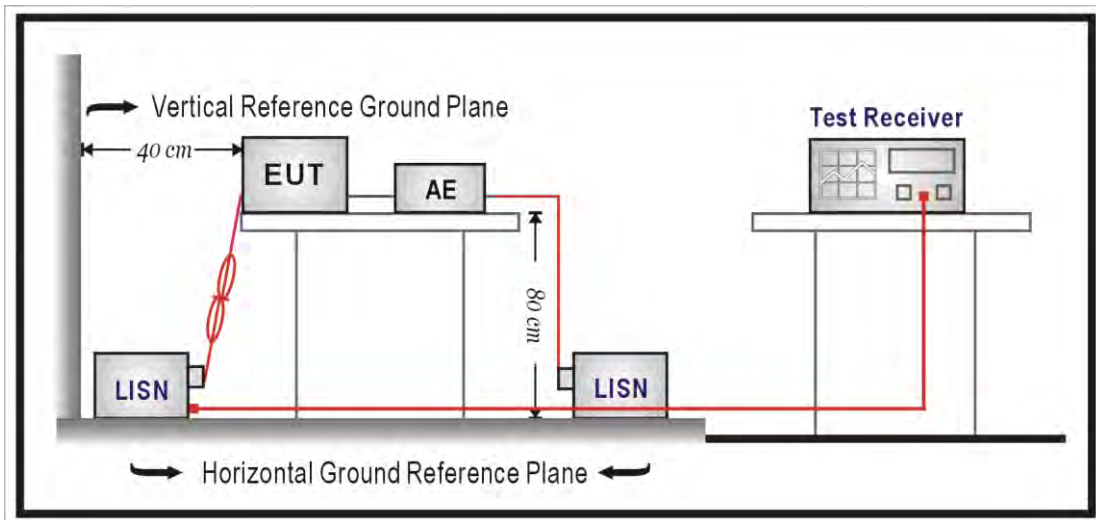

■ Test Procedure

The EUT and simulators are connected to the main power through a line impedance stabilization network (L.I.S.N.). This provides a $50 \Omega // 50 \mu\text{H}$ coupling impedance for the measuring equipment. The peripheral devices are also connected to the main power through a LISN that provides a $50 \Omega // 50 \mu\text{H}$ coupling impedance with 50 ohm termination.

Tabletop device shall be placed on a non-conducting platform, of nominal size 1 m by 1.5 m, raised 80 cm above the reference ground plane. The wall of screened room shall be located 40 cm to the rear of the EUT. Other surfaces of tabletop or floor standing EUT shall be at least 80 cm from any other ground conducting surface including one or more LISNs. For floor-standing device shall be placed under the EUT with a 12 mm insulating material.

Conducted emissions were investigated over the frequency range from 0.15 MHz to 30 MHz using a resolution bandwidth of 9 kHz. The equipment under test (EUT) shall be meet the limits in section 4.1, as applicable, including the average limit and the quasi-peak limit when using respectively, an average detector and quasi-peak detector measured in accordance with the methods described of related standard. When all of peak value were complied with quasi-peak and average limit from 150 kHz to 30 MHz then quasi-peak and average measurement was unnecessary.

The AMN shall be placed 0.8 m from the boundary of the unit under test and bonded to a ground reference plane for AMNs mounted on top of the ground reference plane. This distance is between the closest points of the AMN and the EUT. All other units of the EUT and associated equipment shall be at least 0.8 m from the AMN. If the mains power cable is longer than 1 m then the cable shall be folded back and forth at the centre of the lead to form a bundle no longer than 0.4 m. All of interconnecting cables that hang closer than 40 cm to the ground plane shall be folded back and forth in the center forming a bundle 30 cm to 40 cm long. All of EUT and AE shall be separate place more than 0.1 m. All 50Ω ports of the LISN shall be resistively terminated into 50Ω loads when not connected to the measuring instrument.

If the reading of the measuring receiver shows fluctuations close to the limit, the reading shall be observed for at least 15 s at each measurement frequency; the higher reading shall be recorded with the exception of any brief isolated high reading which shall be ignored.

4.3. Radiated Emission Measurement

■ **Limit**

According to §15.209(a), except as provided elsewhere in this subpart, the emissions from an intentional radiator shall not exceed the field strength levels specified in the following table:

Frequency (MHz)	Field Strength ($\mu\text{V/m}$ at meter)	Measurement Distance (meters)
0.009 – 0.490	$2400 / F$ (kHz)	300
0.490 – 1.705	$24000 / F$ (kHz)	30
1.705 – 30.0	30	30
30 - 88	100**	3
88-216	150**	3
216-960	200**	3
Above 960	500	3

** Except as provided in paragraph (g), fundamental emissions from intentional radiators operating under this Section shall not be located in the frequency bands 54-72 MHz, 76-88 MHz, 174-216 MHz or 470-806 MHz. However, operation within these frequency bands is permitted under other sections of this Part, e.g., Sections 15.231 and 15.241.

■ **Setup**

9 kHz ~ 30 MHz

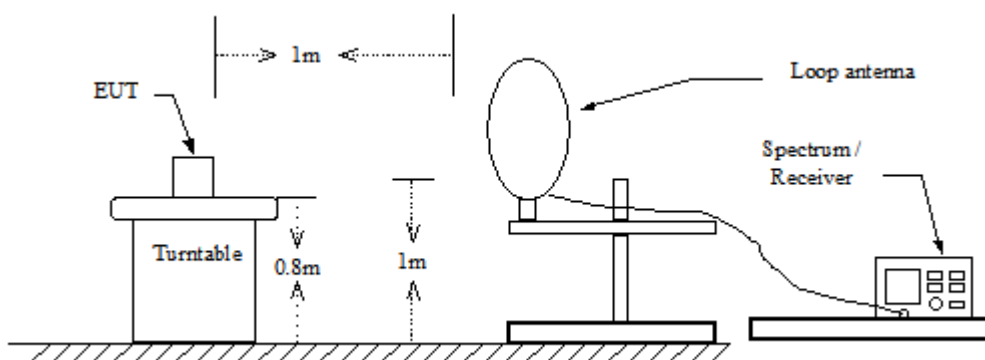

Below 1 GHz

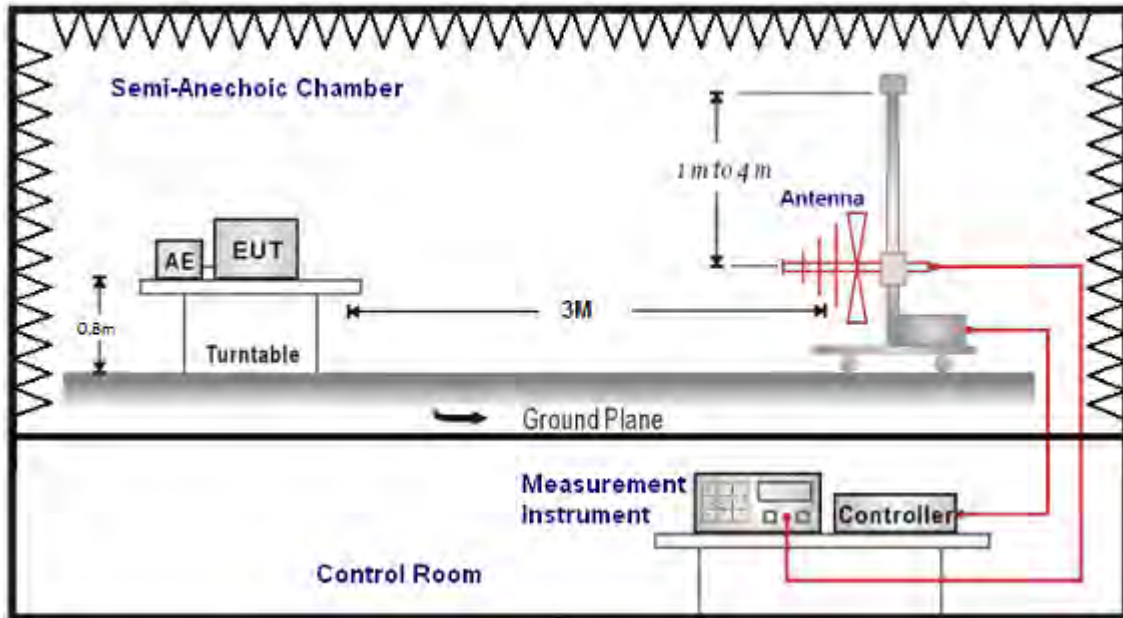

Above 1 GHz

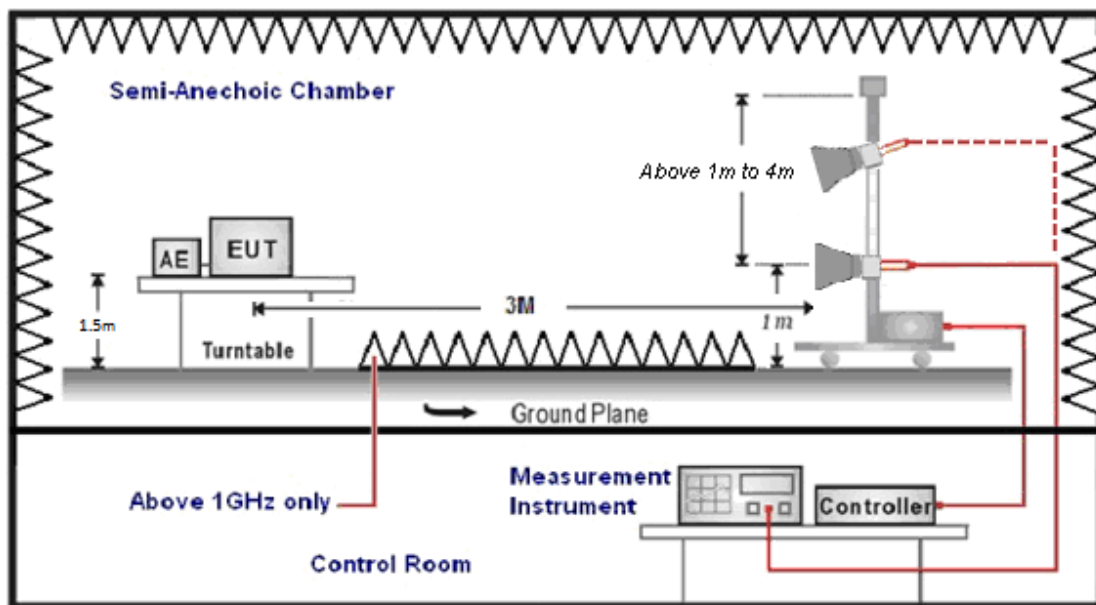

■ Test Procedure

Final radiation measurements were made on a three-meter, Semi Anechoic Chamber. The EUT system was placed on a nonconductive turntable which is 0.8 or 1.5 meters height, top surface 1.0 x 1.5 meter. The spectrum was examined from 250 MHz to 2.5 GHz in order to cover the whole spectrum below 10th harmonic which could generate from the EUT. During the test, EUT was set to transmit continuously & Measurements spectrum range from 9 kHz to 26.5 GHz is investigated.

For measurements below 1 GHz the resolution bandwidth is set to 100 kHz for peak detection measurements or 120 kHz for quasi-peak detection measurements. Peak detection is used unless otherwise noted as quasi-peak.

For measurements above 1 GHz the resolution bandwidth is set to 1 MHz, and then the video bandwidth is set to 3 MHz for peak measurements and 10 Hz for average measurements when Duty cycle >98 % / 1/T for average measurements when Duty cycle <98 %. A nonconductive material surrounded the EUT to supporting the EUT for standing on three orthogonal planes. At each condition, the EUT was rotated 360 degrees, and the antenna was raised and lowered from one to four meters to find the maximum emission levels. Measurements were taken using both horizontal and vertical antenna polarization.

SCHWARZBECK MESS-ELEKTRONIK Biconilog Antenna at 3 Meter and the SCHWARZBECK Double Ridged Guide Antenna was used in frequencies 1 – 26.5 GHz at a distance of 1 meter. All test results were extrapolated to equivalent signal at 3 meters utilizing an inverse linear distance extrapolation Factor (20 dB/decade).

For testing above 1 GHz, the emission level of the EUT in peak mode was 20 dB lower than average limit (that means the emission level in peak mode also complies with the limit in average mode), then testing will be stopped and peak values of EUT will be reported, otherwise, the emissions will be measured in average mode again and reported.

Appropriate preamplifiers were used for improving sensitivity and precautions were taken to avoid overloading or desensitizing the spectrum analyzer. No post – detector video filters were used in the test.

The spectrum analyzer's 6 dB bandwidth was set to 1 MHz, and the analyzer was operated in the peak detection mode, for frequencies both below and up 1 GHz. The average levels were obtained by subtracting the duty cycle correction factor from the peak readings.

The following procedures were used to convert the emission levels measured in decibels referenced to 1 microvolt (dBuV) into field intensity in micro volts per meter (uV/m).

The actual field intensity in decibels referenced to 1 microvolt in to field intensity in micro volts per meter (dBuV/m).

The actual field intensity in referenced to 1 microvolt per meter (dBuV/m) is determined by algebraically adding the measured reading in dBuV, the antenna factor (dB), and cable loss (dB) and Subtracting the gain of preamplifier (dB) is auto calculate in spectrum analyzer.

$$(1) \text{ Amplitude (dBuV/m) = FI (dBuV) +AF (dBuV) +CL (dBuV)-Gain (dB)}$$

FI= Reading of the field intensity.

AF= Antenna factor.

CL= Cable loss.

P.S Amplitude is auto calculate in spectrum analyzer.

$$(2) \text{ Actual Amplitude (dBuV/m) = Amplitude (dBuV)-Dis(dB)}$$

The FCC specified emission limits were calculated according the EUT operating frequency and by following linear interpolation equations:

(a) For fundamental frequency : Transmitter Output < +30 dBm

(b) For spurious frequency : Spurious emission limits = fundamental emission limit /10

Data of measurement within this frequency range without mark in the table above means the reading of emissions are attenuated more than 20 dB below the permissible limits or the field strength is too small to be measured.



4.4. Antenna Measurement

- **Limit**

For intentional device, according to 15.203, an intentional radiator shall be designed to ensure that no antenna other than that furnished by the responsible party shall be used with the device.

And According to 15.247 (b)(4), if transmitting antennas of directional gain greater than 6 dBi are used, the power shall be reduced by the amount in dB that the directional gain of the antenna exceeds 6 dBi.

- **Antenna Connector Construction**

See section 2 – antenna information.



5 Test Results

Annex A. Conducted Emission

Standard:	FCC Part 15.247	Line:	L1
Test Mode:	Mode 1	Power:	AC 120 V/60 Hz
		Temp.(°C)/Hum.(%RH):	26(°C)/60 %RH
Description:			

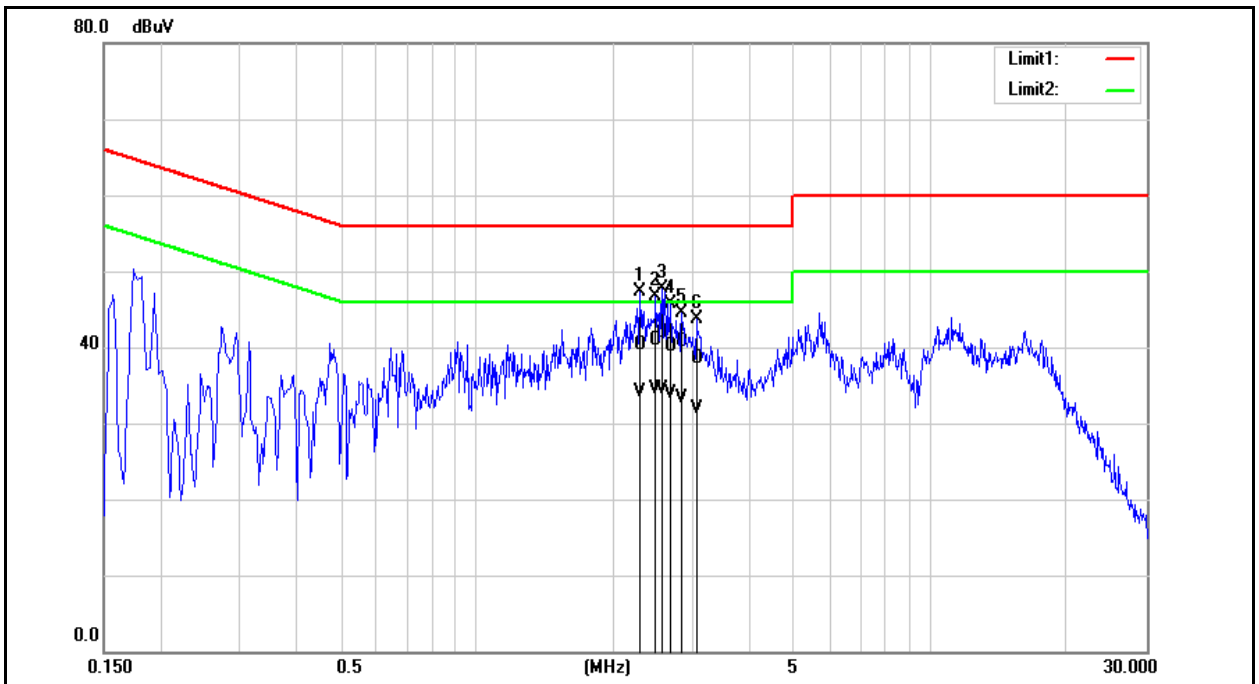

No.	Frequency (MHz)	QP reading (dBuV)	AVG reading (dBuV)	Correction factor (dB)	QP result (dBuV)	AVG result (dBuV)	QP limit (dBuV)	AVG limit (dBuV)	QP margin (dB)	AVG margin (dB)	Remark
1	2.2940	30.55	24.33	9.72	40.27	34.05	56.00	46.00	-15.73	-11.95	Pass
2	2.4860	31.20	24.78	9.73	40.93	34.51	56.00	46.00	-15.07	-11.49	Pass
3	2.5620	32.17	24.68	9.74	41.91	34.42	56.00	46.00	-14.09	-11.58	Pass
4	2.6700	30.29	24.14	9.74	40.03	33.88	56.00	46.00	-15.97	-12.12	Pass
5	2.8260	30.94	23.48	9.74	40.68	33.22	56.00	46.00	-15.32	-12.78	Pass
6	3.0540	28.81	22.06	9.75	38.56	31.81	56.00	46.00	-17.44	-14.19	Pass

Note: 1. Result (dBuV) = Correction factor (dB) + Reading(dBuV).
2. Correction factor (dB) = Cable loss (dB) + L.I.S.N. factor (dB).



Standard:	FCC Part 15.247	Line:	N
Test Mode:	Mode 1	Power:	AC 120 V/60 Hz
		Temp.(°C)/Hum.(%RH):	26(°C)/60 %RH
Description:			

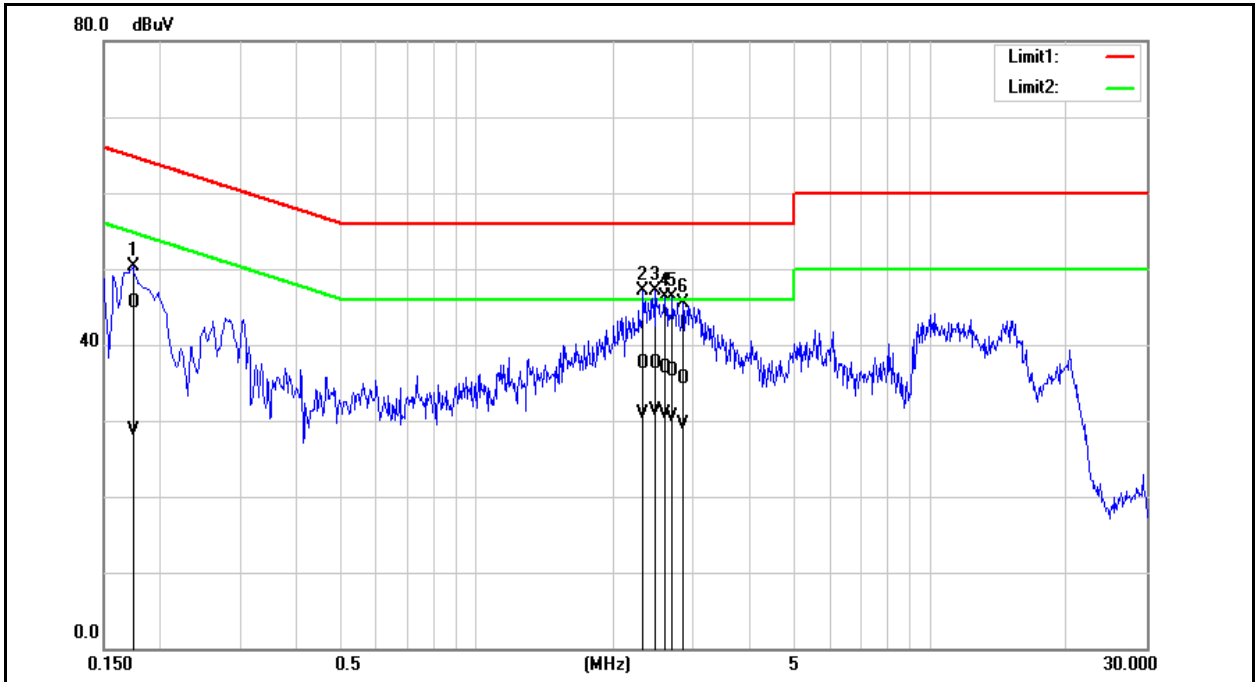

No.	Frequency (MHz)	QP reading (dBuV)	AVG reading (dBuV)	Correction factor (dB)	QP result (dBuV)	AVG result (dBuV)	QP limit (dBuV)	AVG limit (dBuV)	QP margin (dB)	AVG margin (dB)	Remark
1	0.1740	35.90	19.08	9.68	45.58	28.76	64.77	54.77	-19.19	-26.01	Pass
2	2.3260	27.75	21.14	9.76	37.51	30.90	56.00	46.00	-18.49	-15.10	Pass
3	2.4860	27.69	21.54	9.76	37.45	31.30	56.00	46.00	-18.55	-14.70	Pass
4	2.6020	27.13	21.08	9.77	36.90	30.85	56.00	46.00	-19.10	-15.15	Pass
5	2.6980	26.82	20.65	9.77	36.59	30.42	56.00	46.00	-19.41	-15.58	Pass
6	2.8500	25.79	19.83	9.77	35.56	29.60	56.00	46.00	-20.44	-16.40	Pass

Note: 1. Result (dBuV) = Correction factor (dB) + Reading(dBuV).
2. Correction factor (dB) = Cable loss (dB) + L.I.S.N. factor (dB).

Annex B. Conducted Test Results

Maximum Conducted Output Power Measurement

Test Mode	Frequency (MHz)	Packet Type	Average Power		Peak Power		Limit (W)
			(dBm)	(W)	(dBm)	(W)	
Mode 2	2402	DH1	-3.71	0.00043	1.25	0.00133	≤ 0.125
		DH3	-0.87	0.00082	1.29	0.00135	≤ 0.125
		DH5	-0.24	0.00095	1.16	0.00131	≤ 0.125
	2441	DH1	-3.41	0.00046	1.55	0.00143	≤ 0.125
		DH3	-0.35	0.00092	1.53	0.00142	≤ 0.125
		DH5	0.16	0.00104	1.51	0.00142	≤ 0.125
	2480	DH1	-3.26	0.00047	1.63	0.00146	≤ 0.125
		DH3	-0.19	0.00096	1.64	0.00146	≤ 0.125
		DH5	0.29	0.00107	1.65	0.00146	≤ 0.125
Mode 3	2402	2DH1	-4.55	0.00035	1.25	0.00133	≤ 0.125
		2DH3	-2.15	0.00061	1.21	0.00132	≤ 0.125
		2DH5	-1.79	0.00066	1.14	0.00130	≤ 0.125
	2441	2DH1	-4.29	0.00037	1.51	0.00142	≤ 0.125
		2DH3	-1.79	0.00066	1.49	0.00141	≤ 0.125
		2DH5	-1.39	0.00073	1.41	0.00138	≤ 0.125
	2480	2DH1	-4.01	0.00040	1.58	0.00144	≤ 0.125
		2DH3	-1.59	0.00069	1.60	0.00145	≤ 0.125
		2DH5	-1.19	0.00076	1.61	0.00145	≤ 0.125
Mode 4	2402	3DH1	-4.52	0.00035	1.47	0.00140	≤ 0.125
		3DH3	-2.12	0.00061	1.46	0.00140	≤ 0.125
		3DH5	-1.74	0.00067	1.45	0.00140	≤ 0.125
	2441	3DH1	-4.23	0.00038	1.66	0.00147	≤ 0.125
		3DH3	-1.77	0.00067	1.68	0.00147	≤ 0.125
		3DH5	-1.32	0.00074	1.66	0.00147	≤ 0.125
	2480	3DH1	-3.98	0.00040	1.84	0.00153	≤ 0.125
		3DH3	-1.53	0.00070	1.84	0.00153	≤ 0.125
		3DH5	-1.14	0.00077	1.85	0.00153	≤ 0.125

Note: The relevant measured result has the offset with cable loss already.



Annex C. Radiated Emission Measurement

Below 1 GHz

Standard:	FCC Part 15.247	Test Distance:	3 m
Test item:	Harmonic	Power:	DC 3.3 V
Frequency:	2402 MHz	Temp.(°C)/Hum.(%RH):	26(°C)/60 %RH
Test Mode:	Mode 2		

Frequency (MHz)	Reading (dBuV)	Correct Factor (dB/m)	Result (dBuV/m)	Limit (dBuV/m)	Margin (dB)	Remark	Ant.Polar. H / V
207.5100	46.42	-7.89	38.53	43.50	-4.97	QP	H
256.0100	46.07	-5.85	40.22	46.00	-5.78	QP	H
271.5300	46.82	-5.07	41.75	46.00	-4.25	QP	H
288.0200	45.70	-4.40	41.30	46.00	-4.70	QP	H
320.0300	44.85	-3.66	41.19	46.00	-4.81	QP	H
367.5600	44.86	-2.81	42.05	46.00	-3.95	QP	H
93.0500	43.43	-11.81	31.62	43.50	-11.88	QP	V
205.5700	45.19	-7.93	37.26	43.50	-6.24	QP	V
320.0300	40.89	-3.66	37.23	46.00	-8.77	QP	V
367.5600	42.36	-2.81	39.55	46.00	-6.45	QP	V
489.7800	39.17	-0.46	38.71	46.00	-7.29	QP	V
666.3200	34.64	3.06	37.70	46.00	-8.30	QP	V

Note:1.Result (dBuV/m) = Correct Factor (dB/m) + Reading(dBuV).

Example: 38.53 = -7.89 + 46.42.

2.Correction factor (dB/m) = Antenna Factor (dB/m) + Cable loss (dB) – Pre-Amplifier gain (dB).

3.When the peak results are less than average limit, so not need to evaluate the average.



Harmonic

Above 1 GHz

Standard:	FCC Part 15.247	Test Distance:	3 m
Test item:	Harmonic	Power:	DC 3.3 V
Frequency:	2402 MHz	Temp.(°C)/Hum.(%RH):	26(°C)/60 %RH
Mode:	Mode 2		
Ant.Polar.:	Horizontal		

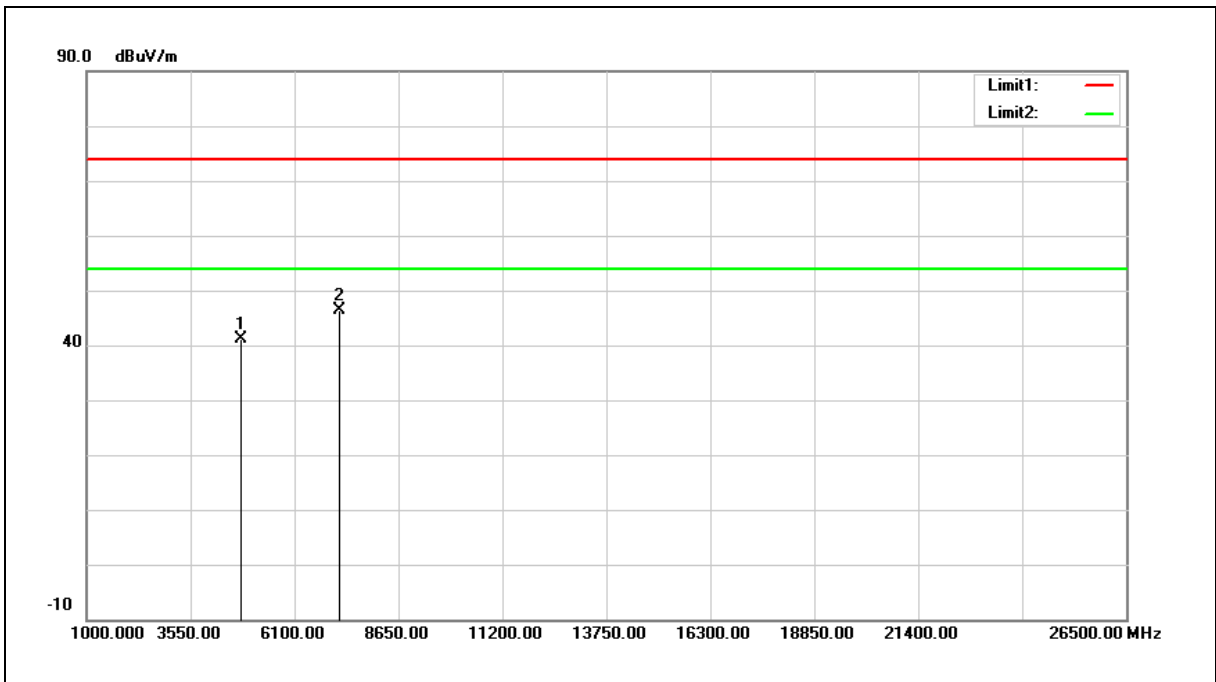

No.	Frequency (MHz)	Reading (dBuV)	Correct Factor (dB/m)	Result (dBuV/m)	Limit (dBuV/m)	Margin (dB)	Remark
1	4804.000	35.35	5.83	41.18	74.00	-32.82	peak
2	7206.000	34.00	12.32	46.32	74.00	-27.68	peak

Note: 1.Result (dBuV/m) = Correct Factor (dB/m) + Reading(dBuV).

Example: 41.18 = 5.83 + 35.35.

2.Correction factor (dB/m) = Antenna Factor (dB/m) + Cable loss (dB) – Pre-Amplifier gain (dB).

3.When the peak results are less than average limit, so not need to evaluate the average.



Standard:	FCC Part 15.247	Test Distance:	3 m
Test item:	Harmonic	Power:	DC 3.3 V
Frequency:	2402 MHz	Temp.(°C)/Hum.(%RH):	26(°C)/60 %RH
Mode:	Mode 2		
Ant.Polar.:	Vertical		

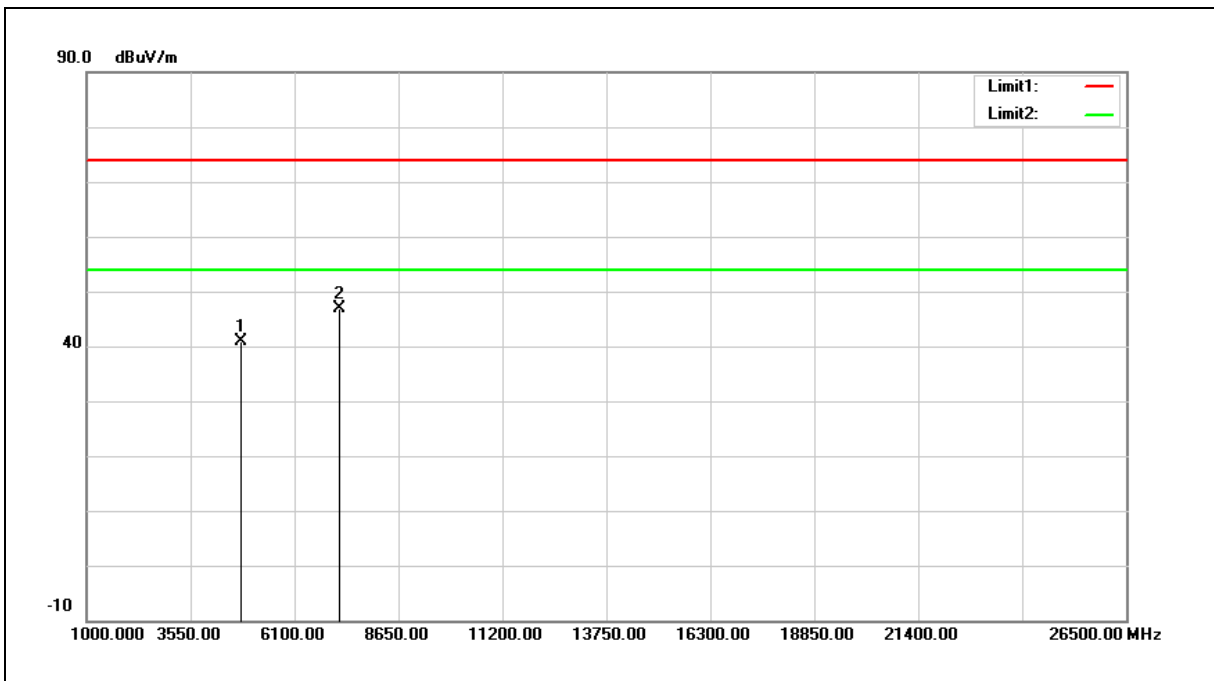

No.	Frequency (MHz)	Reading (dBuV)	Correct Factor (dB/m)	Result (dBuV/m)	Limit (dBuV/m)	Margin (dB)	Remark
1	4804.000	35.17	5.83	41.00	74.00	-33.00	peak
2	7206.000	34.49	12.32	46.81	74.00	-27.19	peak

Note: 1. Result (dBuV/m) = Correct Factor (dB/m) + Reading(dBuV).

Example: 41.00 = 5.83 + 35.17.

2. Correction factor (dB/m) = Antenna Factor (dB/m) + Cable loss (dB) – Pre-Amplifier gain (dB).

3. When the peak results are less than average limit, so not need to evaluate the average.



Standard:	FCC Part 15.247	Test Distance:	3 m
Test item:	Harmonic	Power:	DC 3.3 V
Frequency:	2441 MHz	Temp.(°C)/Hum.(%RH):	26(°C)/60 %RH
Mode:	Mode 2		
Ant.Polar.:	Horizontal		

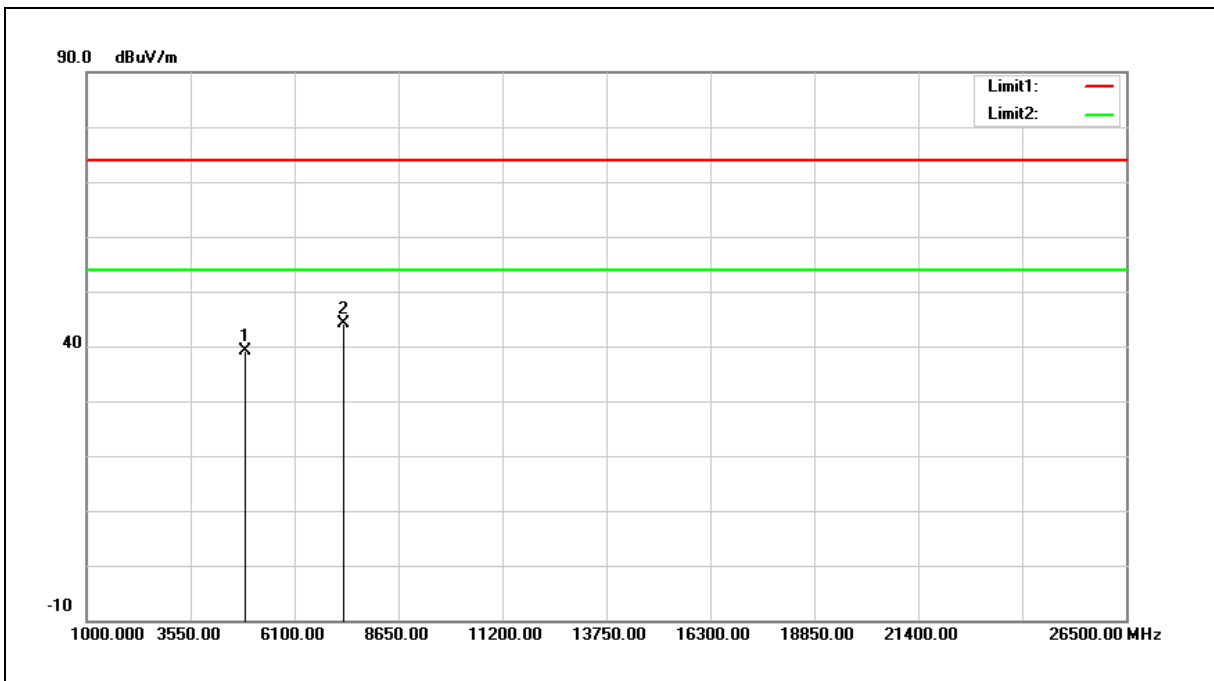

No.	Frequency (MHz)	Reading (dBuV)	Correct Factor (dB/m)	Result (dBuV/m)	Limit (dBuV/m)	Margin (dB)	Remark
1	4882.000	33.14	6.05	39.19	74.00	-34.81	peak
2	7323.000	31.43	12.72	44.15	74.00	-29.85	peak

Note: 1.Result (dBuV/m) = Correct Factor (dB/m) + Reading(dBuV).

2.Correction factor (dB/m) = Antenna Factor (dB/m) + Cable loss (dB) – Pre-Amplifier gain (dB).

3.When the peak results are less than average limit, so not need to evaluate the average.



Standard:	FCC Part 15.247	Test Distance:	3 m
Test item:	Harmonic	Power:	DC 3.3 V
Frequency:	2441 MHz	Temp.(°C)/Hum.(%RH):	26(°C)/60 %RH
Mode:	Mode 2		
Ant.Polar.:	Vertical		

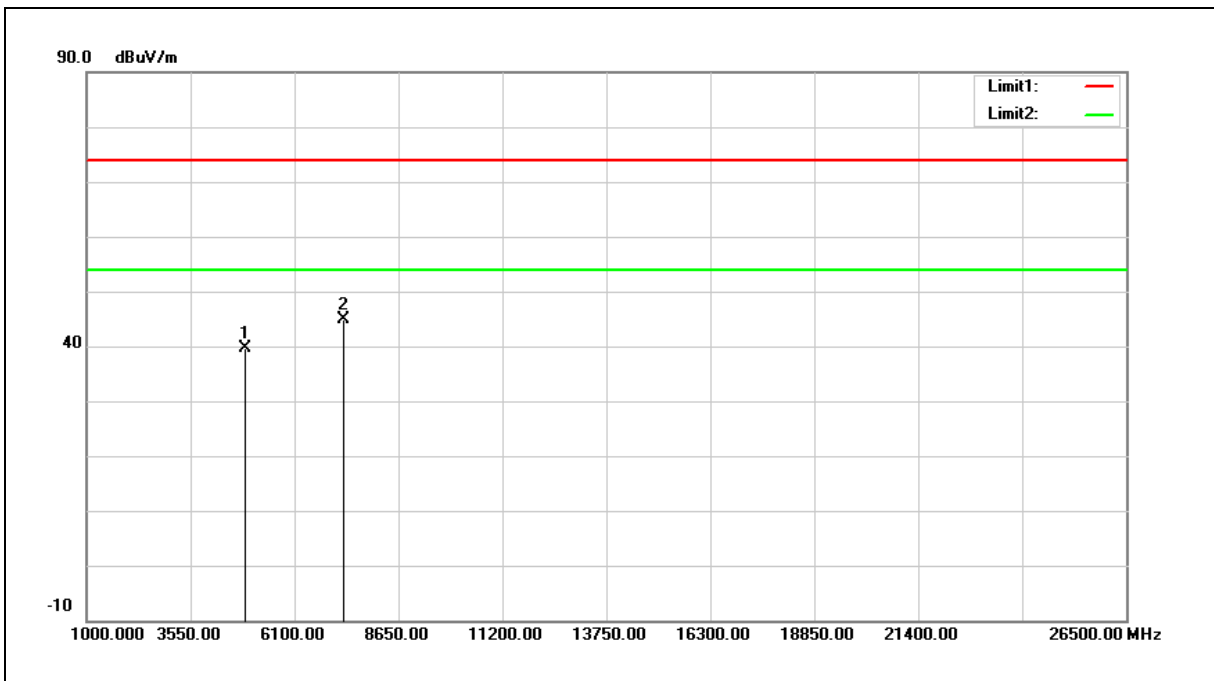

No.	Frequency (MHz)	Reading (dBuV)	Correct Factor (dB/m)	Result (dBuV/m)	Limit (dBuV/m)	Margin (dB)	Remark
1	4882.000	33.64	6.05	39.69	74.00	-34.31	peak
2	7323.000	32.28	12.72	45.00	74.00	-29.00	peak

Note: 1. Result (dBuV/m) = Correct Factor (dB/m) + Reading(dBuV).

2. Correction factor (dB/m) = Antenna Factor (dB/m) + Cable loss (dB) – Pre-Amplifier gain (dB).

3. When the peak results are less than average limit, so not need to evaluate the average.



Standard:	FCC Part 15.247	Test Distance:	3 m
Test item:	Harmonic	Power:	DC 3.3 V
Frequency:	2480 MHz	Temp.(°C)/Hum.(%RH):	26(°C)/60 %RH
Mode:	Mode 2		
Ant.Polar.:	Horizontal		

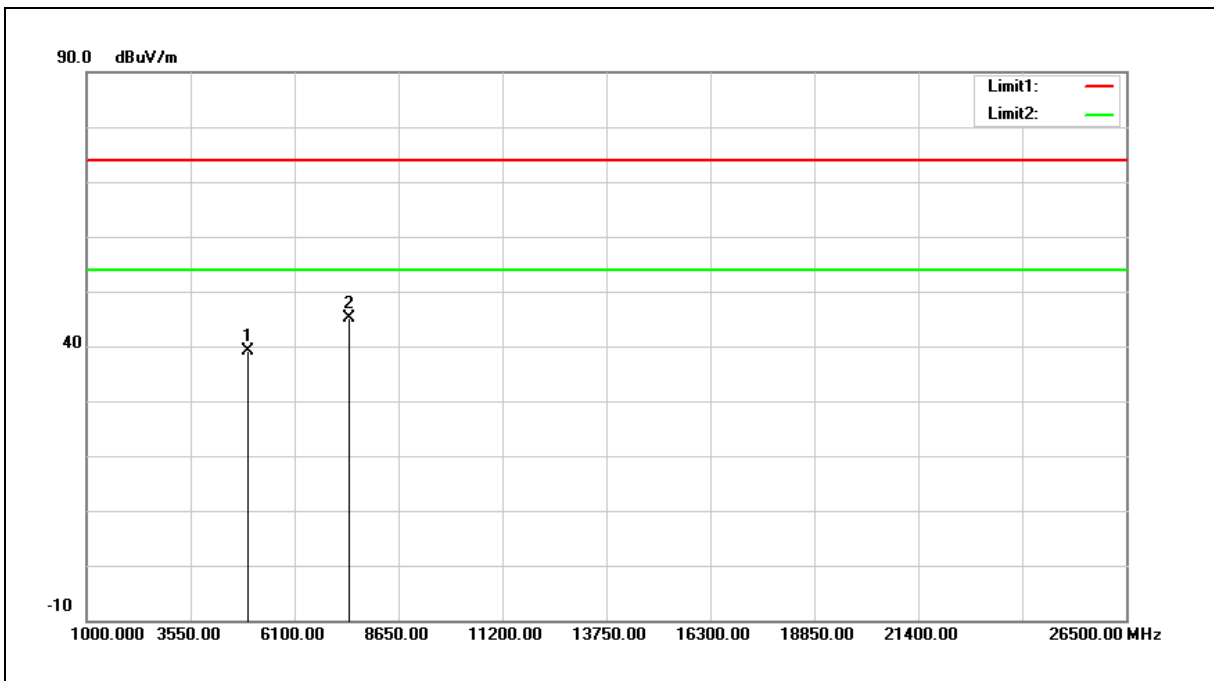

No.	Frequency (MHz)	Reading (dBuV)	Correct Factor (dB/m)	Result (dBuV/m)	Limit (dBuV/m)	Margin (dB)	Remark
1	4960.000	32.96	6.28	39.24	74.00	-34.76	peak
2	7440.000	31.97	13.13	45.10	74.00	-28.90	peak

- Note: 1.Result (dBuV/m) = Correct Factor (dB/m) + Reading(dBuV).
 2.Correction factor (dB/m) = Antenna Factor (dB/m) + Cable loss (dB) – Pre-Amplifier gain (dB).
 3.When the peak results are less than average limit, so not need to evaluate the average.



Standard:	FCC Part 15.247	Test Distance:	3 m
Test item:	Harmonic	Power:	DC 3.3 V
Frequency:	2480 MHz	Temp.(°C)/Hum.(%RH):	26(°C)/60 %RH
Mode:	Mode 2		
Ant.Polar.:	Vertical		

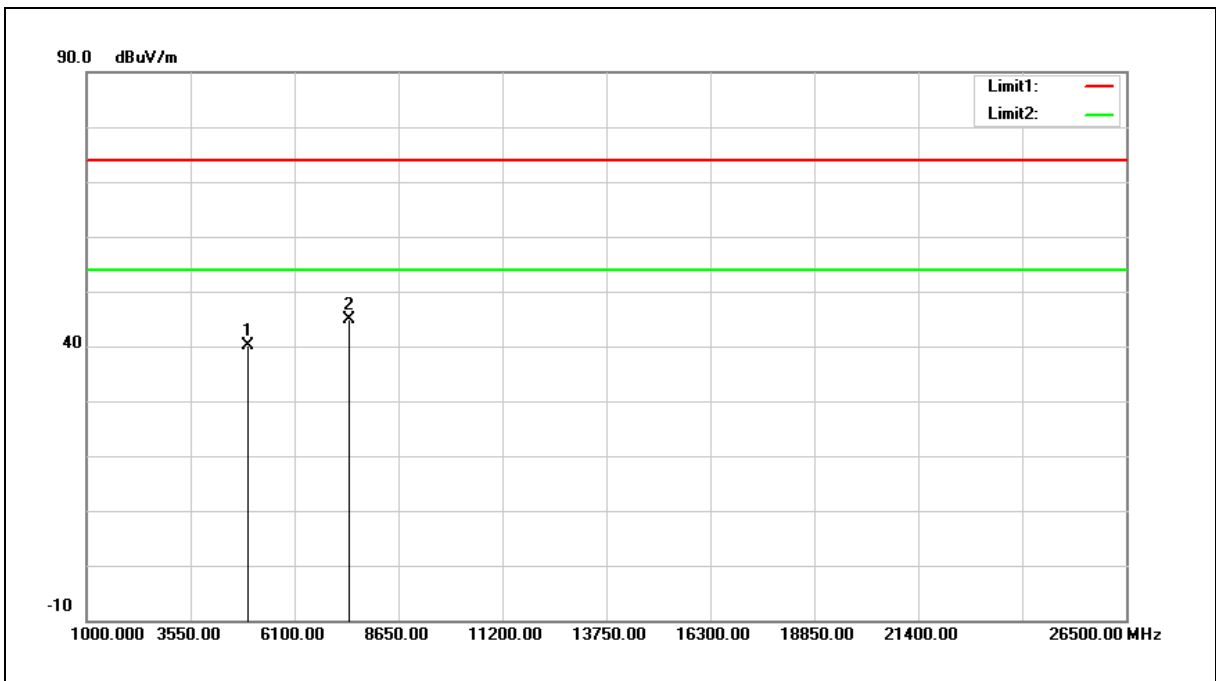

No.	Frequency (MHz)	Reading (dBuV)	Correct Factor (dB/m)	Result (dBuV/m)	Limit (dBuV/m)	Margin (dB)	Remark
1	4960.000	33.94	6.28	40.22	74.00	-33.78	peak
2	7440.000	31.80	13.13	44.93	74.00	-29.07	peak

Note: 1. Result (dBuV/m) = Correct Factor (dB/m) + Reading(dBuV).

2. Correction factor (dB/m) = Antenna Factor (dB/m) + Cable loss (dB) – Pre-Amplifier gain (dB).

3. When the peak results are less than average limit, so not need to evaluate the average.



Standard:	FCC Part 15.247	Test Distance:	3 m
Test item:	Harmonic	Power:	DC 3.3 V
Frequency:	2402 MHz	Temp.(°C)/Hum.(%RH):	26(°C)/60 %RH
Mode:	Mode 4		
Ant.Polar.:	Horizontal		

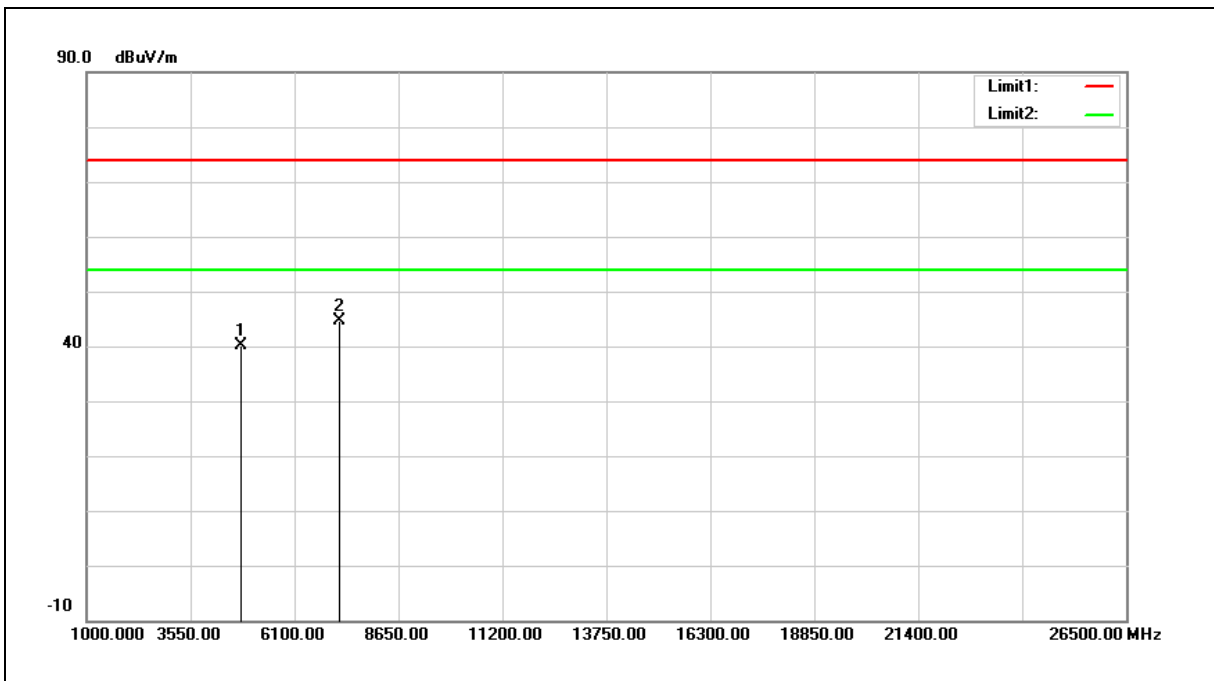

No.	Frequency (MHz)	Reading (dBuV)	Correct Factor (dB/m)	Result (dBuV/m)	Limit (dBuV/m)	Margin (dB)	Remark
1	4804.000	34.20	5.83	40.03	74.00	-33.97	peak
2	7206.000	32.19	12.32	44.51	74.00	-29.49	peak

Note: 1.Result (dBuV/m) = Correct Factor (dB/m) + Reading(dBuV).

2.Correction factor (dB/m) = Antenna Factor (dB/m) + Cable loss (dB) – Pre-Amplifier gain (dB).

3.When the peak results are less than average limit, so not need to evaluate the average.



Standard:	FCC Part 15.247	Test Distance:	3 m
Test item:	Harmonic	Power:	DC 3.3 V
Frequency:	2402 MHz	Temp.(°C)/Hum.(%RH):	26(°C)/60 %RH
Mode:	Mode 4		
Ant.Polar.:	Vertical		

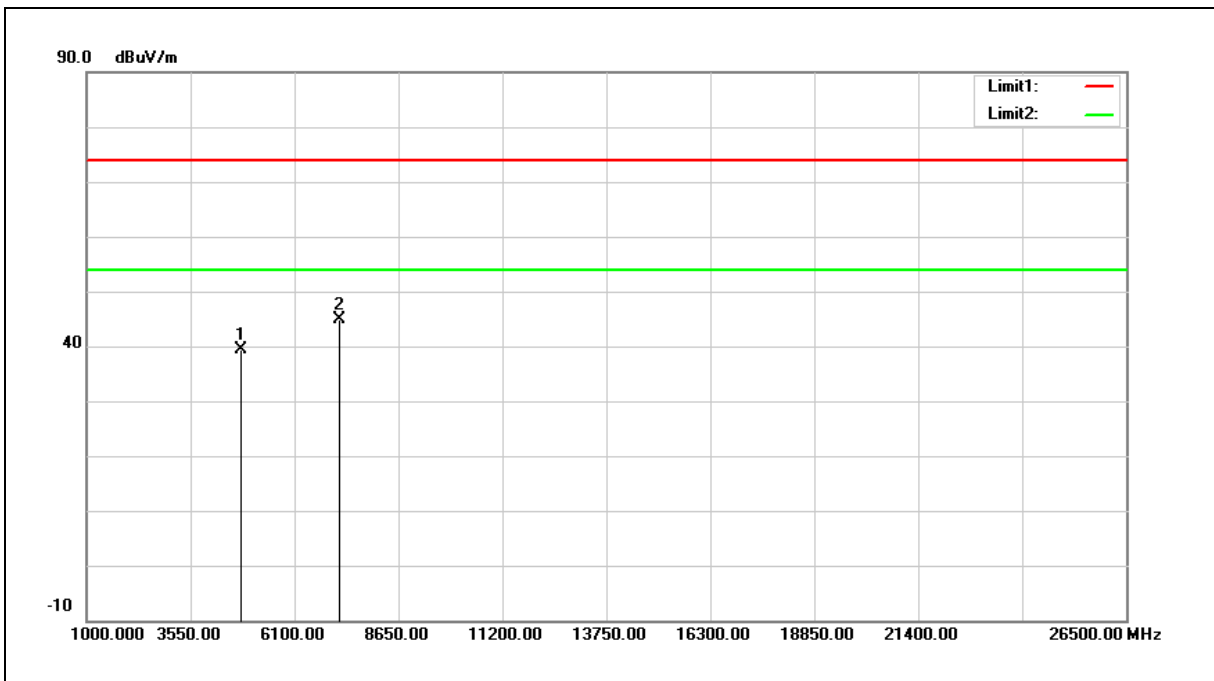

No.	Frequency (MHz)	Reading (dBuV)	Correct Factor (dB/m)	Result (dBuV/m)	Limit (dBuV/m)	Margin (dB)	Remark
1	4804.000	33.45	5.83	39.28	74.00	-34.72	peak
2	7206.000	32.64	12.32	44.96	74.00	-29.04	peak

- Note: 1.Result (dBuV/m) = Correct Factor (dB/m) + Reading(dBuV).
 2.Correction factor (dB/m) = Antenna Factor (dB/m) + Cable loss (dB) – Pre-Amplifier gain (dB).
 3.When the peak results are less than average limit, so not need to evaluate the average.



Standard:	FCC Part 15.247	Test Distance:	3 m
Test item:	Harmonic	Power:	DC 3.3 V
Frequency:	2441 MHz	Temp.(°C)/Hum.(%RH):	26(°C)/60 %RH
Mode:	Mode 4		
Ant.Polar.:	Horizontal		

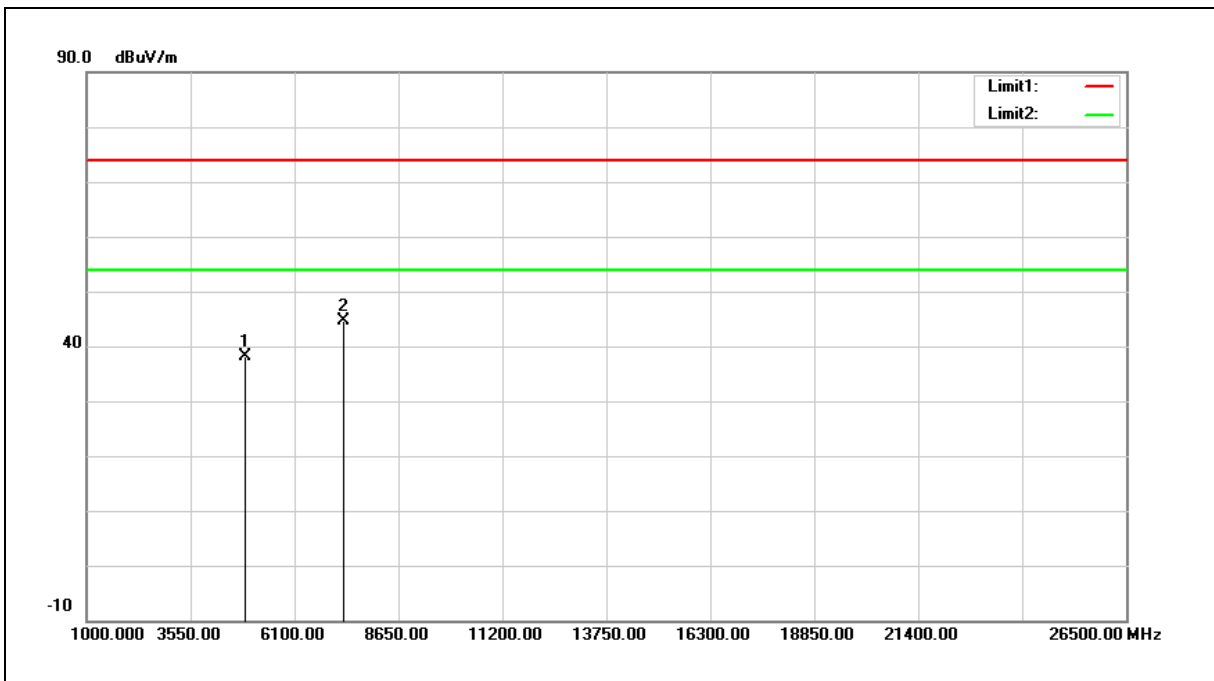

No.	Frequency (MHz)	Reading (dBuV)	Correct Factor (dB/m)	Result (dBuV/m)	Limit (dBuV/m)	Margin (dB)	Remark
1	4882.000	32.15	6.05	38.20	74.00	-35.80	peak
2	7323.000	31.81	12.72	44.53	74.00	-29.47	peak

- Note: 1.Result (dBuV/m) = Correct Factor (dB/m) + Reading(dBuV).
 2.Correction factor (dB/m) = Antenna Factor (dB/m) + Cable loss (dB) – Pre-Amplifier gain (dB).
 3.When the peak results are less than average limit, so not need to evaluate the average.



Standard:	FCC Part 15.247	Test Distance:	3 m
Test item:	Harmonic	Power:	DC 3.3 V
Frequency:	2441 MHz	Temp.(°C)/Hum.(%RH):	26(°C)/60 %RH
Mode:	Mode 4		
Ant.Polar.:	Vertical		

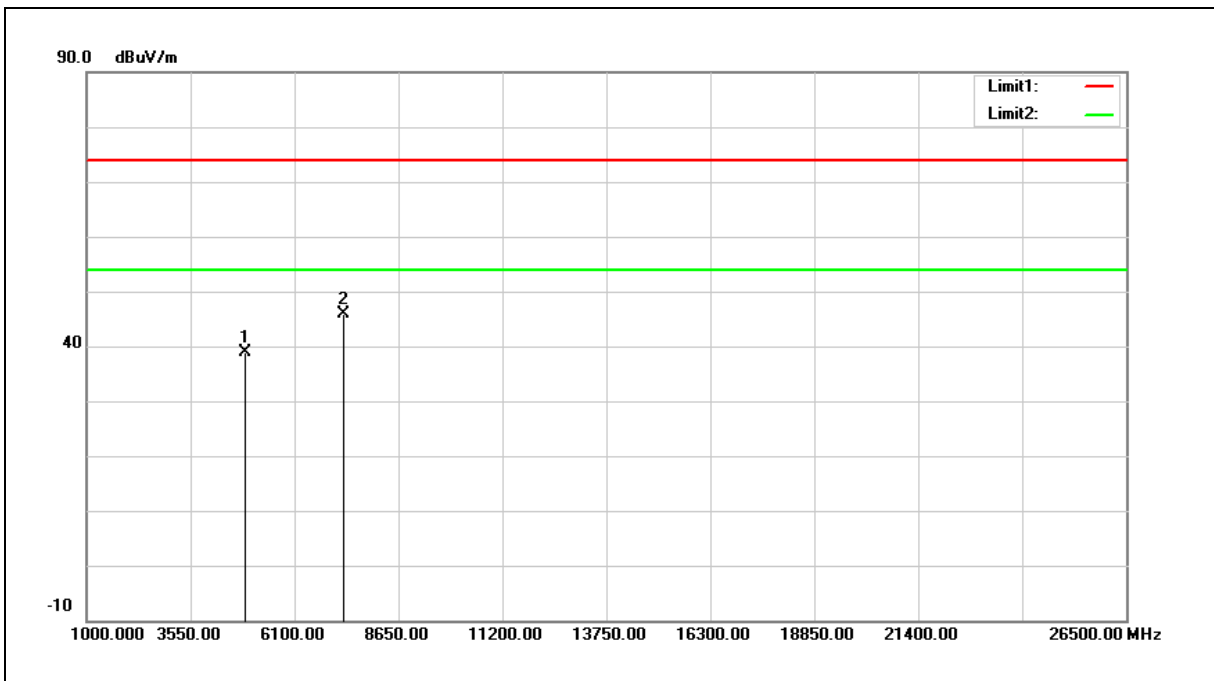

No.	Frequency (MHz)	Reading (dBuV)	Correct Factor (dB/m)	Result (dBuV/m)	Limit (dBuV/m)	Margin (dB)	Remark
1	4882.000	32.73	6.05	38.78	74.00	-35.22	peak
2	7323.000	33.19	12.72	45.91	74.00	-28.09	peak

- Note: 1.Result (dBuV/m) = Correct Factor (dB/m) + Reading(dBuV).
 2.Correction factor (dB/m) = Antenna Factor (dB/m) + Cable loss (dB) – Pre-Amplifier gain (dB).
 3.When the peak results are less than average limit, so not need to evaluate the average.



Standard:	FCC Part 15.247	Test Distance:	3 m
Test item:	Harmonic	Power:	DC 3.3 V
Frequency:	2480 MHz	Temp.(°C)/Hum.(%RH):	26(°C)/60 %RH
Mode:	Mode 4		
Ant.Polar.:	Horizontal		

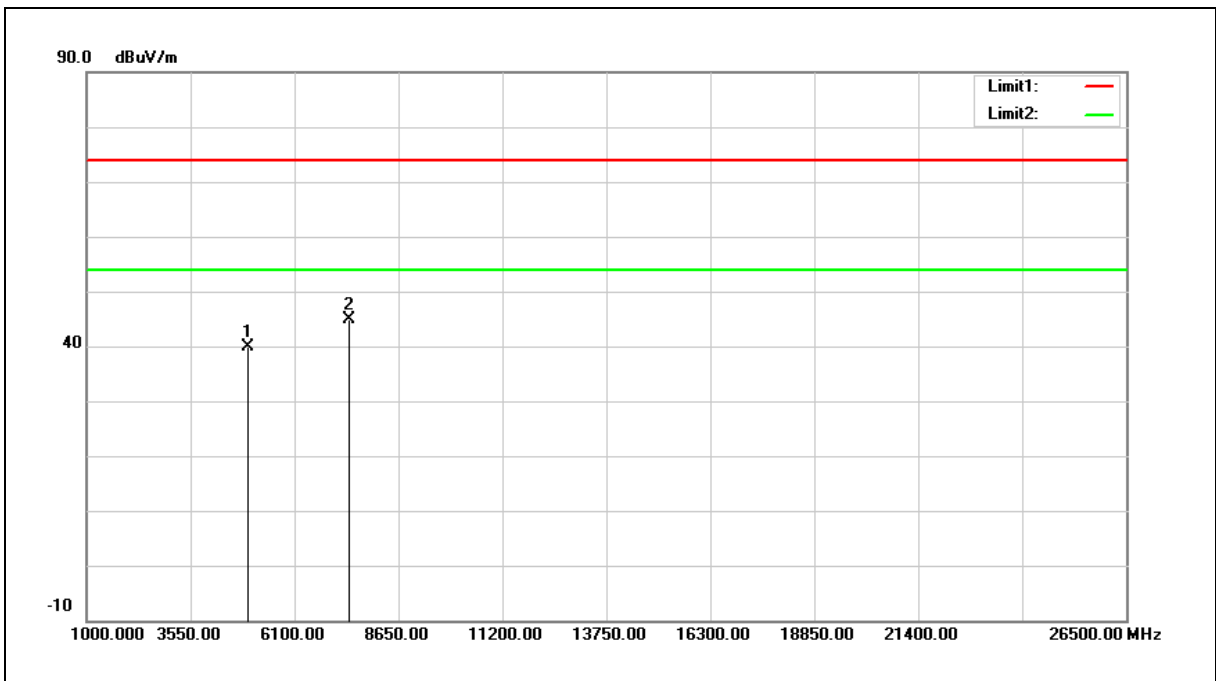

No.	Frequency (MHz)	Reading (dBuV)	Correct Factor (dB/m)	Result (dBuV/m)	Limit (dBuV/m)	Margin (dB)	Remark
1	4960.000	33.68	6.28	39.96	74.00	-34.04	peak
2	7440.000	31.83	13.13	44.96	74.00	-29.04	peak

- Note: 1.Result (dBuV/m) = Correct Factor (dB/m) + Reading(dBuV).
 2.Correction factor (dB/m) = Antenna Factor (dB/m) + Cable loss (dB) – Pre-Amplifier gain (dB).
 3.When the peak results are less than average limit, so not need to evaluate the average.



Standard:	FCC Part 15.247	Test Distance:	3 m
Test item:	Harmonic	Power:	DC 3.3 V
Frequency:	2480 MHz	Temp.(°C)/Hum.(%RH):	26(°C)/60 %RH
Mode:	Mode 4		
Ant.Polar.:	Vertical		

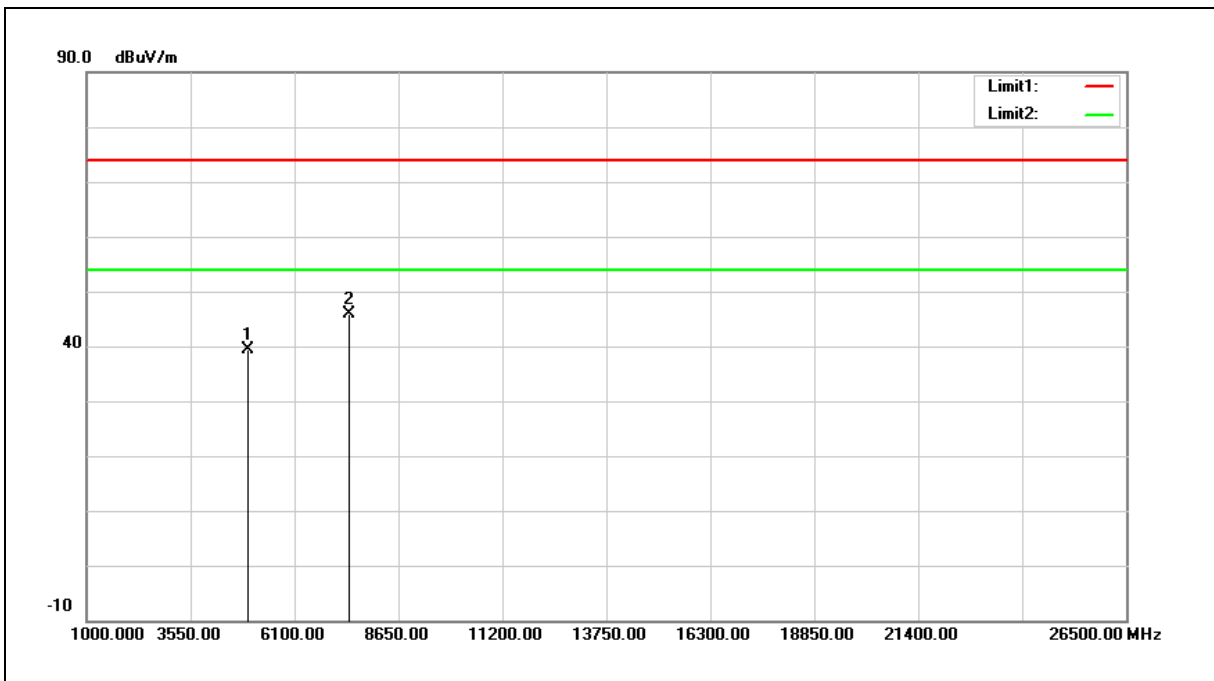

No.	Frequency (MHz)	Reading (dBuV)	Correct Factor (dB/m)	Result (dBuV/m)	Limit (dBuV/m)	Margin (dB)	Remark
1	4960.000	33.04	6.28	39.32	74.00	-34.68	peak
2	7440.000	32.83	13.13	45.96	74.00	-28.04	peak

Note: 1. Result (dBuV/m) = Correct Factor (dB/m) + Reading(dBuV).

2. Correction factor (dB/m) = Antenna Factor (dB/m) + Cable loss (dB) – Pre-Amplifier gain (dB).

3. When the peak results are less than average limit, so not need to evaluate the average.

Band Edge

Standard:	FCC Part 15.247	Test Distance:	3 m
Test item:	Band edge	Power:	DC 3.3 V
Frequency:	2402 MHz	Temp.(°C)/Hum.(%RH):	26(°C)/60 %RH
Mode:	Mode 2		
Ant.Polar.:	Horizontal		

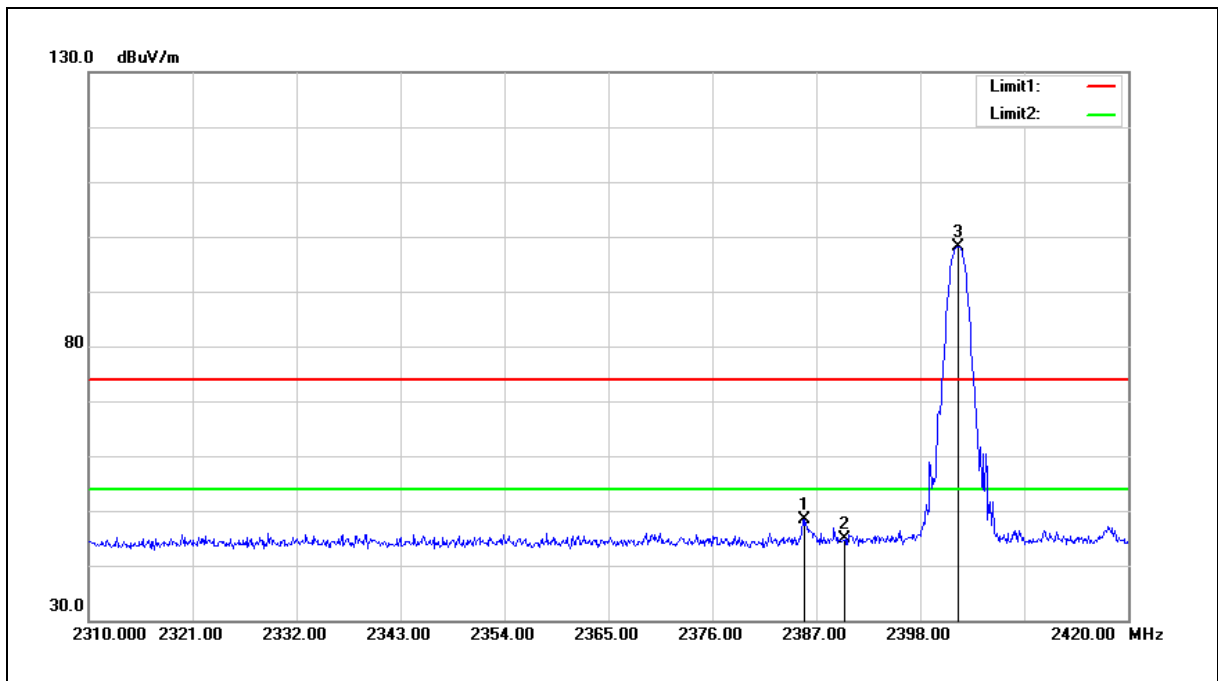

No.	Frequency (MHz)	Reading (dBuV)	Correct Factor (dB/m)	Result (dBuV/m)	Limit (dBuV/m)	Margin (dB)	Remark
1	2385.680	49.27	-0.85	48.42	74.00	-25.58	peak
2	2390.000	45.60	-0.82	44.78	74.00	-29.22	peak
3	2401.960	98.95	-0.76	98.19	--	--	peak

Note:1.Result (dBuV/m) = Correct Factor (dB/m) + Reading(dBuV).

2.Correction factor (dB/m) = Antenna Factor (dB/m) + Cable loss (dB) – Pre-Amplifier gain (dB).

3.When the peak results are less than average limit, so not need to evaluate the average.



Standard:	FCC Part 15.247	Test Distance:	3 m
Test item:	Band edge	Power:	DC 3.3 V
Frequency:	2402 MHz	Temp.(°C)/Hum.(%RH):	26(°C)/60 %RH
Mode:	Mode 2		
Ant.Polar.:	Vertical		

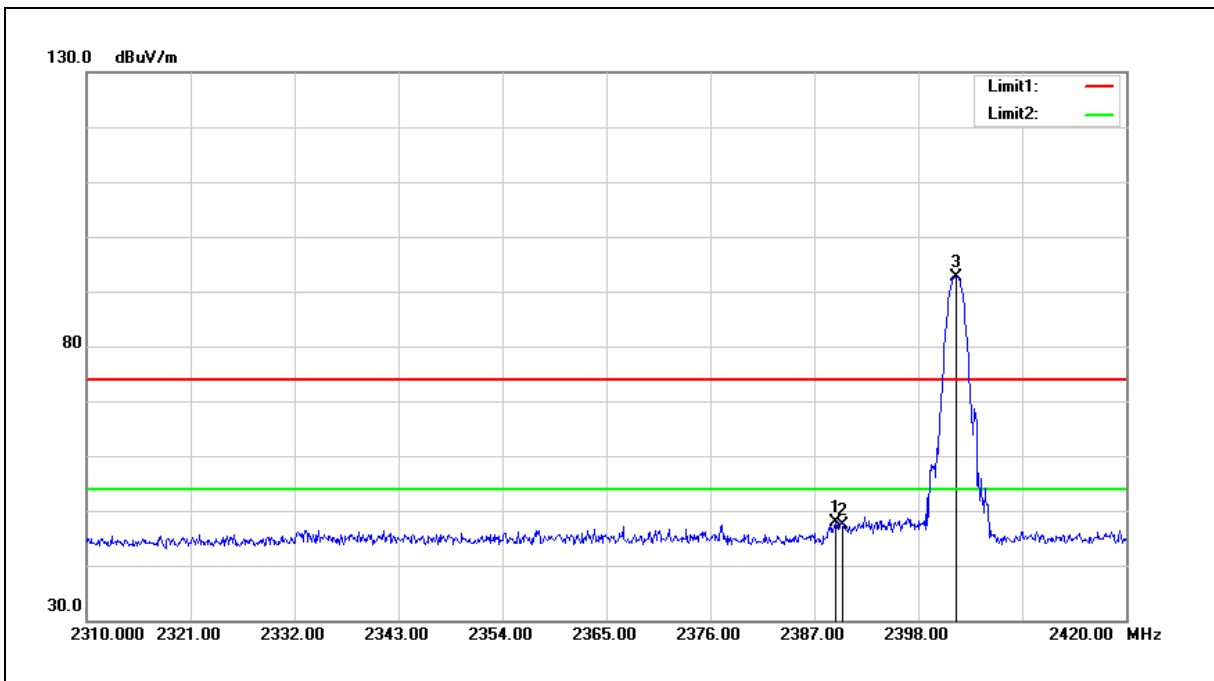

No.	Frequency (MHz)	Reading (dBuV)	Correct Factor (dB/m)	Result (dBuV/m)	Limit (dBuV/m)	Margin (dB)	Remark
1	2389.310	48.63	-0.83	47.80	74.00	-26.20	peak
2	2390.000	48.20	-0.82	47.38	74.00	-26.62	peak
3	2402.070	93.35	-0.76	92.59	--	--	peak

Note:1.Result (dBuV/m) = Correct Factor (dB/m) + Reading(dBuV).

2.Correction factor (dB/m) = Antenna Factor (dB/m) + Cable loss (dB) – Pre-Amplifier gain (dB).

3.When the peak results are less than average limit, so not need to evaluate the average.



Standard:	FCC Part 15.247	Test Distance:	3 m
Test item:	Band edge	Power:	DC 3.3 V
Frequency:	2480 MHz	Temp.(°C)/Hum.(%RH):	26(°C)/60 %RH
Mode:	Mode 2		
Ant.Polar.:	Horizontal		

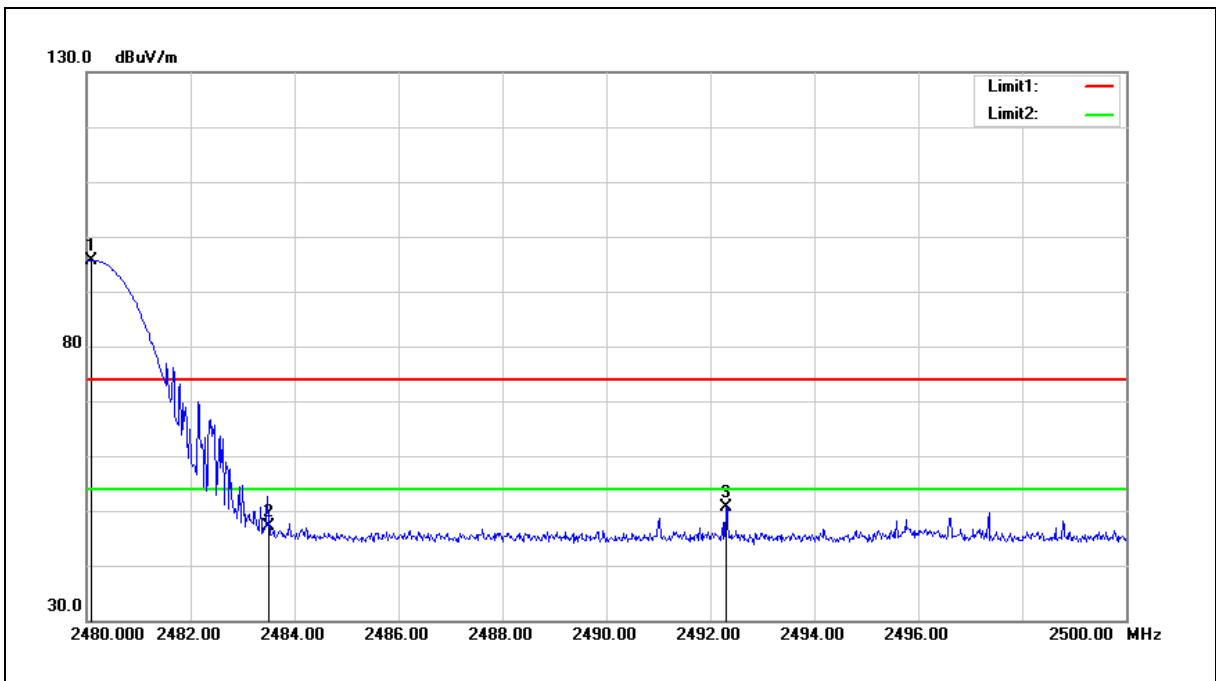

No.	Frequency (MHz)	Reading (dBuV)	Correct Factor (dB/m)	Result (dBuV/m)	Limit (dBuV/m)	Margin (dB)	Remark
1	2480.100	96.10	-0.37	95.73	--	--	peak
2	2483.500	47.40	-0.35	47.05	74.00	-26.95	peak
3	2492.300	51.04	-0.30	50.74	74.00	-23.26	peak

Note:1.Result (dBuV/m) = Correct Factor (dB/m) + Reading(dBuV).

2.Correction factor (dB/m) = Antenna Factor (dB/m) + Cable loss (dB) – Pre-Amplifier gain (dB).

3.When the peak results are less than average limit, so not need to evaluate the average.



Standard:	FCC Part 15.247	Test Distance:	3 m
Test item:	Band edge	Power:	DC 3.3 V
Frequency:	2480 MHz	Temp.(°C)/Hum.(%RH):	26(°C)/60 %RH
Mode:	Mode 2		
Ant.Polar.:	Vertical		

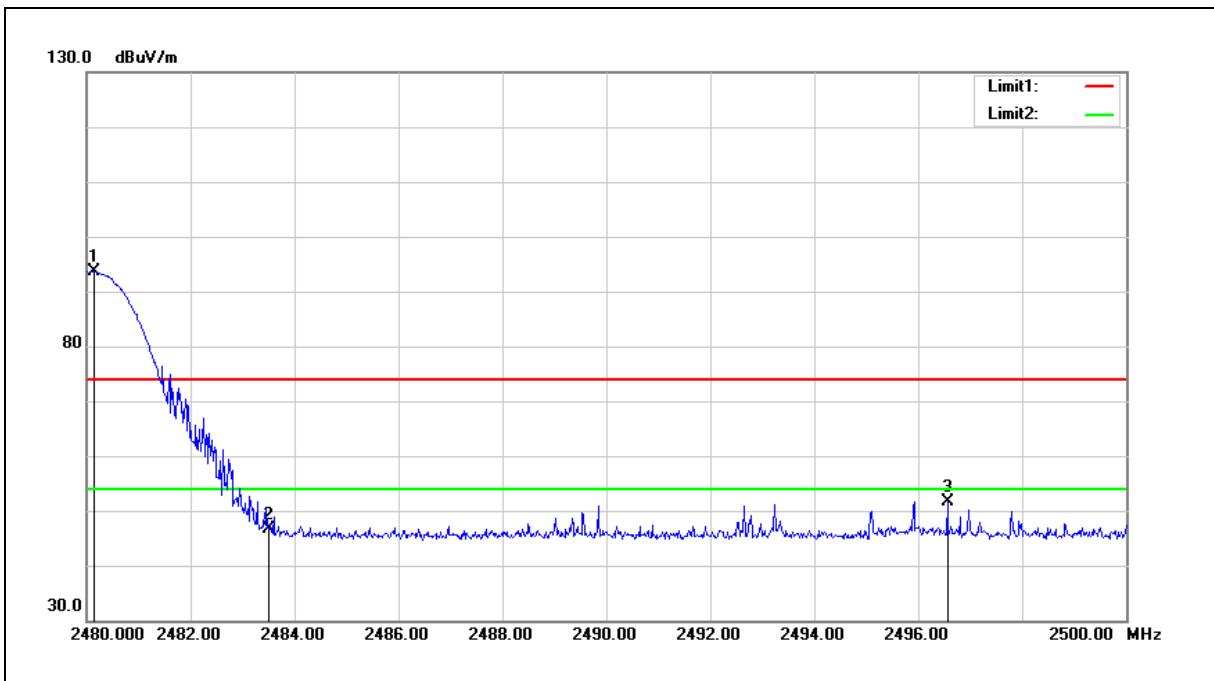

No.	Frequency (MHz)	Reading (dBuV)	Correct Factor (dB/m)	Result (dBuV/m)	Limit (dBuV/m)	Margin (dB)	Remark
1	2480.140	94.03	-0.36	93.67	--	--	peak
2	2483.500	46.92	-0.35	46.57	74.00	-27.43	peak
3	2496.560	51.98	-0.28	51.70	74.00	-22.30	peak

Note:1.Result (dBuV/m) = Correct Factor (dB/m) + Reading(dBuV).

2.Correction factor (dB/m) = Antenna Factor (dB/m) + Cable loss (dB) – Pre-Amplifier gain (dB).

3.When the peak results are less than average limit, so not need to evaluate the average.



Standard:	FCC Part 15.247	Test Distance:	3 m
Test item:	Band edge	Power:	DC 3.3 V
Frequency:	Hopping	Temp.(°C)/Hum.(%RH):	26(°C)/60 %RH
Test Mode:	Mode 2		
Ant.Polar.:	Horizontal		

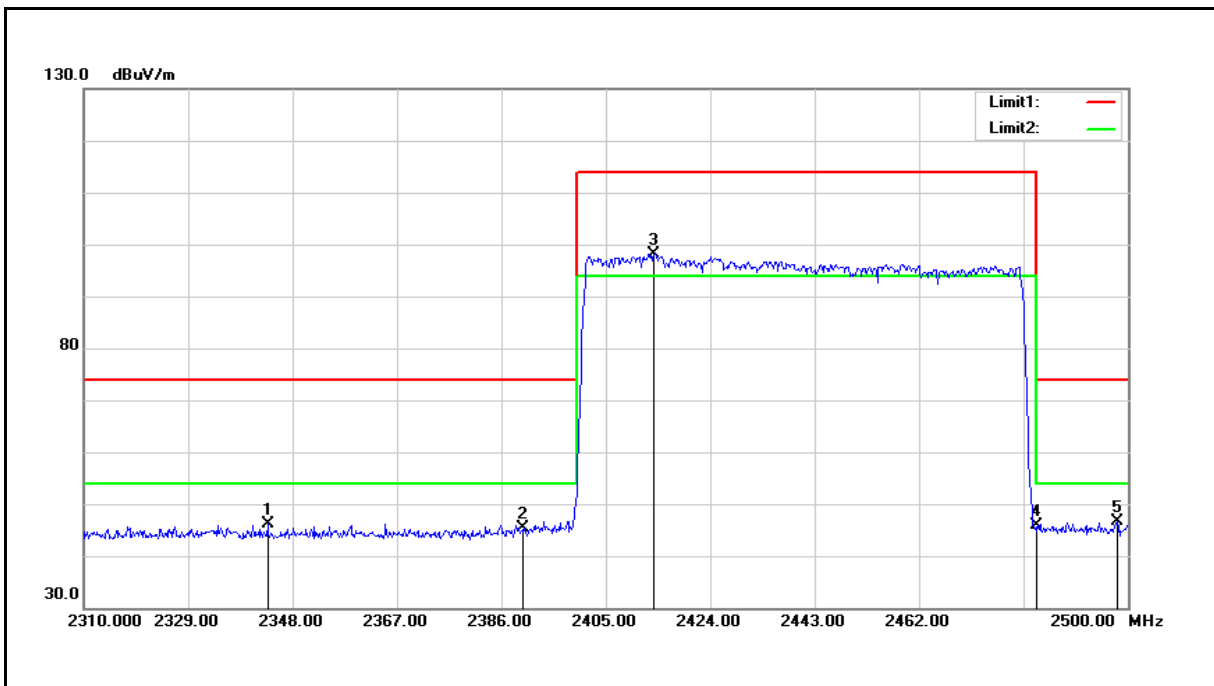

No.	Frequency (MHz)	Reading (dBuV)	Correct Factor (dB/m)	Result (dBuV/m)	Limit (dBuV/m)	Margin (dB)	Remark
1	2343.440	47.24	-1.06	46.18	74.00	-27.82	peak
2	2390.000	46.24	-0.82	45.42	74.00	-28.58	peak
3	2413.740	98.92	-0.70	98.22	--	--	peak
4	2483.500	46.26	-0.35	45.91	74.00	-28.09	peak
5	2498.100	47.00	-0.27	46.73	74.00	-27.27	peak

Note:1.Result (dBuV/m) = Correct Factor (dB/m) + Reading(dBuV).

2.Correction factor (dB/m) = Antenna Factor (dB/m) + Cable loss (dB) – Pre-Amplifier gain (dB).

3.When the peak results are less than average limit, so not need to evaluate the average.



Standard:	FCC Part 15.247	Test Distance:	3 m
Test item:	Band edge	Power:	DC 3.3 V
Frequency:	Hopping	Temp.(°C)/Hum.(%RH):	26(°C)/60 %RH
Test Mode:	Mode 2		
Ant.Polar.:	Vertical		

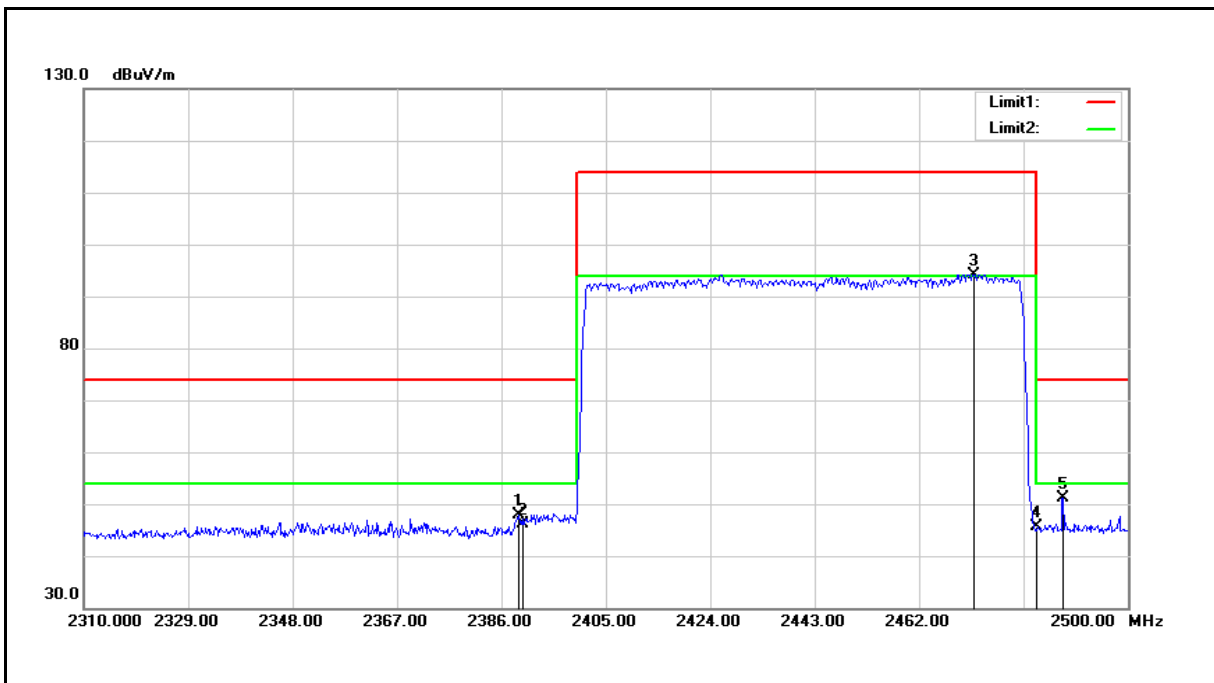

No.	Frequency (MHz)	Reading (dBuV)	Correct Factor (dB/m)	Result (dBuV/m)	Limit (dBuV/m)	Margin (dB)	Remark
1	2389.040	48.65	-0.84	47.81	74.00	-26.19	peak
2	2390.000	46.95	-0.82	46.13	74.00	-27.87	peak
3	2472.070	94.64	-0.40	94.24	--	--	peak
4	2483.500	45.95	-0.35	45.60	74.00	-28.40	peak
5	2488.220	51.53	-0.32	51.21	74.00	-22.79	peak

Note:1.Result (dBuV/m) = Correct Factor (dB/m) + Reading(dBuV).

2.Correction factor (dB/m) = Antenna Factor (dB/m) + Cable loss (dB) – Pre-Amplifier gain (dB).

3.When the peak results are less than average limit, so not need to evaluate the average.



Standard:	FCC Part 15.247	Test Distance:	3 m
Test item:	Band edge	Power:	DC 3.3 V
Frequency:	2402 MHz	Temp.(°C)/Hum.(%RH):	26(°C)/60 %RH
Mode:	Mode 4		
Ant.Polar.:	Horizontal		

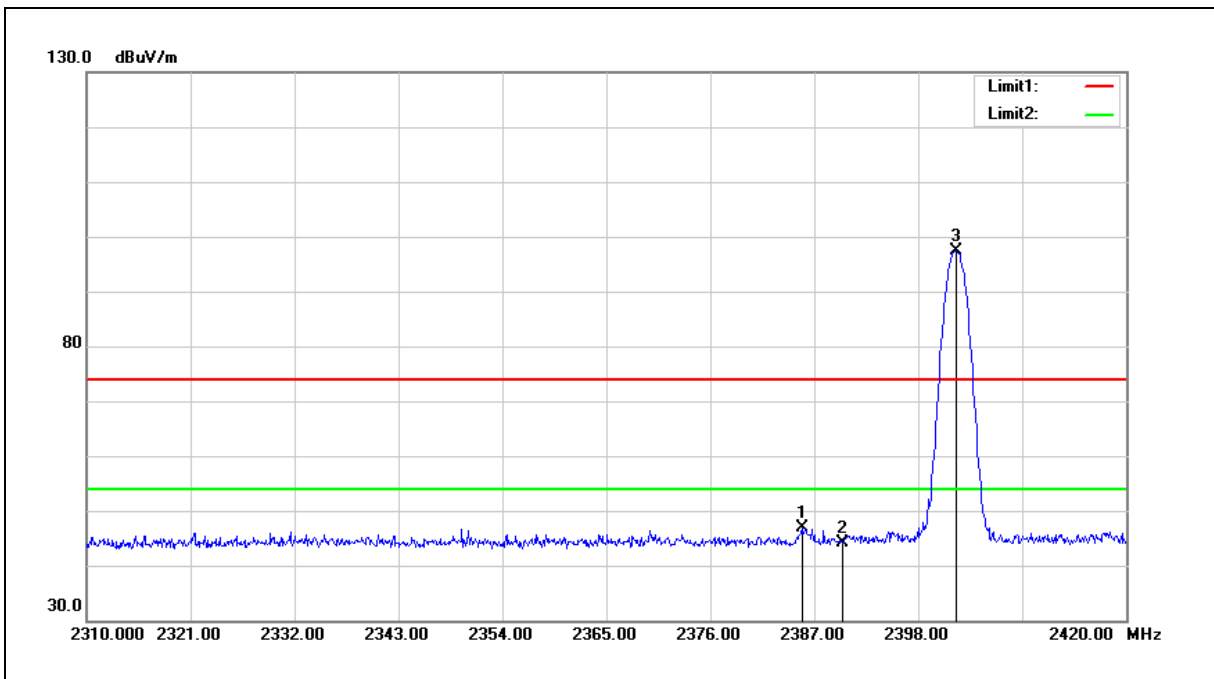

No.	Frequency (MHz)	Reading (dBuV)	Correct Factor (dB/m)	Result (dBuV/m)	Limit (dBuV/m)	Margin (dB)	Remark
1	2385.680	47.78	-0.85	46.93	74.00	-27.07	peak
2	2390.000	45.02	-0.82	44.20	74.00	-29.80	peak
3	2401.960	98.13	-0.76	97.37	--	--	peak

Note:1.Result (dBuV/m) = Correct Factor (dB/m) + Reading(dBuV).

2.Correction factor (dB/m) = Antenna Factor (dB/m) + Cable loss (dB) – Pre-Amplifier gain (dB).

3.When the peak results are less than average limit, so not need to evaluate the average.



Standard:	FCC Part 15.247	Test Distance:	3 m
Test item:	Band edge	Power:	DC 3.3 V
Frequency:	2402 MHz	Temp.(°C)/Hum.(%RH):	26(°C)/60 %RH
Mode:	Mode 4		
Ant.Polar.:	Vertical		

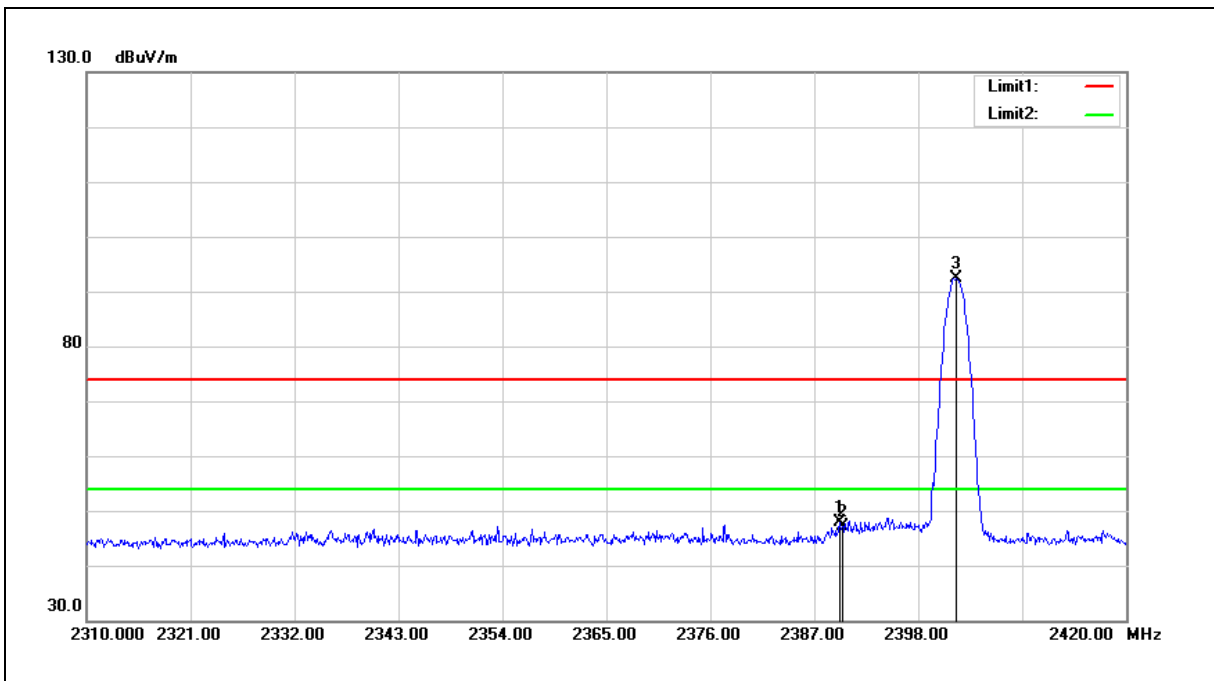

No.	Frequency (MHz)	Reading (dBuV)	Correct Factor (dB/m)	Result (dBuV/m)	Limit (dBuV/m)	Margin (dB)	Remark
1	2389.640	48.80	-0.83	47.97	74.00	-26.03	peak
2	2390.000	48.00	-0.82	47.18	74.00	-26.82	peak
3	2402.070	93.25	-0.76	92.49	--	--	peak

Note:1.Result (dBuV/m) = Correct Factor (dB/m) + Reading(dBuV).

2.Correction factor (dB/m) = Antenna Factor (dB/m) + Cable loss (dB) – Pre-Amplifier gain (dB).

3.When the peak results are less than average limit, so not need to evaluate the average.



Standard:	FCC Part 15.247	Test Distance:	3 m
Test item:	Band edge	Power:	DC 3.3 V
Frequency:	2480 MHz	Temp.(°C)/Hum.(%RH):	26(°C)/60 %RH
Mode:	Mode 4		
Ant.Polar.:	Horizontal		

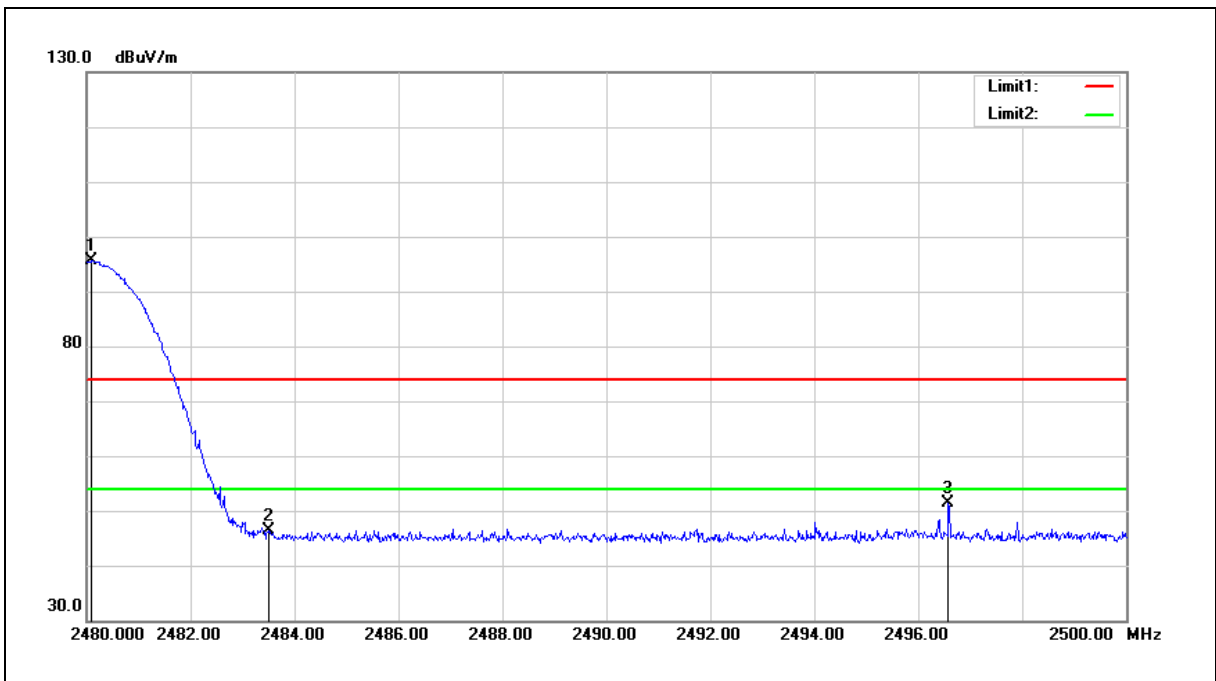

No.	Frequency (MHz)	Reading (dBuV)	Correct Factor (dB/m)	Result (dBuV/m)	Limit (dBuV/m)	Margin (dB)	Remark
1	2480.100	95.90	-0.37	95.53	--	--	peak
2	2483.500	46.69	-0.35	46.34	74.00	-27.66	peak
3	2496.580	51.61	-0.28	51.33	74.00	-22.67	peak

Note:1.Result (dBuV/m) = Correct Factor (dB/m) + Reading(dBuV).

2.Correction factor (dB/m) = Antenna Factor (dB/m) + Cable loss (dB) – Pre-Amplifier gain (dB).

3.When the peak results are less than average limit, so not need to evaluate the average.



Standard:	FCC Part 15.247	Test Distance:	3 m
Test item:	Band edge	Power:	DC 3.3 V
Frequency:	2480 MHz	Temp.(°C)/Hum.(%RH):	26(°C)/60 %RH
Mode:	Mode 4		
Ant.Polar.:	Vertical		

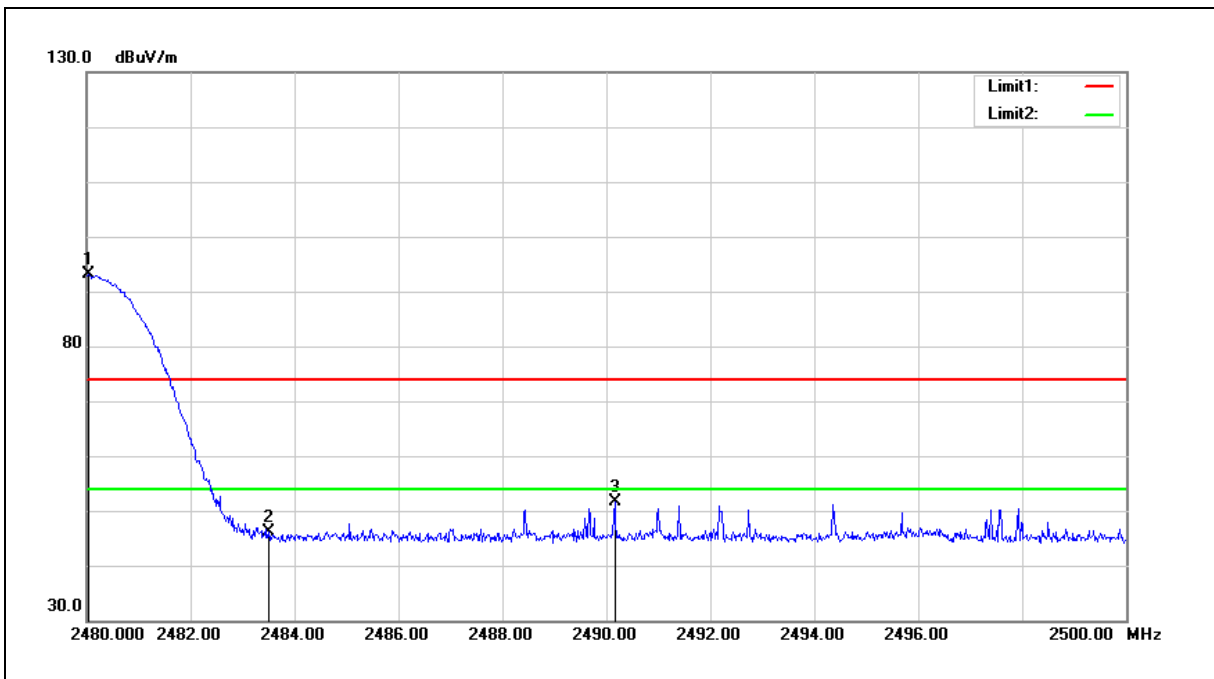

No.	Frequency (MHz)	Reading (dBuV)	Correct Factor (dB/m)	Result (dBuV/m)	Limit (dBuV/m)	Margin (dB)	Remark
1	2480.040	93.53	-0.37	93.16	--	--	peak
2	2483.500	46.47	-0.35	46.12	74.00	-27.88	peak
3	2490.160	52.00	-0.31	51.69	74.00	-22.31	peak

Note:1.Result (dBuV/m) = Correct Factor (dB/m) + Reading(dBuV).

2.Correction factor (dB/m) = Antenna Factor (dB/m) + Cable loss (dB) – Pre-Amplifier gain (dB).

3.When the peak results are less than average limit, so not need to evaluate the average.



Standard:	FCC Part 15.247	Test Distance:	3 m
Test item:	Band edge	Power:	DC 3.3 V
Frequency:	Hopping	Temp.(°C)/Hum.(%RH):	26(°C)/60 %RH
Test Mode:	Mode 4		
Ant.Polar.:	Horizontal		

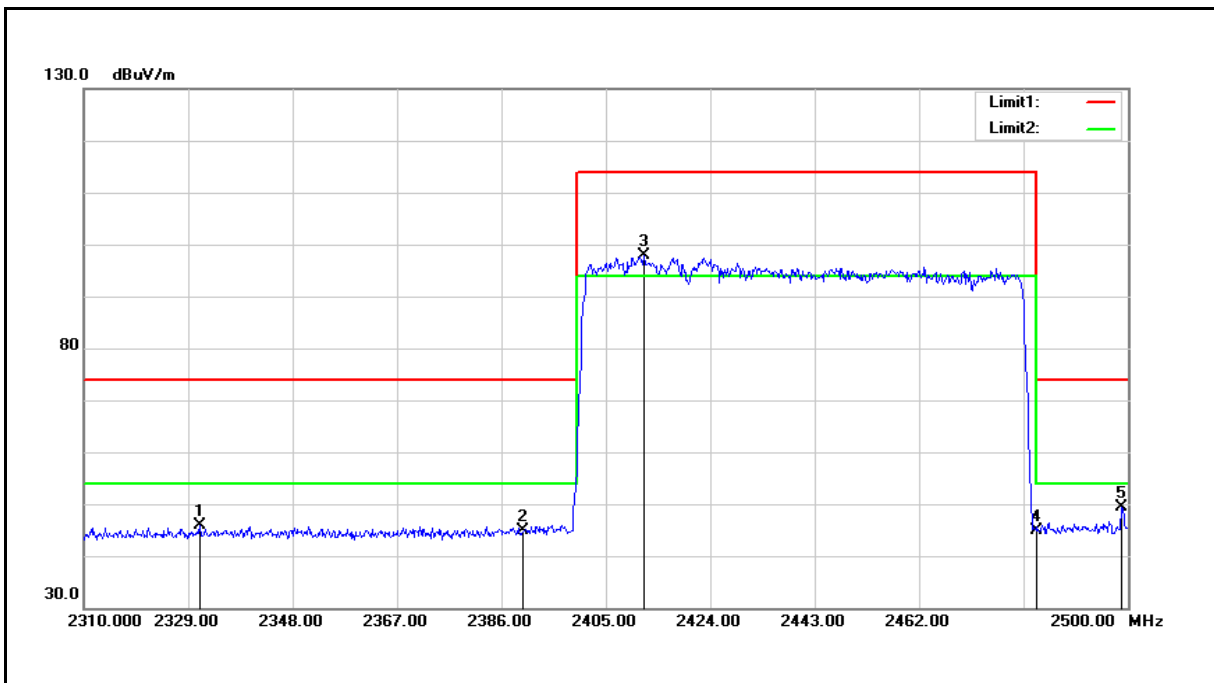

No.	Frequency (MHz)	Reading (dBuV)	Correct Factor (dB/m)	Result (dBuV/m)	Limit (dBuV/m)	Margin (dB)	Remark
1	2331.090	47.07	-1.12	45.95	74.00	-28.05	peak
2	2390.000	45.61	-0.82	44.79	74.00	-29.21	peak
3	2411.840	98.70	-0.72	97.98	--	--	peak
4	2483.500	45.27	-0.35	44.92	74.00	-29.08	peak
5	2498.860	49.53	-0.26	49.27	74.00	-24.73	peak

Note:1.Result (dBuV/m) = Correct Factor (dB/m) + Reading(dBuV).

2.Correction factor (dB/m) = Antenna Factor (dB/m) + Cable loss (dB) – Pre-Amplifier gain (dB).

3.When the peak results are less than average limit, so not need to evaluate the average.



Standard:	FCC Part 15.247	Test Distance:	3 m
Test item:	Band edge	Power:	DC 3.3 V
Frequency:	Hopping	Temp.(°C)/Hum.(%RH):	26(°C)/60 %RH
Test Mode:	Mode 4		
Ant.Polar.:	Vertical		

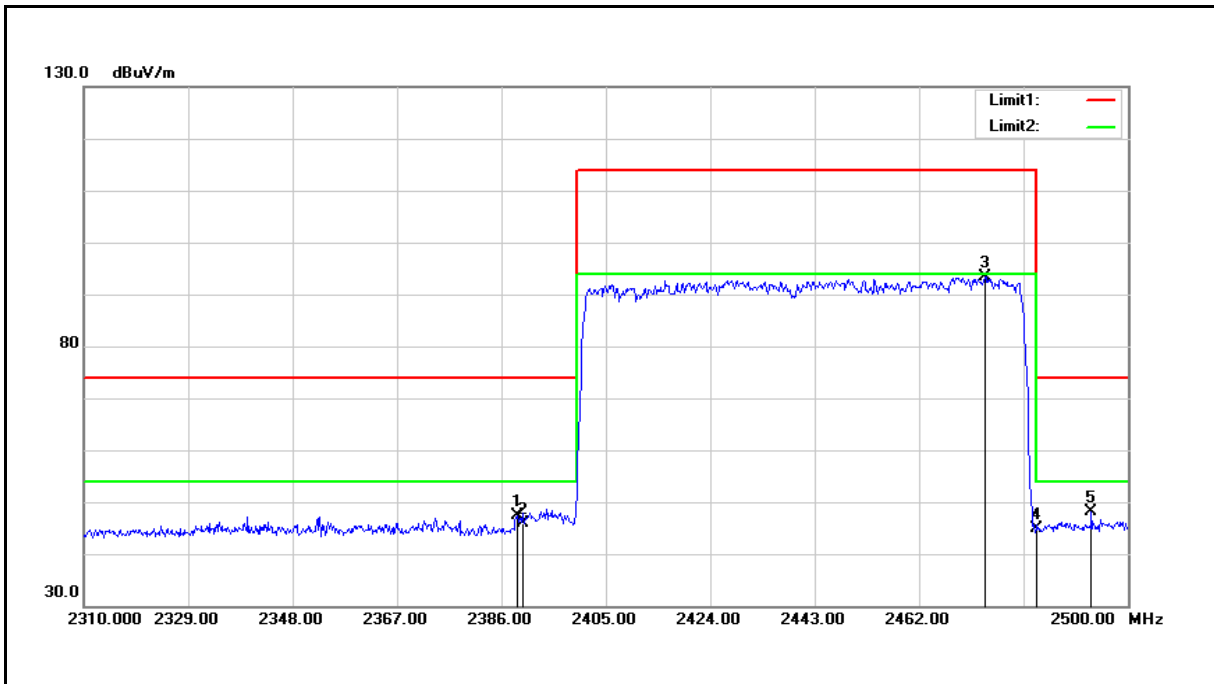

No.	Frequency (MHz)	Reading (dBUV)	Correct Factor (dB/m)	Result (dBUV/m)	Limit (dBUV/m)	Margin (dB)	Remark
1	2388.850	48.33	-0.84	47.49	74.00	-26.51	peak
2	2390.000	46.71	-0.82	45.89	74.00	-28.11	peak
3	2473.970	93.81	-0.40	93.41	--	--	peak
4	2483.500	45.32	-0.35	44.97	74.00	-29.03	peak
5	2493.350	48.30	-0.29	48.01	74.00	-25.99	peak

Note:1.Result (dBUV/m) = Correct Factor (dB/m) + Reading(dBUV).

2.Correction factor (dB/m) = Antenna Factor (dB/m) + Cable loss (dB) – Pre-Amplifier gain (dB).

3.When the peak results are less than average limit, so not need to evaluate the average.

--- END---