

Spectrophotometer CM-700d/600d

E Instruction Manual

Es Manual de instrucciones



KONICA MINOLTA

Notes on this Manual

- Copying or reproduction of all or part of the contents of this manual without KONICA MINOLTA SENSING's permission is strictly prohibited.
- The contents of this manual are subject to change without prior notice.
- Every effort has been made in the preparation of this manual to ensure the accuracy of its contents. However, should you have any questions or find any errors, please contact a KONICA MINOLTA SENSING-authorized service facility.
- KONICA MINOLTA SENSING will not accept any responsibility for consequences arising from the use of the instrument.

- This equipment has been tested and found to comply with the limits for a Class B digital device, pursuant to Part 15 of the FCC Rules. These limits are designed to provide reasonable protection against harmful interference in a residential installation. This equipment generates, uses and can radiate radio frequency energy and, if not installed and used in accordance with the instructions, may cause harmful interference to radio communications. However, there is no guarantee that interference will not occur in a particular installation. If this equipment does cause harmful interference to radio or television reception, which can be determined by turning the equipment off and on, the user is encouraged to try to correct the interference by one or more of the following measures:
 - Reorient or relocate the receiving antenna.
 - Increase the separation between the equipment and receiver.
 - Connect the equipment into an outlet on a circuit different from that to which the receiver is connected.
 - Consult the dealer or an experienced radio/TV technician for help.
- This device complies with FCC RF radiation exposure limits set forth for an uncontrolled environment. The antenna used for this transmitter must be installed to provide a separation distance of at least 20 cm from all persons and must not be co-located or operating in conjunction with any other antenna or transmitter.
- You are cautioned that changes or modifications not expressly approved by the party responsible for compliance could void your authority to operate the equipment.
- This Class B digital apparatus complies with Canadian ICES-003.
- Cet appareil numérique de la classe B est conforme a la norme NMB-003 du Canada.

Safety Symbols

The following symbols are used in this manual to prevent accidents which may occur as result of incorrect use of the instrument.



Denotes a sentence regarding a safety warning or note.
Read the sentence carefully to ensure safe and correct use.



Denotes a prohibited operation.
The operation must never be performed.



Denotes an instruction.
The instruction must be strictly adhered to.



Denotes a prohibited operation.
Never disassemble the instrument.











Denotes an instruction.
Disconnect the AC power cord from the AC outlet.





Trademarks

- Windows® is a registered trademark of Microsoft Corporation in the United States and other countries.
- Bluetooth® is a registered trademark of Bluetooth SIG, Inc.

Safety Precautions

To ensure correct use of this instrument, read the following points carefully and adhere to them. After you have read this manual, keep it in a safe place where it can be referred to anytime a question arises.

 WARNING (Failure to adhere to the following points may result in death or serious injury.)			
	Do not use the instrument in places where flammable or combustible gases (gasoline etc.) are present. Doing so may cause a fire.		Do not disassemble or modify the instrument or the AC adapter. Doing so may cause a fire or electric shock.
	Always use the AC adapter supplied as a standard accessory or the optional AC adapter, and connect it to an AC outlet of the rated voltage and frequency. If an AC adapter other than those specified by KONICA MINOLTA SENSING is used, it may result in damage to the unit, fire or electric shock.		The instrument should not be operated if it is damaged or the AC adapter is damaged, or if smoke or odd smells occur. Doing so may result in a fire. In such situations, turn the power OFF immediately, disconnect the AC adapter from the AC outlet (or remove the batteries if they are being used) and contact the nearest KONICA MINOLTA SENSING-authorized service facility.
	If the instrument will not be used for a long time, disconnect the AC adapter from the AC outlet. Accumulated dirt or water on the prongs of the AC adapter's plug may cause a fire and should be removed.		Do not insert or disconnect the AC adapter with wet hands. Doing so may cause electric shock.
	Take special care not to allow liquid or metal objects to enter the instrument. Doing so may cause a fire or electric shock. Should liquid or metal objects enter the instrument, turn the power OFF immediately, disconnect the AC adapter from the AC outlet (or remove the batteries if they are being used), and contact the nearest KONICA MINOLTA SENSING-authorized service facility.		Do not dispose of batteries in fire, short their terminals, apply heat to them, or disassemble them. Also, do not recharge them (if they are not chargeable). Doing so may cause explosion or heat generation, resulting in fire or injury.

 CAUTION (Falling to adhere to the following points may result in injury or damage to the instrument or other property.)			
	Do not perform measurement with the specimen measuring port directed towards your eyes. Doing so may damage your eyes.		Do not place the instrument on an unstable or sloping surface. Doing so may result in its dropping or overturning, causing injury. Be careful not to drop the instrument when carrying it.
	Do not use batteries other than those specified by KONICA MINOLTA SENSING. When installing batteries in the instrument, make sure that they are correctly oriented according to the (+) and (-) marks. Failure to adhere to these instructions may cause batteries to explode or leak electrolyte, resulting in fire, injury or air pollution.		When using the AC adapter, make sure that the AC outlet is located near the instrument and that the AC adapter can be connected to and disconnected from the AC outlet easily.

Introduction

Thank you for purchasing the CM-700d/600d.

This is a precise, lightweight and compact spectrophotometer developed for color and color difference measurement of reflective objective colors in various industries.

Packing materials of the product

Be sure to keep all packing materials used for shipping the product (cardboard box, cushioning material, plastic bags, etc.).

The CM-700d/600d is a precision measuring instrument. When transporting the instrument to a service facility for maintenance or for other reasons, be sure to use the packing materials to minimize shock or vibration.

If the packing materials are lost or damaged, contact a KONICA MINOLTA SENSING-authorized service facility.

Notes on Use

Operating Environment

- Use the CM-700d/600d at ambient temperature between 5°C and 40°C and relative humidity 80% or less (at 35°C) with no condensation.
Be sure to use the instrument within this range. Do not use it in areas of rapid temperature changes.
- Do not leave the CM-700d/600d in direct sunlight or near sources of heat, such as stoves etc. The internal temperature of the instrument may become much higher than the ambient temperature in such cases.
- Do not use the CM-700d/600d in areas where dust, cigarette smoke or chemical gases are present. Doing so may cause deterioration in performance or a breakdown.
- Do not use the CM-700d/600d near equipment which produces a strong magnetic field (such as speakers etc.).
- The CM-700d/600d belongs to installation category II products (equipment which is powered by an AC adapter connected to commercially available power).
- The CM-700d/600d belongs to pollution level 2 products (equipment which may cause temporary electrical hazards due to contamination or condensation or products which are used in such an environment).
- Do not use the CM-700d/600d at altitudes higher than 2000 m.
- The CM-700d/600d and the AC adapter supplied as a standard accessory have been designed exclusively for indoor use. They should never be used outdoors because rain or other factors may damage the instrument.

Measurement

- When using the instrument upside-down, make sure no dirt or dust get into the specimen measuring port.
- When using the instrument for long periods of time, the displayed value may change depending on changes in the environment. Therefore, in order to achieve accurate measurements, we recommend that white calibration be done regularly using the White Calibration Cap.

White Calibration Cap

- The White Calibration Cap must be used in combination with the instrument that bears the same pairing number.
- The calibration data for the White Calibration Plate attached to the White Calibration Cap was measured at 23°C. To achieve the highest accuracy when measuring absolute values (colorimetric values), calibration and measurement should be performed at 23°C.
- Do not allow the White Calibration Plate to get scratched or stained.
- When not using the White Calibration Cap, invert it so that the White Calibration Plate is not exposed to ambient light.
- When the White Calibration Cap is attached to the instrument, do not hold on to the White Calibration Cap to move the instrument. The cap may become detached from the instrument, causing the instrument to fall and become damaged.

Target Mask

- Do not touch the Target Mask's inner surface by hand, scratch it or make it dirty.
- When not in use, Target Masks should be stored in the cardboard box used for shipment or in the optional hard case so that they will not be exposed to ambient light.

Power Source

- Make sure that the power switch is set to OFF (“”) when the CM-700d/600d is not in use.
- The CM-700d/600d can be powered from either the AC adapter (AC-A305) or AA-size alkaline or nickel-metal-hydride rechargeable batteries. Note, however, that you cannot use this AC adapter to charge the nickel-metal-hydride rechargeable batteries installed in the instrument.
- Always use the AC adapter supplied as a standard accessory (AC-A305) and connect it to an AC outlet of the rated voltage and frequency. Use an AC power supply of the rated supply voltage (within $\pm 10\%$).

System

- Do not subject the CM-700d/600d to strong impact or vibration. Doing so may cause deterioration in performance or a breakdown.
- Since the specimen measuring port and integrating sphere are extremely precise optical components, great care should be taken to prevent them getting dirty or exposing them to impact.
- When not in use, the instrument must be stored with the White Calibration Cap being attached.
- The CM-700d/600d may cause interference if used near a television, radio, etc.
- When the instrument is exposed to strong external static electricity, the LCD may go blank or the measurement result may not be displayed properly. If the instrument is communicating with an external device, the communication may be interrupted. In these cases, turn the power OFF and then turn it ON again. If black smudges appear on the LCD, wait until they disappear naturally.
- When turning the power OFF and then ON again, wait several seconds after turning the power OFF.

Backup Battery

- Measured data and various settings are stored in the memory backed up by batteries. The backup batteries are automatically charged during operation of this instrument, and can retain the contents of the memory for 5 months if they have been fully charged. At the time of purchase, the backup battery may not be fully charged. To charge the backup battery, set the power switch to ON. Charging of the backup battery is performed continuously while the instrument is switched on, even while the instrument is being used. Full charging is completed in 24 hours, and there is no danger of overcharging.
- It is recommended to keep a backup for your important data on another recording medium using the optional Color Data Software SpectraMagic™ NX (CM-S100w).

Note

- *The backup batteries' model number is ML2020 (3 V).*
- *Do not try to replace the backup batteries by yourself. Contact a KONICA MINOLTA SENSING-authorized service facility.*

Notes on Storage

- The CM-700d/600d should be stored at temperatures between 0°C and 45°C, and at a relative humidity of 80% or less (35°C) without condensation. Do not store the instrument in areas subject to high temperatures, high humidity, sudden changes in temperature, or where freezing or condensation may occur, because these circumstances may cause a breakdown. It is recommended to store the CM-700d/600d with a drying agent (such as silica gel) at a temperature around 20°C.
- Do not leave the CM-700d/600d inside a car such as in the cabinet or trunk. Otherwise, the temperature and/or humidity may exceed the allowable range for storage during midsummer or midwinter, resulting in a breakdown.
- Keep the packing materials used for shipment and use them to transport the CM-700d/600d. This protects the instrument from sudden changes in temperature, vibration, and shock.
- Do not store the CM-700d/600d in areas where dust, cigarette smoke or chemical gases are present. Doing so may cause deterioration in performance or a breakdown.
- Entry of dust into the specimen measuring port will hinder accurate measurement. When the instrument is not in use, you must attach the White Calibration Cap to the instrument to prevent the entry of dust into the integrating sphere through the specimen measuring port.

- The White Calibration Plate attached to the White Calibration Cap may become discolored if left exposed to light. Therefore, make sure that the cap is inverted when it is not in use so that the White Calibration Plate is not exposed to ambient light.
- The Target Masks may discolor if they are left exposed to light. When they are not in use, keep them in a safe place to prevent exposure to light and to protect them from scratches and dust.
- Be sure to keep all packing materials (cardboard box, cushioning material, plastic bags, etc.). They can be used to protect the instrument during transportation to the service facility for maintenance (re-calibration etc.).
- If you are not going to use the CM-700d/600d for more than two weeks, the batteries must be removed. If the batteries are left in the instrument, battery electrolyte may leak and damage the instrument.

Notes on Cleaning

- If the CM-700d/600d becomes dirty, wipe it with a soft, clean dry cloth. Never use solvents such as thinner or benzene.
- If the White Calibration Plate attached to the White Calibration Cap becomes dirty, wipe it gently with a soft, clean and dry cloth. If dirt is difficult to remove, wipe it off with a cloth dampened with commercially-available lens cleaning solution. Then remove the solution with a cloth dampened with water, and leave the plate to dry.
- If the inner surface of the Target Masks or the inside of the integrating sphere get dirty, contact a KONICA MINOLTA SENSING-authorized service facility.
- Should the CM-700d/600d break down, do not try to disassemble and repair it by yourself. Contact a KONICA MINOLTA SENSING-authorized service facility.

Disposal Method

- When disposing of used batteries, insulate the terminals with insulating tape etc. If the terminals of the battery come into contact with metal objects, heat generation, explosion or fire may result.
- Make sure that the CM-700d/600d, its accessories and used batteries are either disposed of or recycled correctly in accordance with local laws and regulations.

Contents

Safety Precautions	E-1
Introduction	E-2
Notes on Use	E-2
Notes on Storage	E-3
Notes on Cleaning	E-4
Disposal Method	E-4
Conventions	E-8

Chapter 1 Before Using the Instrument

Accessories	E-10
Standard Accessories	E-10
Optional Accessories	E-11
Names and Functions of Parts	E-12
Preparation	E-14
White Calibration Cap CM-A177	E-14
Attaching/Removing a Target Mask	E-15
Cleaning Parts	E-16
Attaching Wrist Strap to the Instrument	E-17
Inserting the Batteries	E-18
Connecting the AC Adapter	E-19
Turning Power ON/OFF	E-20
System Diagram	E-21
Items You Must Know	E-22
Initial Settings of the CM-700d/600d	E-22
Control Panel	E-22
Battery Alarm	E-24
Data Saving	E-24
Pairing Number	E-24

Chapter 2 Preparation for Measurement

Flow of Measurement	E-26
Calibration	E-27
Zero Calibration	E-27
White Calibration	E-29
User Calibration	E-31
Condition Setting	E-32
Setting the Display Conditions	E-32
Setting the Measurement Conditions	E-42
Color Difference Target Color Data Operation	E-47
Setting a Target Color	E-47
Target Color Menu	E-48
Registering Conditions (Cond)	E-58
Naming a Condition	E-60
Setting the Default Color Difference Tolerance (Tolerance (Def.))	E-61
Selecting Color Difference Tolerances	E-64
Deleting the Default Color Difference Tolerance Setting	E-65
Naming the Color Difference Tolerance Setting	E-66

Other Settings	E-68
Setting the Display Language	E-68
Setting the Date and Time	E-69
Setting the Power Save Mode	E-72
Initialization	E-74

Chapter 3 Measurement

Measurement	E-76
Displaying the Measurement Results	E-77
Measured Data	E-77
Pass/Fail Judgment	E-78
Color Difference Graph	E-78
Spectral Reflectance Graph	E-79
Switching the Display Contents of the Measurement Results	E-80
Measured Data Operation	E-83
Print	E-84
Delete	E-84
Edit Name	E-85
Scan Name	E-86
Setting the List (List)	E-88
Auto Target	E-88
Delete All	E-89

Chapter 4 Other Functions

Average Measurement	E-92
Manual Averaging	E-92
Auto Averaging	E-94
Pass/Fail Judgment for Color Difference	E-95
Pass/Fail Judgment Based on Tolerances	E-95
Connecting to an External Device	E-98
Connecting a Personal Computer	E-98
Connecting a Printer	E-102
Connecting a Bar Code Scanner	E-111
Setting Auto Scan	E-116
Displaying the Instrument Information	E-117
Showing/Hiding the Annual Service Recalibration Recommendation Message	E-118

Chapter 5 Troubleshooting

Error Messages	E-120
Troubleshooting	E-123

Chapter 6 Appendix

Principles of Measurement	E-126
Illuminating/Viewing System	E-126
Illumination Area and Measurement Area	E-127
Simultaneous SCI/SCE Measurement	E-127
Communication Mode	E-127
Initial Settings	E-128
Specifications	E-129
Dimensions	E-131

Conventions

This manual describes how to safely operate the CM-700d/600d using a specific procedure to perform measurement.

• Page layout

Symbols used in this manual are explained below.

*Note that the page shown in the illustration is for explanatory purposes only, and is not an actual page from this manual.

<p>Memo Gives useful Information and additional explanations.</p>	<p>Note Gives the points that you should know to perform operations correctly. Make sure that you read the notes.</p>	<p>Procedure Shows the operating procedure.</p>	<p>Settings Gives the range and explanation of the values to be set in this screen.</p>	<div style="border: 1px solid black; padding: 10px;"> <h3 style="text-align: center;">Condition Setting</h3> <p>The CM-700d/600d requires condition settings (display and measurement conditions) before measurement can be started.</p> <p>Memo To configure condition settings, select "Disp. Cond." (display condition) or "Meas. Cond." (measurement condition) from the <Option> screen to open an appropriate screen.</p> <p>Note The results for "Diff. Formu.", "Abs. & Diff." and "Comp. Diff." will be displayed only when the no operation has been specified.</p> <h4 style="text-align: center;">Setting the Display Conditions</h4> <p>To set the display conditions, select "Disp. Cond." on the <Option> screen. You can select to specify the following seven items at the display conditions:</p> <ul style="list-style-type: none"> • Disp. Type: Specify items to be displayed as measurement results. • Color Space: Select a color space to be used. • Equation: Select a color difference formula to be used. • Color Index: Select an index (VI, VI, etc.) to be used. • Observer: Select a measuring angle from 2° or 10°. • Illuminant 1: Select an illuminant used to measure colorimetric data. • Illuminant 2: Select a secondary illuminant used for MI (metamerism index) calculation, etc. <p>[Setting Procedure] Start the procedure from the <Disp. Cond.> screen.</p> <ol style="list-style-type: none"> 1 Hold down the [MENU] button and press the \blacktriangledown button of the cross key. The <Option> screen is displayed. 2 Use the \blacktriangle or \blacktriangledown button of the cross key to move the cursor to "Disp. Cond." and then press the [SAVE/SEL] button. The <Disp. Cond.> screen is displayed. <div style="border: 1px solid black; padding: 5px; margin: 10px 0;"> <p style="font-size: small;">Option</p> <p style="font-size: small;">1. [MENU] 2. [SAVE/SEL]</p> <p style="font-size: small;">1. To improve Char. 2</p> <p style="font-size: small;">2. Conversion Level 1</p> <p style="font-size: small;">3. Settings</p> <p style="font-size: small;">4. Measurement</p> <p style="font-size: small;">5. Power / OFF</p> <hr/> <p style="font-size: small;">Disp. Cond.</p> <p style="font-size: small;">1. Disp. Type</p> <p style="font-size: small;">2. To improve Char. 2</p> <p style="font-size: small;">3. Conversion Level 1</p> <p style="font-size: small;">4. Settings</p> <p style="font-size: small;">5. Measurement</p> <p style="font-size: small;">6. Power / OFF</p> </div> <p style="font-size: x-small;">E-32</p> </div>	<p>Start screen Shows the screen from which operation must be started.</p> <p>Screen Shows the contents of the current screen when the given operation is carried out.</p>
--	--	--	--	--	--

For the version of the instrument firmware

The version of the instrument firmware can be confirmed on the <Instrument> screen. For details, refer to page E-117 "Displaying the Instrument Information" in this manual.



Chapter 1

Before Using the Instrument

Accessories

Standard and optional accessories are available with the instrument.

Standard Accessories

Make sure that all the following items are present.

White Calibration Cap CM-A177
(w/ white calibration data CD-R)

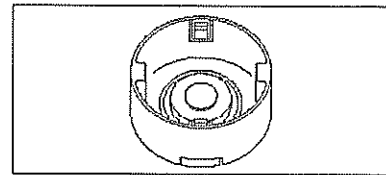

Target Mask

Used to switch the illumination area (specimen measuring port size) according to the specimen.

Target Mask ϕ 8 mm (w/ plate) CM-A178 <For MAV>
Target Mask ϕ 3 mm (w/ plate) CM-A179 <For SAV>
Target Mask ϕ 8 mm (w/o plate) CM-A180 <For MAV>
Target Mask ϕ 3 mm (w/o plate) CM-A181 <For SAV>

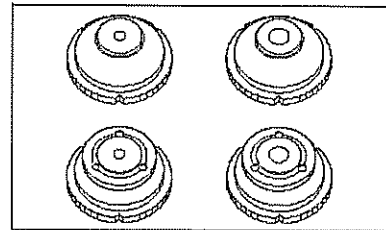

[Memo]

- The instrument is shipped with the CM-A178 Target Mask ϕ 8 mm with plate (for MAV) being attached.
- The CM-A179 and CM-A181 Target Masks ϕ 3 mm (for SAV) are not included in the package of the CM-600d.

AC Adapter AC-A305

Used to supply power from an AC outlet to the instrument.
Input: 100-240 V \sim 50/60 Hz 24-38 VA
Output: 5 V \equiv 2 A

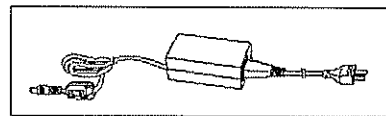

USB Cable IF-A17

Used to connect the instrument to a personal computer (PC).



4 AA-size alkaline dry batteries

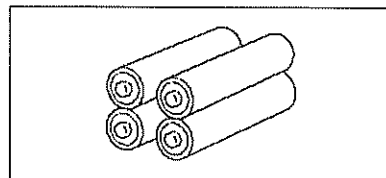

Wrist Strap CR-A73

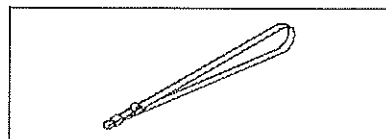

Optional Accessories

You may purchase the following accessories if necessary.

Zero Calibration Box CM-A182

Used to perform zero calibration.

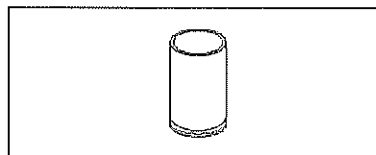

Color Data Software SpectraMagic™ NX CM-S100w

Used to operate the instrument from a PC for data processing and file management.

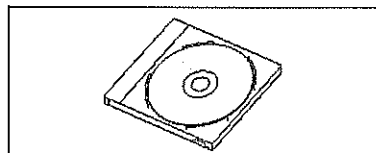

Hard Case CM-A176

Used to store the instrument together with accessories.

*Do not use the hard case for transportation purposes.

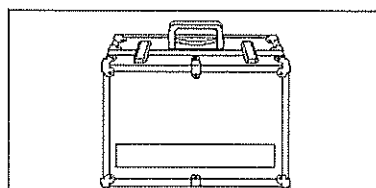

Target Mask ϕ 8 mm (with glass) CM-A183

Used to measure viscous or damp specimens.



Granular-Materials Attachment CM-A184

Used to contain paste or powder specimens to ensure measurements under stable conditions.



Dust Cover Set CM-A185

Prevents foreign matters from entering the instrument in dusty environments.

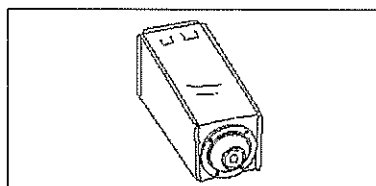

Replacement Dust Cover (Polyolefin) CM-A186

Names and Functions of Parts

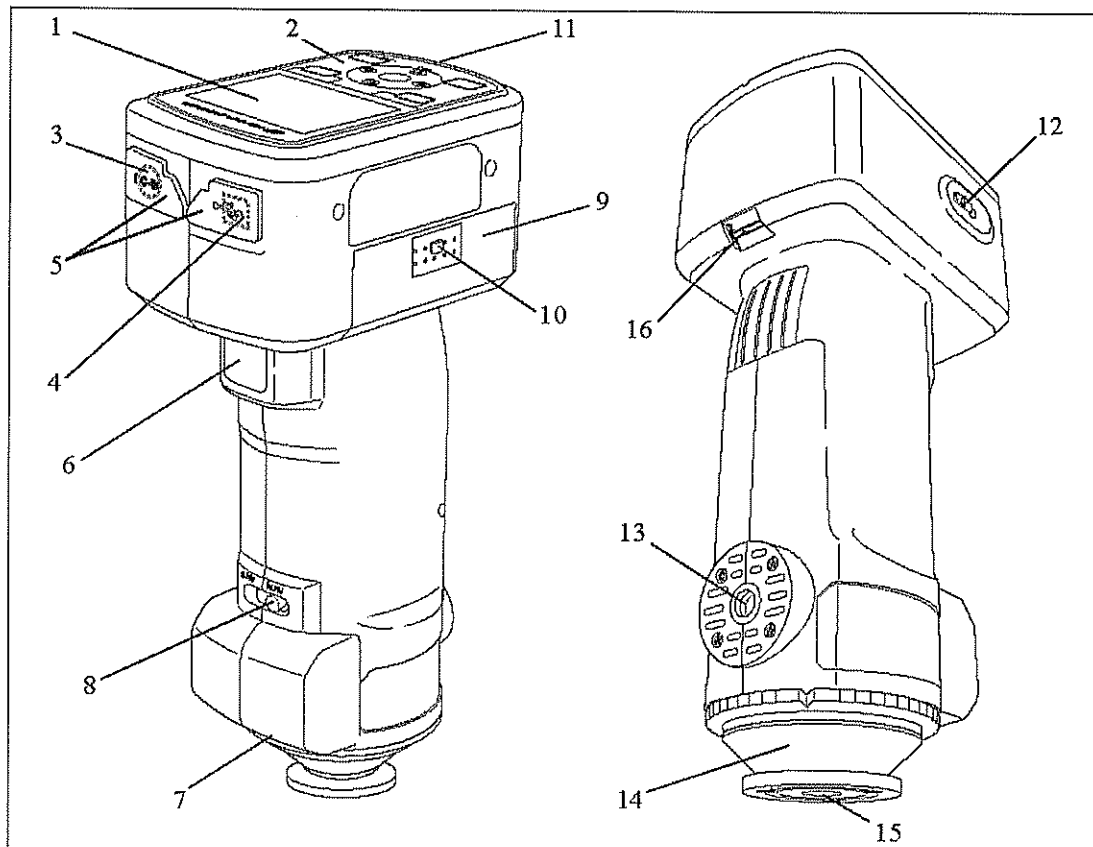

- 1 **LCD screen**
Displays setting items, measurement results and messages.
- 2 **Control panel**
Used to switch screens or select/determine/save setting items.
For details, refer to page E-23 "Control Buttons".
- 3 **AC adapter terminal**
When using the supplied AC adapter (CM-A305), connect the adapter's plug to this terminal.
- 4 **USB connection terminal**
Used to connect the instrument to a PC with the supplied USB cable (IF-A17).
- 5 **Connector protection covers**
Protects the AC adapter terminal and USB connection terminal.
- 6 **Measuring button**
Push this button to perform calibration or measurement.
- 7 **Pairing No. label**
Shows the identification No. of the White Calibration Cap that can be used with the instrument.

8 Measurement area selector

Used to change the lens position according to the measurement area.

Memo

The CM-600d does not have this switch.

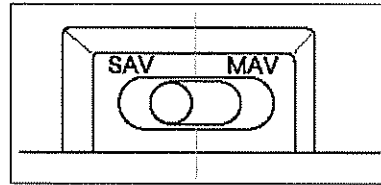
**9 Battery chamber cover**

The cover of the battery chamber. Four AA-size batteries must be set in the battery chamber with the correct polarity alignment.

10 Battery chamber cover button

Press this button to open or close the battery chamber cover.

11 READY Lamp

Ready to measure (and fully charged) when green.

12 Power switch

Used to turn ON/OFF power. Setting this switch to "O" turns the power OFF, and setting it to "I" turns the power ON.

13 Tripod mount**14 Target Mask**

Used to change the measurement area according to the measurement area selector setting. Selectable from several types depending on the application.

15 Specimen measuring port

The port for measuring the specimen. The port size can be changed by changing the Target Masks.

Note

The measurement area cannot be changed with the CM-600d.

16 Strap holder

Used to attach the supplied Wrist Strap.

Memo

For details of attaching Wrist Strap, refer to "Attaching Wrist Strap to the Instrument" (page E-17).

Preparation

White Calibration Cap CM-A177

The instrument is shipped with a White Calibration Cap and white calibration data CD-R. The White Calibration Cap has the structure shown below. It should be attached to the instrument before white calibration.

Note

- The White Calibration Cap must be used in combination with the instrument that bears the same pairing number.
- When the White Calibration Cap is not in use, invert it so that the White Calibration Plate is not exposed to ambient light or dust.
- When the CM-700d/600d is not in use, you must attach the White Calibration Cap to the instrument to prevent the entry of dust into the integrating sphere through the specimen measuring port.

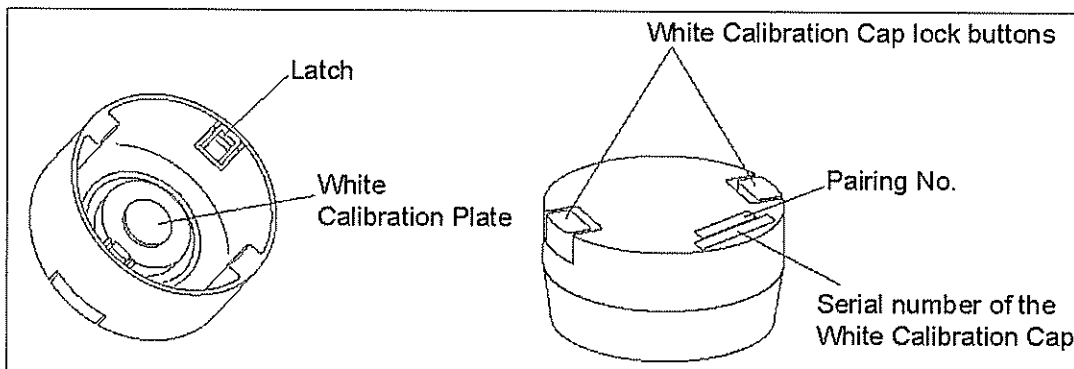

Attachment/Removal to/from the Instrument

• Attachment

1. Hold the instrument securely.
2. Squeeze the White Calibration Cap lock buttons, place the White Calibration Cap on the Target Mask of the instrument, and release the lock buttons to secure the cap.

Note

Do not move the instrument by holding the White Calibration Cap. The instrument may detach from the cap, possibly resulting in the instrument falling and being damaged.

• Removal

1. While squeezing the White Calibration Cap lock buttons, pull the cap out straight from the instrument.

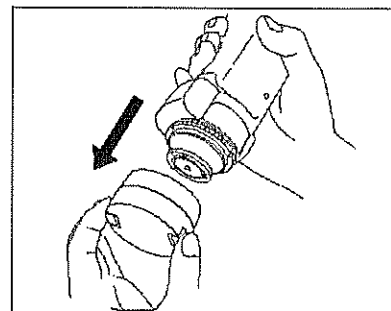
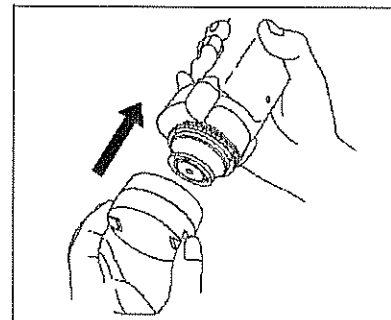

Attaching/Removing a Target Mask

The CM-700d/600d must be used with a Target Mask conforming to the selected lens position and measurement condition.

To attach/remove a Target Mask, follow the procedure given below.

Note

- When attaching/removing a Target Mask, be careful not to allow dirt or dust to enter the integrating sphere through the specimen measuring port.
- Do not touch the white-coated inner surface of the integrating sphere, wipe it with a cloth or put an object inside it.
- Do not exert excessive force on the latch of the Target Mask. Doing so may damage the latch, disabling use of the Target Mask.

Memo

If a Target Mask is damaged, contact a KONICA MINOLTA SENSING-authorized service facility.

Attachment/Removal to/from the Instrument

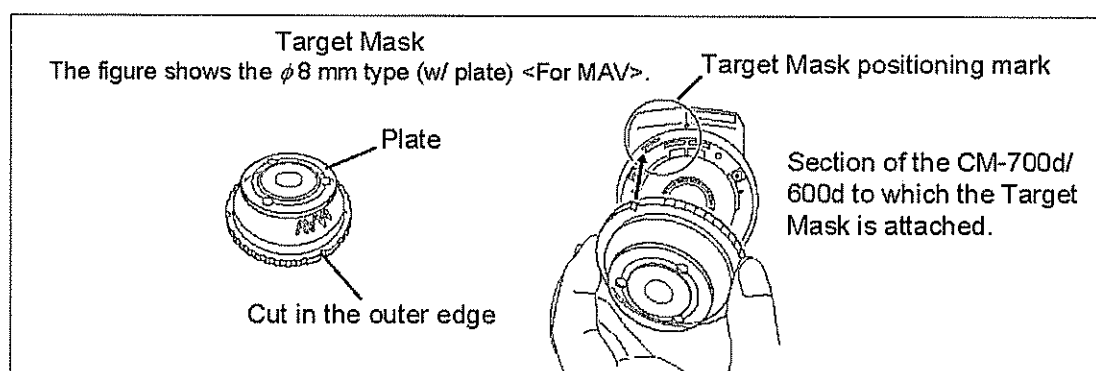

• Attachment

1. Place the Target Mask over the specimen measuring port so that the cut in the outer edge of the Target Mask is aligned with the starting point of the positioning mark (→) on the instrument.
2. Hold the outer edge of the mask, and turn it in the direction of the arrow (clockwise). Turn the mask until the cut in the outer edge is aligned with the “O” mark on the instrument and then secure the mask.

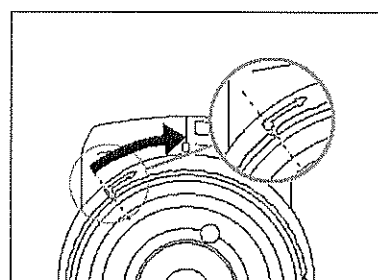

• Removal

1. Hold the outer edge of the mask, and turn it in the opposite direction of the arrow (counterclockwise). Turn the mask until the cut in the outer edge is aligned with the starting point of the positioning mark (→) of the instrument.
2. Hold the outer edge of the mask and remove it.

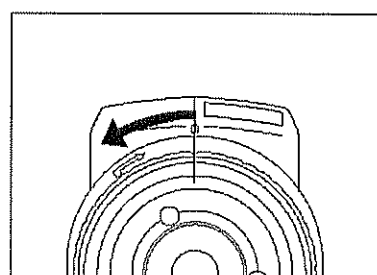

Cleaning Parts

This section explains how to clean the White Calibration Cap, Target Mask and the inside of the integrating sphere.

White Calibration Cap

- When the White Calibration Plate becomes dirty, gently wipe the dirt off with a soft dry cloth. If the dirt is difficult to remove, wipe it off with a cloth dampened with commercially available lens cleaning solution. Then remove the solution with a cloth dampened with water, and leave the plate to dry.
- When parts other than the White Calibration Plate become dirty, lightly wipe the dirt off with a cloth dampened with water or soapy water. Never use solvents such as thinner or benzene.

Note

Be careful not to scratch the White Calibration Plate.

Target Mask

Use a blower to remove dirt and dust from the Target Masks.

Note

Do not touch the inner surface of the Target Masks with your fingers or wipe them with a cloth to remove dust. If the inside is so dirty that dirt cannot be removed with a blower, contact the nearest KONICA MINOLTA SENSING-authorized service facility.

Inside the Integrating Sphere

1. Remove the Target Mask.

Memo

For the procedure of removing the Target Mask, refer to page E-15 "Attaching/Removing a Target Mask".

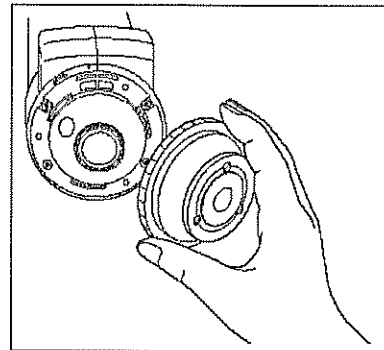

2. Use a blower to remove dirt and dust from the integrating sphere.

Note

Do not touch the white-coated inner surface of the integrating sphere, wipe it with a cloth or put an object inside it. If the inside is so dirty that dirt cannot be removed with a blower, contact the nearest KONICA MINOLTA SENSING-authorized service facility.

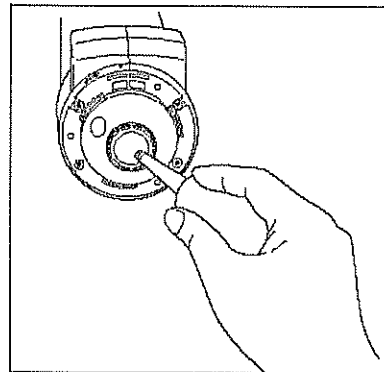

Attaching Wrist Strap to the Instrument

When measuring by hand, attach Wrist Strap and put your arm through Wrist Strap to prevent dropping of the instrument.

[Procedure]

- 1** Pass one end of Wrist Strap through the strap holder of the instrument.
- 2** Pass other end of Wrist Strap through the ring, and pass the strap that passed through the strap holder through the ring too.
- 3** Pass one end of Wrist Strap that passed through the ring through the buckle.
- 4** Pass other end of the strap through the buckle from the other side.

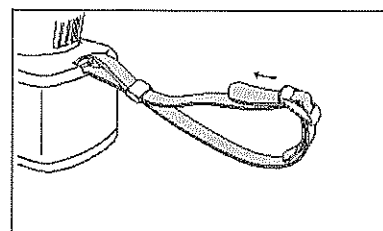
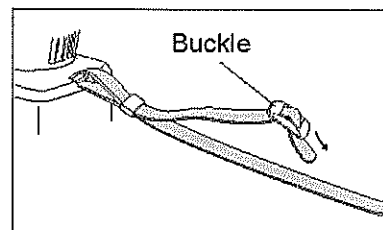
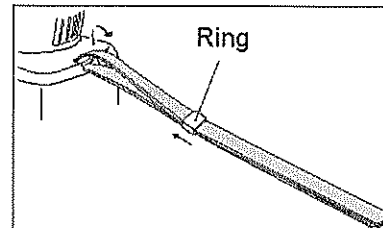
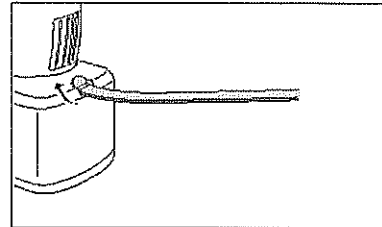

Memo

If necessary, after passing the arm through the strap, move the position of the ring so that the strap is snug your arm.

Inserting the Batteries

For the CM-700d/600d, the supplied AC adapter (AC-A305) or four AA-size batteries (alkaline or nickel-metal-hydrate rechargeable batteries) must be used as a power supply. Use either the AC adapter or batteries according to your application.

Note

- Do not use manganese batteries.
- If you are not going to use the CM-700d/600d for more than two weeks, the batteries must be removed. If the batteries are left in the instrument for a long time, battery electrolyte may leak and damage the instrument.
- Do not use batteries of different types or mix new batteries with old ones. Doing so may result in battery explosion or shorter battery life.
- Do not touch or short-circuit the terminals inside the battery chamber. Doing so may result in breakdown of the instrument.

[Procedure]

- 1 Make sure that power is OFF (Power switch is set to "O").

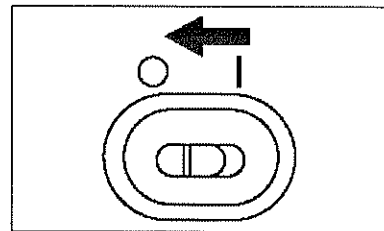

- 2 Press the battery chamber cover button on the side of the instrument and slide the cover downward to open it.

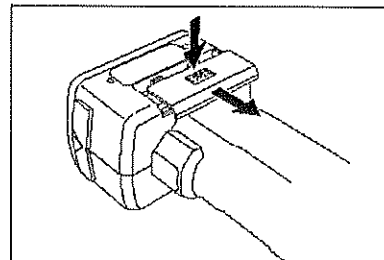

- 3 Place four AA-size batteries in the battery chamber. Make sure that the batteries are placed in the correct direction.

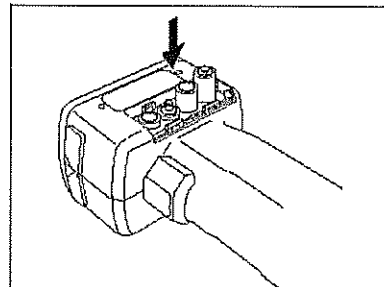

- 4 Align the grooves of the cover with the guides on the edge of the battery chamber opening. Press down lightly on the cover and slide it upward to close it.

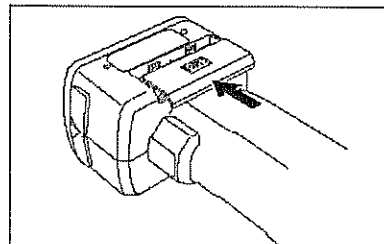

Connecting the AC Adapter

[Memo]

When the external output terminal is used for data communication or printing, more power will be required. In this case, it is recommended to use the AC adapter (AC-A305) rather than batteries.

[Note]

- To supply AC power to the instrument, always use the AC adapter (AC-A305) supplied with the instrument.
- Before connecting or disconnecting the AC adapter jack or plug, make sure that the instrument is turned OFF.

[Operating Procedure]

- 1 Make sure that power is OFF (Power switch is set to "O").

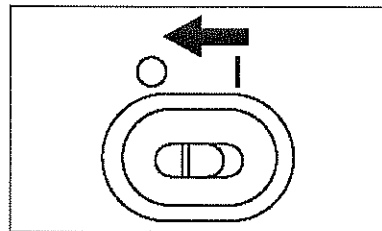

- 2 Open the connector protection cover of the AC adapter terminal on the instrument.

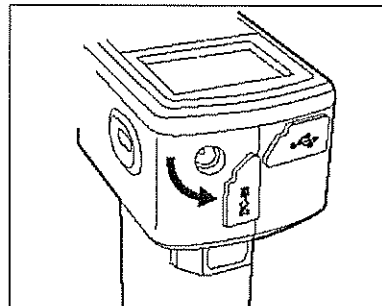

- 3 Connect the AC adapter connector jack to the AC adapter terminal.

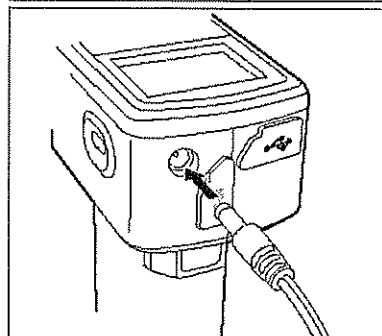

- 4 Insert the AC adapter power plug to an AC outlet (100 to 240 VAC, 50-60 Hz).

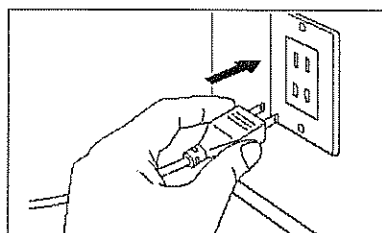

Turning Power ON/OFF

[Operating Procedure]

Turning power ON

- 1 Slide the Power switch to the “I” position.
The power will be turned ON (energized).

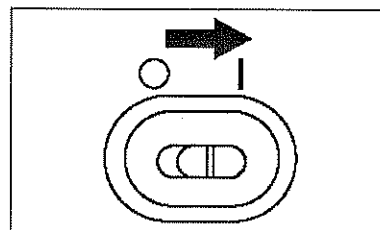

[Operating Procedure]

Turning power OFF

- 1 Slide the Power switch to the “O” position.
The power will be turned OFF.

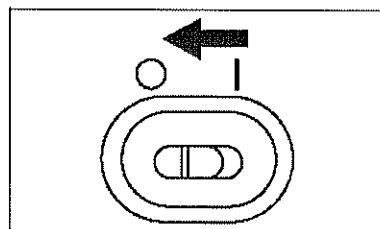

Power Save Function

The CM-700d/600d features a power save function which activates the power save mode when none of the measuring and control buttons is operated for a specified period of time. In the power save mode, the screen display is turned off and the flash circuit will not be charged.

You can return to the normal mode by pressing any of the measuring or control buttons.

Memo

The period of time before the power save mode is activated can be set on the <Option> screen. For details, refer to page E-72 “Setting the Power Save Mode”.

Note

The power save function is factory-set to OFF.

System Diagram

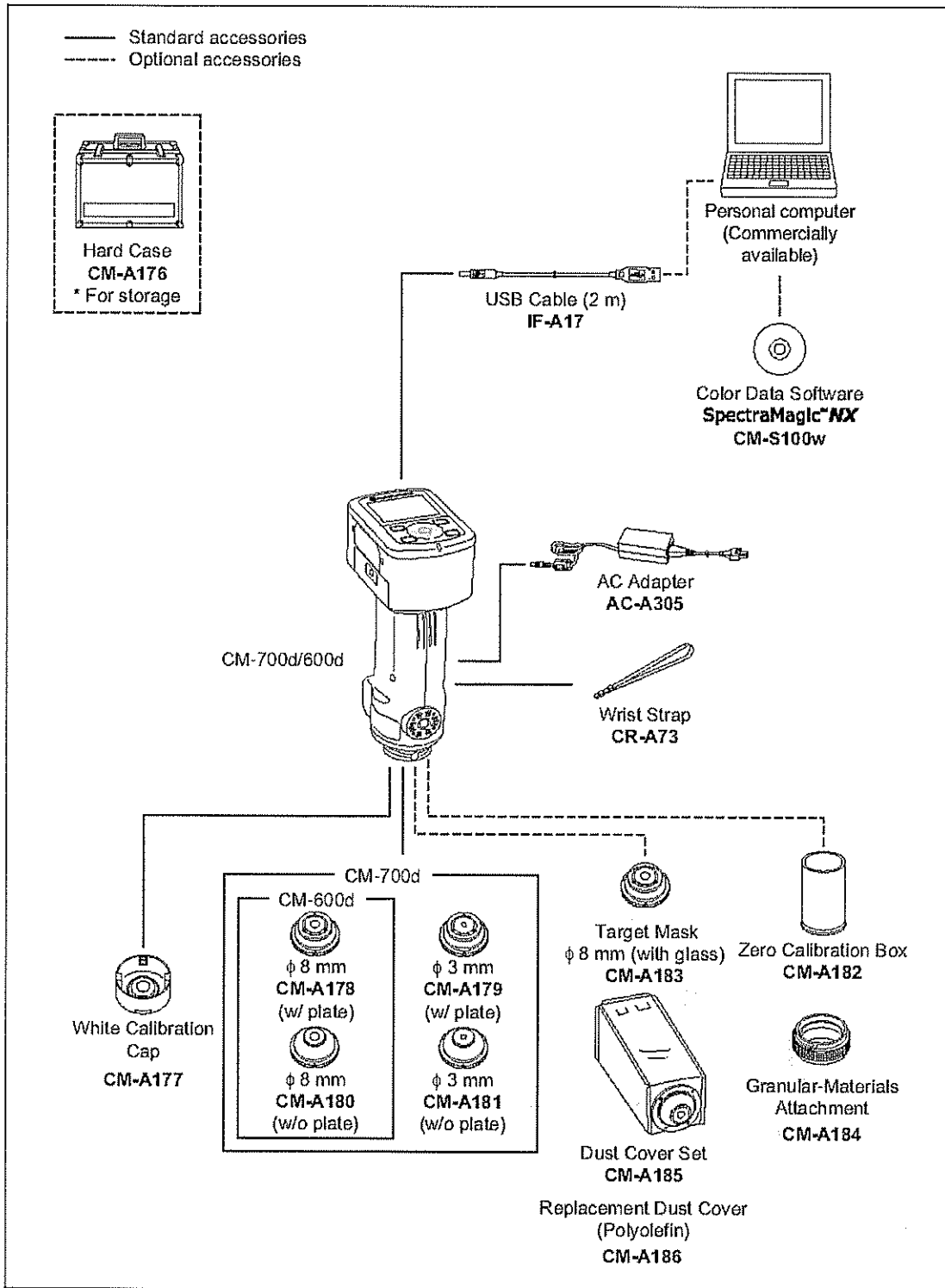

Items You Must Know

Initial Settings of the CM-700d/600d

When the instrument is turned ON, the <Calibration> screen will appear automatically in English. For normal measurement, you do not need to change the initial settings.

It is recommended that you check the date and specify the power save mode in the <Option> screen before using the instrument.

The display language can be selected from seven languages including Japanese.

For details, refer to page E-68 "Other Settings".

Control Panel

The top of the CM-700d/600d contains the LCD screen on which the instrument displays measurement results and messages, and the control buttons which are used to set measurement options or to change displays.

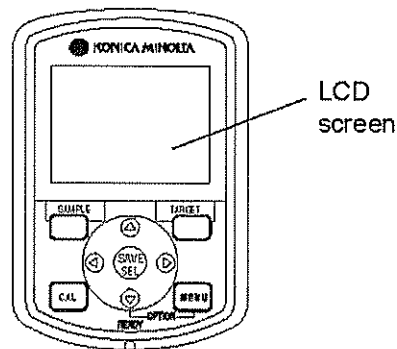

Screen Display (LCD Screen)

The LCD screen displays measurement settings, measurement results and messages. It also indicates the status of the instrument with icons.

The basic screen layout is shown below.

The screenshot shows the following text on the screen:

Target color No. 0001

MONICA MINOLTA

Sample0001

SGI 10°/D65 10°/C

L*	100.43	100.43
a*	0.43	0.33
b*	3.08	3.08
dL*	0.31	0.31
da*	0.03	0.03
db*	-0.00	0.01
dE00	0.18	0.18

2007/06/27 05:20:14

0001 M/I+E

Sample List Target







Annotations:

- Target color No. (points to '0001')
- Status icons (points to icons in the top right corner)
- The screen title is displayed. (points to 'Sample0001')
- Measured values and setting items are displayed. (points to the measurement table)

* For details, refer to the next page.

The functions assigned to the [SAMPLE], [SAVE/SEL] and [TARGET] buttons are displayed respectively.

Status Icons

Status icon	Description (Status)	Meaning
	Measurement area (Measurement area selector setting) * The CM-700d shows either the MAV or SAV icon. The CM-600d shows only the MAV icon.	MAV/SAV
	Specular component mode setting	SCI/SCE/I + E (SCI + SCE)
	Bluetooth capability setting	ON/OFF
	Calibration necessity	Zero calibration required/White calibration required/User calibration required
	White calibration after power-on	Performed/Not performed
	Flash circuit charging	Completed/Not completed

Control Buttons

Use these buttons to set items or change screens according to the guide on the LCD screen.

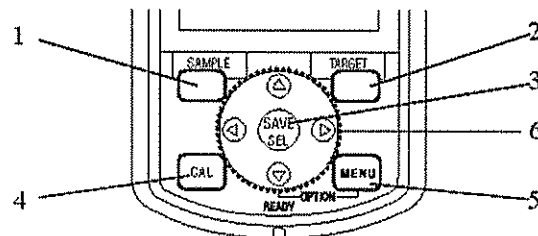

- | | |
|---|---|
| <p>1 [SAMPLE] button:
Press this button to display the <Sample> screen.</p> <p>2 [TARGET] button:
Press this button to display the <Target> screen.</p> <p>3 [SAVE/SEL] button:
Use this button to determine the item indicated by the cursor or to save the setting. When the <Sample> or <Target> screen is displayed, use this button to switch between the detail display and list display.</p> <p>4 [CAL] button:
Press this button to display the <Calibration> screen.</p> | <p>5 [MENU] button:
Press this button to display the <Menu> screen. The screens and setting items for which menu setting is available are indicated with <u>MENU</u> (MENU mark) at the top of the screen. You can display the <Option> screen by pressing the [MENU] button while holding down the ∇ button of the cross key.</p> <p>6 Cross key ($\leftarrow/\Delta/\nabla/\rightarrow$):
Use this key to move the cursor on the screen or to change the selected value. To determine the item indicated by the cursor, press the [SAVE/SEL] button.</p> |
|---|---|

Memo

The [SAMPLE], [SAVE/SEL] and [TARGET] buttons may be assigned different functions depending on the screen. In this case, the guidance at the bottom of the screen indicates the current functions (Edit, etc.).

Example of assigned functions

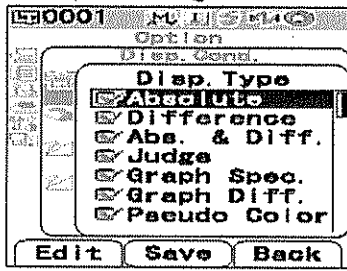

For example, when the screen shows the guidance **Edit Save Back**, the [SAMPLE], [SAVE/SEL] and [TARGET] buttons are assigned with the Edit, Save and Back functions respectively. In this manual, when the button name and the function assigned to the button are different, the button name and the function are described as “the [SAMPLE] (Edit) button” or “[TARGET] (Back) button”.

Battery Alarm

The CM-700d/600d can be powered from the standard AC adapter (AC-A305) or AA-size alkaline or nickel-metal-hydride rechargeable batteries. When the instrument is used with batteries, two types of battery alarm indication will appear when battery power level is low. When the battery power is sufficient, no battery alarm indication is displayed.

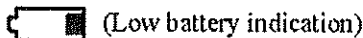

(Low battery indication)
When this indication appears, new batteries or the AC adapter should be prepared in the near future. Even with this indication displayed, measurements are still possible.

If you continue using the instrument with the low battery indication being displayed, ER002 (low battery voltage error) is displayed. When this error is displayed, replace the batteries immediately with new ones or connect the AC adapter.

Data Saving

Data used with this instrument are saved automatically. The white calibration data stored in the internal memory after you perform white calibration is retained even after the instrument is turned off.

Pairing Number

In addition to individual serial numbers, the instrument and White Calibration Cap bear 5-digit numbers called “pairing number”. Before starting white calibration, confirm that the instrument and White Calibration Cap have the same pairing number.

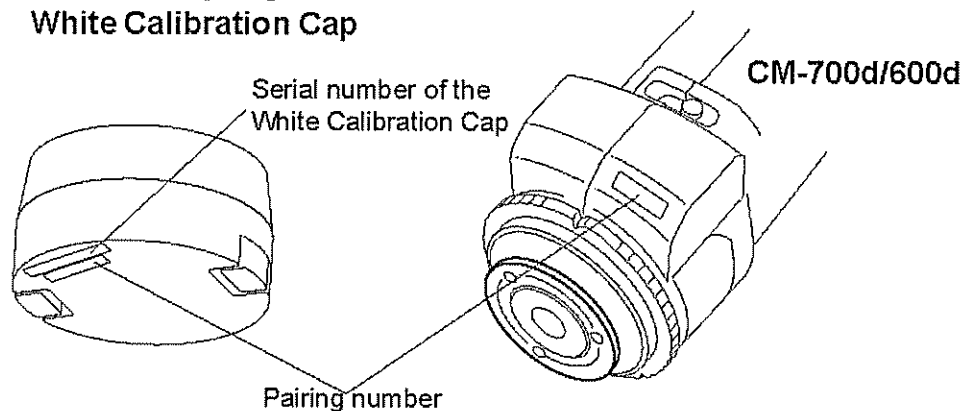

The instrument and White Calibration Cap to be used together must have the same pairing number.

Chapter 2



Preparation for Measurement

Flow of Measurement

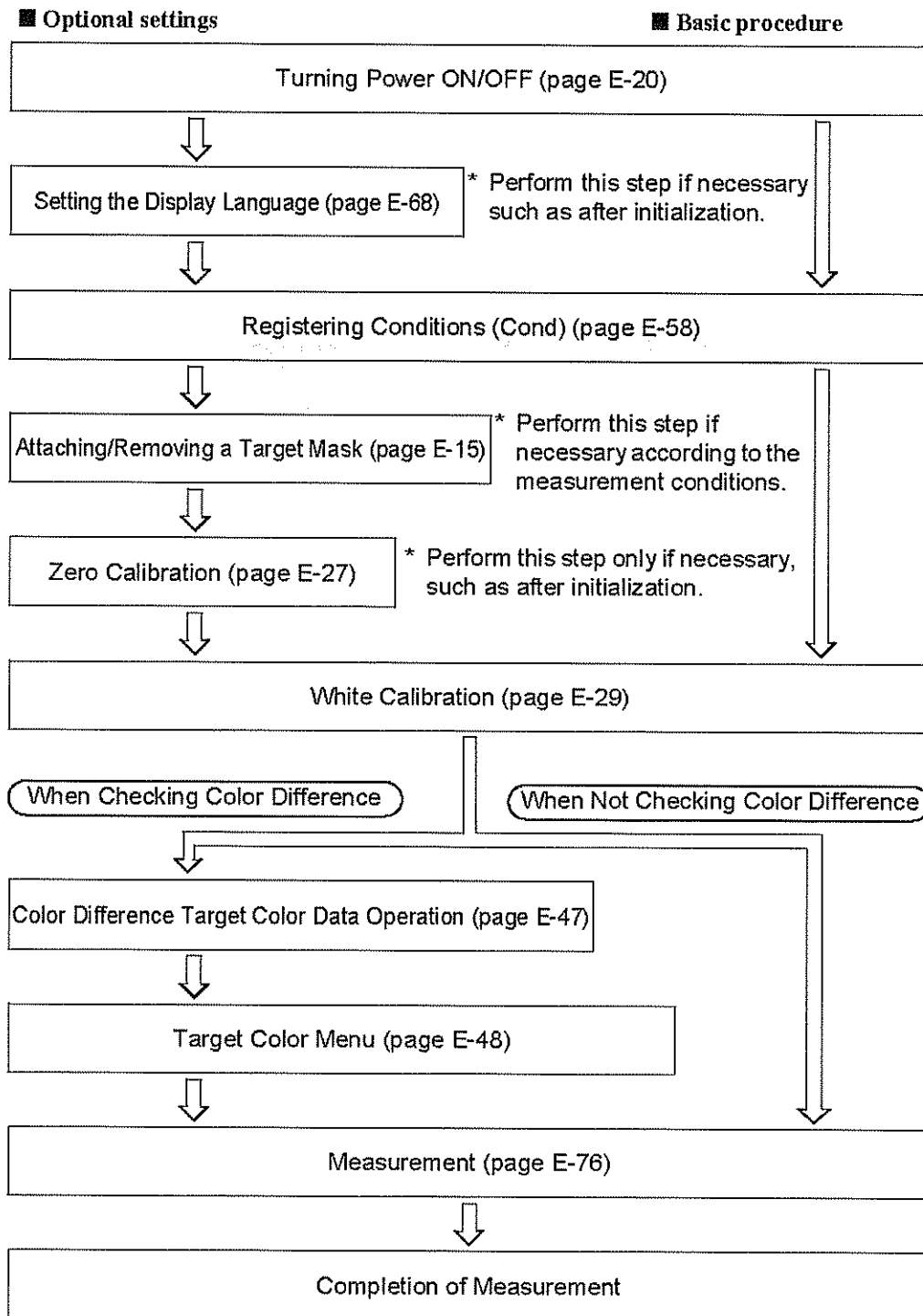

Calibration

Zero Calibration

Since the CM-700d/600d stores the data of the zero calibration performed at the factory, it is unnecessary to repeat the zero calibration every time you turn ON the instrument. However, if the measurement conditions change greatly, or if you use the optional dust cover set or Target Mask ϕ 8 mm (with glass), you need to perform zero calibration before white calibration.

[Memo]

- The effects of stray light inside the measuring part (i.e. light generated due to the flare characteristics of the optical system) will be compensated for automatically by the zero calibration data.
- The amount of stray light may change because of dust or dirt which has collected in the optical system, humidity, repeated operation, or vibration and shock exerted on the instrument. In this case, performing zero calibration periodically is recommended.
- When I + E (SCI + SCE) is specified as the specular component mode (refer to page E-43 "Mode"), clicks caused by opening and closing the optical trap may be heard during the measurement.

[Note]

- *If the instrument is not used for long periods of time, the zero calibration data stored in the instrument may be lost. If the data is lost, zero calibration must be performed again.*
- *When the instrument is used for the first time after purchase at a given measurement area setting (MAV or SAV; SAV is available on CM-700d only), zero calibration must be performed.*
- *If you performed zero calibration using the optional dust cover set or Target Mask ϕ 8 mm (with glass), you must perform zero calibration again before starting measurement using the standard Target Mask.*

[Setting Procedure]

1 Confirm the type of attached target mask and the setting of the measurement area selector of the instrument.

2 Turn the instrument ON.
The <Calibration> screen is displayed.

[Note]

Check the status icons displayed at the top of the screen to verify that the lens position (MAV/SAV) icon is correct for the measurement area selector setting and for the type of attached Target Mask.

- If a different screen is displayed, press the [CAL] button.

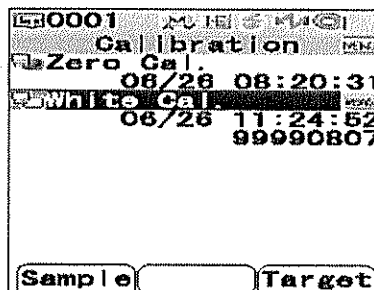

Calibration

3 Use the Δ button of the cross key to move the cursor to "Zero Cal."

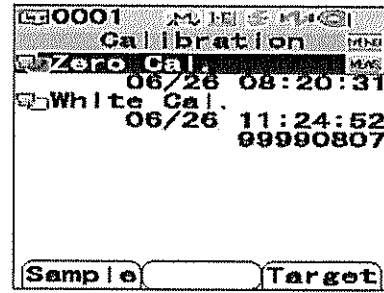

4 Direct the specimen measuring port to midair.

- Do not direct the specimen measuring port toward a light source (including illumination such as a fluorescent lamp).
- Keep the specimen measuring port more than 1 m away from any reflective items (hands, desks, walls etc.).

Memo

Use of the optional Zero Calibration Box CM-A182 ensures proper zero calibration.

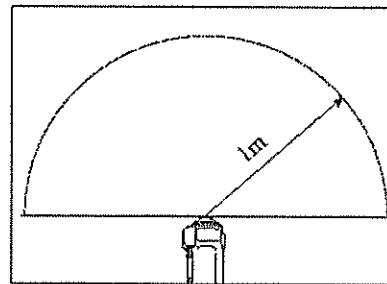

5 Make sure that ⚡ (Ready to measure) is displayed or Ready lamp is green, and then press the measuring button.

Zero calibration will be performed.

The Xe lamp flashes five times for each SCI and SCE measurement.

During zero calibration, the screen shows the number of flashes performed.

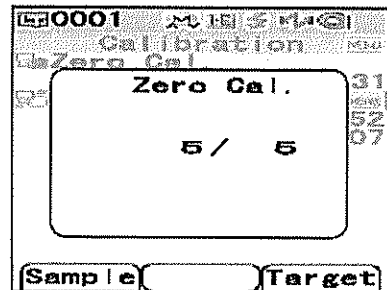

When zero calibration is finished, the screen returns to the <Calibration> screen.

Memo

When the screen is turned OFF by the power save function, press any of the measuring or control buttons to turn ON the screen, confirm that ⚡ (Ready to measure) is displayed or Ready lamp is green, and then press the measuring button.

Note

- After zero calibration finished, perform white calibration. Go to step 3 of "White Calibration" on page E-29.
- Even though you performed white calibration after turning ON the power, you need to perform it again if you performed zero calibration after the first white calibration.

White Calibration

White calibration must be performed prior to start of measurement after the power is turned ON for the first time after purchase at the current settings.

When white calibration finishes,  <white calibration completed icon> is displayed.

Once white calibration is completed, measurement is possible without white calibration when the instrument is turned ON the next time. However, the measurement result is not accurate.

[Memo]

- The calibration data for the White Calibration Cap supplied with the instrument are stored in the instrument.
- Although the white calibration results stored in the internal memory are retained even after the instrument is turned off, it is recommended that you repeat white calibration each time you switch the power back on.
- The reading may fluctuate slightly due to changes in the ambient temperature or due to heat generation caused by repeated operation of the instrument. In this case, make sure to perform white calibration regularly.
- When I + E (SCI + SCE) is specified as the specular component mode (refer to page E-43 "Mode"), clicks caused by opening and closing the optical trap may be heard during the measurement.

[Note]

- *White calibration must be performed at the same temperature as the one at which measurement will be performed.*
- *Before starting white calibration, make sure that the instrument is sufficiently acclimatized to the ambient temperature.*
- *Whenever the measurement area setting has been changed between MAV and SAV, white calibration must be performed.*

[Setting Procedure]

- 1 Confirm the type of attached target mask and the setting of the measurement area selector of the instrument.

- 2 Turn the instrument ON.

The <Calibration> screen is displayed.

[Note]

Check the status icons displayed at the top of the screen to verify that the lens position (MAV/SAV) icon is correct for the measurement area selector setting and for the type of attached Target Mask.

- If a different screen is displayed, press the [CAL] button.

[Memo]

- The <Calibration> screen shows two items: "Zero Cal." and "White Cal." The date of the last calibration is displayed under each item. If no calibration has been performed yet, "None" is displayed.
- Under "White Cal.", the serial number of the White Calibration Cap to be used for the instrument is displayed.

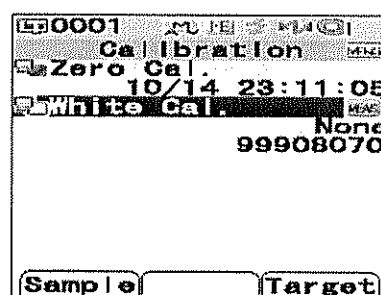

- 3 If necessary, use the ∇ button of the cross key to move the cursor to "White Cal."

Calibration

- 4 Properly attach the White Calibration Cap, which has the same pairing number as the instrument.

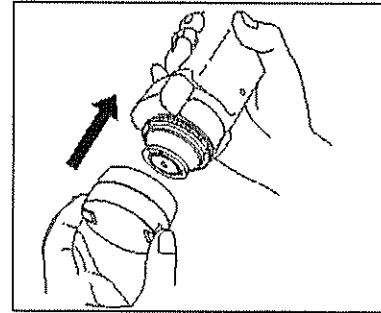

- 5 Make sure that  (Ready to measure) is displayed or Ready lamp is green, and then press the measuring button.

White calibration will be performed.

The Xe lamp flashes five times for each SCI and SCE measurement.

During white calibration, the screen shows the number of flashes performed.

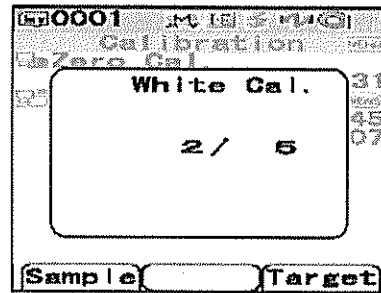

When white calibration finishes, the screen returns to the <Calibration> screen.

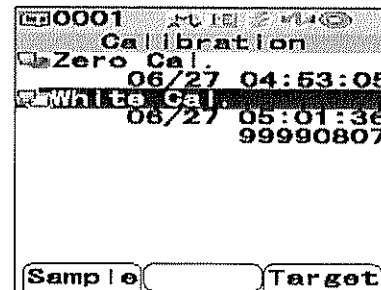

Note

The instrument contains the data for the White Calibration Cap which has the same pairing number. Therefore, you must use the instrument and corresponding White Calibration Cap for white calibration.

Memo

- If you change the measurement area or change the specular component mode from a setting other than “I + E” after white calibration, you must perform white calibration under the changed conditions.
- If you performed white calibration in “I + E” mode and then switched the mode to “SCT” or “SCE”, it is considered that white calibration has been completed and you do not need to repeat it.
- When the screen is turned OFF by the power save function, press any of the measuring or control buttons to turn ON the screen, confirm that  (Ready to measure) is displayed or Ready lamp is green, and then press the measuring button.

User Calibration

You can perform calibration by using your own reference plate and calibration data instead of the white calibration data. The calibration data for user calibration can be specified by connecting the instrument to a PC and using the optional Color Data software “SpectraMagic™ NX”.

You can select whether to use the user calibration data for measurement on the <User Cal.> screen of the instrument.

[Setting Procedure]

1 Turn the instrument ON.

The <Calibration> screen is displayed.

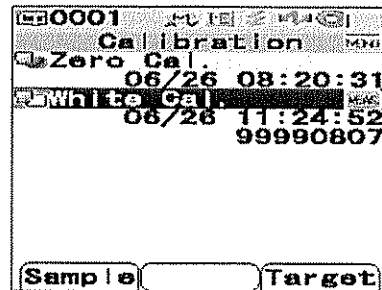

- If a different screen is displayed, press the [CAL] button.

2 Press the [MENU] button.

The <User Cal.> screen is displayed.

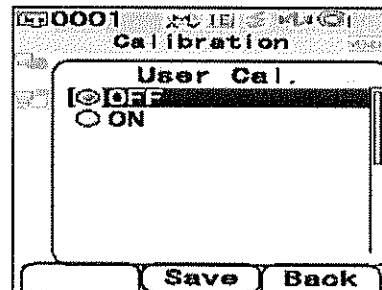

3 Use the ▾ button of the cross key to move the cursor to “ON” and then press the [SAVE/SEL] button.

Now you can perform white calibration using your own calibration data.

Note

You need to prepare user calibration data and write it to the instrument memory before you can set user calibration to ON.

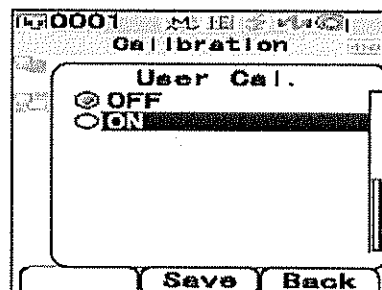

Condition Setting

The CM-700d/600d requires condition settings (display and measurement conditions) before measurement can be started.

[Memo]

To configure condition settings, select "Disp. Cond." (display conditions) or "Meas. Cond." (measurement conditions) from the <Option> screen to open an appropriate screen.

[Note]

If any predefined condition is selected, the condition setting (display/measurement conditions) is disabled. Set the condition to OFF before starting condition setting.

Setting the Display Conditions

To set the display conditions, select "Disp. Cond." on the <Option> screen.

You can select or specify the following seven items as the display conditions:

- Disp. Type: Specify items to be displayed as measurement results.
- Color Space: Select the color space to be used.
- Equation: Select the color difference formula to be used.
- Color Index: Select the index (WI, YI, etc.) to be used.
- Observer: Select the observer angle: 2° or 10°
- Illuminant 1: Select the illuminant used to measure colorimetric data.
- Illuminant 2: Select the secondary illuminant used for MI (metamerism index) calculation, etc.

[Setting Procedure]

- 1 Hold down the [MENU] button and press the ∇ button of the cross key.
The <Option> screen is displayed.

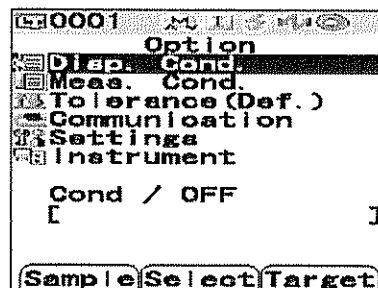

- 2 Use the Δ or ∇ button of the cross key to move the cursor to "Disp. Cond." and then press the [SAVE/SEL] button.
The <Disp. Cond.> screen is displayed.

[Note]

When setting of "Cond" is "ON" (refer to page E-58), "Disp. Cond" and "Meas. Cond" cannot be selected.

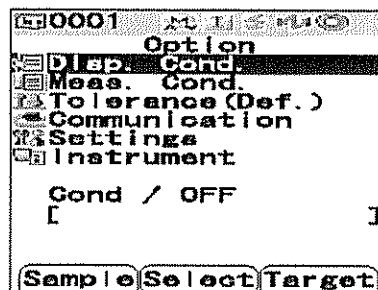

- The <Disp. Cond.> screen shows the current settings.

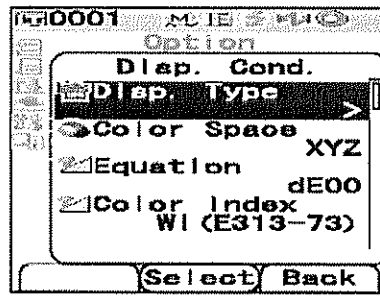

- 3 After you set the display conditions, press the [TARGET] (Back) button to return to the <Option> screen.

Disp. Type

Specify items to be displayed as measurement results.

[Setting Procedure] Start the procedure from the <Disp. Cond.> screen.

- 1 Use the Δ or ∇ button of the cross key to move the cursor to "Disp. Type." and then press the [SAVE/SEL] button.

The <Disp. Type> screen is displayed.

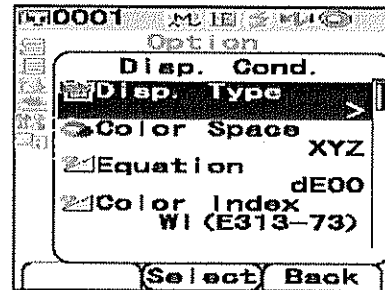

- 2 Use the Δ or ∇ button of the cross key to move the cursor to the desired item.

Memo

- Press the [SAMPLE] (Edit) button to check or uncheck the "Disp. Type" options indicated by the cursor.
- The checked option is currently selected.

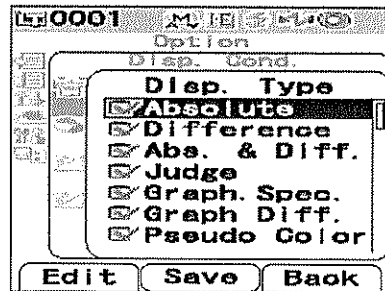

Settings

- Absolute: Display the absolute values of the colorimetric data.
- Difference: Display the color difference from the target color. The measured data which failed the pass/fail judgment based on the specified tolerances will be highlighted in red.
- Abs. & Diff.: Display the absolute value and the color difference from the target color. The measured data which failed the pass/fail judgment based on the specified tolerances will be highlighted in red.
- Judge: Perform judgment of whether the color difference from the target color is within the range of the predefined tolerances. "Pass" indicates that all the items passed the judgment, and "Fail" indicates at least one item failed the judgment.
- Graph Spec.: Display a spectral reflectance graph.
- Graph Diff.: Display a graph indicating the color difference from the target color.
- Pseudo Color: Display a pseudocolor.
- Assessments: Display deviations in hue or other factors from the target color with specific words.

The table below shows the words to be used.

$\Delta a^*/\Delta b^*/\text{Hue (h, } a^*, b^*)$		Lightness (L^*)	Chroma (C^*)
+ RED	- RED	LIGHTER	VIVID
+ GREEN	- GREEN	DARKER	DULLER
+ YELLOW	- YELLOW		
+ BLUE	- BLUE		

* When the L^*C^*h color space is selected, the color assessment is indicated in the + direction only.

* The saturation is displayed only when the L^*C^*h color space is selected.

Note

The results for "Difference", "Abs. & Diff." and "Graph Diff." will be displayed only when the target color has been specified.

3 Press the [SAVE/SEL] button.

The selection is confirmed and the screen returns to the <Disp. Cond.> screen.

Note

If you press the [TARGET] (Back) button without pressing the [SAVE/SEL] button, you return to the <Disp. Cond.> screen without changing the setting.

Color Space

Select the color space to be used.

[Setting Procedure] Start the procedure from the <Disp. Cond.> screen.

- 1 Use the Δ or ∇ button of the cross key to move the cursor to "Color Space" and then press the [SAVE/SEL] button.

The <Color Space> screen is displayed.

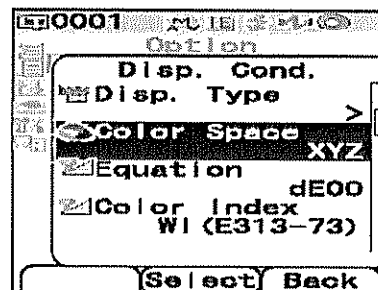

- 2 Use the Δ or ∇ button of the cross key to move the cursor to the desired item.

Settings

- L*a*b*: L*a*b* color space
- L*C*h: L*C*h color space
- Hunter Lab: Hunter Lab color space
- Yxy: Yxy color space
- XYZ: XYZ color space
- Munsell: Munsell color space

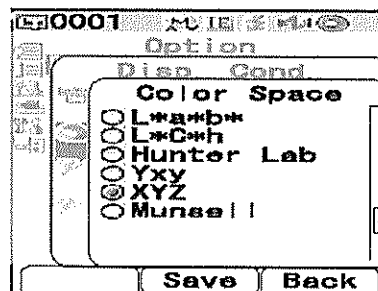

Memo

A value for Munsell is displayed only when observer 2° and illuminant "C" are selected.

- 3 Press the [SAVE/SEL] button.

The selection is confirmed and the screen returns to the <Disp. Cond.> screen.

Note

If you press the [TARGET] (Back) button without pressing the [SAVE/SEL] button, you return to the <Disp. Cond.> screen without changing the setting.

Equation

Select the color difference formula to be used.

[Setting Procedure] Start the procedure from the <Disp. Cond.> screen.

- 1 Use the Δ or ∇ button of the cross key to move the cursor to "Equation" and then press the [SAVE/SEL] button.

The <Equation> screen is displayed.

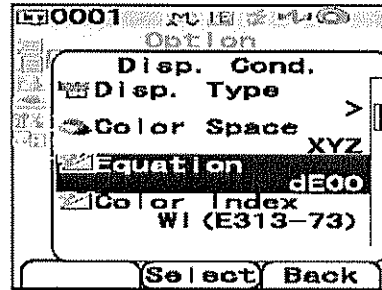

- 2 Use the Δ or ∇ button of the cross key to move the cursor to the desired item.

Settings

- dE*ab: ΔE^*ab (CIE1976) color difference formula
- CMC: CMC color difference formula
- dE*94: ΔE^*94 (CIE1994) color difference formula
- dE00: $\Delta E00$ (CIE2000) color difference formula

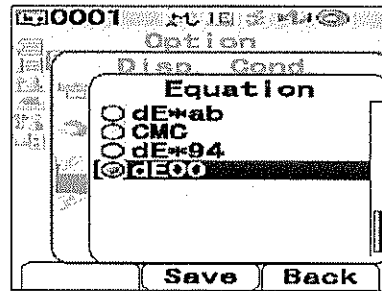

- 3 Press the [SAVE/SEL] button.

The selection is confirmed and the screen returns to the <Disp. Cond.> screen.

Note

If you press the [TARGET] (Back) button without pressing the [SAVE/SEL] button, you return to the <Disp. Cond.> screen without changing the setting.

Color Index

Select the index (WI, YI, etc.) to be used.

[Setting Procedure] Start the procedure from the <Disp. Cond.> screen.

- 1 Use the Δ or ∇ button of the cross key to move the cursor to "Color Index" and then press the [SAVE/SEL] button.

The <Color Index> screen is displayed.

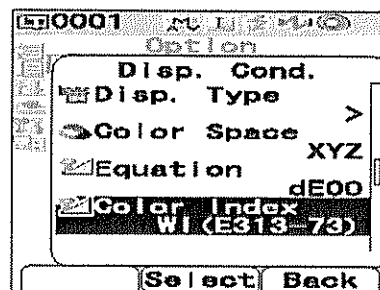

- 2 Use the Δ or ∇ button of the cross key to move the cursor to the desired item.

Settings

- None
- WI (E313-73): Whiteness index (ASTM E313-73)
- WI (E313-96): Whiteness index (ASTM E313-96)
- YI (E313-73): Yellowness index (ASTM E313-73)
- YI (D1925): Yellowness index (ASTM D1925)
- ISO Bright.: ISO Brightness
- 8° Gloss: The gloss value calculated with the specular reflection in the direction of 8°. This value can be used for relative management of glossiness.

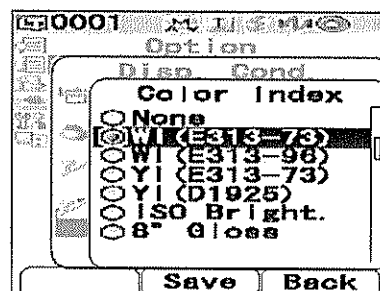

Memo

- A value for WI (E313-73) is displayed only when observer 2° and illuminant "C" are selected.
- A value for WI (E313-96) is displayed only when illuminant "C", "D50" or "D65" is selected.
- A value for YI (E313-73) is displayed only when observer 2° and illuminant "C" are selected.
- A value for YI (E313-96) is displayed only when observer 2° and illuminant "C" are selected.
- A value for 8° Gloss is displayed only when "I+E" for specular component mode is selected.

- 3 Press the [SAVE/SEL] button.

The selection is confirmed and the screen returns to the <Disp. Cond.> screen.

Note

If you press the [TARGET] (Back) button without pressing the [SAVE/SEL] button, you return to the <Disp. Cond.> screen without changing the setting.

Observer

Select the observer angle: 2° or 10°.

[Setting Procedure] Start the procedure from the <Disp. Cond.> screen.

- 1 Use the Δ or ∇ button of the cross key to move the cursor to "Observer" and then press the [SAVE/SEL] button.

The <Observer> screen is displayed.

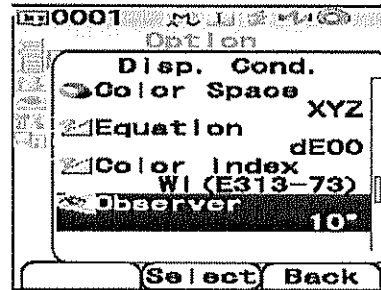

- 2 Use the Δ or ∇ button of the cross key to move the cursor to the desired item.

Settings

- 2°: 2° observer (CIE1931)
- 10°: 10° observer (CIE1964)

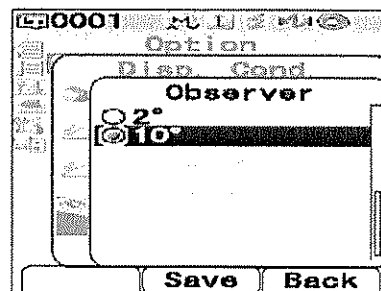

- 3 Press the [SAVE/SEL] button.

The selection is confirmed and the screen returns to the <Disp. Cond.> screen.

Note

If you press the [TARGET] (Back) button without pressing the [SAVE/SEL] button, you return to the <Disp. Cond.> screen without changing the setting.

Illuminant 1

Select the illuminant used to measure colorimetric data.

[Setting Procedure] Start the procedure from the <Disp. Cond.> screen.

- 1 Use the Δ or ∇ button of the cross key to move the cursor to "Illuminant 1" and then press the [SAVE/SEL] button.

The <Illuminant 1> screen is displayed.

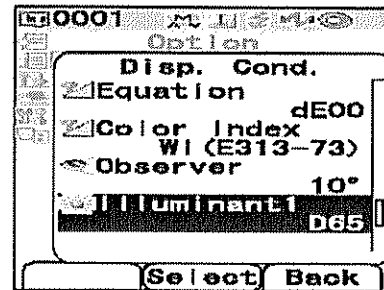

- 2 Use the Δ or ∇ button of the cross key to move the cursor to the desired item.

Settings

- A: Standard illuminant A (Incandescent lamp, Color temperature: 2856K)
- C: Illuminant C (Daylight, The relative value of the spectral distribution in the ultraviolet region is small; Color temperature: 6774K)
- D₅₀: Illuminant D₅₀ (Daylight, Color temperature: 5003K)
- D₆₅: Standard illuminant D₆₅ (Daylight, Color temperature: 6504K)
- F2: Cool white (fluorescent lamp)
- F6: Cool white (fluorescent lamp)
- F7: Color rendering A daylight white (fluorescent lamp)
- F8: Color rendering AAA natural white (fluorescent lamp)
- F10: 3-band type natural white (fluorescent lamp)
- F11: 3-band type cool white (fluorescent lamp)
- F12: 3-band type warm white (fluorescent lamp)

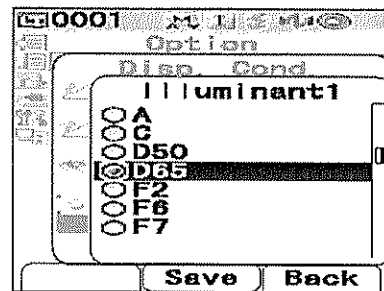

- 3 Press the [SAVE/SEL] button.

The selection is confirmed and the screen returns to the <Disp. Cond.> screen.

INote

If you press the [TARGET] (Back) button without pressing the [SAVE/SEL] button, you return to the <Disp. Cond.> screen without changing the setting.

Illuminant 2

Select the secondary illuminant used for MI (metamerism index) calculation, etc.

[Setting Procedure] Start the procedure from the <Disp. Cond.> screen.

- 1 Use the Δ or ∇ button of the cross key to move the cursor to "Illuminant 2" and then press the [SAVE/SEL] button.

The <Illuminant 2> screen is displayed.

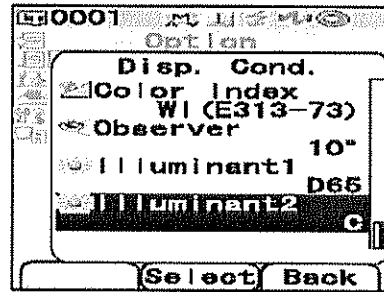

- 2 Use the Δ or ∇ button of the cross key to move the cursor to the desired item.

Settings

- The setting values are the same as those for "Illuminant 1" and "None".

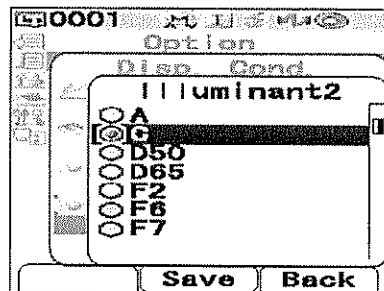

- 3 Press the [SAVE/SEL] button.

The selection is confirmed and the screen returns to the <Disp. Cond.> screen.

Note

If you press the [TARGET] (Back) button without pressing the [SAVE/SEL] button, you return to the <Disp. Cond.> screen without changing the setting.

Setting the Measurement Conditions

To set measurement conditions, select "Meas. Cond." from the <Option> screen.

You can select or specify the following four items as the measurement conditions:

- Mode: Select the specular component mode.
- Wait Time: Specify the delay between the press of the measuring button and the flash of the lamp.
- Auto Ave.: Specify the number of measurements for auto averaging.
- Manual Ave.: Specify the number of measurements for manual averaging.

[Setting Procedure]

- 1 Hold down the [MENU] button and press the ∇ button of the cross key.

The <Option> screen is displayed.

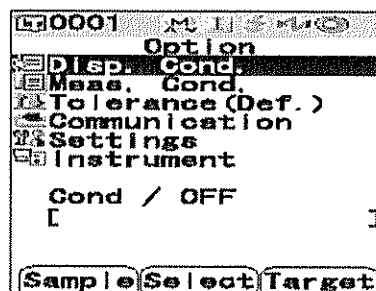

- 2 Use the Δ or ∇ button of the cross key to move the cursor to "Meas. Cond." and then press the [SAVE/SEL] button.

The <Meas. Cond.> screen is displayed.

Note

When setting of "Cond" is "ON" (refer to page E-58), "Disp. Cond" and "Meas. Cond" cannot be selected.

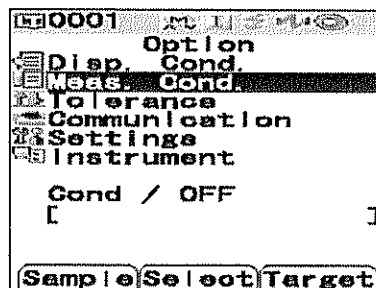

- The <Meas. Cond.> screen shows the current settings.

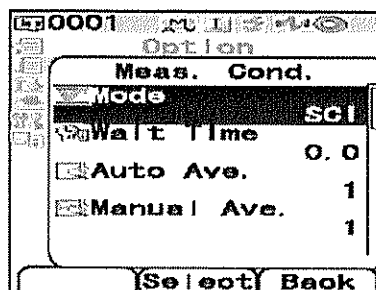

- 3 After you set the measurement conditions, press the [TARGET] (Back) button to return to the <Option> screen.

Mode

Select the specular component mode.

[Setting Procedure] Start the procedure from the <Meas. Cond.> screen.

- 1 Use the Δ or ∇ button of the cross key to move the cursor to "Mode" and then press the [SAVE/SEL] button.

The <Mode> screen is displayed.

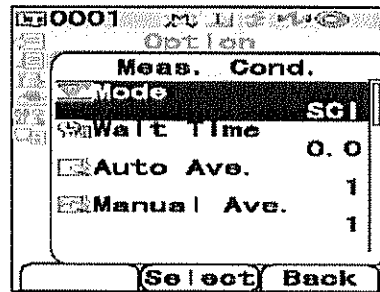

- 2 Use the Δ or ∇ button of the cross key to move the cursor to the desired item.

Settings

- SCI: Specular component included
- SCE: Specular component excluded
- SCI+SCE: Automatic SCI/SCE switching

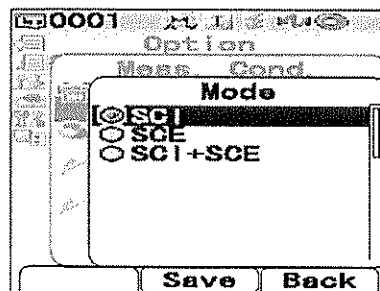

- 3 Press the [SAVE/SEL] button.

The selection is confirmed and the screen returns to the <Meas. Cond.> screen.

Note

If you press the [TARGET] (Back) button without pressing the [SAVE/SEL] button, you return to the <Meas. Cond.> screen without changing the setting.

Wait Time

Specify the delay between the press of the measuring button and the flash of the lamp.

[Setting Procedure] Start the procedure from the <Meas. Cond.> screen.

- 1 Use the Δ or ∇ button of the cross key to move the cursor to "Wait Time" and then press the [SAVE/SEL] button.

The <Wait Time> screen is displayed.

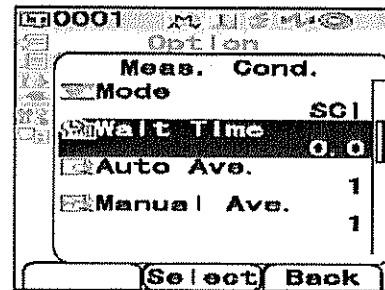

- 2 Use the Δ or ∇ button of the cross key to specify a value.

- Use the \triangleleft or \triangleright button of the cross key to move the cursor to the digit on the left or right.

Setting

○Sec. [0.0 to 3.0]:

To eliminate the influence of instrument shake, provide a period between the press of the measuring button and the flash of the lamp for measurement in increments of 0.1 seconds. When 0.0 seconds is specified, measurement starts immediately.

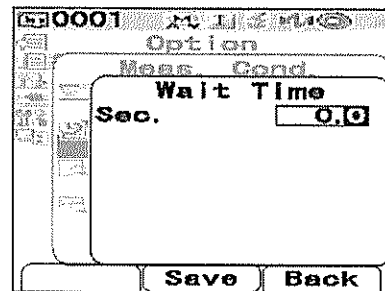

- 3 Press the [SAVE/SEL] button.

The selection is confirmed and the screen returns to the <Meas. Cond.> screen.

Note

If you press the [TARGET] (Back) button without pressing the [SAVE/SEL] button, you return to the <Meas. Cond.> screen without changing the setting.

Auto Averaging (Auto Ave.)

Specify the number of measurements for auto averaging.

[Setting Procedure] Start the procedure from the <Meas. Cond.> screen.

- 1 Use the Δ or ∇ button of the cross key to move the cursor to "Auto Ave." and then press the [SAVE/SEL] button.

The <Auto Ave.> screen is displayed.

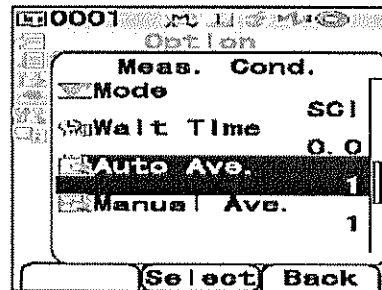

- 2 Use the Δ or ∇ button of the cross key to specify a value.

- Use the \triangleleft or \triangleright button of the cross key to move the cursor to the digit on the left or right.

Setting

- Times [1 to 10]: Specify the number of measurements, from 1 to 10, to perform when using auto averaging.

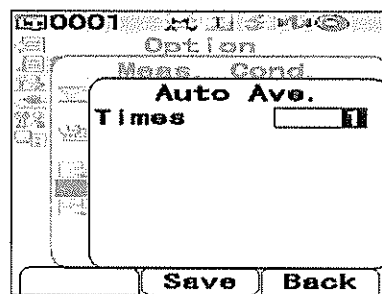

- 3 Press the [SAVE/SEL] button.

The selection is confirmed and the screen returns to the <Meas. Cond.> screen.

Note

If you press the [TARGET] (Back) button without pressing the [SAVE/SEL] button, you return to the <Meas. Cond.> screen without changing the setting.

Manual Averaging (Manual Ave.)

Specify the number of measurements for manual averaging.

[Setting Procedure] Start the procedure from the <Meas. Cond.> screen.

- 1 Use the Δ or ∇ button of the cross key to move the cursor to "Manual Ave." and then press the [SAVE/SEL] button.

The <Manual Ave.> screen is displayed.

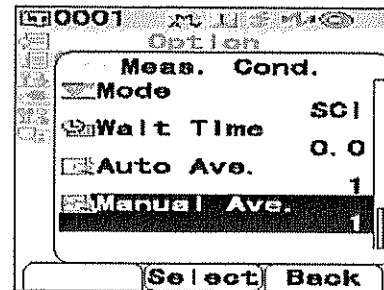

- 2 Use the Δ or ∇ button of the cross key to specify a value.

- Use the \triangleleft or \triangleright button of the cross key to move the cursor to the digit on the left or right.

Setting

- Times [1 to 30]: Specify the number of measurements, from 1 to 30, to perform when using manual averaging.

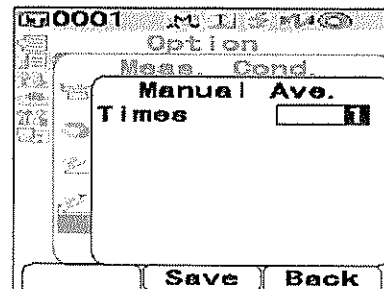

- 3 Press the [SAVE/SEL] button.

The selection is confirmed and the screen returns to the <Meas. Cond.> screen.

Note

If you press the [TARGET] (Back) button without pressing the [SAVE/SEL] button, you return to the <Meas. Cond.> screen without changing the setting.

Color Difference Target Color Data Operation

Setting a Target Color

To measure the color difference between two specimens, the color of one of the specimens must be set as the target color. The CM-700d/600d can store up to 1,000 target colors. When using the instrument alone, measure a target specimen by following the procedure below and set the result as the target color.

[Memo]

- Target colors are stored with setting numbers from 0001 to 1000 being assigned. Even when the data at some midpoint is deleted, these setting numbers do not change. It is useful to group data by assigning numbers of specific digits.
- The color difference tolerances used for pass/fail judgment are generally set for each target color. Consequently, you can set the tolerances using the menu of a target color.
- To set more accurate target color data, use averaging to measure the target specimen. For details, refer to "Average Measurement" on page E-92.

[Note]

- *Be sure to perform white calibration before setting target colors.*
- *To ensure measurement accuracy, make sure to keep ambient conditions (temperature, etc.) constant.*

[Setting Procedure]

1 Press the [TARGET] button.

The <Target> screen is displayed.

- Pressing the [SAVE/SEL] (List/Detail) button switches the screen between detail display and list display.

2 Use the Δ or ∇ button of the cross key to move the cursor to a desired target color No.

[Note]

Unlike measured data, the numbers assigned to target color data do not change automatically. When you measure colors continuously to set target colors, you need to move the cursor manually to set each data.

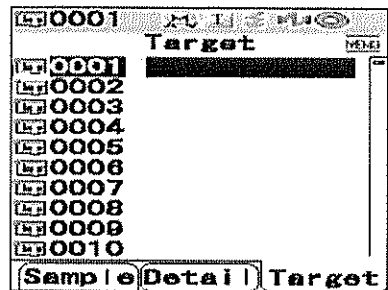
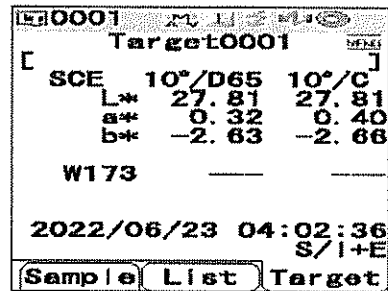

- 3** Place the specimen measuring port on the specimen.

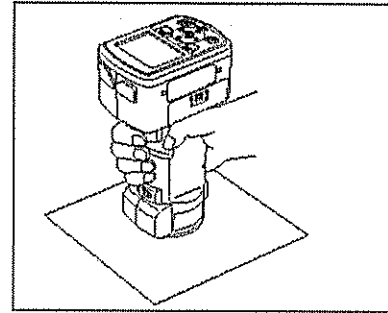

- 4** Make sure that  (Ready to measure) is displayed or Ready lamp is green, and then press the measuring button.

The specimen is measured and the result is displayed on the screen.

- When Scan Name is set to “Auto Scan” (refer to page E-53 “Scan Name”), the <Scan Name> screen is displayed. The bar code scanner reads a name, and the name is set as the name of the target color data.

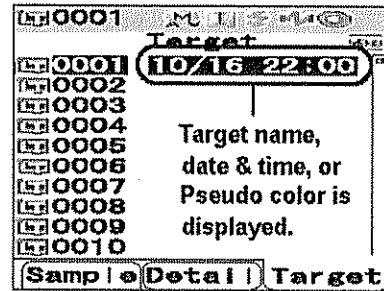

Note

If you selected a number to which target color data has already been set, a message is displayed to confirm overwriting.

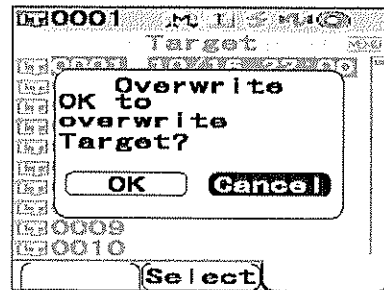

- 5** To set more target colors, repeat steps 2 to 4.

Target Color Menu

The target color menu allows the following operations for target color data.

- Print: Print the target color data. This option can be selected only when a printer has been connected.
- Delete: Delete the target color data.
- Tolerance: Specify the tolerance (box tolerance) used for pass/fail judgment of measured data.
- Edit Name: Name the target color data.
- Scan Name: The “name” of the target color data is read with a Bluetooth bar code scanner and is set as the data name.
- List: Specify the columns displayed for each target color No. in the list.
- Data Protect: Disable the deletion of the target color data. When Data Protect is specified, “Delete” and “Delete All” in the <Menu> screen cannot be selected.
- Delete All: Delete all the target color data except for protected data.

[Setting Procedure]

- 1 From the <Target> screen, press the [MENU] button.

The <Menu> screen is displayed.

- 2 Use the Δ or ∇ button of the cross key to move the cursor to the item to select or execute, and then press the [SAVE/SEL] button.

The setting screen for the selected item is displayed.

For the setting procedure of each item, refer to the following sections.

- 3 To return to the <Target> screen, press the [MENU] button while the <Menu> screen is displayed.

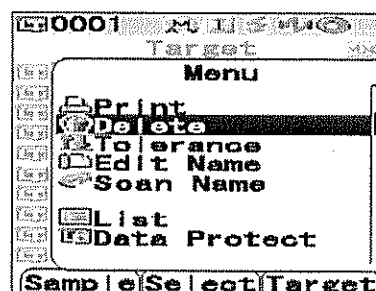

Print

Print the target color data.

You need to establish a connection between the instrument and a Bluetooth printer in advance.

Note

- If proper connection is not established, you cannot select "Print" on the <Menu> screen.
- Even if the connection has been established, printing may fail for reasons such as, the printer is turned off when printing is attempted.

[Setting Procedure] Start the procedure from the <Menu> screen of the <Target> screen.

- 1 Use the Δ or ∇ button of the cross key to move the cursor to "Print".

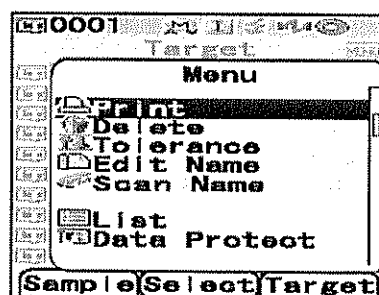

- 2 Press the [SAVE/SEL] button. The <Print> screen is displayed and the data is printed from the connected printer.

- When the printing is complete, the screen returns to the <Target> screen.

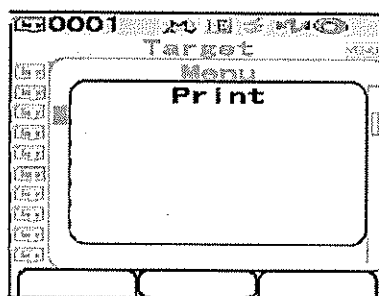

Delete

Delete the target color data.

Note

When the data is protected, you cannot select "Delete" on the <Menu> screen.

[Setting Procedure] Start the procedure from the <Menu> screen of the <Target> screen.

- 1 Use the Δ or ∇ button of the cross key to move the cursor to "Delete" and then press the [SAVE/SEL] button.

The <Delete> screen is displayed.

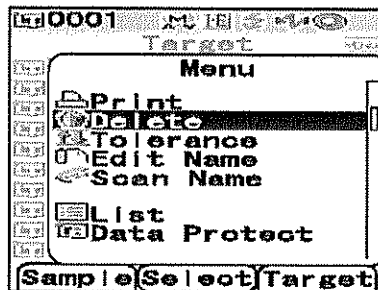

- 2 Use the \leftarrow button of the cross key to move the cursor to "OK" and press the [SAVE/SEL] button, and the data is deleted.

- When the deletion is complete, the screen returns to the <Target> screen.
- When you place the cursor on "Cancel" and press the [SAVE/SEL] button, the deletion is canceled and the screen returns to the <Target> screen.

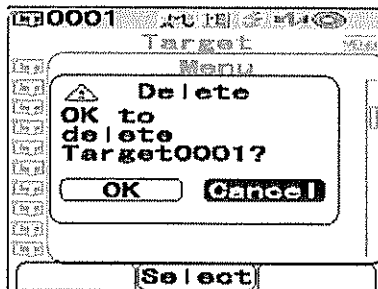

Tolerance (Box Tolerance) Setting

Specify the tolerance (box tolerance) used for pass/fail judgment of measured data to each target color.

Memo

- Before you set tolerance to each target color, the default tolerance selected for the measurement is set (factory setting: No. 01). For details, refer to page E-61 "Setting the Default Color Difference Tolerance (Tolerance (Def.))".
- With the optional Color Data Software "SpectraMagic™ NX", you can set or use the color difference tolerance easily.

Note

The items which can be set as tolerance settings are the items for the currently selected default tolerance registration number (initial setting at time of shipment: registration 01). Even if the display conditions (such as color space or color difference equation, index, etc.) are changed, the tolerance setting items will not be changed. If it is desired to change the tolerance setting items, after changing the display conditions, it is necessary to create new tolerance settings in the Tolerance (Def.) screen.

[Setting Procedure] Start the procedure from the <Menu> screen of the <Target> screen.

- 1 Use the Δ or ∇ button of the cross key to move the cursor to "Tolerance" and then press the [SAVE/SEL] button.

The <Tolerance> screen is displayed.

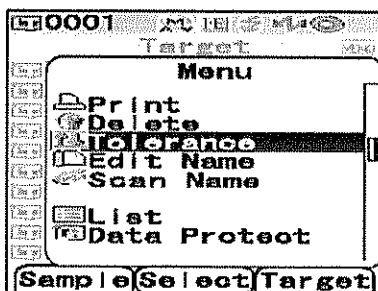

2 Use the Δ or ∇ button of the cross key to move the cursor to the desired item.

Memo

- If $\blacktriangleleft/\blacktriangleright$ is displayed at the top of the screen, you can use the \triangleleft or \triangleright button of the cross key to change the combination of the specular component mode and illuminant used for the screen display.
- If $\blacktriangle/\blacktriangledown$ is displayed on the left side/end of the screen, you can use the Δ or ∇ button of the cross key to scroll the display screen upward or downward.

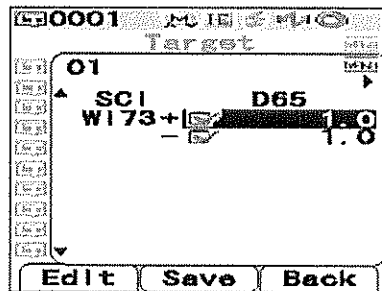
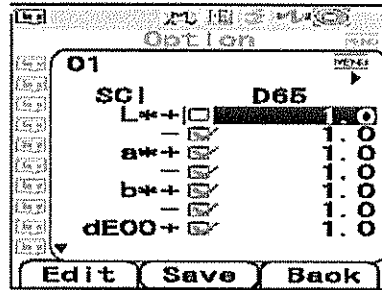
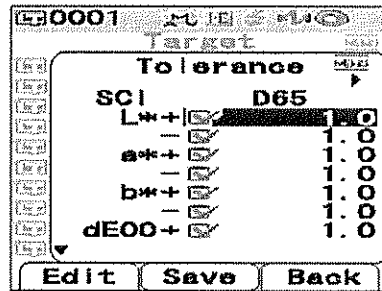

3 Press the [SAMPLE] (Edit) button and change the setting.

- When you select an item which is currently checked and press the [SAMPLE] (Edit) button, the check mark is cleared. When you press the [SAMPLE] (Edit) button again, the cursor moves to the setting value. Use the Δ or ∇ button of the cross key to change the value.
- When you select an item which is not currently checked and press the [SAMPLE] (Edit) button, the cursor moves directly to the setting value. Use the Δ or ∇ button of the cross key to change the value.
- To set each parameter l, c and h for CMC, ΔE^*94 and $\Delta E00$, place the cursor on the item and press the [SAMPLE] (Edit) button, and the cursor moves to the value of the item. Press the Δ or ∇ button of the cross key to change the value.

Memo

You can move the cursor between the digits of the value by pressing the \triangleleft or \triangleright button of the cross key.

Settings

○ ± 0.0 to 20.0

* Settings of each parameter l, c and h for CMC, ΔE^*94 and $\Delta E00$ are 0.00 to 9.99.

- You need to press the [SAVE/SEL] (OK) button to confirm the change every time you change the setting of an item.

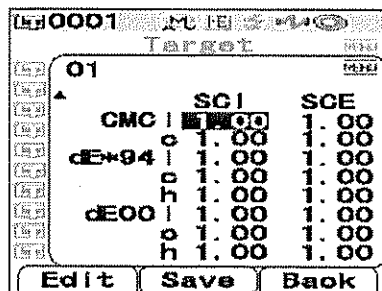

- 4** When all items have been set, press the [SAVE/SEL] button.
The settings are confirmed and the screen returns to the <Target> screen.

Note

If you press the [TARGET] (Back) button without pressing the [SAVE/SEL] button, you return to the <Target> screen without changing the settings.

Edit Name

Name the target color data.

[Setting Procedure] Start the procedure from the <Menu> screen of the <Target> screen.

- 1** Use the Δ or ∇ button of the cross key to move the cursor to "Edit Name" and then press the [SAVE/SEL] button.
The <Edit Name> screen is displayed.

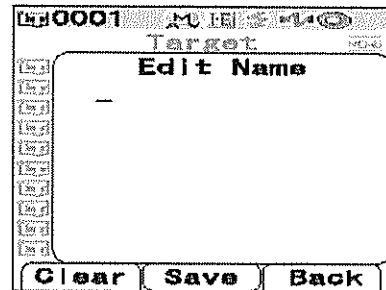
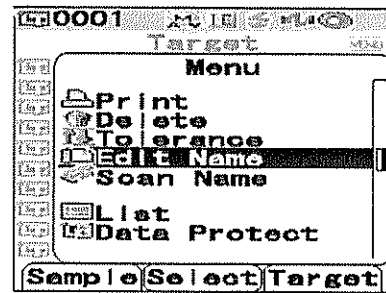

- 2** Use the \leftarrow or \rightarrow button of the cross key to move the cursor, and use the Δ or ∇ button to change the letter.
- Use the \leftarrow button of the cross key to move the cursor backward to correct letters.
 - Pressing the [SAMPLE] (Clear) button clears all letters.
 - Up to 11 characters can be used.

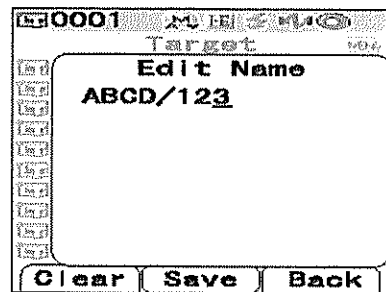

- The available letters are upper/lower-case alphabets, symbols, numbers (0 to 9), and a space.

Available symbols										
!	"	#	\$	%	&	'	()	*	+
,	-	.	/	:	;	<	=	>	?	@
[¥]	^	_	'	(}		

- 3** When you have entered the name, press the [SAVE/SEL] button.
The screen returns to the <Target> screen.

Scan Name

You can scan a “name” of the target color data with a Bluetooth bar code scanner and set it as the data name.

- First, you need to establish the Bluetooth connection between the instrument and bar code scanner.
- There are two methods of the Scan Name function: “Auto Scan” and “Manual Scan”.
 - Auto Scan: The bar code scanner automatically reads a “name” for each measurement.
 - Manual Scan: The user invokes “Scan Name” from the <Menu> screen and reads a “name” with the bar code scanner.

Memo

- For the method of establishing the Bluetooth connection with the bar code scanner, refer to page E-111 “Connecting a Bar Code Scanner”.
- For the method of switching between Auto Scan and Manual Scan, refer to page E-116 “Setting Auto Scan”.

Note

- *If the Bluetooth connection is improper, “Scan Name” cannot be selected on the <Menu> screen.*
- *Although the Bluetooth connection is established, the input may be disabled in the case when the Scan Name operation is attempted while the bar code scanner is turned off.*

When Auto Scan is Set

When the Scan Name method is set to “Auto Scan”, the bar code scanner automatically reads a “name” for each measurement.

Memo

- Pressing the [Cancel] (Back) button cancels the name reading.

Note

When the bar code scanner fails reading a name, an error message appears to prompt the user to read the name with “Manual Scan”.

Memo

For instructions of the Manual Scan, refer to page E-54 “When Manual Scan is Set”.

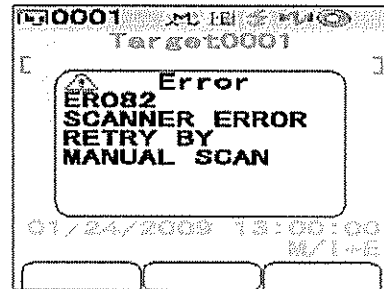
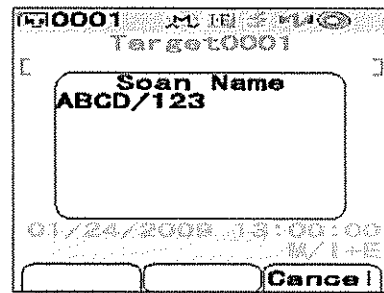

When Manual Scan Is Set

When the Scan Name method is set to “Manual Scan”, follow the procedure below to read a “name” with the bar code scanner.

[Operating Procedure] Start the procedure from the <Menu> screen of the <Target> screen.

- 1 Use the Δ or ∇ button of the cross key to move the cursor to “Scan Name” and then press the [SAVE/SEL] button.

The <Scan Name> screen is displayed.

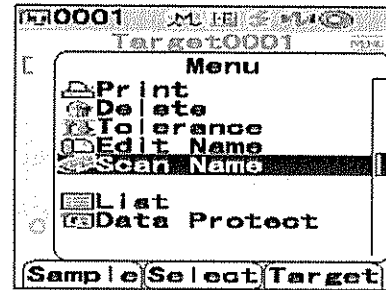

Read “name” data with the bar code scanner.

[Memo]

- Pressing the [Cancel] (Back) button cancels the name reading.

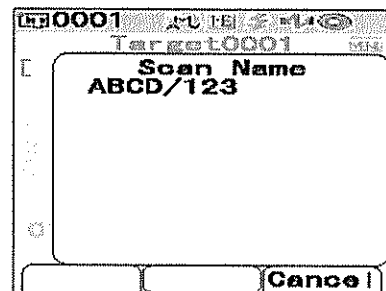

[Note]

- When the bar code scanner fails reading a name, an error message appears to prompt the user to invoke the manual scan to read the name again.
- Although the Bluetooth connection is established, the input may be disabled in the case when the Scan Name operation is attempted while the bar code scanner is turned off.

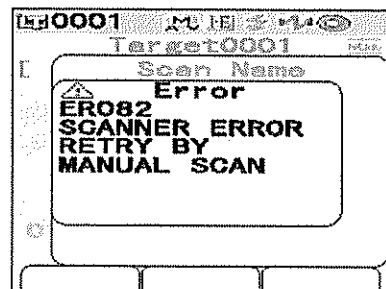

Setting the List (List)

Specify the column displayed for each target color No. in the list.

[Setting Procedure] Start the procedure from the <Menu> screen of the <Target> screen.

- 1 Use the Δ or ∇ button of the cross key to move the cursor to "List" and then press the [SAVE/SEL] button.

The <List> screen is displayed.

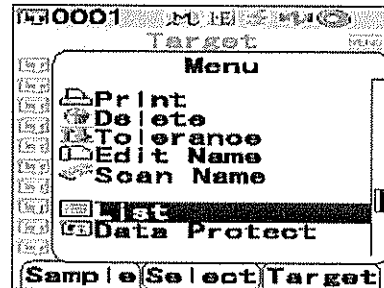

- 2 Use the Δ or ∇ button of the cross key to move the cursor to the desired item.

Settings

- Name: Display the name specified with Edit Name in the list.
- Date&Time: Display the date and time of the measurement in the list.
- Pseudo Color: Display the pseudocolor in the list.

- 3 Press the [SAVE/SEL] button.

The settings are confirmed and the screen returns to the <Target> screen.

Note

If you press the [TARGET] (Back) button without pressing the [SAVE/SEL] button, you return to the <Target> screen without changing the settings.

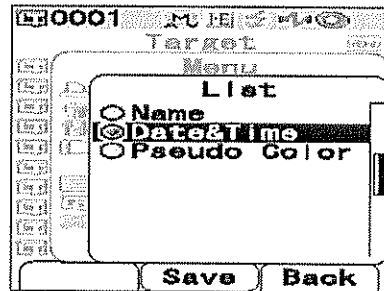

Data Protection

You can specify data protection so that the saved target color setting will not be deleted by accident. When the data protection is specified, "Delete" and "Delete All" in the <Menu> screen cannot be selected.

[Setting Procedure] Start the procedure from the <Menu> screen of the <Target> screen.

- 1 Use the Δ or ∇ button of the cross key to move the cursor to "Data Protect" and then press the [SAVE/SEL] button.

The <Data Protect> screen is displayed.

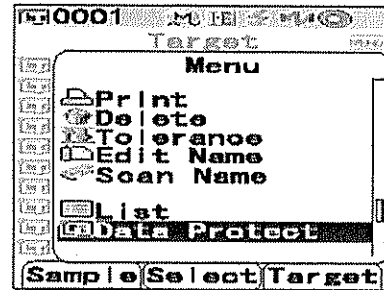

- 2 Use the Δ or ∇ button of the cross key to move the cursor to the desired item.

Settings

ON: Protect the data.

OFF: Do not protect the data.

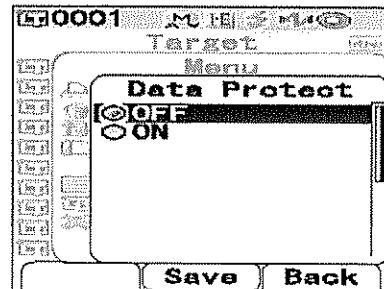

- 3 Press the [SAVE/SEL] button.

The settings are confirmed and the screen returns to the <Target> screen.

Note

If you press the [TARGET] (Back) button without pressing the [SAVE/SEL] button, you return to the <Target> screen without changing the settings.

Delete All

Delete all the target color data which have been set.

Note

When the data is protected, you cannot select "Delete All" on the <Menu> screen.

[Setting Procedure] Start the procedure from the <Menu> screen of the <Target> screen.

- 1 Use the Δ or ∇ button of the cross key to move the cursor to "Delete All" and then press the [SAVE/SEL] button.

The <Delete All> screen is displayed.

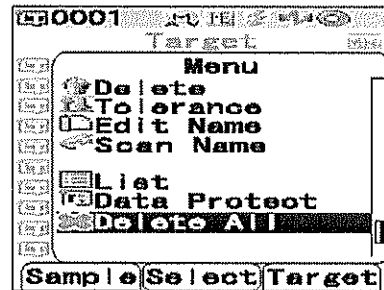

- 2 Use the \triangleleft button of the cross key to move the cursor to "OK" and press the [SAVE/SEL] button, and all of the data is deleted.

- When the deletion is complete, the screen returns to the <Target> screen.
- When you place the cursor on "Cancel" and press the [SAVE/SEL] button, the deletion is canceled and the screen returns to the <Target> screen.

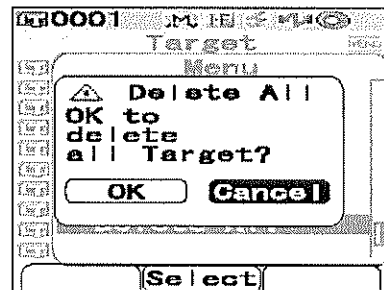

Registering Conditions (Cond)

The CM-700d/600d allows registration of up to 8 conditions (display and measurement conditions) in advance.

You can display measurement results under desired conditions by switching registered conditions stored as "Cond 01 to 08".

Note

When "Cond" is ON (When one of Cond 01 to 08 is selected), you cannot set the display and measurement conditions with the <Option> screen.

Memo

To register conditions, select one of Cond 01 to 08 before setting details. When Cond is OFF (normal condition setting), the settings are not saved.

[Setting Procedure]

- 1 Hold down the [MENU] button and press the ∇ button of the cross key.

The <Option> screen is displayed.

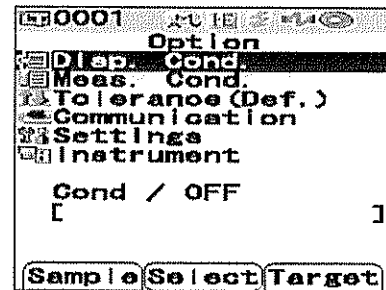

- 2 Use the ∇ button of the cross key to move the cursor to "Cond/OFF" and then press the [SAVE/SEL] button.

The <Cond> screen is displayed.

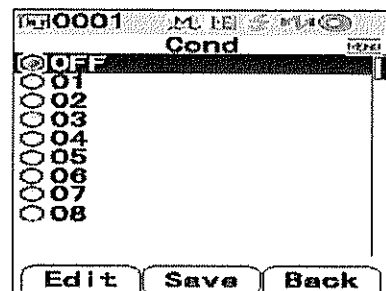
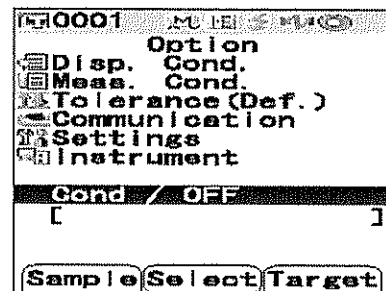

- 3** Use the Δ or ∇ button of the cross key to move the cursor to the desired registration number (01 to 08), and then press the [SAMPLE] (Edit) button.

A screen used to select the display conditions for the selected registration number is displayed.

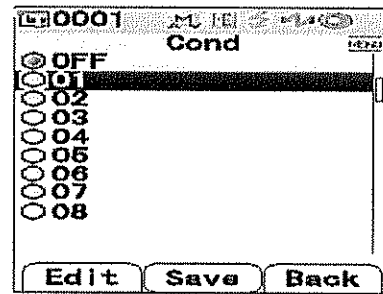

- 4** Use the Δ or ∇ button of the cross key to move the cursor to a desired item and then press the [SAVE/SEL] button.

[Memo]

For the setting procedure and details of the items, refer to page E-32 "Condition Setting".

Settings

- Mode: Select the mode to process specular components.
- Wait Time: Specify the delay between the press of the measuring button and the flash of the lamp.
- Auto Ave.: Specify the number of measurements for auto averaging.
- Manual Ave.: Specify the number of measurements for manual averaging.
- Disp. Type: Specify items to be displayed as measurement results.
- Color Space: Select the color space to be used.
- Equation: Select the color difference formula to be used.
- Color Index: Select the index (WI, YI, etc.) to be used.
- Observer: Select the observer angle from 2° or 10°.
- Illuminant 1: Select the illuminant used to measure colorimetric data.
- Illuminant 2: Select the secondary illuminant used for MI (metamerism index) calculation, etc.

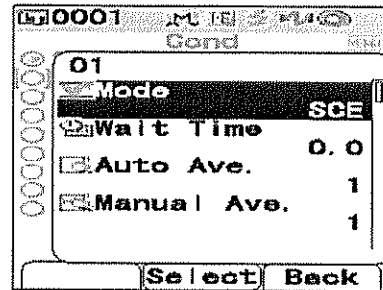

- 5** When the setting is complete, press the [TARGET] (Back) button.

The screen returns to the <Cond> screen.

[Memo]

To set two or more conditions, repeat steps 3 and 4.

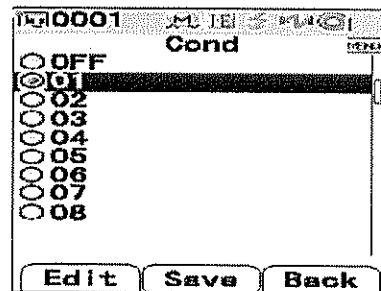

- 6** Use the Δ or ∇ button of the cross key to move the cursor to the desired registration number (OFF or 01 to 08), and then press the [SAVE/SEL] button.

The selection is confirmed and the screen returns to the <Option> screen.

[Memo]

- When the condition has a name, it is displayed on the next line of the registration No. of the condition (enclosed in []).
- For the method of naming conditions, refer to page E-60 "Naming a Condition".

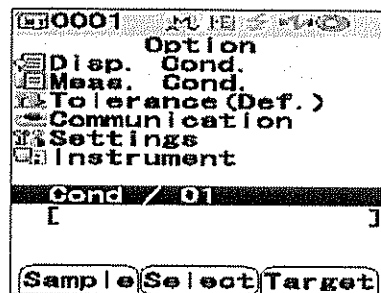

Naming a Condition

You can name a condition for easier management.

[Setting Procedure]

- 1 From the <Cond> screen, press the [MENU] button.

The <Menu> screen is displayed.

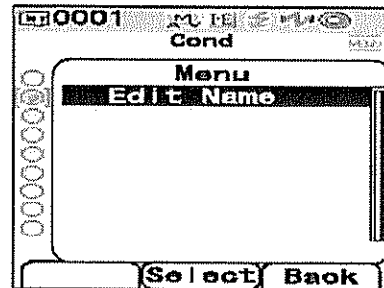

- 2 Make sure that "Edit Name" is selected, and then press the [SAVE/SEL] button.

The <Edit Name> screen is displayed.

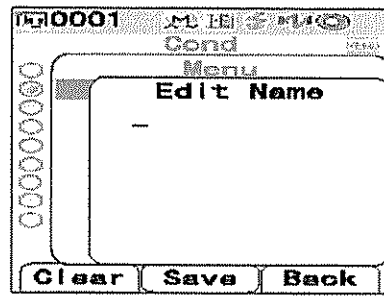

- 3 Use the < or > button of the cross key to move the cursor, and use the Δ or ▽ button to change the letter.

- Use the < button of the cross key to move the cursor backward to correct letters.
- Pressing the [SAMPLE] (Clear) button clears all letters.
- Up to 11 characters can be used.
- The available letters are upper/lower-case alphabets, symbols, numbers (0 to 9), and a space.

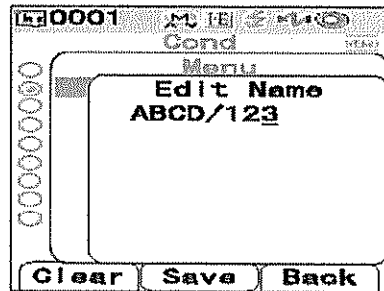

Available symbols										
!	"	#	\$	%	&	'	()	*	+
,	-	.	/	:	;	<	=	>	?	@
[¥]	^	_	'	{		}		

- 4 When you finish entering letters, press the [SAVE/SEL] button.

The screen returns to the <Cond> screen.

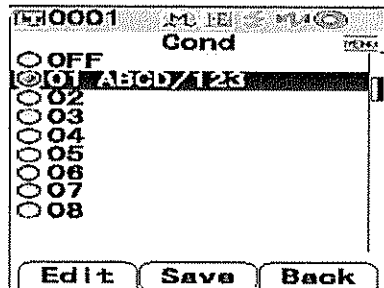

Setting the Default Color Difference Tolerance (Tolerance (Def.))

With the CM-700d/600d, you can preset and save tolerances which do not depend on the target color data as default values. During measurement, just selecting the tolerance No. allows automatic judgment using the target colors and tolerances.

[Memo]

- If tolerances for each target color have not been set, the tolerance setting for the registration number selected during measurement (initial value: 01) is used as the tolerance setting for each target color.
- Up to 8 default tolerance settings can be specified to registration numbers 01 to 08. Tolerances have been factory-set to registration number 01 only. You need to set tolerances for registration numbers 02 to 08 as necessary.
- With the optional Color Data Software "SpectraMagic™ NX", you can set or use the color difference tolerance easily.

[Note]

Registration 01 for tolerance settings is set as the initial setting at the time of shipment from the factory, and contains default settings for tolerance items. Even if the display conditions (such as color space or color difference equation, index, etc.) are changed, the tolerance setting items will not be automatically changed. If it is desired to set tolerance values according to the currently set display conditions, either delete the currently set tolerance settings and then create new tolerance settings, or create new tolerance settings for a registration number for which tolerances have not yet been set and select that registration number.

[Setting Procedure]

- 1 Hold down the [MENU] button and press the ▽ button of the cross key.

The <Option> screen is displayed.

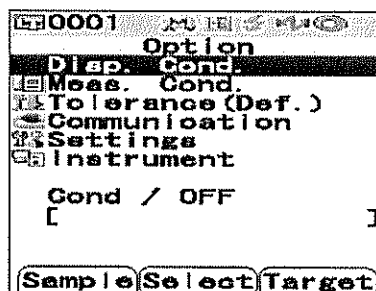

- 2 Use the ▲ or ▼ button of the cross key to move the cursor to "Tolerance(Def.)" and then press the [SAVE/SEL] button.

The <Tolerance(Def.)> screen is displayed.

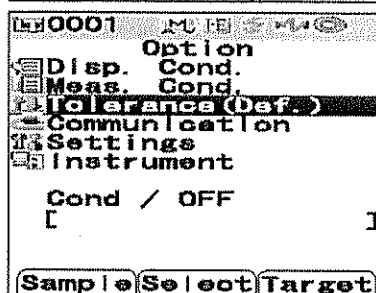

Setting the Default Color Difference Tolerance (Tolerance (Def.))

- 3 Use the Δ or ∇ button of the cross key to move the cursor to the desired registration number (01 to 08).

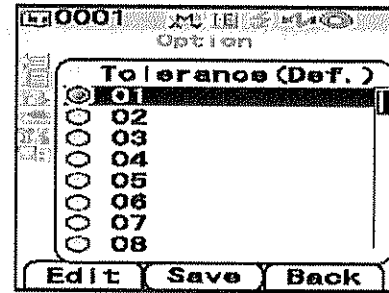

- 4 Press the [SAMPLE] (Edit) button.

A screen used to set tolerances for the selected registration number is displayed.

MEMO

- If registration number 01 (initial setting) is selected, or if you select a number with which tolerances have already been registered, a screen used to change the current tolerance setting is displayed.
- If you select a registration number for which no tolerance has been set, a blank screen is displayed. To set tolerances, press the [MENU] button to display the <MENU> screen. Move the cursor to "Create" and press the [SAVE/SEL] button, and the tolerance setting screen is displayed.

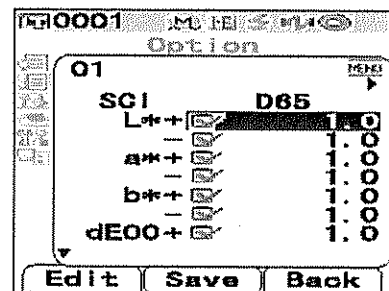

- 5 Use the Δ or ∇ button of the cross key to move the cursor to the desired item.

MEMO

- If $\triangleleft/\triangleright$ is displayed at the top of the screen, you can use the \triangleleft or \triangleright button of the cross key to change the combination of the specular component mode and illuminant used for the screen display.
- If $\blacktriangle/\blacktriangledown$ is displayed on the left side/end of the screen, you can use the Δ or ∇ button of the cross key to scroll the display screen upward or downward.

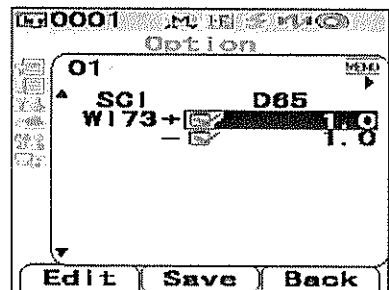
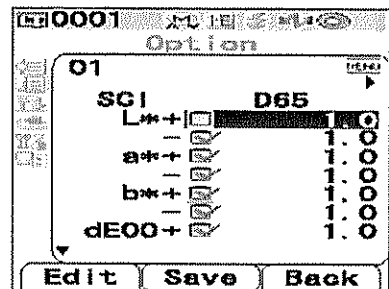

6 Press the [SAMPLE] (Edit) button and change the setting.

- When you select an item which is currently checked and press the [SAMPLE] (Edit) button, the check mark is cleared. When you press the [SAMPLE] (Edit) button again, the cursor moves to the setting value. Use the Δ or ∇ button of the cross key to change the value.
- When you select an item which is not currently checked and press the [SAMPLE] (Edit) button, the cursor moves directly to the setting value. Use Δ or ∇ button of the cross key to change the value.
- To set each parameter l, c and h for CMC, ΔE^*94 and $\Delta E00$, place the cursor on the item and press the [SAMPLE] (Edit) button, and the cursor moves to the value of the item. Press the Δ or ∇ button of the cross key to change the value.

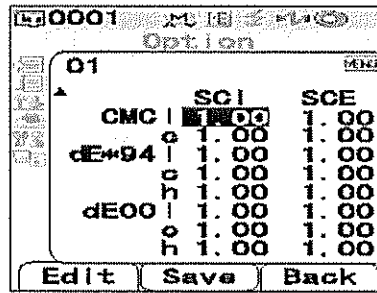

Memo

You can move the cursor between the digits of the value by pressing the \triangleleft or \triangleright button of the cross key.

Settings

- ± 0.0 to 20.0
 - * Settings of each parameter l, c and h for CMC, ΔE^*94 and $\Delta E00$ are 0.00 to 9.99.
- You need to press the [SAVE/SEL] (OK) button to confirm the change every time you change the setting of an item.

7 When all items have been set, press the [SAVE/SEL] button.

The settings are confirmed and the screen returns to the <Tolerance(Def.)> screen.

Memo

To set two or more default tolerances, repeat steps 3 through 7.

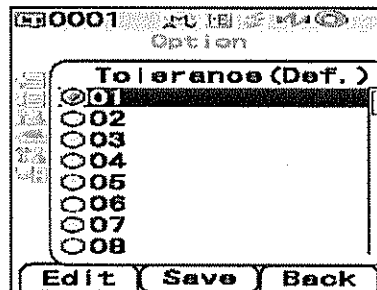

Note

If you press the [TARGET] (Back) button without pressing the [SAVE/SEL] button, you return to the <Tolerance(Def.)> screen without changing the settings.

Setting the Default Color Difference Tolerance (Tolerance (Def.))

Selecting Color Difference Tolerances

You can set color difference tolerances to individual target colors when they are measured. You can also select one of the predefined tolerances (default tolerances) and use it for judgment.

[Memo]

A default tolerance setting can be registered with each registration number from 01 to 08. Before shipment, registration number 01 has been selected. Its tolerance setting is used as a default tolerance setting, which can be set to each target color.

[Note]

When you select a registration number for which no tolerance has been set, the tolerance setting for each target color is also blank.

[Setting Procedure]

- 1 Hold down the [MENU] button and press the ∇ button of the cross key.

The <Option> screen is displayed.

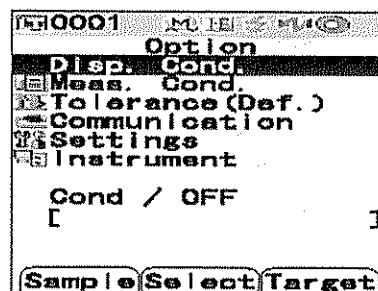

- 2 Use the Δ or ∇ button of the cross key to move the cursor to "Tolerance(Def.)" and then press the [SAVE/SEL] button.

The <Tolerance(Def.)> screen is displayed.

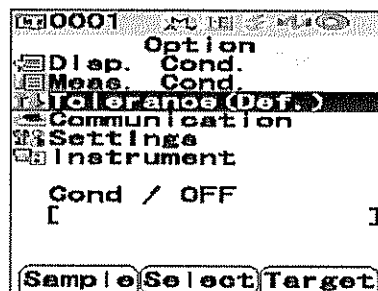

- 3 Use the Δ or ∇ button of the cross key to move the cursor to the desired registration number.

[Memo]

If you press the [SAMPLE] (Edit) button here, you can check the tolerance setting of the registration number. After checking the setting, press the [SAVE/SEL] (OK) button to return to the <Tolerance(Def.)> screen.

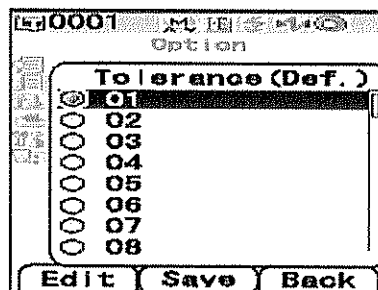

- 4 Press the [SAVE/SEL] button.

The selection is confirmed and the screen returns to the <Option> screen.

Deleting the Default Color Difference Tolerance Setting

Delete the setting of the default tolerance of the selected registration number.

[Setting Procedure] Start the procedure from the <Tolerance(Def.)> screen.

- 1 Use the Δ or ∇ button of the cross key to move the cursor to the registration number for which you want to delete the setting, and then press the [SAMPLE] (Edit) button.

A screen used to set tolerances for the selected registration number is displayed.

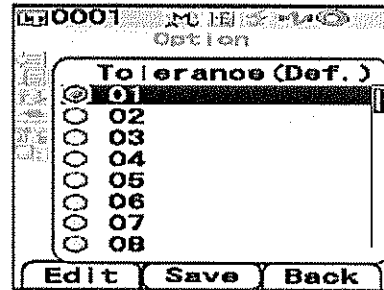

- 2 Press the [MENU] button. The <Menu> screen is displayed.

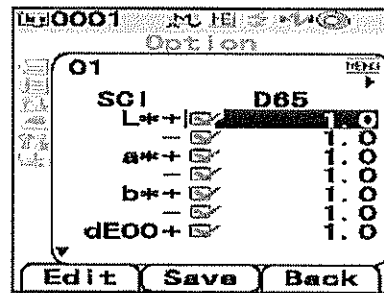

- 3 Use the Δ or ∇ button of the cross key to move the cursor to "Clear", and then press the [SAVE/SEL] button. The setting of the selected registration number is deleted.

[Memo]

After the setting is deleted, the screen for the registration number is blank.

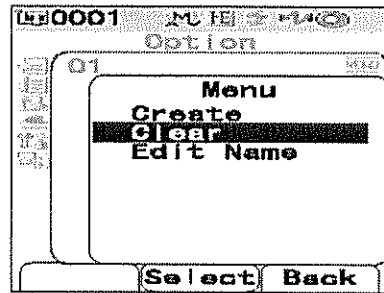

Naming the Color Difference Tolerance Setting

[Setting Procedure] Start the procedure from the <Tolerance(Def.)> screen.

- 1 Use the Δ or ∇ button of the cross key to move the cursor to the registration number for which you want to edit the name, and then press the [SAMPLE] (Edit) button.

A screen used to set tolerances for the selected registration number is displayed.

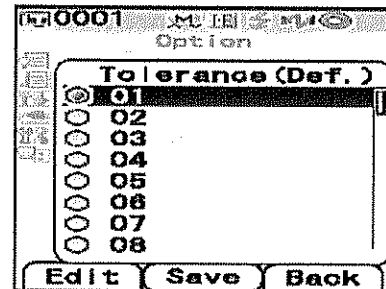

- 2 Press the [MENU] button. The <Menu> screen is displayed.

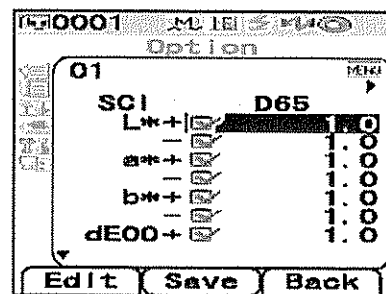

- 3 Use the Δ or ∇ button of the cross key to move the cursor to "Edit Name" and then press the [SAVE/SEL] button. The <Edit Name> screen is displayed.

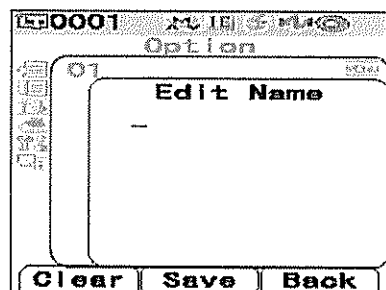
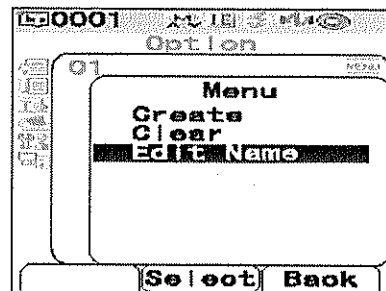

4 Use the ◀ or ▶ button of the cross key to move the cursor, and use the ▲ or ▼ button to change the letter.

- Use the ◀ button of the cross key to move the cursor backward to correct letters.
- Pressing the [SAMPLE] (Clear) button clears all letters.
- Up to 11 characters can be used.
- The available letters are upper/lower-case alphabets, symbols, numbers (0 to 9), and a space.

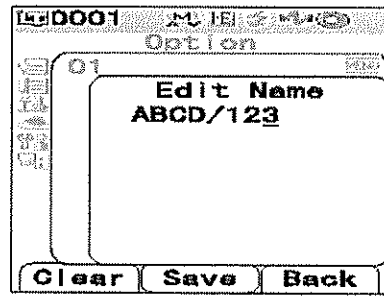

Available symbols										
!	"	#	\$	%	&	'	()	*	+
,	-	.	/	:	;	<	=	>	?	@
[¥]	^	_	`	{		}		

5 When you finish entering letters, press the [SAVE/SEL] button.

The screen returns to a screen used to set tolerances for the selected registration number.

Other Settings

Setting the Display Language

The display language can be changed from the factory-set language. Available languages are: English, Japanese, German, French, Spanish, Italian, and Chinese.

[Memo]

The language is factory-set to "English".

[Note]

When the backup battery of the instrument has gone dead, the display language is reset to English regardless of the set language.

[Setting Procedure]

- 1 Hold down the [MENU] button and turn ON the instrument.

The <Language> screen is displayed.

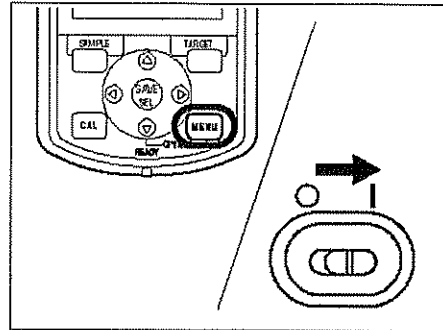

- 2 Use the Δ or ∇ button of the cross key to move the cursor to the desired language.

* The figure shows an example when German (Deutsch) is selected.

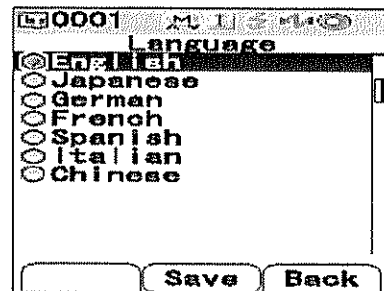

- 3** Press the [SAVE/SEL] button.
The <Calibration> screen is displayed in the selected language.
* The figure shows an example when German (Deutsch) is selected.

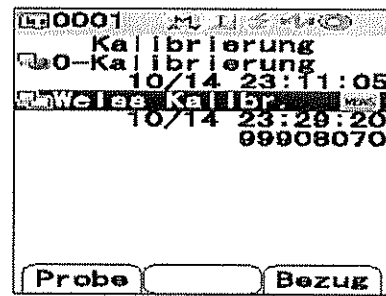

Setting the Date and Time

The CM-700d/600d has a built-in clock to record the date and time of measurement. Since the date and time have been set at the factory, you do not need to change them under normal conditions. If necessary, you can change the date and time settings.

[Setting Procedure]

- 1** Hold down the [MENU] button and press the ∇ button of the cross key.

The <Option> screen is displayed.

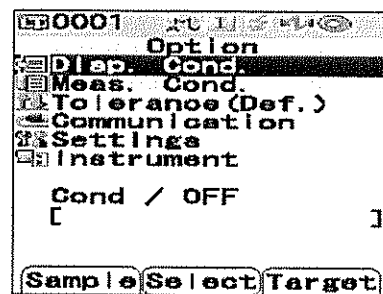

- 2** Use the ∇ button of the cross key to move the cursor to "Settings" and then press the [SAVE/SEL] button.

The <Settings> screen is displayed.

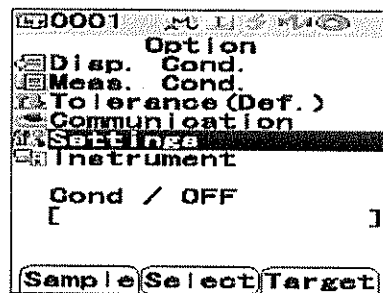

- 3** Use the ∇ button of the cross key to move the cursor to "Date&Time" and then press the [SAVE/SEL] button.

The <Date&Time> screen is displayed.

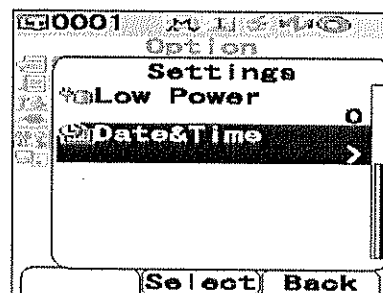

- 4** If you want to change the date format, move the cursor to "Format" and then press the [SAVE/SEL] button.

The <Format> screen is displayed.

Memo

This step is unnecessary if you do not change the date format. Go to step 6 on the next page.

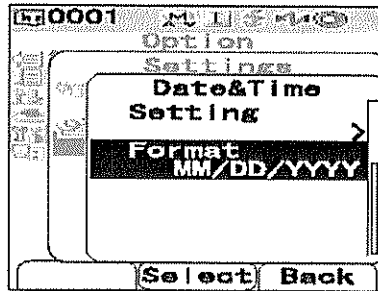

- 5** Use the Δ or ∇ button of the cross key to move the cursor to the desired format and then press the [SAVE/SEL] button.

The screen returns to the <Date&Time> screen.

Settings

- YYYY/MM/DD: Display the date in the format of year/month/day.
- MM/DD/YYYY: Display the date in the format of month/day/year.

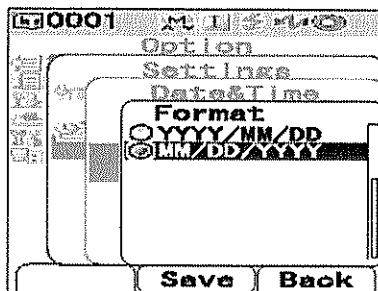

- 6** Use the Δ or ∇ button of the cross key to move the cursor to "Setting" and then press the [SAVE/SEL] button.

The <Setting> screen is displayed.

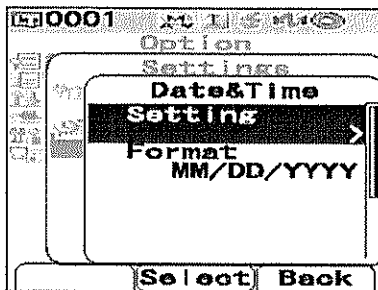

- 7** Use the Δ , ∇ , \triangleleft or \triangleright button of the cross key to move the cursor to the block of the item which you want to change.

Memo

The date consists of blocks of the year, month and day, and the time consists of blocks of the hour, minute and second. To change the values, you need to change the blocks individually.

- Pressing the Δ or ∇ button of the cross key moves the cursor between the date setting line and the time setting line.
- Pressing the \triangleleft or \triangleright button of the cross key moves the cursor among the blocks on either the date setting line or the time setting line.

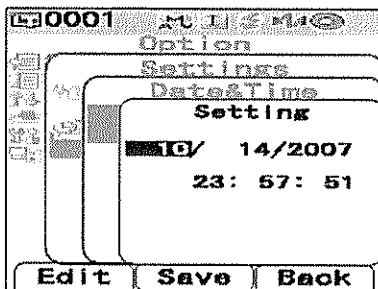

8 Press the [SAMPLE] (Edit) button.

The cursor moves to the position where the setting can be changed.

- Use the Δ or ∇ button of the cross key to change the values.

Note

Every time you change the value of a block, you need to press the [SAVE/SEL] (OK) button to confirm the change. You cannot move to the next block unless you confirm the change of the current block.

Settings

- Year: 2000 to 2050
- Month: 1 to 12
- Day: 1 to 28, 29, 30 and 31 (varies with the selected month/year)
- Hour: 0 to 23
- Minute: 0 to 59
- Second: 0 to 59

9 When all of the necessary items have been changed, press the [SAVE/SEL] button.

The settings are confirmed, and the screen returns to the <Date&Time> screen.

- Press the [TARGET] (Back) button twice to return to the <Option> screen.

Setting the Power Save Mode

The CM-700d/600d features a power save function which turns off the screen display and stops the power supply to the flash circuit after no operation was made for a specified period of time. The period before the activation of the power save function can be set to 0 (OFF) or within the range from 1 to 60 minutes.

Note

The power save function is factory-set to OFF.

[Setting Procedure]

- 1 Hold down the [MENU] button and press the ∇ button of the cross key.

The <Option> screen is displayed.

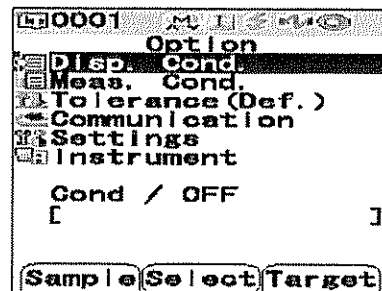

- 2 Use the ∇ button of the cross key to move the cursor to "Settings" and then press the [SAVE/SEL] button.

The <Settings> screen is displayed.

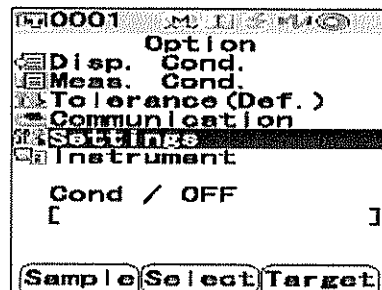

- 3 Use the Δ button of the cross key to move the cursor to "Low Power" and then press the [SAVE/SEL] button.

The <Low Power> screen is displayed.

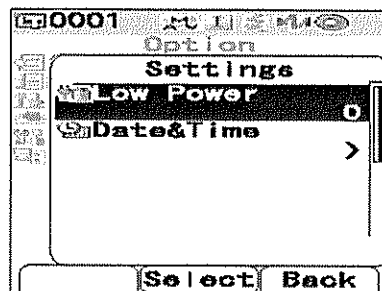

- 4** Use the Δ or ∇ button of the cross key to change the time before the power save mode is activated by specifying the number of minutes.

Memo

Holding down the Δ or ∇ button of the cross key changes the value continuously.

- When you finish changing the setting, press the [TARGET] (Back) button to return to the <Settings> screen of the Option menu.

Settings

- 0: Disable the power save mode.
- 1 to 60: 1 to 60 minutes

- 5** When the change is complete, press the [SAVE/SEL] button.

The setting is confirmed and the screen returns to the <Setting> screen.

Note

If you press the [TARGET] (Back) button without pressing the [SAVE/SEL] button, you return to the <Settings> screen without changing the setting.

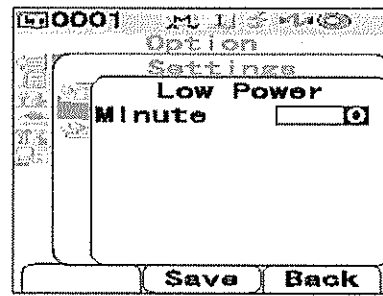

Initialization

Reset the settings of the instrument to the initial status.

Note

- Do not initialize the instrument unless necessary.
- The measured data, target color data, tolerances set to each target color and default tolerance settings will be protected and not be deleted by initialization.

Memo

The measured data and target color data which you saved will be stored even after initialization.
For details of the initial setting values, refer to page E-128 "Initial Settings".

[Setting Procedure]

- 1 Turn ON the instrument while holding down the [TARGET] and [SAMPLE] buttons simultaneously.

The <Initialize> screen is displayed.

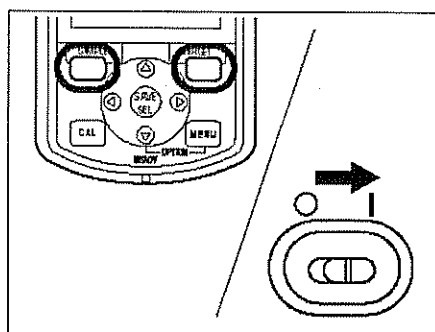

- 2 Use the < or > button of the cross key to move the cursor to "OK" and then press the [SAVE/SEL] button.

Initialization will be performed.

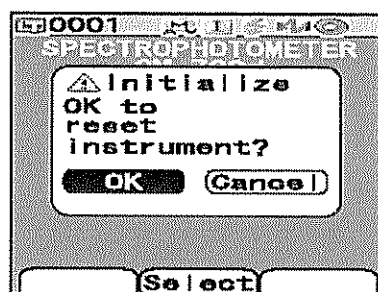

Memo

When you place the cursor on "Cancel" on the <Initialize> screen and press the [SAVE/SEL] button, the initialization is canceled and the <Calibration> screen is displayed.

Other Settings |



| Other Settings



Chapter 3



Measurement

Measurement

Note

- Prior to start of measurement, be sure to perform white calibration. For details, refer to page E-29 "White Calibration".
- To display color difference, it is necessary to set target colors before measurement.
- For accurate measurement, make sure to keep measurement conditions (ambient temperature etc.) constant.

[Setting Procedure]

- 1 Press the [SAMPLE] button.
The <Sample> screen is displayed.

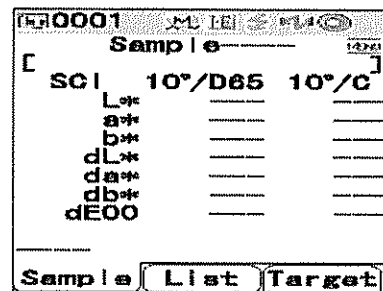

- 2 Place the specimen measuring port on the specimen.

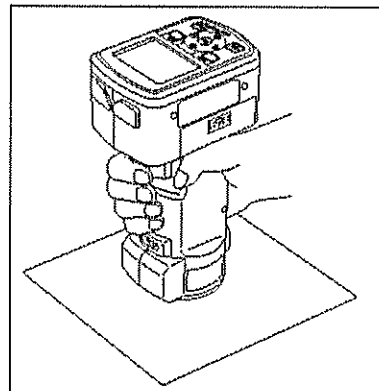

- 3 Make sure that  (Ready to measure) is displayed or Ready lamp is green, and then press the measuring button.

The specimen is measured and the result is displayed on the screen.

- When Scan Name is set to "Auto Scan" (refer to page E-86 "Scan Name"), the <Scan Name> screen is displayed. The bar code scanner reads a name, and the name is set as the name of the sample data.
- The sample data Nos. are automatically assigned sequentially in the order of measurements.

Parameter	Value 1	Value 2
SCI	10°/D65	10°/C
L*	100.43	100.43
a*	0.43	0.33
b*	3.08	3.08
dL*	0.31	0.31
da*	0.03	0.03
db*	-0.00	0.01
dE00	0.18	0.18

Memo

- When the number of measured data sets stored in the memory reaches 4000, the number assigned to the subsequent measured data will always be No. 4000, and the oldest data will be deleted one by one.
- When the screen is turned OFF by the power save function, press any of the measuring or control buttons to turn ON the screen, confirm that  (Ready to measure) is displayed or Ready lamp is green, and then press the measuring button.
- When I + E (SCI + SCE) is specified as the specular component mode (refer to page E-43 "Mode"), clicks caused by opening and closing the optical trap may be heard during the measurement.

Displaying the Measurement Results

At the end of measurement, the measurement results will be displayed on the LCD according to the specified measurement conditions. Typical measurement result screens are shown below.

[Memo]

You can switch the measurement result screens with the ◀ or ▶ button of the cross key. For details of the screen switching, refer to page E-80 "Switching the Display Contents of the Measurement Results".

Measured Data

The figure below shows a sample screen where "Abs. & Diff." is selected for "Disp. Type" of the display condition.

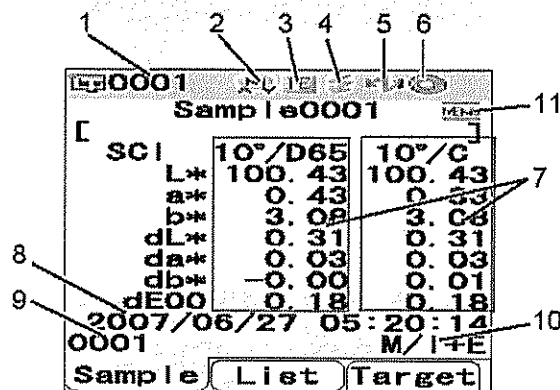

- 1 Data No. of the currently selected target color data.
- 2 Current lens position (M: MAV, S: SAV)
 - With the CM-600d, only "MAV" can be used.
- 3 Current specular component mode (I: SCI, E: SCE, I+E: SCI + SCE)
- 4 Ready to measure
- 5 Bluetooth mode is ON.
- 6 White calibration completed
- 7 Measured data (Can be switched with the ◀ or ▶ button of the cross key.)
 - When both illuminants 1 and 2 are set, the measurement results for both illuminants are displayed. The results of the measurement using illuminant 1 are displayed on the left, and the results using illuminant 2 are displayed on the right.
 - The measured data which failed the pass/fail judgment based on the color difference tolerance will be highlighted in red.
- 8 Date and time of the measurement
- 9 Data No. of the target color data used for the measurement
- 10 Lens position and specular component mode used for the measurement
- 11 Indicates that pressing the [MENU] button will display the <Menu> screen.

Pass/Fail Judgment

The following screens are displayed when “Judge” has been selected for “Disp. Type” of the current display conditions.

- When the result was “Pass”
The background is shown in green.

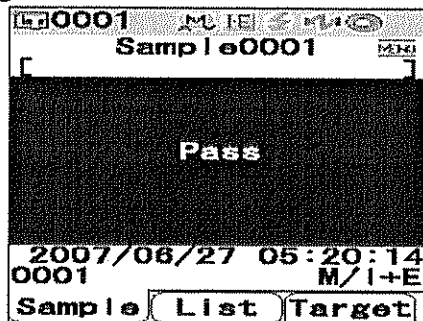

- When the result was “Fail”
The background is shown in red.



Color Difference Graph

The following screen is displayed when “Graph Diff.” has been selected for “Disp. Type” of the current display conditions.

The measurement result is displayed as the points on the graph of which the origin point is set as the target color.

Note

- If a target color has not been set for the selected data No., no point is displayed on the graph.

- Color difference graph

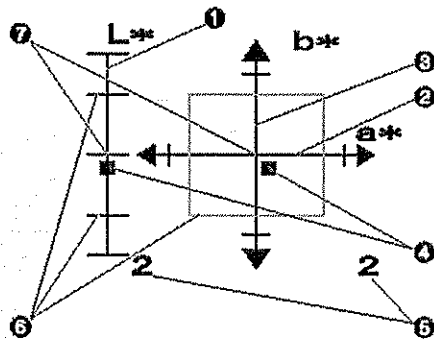
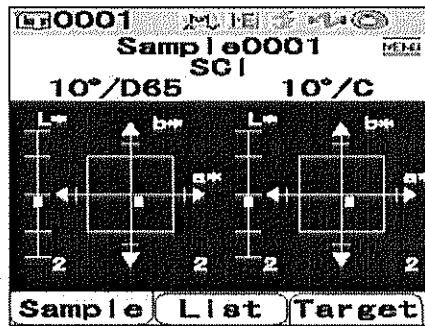

- ① ΔL^* axis (color difference graph)
- ② Δa^* axis (color difference graph)
- ③ Δb^* axis (color difference graph)
- ④ Measuring point
- ⑤ Scales for the axes
- ⑥ Specified box tolerances
- ⑦ Position of target color

Spectral Reflectance Graph

The following screen is displayed when "Graph Spec." has been selected for "Disp. Type" of the current display conditions.

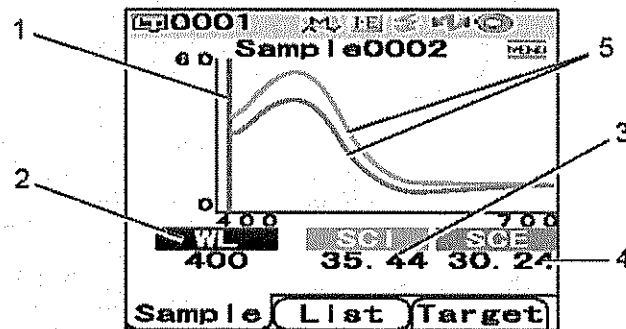

- 1 Position of the currently selected wavelength
- 2 WL: Select the wavelength used in the spectral reflectance graph.
To select wavelength, use the ∇ button of the cross key to move the cursor to the value at the bottom of the screen (unit: nm), then press the \triangleleft or \triangleright button of the cross key.
- 3 SCI: Spectral reflectance in SCI (Specular Component Included) mode
* When the specular component mode is SCE, no value is displayed.
- 4 SCE: Spectral reflectance in SCE (Specular Component Excluded) mode
* When the specular component mode is SCI, no value is displayed.
- 5 Spectral graph: The graph shows the spectral reflectance measured in SCI mode with a blue line, and it shows the reflectance measured in SCE mode with a green line.

Switching the Display Contents of the Measurement Results

The contents of the measurement result display can be changed by pressing the ◀ or ▶ button of the cross key on the <Sample> screen. The contents will vary depending on the display type setting.







Memo

The color difference is displayed only when target data has been set.

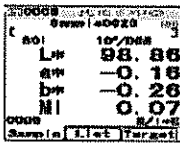
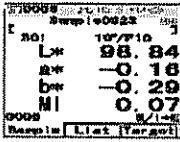
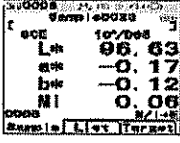
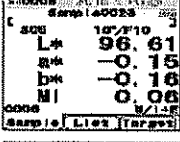
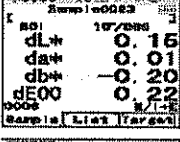
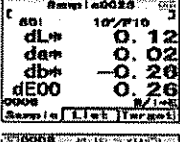
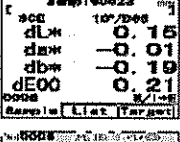
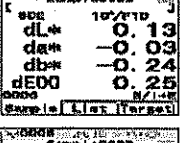
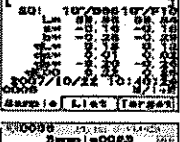
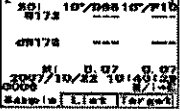
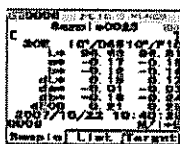
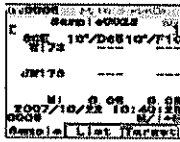
Display type	Illuminant setting	Mode	1		2		3		4		5		6		7		8		9		10	
			SCI				SCE				SCI		SCE		SCI							
			Absolute value/ Illuminant 1		Absolute value/ Illuminant 2		Absolute value/ Illuminant 1		Absolute value/ Illuminant 2		Color difference + Equation		Color difference + Equation		Color difference + Absolute value		Color index					
Absolute value	Mi	Absolute value	Mi	Absolute value	Mi	Absolute value	Mi	Illuminant 1	Illuminant 2	Illuminant 1	Illuminant 2	Illuminant 1	Illuminant 2	Color index	Mi							
Absolute value	Illuminants 1 and 2	I+E	○	○	○	○																
		SCI	○	○	---	---																
		SCE	---	---	○	○																
	Illuminant 1 only	I+E	○	×	---	×	○	×	---	×												
		SCI	○	×	---	×	---	×	---	×												
		SCE	---	×	---	×	○	×	---	×												
Color difference	Illuminants 1 and 2	I+E								○	○	○	○									
		SCI								---	---	---	---									
		SCE												○	○							
	Illuminant 1 only	I+E									○	---	○	---								
		SCI									○	---	---	---								
		SCE									---	---	○	---								
Color difference and Absolute value	Illuminants 1 and 2	I+E																○	○			
		SCI																○	○			
		SCE																---	---			
	Illuminant 1 only	I+E																	○	---	○	×
		SCI																	○	---	○	×
		SCE																	---	---		×
Judgment	Illuminants 1 and 2	I+E																				
		SCI																				
		SCE																				
	Illuminant 1 only	I+E																				
		SCI																				
		SCE																				
Spectral graph	Illuminants 1 and 2	I+E																				
		SCI																				
		SCE																				
	Illuminant 1 only	I+E																				
		SCI																				
		SCE																				
Color difference graph	Illuminants 1 and 2	I+E																				
		SCI																				
		SCE																				
	Illuminant 1 only	I+E																				
		SCI																				
		SCE																				
Pseudo color	Illuminants 1 and 2	I+E																				
		SCI																				
		SCE																				
	Illuminant 1 only	I+E																				
		SCI																				
		SCE																				
Color assessment	Illuminants 1 and 2	I+E																				
		SCI																				
		SCE																				
	Illuminant 1 only	I+E																				
		SCI																				
		SCE																				

Displaying the Measurement Results

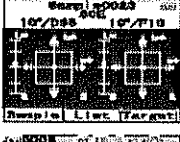
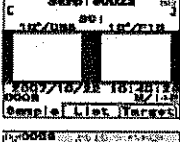
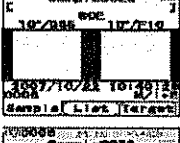
Display order of the measurement result screens (when all the items are selected for "Disp. Type")

- | | | | |
|--|--|---|--|
| <p>1 Absolute value/SCI/
Illuminant 1</p> <p style="text-align: center;">↓</p> <p>2 Absolute value/SCI/
Illuminant 2</p> <p style="text-align: center;">↓</p> <p>3 Absolute value/SCE/
Illuminant 1</p> <p style="text-align: center;">↓</p> <p>4 Absolute value/SCE/
Illuminant 2</p> <p style="text-align: center;">↓</p> <p>5 Color difference/SCI/
Illuminant 1</p> <p style="text-align: center;">↓</p> <p>6 Color difference/SCI/
Illuminant 2</p> <p style="text-align: center;">↓</p> <p>7 Color difference/SCE/
Illuminant 1</p> <p style="text-align: center;">↓</p> <p>8 Color difference/SCE/
Illuminant 2</p> <p style="text-align: center;">↓</p> <p>9 Color difference &
Absolute value/SCI/
Illuminants 1 and 2</p> <p style="text-align: center;">↓</p> <p>10 Color index/SCI/
Illuminants 1 and 2</p> <p style="text-align: center;">↓</p> |           | <p>11 Color difference &
Absolute value/SCE/
Illuminants 1 and 2</p> <p style="text-align: center;">↓</p> <p>12 Color index/SCE/
Illuminants 1 and 2</p> <p style="text-align: center;">↓</p> <p>13 Judgment</p> <p style="text-align: center;">↓</p> <p>14 Spectral graph</p> <p style="text-align: center;">↓</p> <p>15 Color difference graph/
SCI</p> <p style="text-align: center;">↓</p> <p>16 Color difference graph/
SCE</p> <p style="text-align: center;">↓</p> <p>17 Pseudo color/SCI</p> <p style="text-align: center;">↓</p> <p>18 Pseudo color/SCE</p> <p style="text-align: center;">↓</p> <p>19 Color assessment/SCI</p> <p style="text-align: center;">↓</p> <p>20 Color assessment/SCE</p> <p style="text-align: center;">↓</p> |           |
|--|--|---|--|

Continues to 11

Returns to 1

Measured Data Operation

The following operations are available for the measured data.

- Print: Print the measured data.
- Delete: Delete the measured data.
- Edit Name: Name the measured data.
- Scan Name:
The “name” of the measured data is read with a Bluetooth bar code scanner and is set as the data name.
- List: Specify the columns displayed for each sample data No. in the list.
- Auto Target: Automatically select a target color with the smallest color difference for measurement.
- Delete All: Delete all the measured data.

[Operating Procedure]

- 1** From the <Sample> screen, press the [MENU] button.

The <Menu> screen is displayed.

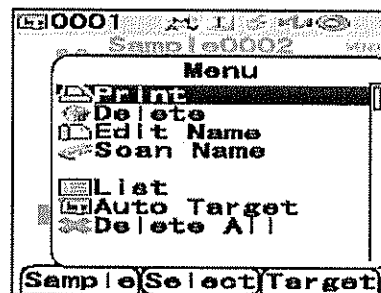

- 2** Use the Δ or ∇ button of the cross key to move the cursor to an item to select or execute, and then press the [SAVE/SEL] button.

The setting screen for the selected item is displayed.

For the operating procedure of each item, refer to the following sections.

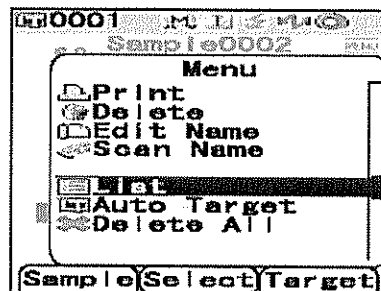

- 3** To return to the <Sample> screen, press the [MENU] button while the <Menu> screen is displayed.

Print

Print the measured data.

You need to establish a connection between the instrument and a Bluetooth printer in advance.

Note

If proper connection is not established, you cannot select "Print" on the <Menu> screen.

[Operating Procedure] Start the procedure from the <Menu> screen of the <Sample> screen.

- 1 Use the Δ or ∇ button of the cross key to move the cursor to "Print".

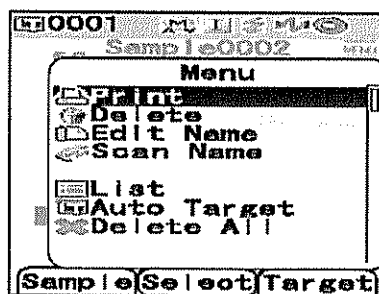

- 2 Press the [SAVE/SEL] button. The <Print> screen is displayed and the data is printed from the connected printer.

When the printing is complete, the screen returns to the <Sample> screen.

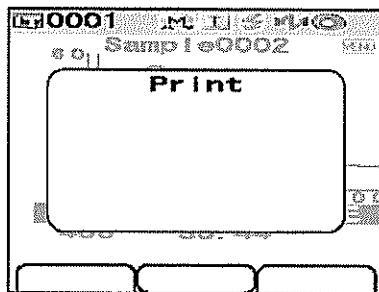

Delete

Delete the measured data.

[Operating Procedure] Start the procedure from the <Menu> screen of the <Sample> screen.

- 1 Use the Δ or ∇ button of the cross key to move the cursor to "Delete" and then press the [SAVE/SEL] button.

The <Delete> screen is displayed.

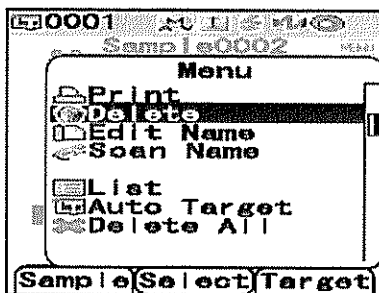

- Use the \triangleleft button of the cross key to move the cursor to "OK" and press the [SAVE/SEL] button. Data will be deleted.

[Memo]

When data is deleted, the subsequent sample data Nos. will be reassigned, reducing them by one.

- When the deletion is complete, the screen returns to the <Menu> screen.
- When you place the cursor on "Cancel" and press the [SAVE/SEL] button, the deletion is canceled and the screen returns to the <Menu> screen.

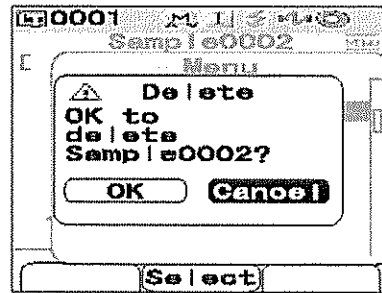

Edit Name

Name the measured data.

[Setting Procedure] Start the procedure from the <Menu> screen of the <Sample> screen.

- Use the \triangle or ∇ button of the cross key to move the cursor to "Edit Name" and then press the [SAVE/SEL] button.

The <Edit Name> screen is displayed.

[Memo]

The initial value for the name is "No Name".

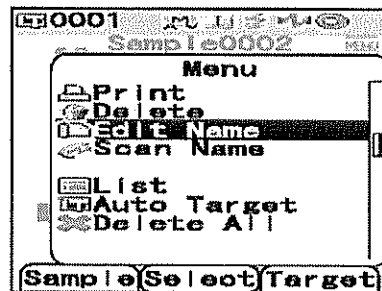

- Use the \triangleleft or \triangleright button of the cross key to move the cursor, and use the \triangle or ∇ button to change the letter.

- Use the \triangleleft button of the cross key to move the cursor backward to correct letters.
- Pressing the [SAMPLE] (Clear) button clears all letters.

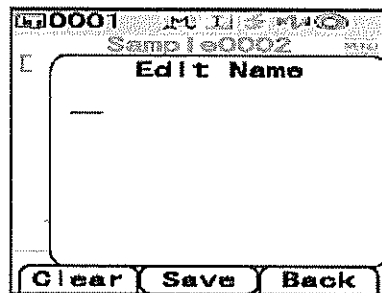

- Up to 11 characters can be used.
- The available letters are upper/lower-case alphabets, symbols, numbers (0 to 9), and a space.

Available symbols										
	*	#	\$	%	&	'	()	*	+
.	-	.	/	:	;	<	=	>	?	@
[¥]	^	_	'	()		

- When you finish entering letters, press the [SAVE/SEL] button.

The name is confirmed, and the screen returns to the <Menu> screen.

[Note]

If you press the [TARGET] (Back) button without pressing the [SAVE/SEL] button, you return to the sample data screen without changing the name.

Scan Name

You can scan a “name” of the measured data with a Bluetooth bar code scanner and set it as the data name.

- First, you need to establish the Bluetooth connection between the instrument and bar code scanner.
- There are two methods of the Scan Name function: “Auto Scan” and “Manual Scan”.
 - Auto Scan: The bar code scanner automatically reads a “name” for each measurement.
 - Manual Scan: The user invokes “Scan Name” from the <Menu> screen and reads a “name” with the bar code scanner.

Memo

- For the method of establishing the Bluetooth connection with the bar code scanner, refer to page E-111 “Connecting a Bar Code Scanner”.
- For the method of switching between Auto Scan and Manual Scan, refer to page E-116 “Setting Auto Scan”.

Note

- *If the Bluetooth connection is improper, “Scan Name” cannot be selected on the <Menu> screen.*
- *Although the Bluetooth connection is established, the input may be disabled in the case when the Scan Name operation is attempted while the bar code scanner is turned off.*

When Auto Scan Is Set

When the Scan Name method is set to “Auto Scan”, the bar code scanner automatically reads a “name” for each measurement.

Memo

- Pressing the [Cancel] (Back) button cancels the name reading.

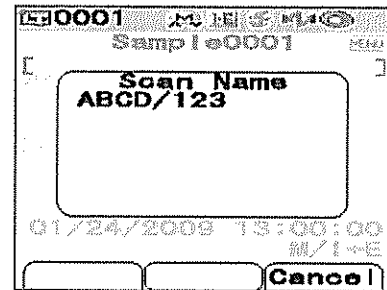

Note

When the bar code scanner fails reading a name, an error message appears to prompt the user to read the name with “Manual Scan”.

Memo

For instructions of the Manual Scan, refer to page E-87 “When Manual Scan is Set”.

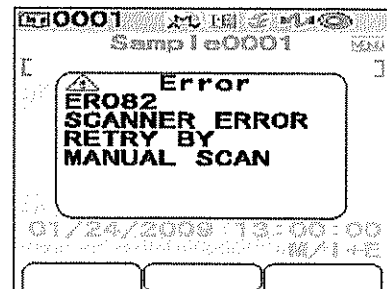

When Manual Scan Is Set

When the Scan Name method is set to "Manual Scan", follow the procedure below to read a "name" with the bar code scanner.

[Operating Procedure] Start the procedure from the <Menu> screen of the <Sample> screen.

- 1 Use the Δ or ∇ button of the cross key to move the cursor to "Scan Name" and then press the [SAVE/SEL] button.

The <Scan Name> screen is displayed.

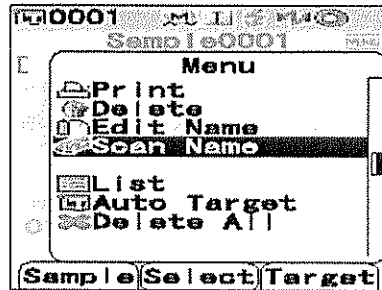

Read "name" data with the bar code scanner.

Memo

- Pressing the [Cancel] (Back) button cancels the name reading.

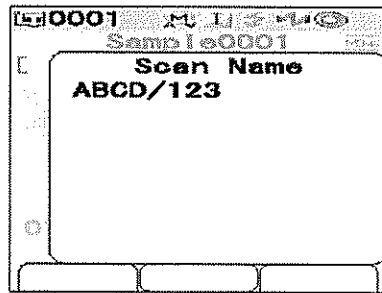

Note

- When the bar code scanner fails reading a name, an error message appears to prompt the user to invoke the manual scan to read the name again.
- Although the Bluetooth connection is established, the input may be disabled in the case when the Scan Name operation is attempted while the bar code scanner is turned off.

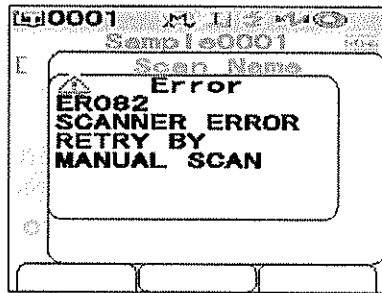

Setting the List (List)

When the <Sample> screen is displayed, pressing the [SAVE/SEL] button switches the screen between the list display and detail display. Specify the columns displayed for each sample data No. in the list.

[Setting Procedure] Start the procedure from the <Menu> screen of the <Sample> screen.

- 1 Use the Δ or ∇ button of the cross key to move the cursor to "List" and then press the [SAVE/SEL] button.

The <List> screen is displayed.

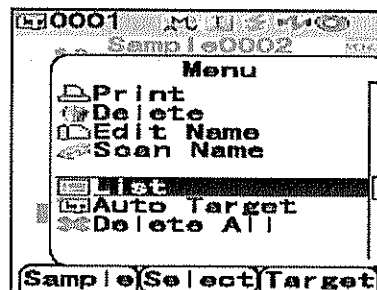

- 2 Use the Δ or ∇ button of the cross key to move the cursor to the desired item.

Settings

- Name: Display the name specified with Edit Name in the list.
- Date.&Time: Display the date and time of the measurement in the list.
- Pseudo Color: Display the pseudocolor in the list.

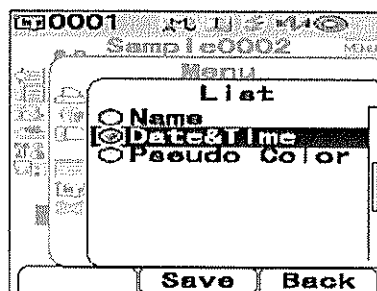

- 3 Press the [SAVE/SEL] button.

The selection is confirmed and the screen returns to the <Menu> screen.

Note

If you press the [TARGET] (Back) button without pressing the [SAVE/SEL] button, you return to the sample data screen without changing the setting.

Auto Target

Automatically select the target color with the smallest color difference (ΔE^*ab) for measurement.

Memo

The target color will be selected from those with the same specular component mode setting as the measurement. For example, when the specular component mode "I + E" is used for the measurement, the target color is selected from those for which "I + E" has been set.

Note

- Do not use this function if you want to check the color difference from a specific target color.
- This setting will not be applied to the measured data obtained before this function is set to ON.

[Setting Procedure] Start the procedure from the <Menu> screen of the <Sample> screen.

- 1 Use the Δ or ∇ button of the cross key to move the cursor to "Auto Target" and then press the [SAVE/SEL] button.

The <Auto Target> screen is displayed.

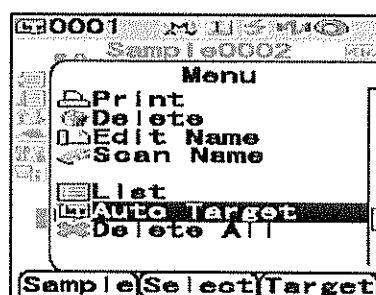

- 2 Use the Δ or ∇ button of the cross key to move the cursor to "ON" or "OFF".

Settings

- ON: Use the Auto Target function for measurement.
- OFF: Do not use the Auto Target function.

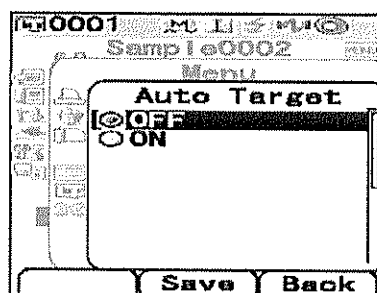

- 3 Press the [SAVE/SEL] button.

The selection is confirmed and the screen returns to the <Menu> screen.

Note

If you press the [TARGET] (Back) button without pressing the [SAVE/SEL] button, you return to the sample data screen without changing the setting.

Delete All

Delete all the measured data.

[Operating Procedure] Start the procedure from the <Menu> screen of the <Sample> screen.

- 1 Use the Δ or ∇ button of the cross key to move the cursor to "Delete All" and then press the [SAVE/SEL] button.

The <Delete All> screen is displayed.

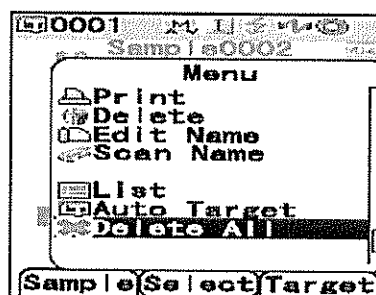

Measured Data Operation

2 Use the \triangleleft button of the cross key to move the cursor to "OK" and press the [SAVE/SEL] button, and the data is deleted.

- When the deletion is complete, the screen returns to the <Menu> screen.
- When you place the cursor on "Cancel" and press the [SAVE/SEL] button, the deletion is canceled and the screen returns to the <Menu> screen.

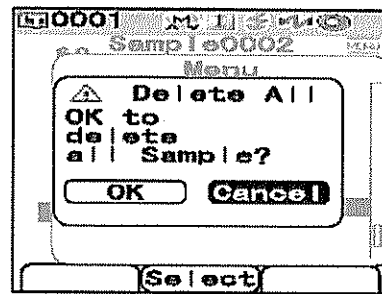

Chapter 4



Other Functions

Average Measurement

When taking measurements or setting target colors, more accurate data can be obtained if the averaging function is used.

With the CM-700d/600d, the following two averaging functions are available.

- **Manual Averaging** : When the color of the specimen is not uniform, measurements are performed at different positions on the specimen and then the average of the measured spectral reflectance data is calculated. This gives the average data of the entire specimen.
- **Auto Averaging** : The specified number of measurements are repeated at the same position on the specimen and then the average of the measured spectral reflectance data is calculated. This will improve the accuracy of the measured data.

These two functions can also be used in combination. In this case, it is necessary to make settings for both auto and manual averaging. For details, refer to page E-45 "Auto Averaging (Auto Ave.)" and page E-46 "Manual Averaging (Manual Ave.)".

Note

For average measurement, the average of the measured spectral reflectance data is calculated first, then colorimetric data is calculated based on that calculated average. Thus, the result may not match the average of the measured colorimetric data.

Manual Averaging

This method is used when the color of the specimen is not uniform. Measurements are performed at different positions on the specimen and then the average of the measured spectral reflectance data is calculated, to obtain the average data of the entire specimen.

Note

Before using manual averaging, you must complete the settings for manual averaging. For details, refer to page E-46 "Manual Averaging (Manual Ave.)".

[Setting Procedure]

- 1** Press the [SAMPLE] button.
The <Sample> screen is displayed.

Sample e0001		
SCI	10°/D65	10°/C
L*	100.43	100.43
a*	0.43	0.33
b*	3.08	3.08
dL*	0.31	0.31
da*	0.03	0.03
db*	-0.00	0.01
dE00	0.18	0.18
2007/06/27 05:20:14		
0001 M/I+E		
Sample	List	Target

- 2** Place the specimen measuring port on the specimen.

- 3** Make sure that  (Ready to measure) is displayed or Ready lamp is green, and then press the measuring button.

The number of completed measurements and the measured value will be displayed during measurement.

Memo

To cancel the measurement, press the [TARGET] (Cancel) button. If canceled, the measurement will not be saved.

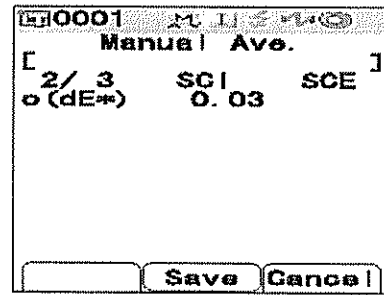

- 4** Place the specimen measuring port at the next position and repeat the steps from 1 to 3.

When the specified number of measurements has been completed, the averaging result will be displayed on the screen.

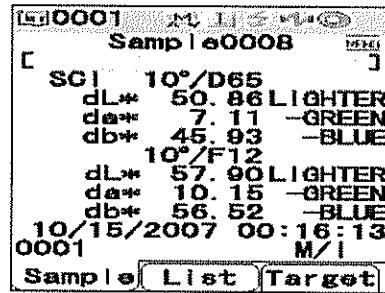

Memo

- To finish manual averaging and display the result before the specified number of measurements is completed, press the [SAVE/SEL] button.
- When the screen is turned OFF by the power save function, press any of the measuring or control buttons to turn ON the screen, confirm that  (Ready to measure) is displayed or Ready lamp is green, and then press the measuring button.

Auto Averaging

Measurement is repeated the specified number of times at the same position on the specimen and then the average of the measured spectral reflectance data is calculated. This will improve the accuracy of the measured data.

The measurement procedure is as shown below.

Note

Before starting auto averaging, you must complete the settings for auto averaging. For details, refer to page E-45 "Auto Averaging (Auto Ave.)".

[Setting Procedure]

- 1 Press the [SAMPLE] button.

The <Sample> screen is displayed.

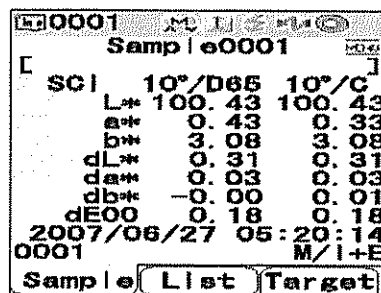

- 2 Place the specimen measuring port on the specimen.

- 3 Make sure that  (Ready to measure) is displayed or Ready lamp is green, and then press the measuring button.

The number of completed measurements will be displayed during measurement.

Memo

To cancel the measurement, press the [TARGET] (Cancel) button. It may take some time before the cancellation is accepted. Continue pressing the button until Error Message WR120 (measurement interrupted) is displayed.

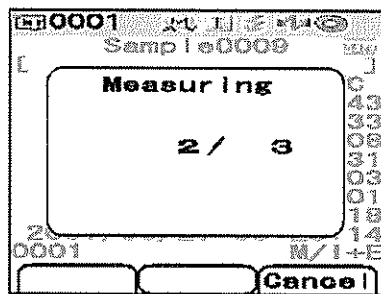

When the specified number of measurements has been completed, the averaging result will be displayed on the screen.

Note

If you cancel measurement before the measurement is repeated for the specified number, the measured value is not displayed.

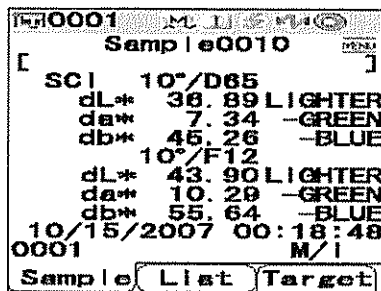

Pass/Fail Judgment for Color Difference

You can set tolerances for the color difference of the measured data from the target color data to make pass/fail judgment. The CM-700d/600d uses box tolerances for judgment. The tolerances can also be set for “Cond 01 to 08” on the <Option> screen. For details, refer to page E-50 “Tolerance (Box Tolerance) Setting”.

The pass/fail judgment will be based on the target color data of the number selected for measurement, and on either of the tolerances specified for the target color data or the tolerances set for “Cond 01 to 08”. If target color data is deleted, neither the color difference display for the data nor the pass/fail judgment based on the tolerances set to the data will be performed. Even if other target color data is selected, recalculations and pass/fail judgments will not take place.

Pass/Fail Judgment Based on Tolerances

If the measured color difference is outside the tolerances set for the target color, the value will be highlighted in red to indicate that the judgment result is “Fail”. Both + and - tolerances can be set for each target color.

To perform pass/fail judgment based on box tolerances, follow the procedure given below.

Note

Before using this function, you must set color difference tolerances.

[Setting Procedure]

- 1 Press the [TARGET] button.
The <Target> screen is displayed.

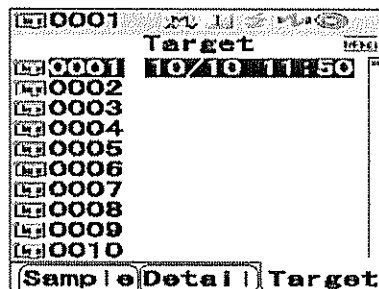

- 2 Use the Δ or ∇ button of the cross key to select the target color No.
 - If you want to select the target color by its name or date, press the [SAVE/SEL] button to show the list display.
 - In the list, you can press the \triangleleft or \triangleright button to change the screen entirely to the next screen.
 - To change the target color No. while the spectral reflectance graph is displayed, you need to press the Δ or ∇ button twice.

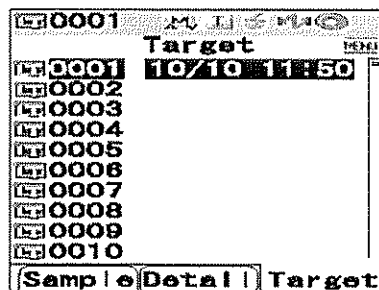

Pass/Fail Judgment for Color Difference

- 3 Press the [MENU] button.
The <Menu> screen is displayed.

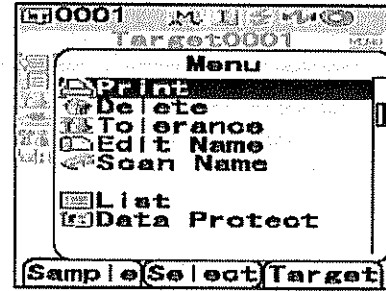

- 4 Use the Δ or ∇ button of the cross key to move the cursor to "Tolerance" and then press the [SAVE/SEL] button.
The <Tolerance> screen is displayed.

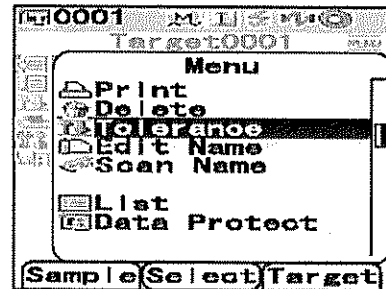

- To display the other tolerance setting items, press the Δ or ∇ button of the cross key.

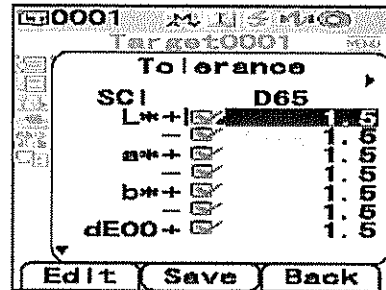

- 5 Make sure that the values are set properly, and then press the [SAVE/SEL] button.
The <Target> screen is displayed.

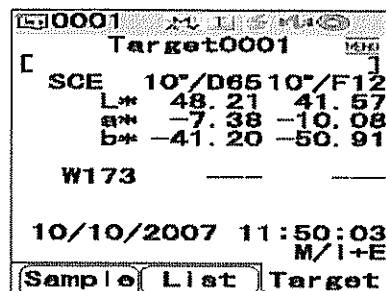

- 6 Press the [SAMPLE] button.
The <Sample> screen is displayed.

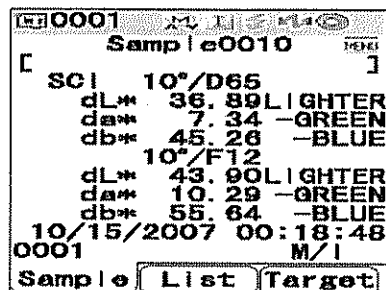

- 7** Place the specimen measuring port on the specimen, and press the measuring button. The specimen is measured and the judgment results are displayed according to the display type specified for the display conditions.

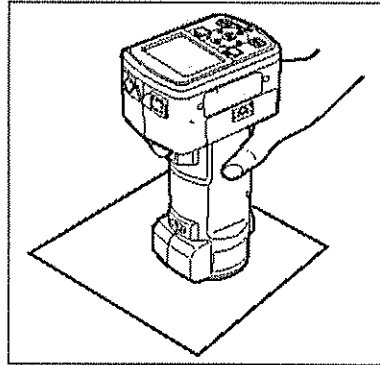

- When the display type is “Absolute” or “Abs. & Diff.”
The values which failed the judgment are highlighted in red. In the print output to the printer, “[]” is appended after the failed item.

Sample0010	
SCI	10°/D65 10°/F12
L*	100.89 101.26
a*	-0.08 0.22
b*	4.07 4.89
dL*	50.86 57.80
da*	7.11 10.15
db*	45.93 56.62
dE00	45.72 53.08
10/15/2007 00:18:13	
0001 M/I	
Sample	List Target

- When the display type is “Judge”

When at least one item failed the judgment, “Fail” is displayed; when all items passed the judgment, “Pass” is displayed.

- When the judgment result is “Pass”, the results are displayed as the screen on the right according to the condition setting at the time of the measurement. In the print output to the printer, “Pass” is printed.

Sample0001	
Pass	
2007/06/27 05:20:14	
0001 M/I+E	
Sample	List Target

- When the judgment result is “Fail”, the results are displayed as the screen on the right according to the condition setting at the time of the measurement. In the print output to the printer, “Fail” is printed.

Sample0002	
Fail	
2007/06/27 05:21:23	
0001 M/I+E	
Sample	List Target

Memo

- When “Judge” is selected as the display type, “Pass” will be displayed only when all the items have passed the judgment.
- When “Absolute” or “Abs. & Diff.” is selected as the display type, the values for the items which have failed the judgment will be highlighted in red.
- If the tolerances have not been set, or the target color data of the number selected for the measurement has been deleted, “None” will be displayed instead of the judgment results.
- When the screen is turned OFF by the power save function, press any of the measuring or control buttons to turn ON the screen, confirm that  (Ready to measure) is displayed or Ready lamp is green, and then press the measuring button.

Connecting to an External Device

The CM-700d/600d features both USB and Bluetooth capability. You can establish data communication or print data by connecting the instrument to a PC with the supplied USB cable IF-A17, or by connecting it to a PC or a printer via Bluetooth.

Note

When the instrument is exposed to strong external static electricity or is affected by ambient interference during communication with an external device, the communication may be interrupted. In this case, turn the power OFF and then turn it ON again.

Connecting a Personal Computer

You can establish connection between the CM-700d/600d and a PC by connecting them with a USB cable or by using the Bluetooth capability of the instrument.

Note

- *To use the Bluetooth capability to establish connection to a PC, the PC must be equipped with a Bluetooth adapter and the Bluetooth communication link must be opened by using the utility software supplied with the adapter.*
- *The USB cable connection will be given priority over the Bluetooth communication link.*

Memo

- When connected to a PC, the instrument enters the communication mode automatically. The LCD screen displays “Communicating” and the measuring and control buttons are disabled.
- If a command to enable the measuring button is sent from the PC to the instrument, you can use the measuring button to start measurement. Note, however, that, in this case, the measured data is not stored in the memory of the instrument, but is transferred to the PC.
- To connect the instrument with a PC, it is recommended that you use software that enables connection and operation of the instrument (such as the optional Color Data Software SpectraMagic NX CM-S100w).

Connecting the Instrument with a USB Cable

Connect the instrument to a PC with the supplied USB cable IF-A17 (2 m).

Note

- *To connect the instrument to a PC, you need to install the USB driver for the CM-700d/600d. Install the USB driver supplied with the software that enables connection and operation of the instrument.*
- *The instrument is not designed to be powered via the USB cable. You need to connect the AC adapter or install batteries in the instrument.*
- *Make sure that the USB connector plug is oriented correctly and connected securely.*
- *When connecting/disconnecting the USB cable, be sure to hold the connector plug. Do not pull on or forcibly bend the cable. Otherwise, wire breakage may result.*
- *Make sure that the cable has sufficient length. Putting tension on the cable may cause connection failure or wire breakage.*
- *To connect the USB cable connector, check the shape of the receptacle (connection terminal) and insert the connector fully until it is secured.*

Memo

The USB communication port of the instrument conforms to USB 1.1.

[Operating Procedure]

In general, a USB cable can be connected/disconnected while the instrument is turned ON, however, you need to turn OFF the instrument in the procedure below.

- 1** Turn OFF the instrument (Slide the Power switch to “O”).

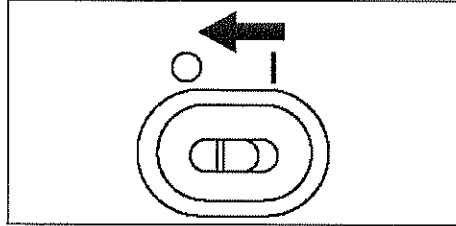

- 2** Open the connector protection cover and connect the B connector of the USB cable to the USB connection terminal.

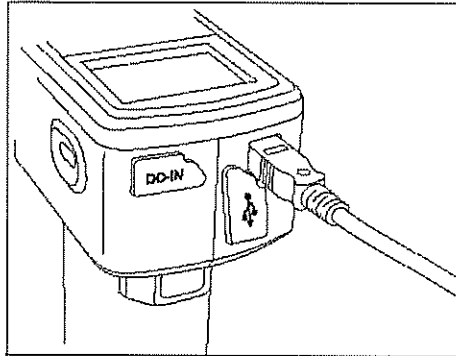

- 3** Connect the A connector of the USB cable to the USB port of the PC.
 • Fully insert the connector and ensure secure connection.

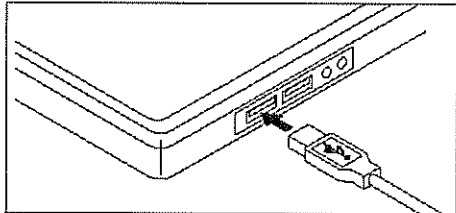

- 4** Turn ON the instrument (Slide the Power switch to “I”).
 • When you are prompted to install the USB driver, specify the USB driver included with the software and complete the installation.

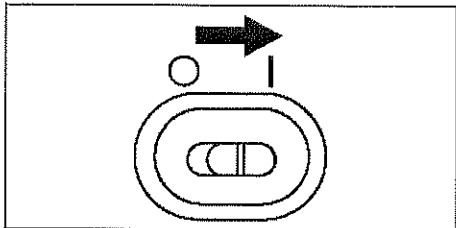

Connecting the Instrument via Bluetooth Communication

Use the built-in Bluetooth capability of the instrument to establish connection between the instrument and a PC.

Note

- The Bluetooth capability of the instrument enables data communication with a PC equipped with a Bluetooth adapter, or data printout with a Bluetooth-capable printer. Note, however, that a PC and a printer cannot be connected simultaneously.
- The USB cable connection and Bluetooth communication link cannot be used simultaneously. When both connections are made, priority is given to the USB cable connection.

Memo

To use the Bluetooth capability of the instrument to connect a PC, you need to prepare both the instrument and the PC to establish Bluetooth communication. For details, refer to the instruction manual of the Bluetooth adapter.

Preparation of the Instrument

Set the Bluetooth capability of the instrument to ON.

[Operating Procedure]

- 1 Hold down the [MENU] button and press the ∇ button of the cross key.

The <Option> screen is displayed.

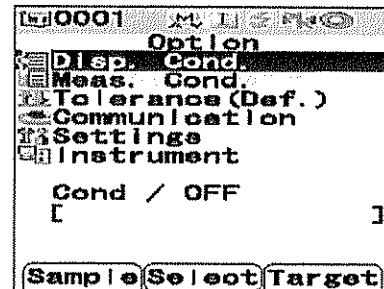

- 2 Use the Δ or ∇ button of the cross key to move the cursor to "Communication" and then press the [SAVE/SEL] button.

The <Communication> screen is displayed.

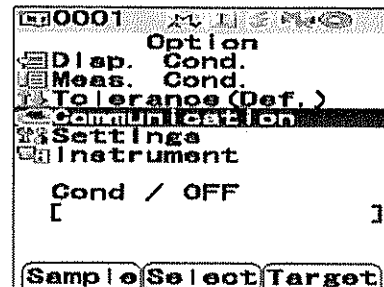

- 3 Use the Δ or ∇ button of the cross key to move the cursor to "Bluetooth" and then press the [SAVE/SEL] button.

The <Bluetooth> screen is displayed.

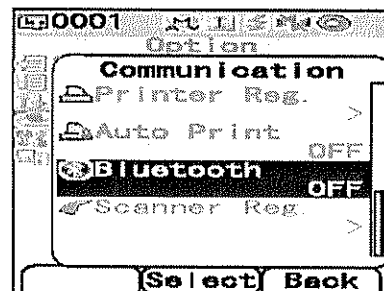

- 4 Use the ∇ button of the cross key to move the cursor to "ON" and then press the [SAVE/SEL] button.

The Bluetooth capability of the instrument is set to ON and the screen returns to the <Communication> screen.

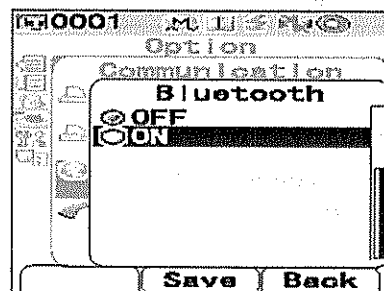

Preparation of the PC

Attach the Bluetooth adapter to the PC to enable Bluetooth communication.

Note

The following describes a basic procedure. For details, refer to the instruction manual of the Bluetooth adapter.

[Operating Procedure]

- 1** Install the utility software supplied with the Bluetooth adapter on the PC.
- 2** Attach the Bluetooth adapter to the USB port of the PC, and ensure that the PC properly recognize the adapter.

Establishing the Connection between the Instrument and PC

Establish the connection between the instrument and PC via Bluetooth communication by setting the PC as a host.

[Operating Procedure]

- 1** Make sure that the instrument is turned ON (The Power switch is set to "I").
- 2** Make sure that the Bluetooth capability of the instrument is set to ON. Also check that a printer is not connected with the Bluetooth capability and that the instrument is not connected to the PC with a USB cable.
- 3** Start the Bluetooth utility software installed on the PC.

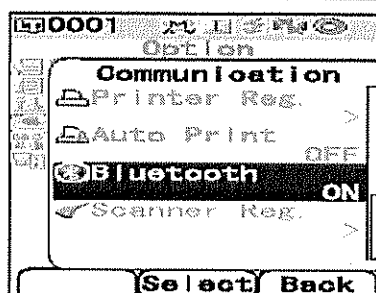
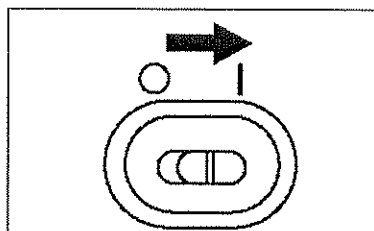

Connecting to an External Device

- 4 From the PC, search for Bluetooth devices and select "KMSEA_XXXXXXX (where XXXXXXX is the serial number of the instrument)" from the listed devices.
- 5 Execute the "Bluetooth to serial connection". When the connection is established, the LCD display of the instrument shows "Communicating".

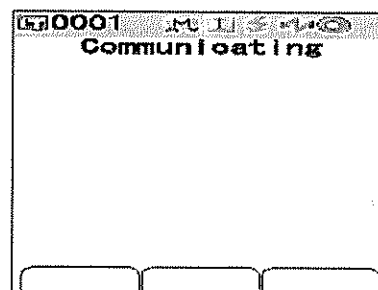

Connecting a Printer

By connecting the instrument and a printer with Bluetooth capability, you can print measurement results and other data from the printer.

Note

- The Bluetooth capability of the instrument enables data communication with a PC equipped with a Bluetooth adapter, or data printout with a Bluetooth-capable printer. Note, however, that a PC and a printer cannot be connected simultaneously.
- Although the maximum communication distance for printing is 10 m, the actual distance for successful printing may vary depending on the radio wave condition of the surrounding environment.
- The Bluetooth printer can print text data only. Note that you cannot print graphs even when you selected spectral graph or color difference graph for the display type for the instrument.

Memo

To use the Bluetooth capability to connect a printer, you need to prepare both the instrument and printer to establish Bluetooth communication.

Preparation of the Printer

Prepare the Bluetooth printer so that it is recognized as a Bluetooth device by the instrument.

Note

The following describes the basic procedure. For details, refer to the separate manual "Bluetooth Setting-up Guide" and the instruction manual of the Bluetooth printer.

[Operating Procedure]

- 1 Set the printer so that it can be used in Bluetooth communication.
 - Check that the communication mode of the printer is set to "Bluetooth". And if it is necessary, charge batteries and set print paper in the printer.
- 2 Check the Bluetooth address of the printer.

Preparation of the Instrument

Set the Bluetooth capability of the instrument to ON.

Note

You cannot register a Bluetooth printer or set Auto Print until the Bluetooth capability of the instrument is set to ON.

[Operating Procedure]

- 1 Hold down the [MENU] button and press the ∇ button of the cross key.

The <Option> screen is displayed.

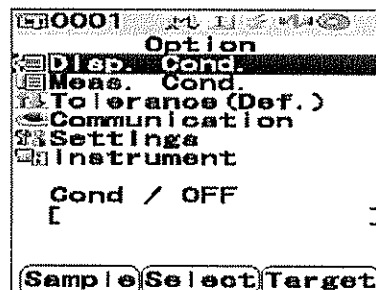

- 2 Use the Δ or ∇ button of the cross key to move the cursor to "Communication" and then press the [SAVE/SEL] button.

The <Communication> screen is displayed.

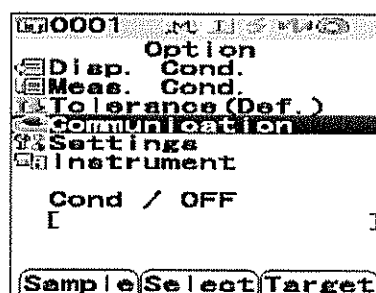

- 3 Use the Δ or ∇ button of the cross key to move the cursor to "Bluetooth" and then press the [SAVE/SEL] button.

The <Bluetooth> screen is displayed.

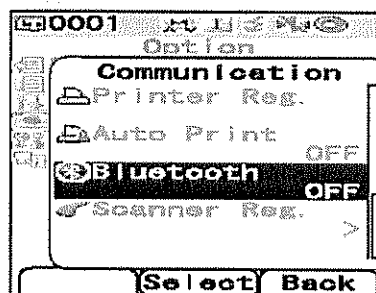

- 4 Use the ∇ button of the cross key to move the cursor to "ON" and then press the [SAVE/SEL] button.

The Bluetooth capability of the instrument is turned ON and can be used.

When the setting finishes, the screen returns to the <Communication> screen.

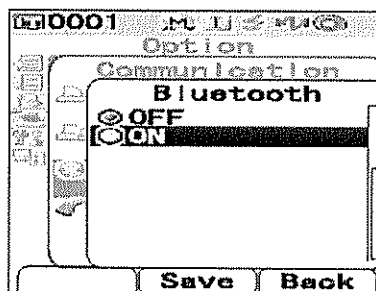

Connecting to an External Device

Establishing the Connection between the Instrument and Printer

Set the instrument as a host and establish a connection between the instrument and Bluetooth printer via Bluetooth communication.

Note

Confirm the following before starting the procedure below.

- The printer is turned ON and its battery has been fully charged.
- The instrument is turned ON (The Power switch is set to "1").
- The Bluetooth capability of the instrument is set to ON.
- A PC is not connected by Bluetooth or USB cable.

Retrieving the Bluetooth Address

[Operating Procedure]

- 1 Hold down the [MENU] button and press the ∇ button of the cross key.

The <Option> screen is displayed.

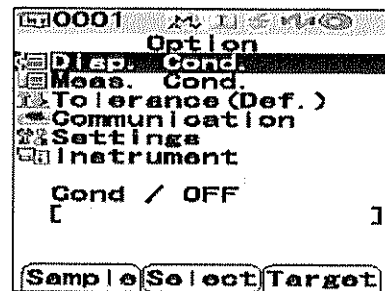

- 2 Use the Δ or ∇ button of the cross key to move the cursor to "Communication" and then press the [SAVE/SEL] button.

The <Communication> screen is displayed.

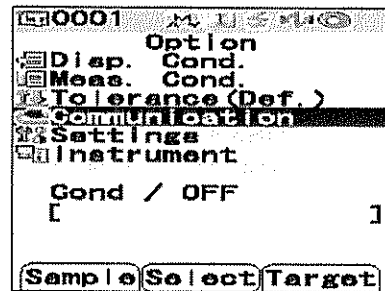

- 3 Use the Δ or ∇ button of the cross key to move the cursor to "Printer Reg." and then press the [SAVE/SEL] button.

The <Printer Reg.> screen is displayed.

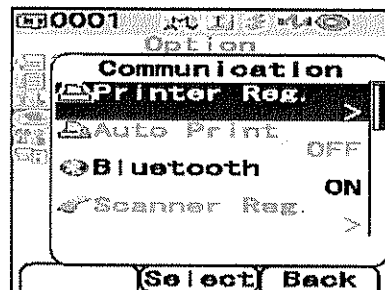

- 4** Use the Δ or ∇ button of the cross key to move the cursor to “Search” and then press the [SAVE/SEL] button.

Available Bluetooth devices are searched for and the result is listed on the LCD screen.

- From the list, find the Bluetooth address of the printer you checked during the procedure of page E-102 “Preparation of the Printer”.
- The search result may not be correct depending on the radio wave condition of the surrounding environment. If you cannot find the Bluetooth address of your printer in the list, make sure that the printer is turned ON and its battery is fully charged, and then try the search again.

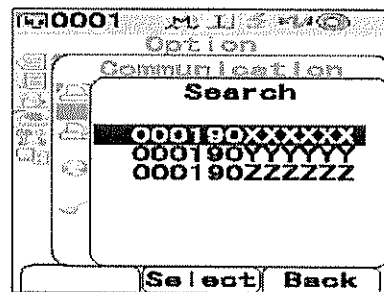
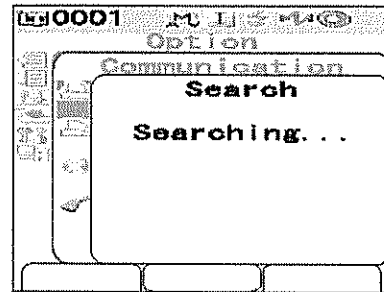
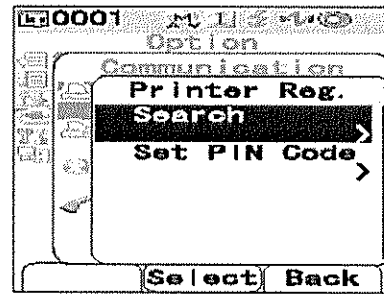

- 5** Use the Δ or ∇ button of the cross key to move the cursor to the Bluetooth address of the printer.

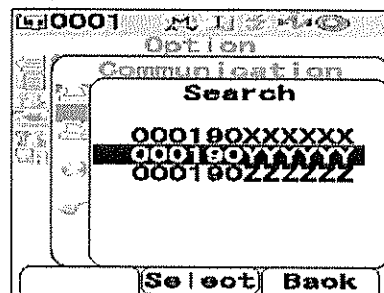

- 6** Press the [SAVE/SEL] button.

The printer is registered as the printing destination of the instrument. Now you can print measured data or other data from the printer.

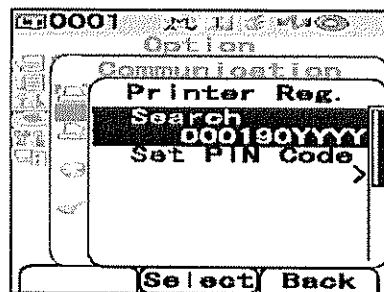

Setting the PIN Code

[Operating Procedure] Start the procedure from the <Printer Reg.> screen.

- 1 Use the Δ or ∇ button of the cross key to move the cursor to "Set PIN Code" and then press the [SAVE/SEL] button.

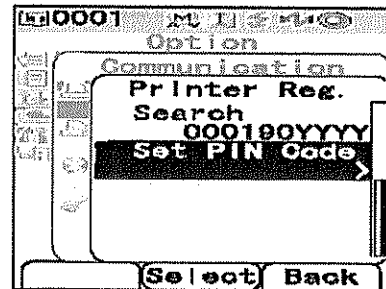

- 2 Use the \triangleleft or \triangleright button of the cross key to move the cursor, and use the Δ or ∇ button to change the value.

- Use the \triangleleft button of the cross key to move the cursor backward to modify the value.
- Pressing the [SAMPLE] (Clear) button erases all codes.
- Up to 8 digits can be entered.
- The input range for each digit is 0 to 9.
- The spaces between the values will change to 0 after the code is saved.

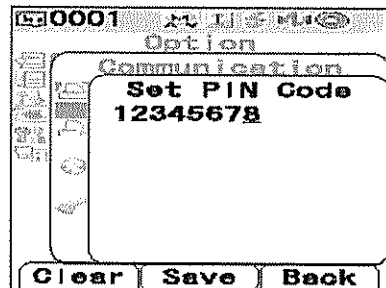

- 3 After entering all digits, press the [SAVE/SEL] button.

The screen returns to the <Scanner Reg.> screen.

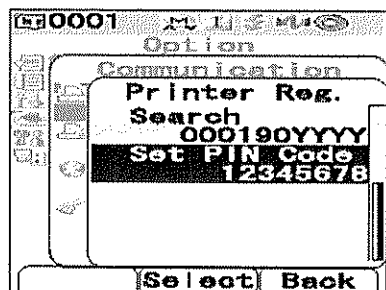

Printing Measured Data

Print the measured data with the printer.

Note

- You need to establish the connection between the instrument and printer in advance.
- The Bluetooth printer can print text data only. Note that you cannot print graphs even when you selected spectral graph or color difference graph for the display type for the instrument.

[Operating Procedure] start the procedure from the screen where the measured data is displayed.

- 1 Press the [MENU] button.
The <Menu> screen of the <Sample> screen is displayed.

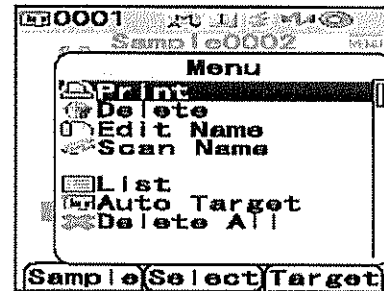

- 2 Use the Δ or ∇ button of the cross key to move the cursor to "Print".

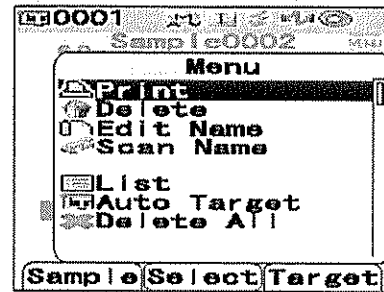

- 3 Press the [SAVE/SEL] button. The <Print> screen is displayed and the data is printed from the connected printer.
When the printing is complete, the screen returns to the <Sample> screen.

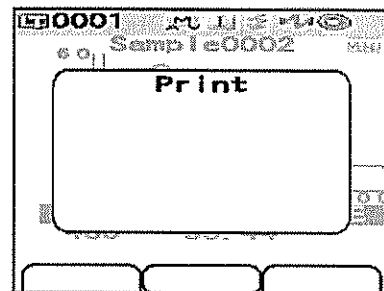

Auto Print

Print measurement results automatically from the printer every time measurement is performed.

Note

- You need to establish the connection between the instrument and printer in advance.
- The Bluetooth printer can print text data only. Note that you cannot print graphs even when you selected spectral graph or color difference graph for the display type for the instrument.

[Printing procedure]

- 1 Hold down the [MENU] button and press the ∇ button of the cross key.

The <Option> screen is displayed.

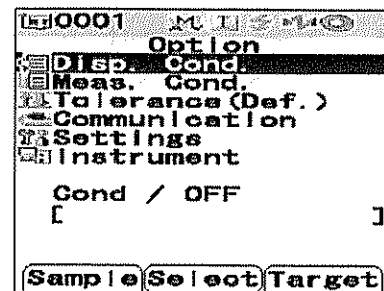

- 2 Use the Δ or ∇ button of the cross key to move the cursor to "Communication" and then press the [SAVE/SEL] button.

The <Communication> screen is displayed.

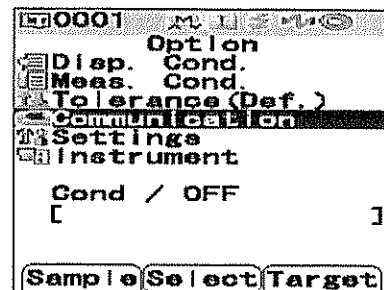

- 3 Use the Δ or ∇ button of the cross key to move the cursor to "Auto Print" and then press the [SAVE/SEL] button.

The <Auto Print> screen is displayed.

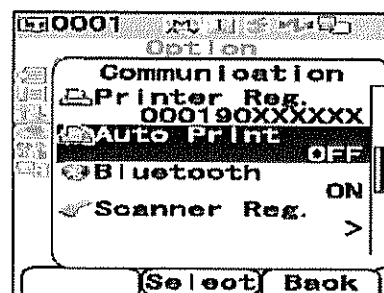

- 4 Use the ∇ button of the cross key to move the cursor to "ON" and then press the [SAVE/SEL] button.

The Auto Print function is set to ON and measurement results will be printed automatically every time measurement is performed.

When the setting finishes, the screen returns to the <Communication> screen.

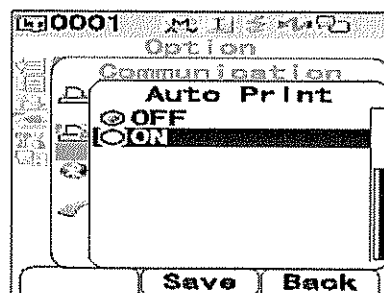

• Print Example 1

Display type is Graph Spec (spectral graph).

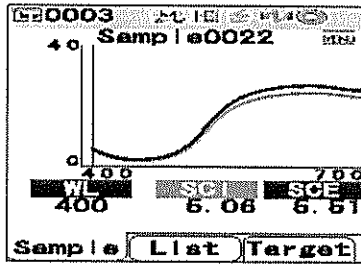

S/N 10000005		
SAMPLE 0022		
[SAMPLE 1]		
	SC1	SCE
400nm	5.06	5.51
410nm	3.60	4.02
420nm	2.78	3.10
430nm	2.18	2.37
440nm	1.92	2.05
450nm	1.94	2.08
460nm	2.08	2.23
470nm	2.35	2.52
480nm	2.77	2.98
490nm	3.49	3.78
500nm	4.60	4.97
510nm	6.38	6.83
520nm	8.79	9.54
530nm	11.90	12.92
540nm	15.08	16.38
550nm	17.74	19.27
560nm	19.70	21.40
570nm	21.03	22.85
580nm	21.97	23.89
590nm	22.68	24.65
600nm	23.15	25.15
610nm	23.37	25.39
620nm	23.41	25.45
630nm	23.47	25.52
640nm	23.59	25.68
650nm	23.71	25.79
660nm	23.83	25.91
670nm	23.85	25.94
680nm	23.48	25.54
690nm	22.90	24.91
700nm	22.69	24.68
11/16/2007 21:23:42		
0003 M/I+E		

• Print Example 2

Display type is Graph Diff. (color difference graph).

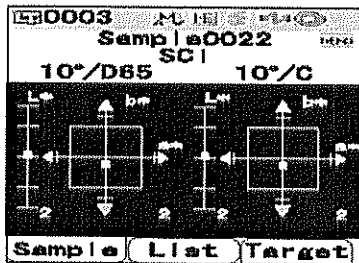

S/N 10000005		
SAMPLE 0022		
[SAMPLE 1]		
SC1	10 /D65	10 /C
L*	46.40	46.47
a*	11.80	10.57
b*	49.46	49.87
dL*	0.06	0.06
dA*	-0.07	-0.06
dB*	-0.38	-0.38
dE00	0.13	0.13
11/16/2007 21:23:42		
0003 M/I+E		

MEMO

If the color difference result fails, “[]” is appended after the value.

Connecting to an External Device

- Print Example 3
Display type is Judge.

```

0003  Sample 0022
[SAMPLE 1]
Pass
11/16/2007 21:23:42
0003 M/I+E
Sample List Target
    
```

```

S/N 10000005
SAMPLE 0022 PASS
[SAMPLE 1]
SCI 10 /D65 10 /C
L* 46.40 46.47
a* 11.80 10.57
b* 49.46 49.87
dL* 0.06 0.06
da* -0.07 -0.06
db* -0.38 -0.38
dE00 0.13 0.13
HI 0.01 0.01
SCE 10 /D65 10 /C
L* 48.14 48.22
a* 12.17 10.90
b* 50.95 51.37
dL* 0.14 0.14
da* -0.06 -0.06
db* -0.29 -0.29
dE00 0.16 0.16
HI 0.00 0.00
11/16/2007 21:23:42
0003 M/I+E
    
```

- Print Example 4
Display type is Abs. & Diff. (absolute value & color difference).

```

0004  Sample 0328
[No Name]
SCI 2° /0 2° /D65
L* 49.37 49.38
a* 3.84 2.82
b* -16.51 -16.35
L* 50.05 50.04
a* 3.77 2.86
b* 16.47 16.31
CMC 42.75 42.46
2009/01/15 17:25:17
0004 M/I
Sample List Target
    
```

```

S/N 11010110
SAMPLE 0320 FAIL
[No Name]
SCI 2 /C 2 /D65
L* 49.37 49.38
a* 3.64 2.82
b* -16.51 -16.35
dL* -50.05[] -50.04[]
da* 3.77[] 2.96[]
db* -16.47[] -16.31[]
CMC 42.75 42.45
2009/01/15 17:25:17
0004 M/I
    
```

- Print Example 5
Display type is Pseudo Color.

```

0003  Sample 0022
[SAMPLE 1]
10° /D65 10° /C
11/16/2007 21:23:42
0003 M/I+E
Sample List Target
    
```

```

S/N 10000005
SAMPLE 0022 PASS
[SAMPLE 1]
SCI 10 /D65 10 /C
L* 46.40 46.47
a* 11.80 10.57
b* 49.46 49.87
dL* 0.06 0.06
da* -0.07 -0.06
db* -0.38 -0.38
dE00 0.13 0.13
HI 0.01 0.01
11/16/2007 21:23:42
0003 M/I+E
    
```

Connecting a Bar Code Scanner

You can scan the “name” of the data to be saved in the instrument with a Bluetooth bar code scanner, and set it as the data name saved in the instrument.

Memo

To use the Bluetooth function of the instrument to connect a bar code scanner, preparation for starting the Bluetooth communication is required on the instrument and bar code scanner respectively.

Note

- *The CM-700A/600d is compatible with the Bluetooth bar code scanner conforming to SPP (Serial Port Profile).*
- *The “name” should be an ASCII character string of 11 characters or less and be suffixed with “CR+LF”.*

Preparation of the Bar Code Scanner

Prepare the Bluetooth bar code scanner so that the instrument recognizes it as a Bluetooth device.

Note

The following describes the basic procedure. For details, refer to the separate manual “Bluetooth Setting-up Guide” and the instruction manual of the Bluetooth bar code scanner.

[Operating Procedure]

- 1** Set the bar code scanner so that it can be used in Bluetooth communication.
Check that the communication mode of the bar code scanner is set to “Bluetooth”.
- 2** Check the Bluetooth address of the bar code scanner.

Connecting to an External Device

Preparation of the Instrument

Set the Bluetooth capability of the instrument to ON.

Note

You cannot register a Bluetooth bar code scanner until the Bluetooth capability of the instrument is set to ON.

[Operating Procedure]

- 1 Hold down the [MENU] button and press the ∇ button of the cross key.

The <Option> screen is displayed.

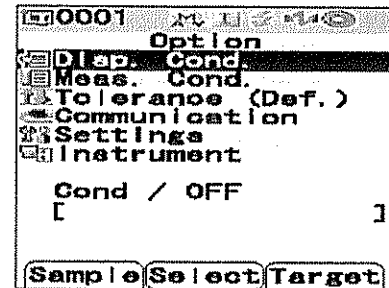

- 2 Use the Δ or ∇ button of the cross key to move the cursor to "Communication" and then press the [SAVE/SEL] button.

The <Communication> screen is displayed.

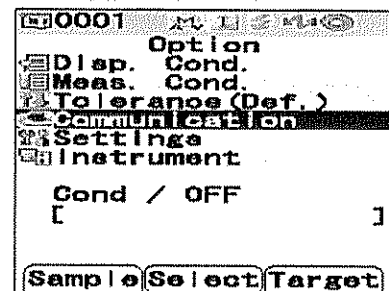

- 3 Use the Δ or ∇ button of the cross key to move the cursor to "Bluetooth" and then press the [SAVE/SEL] button.

The <Bluetooth> screen is displayed.

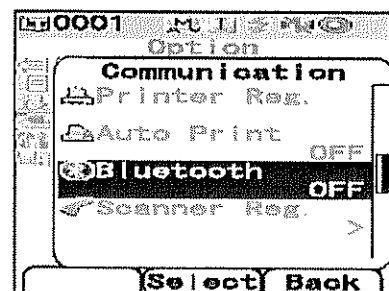

- 4 Use the ∇ button of the cross key to move the cursor to "ON" and then press the [SAVE/SEL] button.

The Bluetooth capability of the instrument is turned ON and can be used.

When the setting finishes, the screen returns to the <Communication> screen.

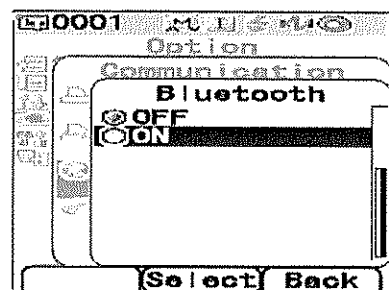

Establishing the Connection between the Instrument and Bar Code Scanner

Set the instrument as a host and establish a connection between the instrument and Bluetooth bar code scanner via Bluetooth communication.

Note

Confirm the following before starting the procedure below.

- The bar code scanner is turned ON and its battery has been fully charged.
- The instrument is turned ON (The Power switch is set to "I").
- The Bluetooth capability of the instrument is set to ON.
- No PC or printer is connected via Bluetooth connection or a USB cable.

Retrieving the Bluetooth Address

[Operating Procedure]

- 1 Hold down the [MENU] button and press the ∇ button of the cross key.

The <Option> screen is displayed.

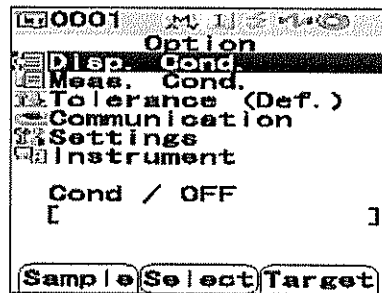

- 2 Use the Δ or ∇ button of the cross key to move the cursor to "Communication" and then press the [SAVE/SEL] button.

The <Communication> screen is displayed.

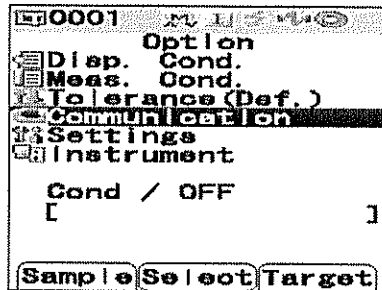

- 3 Use the Δ or ∇ button of the cross key to move the cursor to "Scanner Reg." and then press the [SAVE/SEL] button.

The <Scanner Reg.> screen is displayed.

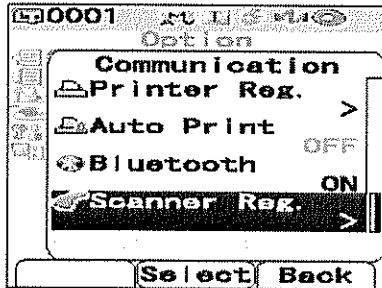

- 4 Confirm that "Search" is highlighted and then press the [SAVE/SEL] button. Available Bluetooth devices are searched for and the result is listed on the LCD screen.

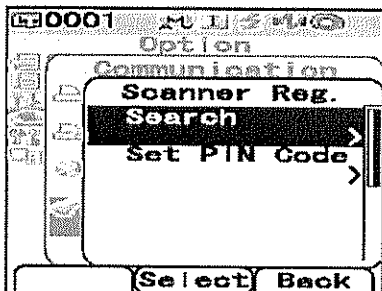

Connecting to an External Device

- From the list, find the Bluetooth address of the bar code scanner you checked during the procedure of page E-111 "Preparation of the Bar Code Scanner".
- The search result may not be correct depending on the radio wave condition of the surrounding environment. If you cannot find the Bluetooth address of your bar code scanner in the list, make sure that the bar code scanner is turned ON and its battery is fully charged, and then try the search again.

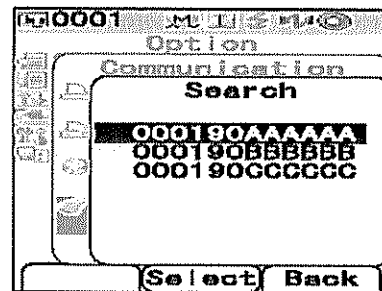
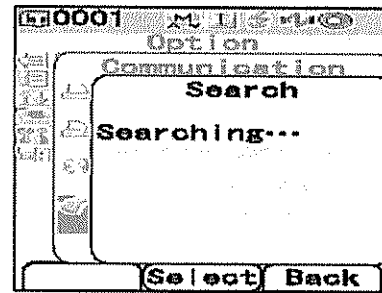

- 5** Use the Δ or ∇ button of the cross key to move the cursor to the Bluetooth address of the bar code scanner.

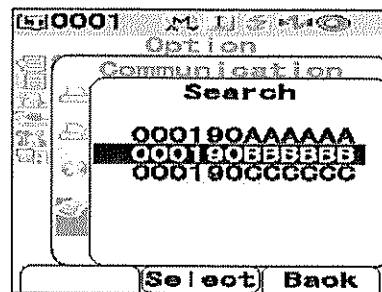

- 6** Press the [SAVE/SEL] button.
The bar code scanner is registered as the one used for data name input.

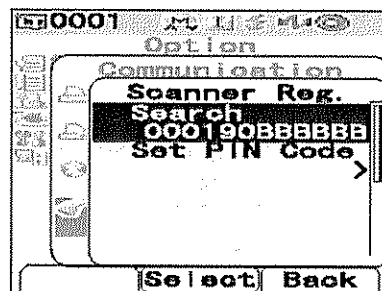

Setting the PIN Code

[Operating Procedure] start the procedure from the <Printer Reg.> screen.

- 1** Use the Δ or ∇ button of the cross key to move the cursor to "Set PIN Code" and then press the [SAVE/SEL] button.

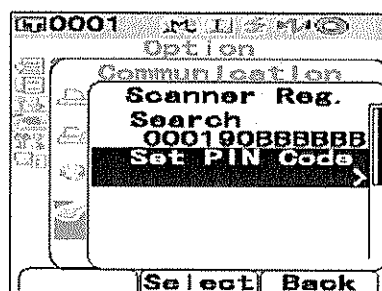

2 Use the ◀ or ▶ button of the cross key to move the cursor, and use the ▲ or ▼ button to change the value.

- Use the ◀ button of the cross key to move the cursor backward to modify the value.
- Pressing the [SAMPLE] (Clear) button erases all codes.
- Up to 8 digits can be entered.
- The input range for each digit is 0 to 9.
- The spaces between the values will change to 0 after the code is saved.

3 After entering all digits, press the [SAVE/SEL] button.

The screen returns to the <Scanner Reg.> screen.

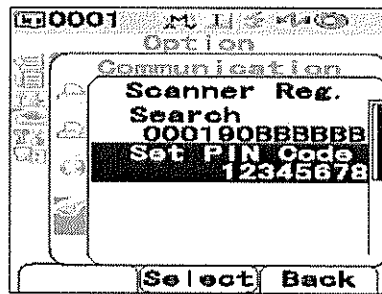
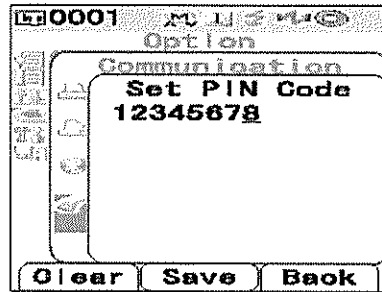
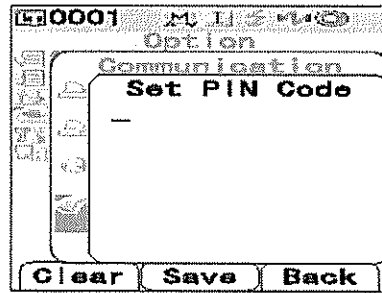

Setting Auto Scan

Enable "Auto Scan" of the Scan Name function.

Note

The bar code scanner should be registered with the instrument beforehand.

Memo

For the method to register the bar code scanner with the instrument, refer to page E-111 "Connecting a Bar Code Scanner".

[Operating Procedure]

- 1 Hold down the [MENU] button and press the ∇ button of the cross key.

The <Option> screen is displayed.

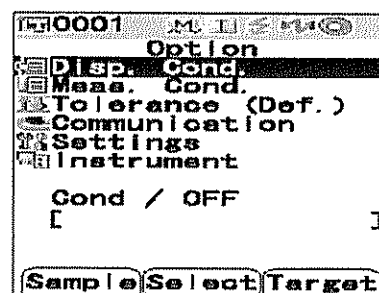

- 2 Use the Δ or ∇ button of the cross key to move the cursor to "Communication" and then press the [SAVE/SEL] button.

The <Communication> screen is displayed.

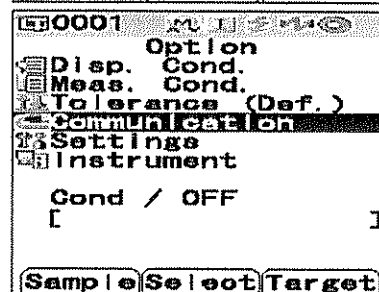

- 3 Use the Δ or ∇ button of the cross key to move the cursor to "Auto Scan Call" and then press the [SAVE/SEL] button.

The <Auto Scan Call> screen is displayed.

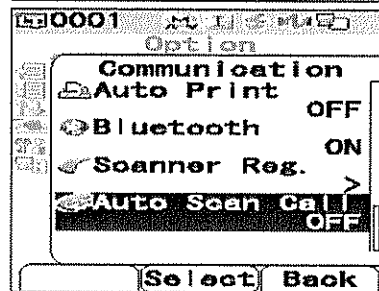

- 4 Use the ∇ button of the cross key to move the cursor to "ON" and then press the [SAVE/SEL] button.

The Auto Scan function is set to ON.

When the setting is complete, the screen returns to the <Communication> screen.

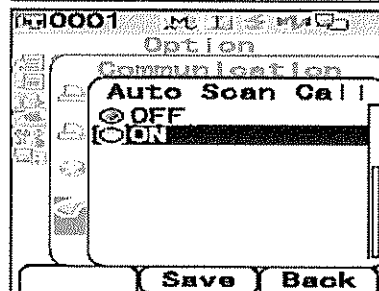

Displaying the Instrument Information

Display the model name, version, and serial number of the instrument.

[Operating Procedure]

- 1 Hold down the [MENU] button and press the ∇ button of the cross key.

The <Option> screen is displayed.

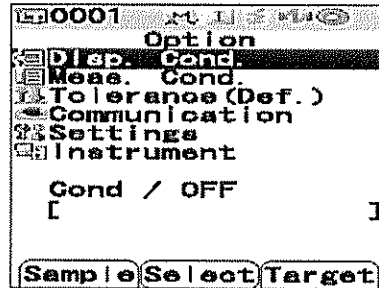

- 2 Use the Δ or ∇ button of the cross key to move the cursor to "Instrument" and then press the [SAVE/SEL] button.

The <Instrument> screen shows either of the following items depending on the instrument setting.

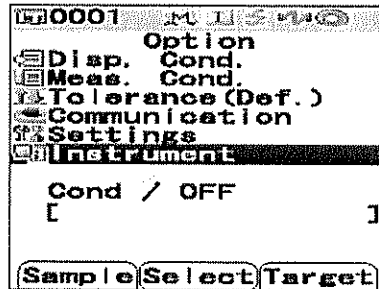

When the annual service recalibration recommendation message display is set to "Show"

The model name, version, serial number, and the month/year when the next annual service recalibration recommendation message will be displayed are displayed.

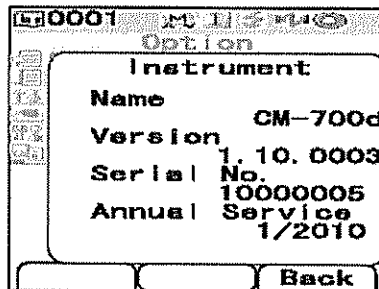

When the annual service recalibration recommendation message display is set to "Hide"

The model name, version, and serial number are displayed.

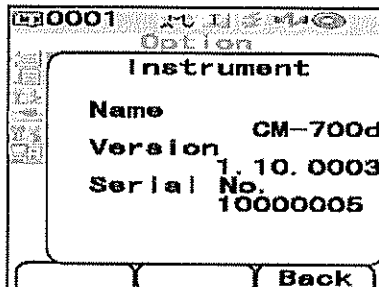

- 3 Press the [TARGET] (Back) button to return to the <Option> screen.

Showing/Hiding the Annual Service Recalibration Recommendation Message

When about one year passes after the factory shipment or the calibration service (or maintenance) conducted by KONICA MINOLTA SENSING-authorized service facility, the CM-700d/600d shows a message “WR050 Annual service recalibration recommended.” at start-up to recommend annual service recalibration.

You can set this message display to be shown or hidden.

Note

Although the annual service recalibration recommendation message display can be hidden, it is recommended to accept our recalibration service.

Memo

The message display is set to “Show” before the factory shipment.

You can set the annual service recalibration recommendation message display when you turn on the instrument as in the procedure below.

[Operating Procedure] Start the procedure when the instrument is turned off.

1 Hold down the [CAL] button and turn ON the instrument.

- Keep holding down the [CAL] button until the <Calibration> screen appears.

The show/hide status of the annual service recalibration recommendation message is toggled by this operation.

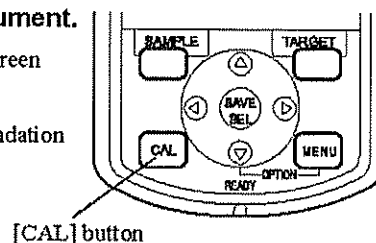

Checking the Message Display Setting

You can check whether the annual service recalibration recommendation message display is set to show or hide by displaying the instrument information.

Memo

For the method to show the instrument information, refer to page E-117 “Displaying the Instrument Information”.

When the annual service recalibration recommendation message display is set to “Show”

The model name, version, serial number, and the month/year when the next annual service recalibration recommendation message will be displayed are displayed.

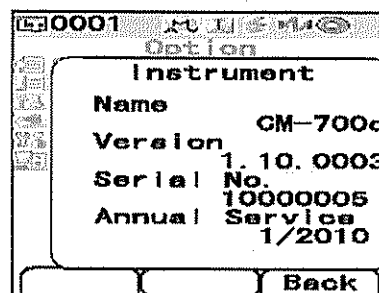

When the annual service recalibration recommendation message display is set to “Hide”

The model name, version, and serial number are displayed.

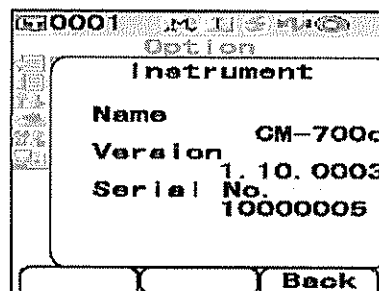

Chapter 5

Troubleshooting



Error Messages

The following messages may appear while you are using the instrument. If such messages appear, take the necessary actions shown in the table below. If the trouble does not go away in spite of taking action, contact a KONICA MINOLTA SENSING-authorized service facility.

Note

Messages that may be displayed on the LCD are given in the table below. For communication error check codes, refer to the separate document.

Messages	Symptom/Possible Cause	Corrective Action
Preparing to auto select target color	(When the setting of "Auto Target" is ON) <ul style="list-style-type: none"> Preparing auto target color settings. 	Wait for a moment. *When the setting of "Auto Target" function is ON, or when power switch is turned ON with auto target setting ON, this message will appear. When preparations are completed, this message will disappear.
ER002 LOW BATTERY	(When the instrument is powered by batteries) <ul style="list-style-type: none"> Battery voltage drop 	Turn the power OFF, and then turn it ON again after changing batteries to new ones or connecting the AC adapter.
ER005 ERROR IN FLASHING	Xenon lamp does not flash properly. <ul style="list-style-type: none"> Xenon lamp has blown. Faulty flash circuit. Faulty sensor 	If this message keeps appearing, contact a KONICA MINOLTA SENSING-authorized service facility.
ER007 INCORRECT CLOCK OPERATION	Clock IC is not working correctly. <ul style="list-style-type: none"> Since power voltage of backup battery is exhausted due to instrument not being used for a long time, data of calendar or clock has been lost. Internal backup battery has reached the end of its life. Breakdown of circuits relating to the clock IC. 	Set date and time after charging the internal backup battery. If this message keeps appearing, contact a KONICA MINOLTA SENSING-authorized service facility.
ER010 NO DATA IN MEMORY	Data for performing user calibration has not been input in the instrument's memory.	For performing user calibration, the user calibration data must be input to the instrument's memory by connecting with computer and using the optional software before user calibration setting is set to ON. For details of the optional software, read the software manual.
ER011 FAILED IN CALIBRATION	Zero calibration or white calibration has not been performed correctly.	For zero calibration, the specimen measuring port must be directed into the air. For white calibration, the White Calibration Cap must be used.
	Target Mask is not correct.	Attach the correct Target Mask.
ER013 ERROR IN A/D	Failed during A/D conversion. <ul style="list-style-type: none"> Faulty A/D converter Breakdown of circuits relating to the A/D converter 	Turn the power OFF, and then turn it ON again. If this message keeps appearing, contact a KONICA MINOLTA SENSING-authorized service facility.

Messages	Symptom/Possible Cause	Corrective Action
ER024 WHITE CALIBRATION INCOMPLETE	White calibration has not been completed.	White calibration must be performed the first time the instrument is turned ON for any measurement area. It is also recommended that white calibration be performed whenever the instrument is switched from OFF to ON or when the measurement area or specular component setting is changed.
ER025 MEASUREMENT AREA CHANGED	Measurement area has been changed. Set the correct area and measure again.	Confirm the measurement area, and then perform the measurement. Do not change the measurement area while performing a measurement.
ER027 ERROR IN CHARGING	Charging for flashing of xenon lamp cannot be completed. <ul style="list-style-type: none"> • Battery exhausted • Breakdown of charging circuit 	When batteries are used, replace them with new ones. If this message is still displayed after battery replacement, contact a KONICA MINOLTA SENSING-authorized service facility.
ER030 MEMORY ERROR	Data has been lost since the memory's backup battery is exhausted.	Turn the power ON to charge the memory's backup battery. The backup battery can be fully charged in 24 hours when the power of this instrument is turned ON. After the battery is fully charged, data backup can be stored for approximate 5 months.
ER036 USER CALIBRATION INCOMPLETE	User calibration has not been performed.	When user calibration is set to on, calibration must be performed the first time the instrument is switched ON for any measurement area. It is also recommended that calibration be performed whenever the instrument is switched from OFF to ON or when the measurement area or specular component setting is changed.
ER069 PROTECTED DATA	Color difference target data have been protected and cannot be overwritten.	If it is necessary to rewrite or delete the protected target data, change the data protect setting of the target to OFF.
ER080 SELECT AT LEAST 1 DISP.TYPE	No Display Type is selected.	Select at least one display type.
ER081 PRINT ERROR RETRY BY MANUAL PRINT	Print error is occurred because no print data has been sent. <ul style="list-style-type: none"> • Printer is not ON. • Connection to the printer is incorrect. • PIN code of the printer is not set properly. 	Check connection between the instrument and the printer, and then print again manually.
ER082 SCANNER ERROR RETRY BY MANUAL SCAN	Scan Name operation failed because the data cannot be obtained from the bar code scanner. <ul style="list-style-type: none"> • Bar code scanner is not ON. • Connection to the bar code scanner is incorrect. • PIN code of the bar code scanner is not set properly. 	Check connection between the instrument and the bar code scanner, and then try Manual Scan of Scan Name.

Error Messages

Messages	Symptom/Possible Cause	Corrective Action
WR002 LOW ILLUMINATION	Amount of light from the xenon lamp has dropped to 50% of its initial level. <ul style="list-style-type: none"> • Deterioration of xenon lamp • Dirt on integrating sphere 	Clean the integrating sphere as explained in "Cleaning Parts" on page E-16. If the problem still remains, contact a KONICA MINOLTA SENSING-authorized service facility.
WR050 WE RECOMMEND RE-CALIBRATION SERVICE	Since a certain period of time has passed since the instrument was last calibrated, recalibration is recommended.	For recalibration service, contact a KONICA MINOLTA SENSING-authorized service facility. This message display can be set to hide. For the setting procedure, refer to page E-118 "Showing/Hiding the Annual Service Recalibration Recommendation Message".
WR112 USER CALIBRATION DATA NOT SET	It is necessary to input data for user calibration before setting the user calibration ON.	For performing user calibration, the user calibration data must be input to the instrument's memory by connecting with computer and using the optional software before user calibration setting is set to ON. For details of the optional software, read the software manual.
WR120 MEASUREMENT PROCESS INTERRUPTED	Measurement has been canceled.	When the averaging measurement setting is set to ON, pressing any button other than measuring button can cancel the measurement. If it is not necessary to cancel the measurement, do not touch any button other than the measurement button during measurement.
WR121 CALIBRATION RECOMMENDED	White calibration (or user calibration when the user calibration setting is ON) has not been performed yet after the power was switched on.	In order to ensure the reliability of white calibration, performing white calibration is recommended when the power is switched from OFF to ON or when the measuring environment (measurement area, etc.) has changed.
WR123 Please restart instrument.	It is necessary to restart the instrument. <ul style="list-style-type: none"> • Memory error or incorrect clock • Executing initialization 	Turn the power OFF, and then turn it ON again.

Troubleshooting

If an abnormality has occurred with the instrument, take necessary actions as given in the table below. If the instrument still does not work properly, turn the power OFF, and then turn it ON again. If the symptom remains, contact a KONICA MINOLTA SENSING-authorized service facility.

Symptom	Check Point	Action
LCD is blank.	Are batteries inserted? Is the AC adapter connected?	Insert the batteries. Connect the AC adapter.
	Is  displayed? Or are batteries extremely low?	Replace the batteries with new ones. Or connect the AC adapter.
	Are batteries inserted correctly?	Reinsert the batteries correctly.
Measuring button is not effective.	Is measurement still in progress?	Wait until measurement is complete, and then press the button.
	Is a screen where measurements are possible displayed?	Measuring button must be pressed while a screen that allows measurements (e.g. Calibration, Target, or Measurement screen) is shown.
Abnormal measurement result	Is the instrument directed perpendicular to the specimen?	Make sure that the instrument is directed perpendicular to the specimen, to prevent leakage of light.
	Was the correct White Calibration Cap used for calibration?	Use the correct White Calibration Cap (the cap with same pairing number as the instrument) to perform white calibration. (page E-24)
	Was white calibration performed correctly?	
	Was zero calibration performed correctly?	Direct the specimen measuring port into the air or use the optional Zero Calibration Box and perform zero calibration.
Measurement results fluctuate.	Is instrument kept stationary during measurement?	Do not allow the instrument to move during measurement.
Not possible to input data to the computer. No commands from computer are accepted. Commands cannot be accepted correctly.	Is the USB cable connected correctly?	Connect the instrument's USB connecting terminal to the computer's USB port with the USB cable supplied with the instrument.
	Is the USB cable supplied with the instrument used?	
	Is Bluetooth communication functioning correctly?	Install a Bluetooth adapter on the computer or enable the computer's Bluetooth function (if computer is so equipped), and then check that communication between the computer and instrument is functioning correctly.
Not possible to print.	Is Bluetooth communication functioning correctly?	Check that Bluetooth communication between this instrument and the Bluetooth printer is functioning correctly.

Troubleshooting

Symptom	Check Point	Action
Measurement data or settings are not held in memory, and disappear immediately.	The instrument's backup battery may be low immediately after purchase or following a period of prolonged non-use. Turn the power of the instrument ON to charge the backup battery. Under this condition, the battery can be fully charged in 24 hours.	The backup battery has an expected service life of approximately ten years. If you find that the instrument fails to retain data in memory even after the battery has been fully charged, however, then it is likely that your battery has reached the end of its life and requires replacement. Note that you cannot replace the battery yourself. For information, please contact a KONICA MINOLTA SENSING-authorized service facility.

Chapter 6

Appendix



Principles of Measurement

Illuminating/Viewing System

This instrument utilizes the $di:8^\circ/de:8^\circ$ geometry conforming to CIE No. 15, ASTM E1164, DIN 5033 Teil 7, ISO 7724/1, and JIS Z8722-1982 (diffused illumination, 8-degree viewing angle) standards, and offers measurement with automatic SCI (specular component included) and SCE (specular component excluded) switching.

The flow of measurement is shown below.

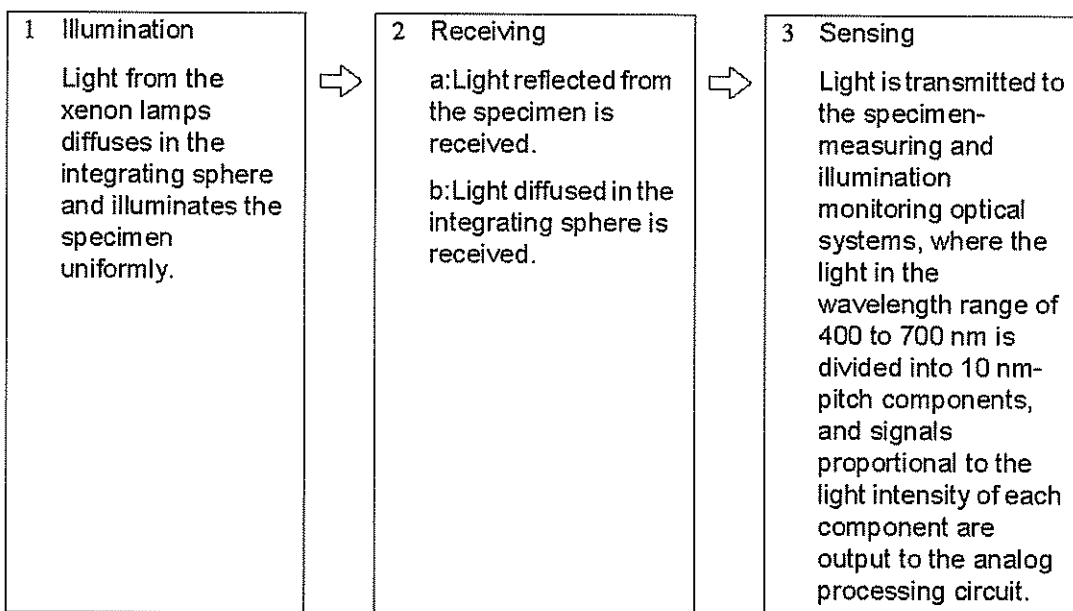

- 1 Light from the xenon lamps diffuses on the inner surface of the integrating sphere and illuminates the specimen uniformly.
- 2
 - a: The light reflected from the specimen surface at an angle of 8° to the normal of the surface is received by the specimen-measuring optical system.
 - b: The light diffused in the integrating sphere is received by the illumination-monitoring optical system and guided to the sensor.
- 3 The light reflected from the specimen surface and the diffused light are divided into each wavelength component by the specimen-measuring optical system and illumination-monitoring optical sensor respectively, and then signals proportional to the light intensity of each component are output to the analog processing circuit.

By processing the outputs from the specimen-measuring optical system and the illumination-monitoring sensor with the calculation by the CPU, the instrument compensates for slight fluctuations in the spectral characteristics and intensity of the illumination light. (Double-beam system)

Illumination Area and Measurement Area

The CM-700d/600d allows selection from two measurement areas, SAV ($\phi 3$ mm) and MAV ($\phi 8$ mm), according to the specimen and applications. A Target Mask (illumination area) suitable for the selected measurement area must be attached to the instrument.

Note

With the CM-600d, only MAV ($\phi 8$ mm) is available.

Target Mask (illumination area)

The CM-700d/600d does not have a function to automatically detect whether the currently-attached Target Mask is for SAV or MAV. You need to attach the correct Target Mask according to the selected measurement area.

Since the Target Mask's tip condition affects measured values, do not touch the inner surface by hand, scratch it or allow it to get dirty.

Measurement Area

The measurement area can be switched by sliding the measurement area selector.

Note

With the CM-600d, only MAV ($\phi 8$ mm) is available. Consequently, it does not have a measurement area selector.

Simultaneous SCI/SCE Measurement

The CM-700d/600d offers simultaneous SCI (Specular Component Included)/SCE (Specular Component Excluded) measurement by using "automatic SCI/SCE switching with an automatic optical trap mechanism".

Automatic optical trap mechanism

An optical trap automatically opens or closes according to the specular component mode (SCI/SCE/I + E) specified with the instrument.

The light source flashes once for SCI measurement and once for SCE measurement respectively. When Auto Averaging is specified, the flash is repeated for the specified number of measurements.

In either SCI or SCE mode, the automatic optical trap mechanism is not used. In I + E (SCE + SCE) mode, the automatic optical trap mechanism is enabled. For the first flash, SCI measurement is performed with the optical trap closed. For the second flash, SCE measurement is performed with the optical trap open.

Communication Mode

The CM-700d/600d is set to the communication mode when it is connected to a PC. When the instrument is controlled from the PC, the instrument's LCD screen shows "Communicating". While this message is displayed, the buttons of the instrument are disabled.

You can, however, send a command from the PC to the instrument to set it to the measuring button enabled mode, so that you can start measurement by pressing the measuring button of the instrument. In this case, the measured data is transferred to the PC and is not stored in the memory of the instrument. If you want to control the instrument from a PC, you need software that allows the connection and operation of the instrument.

If you want to develop your own program to control the instrument from a PC, contact a KONICA MINOLTA SENSING-authorized service facility.

Initial Settings

- * Initialization of the instrument will reset the settings to the initial values shown in the table below. The measured data, target color data and tolerances set for each target color are protected and not cleared by the initialization.
- * The zero calibration data will be reset to the factory-set data. If you performed zero calibration due to a change in the measurement environment, you will need to perform zero calibration again after the initialization.
- * In certain cases, the instrument is initialized due to another cause other than the initialization operation (e.g. when the built-in backup battery life expired). In this case, the measured data, target color data and tolerance setting will also be reset to the initial status (no measured data, no target color data, default tolerance setting).

	Item	Initial setting
Measurement condition	Mode (specular component mode)	I + E (SCI + SCE)
	Number of auto averaging	1
	Number of manual averaging	1
	Wait time	0 seconds
Display condition	Display type	Abs. & Diff., Judge, Graph Diff.
	Color space	L* a* b*
	Equation	ΔE_{00} (CIE2000)
	Color index	WI (ASTM E313-73)
	Observer	10° observer
	Illuminant 1	D65
	Illuminant 2	None
Condition (Cond)		OFF
Tolerance (Default) *They are the factory-set value. Initialization of the instrument will not reset the settings to this initial value.	*Set for No. 01 only (No setting for Nos. 02 to 08)	
	Color space	Upper limit: +1.5/Lower limit: -1.5 of L* a* b*, enabled
	Equation	Upper limit +1.5 of ΔE_{00} , enabled
	Color index	Upper limit: +1.5/Lower limit: -1.5 of None, enabled
	CMC factor	1.00
	ΔE_{94} factor	1.00
	ΔE_{00} factor	1.00
Zero calibration		Completed (factory-set value)
White calibration		Not performed
User calibration		Not performed

Specifications

Model		CM-700d	CM-600d
Optical system	Geometry	di: 8°, de: 8° (diffused illumination, 8-degree viewing angle), SCI (specular component included)/SCE (specular component excluded) selectable (with automatic-switching function) (Conforms to CIE No. 15, ISO7724/1, DIN5033 Teil7, ASTM E 1164, JIS Z 8722)	
	Light source	Pulsed xenon lamp (with UV cut filter)	
	Measurement/illumination area	MAV: ϕ 8 mm/ ϕ 11 mm SAV: ϕ 3 mm/ ϕ 6 mm selectable * Changeable by replacing Target Mask and selecting lens position	MAV: ϕ 8 mm/ ϕ 11 mm only
	Size of integrating sphere	ϕ 40 mm	
	Detector	Silicon photodiode array (dual 36-element)	
	Spectral separation device	Diffraction grating	
Unit specification	Wavelength range	400 nm to 700 nm	
	Wavelength pitch	10 nm	
	Half bandwidth	Approx. 10 nm	
	Measuring range	0 to 175%	
	Resolution	0.01%	
	Measurement time	Approx. 1 second	
	Minimum measurement interval	Approx. 2 seconds (in SCI or SCE mode)	
Performance	Repeatability	Spectral reflectance: Standard deviation within 0.1%, Colorimetric value: Standard deviation within ΔE^*ab 0.04 * When the White Calibration Plate is measured 30 times at 10-second intervals after white calibration	
	Inter-instrument agreement	Within ΔE^*ab 0.2 (MAV/SCI) * Based on 12 BCRA Series II color tiles compared to values measured with a master body at 23°C	
Dimensions/weight	Size	73 (W) x 211.5 (H) x 107 (D) mm	
	Weight	Approx. 550 g (without White Calibration Cap and batteries)	
Function	Display	2.36-inch TFT color LCD	
	Interfaces	USB 1.1; Bluetooth® standard version 1.2*	
	Storable data sets	Measured data: 4,000 sets/Target color data: 1,000 sets	
Power	Power	4 AA-size alkaline dry batteries or nickel-metal-hydride rechargeable batteries; Special AC adapter	
	Ratings (AC adapter)	Input: 100-240 V \sim 50/60 Hz 24-38 VA Output: 5 V \dashv 2 A	
	Battery life	With alkaline dry batteries: Approx. 2,000 measurements With nickel-metal-hydride rechargeable batteries (2300 mAh): Approx. 2,000 measurements with full charge * Stand-alone measurement fixed to either SCI or SCE mode at 10-second intervals at 23°C	
Environment	Operating temperature/humidity range	5 to 40°C; relative humidity 80% or less (at 35°C); with no condensation	
	Storage temperature/humidity range	0 to 45°C; relative humidity 80% or less (at 35°C); with no condensation	

Specifications

Observation	Displayed data	Spectral values/graph, colorimetric values, color difference values/graph, PASS/FAIL result, pseudocolor, color assessment
	Illuminant	A, C, D50, D65, F2, F6, F7, F8, F10, F11, F12 (Simultaneous evaluation with two illuminants possible)
	Observer	2°, 10°
	Color spaces	L*a*b*, L*C*h, Hunter Lab, Yxy, XYZ, Munsell, and color difference in these spaces (except for Munsell)
	Colorimetric data	MI, WI (ASTM E313-73/E313-96), YI (ASTM E313-73/ASTM D1925), ISO Brightness, 8° gloss value
	Color difference formulas	ΔE^*ab (CIE1976), ΔE^*94 (CIE1994), $\Delta E00$ (CIE2000), CMC (1:c)

The above specifications are subject to change without prior notice.

- * Applicable Bluetooth[®] profile: Serial Port Profile, Output: Bluetooth[®] Power Class 1
 The communication distance may vary depending on obstacles and radio wave conditions between the devices. Successful wireless communication is not guaranteed with all Bluetooth[®]-ready equipment. Bluetooth[®] is a registered trademark of Bluetooth[®] SIG, Inc. and it is used under license agreement. The CM-700d/600d incorporates the eT-Kernel/Standard and PrUSB/Device from eSOL Co., Ltd.

Model	CM-700d	CM-600d
Standard accessories	White Calibration Cap (w/ white calibration data CD-R): CM-A145	
	Target Mask $\phi 8$ mm (w/ plate) <For MAV>: CM-A178 * Attached to the instrument at the time of shipment	Target Mask $\phi 8$ mm (w/ plate) <For MAV>: CM-A178 * Attached to the instrument at the time of shipment
	Target Mask $\phi 3$ mm (w/ plate) <For SAV>: CM-A179	Target Mask $\phi 8$ mm (w/o plate) <For MAV>: CM-A180
	Target Mask $\phi 8$ mm (w/o plate) <For MAV>: CM-A180	
	Target Mask $\phi 3$ mm (w/o plate) <For SAV>: CM-A181	
	USB Cable (2 m): IF-A17	
	AC Adapter: AC-A305	
	4 AA-size alkaline dry batteries	
Optional accessories	Wrist Strap: CR-A75	
	Zero Calibration Box: CM-A182	
	Hard Case: CM-A176*	
	Granular-Materials Attachment: CM-A184	
	Dust Cover Set: CM-A185	
	Replacement Dust Cover (Polyolefin): CM-A186	
	Color Data Software SpectraMagic™ NX: CM-S100w	
Target Mask $\phi 8$ mm (with glass) <For MAV>: CM-A183		

- * The hard case is intended for storing the instrument. Do not use it for transportation.

Dimensions

(mm)

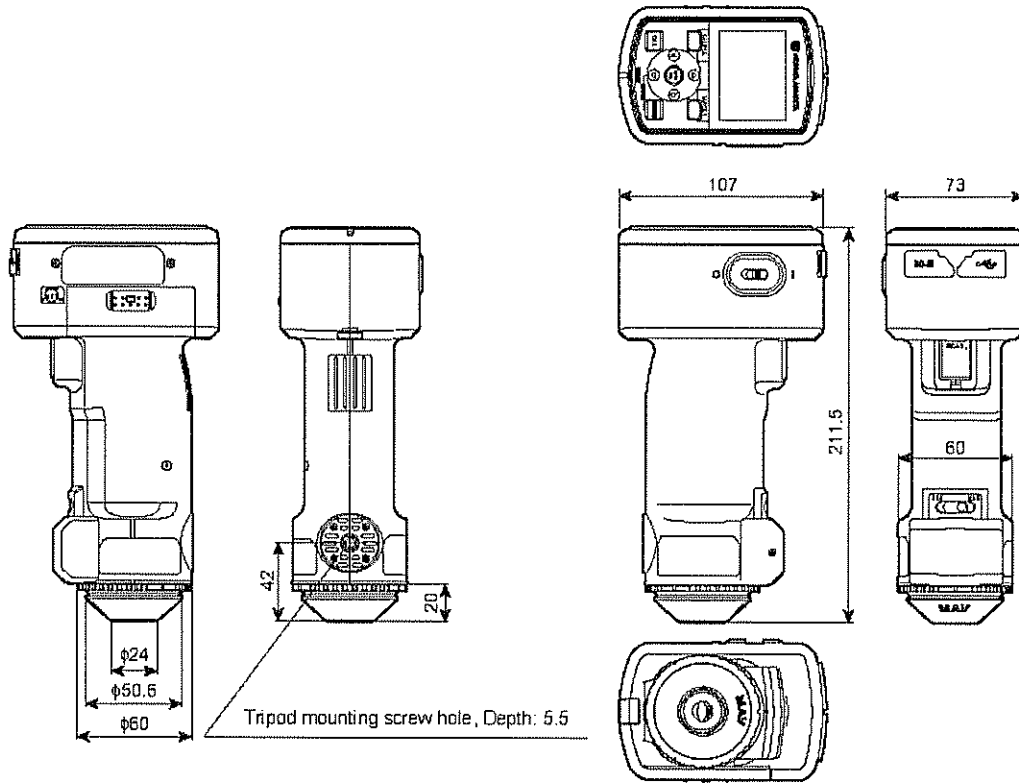

Dimensions

