

# XR SERIES USER MANUAL



VHF Transceiver

**XR-150**

**XR-150R**

UHF Transceiver

**XR-450**

**XR-450R**

Version #1 (2019-02-27)

Yeonhwa M Tech Co., Ltd.

36 Jeonpa-Ro, 44Beon-Gil, Manan-Gu, Anyang-City, Gyeongg-Do, Korea Tel: 82-31-444-7270

**XRadio**

## 1. XR Series Main Features

The XR Series Radio is developed to be user-friendly and compact design, to have various features and to use at the construction / industrial / public areas for the safety & convenience of users.

The followings are the main features of the XR Series Radio.

- 32 Groups and 1,024 Channels are selectable.
- Call guard Squelch of standardized 53 CTCSS / 208 DCS
- English and Korean setting function.
- Comander function
- Intelligent audio function
- Dual Tone Modulation Frequency (DTMF) ANI function.
- ID setting function.
- Receiving sensitivity setting function.
- E.Q ( Timbre ) setting function.
- Impress Function ( maintain a constant transmission sound)
- Lone Worker mode setting function.
- Whisper function.
- Normal scan / Priority scan function.
- 10-step VOX (Voice Operated Transmit) setting function.
- 2 Tone and 5 Tone function.
- BCL/BCLO function.
- Time-Out Timer (TOT) function.
- Monitor function.
- Speaker volume of 1 Watt.
- Wireless repeater function for expansion of communication coverage.
- Emergency / Siren function.
- Flash lighting function
- Wireless cloning
- Frequency Copy function
- 10-step Squelch selection function
- Remote Radio Stun / Kill / Revive (Use 5 tone)
- Using a variety of common accessories for each model.
- Adopt DC+7.5V 2,600mAH high capacity Li-ion Battery

## 2. Specification

### 2.1 XR-150/450

#### General

Frequency Range	XR-150/XR-150R : 138 ~ 174 MHz XR-450/XR-450R : 400~470MHz
Frequency Stability	±2.5ppm (-30 to +60°C)
Programmable Channels	1024 Channels/32 Group
Channel Spacing	Dual Channel Spacing 12.5KHz
Dimensions	111mm (H)×54mm (W)×37mm (D)
Weight	250g
Power Source	DC +7.4V Li-ion 2600mAH Battery
Current Drain (maximum)	Receive mode, rated audio out – 320 (Audio Max) Transmit mode – 1,600mA Standby mode – 90mA

#### Receiver

Sensitivity	0.25uV 12 dB SINAD
Squelch Sensitivity	0.22uV 10dB SINAD
Selectivity	65dB (12.5KHz)
Spurious and Harmonic Rejection	75dB
FM Hum and Noise	40dB (12.5KHz)
Audio Output Power	1 Watt across an 16-ohm load
Audio Distortion	Less than 3% at rated output
Audio Response	+1, -3 dB from 6dB per octave de-emphasis Characteristic from 300 ~ 3000Hz
Input Impedance	50 ohms

#### Transmitter

RF Power Output	2/4.8/Watt
Spurious and Harmonic	70dB
FM Hum and Noise	40dB (12.5KHz)
Audio Distortion	3% maximum with 1KHz modulation
Audio Frequency Response	+1, -3dB from 6dB per octave pre-emphasis Characteristic from 300 ~ 3000Hz
Output Impedance	50ohms

### 3. XR Series with Accessories

- Components could be changed by buyer request.



**Radio**



**Battery Pack**



**Dual slot Charger**



**Antenna**



**Leather Case**



**Belt Clip**



**Hand Strap**



**User Manual**

Figure 3-1) XR Series Main Components

XC-100 : Single slot charger

XC-200 : Dual slot Charger

Battery (XB-2400) : 2200mAH Li-ion battery pack

## 4. Controls & LCD Display

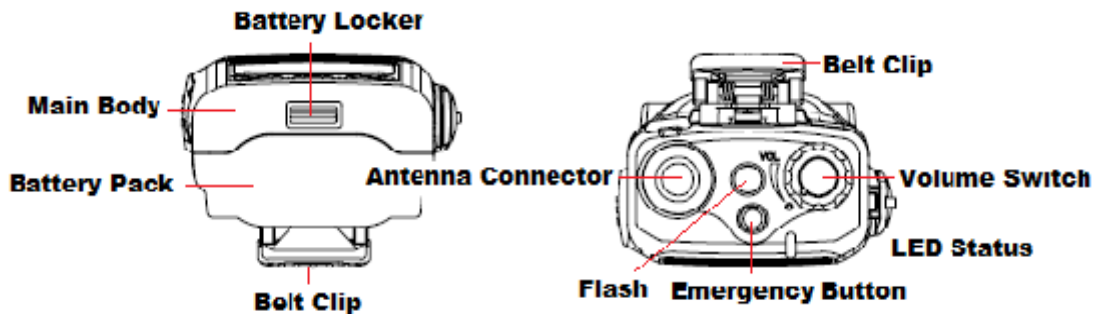
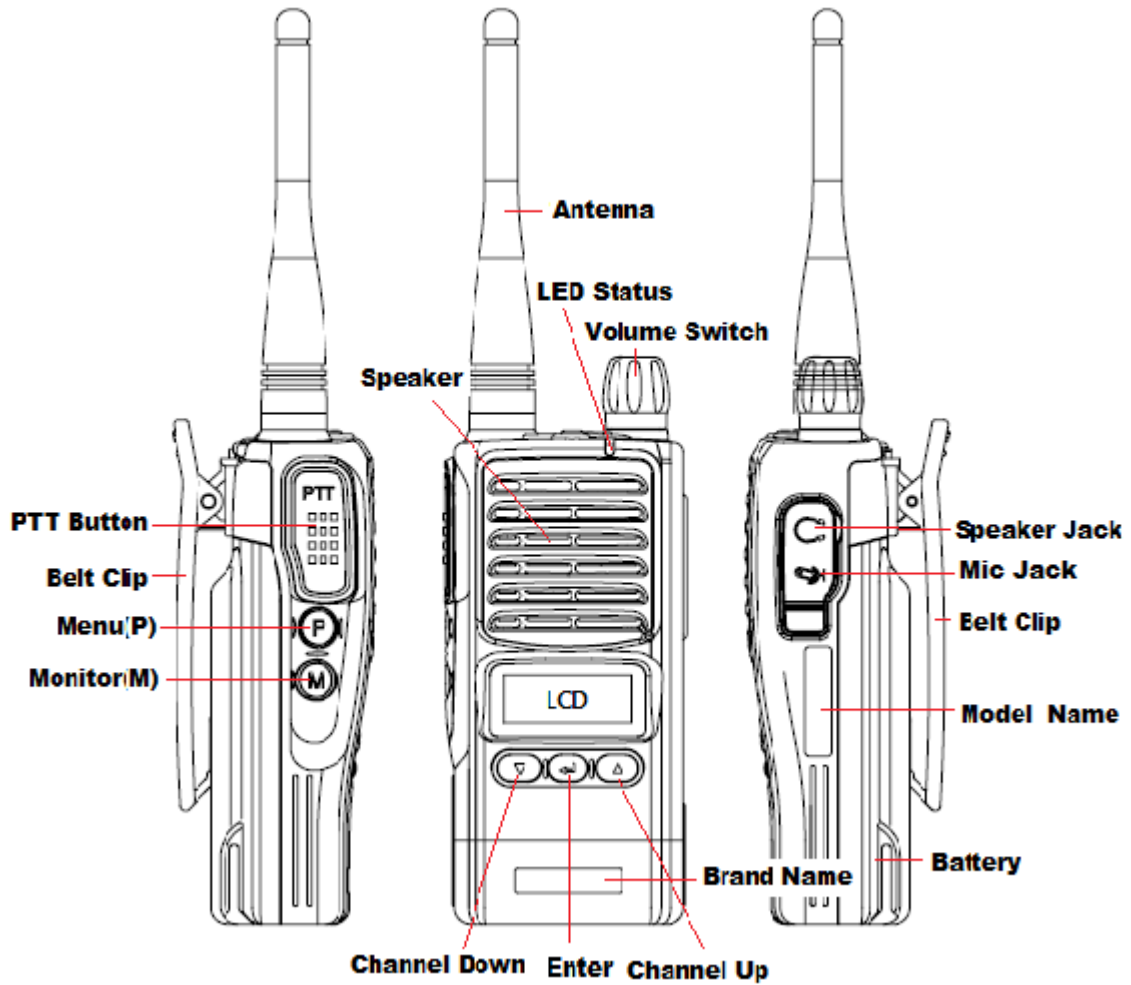

Figure 4-1) Appearance of XR Series Radio

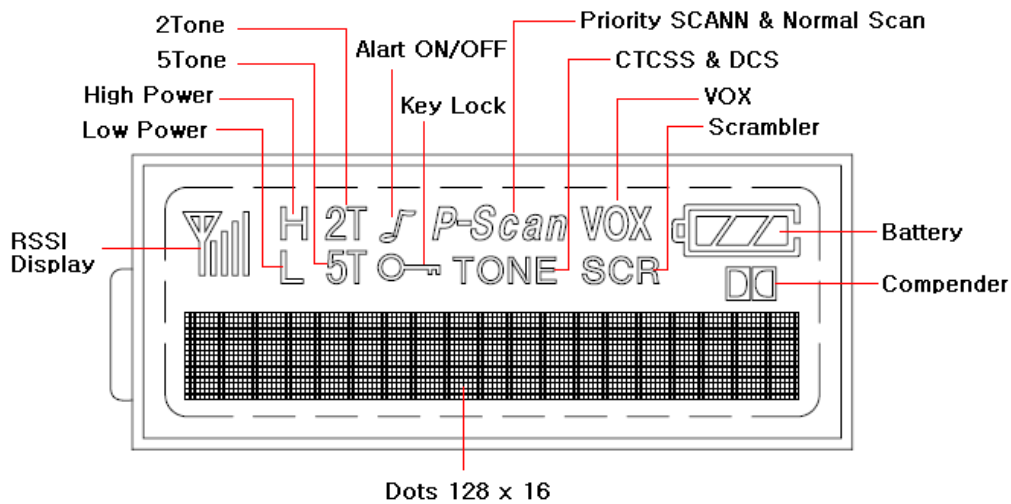

Figure 4-2) LCD Indication of XR Series Radio.

#### 4.1 Basic Button Operation Description.

Button	Operation Functions
PTT Button + Power ON	After cloning cable connection, wait cloning transmission.
Menu button + Power ON	Program mode
Monitor button + Power ON	Frequency search function (required at the time of frequency copy)
Menu button + UP button + Power ON	Wireless cloning transmission.
Menu button + Down button + Power ON	Wireless cloning receiving.
Menu button + UP button	Button fixed
Menu button + Down button	Button release
Enter button (Short key)	Flash ON/OFF
Enter button (Long key)	Scan start / stop / toggle
Emergency button	Emergency beep sound

## 5. Basic operation

Please fully read the instruction manual before use.

This manual provides important information related to radio operation.

### 2.1 Installation and Removing the Antenna

To install the antenna, insert the antenna into antenna connector and screw the antenna clockwise.

To remove the antenna, screw the antenna counter clockwise.

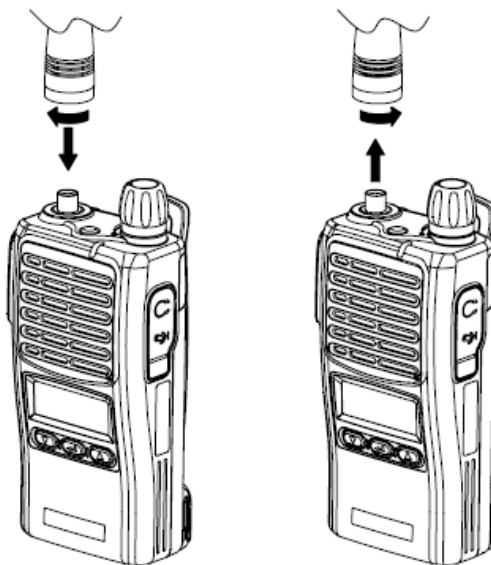



Figure 5-1) Installation and Removing the Antenna

 Caution	When installation of the antenna, giving a strong pressure to the Radio or pulling the antenna with a strong power from the Radio can make a damage on the antenna connector, which may cause the Radio to have a critical problem.
--	---

### 5.2 Installation and Removing the Battery

#### 5.2.1 Installation of the battery

To install battery, slide up the battery towards the top of the radio until battery latch is locked.

#### 5.2.2 Removing the Battery

- Slide the battery latch located on the bottom of radio to the open position as shown in Figure 5-2).
- The battery is removed by pressing it against and sliding it towards the bottom of the radio

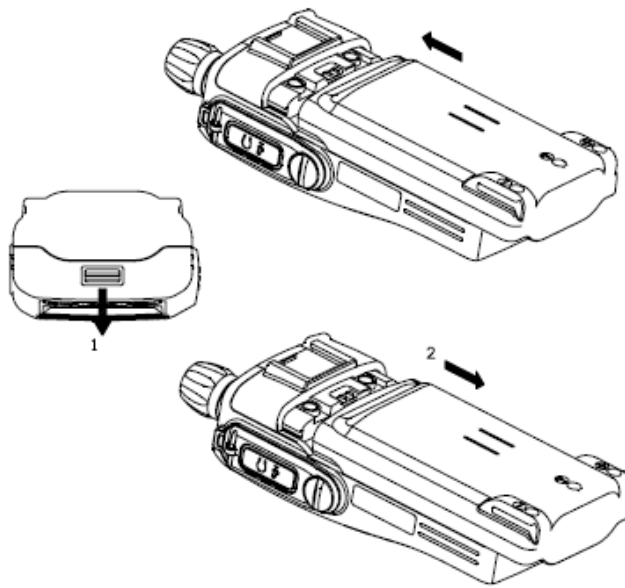

Figure 5-2) Installation and Removing the Battery

### 5.3 Installation and Removing the Belt Clip

- To attach belt clip to radio, align belt clip rails with the grooves in radio and slide the belt clip onto the mounting rails until it latches into place.
- To remove belt clip from radio, push up on tab of belt clip with flat bladed screw driver and at the same time, slide the belt clip towards the top of Radio figure 5-3).

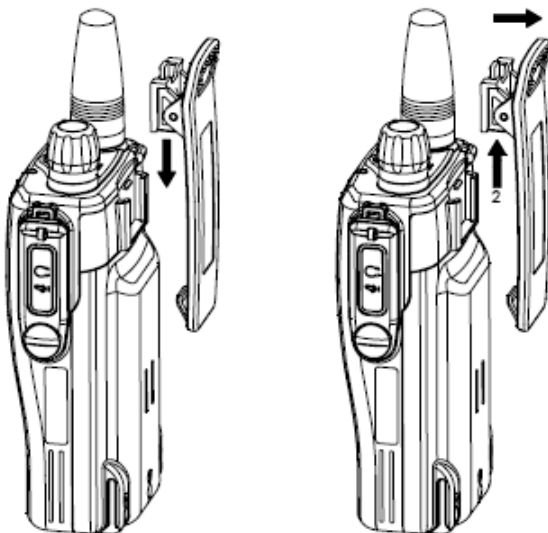

Figure 5-3) Installation and Removing the Belt Clip

### 4.4 Accessory connector

Accessory connector is used to connect external speaker MIC, and headset, etc.

Please close the cover when nothing is connected.



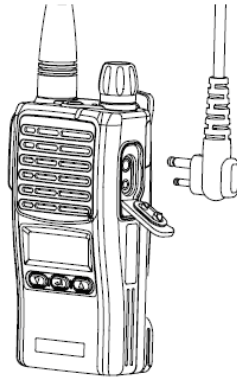

Figure 4-4) Accessory connector

## 6. Operation of the XR Series Radio

### 6.1 Power On/Off, Volume Control Switch

Turning the volume switch knob clockwise to power on and turning the knob counterclockwise to power off. And when set an audio volume level, please refer with the index on the side of the volume knob.

### 6.2 PTT Button

Pressing PTT button, the radio mode is transmission and releasing the button, it is receiving mode. It is recommended to talk 5~10cm away from the microphone for the best voice communication.

### 6.3 Menu Button

Enter into Menu mode by pressing the Menu button (P) for 2 seconds.

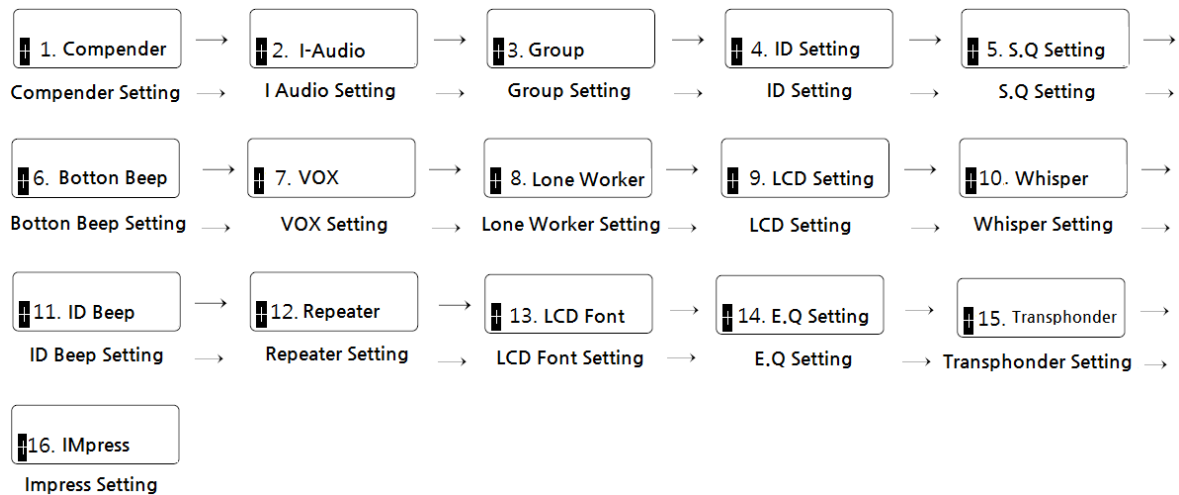

## 6.4 Monitor Button

The monitor mode is enabled and disabled by pressing the Monitor button (M) on the side.

Normal Mode : During pressing the Monitor button(M) for about 2 seconds, it is possible to check the receiving status.

Continuous Mode : During pressing the Monitor button(M) for more than 2 seconds, the Radio will make a “Beep” tone, which means the monitor function is maintained and if you press the Monitor button(M) again, the monitor function will be released.

## 6.5 Emergency Button

In case of emergency situation, if you press the Emergency button, a siren sound will be heard through the speaker in the Radio and the Radio will transmit the emergency signal to the party through the emergency channel.

## 6.6 Channel Buttons (▼, ▲)

Channel Buttons have 3 functions as shown in followings.

- ① Channel buttons : Up (▲) and Down (▼) buttons are to change channels.
- ② Channel buttons are to select menu at menu mode.
- ③ Channel buttons are to change transmission power. By pressing Up button (▲) while PTT button is being pressed, the user can select “H”(High Power), or by pressing Down button (▼), the user can select “L”(Low Power).

## 6.7 Speaker Mic Jack

The Speaker Mic Jack is used when using an external speaker microphone or doing PC programming or making the Cloning or using as a Repeater.

## 6.8 LED indication Status

This LED is a lamp indicating the current status of the Radio and please refer to the below contents.

- ① RX : Green Lamp.
- ② TX : Red Lamp.
- ③ CTCSS, DCS Error : Green Lamp flicker.
- ④ Low Battery: Red Lamp blinks with “beep” sound.

# 7. Charging the Battery

## 7.1 Safety Notes

1) The radio of XR series receives power from high-performance Li-ion battery (XB-2400).

XB-2400 Battery is safe of high performance and highly reliable, and could be charged very fast.

XSB-2400 Battery has been designed suitably only for the charger of Yeonhwa.



The charging of the enclosed Radio on the other maker's charger will cause damage on the battery and also, will cause a trouble on the Radio.

- 2) Please charge the battery before using the radio for best performance and safety.
- 3) When you charge the battery that is installed in the Radio, please turn off the radio first to charge the battery.



The continuous rapid discharge (for example, when making a short circuit on the '+' terminal of battery by a metal substance) may make a fatal defect and the battery can be exploded. Also, it can cause a fire.

- 4) Using the correct battery will improve the efficiency and safety.

## 7.2 The Time of Charging

Low battery voltage maybe cause to reduce communication coverage and also make the performance worse. Please charge the battery in case of following:

- 1) After 10-15 hours after use, recharge when you think the performance of the radio has degradation.
- 2) The red lamp on RX/TX LED blinks. (every 0.5 second), during transmission or reception.
- 3) When the battery icon is blinks
- 4) While the radio is in use, "beep" sounds.

## 7.3 How to Charge

- 1) Plug the adapter of the XC-100/XC-200 charger in general power AC220V power outlet.
- 2) When charging the battery that is equipped with radio, please turn off the power of the Radio and plug the Radio in the charger.
- 3) XC-100 is a single slot charger and XC-200 is dual slot charger.
- 4) Even if charging is completed ( green lamp lights), please charge more for about 30 minutes for a full charge.

Status	LED indication	Status	LED indication
Charging	Red LED lights.	Detecting error	Red LED is flicker
Complete charging	Green LED lights.	Keep charging	Yellow LED lights

## 7.4 Charger (XC-100/XC-200)

The XC-100/XC-200 charger is designed to charge only the Li-ion battery enclosed in this Radio.

Adaptor input voltage: AC85~250V

## 8. Operation of XR Series

### 8.1 Power ON/OFF

Turn Power switch clockwise. Power is supplied immediately and the backlight will be turned on.

If the user made setting of the logo or the user ID, it will be displayed on the LCD and radio will enter into the latest state as a signal sound is generated.

☞ Note : When turning (power) on the radio by pressing a button on it, the radio may enter into a special modes in which transmission and reception are impossible.

Please don't turn on the radio by above way



Figure 8-1) Company Logo & User ID

### 8.2 Transmission Method

For transmission, press PTT button on the left side of the radio. If the DTMF or 5TONE are set, voice communication will be interrupted for several seconds during transmission time of ID.

Then, red LEDs for transmission and reception will be turned on. It is recommended to talk 5 ~ 10cm away from the microphone for the best voice communication.

☞ Note: If the user makes transmission for more than a certain time while BCLO or TOT feature is on, transmission will be forcefully disconnected for other users.

☞ Note: If present channel is TX Inhibited by pc program, TX will not be worked.  
(By PC Program, it could be set.)

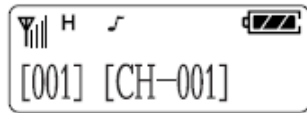

Figure 8-2) Reception

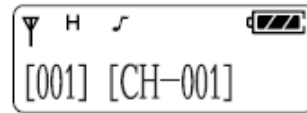

Figure 8-3) Transmission

### 8.3 Receiving Method

If you do not press the PTT button, it will operate in receive mode. The user can adjust the volume by Volume switch, and during reception, the green LED will be turned on.

### 8.4 Changing Channels

Channel buttons (▼, ▲) are to change channels. Press Up button Then, “beep” sound will be generated and the channel number will be increased. Or press Down button (▼) to decrease the channel. If the user presses Up or Down button while only one channel is set, the channel will not be changed and a different sound from “beep” will be generated. For fast increase or decrease channel numbers, press Channel buttons for a while. In this case, however, “beep” sound will not be generated.

### 8.5 Adjusting the Transmission Power

The user can change the transmission power - High Power or Low Power. By pressing Up button (▲) while PTT button is being pressed, the user can select “H” (High Power), or by pressing Down button (▼), the user can select “L” (Low Power). By selecting Low power under good communication conditions, the user can extend the battery use time.

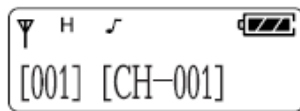

Figure 8-4) High-power operation

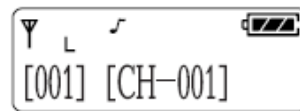

Figure 8-5) Low-power operation

### 8.6 Scan

By pressing “Enter” Button for 2 second in Standby mode, the user can activate Scan function. After Scan function is activated, the radio will automatically search channels and detect a channel corresponding to the frequency. To deactivate Scan function, press “Enter” button once.

#### 8.6.1 Normal Scan

At the Scan mode, the LCD displays “S” icon. When the scan list is S1, S2, S3, the Radio proceeds the channel scan in the sequence of S1, S2, S3, S1, S2,....

During receiving a signal, if you press the UP(▲) or DOWN (▼) button, you can delete the receiving channel temporarily from the scan list and at that time, you can move to the next channel.



### 8.6.2 Priority Scan

At the Scan mode, the LCD displays “s” icon. The Radio scans the channel in the sequence of P, S1, P, S2, P, S3,.... at the priority scan mode.

During receiving signal through the common channel, the Radio scans the priority channel periodically and if the Radio detects the Priority channel, it starts receiving the channel.

During receiving the signal, you can move to the following scan channel by pressing the UP(▲) or DOWN button(▼).

### 8.7 Key Lock function

During pressing the Menu button (P) at the receiving standby mode, press the UP button (▲) and then, the Key Lock function will be executed and the key icon of LCD will appear. At this situation, the other keys except for the PTT and the Monitor key will not be operated. In order to release the Lock function, press the Menu button(P) and during pressing the button, press the DOWN button(▼).

### 8.8 2TONE / 5TONE function

#### 1) 2TONE

You can use the private and group tone functions by the central control system which is using the 2TONE SIGNALING. If the Radio receives the tone signal, the Radio will make a Beep sound which is advising the tone signal status and which means the Radio is ready to talk.

#### 2) 5TONE

The set-up of 5TONE is made by PC programming. Call Name and ID can be the setting up to 200 pieces and set their own ID. And also it allows displaying their ID to the other party at the time of transmission. You can choose 5 Tone Format among ZVEI , CCIR, EEA, PZVEI, DZVEI, PCCIR, PDZVEI, NATEL and it can be set to Manual.

### 8.9 Emergency Call function

This Emergency call is used for calling the party in emergency and if pressing for about 2 seconds the button in Orange color on the top side of Radio, the Emergency Call is transmitted.

In case of setting to the emergency call channel (available by PC programming) with your ID at the general mode or if the Radio is in the call mode, you can make an Emergency Call by pressing the button in Orange color for about 2 seconds.

## 8.10 STUN function

If a lost the radio or you do not want someone use your radio, it can be disable the radio through receiving of STUN ID stored in the radio. (The Stun ID can be set up by PC Program.) If the STUN ID is saved at the Radio, the Radio can't be used even though the power on/off. After receiving the UNSTUN ID, you can use the Radio.

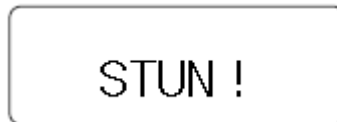

Figure 8-7) STUN

## 8.11 Programming function

The Programming is the function for input of the data such as Frequency/Tone/Scan into the Radio.

\* Programming Method

First, please prepare the Program cable for XR Series Radio.

- ① Press the "P" button of the Radio to turn on. Then, the –Program Mode is displayed.
- ② Connect the Programming cable to the Ear/Microphone Jack of Radio.
- ③ By using the PC Program, store the data and then disconnect the cable.  
Turn off the power and turn on the power again.



Figure 8-8) Programming Mode

## 8.12 Cloning function

The Cloning is to copy the data such as Frequency/Tone/Scan into the other Radio.

\* Cloning Method

- ① First, please prepare the Cloning cable for XR Series Radio.
- ② The original Radio should be turned on with pressing the PTT button and the Radio to be copied should be turned on with pressing the " P " button.
- ③ The original Radio displays Radio's version and then a clone message is displayed with change screen.
- ④ The original Radio displays a < LINE CLON > message and copied Radio displays a

" Program Mode " message..

- ④ Connect the Cloning cable to the Ear/Mic Jack of the two Radios.
  - ⑤ If pressing the Enter button of the original Radio, the copy is made and after completing, please disconnect the cable and turn off & on the power of the two Radios. Finally please use the Radio after checking if the copy is made without problem.
- ☞ Note: If the Cloning is made into the other maker's Radio, a malfunction can happen.

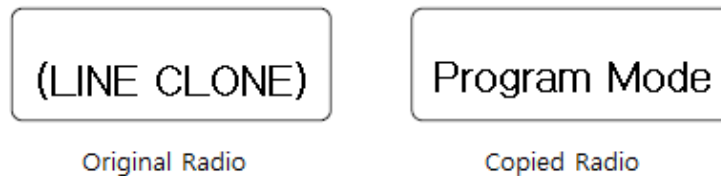

Figure 8-9) CLONE

### 8.13 Wireless Cloning Function

This function is to copy the data such as Frequency/Tone/Scan into the other Radio without use PC program. .

☞ Note: May fail when you move the radio during cloning.

\* Wireless Cloning method: Transmission part

- ① Press "P" + "UP Key" button and turn on.
- ② LCD screen displays a "TX wireless cloning" message.
- ③ Start transmission by pressing "PTT Key".

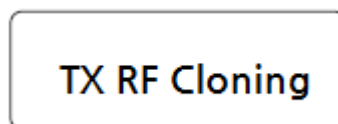

Figure 8-10) TX Wireless Cloning

\* Wireless Cloning method: Reception part

- ① Press "P" + "Down Key" button and turn on.
- ② LCD screen displays a "RX wireless cloning" message.
- ③ When the transmission is started, "G [0] E [0]" message is displayed on the screen.  
"E [0]" is the number of Error.
- ④ If the Error number is 1 or more, "failure" message is displayed and then display " re-receiving " message.



- ⑤ When the reception is successfully completed, display the " Done " message and will be a restart.



Figure 8-11) RX Wireless cloning

## 8.14 Frequency Copy Function .

This function is to copy the Frequency/Tone without use PC program. (including third-party radios)

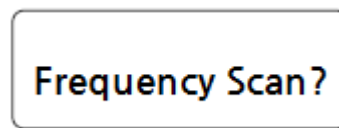

Figure 8-12) Frequency COPY

\* Frequency COPY method

- ① Press "M(Monitor)" button and turn on.
- ② When the "search frequency?" Message is displayed on the screen, press the "PTT Key".
- ③ "PTT Key" + "M" : Setting the SQ sensitivity higher during searching.  
 "PTT Key" + "P" : Setting the SQ sensitivity lower during searching.  
 "UP Key" : Frequency up SCAN.  
 "DOWN Key" : Frequency down SCAN).
- ④ After the search frequency is changed to Sub-Tone Search mode.
- ⑤ When the search is complete, the storage channel is displayed.
- ⑥ UP / Down key is possible to change the channel and the P / M Key can be change 10 channels at a time.
- ⑦ It is possible to re-scan or complete after storage of the channel.

## 8.15 Menu description

If pressing the Menu button (P) on the side for 2 seconds, the Radio will be in Menu mode. The Menu mode consists of 9 Menus and you can use your desired Menu after selection.

☞ Note: After entering into the Menu, if you don't operate the Menu for more than 8 seconds, the Menu mode will be terminated automatically and it is converted to the Receiving mode.

### 1) Setting Compander

This is for On/Off of the Compander.

The setting can be made by the PC program and at the Menu.

- ① Enter into the Menu mode.

- ② By using the channel buttons (▼, ▲), choose the “Compander” and press the Enter button.

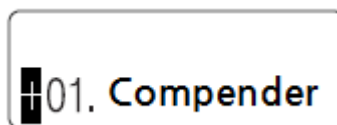

- ③ By using the channel buttons (▼, ▲) choose the ON(“y”) or the OFF(“n”) and press the, Enter button to store.
- ④ To out of the Menu mode, press the Menu button (P).  
In accordance with selection On / Off, the Compander icon appears/disappears on the LCD.

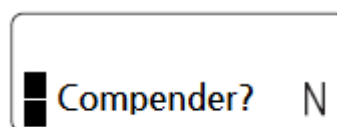
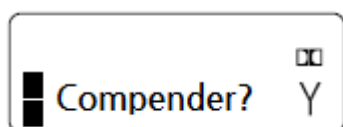

## 2) Setting I Audio (Intelligent Compander)

Detect the mute at the receiving mode and then remove only the White Noise.

- ① Enter into the Menu mode.
- ② By using the channel buttons (▼, ▲), choose the “Comp” and press the Enter button
- ③ Select ON(“y”)/OFF(“n”) by pressing Channel buttons (▲, ▼) and save the selected status by pressing Enter button.
- ④ To out of the Menu mode, press the Menu button (P). .

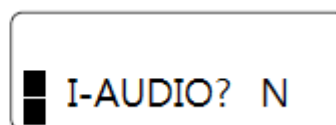
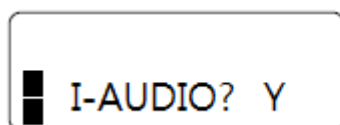

## 3) Setting Group

The Radio is designed to have total 1024 channels and 32 Groups and the selection of each Group & Channel can be available by PC program and Menu.

- ① Enter into the Menu mode.
- ② By using the channel buttons (▼, ▲), choose the “Group” and press the Enter button

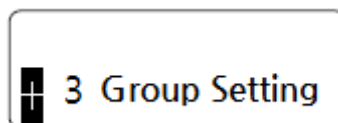

- ③ By using the channel buttons (▲, ▼) choose the “Group” and save by pressing Enter button.

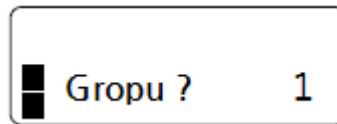

- ④ To out of the Menu mode, press the Menu button (P).

#### 4) Setting ID

This is for transmission of your ID and reception of your party's ID. ID is divided by DTMF and Call ID. Especially the Call ID transmits your ID to the party and also, the party's ID is displayed on your Radio to use your Radio in convenience and efficiently.

- ① Enter into the Menu mode.
- ② By using the channel buttons (▼, ▲), choose the " ID Setting " and press the Enter button.

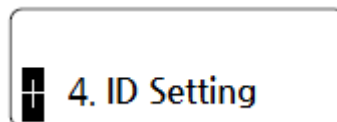

- ③ After the "DTMF Setting " message comes out, choose the ON ("y")/OFF ("n") by the channel buttons (▼,▲) and press the Enter button.

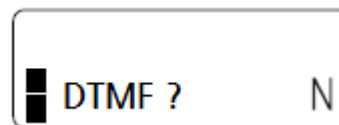
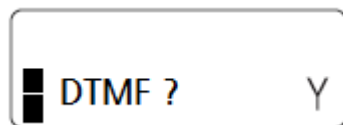

- ④ After the "CALL Setting " message comes out, choose the ON ("y")/OFF ("n") by the channel buttons (▼,▲) and press the Enter button.
- ⑤ Select ON("y")/OFF("n") by pressing Channel buttons (▲,▼) and save the selected status by pressing Enter button.

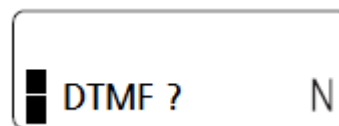
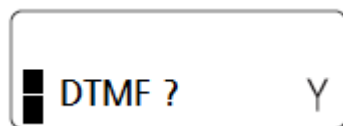

- ⑥ To out of the Menu mode, press the Menu button (P).

#### 5) Setting S.Q (Squelch)

Squelch sensitivity level is selectable by 10 steps. Default value set to level 5.

- ① Enter into the S.Q setting mode.
- ② By using the channel buttons (▼, ▲), choose the " S.Q Setting " and press the Enter button.

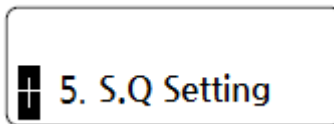

- ③ Using the channel buttons (▼, ▲), choose the S.Q Sensibility and press the Enter button to store.

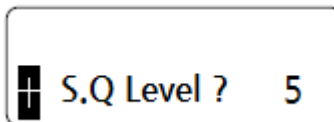

- ④ To out of the Menu mode, press the Menu button (P).

## 6) Setting Button Sound (Alert)

Button sound is available to set to 3 steps ( High, Low, OFF).

By PC Program and menu, it could be set.

- ① Enter into the Button sound setting mode.
- ② By using the channel buttons (▼, ▲), choose the “Button sound Setting ” and press the Enter button.



- ③ By using the channel buttons (▼, ▲), choose one of the 3 steps ( High, Low, OFF) and press the Enter button.
- ④ Select ON(“y”)/OFF(“n”) by pressing Channel buttons (▲, ▼) and save the selected status by pressing Enter button.

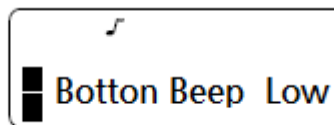
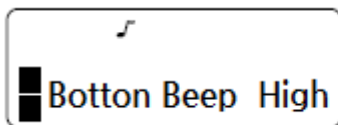

- ⑤ To out of the Menu mode, press the Menu button (P).  
If select off, the symbol will disappear on the LCD.

## 7) Setting VOX

VOX is to enable users to make transmission without pressing PTT button.

By PC Program and menu, it could be set.PTT

- ① Enter into the VOX setting mode.
- ② By using the channel buttons (▼, ▲), choose the “VOX Setting ” and press the Enter button.

## 7. VOX Setting

- ③ After the “**VOX MODE**” message comes out, choose the ON (“y”)/OFF (“n”) by the channel buttons (▼,▲) and press the Enter button.

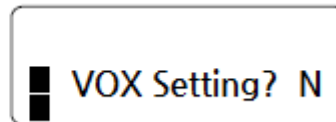
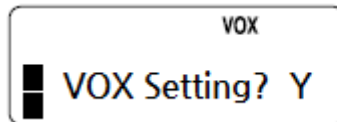

- ④ Select on. Then, the VOX ICON symbols will appear on the LCD and displayed “ VOX Sensibility 5” on the LCD. Select off. Then, the VOX ICON symbol will disappear on the LCD.
- ⑤ Set sensitivity by pressing Channel buttons (▼,▲) and press the Enter button  
VOX sensitivity has a total of 10 levels, 1 is the low sensitivity and 10 is high sensitivity.

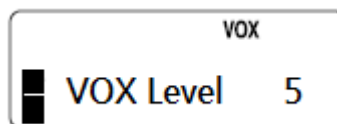

- ⑥ To out of the Menu mode, press the Menu button (P).

## 8) Setting Lone worker

The Lone Worker is for transmission of emergency alarm sound without pressing the designated button within a period of time when night patrol or guarding and the Lone Worker can be set to be ON)/OFF.

The setting can be available by PC program and Menu.

- ① Enter into the menu setting mode.
- ② By using the channel buttons (▼, ▲), choose the “Lone Worker Mode ” and press the Enter button.

## 8. Lone Worker

- ③ Select ON(“y”)/OFF(“n”) by pressing Channel buttons (▲,▼) and save the selected status by pressing Enter button.

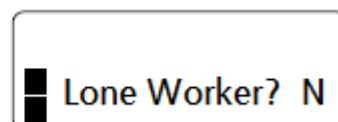
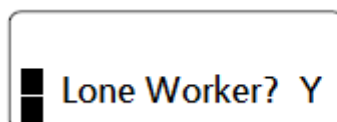

- ④ To out of the Menu mode, press the Menu button (P).

## 9) Setting LCD Contrast

- ① Enter into the menu setting mode.
- ② Select “**LCD CONTRAST**” by Channel buttons (▼,▲) and press Enter button.
- ③



- ④ Select the Level (10~30) of LCD CONTRAST by pressing Channel buttons (▼,▲) and save the selected status by pressing Enter button.

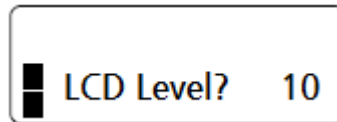

If the level is increased, the contrast will be getting darker and darker..

- ⑤ Exit Menu mode by pressing Menu Button (P) button.

## 10) Setting Whisper Mode

Whisper function is to enable user to transmit a high sound level even if he is whispering on the radio.

By PC program and menu, it could be set.

- ① Enter into the menu setting mode.
- ② Select “**Whisper setting**” by Channel buttons (▼,▲) and press Enter button.



- ③ Select ON("y")/OFF("n") by pressing Channel buttons (▲,▼) and save the selected status by pressing Enter button.

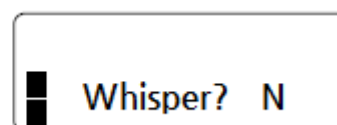
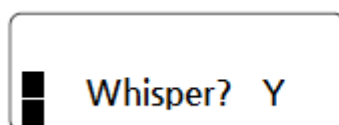

- ④ Exit Menu mode by pressing Menu Button (P) button.

## 11) Setting ID Sound

ID Sound settings feature allows selecting the volume of the DTMF tone

- ① Enter into the menu setting mode.
- ② Select “**ID Sound setting**” by Channel buttons (▼,▲) and press Enter button.

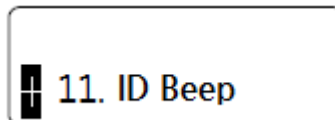

- ③ Select **LOW/HIGH** by pressing Channel buttons (▲,▼) and save the selected status by pressing Enter button.

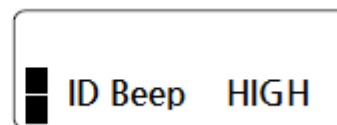

- ④ Exit Menu mode by pressing Menu Button (P) button.

## 12) Setting Repeater

If you want to use the XR Series Radio as a repeater, you can operate the Repeater by On( Y) / Off( N).

By PC program and menu, it could be set.

- ① Enter into the menu mode.
- ② Select “**Repeater setting**” by Channel buttons (▼,▲) and press Enter button.

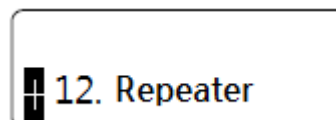

- ③ Select ON("y")/OFF("n") by pressing Channel buttons (▲,▼) and save the selected status by pressing Enter button.

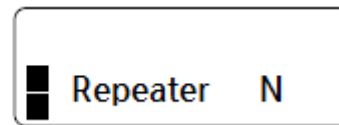
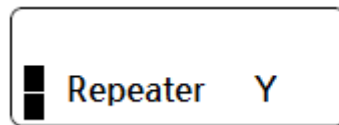

- ④ Exit menu mode by pressing menu Button (P) button.

Repeater is displayed on the LCD.



### 13) Setting LCD Font

This is a function to set the LCD font size.

- ① Enter into the menu setting mode.
- ② Select “ **LCD Font** ” by Channel buttons (▼,▲) and press Enter button.

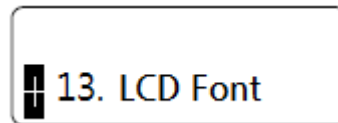

- ③ Select enlarge font ON(“y”)/ decrease font/OFF(“n”) by pressing Channel buttons (▲,▼) and save the selected status by pressing Enter button.

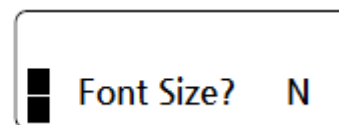

- ④ Exit menu mode by pressing menu Button (P) button.

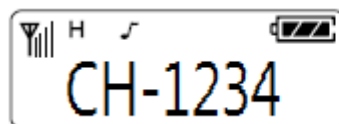

Enlarge font (Y)

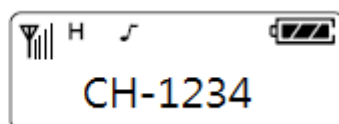

Normal font (N)

### 14) Setting E.Q

EQ (Equalizer) function is provide a convenient sound to the user by dividing the received sound by 4 steps.



By PC program and menu, it could be set.

- ① Enter into the menu setting mode.
- ② Select “ **E.Q Setting** ” by Channel buttons (▼,▲) and press Enter button.

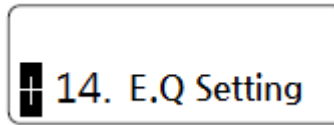

- ③ Select E.Q step by pressing Channel buttons (▲,▼) and save the selected status by pressing Enter button. The default value is set E.Q sound 1.



Description	Characteristics	Remark
E.Q Sound 1	6dB/oct	Low-pitched tone
E.Q Sound 2	5dB/oct	
E.Q Sound 3	4dB/oct	
E.Q Sound 4	3dB/oct	High-pitched tone

- ④ Exit menu mode by pressing menu Button (P) button.

## 15) Setting Transponder

If there is no response from other party's radio, it is able to check that the party's radio is in the communication coverage.

- ① Enter into the menu setting mode.
- ② Select “ Transponder setting ” by Channel buttons (▼,▲) and press Enter button.

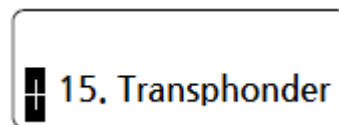

- ③ Select transponder function ON("y")/ NO("n") by pressing Channel buttons (▲,▼) and

save the selected status by pressing Enter button.

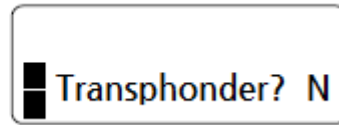

- ④ If choose "Y", select the ID of other party. Relative ID can be selected up to 255 people maximum.

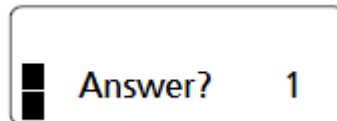

- ⑤ Exit menu mode by pressing menu Button (P) button.

## 16) Setting Impress

Regardless of the voice volume size, direction or the distance from the microphone, it is the ability to use for clear communication.

- ① Enter into the menu setting mode.
- ② Select " Impress setting " by Channel buttons (▼,▲) and press Enter button.

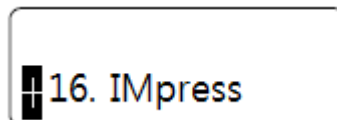

- ③ Select Impress function ON("y")/ NO("n") by pressing Channel buttons (▲,▼) and save the selected status by pressing Enter button.

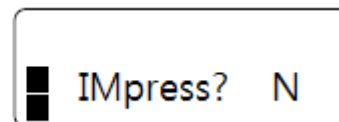
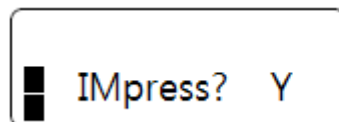



- ④ Exit menu mode by pressing menu Button (P) button.

## 9. Precautions

### 9.1 When using the XR Series Radios

 <p><b>WARNING</b></p>	<p>Don't remove the antenna from the Radio or don't transform the antenna or don't make any change on the antenna. The strong electronic wave to be emitted from the Radio can have an effect on the performance of the Radio and can cause the Radio to have a defect.</p>
---	---

 <p><b>Caution</b></p>	<p>Don't use the accessories (such as rechargeable battery, adaptor, external speaker microphone and earphone, etc.) from the other makers, which can cause to make a defect on battery and a malfunction or a defect on the Radio.</p>
---	---

 <p><b>WARNING</b></p>	<p>Don't disassemble or reorganize the Radio. The disassembly or reorganization will be causes of defect or malfunction and it will be impossible to make repair afterward. Also, a punishment can be made by law.</p>
--	--

 <p><b>WARNING</b></p>	<p>Don't use the other frequency except for the permitted frequency in order not to be punished by law.</p>
---	---

 <p><b>Caution</b></p>	<ul style="list-style-type: none"><li>• Don't give an excessive shock to the Radio.</li><li>• Don't place the Radio where the direct sunlight and/or the high temperature occurs.</li><li>• If the Radio is placed for a long time in car in summer, the hot temperature in the car may cause an explosion of battery.</li><li>• Don't make a damage to the battery by a sharp substance and/or an excessive shock.</li></ul>
---	---

## 9.2 Influences to the operations of Radio or other Equipments

The Radio emits a strong electronic wave, which may have an effect on the operation of other equipments and also, can be influenced by the other devices.

	<p>Please turn off the Radio before boarding on airplane.</p> <p>When you want to use the Radio in the airplane, please follow the rules in the airplane or the instructions by crew.</p>
---	---

	<p>In case of the area that medical equipments are being used, please use the Radio after discussion with the equipment maker or the related doctor.</p>
---	--

	<p>Please don't use the Radio at the place where computer or the other electric/electronic devices are being used, because the strong electronic wave from the Radio can have an effect on the equipments.</p>
--	--

## 10. Safety Notes

Please make sure to read the followings for safe and effective use of the Radio.



- Please keep the Radio away at least 1inch from the body.
- If the outside surface of antenna gets stripped out, it can make a burn on the skin.
- If you contact a conductive metal to battery terminal, a heat can be made and it may cause fire, explosion and burn. Especially, please be careful when putting the battery in a pocket or a bag.
- When using an earphone, please don't listen to the sound at a high level. The high sound may have a bad effect on your ear.
- After setting the volume of the Radio at a low level, please adjust the volume step by step to the level you want. A sudden high sound may give a bad damage to the ear or the heart.
- Please don't remove or replace or charge or discharge the battery at a dangerous area, since it may cause an explosion or a fire by an electrical spark.
- At the area where an electromagnetic force can be made, please make sure to turn off the power of the Radio.

# Warranty Card

Thank you for purchasing XR series.

1. This product has passed strict quality control and testing process.
2. Warranty is one year from the day the factory.
  - Failure of the product under normal operating conditions, during the warranty period may be repaired by Yeonhwa M Tech Co., Ltd. or our authorized service organization free of charge.
3. For the following cases, some service fees will be charged.
  - It occurs after the warranty period has passed, performance failure, malfunction or damage.
  - When the product is damaged due to user's mishandling, abuse or improper operation.
  - When the product is damaged due to user's modification, attempted repair or otherwise access to sealed/non-user serviceable items.
  - When the product is damaged due to fires, pollution, earthquakes and any other natural or unnatural conditions, accidents, etc.

#### 4. Product check list

Model No.		XR-150 / XR-150R / XR-450 / XR-450R
Serial No.		
Purchase date		
Purchaser	Name	
	Address	

※ When you purchasing, please fill out this check list.

### **YEONHWA M Tech Co., Ltd.**

430-857 36, Jeonpa - ro, 44 Beon Gil, Manan-gu, Anayang - city, Gyeonggi-do, Korea.

( Yeonhwa M Tech Bldg)

Tel : 031)444-7270, 070-4827-3200

FAX : 031)444-7271

## Transient Frequency Behavior (12.5KHz)

### 1. 136.025MHz TX Start

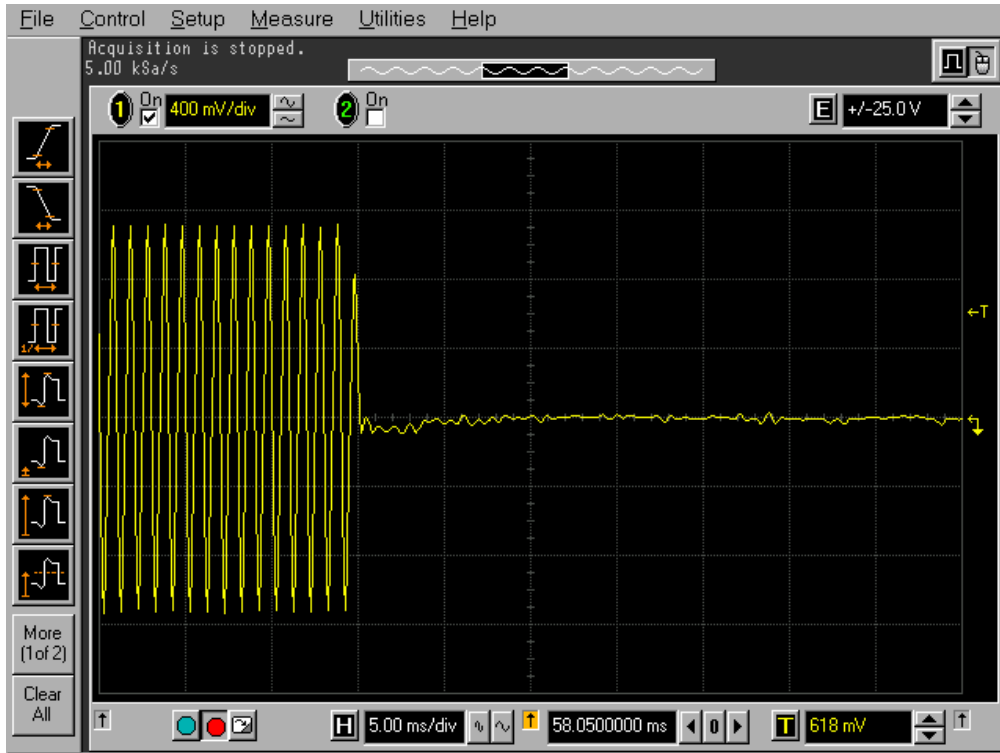

### 2. 136.025MHz TX End

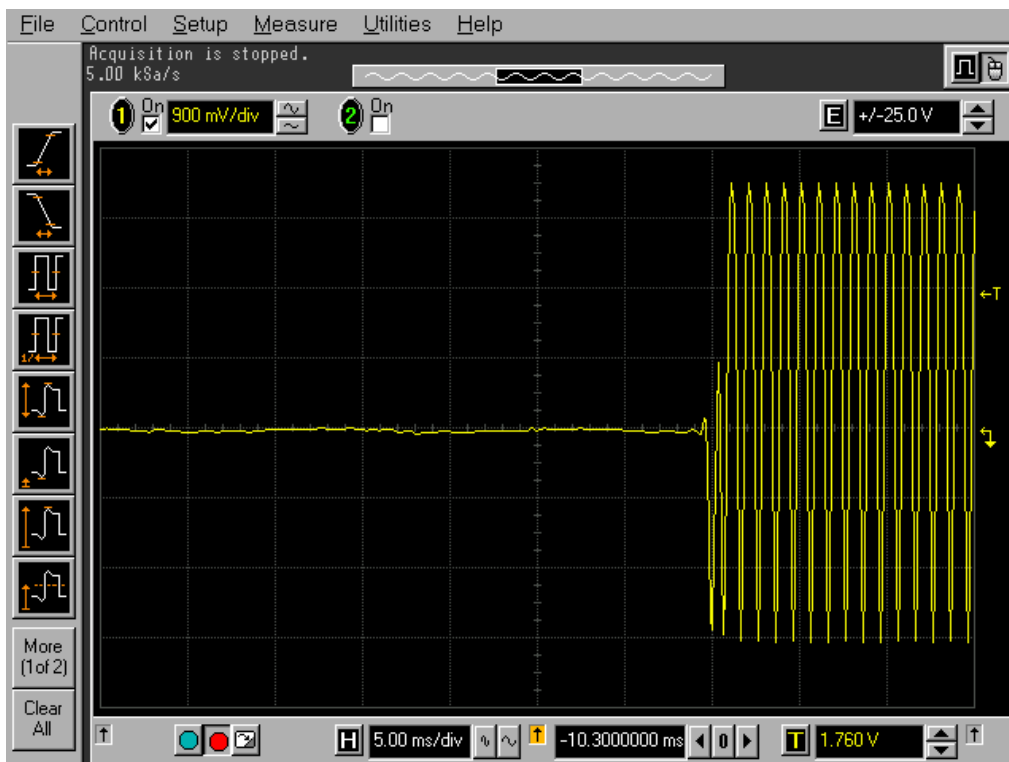

### 3. 155.025MHz TX Start

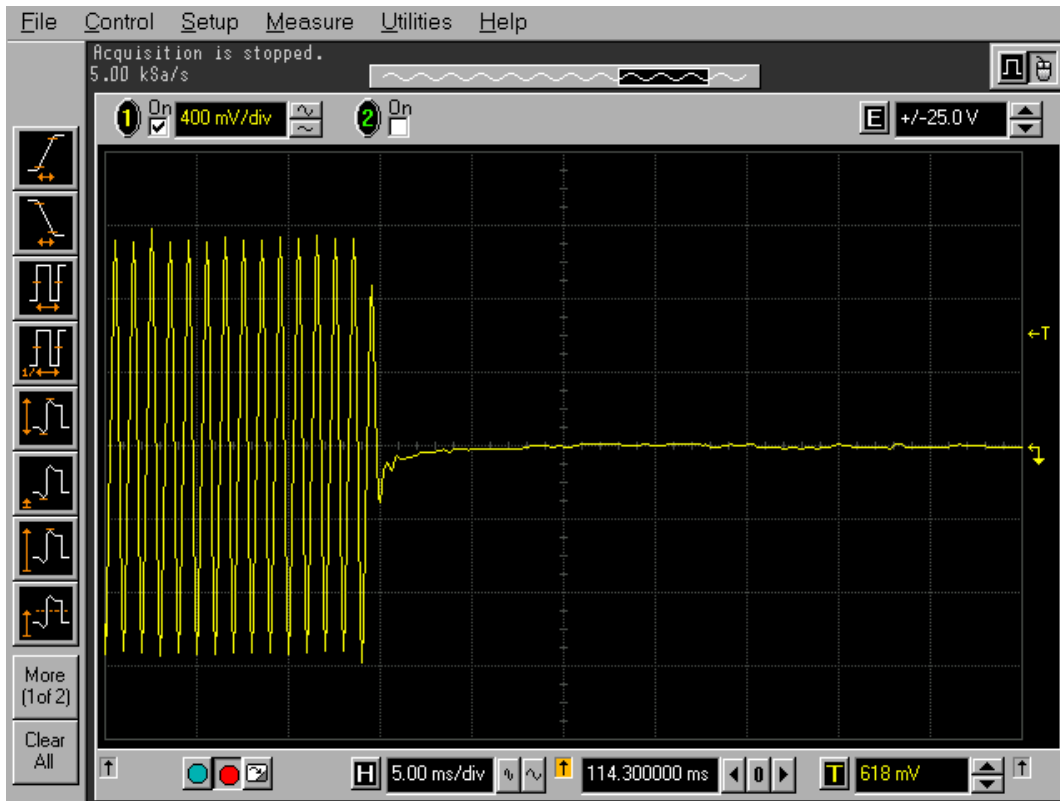

### 4. 155.025MHz TX End

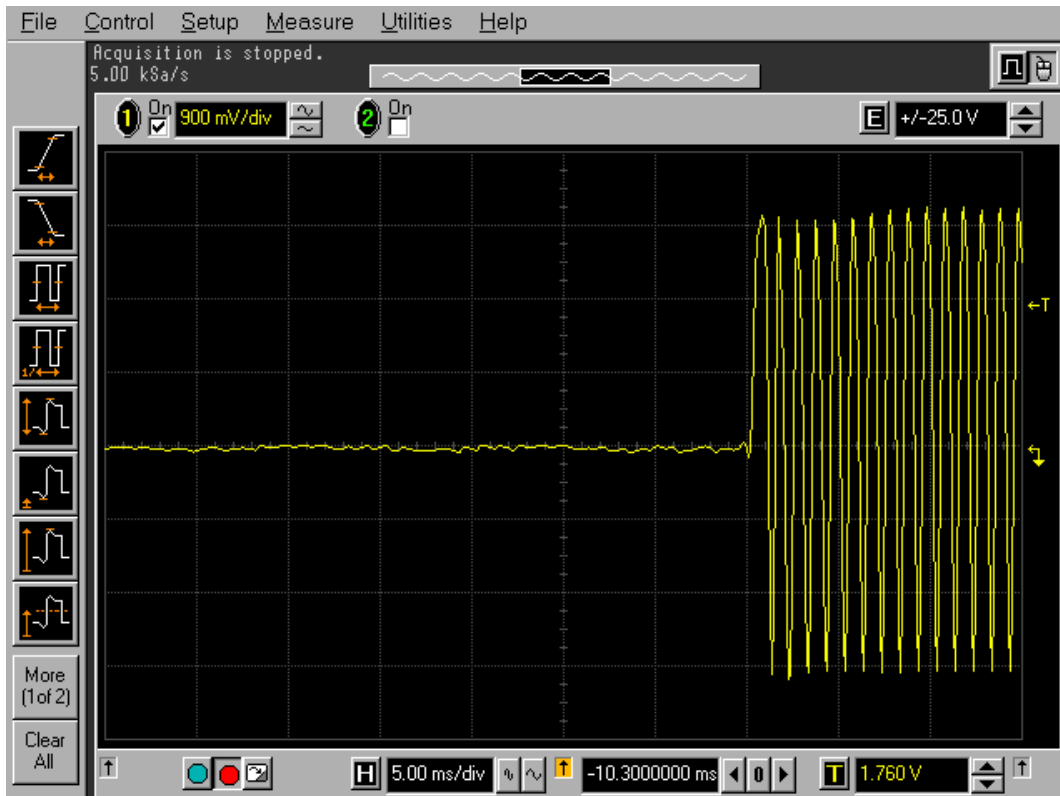



## 5. 173.975MHz TX Start

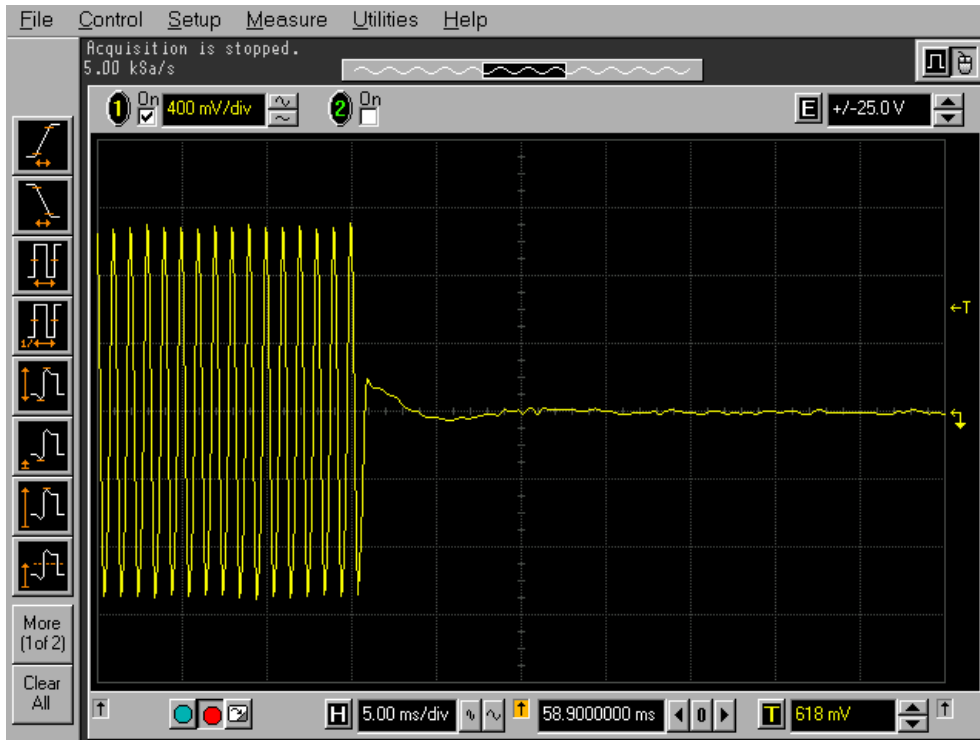

## 6. 173.975MHz TX End

