



243 Jubug-Ri, Yangji-Myeon, Yongin-Si, Gyeonggi-Do, Korea 449-822  
 Tel: +82-31-323-6008 Fax: +82-31-323-6010  
<http://www.ltalab.com>

## SAR TEST REPORT

Equipment Under Test : Private Land Mobile Radio Service  
 Model Name : XP-400D  
 Variant Model Name : XP-450D, XR-400D  
 Applicant : YEONHWA M TECH CO.,LTD.  
 Address of Applicant : 36, Jeonpa-ro 44beon-gil, Manan-gu, Anyang-si, Gyeonggi-do, Korea  
 FCC ID : VSOXP-400D  
 Date of Receipt : 2017-01-25  
 Date of Test(s) : 2017-02-01 ~ 2017-02-05  
 Date of Issue : 2017-02-05  
 Max.SAR(1g) : 4.795 W/kg

**Standards:**  
**KDB 447498 D01 v06**  
**KDB 643646 D01 v01r03**  
**KDB 865664 D01 v01r04**  
**KDB 865664 D02 v01r02**  
**IEEE 1528-2013**  
**ANSI/IEEE C95.1, C95.3**

In the configuration tested, the EUT complied with the standards specified above.

### Remarks:

This report details the results of the testing carried out on one sample, the results contained in this test report do not relate to other samples of the same product. The manufacturer should ensure that all products in series production are in conformity with the product sample detailed in this report.

This report may only be reproduced and distribute in full. If the product in this report is used in any configuration other than that detailed in the report, the manufacturer must ensure the new system complies with all relevant standards. Any mention of LTA Co., Ltd. Or testing done by LTA Co.,Ltd. In connection with distribution or use of the product described in this report must be approved by LTA Co.,Ltd. In writing.

**Tested by** : Jung-won Seo  **2017-02-06**

**Approved by** : Yong-Cheol Wang  **2017-02-06**

---

# **Contents**

<b>1. EXECUTIVE SUMMARY &amp; EUT INFORMATION .....</b>	<b>3</b>
<b>2. INTRODUCTION .....</b>	<b>4</b>
<b>3. SAR MEASUREMENT SETUP .....</b>	<b>5</b>
<b>4. ANSI/IEEE C95.1-2005 RF EXPOSURE LIMIT .....</b>	<b>16</b>
<b>5. SYSTEM AND LIQUID VALIDATION .....</b>	<b>17</b>
<b>6. TYPE A MEASUREMENT UNCERTAINTY .....</b>	<b>23</b>
<b>7. OUTPUT POWER VERIFICATION .....</b>	<b>24</b>
<b>8. TEST CONDITION .....</b>	<b>25</b>
<b>9. SAR TEST RESULTS .....</b>	<b>26</b>
<b>ANNEX A. TEST INSTRUMENT .....</b>	<b>40</b>
<b>ANNEX B. EUT AND TEST SETUP PHOTOGRAPHS .....</b>	<b>41</b>
<b>ANNEX C. CALIBRATION REPORTS .....</b>	<b>45</b>

## 1. Executive Summary & EUT Information

The purpose of this test programmed was to demonstrate compliance of the Intermecc Technologies Corporation Model: 1005CP01 against the current Stipulated Standards. The Mobile Computer have demonstrated compliance with the C95.1, IEEE 1528, KDB447498 D03 Supplement C Cross-Reference v01, RSS-102 Issue 5 and Safety Code 6. The test has demonstrated that this unit complies with stipulated standards.

EUT information	
<b>EUT Description</b>	Private Land Mobile Radio Service (Tetra Hand Portable Radio)
<b>Model No.</b>	XP-400D
<b>Serial No.</b>	Identical prototype
<b>Mode of Operations</b>	FM
<b>Body-Worn Accessory</b>	BeltClip
<b>TX Frequency Range</b>	410.000 ~ 470.000 MHz (Analog 4.8 W) 410.000 ~ 470.000 MHz (DMR 4.8 W)
<b>Conducted Max Power</b>	36.16 dBm (Analog 4.8 W) 36.12 dBm (DMR 4.8 W)
<b>Battery Type</b>	DC 7.5 V

## 2. Introduction

### Introduction

This measurement report shows compliance of the EUT with FCC OET Bulletin 65 Supplement C (Edition 01-01) & RSS 102 Issue 4.0.

The test procedures, as described in ANSI C95.1 – 2005 Standard for Safety Levels with Respect to Human Exposure to Radio Frequency Electromagnetic Fields, 3 kHz to 300 GHz [2], and ANSI C95.3 – 2002 Recommended Practice for the Measurement of Potentially Hazardous Electromagnetic Fields [3], were employed.

### SAR Definition

Specific Absorption Rate is defined as the time derivative (rate) of the incremental energy (dW) absorbed by (dissipated in) an incremental mass (dm) contained in a volume element (dV) of a given density ( $\rho$ ).

$$SAR = \frac{d}{dt} \left( \frac{dW}{dm} \right) = \frac{d}{dt} \left( \frac{dW}{\rho dV} \right)$$

SAR is expressed in units of watts per kilogram (W/kg). SAR can be related to the electric field at a point by

$$SAR = \frac{\sigma |E|^2}{\rho}$$

where:

- $\sigma$  = conductivity of the tissue (S/m)
- $\rho$  = mass density of the tissue (kg/m<sup>3</sup>)
- E = rms electric field strength (V/m)

### 3. SAR Measurement Setup

#### Dosimetric Assessment System

These measurements were performed with the automated near-field scanning system OPENSAR from SATIMO. The system is based on a high precision robot (working range: 850 mm), which positions the probes with a positional repeatability of better than  $\pm 0.02$  mm. Special E- and H-field probes have been developed for measurements close to material discontinuity, the sensors of which are directly loaded with a Schottky diode and connected via highly resistive lines to the data acquisition unit.

The SAR measurements were conducted with dosimetric probe (manufactured by SATIMO), designed in the classical triangular configuration and optimized for dosimetric evaluation. The probe has been calibrated according to the procedure described in SAR standard with accuracy of better than  $\pm 10\%$ . The spherical isotropy was evaluated with the procedure described in SAR standard and found to be better than  $\pm 0.25$  dB. The phantom used was the SAM Phantom as described in FCC supplement C, IEEE P1528 and CENELEC EN62209-1.

#### Measurement System Diagram

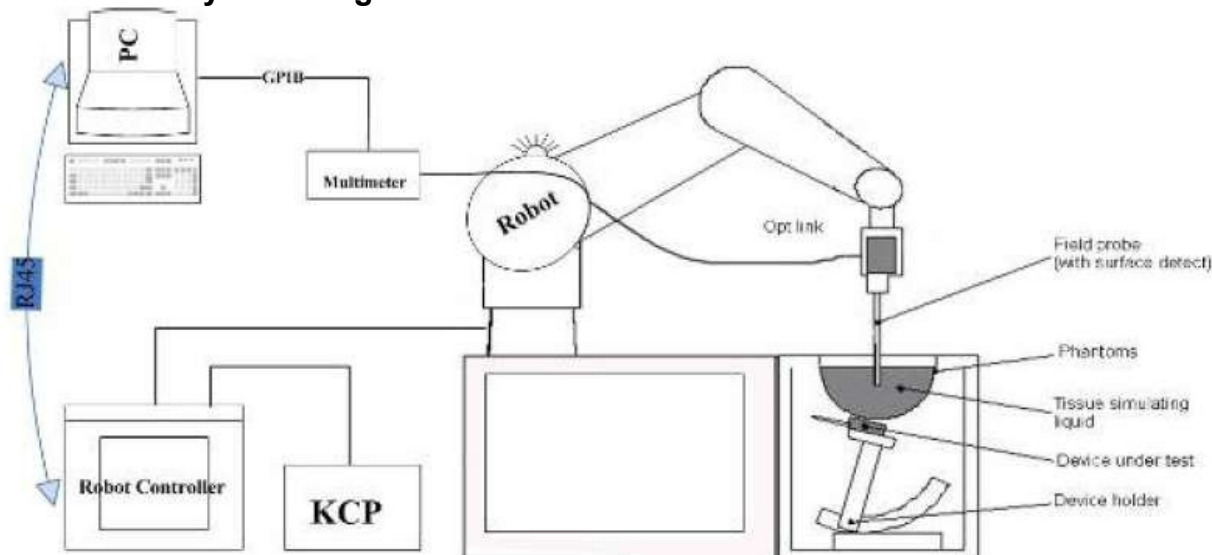

#### The OPENSAR system for performing compliance tests consist of the following items:

1. A standard high precision 6-axis robot (KUKA) with controller and software.
2. KUKA Control Panel (KCP).
3. A dosimetric probe, i.e., an isotropic E-field probe optimized and calibrated for usage in tissue simulating liquid. The probe is equipped with an optical surface detector system.
4. The functions of the PC plug-in card are to perform the time critical task such as signal filtering, surveillance of the robot operation fast movement interrupts.
5. A computer operating Windows XP.
6. OPENSAR software.
7. Remote control with teaches pendant and additional circuitry for robot safety such as warning lamps, etc.
8. The SAM phantom enabling testing left-hand right-hand and body usage.
9. The Position device for handheld EUT.
10. Tissue simulating liquid mixed according to the given recipes (see Application Note).
11. System validation dipoles to validate the proper functioning of the system.

## EPG226 Probe



Construction Symmetrical design with triangular Core. Built-in shielding against static charges Calibration in air from 100 MHz to 2.5 GHz. In brain and muscle simulating tissue at frequencies from 800 to 6000 MHz (accuracy of 8%) .

Frequency 100 MHz to 6 GHz;

Linearity ; 0.25 dB (100 MHz to 6 GHz) ,

Directivity : 0.25 dB in brain tissue (rotation around probe axis) 0.5 dB in brain tissue (rotation normal probe axis)

Dynamic : 0.001W/kg to > 100W/kg;

Range Linearity: 0.25 dB

Surface : 0.2 mm repeatability in air and liquids

Dimensions Overall length: 330 mm

Tip length: 16 mm

Body diameter: 8 mm

Tip diameter: 2.6 mm

Distance from probe tip to dipole centers: <1.5 mm

Application General dosimetric up to 6 GHz

Compliance tests of mobile phones

Fast automatic scanning in arbitrary phantoms

The SAR measurements were conducted with the dosimetric probe designed in the classical triangular configuration and optimized for dosimetric evaluation. The probe is constructed using the thick film technique, with printed resistive lines on ceramic substrates.

It is connected to the KRC box on the robot arm and provides an automatic detection of the phantom surface. The 3D file of the phantom is include in OpenSAR software. The Video Positioning System allow the system to take the automatic reference and to move the probe safely and accurately on the phantom.

## E-Field Probe Calibration Process

Each probe is calibrated according to a dosimetric assessment procedure described in SAR standard with accuracy better than +/- 10%. The spherical isotropy was evaluated with the procedure described in SAR standard and found to be better than +/-0.25dB. The sensitivity parameters (NormX, NormY, NormZ), the diode compression parameter (DCP) and the conversion factor (ConvF) of the probe are tested. The free space E-field from probe outputs is determined in a test chamber. This is performed in a TEM cell for frequencies below 0.8 GHz, and in a waveguide above 0.8 GHz for free space. For the free space calibration, the probe is placed in the volumetric center of the cavity and at the proper orientation with the field. E-field correlation calibration is performed in a flat phantom filled with the appropriate simulated brain tissue.

### SAM Phantom

The ELLI Phantom ELLI25 is constructed of a fiberglass shell integrated in a wooden table. The shape of the shell is in compliance with the specification set in IEEE P1528 and CENELEC EN62209-2. The phantom enables the dosimetric evaluation of left and right hand phone usage as well as body mounted usage at the flat phantom region.

A cover prevents the evaporation of the liquid.

Reference markings on the Phantom allow the complete setup of all predefined phantom positions and measurement grids by manually teaching three points in the robot.

Shell Thickness: 2~0.2 mm

Filling Volume: Approx. 25 liters

Dimensions (H x L x W): 600 x 400 x 200 mm

Liquid is filled to at least 15mm from the bottom of Phantom.



### Device Holder

In combination with the Generic Twin Phantom V3.0, the Mounting Device enables the rotation of the mounted transmitter in spherical coordinates whereby the rotation points is the ear opening. The devices can be easily, accurately, and repeatedly positioned according to the FCC and CENELEC specifications. The device holder can be locked at different phantom locations (left head, right head, flat phantom).

*Note: A simulating human hand is not used due to the complex anatomical and geometrical structure of the hand that may produce infinite number of configurations [10]. To produce the worst-case condition (the hand absorbs antenna output power), the hand is omitted during the tests.*



## Data Evaluation

The OPENSAR software automatically executes the following procedure to calculate the field units from the microvolt readings at the probe connector. The parameters used in the valuation are stored in the configuration modules of the software:

Probe Parameters	- Sensitivity	Normi
	- Conversion factor	ConvFi
	- Diode compression point Dcpi	
Device Parameters	- Frequency	f
	- Crest factor	cf
Media Parameters	- Conductivity	$\sigma$
	- Density	$\rho$

These parameters must be set correctly in the software. They can either be found in the component documents or be imported into the software from the configuration files issued for the OPENSAR components.

The first step of the evaluation is a linearization of the filtered input signal to account for the compression characteristics of the detector diode. The compensation depends on the input signal, the diode type and the DC-transmission factor from the diode to the evaluation electronics. If the exciting field is pulsed, the crest factor of the signal must be known to correctly compensate for peak power. The formula for each channel can be given as

$$V_i = U_i + U_i^2 \cdot \frac{cf}{dcp_i}$$

Where  $V_i$  = Compensated signal of channel  $i$  ( $i = x, y, z$ )

$U_i$  = Input signal of channel  $i$  ( $i = x, y, z$ )

$cf$  = Crest factor of exciting field (DASY parameter)

$dcp_i$  = Diode compression point (DASY parameter)

From the compensated input signals the primary field data for each channel can be evaluated:

$$\text{E-field probes: } E_i = \sqrt{\frac{V_i}{Norm_i \cdot ConvF}}$$

$$\text{H-field probes: } H_i = \sqrt{V_i} \cdot \frac{a_{i0} + a_{i1}f + a_{i2}f^2}{f}$$

Where  $V_i$  = Compensated signal of channel  $i$  ( $i = x, y, z$ )

$Norm_i$  = Sensor sensitivity of channel  $i$  ( $i = x, y, z$ )  
 $\mu V / (V/m)^2$  for E0field Probes

$ConvF$  = Sensitivity enhancement in solution

$a_{ij}$  = Sensor sensitivity factors for H-field probes



- $f$  = Carrier frequency (GHz)  
 $E_i$  = Electric field strength of channel  $i$  in V/m  
 $H_i$  = Magnetic field strength of channel  $i$  in A/m

The RSS value of the field components gives the total field strength (Hermitian magnitude):

$$E_{\text{tot}} = \sqrt{E_x^2 + E_y^2 + E_z^2}$$

The primary field data are used to calculate the derived field units.

$$SAR = E_{\text{tot}}^2 \cdot \frac{\sigma}{\rho \cdot 1000}$$

- where  $SAR$  = local specific absorption rate in mW/g  
 $E_{\text{tot}}$  = total field strength in V/m  
 $\sigma$  = conductivity in [mho/m] or [siemens/m]  
 $\rho$  = equivalent tissue density in g/cm<sup>3</sup>

Note that the density is normally set to 1 (or 1.06), to account for actual brain density rather than the density of the simulation liquid.

The power flow density is calculated assuming the excitation field as a free space field.

$$P_{\text{pwe}} = \frac{E_{\text{tot}}^2}{3770} \quad \text{or} \quad P_{\text{pwe}} = H_{\text{tot}}^2 \cdot 37.7$$

- where  $P_{\text{pwe}}$  = Equivalent power density of a plane wave in mW/cm<sup>2</sup>  
 $E_{\text{tot}}$  = total electric field strength in V/m  
 $H_{\text{tot}}$  = total magnetic field strength in A/m

## SAR Evaluation – Peak Spatial - Average

The procedure for assessing the peak spatial-average SAR value consists of the following steps

- **Power Reference Measurement**

The reference and drift jobs are useful jobs for monitoring the power drift of the device under test in the batch process. Both jobs measure the field at a specified reference position, at a selectable distance from the phantom surface. The reference position can be either the selected section's grid reference point or a user point in this section. The reference job projects the selected point onto the phantom surface, orients the probe perpendicularly to the surface, and approaches the surface using the selected detection method.

- **Area Scan**

The area scan is used as a fast scan in two dimensions to find the area of high field values, before doing a finer measurement around the hot spot. The sophisticated interpolation routines implemented in OPENSAR software can find the maximum locations even in relatively coarse grids. The scan area is defined by an editable grid. This grid is anchored at the grid reference point of the selected section in the phantom. When the area scan's property sheet is brought-up, grid was at to 15 mm by 15 mm and can be edited by a user.

- **Zoom Scan**

Zoom scans are used to assess the peak spatial SAR values within a cubic averaging volume containing 1 g and 10 g of simulated tissue. The default zoom scan measures 5 x 5 x 7 points within a cube whose base faces are centered around the maximum found in a preceding area scan job within the same procedure. If the preceding Area Scan job indicates more than one maximum, the number of Zoom Scans has to be enlarged accordingly (The default number inserted is 1).

- **Power Drift measurement**

The drift job measures the field at the same location as the most recent reference job within the same procedure, and with the same settings. The drift measurement gives the field difference in dB from the reading conducted within the last reference measurement. Several drift measurements are possible for one reference measurement. This allows a user to monitor the power drift of the device under test within a batch process. In the properties of the Drift job, the user can specify a limit for the drift and have OPENSAR software stop the measurements if this limit is exceeded.

## SAR Evaluation – Peak SAR

The procedure for spatial peak SAR evaluation has been implemented according to the IEEE1529 standard. It can be conducted for 1 g and 10 g. The OPENSAR system allows evaluations that combine measured data and robot positions, such as:

- maximum search
- extrapolation
- boundary correction
- peak search for averaged SAR

During a maximum search, global and local maximum searches are automatically performed in 2-D after each Area Scan measurement with at least 6 measurement points. It is based on the evaluation of the local SAR gradient calculated by the Quadratic Shepard's method. The algorithm will find the global maximum and all local maxima within -2 dB of the global maxima for all SAR distributions.

### Extrapolation

Extrapolation routines are used to obtain SAR values between the lowest measurement points and the inner phantom surface. The extrapolation distance is determined by the surface detection distance and the probe sensor offset. Several measurements at different distances are necessary for the extrapolation.

They are used in the Cube Scan to obtain SAR values between the lowest measurement points and the inner phantom surface. The routine uses the fourth order least square polynomial method for extrapolation. For a grid using 5x5x7 measurement points with 5mm resolution amounting to 343 measurement points, the uncertainty of the extrapolation routines is less than 1% for 1 g and 10 g cubes.

## Definition of Reference Points

### Ear Reference Point

Figure 6.2 shows the front, back and side views of the SAM Phantom. The point “M” is the reference point for the center of the mouth, “LE” is the left ear reference point (ERP), and “RE” is the right ERP. The ERPs are 15mm posterior to the entrance to the ear canal (EEC) along the B-M line (Back-Mouth), as shown in Figure 6.1. The plane passing through the two ear canals and M is defined as the Reference Plane. The line N-F (Neck-Front) is perpendicular to the reference plane and passing through the RE (or LE) is called the Reference Pivoting Line (see Figure 6.1). Line B-M is perpendicular to the N-F line. Both N-F and B-M lines are marked on the external phantom shell to facilitate handset positioning.

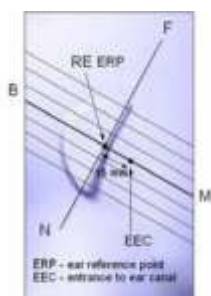

Figure 6.1 Close-up side view of ERP's



Figure 6.2 Front, back and side view of SAM

## Device Reference Points

Two imaginary lines on the device need to be established: the vertical centerline and the horizontal line. The test device is placed in a normal operating position with the “test device reference point” located along the “vertical centerline” on the front of the device aligned to the “ear reference point” (See Fig. 6.3). The “test device reference point” is then located at the same level as the center of the ear reference point. The test device is positioned so that the “vertical centerline” is bisecting the front surface of the device at its top and bottom edges, positioning the “ear reference point” on the outer surface of both the left and right head phantoms on the ear reference point.

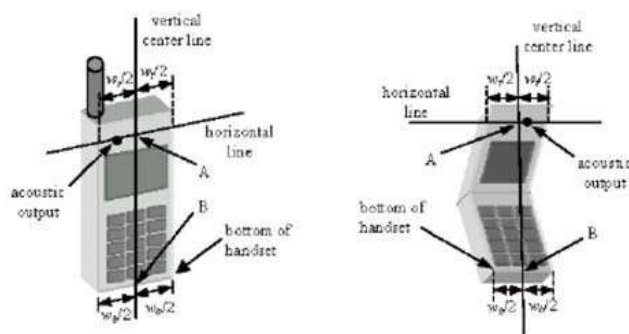

Figure 6.3 Handset Vertical Center & Horizontal Line Reference Points

## Test Configuration – Positioning for Cheek / Touch

1. Position the device close to the surface of the phantom such that point A is on the (virtual) extension of the line passing through points RE and LE on the phantom (see Figure below), such that the plane defined by the vertical center line and the horizontal line of the device is approximately parallel to the sagittal plane of the phantom



**Figure 7.1 Front, Side and Top View of Cheek/Touch Position**

2. Translate the device towards the phantom along the line passing through RE and LE until the device touches the ear.
3. While maintaining the device in this plane, rotate it around the LE-RE line until the vertical centerline is in the plane normal to MB-NF including the line MB (called the reference plane).
4. Rotate the device around the vertical centerline until the device (horizontal line) is symmetrical with respect to the line NF.
5. While maintaining the vertical centerline in the reference plane, keeping point A on the line passing through RE and LE and maintaining the device contact with the ear, rotate the device about the line NF until any point on the device is in contact with a phantom point below the ear (cheek). See Figure below.

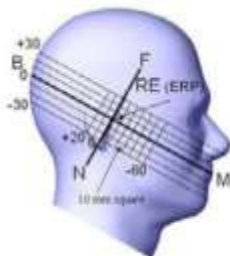

**Figure 7.2 Side view w/ relevant markings**

## Test Configuration – Positioning for Ear / 15° Tilt

With the test device aligned in the Cheek/Touch Position”:

1. While maintaining the orientation of the device, retract the device parallel to the reference plane far enough to enable a rotation of the device by 15 degrees.
2. Rotate the device around the horizontal line by 15 degrees.
3. While maintaining the orientation of the device, move the device parallel to the reference plane until any part of the device touches the head. (In this position, point A is located on the line RE-LE). The tilted position is obtained when the contact is on the pinna. If the contact is at any location other than the pinna, the angle of the device shall be reduced. The tilted position is obtained when any part of the device is in contact with the ear as well as a second part of the device is in contact with the head (see Figure below).



Figure 7.3 Front, Side and Top View of Ear/15° Tilt Position

## Test position – Body Worn Configurations

Body-worn operating configurations are tested with the accessories attached to the device and positioned against a flat phantom in a normal use configuration. A device with a headset output is tested with a headset connected to the device. Body dielectric parameters are used.

Accessories for Body-worn operation configurations are divided into two categories: those that do not contain metallic components and those that do contain metallic components. When multiple accessories that do not contain metallic components are supplied with the device, the device is tested with only the accessory that dictates the closest spacing to the body. Then, when multiple accessories that contain metallic components are supplied with the device, the device is tested with each accessory that contains a unique metallic component. If multiple accessories share an identical metallic component (i.e. the same metallic belt-clip used with different holsters with no other metallic components) only the accessory that dictates the closest spacing to the body is tested.

Body-worn accessories may not always be supplied or available as options for some devices intended to be authorized for body worn use. In this case, a test configuration where a separation distance between the back of the device and the flat phantom is used. All test position spacings are documented.

Transmitters that are designed to operate in front of a person's face, as in push-to-talk configurations, are tested for SAR compliance with the front of the device positioned to face the flat phantom. For devices that are carried next to the body such as a shoulder, waist or chest-worn transmitters, SAR compliance is tested with the accessory(ies), including headsets and microphones, attached to the device and positioned against a flat phantom in a normal use configuration.

In all cases SAR measurements are performed to investigate the worst-case positioning. Worst-case positioning is then documented and used to perform Body SAR testing.

## Test position – Body-worn device

A typical example of a body-worn device is a mobile phone, wireless enabled PDA or other battery operated wireless device with the ability to transmit while mounted on a person's body using a carry accessory approved by the wireless device manufacture.

If the user instructions provided by the manufacturer specify intended use with a carry accessory (belt-clip, holster, carry-case or similar), the device shall be placed as intended in that carry accessory and the carry accessory shall be placed in the intended orientation against the flat phantom.

For carry accessories constructed from non conductive materials that are capable of holding the DUT at varying minimum distances to the phantom, the carry accessory providing the closest separation distance is expected to produce the highest SAR; therefore, testing of the carry accessories providing larger separation distances is not necessary. For carry accessories that do not contain conductive materials (e.g. metal), it is acceptable to substitute the carry accessory with an air-gap or a spacer that keeps the DUT at a distance from the phantom surface no greater than the distance provided by the carry accessory. The spacer shall be made of a low loss and low permittivity material with a loss tangent  $\leq 0,005$  and relative permittivity  $\leq 1,1$ . Accessories that do not contain RF transmitters and have been proven to increase the peak SAR by less than 5 %, such as hands-free kits, do not need SAR tests separate from the SAR tests attached to a main DUT configuration. Annex G provides other information and rationale about hands-free kit testing.

If the user instructions provided by the manufacturer specify an intended use with an appropriate accessory at a certain separation distance to the body, the device shall be positioned as intended at the distance to the outer surface of the phantom that corresponds to the specified distance (Figure 5). When evaluating device SAR without a specific carry accessory, the separation distance shall not exceed 25 mm. The surface of the device pointing towards the flat phantom should be parallel to the surface of the phantom. However, all devices do not have a flat surface. Therefore the details of the device position, e.g. the definition of the distance and the physical relationship between the device and the phantom (see 6.1.4.1), shall be documented in the measurement report according to the manufacturer instructions.

If the intended use is not specified in the user instructions, the device shall be tested with all its surfaces directly against the flat phantom. The details of the device position, especially contact points to the surface of the phantom, shall be documented in the measurement report. If testing for one or more surfaces is omitted, this shall be documented with an associated rationale in the measurement report.

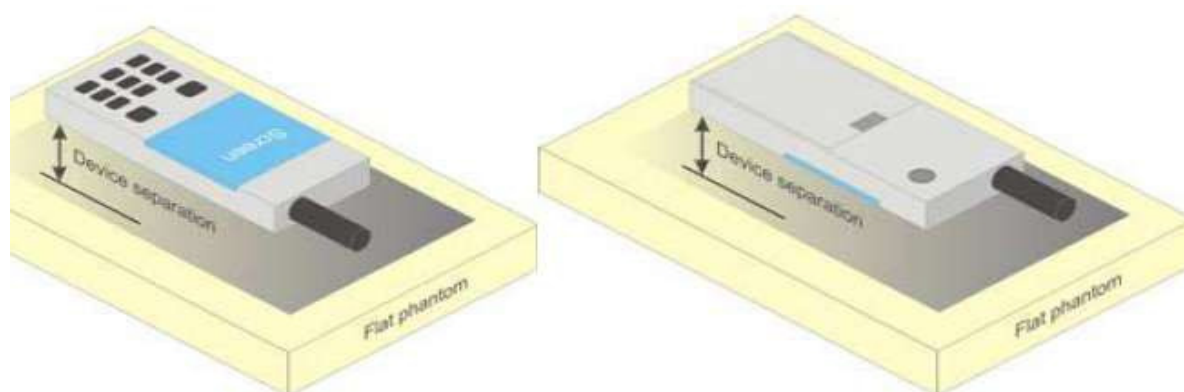
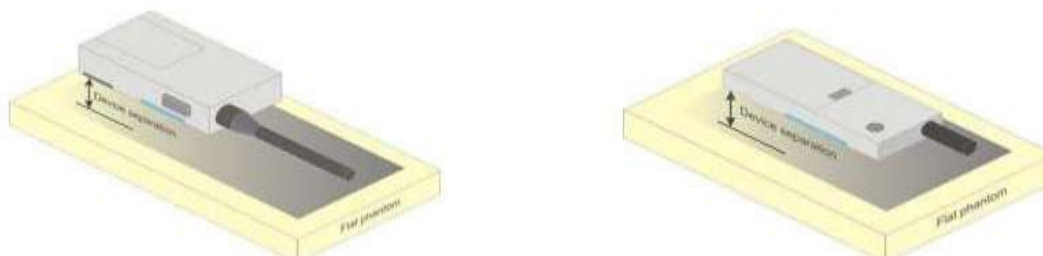

**Figure 5 – Test positions for body-worn devices**



## Test position – Font-of-face device

A typical example of a front-of-face device is a two-yaw radio that is held at a distance from the face of the user when transmitting. In these cases the device under test shall be positioned at the distance to the phantom surface that corresponds to the intended use as specified by the manufacturer in the user instructions (Figure 9a). If the intended use is not specified, a separation distance of 25 mm between the phantom surface and the device shall be used.



**a) Two-way radios**

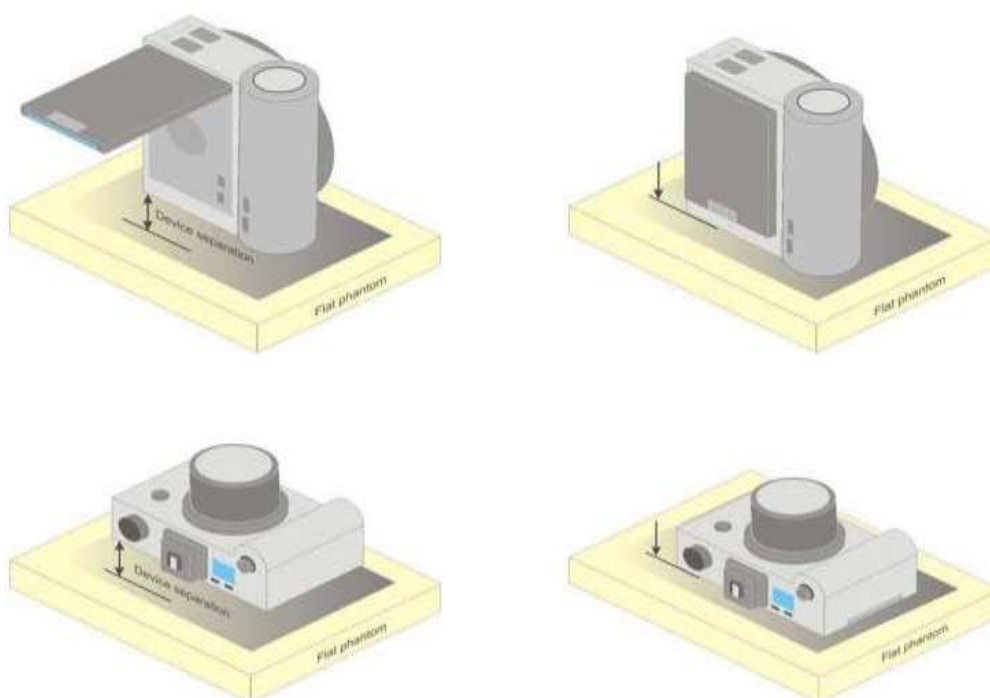

**b) Still cameras and video cameras**

**Figure 9 – Test positions for front-of-face devices**

Other devices that fall into this category include wireless-enabled still cameras and video cameras that can send data to a network of other device (Figure 9b). In the case of a device whose intended use requires a separation distance from the user (e.g., device with a viewing screen), this shall be positioned at the distance to the phantom surface that corresponds to the intended use as specified by the manufacturer in the user instructions (Figure 9b, left side). If the intended use is not specified, a separation distance of 25 mm between the phantom surface and the device shall be used.

For a device whose intended use requires the user's face to be in contact with the device (e.g., device with an optical viewfinder), this shall be placed directly against the phantom (Figure 9b, right side)

## 4. ANSI/IEEE C95.1 – 2005 RF Exposure Limit

In order for users to be aware of the body-worn operating requirements for meeting RF exposure compliance, operating instructions and cautions statements are included in the user's manual.

### Uncontrolled Environment

Uncontrolled Environments are defined as locations where there is the exposure of individuals who have no knowledge or control of their exposure. The general population/uncontrolled exposure limits are applicable to situations in which the general public may be exposed or in which persons who are exposed as a consequence of their employment may not be made fully aware of the potential for exposure or cannot exercise control over their exposure. Members of the general public would come under this category when exposure is not employment-related; for example, in the case of a wireless transmitter that exposes persons in its vicinity.

### Controlled Environment

Controlled Environments are defined as locations where there is exposure that may be incurred by persons who are aware of the potential for exposure, (i.e. as a result of employment or occupation). In general, occupational/controlled exposure limits are applicable to situations in which persons are exposed as a consequence of their employment, who have been made fully aware of the potential for exposure and can exercise control over their exposure. This exposure category is also applicable when the exposure is of a transient nature due to incidental passage through a location where the exposure levels may be higher than the general population/uncontrolled limits, but the exposed person is fully aware of the potential for exposure and can exercise control over his or her exposure by leaving the area or by some other appropriate means.

**Human Exposure Limits**

	UNCONTROLLED ENVIRONMENT General Population (W/kg) or (mW/g)	CONTROLLED ENVIROMENT Professional Population (W/kg) or (mW/g)
SPATIAL PEAK SAR <sup>1</sup> Brain	1.60	8.00
SPATIAL AVERAGE SAR <sup>2</sup> Whole Body	0.08	0.40
SPATIAL PEAK SAR <sup>3</sup> Hands, Feet, Ankles, Wrists	4.00	20.00

<sup>1</sup> The Spatial Peak value of the SAR averaged over any 1 gram of tissue (defined as a tissue volume in the shape of a cube) and over the appropriate averaging time.

<sup>2</sup> The Spatial Average value of the SAR averaged over the whole body.

<sup>3</sup> The Spatial Peak value of the SAR averaged over any 10 grams of tissue (defined as a tissue volume in the shape of a cube) and over the appropriate averaging time.



## 5. System and Liquid Validation

### System Validation

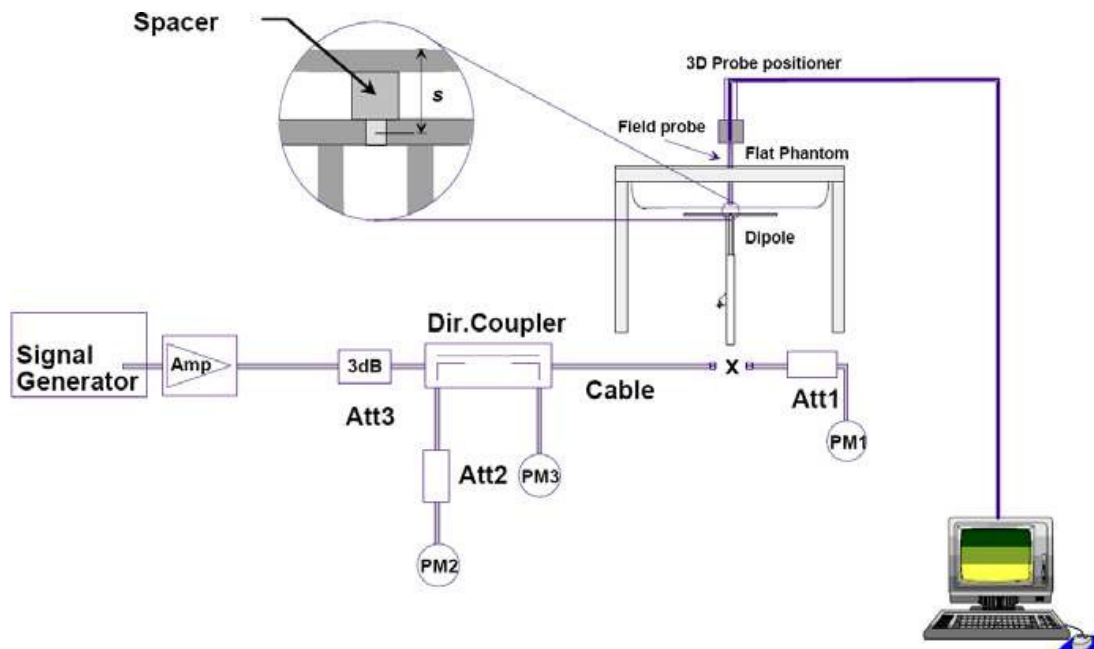

Fig 8.1 System Setup for System Evaluation

The system performance check verifies that the system operates within its specifications. System and operator errors can be detected and corrected. It is recommended that the system performance check be performed prior to any usage of the system in order to guarantee reproducible results. The system performance check uses normal SAR measurements in a simplified setup with a well characterized source. This setup was selected to give a high sensitivity to all parameters that might fail or vary over time. The system check does not intend to replace the calibration of the components, but indicates situations where the system uncertainty is exceeded due to drift or failure.

In the simplified setup for system evaluation, the DUT is replaced by a calibrated dipole and the power source is replaced by a continuous wave that comes from a signal generator. The calibrated dipole must be placed beneath the flat phantom section of the SAM twin phantom with the correct distance holder. The distance holder should touch the phantom surface with a light pressure at the reference marking and be oriented parallel to the long side of the phantom. The equipment setup is shown below:

1. Signal Generator
2. Amplifier
3. Directional Coupler
4. Power Meter
5. Calibrated Dipole

The output power on dipole port must be calibrated to 30 dBm (1000 mW) before dipole is connected.

---

**Numerical reference SAR values (W/kg) for reference dipole and flat phantom**

Frequency (MHz)	1g SAR	10g SAR	Local SAR at surface (above feed-point)	Local SAR at surface (y=2cm offset from feed-point)
300	3.0	2.0	4.4	2.1
450	4.9	3.3	7.2	3.2
835	9.5	6.2	4.1	4.9
900	10.8	6.9	16.4	5.4
1450	29.0	16.0	50.2	6.5
1800	38.1	19.8	69.5	6.8
1900	39.7	20.5	72.1	6.6
2000	41.1	21.1	74.6	6.5
2450	52.4	24.0	104.2	7.7
3000	63.8	25.7	140.2	9.5

**Target and measurement SAR after Normalized**

Measurement Date	Frequency (MHz)	Phantom	Target SAR 1g (W/Kg)	Measured SAR 1g (W/Kg)	Deviation (%)	ConvF
Feb, 04, 2017	450	Head	4.58	4.41	-3.71	19.47
Feb, 04, 2017	450	Body	4.98	5.13	3.01	20.22

## Liquid Validation

The dielectric parameters were checked prior to assessment using the HP85070C dielectric probe kit. The dielectric parameters measured are reported in each correspondent section.

## IEEE SCC-34/SC-2 P1528 recommended Tissue Dielectric Parameters

The head tissue dielectric parameters recommended by the IEEE SCC-34/SC-2 in P1528 have been incorporated in the following table. These head parameters are derived from planar layer models simulating the highest expected SAR for the dielectric properties and tissue thickness variations in a human head. Other head and body tissue parameters that have not been specified in P1528 are derived from the tissue dielectric parameters computed from the 4-Cole-Cole equations and extrapolated according to the head parameters specified in P1528

Target Frequency	Head		Body	
	MHz	$\epsilon_r$	$\sigma$ (S/m)	$\epsilon_r$
150	52.3	0.76	61.9	0.80
300	45.3	0.87	58.2	0.92
450	43.5	0.87	56.7	0.94
835	41.5	0.90	55.2	0.97
900	41.5	0.97	55.0	1.05
915	41.5	0.98	55.0	1.06
1450	40.5	1.20	54.0	1.30
1610	40.3	1.29	53.8	1.40
1800 ~ 2000	40.0	1.40	53.3	1.52
2450	39.2	1.80	52.7	1.95
3000	38.5	2.40	52.0	2.73
5800	35.3	5.27	48.2	6.00

Note:  $\epsilon_r$  = relative permittivity,  $\sigma$  = conductivity and  $\rho = 1000 \text{ kg/m}^3$

## Liquid Confirmation Result :

Measurement date	Temperature : 21.5°C			Relative humidity : 55.1%		
	450 MHz		Target	Measured	Deviation (%)	Limit (%)
Feb, 04, 2017	Head	Permittivity	43.5	42.712	-1.811	±5
		Conductivity	0.87	0.870	-0.011	±5

Measurement date	Temperature : 21.5°C			Relative humidity : 55.1%		
	450 MHz		Target	Measured	Deviation (%)	Limit (%)
Feb, 04, 2017	Head	Permittivity	56.7	57.228	0.931	±5
		Conductivity	0.94	0.930	-1.064	±5

### System Validation Plots

Test Mode : 450 MHz  
 Product Description : Validation Head  
 Model : N/A  
 Test date : February, 04, 2017

Frequency (MHz)	450.000
Relative Permittivity (real part)	42.712
Relative Permittivity (imaginary part)	34.800
Conductivity (S/m)	0.870
Variation	-1.030
SAR 1g (W/Kg)	0.441
SAR 10g (W/Kg)	0.291

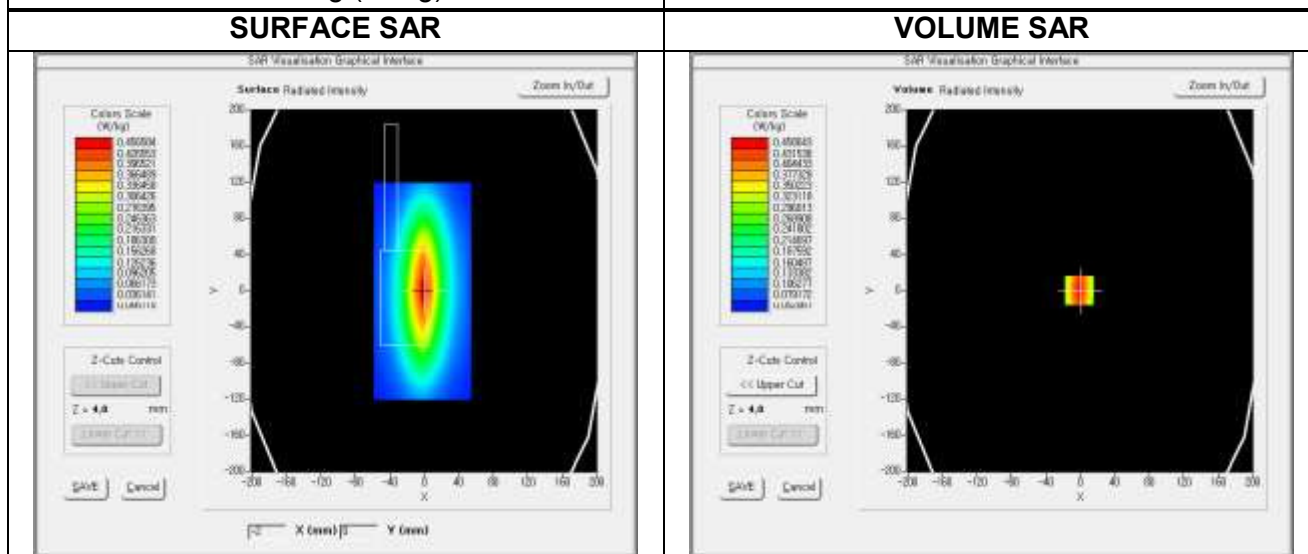

**Z Axis Scan (X=0, Y=0)**

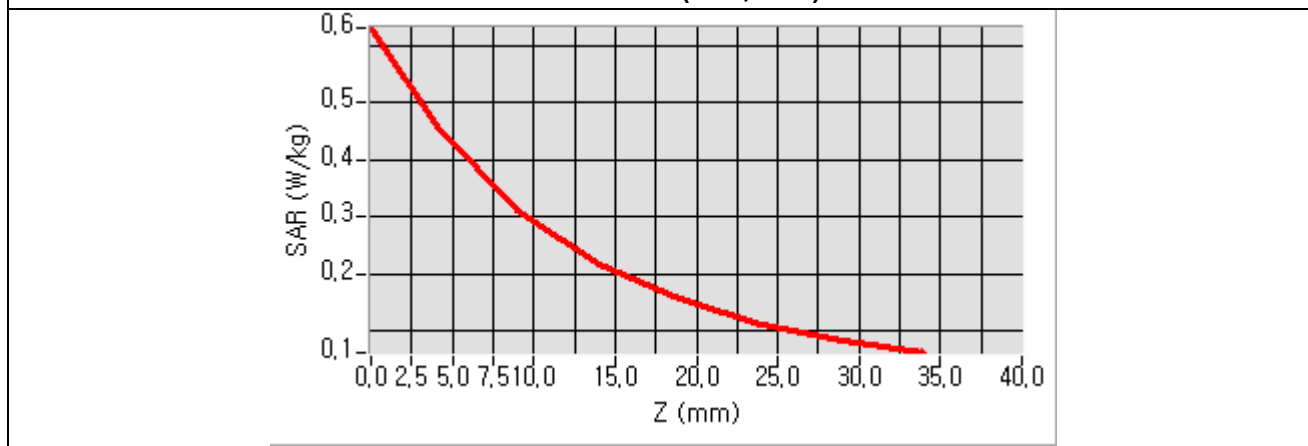

Test Mode : 450 MHz  
 Product Description : Validation Body  
 Model : N/A  
 Test date : February, 04, 2017

Frequency (MHz)	450.000
Relative Permittivity (real part)	57.228
Relative Permittivity (imaginary part)	37.219
Conductivity (S/m)	0.930
Variation	3.300
SAR 1g (W/Kg)	0.513
SAR 10g (W/Kg)	0.351

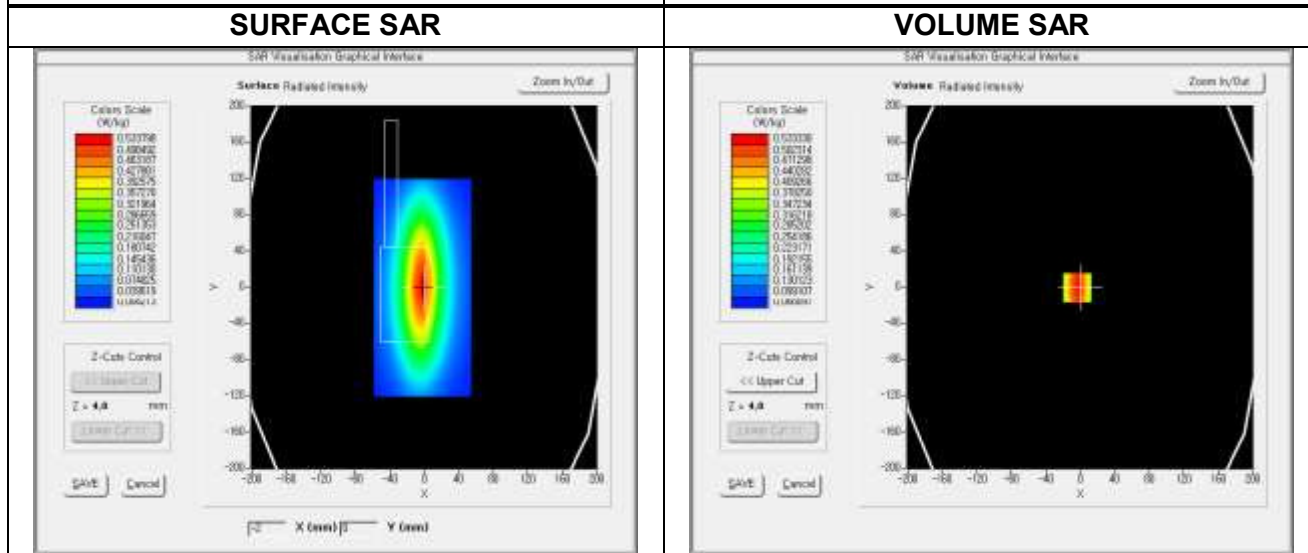

Z Axis Scan (X=0, Y=0)

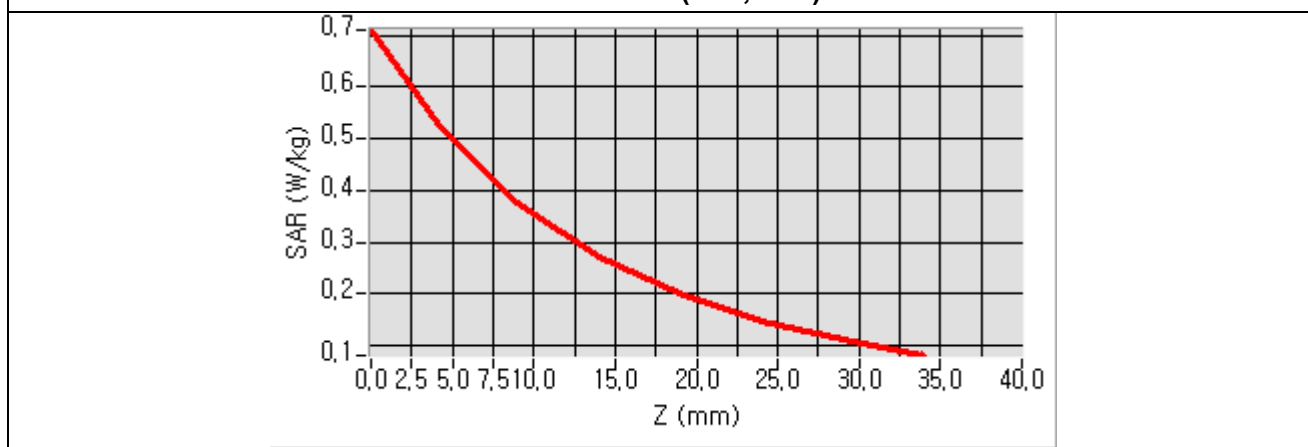

Frequency (MHz)	Epsilon ' "	Epsilon " "	Sigma (S/m)	ns Body Liquid) (+/-5%
400,00	58,11	39,94	0,89	Epsilon ' : 1,58 % Epsilon " : -4,90 %
405,00	57,93	39,50	0,89	Epsilon ' : 1,37 % Epsilon " : -4,85 %
410,00	57,95	39,30	0,90	Epsilon ' : 1,49 % Epsilon " : -4,23 %
415,00	57,79	39,11	0,90	Epsilon ' : 1,30 % Epsilon " : -3,60 %
420,00	57,68	38,72	0,90	Epsilon ' : 1,20 % Epsilon " : -3,49 %
425,00	57,65	38,35	0,91	Epsilon ' : 1,23 % Epsilon " : -3,33 %
430,00	57,60	38,17	0,91	Epsilon ' : 1,22 % Epsilon " : -2,72 %
435,00	57,44	37,99	0,92	Epsilon ' : 1,04 % Epsilon " : -2,11 %
440,00	57,36	37,63	0,92	Epsilon ' : 0,98 % Epsilon " : -2,00 %
445,00	57,32	37,44	0,93	Epsilon ' : 1,00 % Epsilon " : -1,47 %
450,00	57,23	37,22	0,93	Epsilon ' : 0,93 % Epsilon " : -1,01 %
455,00	57,23	36,84	0,93	Epsilon ' : 0,97 % Epsilon " : -0,97 %
460,00	57,03	36,67	0,94	Epsilon ' : 0,66 % Epsilon " : -0,39 %
465,00	57,01	36,40	0,94	Epsilon ' : 0,66 % Epsilon " : -0,08 %
470,00	56,91	36,27	0,95	Epsilon ' : 0,50 % Epsilon " : 0,57 %
475,00	56,88	36,04	0,95	Epsilon ' : 0,49 % Epsilon " : 0,97 %

## &lt;Head Liquid&gt;

Frequency (MHz)	Epsilon ' "	Epsilon " "	Sigma (S/m)	IEC/IEEE Standard Head Liquid) (+/-5%
400,00	43,92	37,20	0,83	Epsilon ' : -0,41 % Epsilon " : -4,98 %
405,00	43,94	37,00	0,83	Epsilon ' : -0,24 % Epsilon " : -4,31 %
410,00	43,61	36,79	0,84	Epsilon ' : -0,84 % Epsilon " : -3,67 %
415,00	43,50	36,52	0,84	Epsilon ' : -0,95 % Epsilon " : -3,22 %
420,00	43,37	36,28	0,85	Epsilon ' : -1,13 % Epsilon " : -2,69 %
425,00	43,32	36,02	0,85	Epsilon ' : -1,11 % Epsilon " : -2,24 %
430,00	43,00	35,74	0,85	Epsilon ' : -1,70 % Epsilon " : -1,87 %
435,00	42,98	35,49	0,86	Epsilon ' : -1,61 % Epsilon " : -1,43 %
440,00	42,95	35,43	0,87	Epsilon ' : -1,54 % Epsilon " : -0,46 %
445,00	42,85	35,13	0,87	Epsilon ' : -1,63 % Epsilon " : -0,18 %
450,00	42,71	34,80	0,87	Epsilon ' : -1,81 % Epsilon " : -0,00 %
455,00	42,64	34,60	0,87	Epsilon ' : -1,92 % Epsilon " : 0,46 %
460,00	42,39	34,41	0,88	Epsilon ' : -2,42 % Epsilon " : 1,00 %
465,00	42,30	34,18	0,88	Epsilon ' : -2,58 % Epsilon " : 1,38 %
470,00	42,26	34,02	0,89	Epsilon ' : -2,61 % Epsilon " : 1,95 %
475,00	42,10	33,81	0,89	Epsilon ' : -2,91 % Epsilon " : 2,36 %

## &lt;Body Liquid&gt;

## 6. TYPE A MEASUREMENT UNCERTAINTY

The component of uncertainty may generally be categorized according to the methods used to evaluate them. The evaluation of uncertainty by the statistical analysis of a series of observations is termed a Type A evaluation of uncertainty. The evaluation of uncertainty by means other than the statistical analysis of a series of observation is termed a Type B evaluation of uncertainty. Each component of uncertainty, however evaluated, is represented by an estimated standard deviation, termed standard uncertainty, which is determined by the positive square root of the estimated variance.

A Type A evaluation of standard uncertainty may be based on any valid statistical method for treating data. This includes calculating the standard deviation of the mean of a series of independent observations; using the method of least squares to fit a curve to the data in order to estimate the parameter of the curve and their standard deviations; or carrying out an analysis of variance in order to identify and quantify random effects in certain kinds of measurement.

A type B evaluation of standard uncertainty is typically based on scientific judgment using all of the relevant information available. These may include previous measurement data, experience and specification, data provided in calibration reports and uncertainties assigned to reference data taken from handbooks. Broadly speaking, the uncertainty is either obtained from an outdoor source or obtained from an assumed distribution, such as the normal distribution, rectangular or triangular distributions indicated in Table .

below :

Uncertainty Distribution	Normal	Rectangle	Triangluar	U shape
Multi-plying Factor(a)	1/K(b)	1/ $\sqrt{3}$	1/ $\sqrt{6}$	1/ $\sqrt{2}$

(a) standard uncertainty is determined as the product of the multiplying factor and the estimated range of variations in the measured quantity

(b)  $\kappa$  is the coverage factor

### Standard Uncertainty for Assumed Distribution

The combined standard uncertainty of the measurement result represents the estimated standard deviation of the result. It is obtained by combining the individual standard uncertainties of both Type A and Type -sum- by taking the positive square root of the estimated variances.

Expanded uncertainty is a measure of uncertainty that defines an interval about the measurement result within which the measured value is confidently believed to lie. It is obtained by multiplying the combined standard uncertainty by a coverage factor. Typically, the coverage factor ranges from 2 to 3. Using a coverage factor allows the true value of a measured quantity to be specified with a defined probability within the specified uncertainty range. For purpose of this document, a coverage factor two is used, which corresponds to confidence interval of about 95 %.

The COMOSAR Uncertainty Budget is show in below table :

## Uncertainty Budget of COMOSAR for frequency range 300 MHz to 6 GHz

Uncertainty Component	Tolerances %	Probability Distribution	Divisor	Ci (1g)	Ci (10g)	Uncertainty 1g(%)	Uncertainty (10g(%)
<b>Measurement System Related</b>							
Probe Calibration	6	N	1	1	1	6	6
Axial Isotropy	3	R	$\sqrt{3}$	$\sqrt{1-C_p}$	$\sqrt{1-C_p}$	1.22474	1.22474
Hemispherical Isotropy	4	R	$\sqrt{3}$	$\sqrt{C_p}$	$\sqrt{C_p}$	1.63299	1.63299
Boundary Effect	1	R	$\sqrt{3}$	1	1	0.57735	0.57735
Linearity	5	R	$\sqrt{3}$	1	1	2.88675	2.88675
System Detection Limits	1	R	$\sqrt{3}$	1	1	0.57735	0.57735
Readout Electronics	0.5	N	1	1	1	0.5	0.5
Response Time	0.2	R	$\sqrt{3}$	1	1	0.11547	0.11547
Integration Time	2	R	$\sqrt{3}$	1	1	1.1547	1.1547
RF Ambient Conditions	3	R	$\sqrt{3}$	1	1	1.73205	1.73205
Probe Positioner Mechanical Tolerances	2	R	$\sqrt{3}$	1	1	1.1547	1.1547
Probe Positioning with respect to Phantom Shell	1	R	$\sqrt{3}$	1	1	0.57735	0.57735
Extrapolation, Interpolation and integration Algorithms for Max. SAR Evaluation	1.5	R	$\sqrt{3}$	1	1	0.86603	0.86603
<b>Test Sample Related</b>							
Test Sample Positioning	1.5	N	1	1	1	1.5	1.5
Device Holder Uncertainty	5	N	1	1	1	5	5
Output Power Variation – SAR Drift measurement	3	R	$\sqrt{3}$	1	1	1.73205	1.73205
<b>Phantom and Tissue Parameters Related</b>							
Phantom Uncertainty (Shape and thickness Tolerances)	4	R	$\sqrt{3}$	1	1	2.3094	2.394
Liquid Conductivity – deviation from target value	5	R	$\sqrt{3}$	0.64	0.43	1.84752	1.2413
Liquid Conductivity – Measurement Uncertainty	2.5	N	1	0.64	0.43	1.6	1.075
Liquid Permittivity – deviation from target value	3	R	$\sqrt{3}$	0.6	0.49	1.03923	0.8487
Liquid Permittivity – Measurement Uncertainty	2.5	N	1	0.6	0.49	1.5	1.225
Combined Standard Uncertainty						9.66051%	9.52428%
<b>Expanded Standard Uncertainty ( K=2 , confidence 95%)</b>						<b>18.9346%</b>	<b>18.6676%</b>



## 7. OUTPUT POWER VERIFICATION

### FM (Analog / DMR)

Mode	Mode	Channel	Frequency (MHz)	Conducted Power (dBm)
FM - Analog	4.8 W	1	410.0125	36.16
		256	440.0125	36.01
		512	469.7000	35.47

Mode	Mode	Channel	Frequency (MHz)	Conducted Power (dBm)
FM - DMR	4.8 W	1	410.0125	36.11
		256	440.0125	36.12
		512	469.7000	35.41

## 8. TEST CONDITION

The EUT was tested in the face position with front of the device 1 inch away from the flat phantom and the body position with the belt clip in contact with the flat phantom. For each of the tests conducted. The device was set to continuously transmit at a maximum output power on the channel specified in the test data. The EUT was tested in the worst case (PTT button).

The SAR for analog mode was scaled to 75% duty cycle per KDB 643646 D06.  
All tests reductions were reduced based on the reductions in KDB 643646 D06.

For digital mode, press the PTT button, engineering firmware installed on the EUT can provide continuous transmitting RF signal (50 % duty) despite EUT use VOX capabilities. So duty factor was applied to this project.

## 9. SAR TEST RESULTS

Front of Device 25 mm from Phantom							
Mode	Channel	Temp (°C)	Drift (%)	1g SAR (W/Kg)	10g SAR (W/Kg)	1g SAR (W/kg) Duty 75%/50%	ConvF
Analog	1	21.7	2.37	3.395	2.492	2.546	19.47
	256		2.11	5.327	3.856	3.995	
	512		0.02	3.891	2.824	2.918	
DMR	1	21.7	-0.62	2.002	1.448	1.001	
	256		-3.14	2.606	1.897	1.303	
	512		-1.19	1.538	1.111	0.769	

Body-Worn Back of Device 0 mm from Phantom							
Mode	Channel	Temp (°C)	Drift (%)	1g SAR (W/Kg)	10g SAR (W/Kg)	1g SAR (W/Kg) Duty 75%/50%	ConvF
Analog	1	21.7	-0.90	6.393	4.755	4.795	20.22
	256		-0.10	5.206	3.849	3.905	
	512		0.58	5.118	3.783	3.839	
DMR	1	21.7	3.53	4.182	2.811	2.091	
	256		-0.88	3.285	2.157	1.643	
	512		1.26	2.546	1.818	1.273	

**Note :****Test separation distances**

KDB 643646 D01 – Appendix

Head SAR Test consideration.

Head SAR is measured with the front surface of the radio positioned at 1 inch parallel to a flat phantom

## Test Method List

447498 D01 v06 General RF Exposure Guidance

865664 D01 v01r04 SAR Measurement 100 MHz to 6 GHz

643646 D01 v01r03 SAR Test for PTT Radios

### SAR Measurement Plots

Test Mode : 410.0125 MHz // Front of Device 25 mm from Phantom // ch 1  
 Product Description : Push to Talk - Analog  
 Model : XP-400D  
 Test date : February, 04, 2017

Frequency (MHz)	410.0125
Relative Permittivity (real part)	43.612
Relative Permittivity (imaginary part)	36.792
Conductivity (S/m)	0.838
Variation	2.370
SAR 1g (W/Kg)	3.395
SAR 10g (W/Kg)	2.492

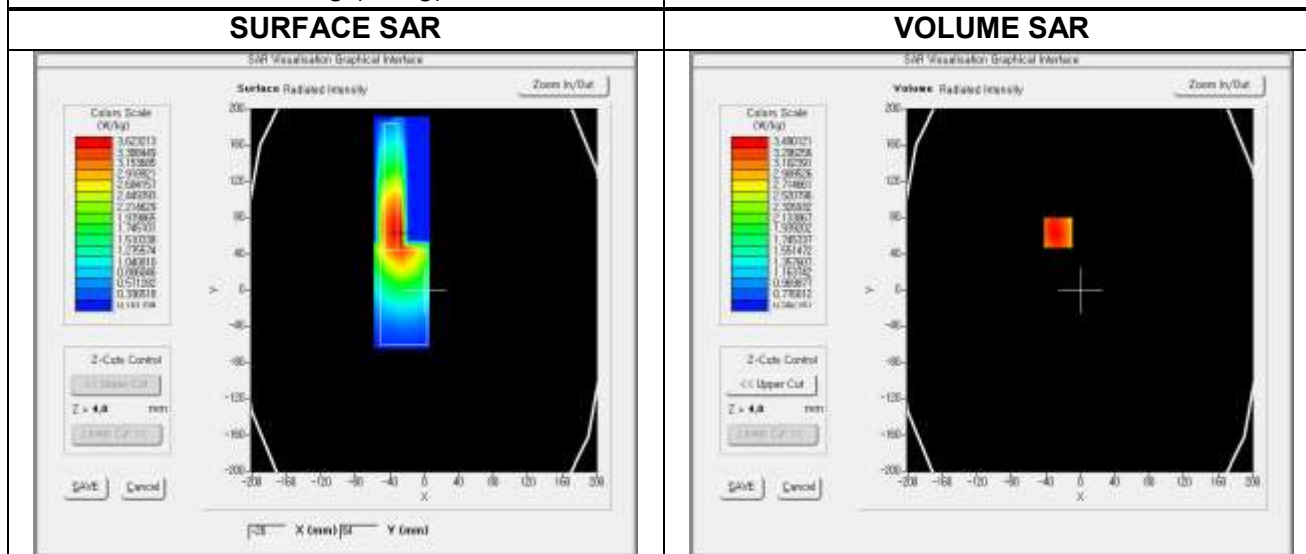

**Z Axis Scan (X=0, Y=0)**

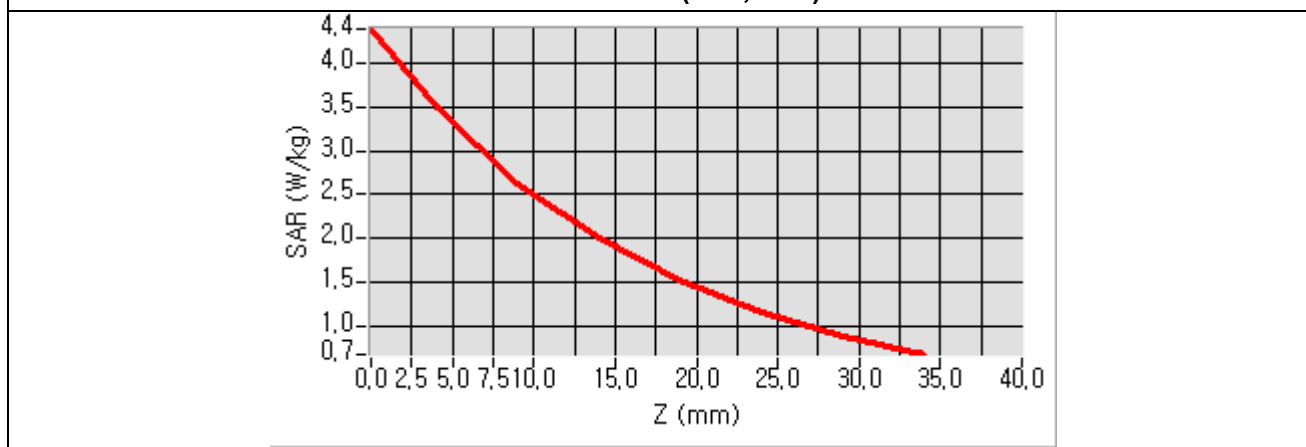

Test Mode : 440.0125 MHz // Front of Device 25 mm from Phantom // ch 256  
 Product Description : Push to Talk - Analog  
 Model : XP-400D  
 Test date : February, 04, 2017

Frequency (MHz)	440.0125
Relative Permittivity (real part)	42.947
Relative Permittivity (imaginary part)	36.427
Conductivity (S/m)	0.866
Variation	2.110
SAR 1 g (W/kg)	5.327
SAR 10 g (W/kg)	3.856

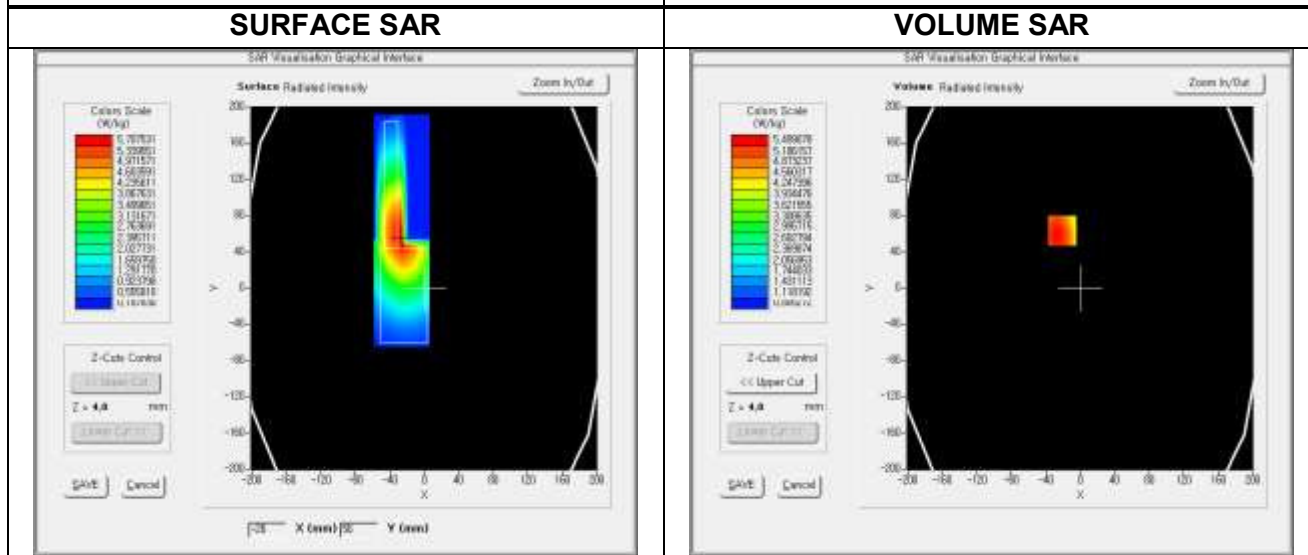

Z Axis Scan (X=0, Y=0)

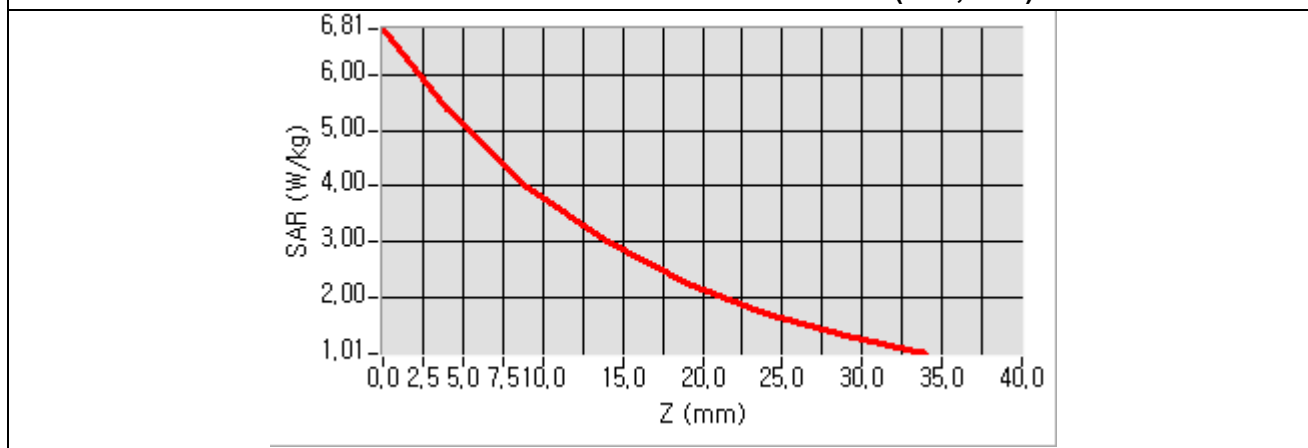

Test Mode : 469.700 MHz // Front of Device 25 mm from Phantom // ch 512  
 Product Description : Push to Talk - Analog  
 Model : XP-400D  
 Test date : February 04, 2017

Frequency (MHz)	469.700
Relative Permittivity (real part)	42.263
Relative Permittivity (imaginary part)	34.020
Conductivity (S/m)	0.888
Variation	0.020
SAR 1g (W/Kg)	3.891
SAR 10g (W/Kg)	2.824

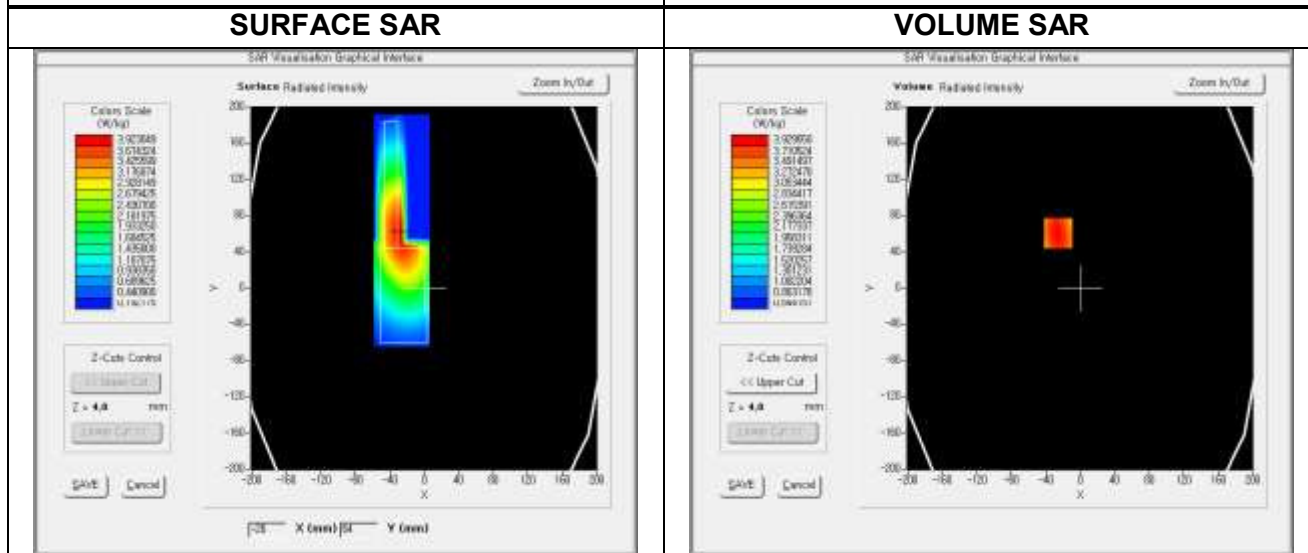

Z Axis Scan (X=0, Y=0)

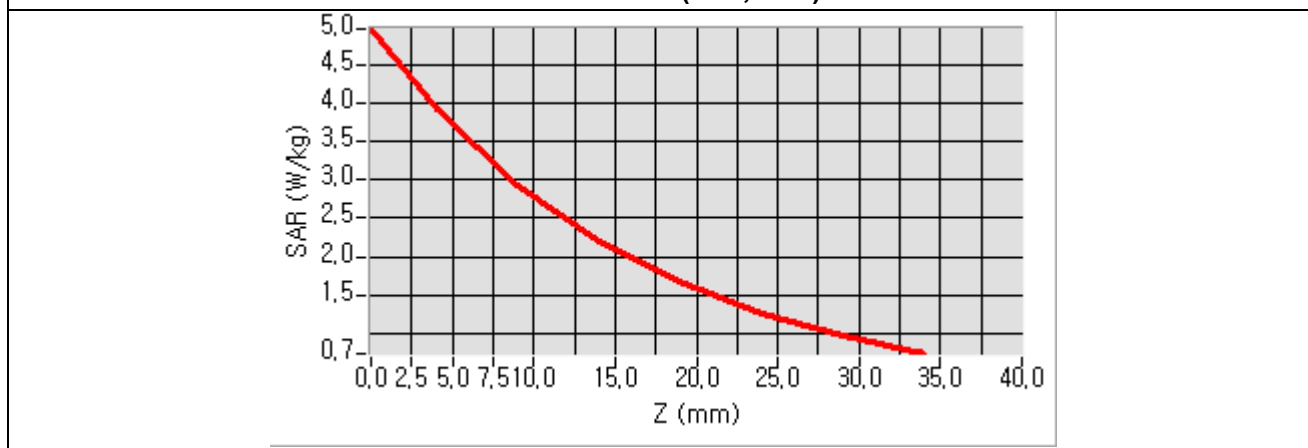

Test Mode : 410.0125 MHz // Body-Worn Back of Device 0 mm // ch 1  
 Product Description : Push to Talk - Analog  
 Model : XP-400D  
 Test date : February 04, 2017

Frequency (MHz)	410.0125
Relative Permittivity (real part)	57.951
Relative Permittivity (imaginary part)	39.297
Conductivity (S/m)	0.895
Variation	-0.090
SAR 1g (W/Kg)	6.393
SAR 10g (W/Kg)	4.756

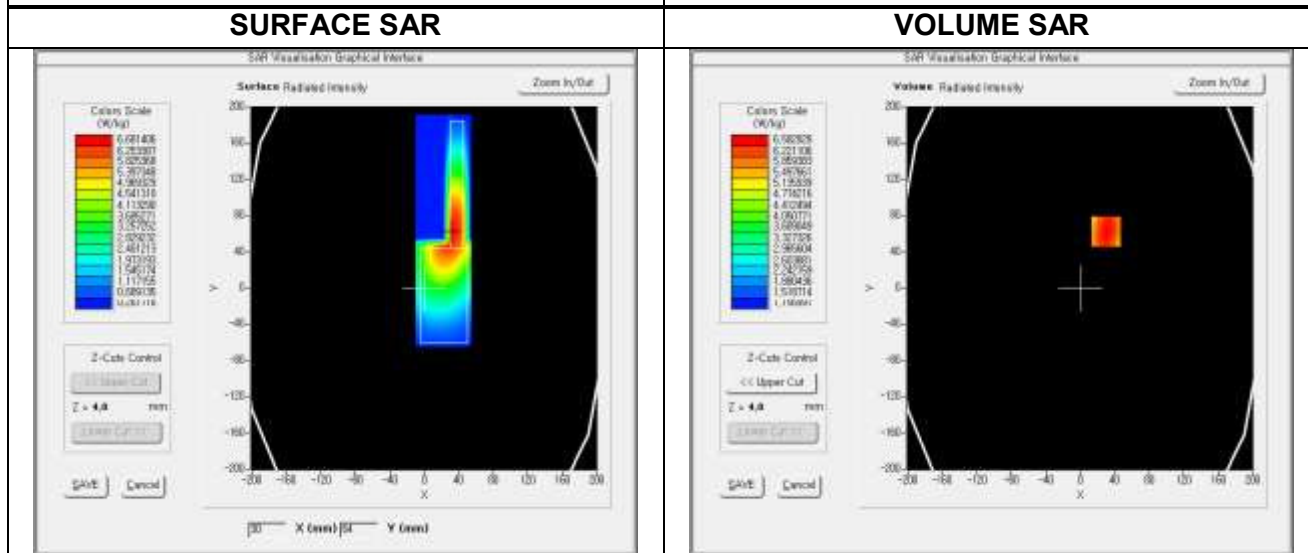

Z Axis Scan (X=0, Y=0)

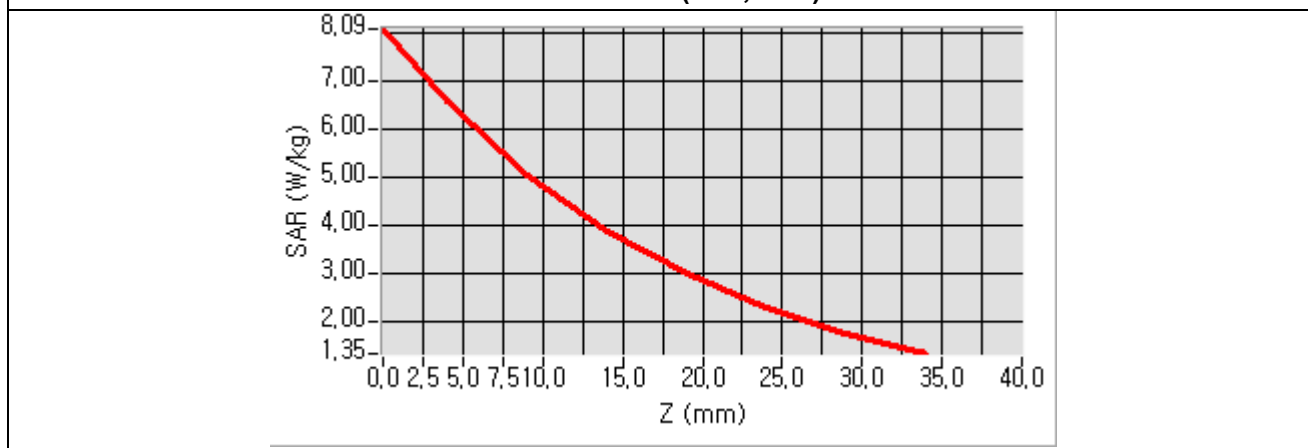

Test Mode : 440.0125 MHz // Body-Worn Back of Device 0 mm // ch 256  
 Product Description : Push to Talk - Analog  
 Model : XP-400D  
 Test date : February 04, 2017

Frequency (MHz)	440.0125
Relative Permittivity (real part)	57.358
Relative Permittivity (imaginary part)	37.633
Conductivity (S/m)	0.920
Variation	-0.100
SAR 1 g (W/kg)	5.206
SAR 10 g (W/kg)	3.849

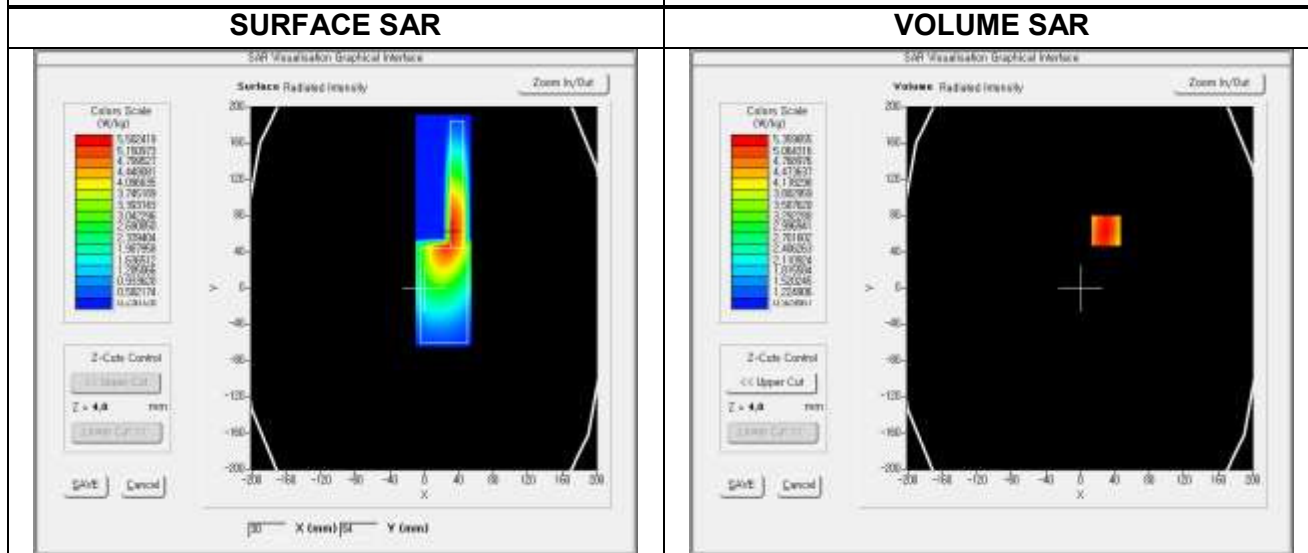

Z Axis Scan (X=0, Y=0)

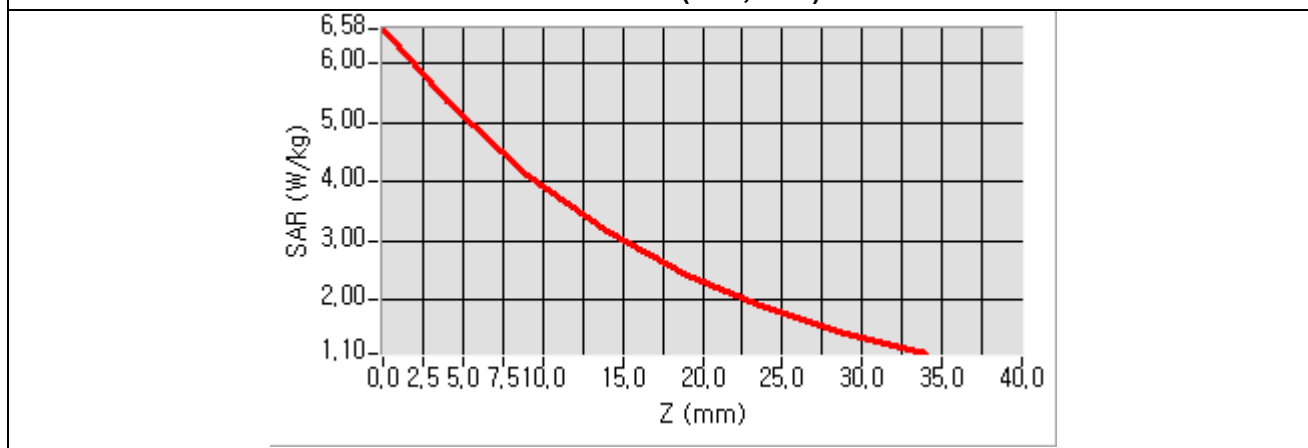



Test Mode : 469.700 MHz // Body-Worn Back of Device 0 mm // ch 512  
 Product Description : Push to Talk - Analog  
 Model : XP-400D  
 Test date : February 04, 2017

Frequency (MHz)	469.700
Relative Permittivity (real part)	56.913
Relative Permittivity (imaginary part)	36.274
Conductivity (S/m)	0.947
Variation	0.580
SAR 1g (W/Kg)	5.118
SAR 10g (W/Kg)	3.783

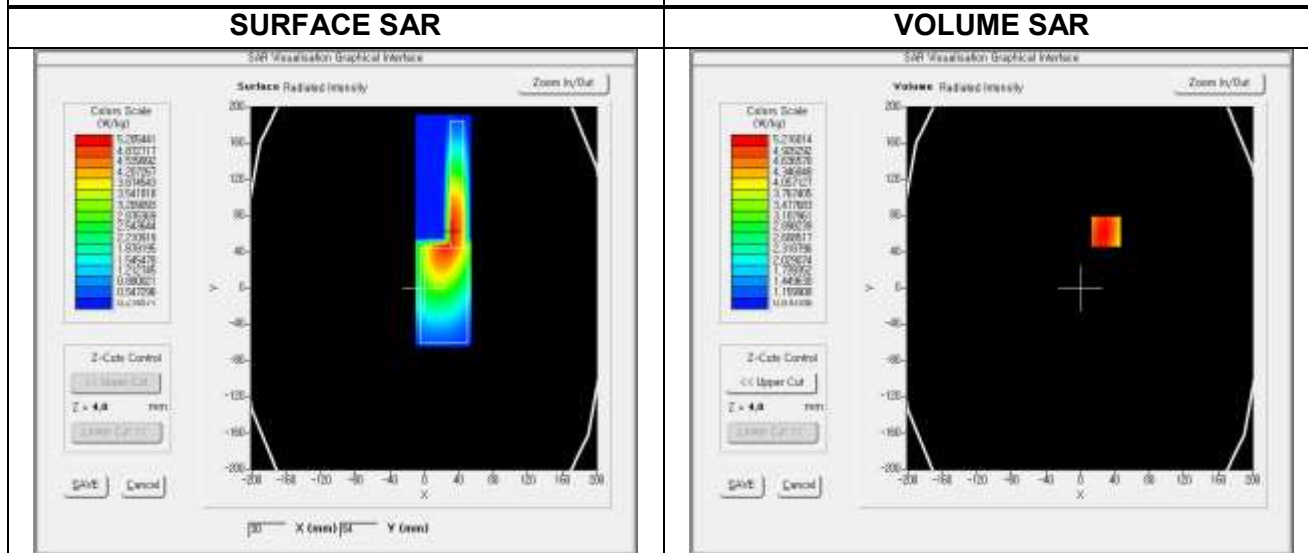

Z Axis Scan (X=0, Y=0)

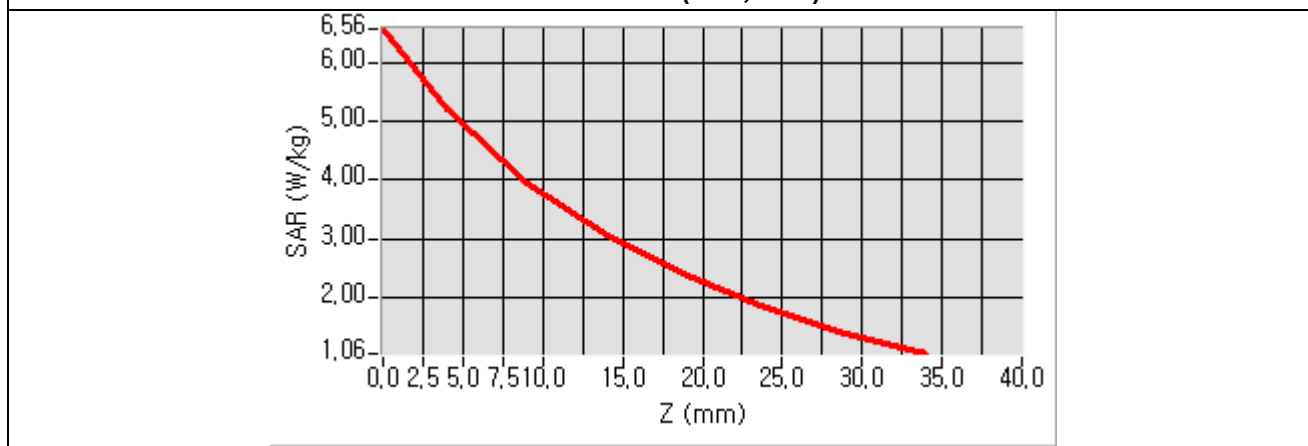

Test Mode : 410.0125 MHz // Front of Device 25 mm from Phantom // ch 1  
 Product Description : Push to Talk - DMR  
 Model : XP-400D  
 Test date : February 04, 2017

Frequency (MHz)	410.0125
Relative Permittivity (real part)	43.612
Relative Permittivity (imaginary part)	36.792
Conductivity (S/m)	0.838
Variation	-0.620
SAR 1g (W/Kg)	2.002
SAR 10g (W/Kg)	1.448

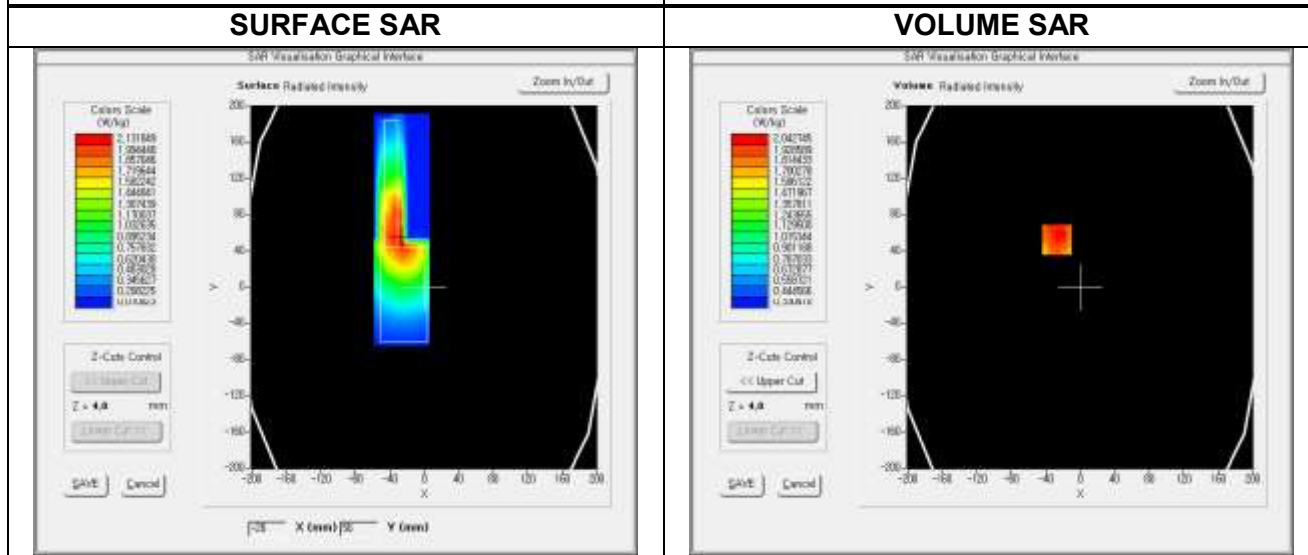

**Z Axis Scan (X=0, Y=0)**

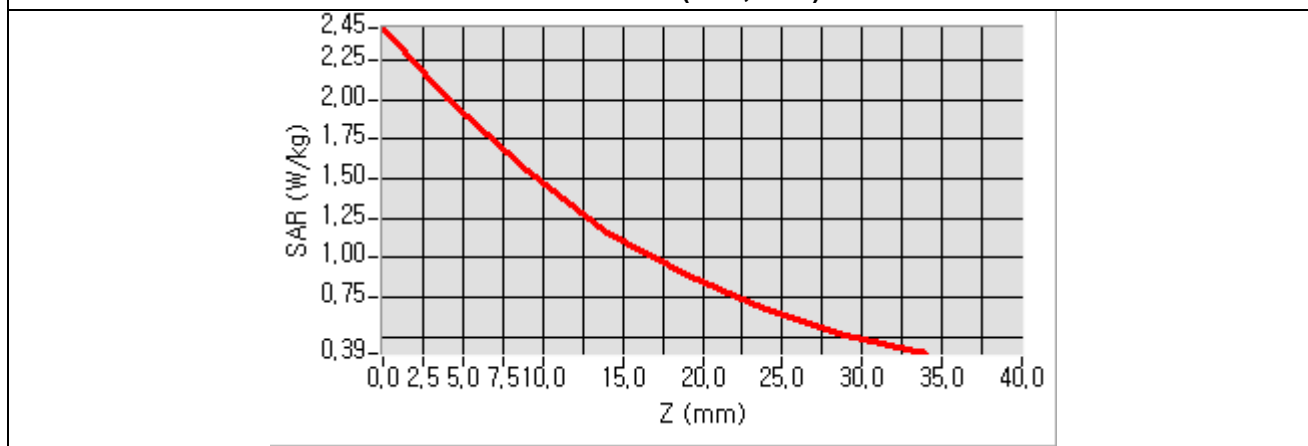

Test Mode : 440.0125 MHz // Front of Device 25 mm // ch 256  
 Product Description : Push to Talk - DMR  
 Model : XP-400D  
 Test date : February 04, 2017

Frequency (MHz)	440.0125
Relative Permittivity (real part)	42.947
Relative Permittivity (imaginary part)	36.427
Conductivity (S/m)	0.866
Variation	-3.140
SAR 1 g (W/kg)	2.606
SAR 10 g (W/kg)	1.897

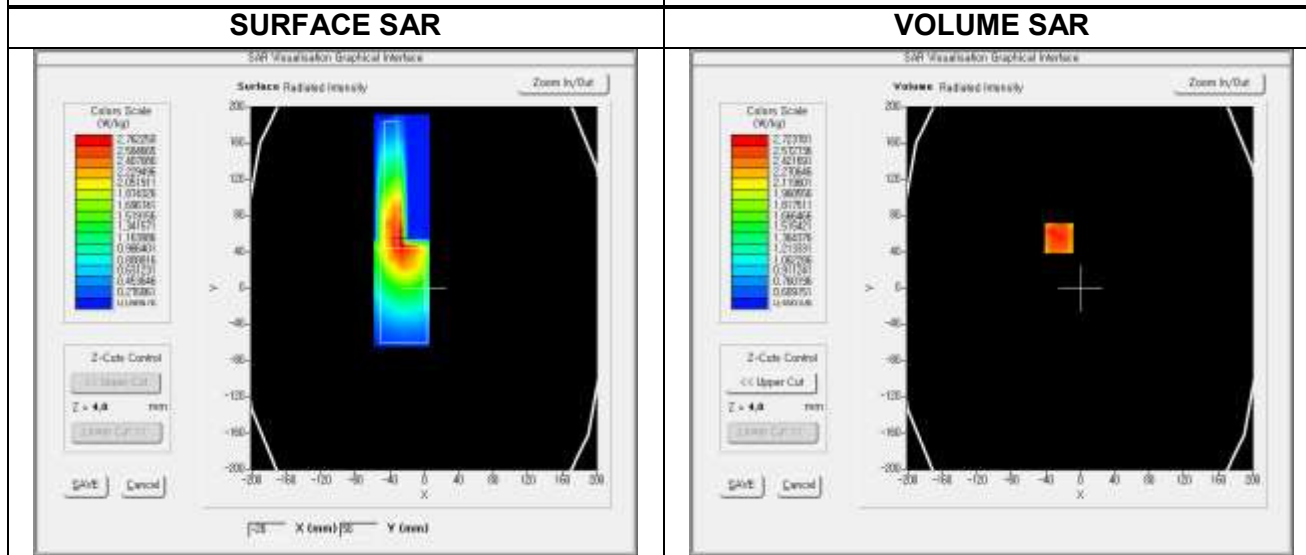

Z Axis Scan (X=0, Y=0)

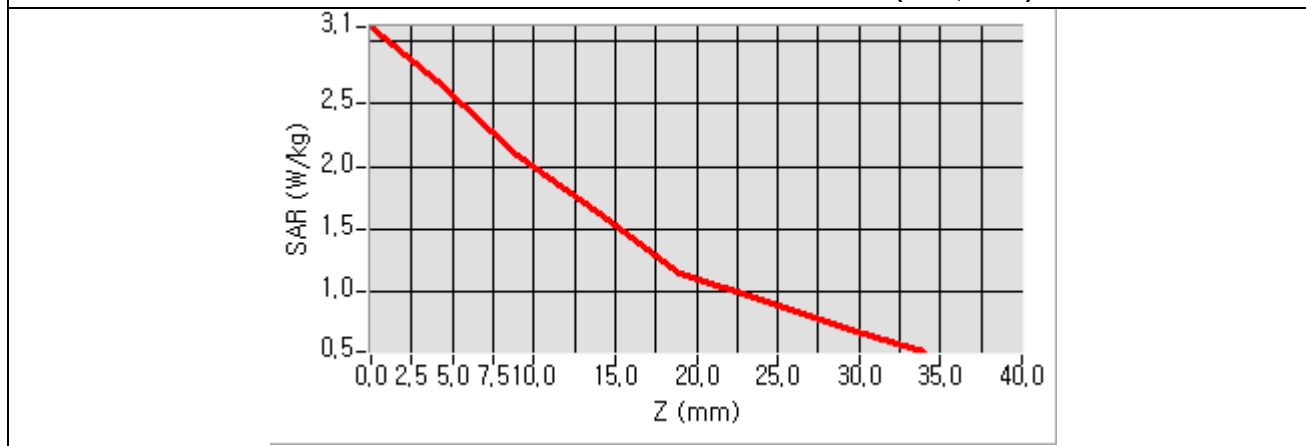

Test Mode : 469.700 MHz // Front of Device 25 mm from Phantom // ch 512  
 Product Description : Push to Talk - DMR  
 Model : XP-400D  
 Test date : February 04, 2017

Frequency (MHz)	469.700
Relative Permittivity (real part)	42.263
Relative Permittivity (imaginary part)	34.020
Conductivity (S/m)	0.888
Variation	-1.190
SAR 1g (W/Kg)	1.538
SAR 10g (W/Kg)	1.111

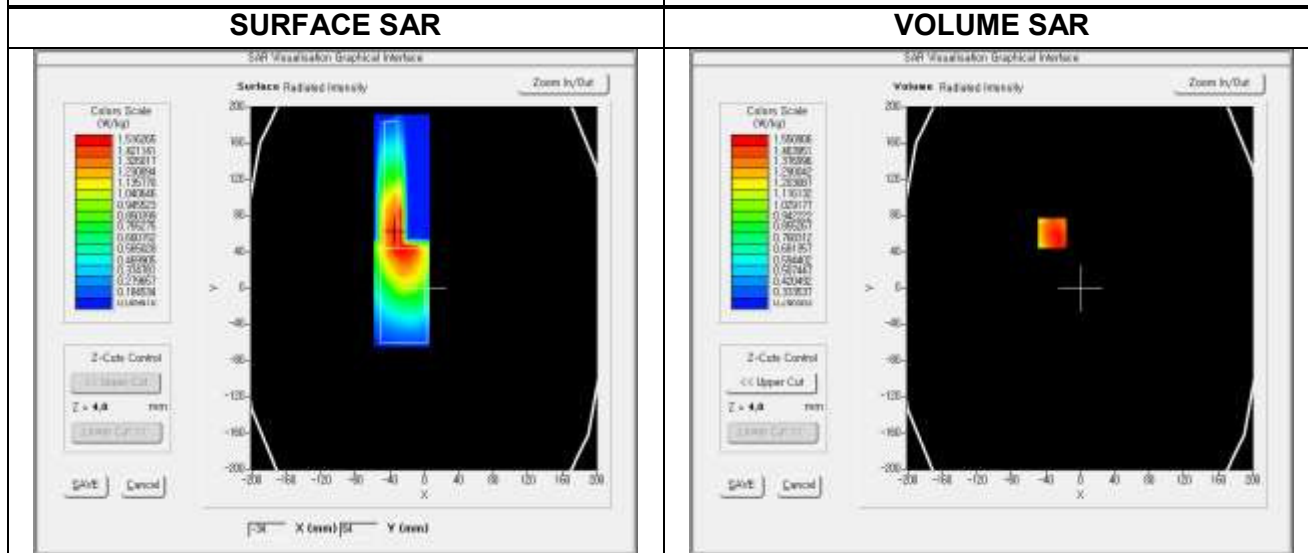

Z Axis Scan (X0, Y=0)

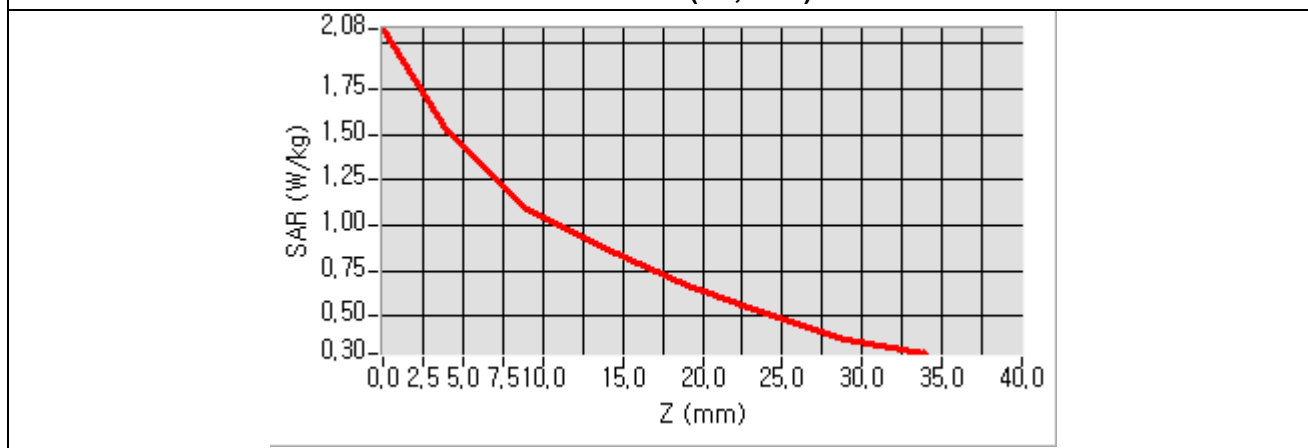

Test Mode : 410.0125 MHz // Body-Worn Back of Device 0 mm // ch 1  
 Product Description : Push to Talk - DMR  
 Model : XP-400D  
 Test date : February 04, 2017

Frequency (MHz)	410.0125
Relative Permittivity (real part)	57.951
Relative Permittivity (imaginary part)	39.297
Conductivity (S/m)	0.895
Variation	3.530
SAR 1g (W/Kg)	4.182
SAR 10g (W/Kg)	2.811

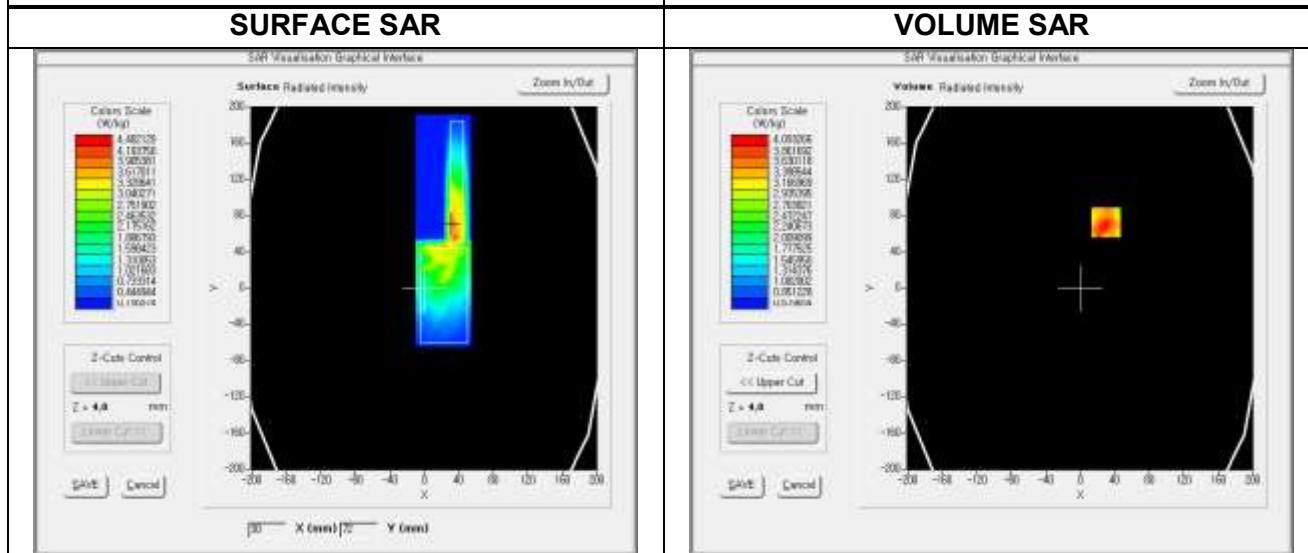

Z Axis Scan (X=0, Y=0)

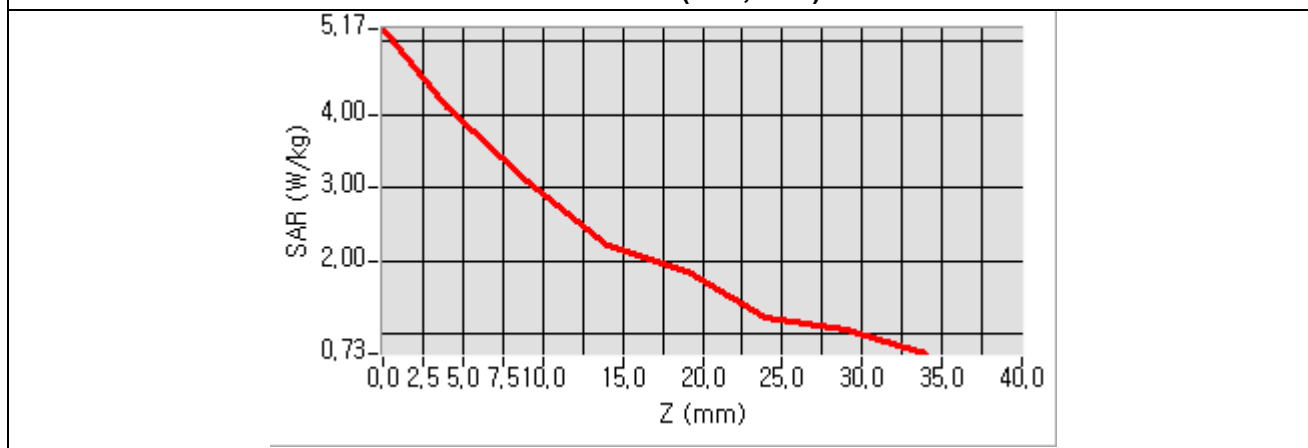

Test Mode : 440.0125 MHz // Body-Worn Back of Device 0 mm // ch 256  
 Product Description : Push to Talk - DMR  
 Model : XP-400D  
 Test date : February 04, 2017

Frequency (MHz)	440.0125
Relative Permittivity (real part)	57.358
Relative Permittivity (imaginary part)	37.633
Conductivity (S/m)	0.920
Variation	-0.880
SAR 1 g (W/kg)	3.285
SAR 10 g (W/kg)	2.157

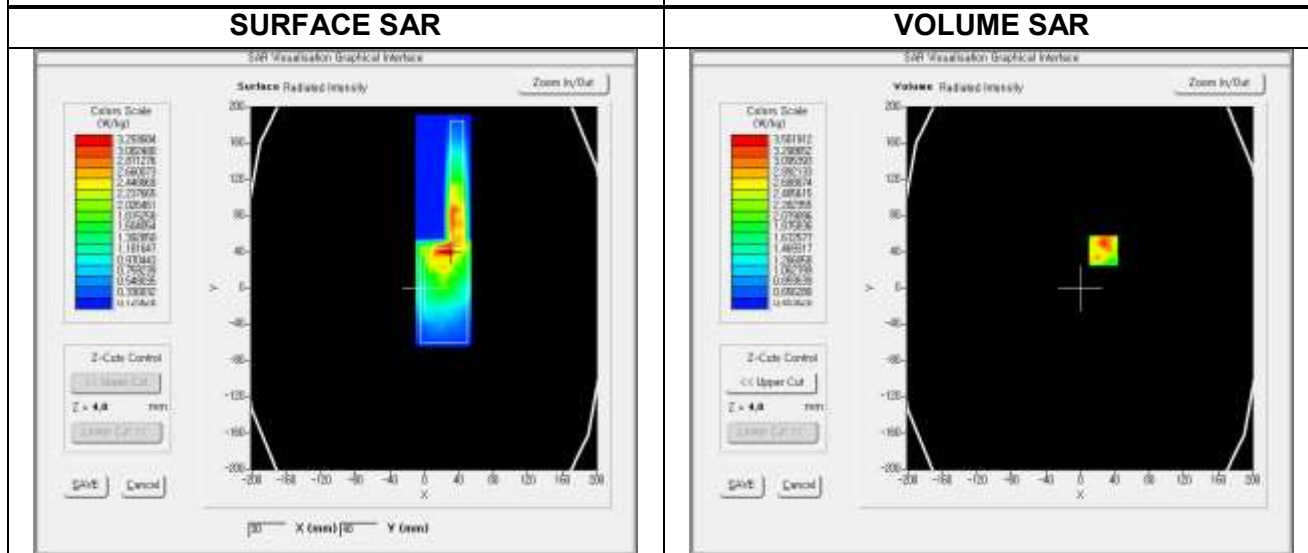

Z Axis Scan (X=0, Y=0)

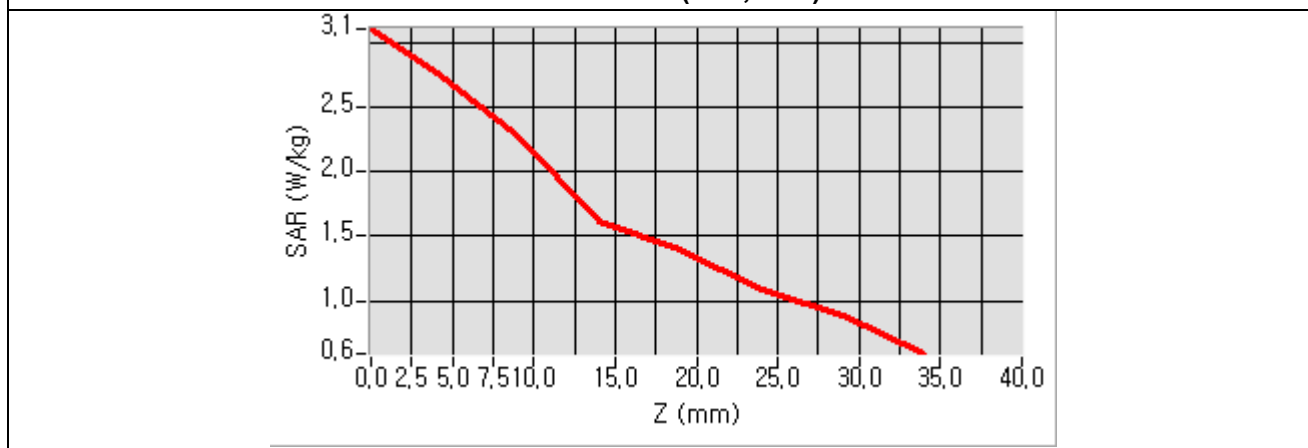

Test Mode : 469.700 MHz // Body-Worn Back of Device 0 mm // ch 512  
 Product Description : Push to Talk - DMR  
 Model : XP-400D  
 Test date : February 04, 2017

Frequency (MHz)	469.700
Relative Permittivity (real part)	56.913
Relative Permittivity (imaginary part)	36.274
Conductivity (S/m)	0.947
Variation	1.260
SAR 1g (W/Kg)	2.546
SAR 10g (W/Kg)	1.818

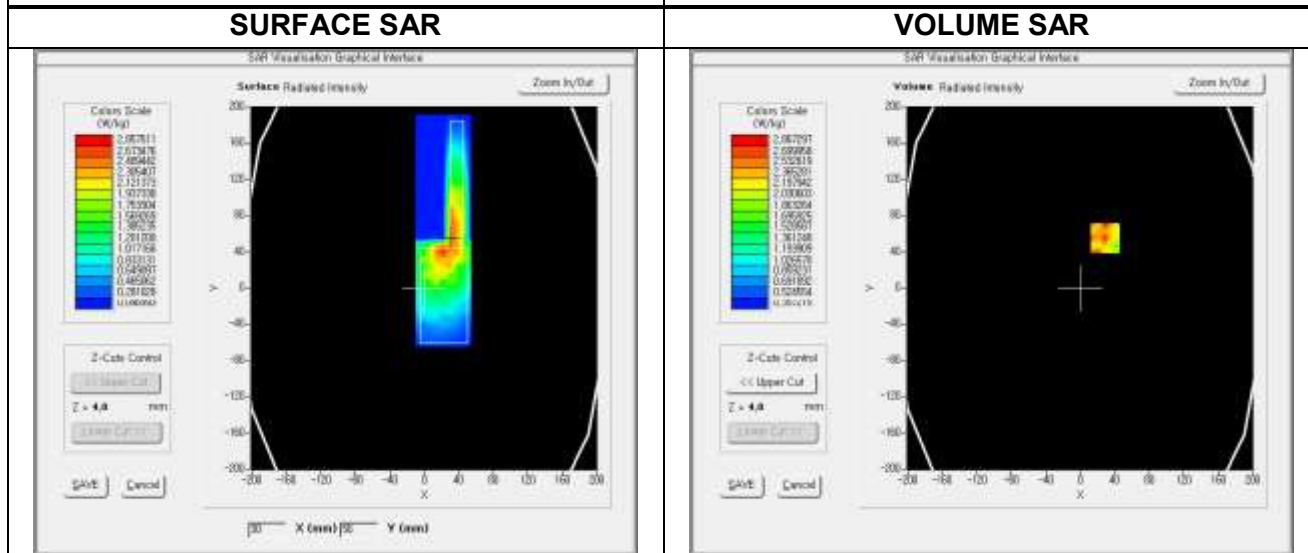

Z Axis Scan (X=0, Y=0)

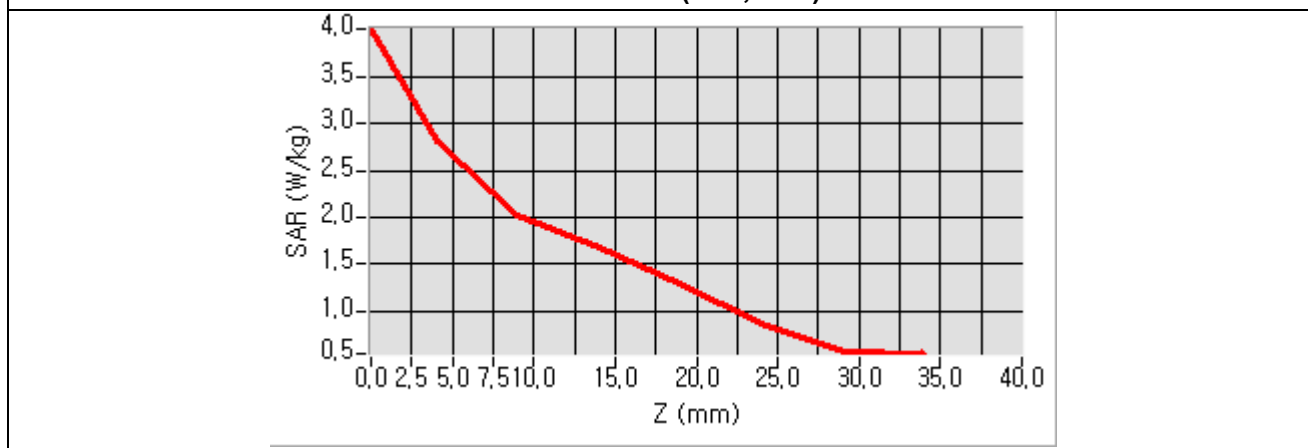

## Annex A. Test Instrument

Name of Equipment	Model	Serial Number	Manufacturer	Last Cal. Date
ROBOT KR6-R900 KUKA	KR 6 R900 sixx	500106	KUKA	N/A
KUKA ROBOT CONTROLLER	KCP	7611	KUKA	N/A
KUKA ROBOT CONTROL BOX	KRC4	212851	KUKA	N/A
KUKA ROBOT VPS	VPS	SN 12/13 VPS 37	KUKA	N/A
COMOSAR PROBE FOR VPS	PROBE FOR VPS	SN 04/13 RT34	SATIMO	N/A
PROBE HOLDER SECURITY	PROBE HOLDER SECURITY	SN 12/13 SUPR56	KUKA	N/A
USB GPIB	10833C	HB5748863	SATIMO	N/A
USB GPIB	GPIB-USB-HS	181941D	NI	N/A
PCI FIREWIRE CARD	AA25280	IE-V13-2121-00-00012	ST Lab	N/A
HASP USB KEY	HASP USB KEY	1660881042	KUKA	N/A
COMOSAR IEEE SAM PHANTOM	SAM PHANTOM	SN 12/13 SAM98	SATIMO	N/A
COMOSAR ELLIPTIC PHANTOM	ELLIPTIC PHANTOM	SN 12/13 ELLI25	SATIMO	N/A
MOBILE PHONE POSITIONING SYSTEM	HANDSET POSITIONING	SN 12/13 MSH81	SATIMO	N/A
LAPTOP POSITIONING SYSTEM	DEVICE POSITIONING	SN 25/12 LSH18	SATIMO	N/A
COMOSAR DOSIMETRIC E FIELD PROBE	SSE2	SN 27/14 EPG226	SATIMO	2016-08-17
COMOSAR DUMMY PROBE	DUMMY PROBE	SN 11/13 DP48	SATIMO	N/A
LIMESAR DIELECTRIC PROBE	SCLMP	SN 12/13 OCPG52	SATIMO	2016-03-02
COMMUNICATION ANTENNA	COMMUNICATION ANTENNA	SN 26/12 ANTA41	SATIMO	N/A
COMOSAR 300 MHz REFERENCE DIPOLE	SID300	SN 12/13 DIP0G300-221	SATIMO	2016-03-02
COMOSAR 450 MHz REFERENCE DIPOLE	SID450	SN 12/13 DIP0G450-222	SATIMO	2016-03-02
COMOSAR 835 MHz REFERENCE DIPOLE	SID835	SN 12/13 DIP0G835-223	SATIMO	2016-03-02
COMOSAR 1800 MHz REFERENCE DIPOLE	SID1800	SN 12/13 DIP1G800-225	SATIMO	2016-03-02
COMOSAR 2000 MHz REFERENCE DIPOLE	SID2000	SN 12/13 DIP2G000-227	SATIMO	2016-03-02
COMOSAR 2450 MHz REFERENCE DIPOLE	SID2450	SN 12/13 DIP2G450-228	SATIMO	2016-03-02
COMOSAR 5000-6000 MHz REFERENCE WAVEGUIDE	SWG5500	SN 41/12 WGA20	SATIMO	2016-03-02
Attenuator (6dB)	8491A-6	34082	HP	2016-03-21
Attenuator (10dB)	8491A-10	58121	HP	2016-03-21
Attenuator (30dB)	8491B	04306	HP	2016-03-21
Dual Directional Coupler	772D	2839A01038	HP	2016-03-21
Dual Directional Coupler	778D	13020	HP	2016-03-21
Directional Coupler	779D	13021	HP	2016-03-22
MULTIMETER	KEITHLEY 2000	4014116	KEITHLEY	2016-02-17
SCAN CARD	SCAN CARD KIETHLEY	4014091	KEITHLEY	N/A
ELECTRIC BALANCE	SW-30H	CKG2735	CAS	2016-03-23
ELECTRIC BALANCE	KB-500	KB031417	SHENZHEN ACCT	2016-03-23
Digital Thermometer	CS-I02	1211	ACUBA	2016-07-11
Temp. Humidity Data Logger	TES-1367	50504189	TES	2016-07-12
DC Power Suply	E3632A	KR75305998	HP	N/A
Power Meter	EPM-441A	GB32481702	HP	2016-03-22
Power Meter	E4419B	MY41291999	AGILENT	2016-07-08
Power Sensor	8481A	3318A94972	HP	2016-12-30
Power Sensor	E9301A	MY41497729	AGILENT	2016-07-08
Power Sensor	E9301A	MY41497869	AGILENT	2016-07-08
3~6G Power Amp.	SMA027	1	KTM	2016-09-12
Radio Communication Tester	CMU200	106243	ROHDE&SCHWARZ	2016-03-21
VECTOR SIGNAL GENERATOR	SMBV100A	255081	ROHDE&SCHWARZ	2016-03-21
Wideband Radio Communication Tester	CMW 500	122216	ROHDE&SCHWARZ	2016-03-22
NETWORK ANALYZER	8753E	US38433174	AGILENT	2016-02-17
Type N Calibration Kit	85032 B	KTM 85032B-070212	AGILENT	N/A



## Annex B. EUT and Test Setup Photographs



EUT Front view



EUT Back view



**EUT Bottom view**



**EUT Side view**

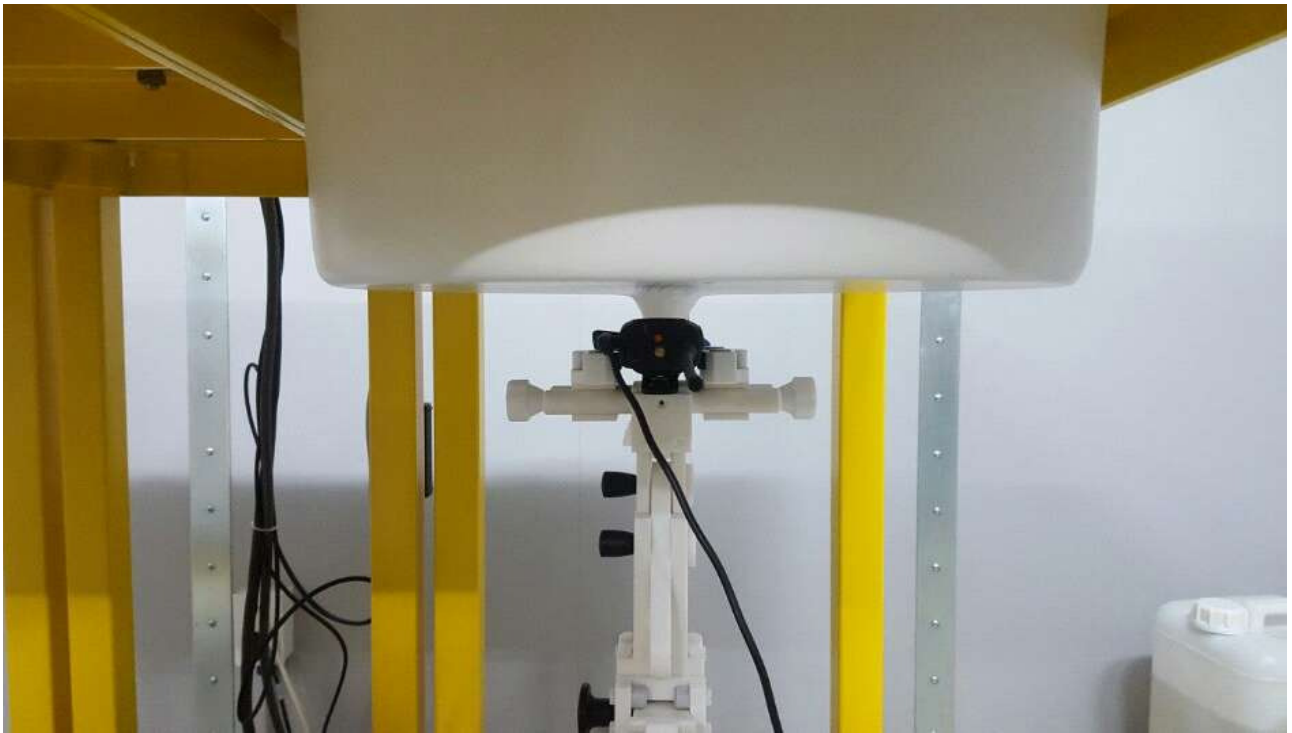

**Front of Device 25 mm from Phantom Top view**



**Front of Device 25 mm from Phantom Side view**

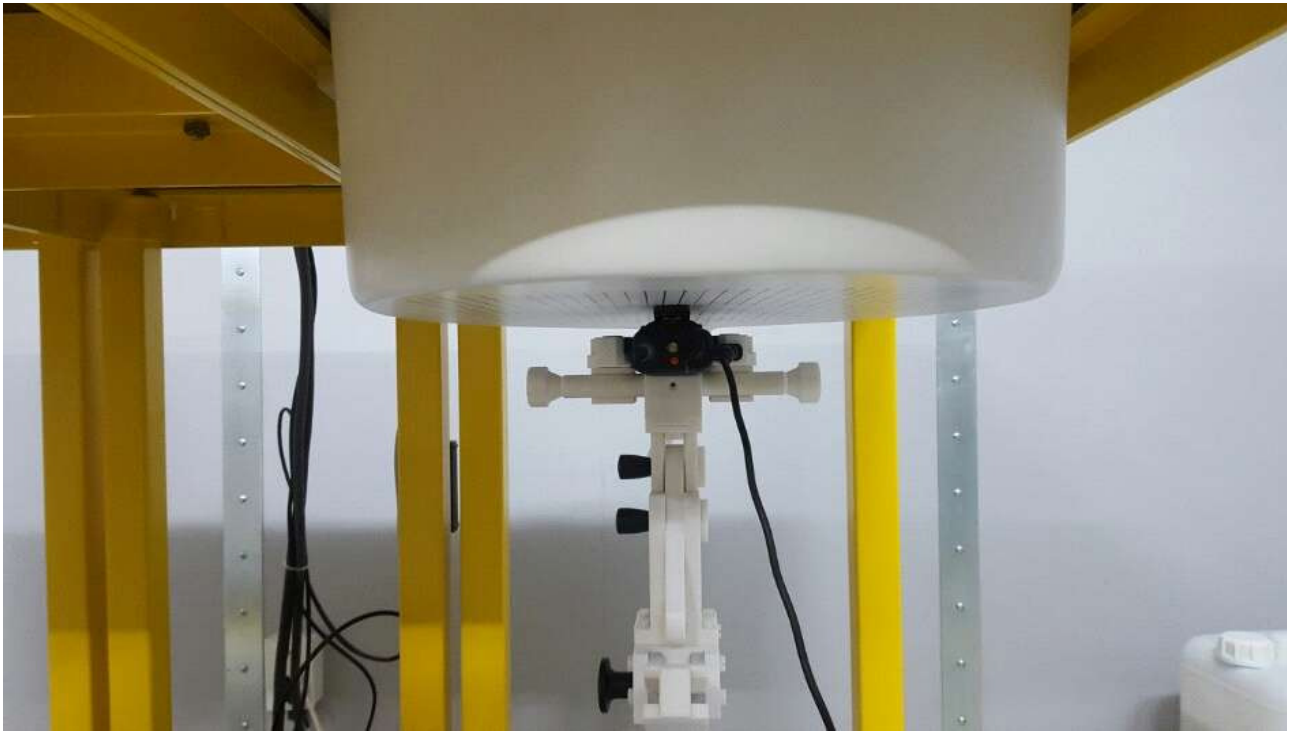

**Body-Worn Back of Device 0 mm from Phantom Top view**



**Body-Worn Back of Device 0 mm from Phantom Side view**



# Annex C. Calibration Reports



## COMOSAR E-Field Probe Calibration Report

Ref : ACR.221.13.16.SATU.A

**LTA CO.,LTD.**  
**243 JUBUG-RI, YANGJI-MYEON, CHEOIN-GU**  
**YONGIN-CITY, KOREA**  
**MVG COMOSAR DOSIMETRIC E-FIELD PROBE**  
**SERIAL NO.: SN 27/14 EPG226**

**Calibrated at MVG US**  
**2105 Barrett Park Dr. - Kennesaw, GA 30144**

The IAC-MRA logo is a circular emblem with the text 'IAC-MRA' in the center and 'INTERNATIONAL ACCREDITED' around the perimeter. The ILA logo consists of a stylized blue 'ILA' with the word 'ACCREDITED' in a red box below it, and 'CALIBRATION CERT. 81204-02' in smaller text underneath.

**Calibration Date: 08/08/2016**

*Summary:*  
This document presents the method and results from an accredited COMOSAR Dosimetric E-Field Probe calibration performed in MVG USA using the CALISAR / CALIBAIR test bench, for use with a COMOSAR system only. All calibration results are traceable to national metrology institutions.



COMOSAR E-FIELD PROBE CALIBRATION REPORT

Ref: ACR.221.13.16.SATU.A

	<i>Name</i>	<i>Function</i>	<i>Date</i>	<i>Signature</i>
<i>Prepared by :</i>	Jérôme LUC	Product Manager	8/8/2016	<i>JS</i>
<i>Checked by :</i>	Jérôme LUC	Product Manager	8/8/2016	<i>JS</i>
<i>Approved by :</i>	Kim RUTKOWSKI	Quality Manager	8/8/2016	<i>Kim Rutkowski</i>

	<i>Customer Name</i>
<i>Distribution :</i>	LTA CO.,LTD.

<i>Issue</i>	<i>Date</i>	<i>Modifications</i>
A	8/8/2016	Initial release

*This document shall not be reproduced, except in full or in part, without the written approval of MVG.  
The information contained herein is to be used only for the purpose for which it is submitted and is not to be released in whole or part without written approval of MVG.*



## TABLE OF CONTENTS

1	Device Under Test .....	4
2	Product Description .....	4
2.1	General Information .....	4
3	Measurement Method .....	4
3.1	Linearity .....	4
3.2	Sensitivity .....	5
3.3	Lower Detection Limit .....	5
3.4	Isotropy .....	5
3.5	Boundary Effect .....	5
4	Measurement Uncertainty .....	5
5	Calibration Measurement Results .....	6
5.1	Sensitivity in air .....	6
5.2	Linearity .....	7
5.3	Sensitivity in liquid .....	7
5.4	Isotropy .....	8
6	List of Equipment .....	10

Page: 3/10

*This document shall not be reproduced, except in full or in part, without the written approval of MVG.  
The information contained herein is to be used only for the purpose for which it is submitted and is not to be released in whole or part without written approval of MVG.*



## 1 DEVICE UNDER TEST

Device Under Test	
Device Type	COMOSAR DOSIMETRIC E FIELD PROBE
Manufacturer	MVG
Model	SSE2
Serial Number	SN 27/14 EPG226
Product Condition (new / used)	Used
Frequency Range of Probe	0.15 GHz-6GHz
Resistance of Three Dipoles at Connector	Dipole 1: R1=0.186 MΩ Dipole 2: R2=0.208 MΩ Dipole 3: R3=0.197 MΩ

A yearly calibration interval is recommended.

## 2 PRODUCT DESCRIPTION

### 2.1 GENERAL INFORMATION

MVG's COMOSAR E field Probes are built in accordance to the IEEE 1528, OET 65 Bulletin C and CEI/IEC 62209 standards.



Figure 1 – MVG COMOSAR Dosimetric E field Dipole

Probe Length	330 mm
Length of Individual Dipoles	2 mm
Maximum external diameter	8 mm
Probe Tip External Diameter	2.5 mm
Distance between dipoles / probe extremity	1 mm

## 3 MEASUREMENT METHOD

The IEEE 1528, OET 65 Bulletin C, CENELEC EN50361 and CEI/IEC 62209 standards provide recommended practices for the probe calibrations, including the performance characteristics of interest and methods by which to assess their affect. All calibrations / measurements performed meet the fore mentioned standards.

### 3.1 LINEARITY

The evaluation of the linearity was done in free space using the waveguide, performing a power sweep to cover the SAR range 0.01W/kg to 100W/kg.

Page: 4/10

*This document shall not be reproduced, except in full or in part, without the written approval of MVG.  
The information contained herein is to be used only for the purpose for which it is submitted and is not to be released in whole or part without written approval of MVG.*





### 3.2 SENSITIVITY

The sensitivity factors of the three dipoles were determined using a two step calibration method (air and tissue simulating liquid) using waveguides as outlined in the standards.

### 3.3 LOWER DETECTION LIMIT

The lower detection limit was assessed using the same measurement set up as used for the linearity measurement. The required lower detection limit is 10 mW/kg.

### 3.4 ISOTROPY

The axial isotropy was evaluated by exposing the probe to a reference wave from a standard dipole with the dipole mounted under the flat phantom in the test configuration suggested for system validations and checks. The probe was rotated along its main axis from 0 - 360 degrees in 15 degree steps. The hemispherical isotropy is determined by inserting the probe in a thin plastic box filled with tissue-equivalent liquid, with the plastic box illuminated with the fields from a half wave dipole. The dipole is rotated about its axis (0°–180°) in 15° increments. At each step the probe is rotated about its axis (0°–360°).

### 3.5 BOUNDARY EFFECT

The boundary effect is defined as the deviation between the SAR measured data and the expected exponential decay in the liquid when the probe is oriented normal to the interface. To evaluate this effect, the liquid filled flat phantom is exposed to fields from either a reference dipole or waveguide. With the probe normal to the phantom surface, the peak spatial average SAR is measured and compared to the analytical value at the surface.

## 4 MEASUREMENT UNCERTAINTY

The guidelines outlined in the IEEE 1528, OET 65 Bulletin C, CENELEC EN50361 and CEI/IEC 62209 standards were followed to generate the measurement uncertainty associated with an E-field probe calibration using the waveguide technique. All uncertainties listed below represent an expanded uncertainty expressed at approximately the 95% confidence level using a coverage factor of k=2, traceable to the Internationally Accepted Guides to Measurement Uncertainty.

Uncertainty analysis of the probe calibration in waveguide					
ERROR SOURCES	Uncertainty value (%)	Probability Distribution	Divisor	ci	Standard Uncertainty (%)
Incident or forward power	3.00%	Rectangular	$\sqrt{3}$	1	1.732%
Reflected power	3.00%	Rectangular	$\sqrt{3}$		1.732%
Liquid conductivity	5.00%	Rectangular	$\sqrt{3}$		2.887%
Liquid permittivity	4.00%	Rectangular	$\sqrt{3}$		2.309%
Field homogeneity	3.00%	Rectangular	$\sqrt{3}$		1.732%
Field probe positioning	5.00%	Rectangular	$\sqrt{3}$		2.887%

Page: 5/10

*This document shall not be reproduced, except in full or in part, without the written approval of MVG.  
The information contained herein is to be used only for the purpose for which it is submitted and is not to be released in whole or part without written approval of MVG.*



Field probe linearity	3.00%	Rectangular	$\sqrt{3}$	1	1.732%
<b>Combined standard uncertainty</b>					5.831%
<b>Expanded uncertainty</b> 95 % confidence level k = 2					12.0%

5 CALIBRATION MEASUREMENT RESULTS

Calibration Parameters	
Liquid Temperature	21 °C
Lab Temperature	21 °C
Lab Humidity	45 %

5.1 SENSITIVITY IN AIR

Normx dipole 1 ( $\mu\text{V}/(\text{V}/\text{m})^2$ )	Normy dipole 2 ( $\mu\text{V}/(\text{V}/\text{m})^2$ )	Normz dipole 3 ( $\mu\text{V}/(\text{V}/\text{m})^2$ )
0.71	0.65	0.58

DCP dipole 1 (mV)	DCP dipole 2 (mV)	DCP dipole 3 (mV)
92	90	90

Calibration curves  $e_i=f(V)$  ( $i=1,2,3$ ) allow to obtain H-field value using the formula:

$$E = \sqrt{E_1^2 + E_2^2 + E_3^2}$$

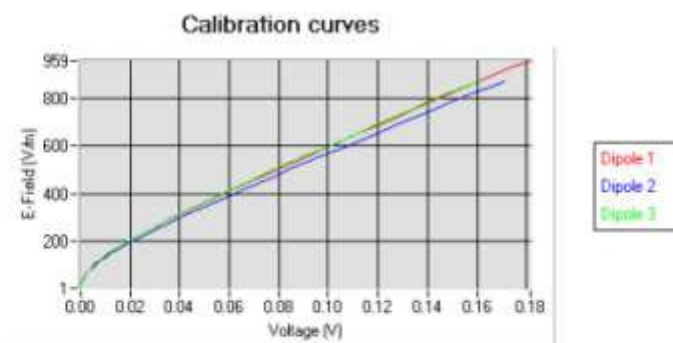



## 5.2 LINEARITY

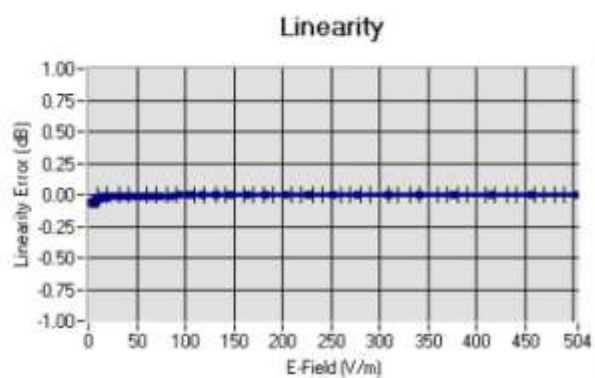

Linearity:  $\pm 1.79\%$  ( $\pm 0.08\text{dB}$ )

## 5.3 SENSITIVITY IN LIQUID

Liquid	Frequency (MHz +/- 100MHz)	Permittivity	Epsilon (S/m)	ConvF
HL150	150	54.12	0.76	20.79
BL150	150	62.52	0.83	21.62
HL300	300	45.04	0.83	17.89
BL300	300	59.07	0.96	18.25
HL450	450	42.17	0.86	19.27
BL450	450	57.65	0.95	20.01
HL850	835	42.19	0.90	16.02
BL850	835	54.67	1.01	16.59
HL1800	1800	41.68	1.46	16.32
BL1800	1800	53.86	1.46	16.68
HL2000	2000	38.26	1.38	17.12
BL2000	2000	52.70	1.51	17.61
HL2450	2450	37.50	1.80	17.66
BL2450	2450	53.22	1.89	18.35
HL5200	5200	35.64	4.67	14.84
BL5200	5200	48.64	5.51	15.20
HL5400	5400	36.44	4.87	15.94
BL5400	5400	46.52	5.77	16.48
HL5600	5600	36.66	5.17	16.13
BL5600	5600	46.79	5.77	16.69
HL5800	5800	35.31	5.31	14.95
BL5800	5800	47.04	6.10	15.37

LOWER DETECTION LIMIT: 8mW/kg

Page: 7/10

*This document shall not be reproduced, except in full or in part, without the written approval of MVG.  
The information contained herein is to be used only for the purpose for which it is submitted and is not to be released in whole or part without written approval of MVG.*



5.4 ISOTROPY

**HL850 MHz**

- Axial isotropy: 0.04 dB
- Hemispherical isotropy: 0.05 dB

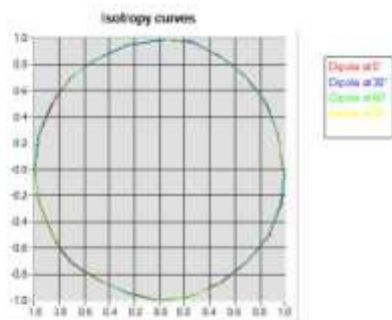

**HL1800 MHz**

- Axial isotropy: 0.04 dB
- Hemispherical isotropy: 0.07 dB

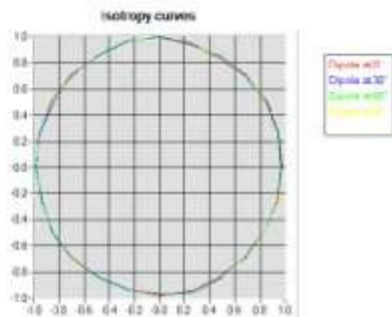



**HL5600 MHz**

- Axial isotropy: 0.06 dB
- Hemispherical isotropy: 0.09 dB

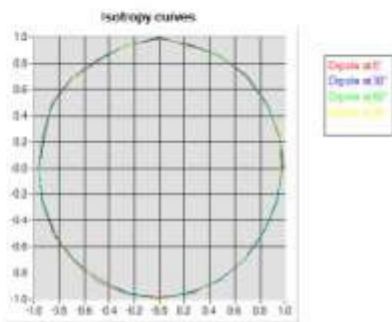



## 6 LIST OF EQUIPMENT

Equipment Summary Sheet				
Equipment Description	Manufacturer / Model	Identification No.	Current Calibration Date	Next Calibration Date
Flat Phantom	MVG	SN-20/09-SAM71	Validated. No cal required.	Validated. No cal required.
COMOSAR Test Bench	Version 3	NA	Validated. No cal required.	Validated. No cal required.
Network Analyzer	Rhode & Schwarz ZVA	SN100132	02/2016	02/2019
Reference Probe	MVG	EP 94 SN 37/08	10/2015	10/2016
Multimeter	Keithley 2000	1188656	12/2013	12/2016
Signal Generator	Agilent E4438C	MY49070581	12/2013	12/2016
Amplifier	Aethercomm	SN 046	Characterized prior to test. No cal required.	Characterized prior to test. No cal required.
Power Meter	HP E4418A	US38261498	12/2013	12/2016
Power Sensor	HP ECP-E26A	US37181460	12/2013	12/2016
Directional Coupler	Narda 4216-20	01386	Characterized prior to test. No cal required.	Characterized prior to test. No cal required.
Waveguide	Mega Industries	069Y7-158-13-712	Validated. No cal required.	Validated. No cal required.
Waveguide Transition	Mega Industries	069Y7-158-13-701	Validated. No cal required.	Validated. No cal required.
Waveguide Termination	Mega Industries	069Y7-158-13-701	Validated. No cal required.	Validated. No cal required.
Temperature / Humidity Sensor	Control Company	150798832	10/2015	10/2017

Page: 10/10

*This document shall not be reproduced, except in full or in part, without the written approval of MVG.  
The information contained herein is to be used only for the purpose for which it is submitted and is not to be released in whole or part without written approval of MVG.*





## 8 LIST OF EQUIPMENT

Equipment Summary Sheet				
Equipment Description	Manufacturer / Model	Identification No.	Current Calibration Date	Next Calibration Date
SAM Phantom	MVG	SN-20/09-SAM71	Validated. No cal required.	Validated. No cal required.
COMOSAR Test Bench	Version 3	NA	Validated. No cal required.	Validated. No cal required.
Network Analyzer	Rhode & Schwarz ZVA	SN100132	02/2016	02/2019
Calipers	Carrera	CALIPER-01	12/2013	12/2016
Reference Probe	MVG	EPG122 SN 18/11	10/2015	10/2016
Multimeter	Keithley 2000	1188656	12/2013	12/2016
Signal Generator	Agilent E4438C	MY49070581	12/2013	12/2016
Amplifier	Aethercomm	SN 046	Characterized prior to test. No cal required.	Characterized prior to test. No cal required.
Power Meter	HP E4418A	US38261498	12/2013	12/2016
Power Sensor	HP ECP-E26A	US37181460	12/2013	12/2016
Directional Coupler	Narda 4216-20	01386	Characterized prior to test. No cal required.	Characterized prior to test. No cal required.
Temperature and Humidity Sensor	Control Company	150798832	10/2015	10/2017

Page: 11/11

*This document shall not be reproduced, except in full or in part, without the written approval of MVG. The information contained herein is to be used only for the purpose for which it is submitted and is not to be released in whole or part without written approval of MVG.*



## SAR Reference Dipole Calibration Report

Ref : ACR.62.2.16.SATU.A

**LTA CO.,LTD.**  
**243 JUBUG-RI, YANGJI-MYEON, CHEOIN-GU**  
**YONGIN-CITY, KOREA**  
**MVG COMOSAR REFERENCE DIPOLE**  
**FREQUENCY: 450 MHZ**  
**SERIAL NO.: SN 12/13 DIP0G450-222**

**Calibrated at MVG US**  
**2105 Barrett Park Dr. - Kennesaw, GA 30144**



**Calibration Date: 03/02/2016**

*Summary:*

This document presents the method and results from an accredited SAR reference dipole calibration performed in MVG USA using the COMOSAR test bench. All calibration results are traceable to national metrology institutions.





## SAR REFERENCE DIPOLE CALIBRATION REPORT

Ref: ACR.61.2.16.SATU.A

	<i>Name</i>	<i>Function</i>	<i>Date</i>	<i>Signature</i>
<i>Prepared by :</i>	Jérôme LUC	Product Manager	3/2/2016	<i>JS</i>
<i>Checked by :</i>	Jérôme LUC	Product Manager	3/2/2016	<i>JS</i>
<i>Approved by :</i>	Kim RUTKOWSKI	Quality Manager	3/2/2016	<i>Kim Rutkowski</i>

	<i>Customer Name</i>
<i>Distribution :</i>	LTA CO.,LTD.

<i>Issue</i>	<i>Date</i>	<i>Modifications</i>
A	3/2/2016	Initial release

Page: 2/11

*This document shall not be reproduced, except in full or in part, without the written approval of MVG.  
The information contained herein is to be used only for the purpose for which it is submitted and is not to be released in whole or part without written approval of MVG.*



## TABLE OF CONTENTS

1	Introduction.....	4
2	Device Under Test .....	4
3	Product Description .....	4
3.1	General Information .....	4
4	Measurement Method .....	5
4.1	Return Loss Requirements .....	5
4.2	Mechanical Requirements .....	5
5	Measurement Uncertainty .....	5
5.1	Return Loss .....	5
5.2	Dimension Measurement .....	5
5.3	Validation Measurement .....	5
6	Calibration Measurement Results .....	6
6.1	Return Loss and Impedance In Head Liquid .....	6
6.2	Return Loss and Impedance In Body Liquid .....	6
6.3	Mechanical Dimensions .....	6
7	Validation measurement .....	7
7.1	Head Liquid Measurement .....	7
7.2	SAR Measurement Result With Head Liquid .....	8
7.3	Body Liquid Measurement .....	9
7.4	SAR Measurement Result With Body Liquid .....	10
8	List of Equipment .....	11

Page: 3/11

*This document shall not be reproduced, except in full or in part, without the written approval of MVG.  
The information contained herein is to be used only for the purpose for which it is submitted and is not to be released in whole or part without written approval of MVG.*



## 1 INTRODUCTION

This document contains a summary of the requirements set forth by the IEEE 1528, FCC KDBs and CEI/IEC 62209 standards for reference dipoles used for SAR measurement system validations and the measurements that were performed to verify that the product complies with the fore mentioned standards.

## 2 DEVICE UNDER TEST

Device Under Test	
Device Type	COMOSAR 450 MHz REFERENCE DIPOLE
Manufacturer	MVG
Model	SID450
Serial Number	SN 12/13 DIP0G450-222
Product Condition (new / used)	Used

A yearly calibration interval is recommended.

## 3 PRODUCT DESCRIPTION

### 3.1 GENERAL INFORMATION

MVG's COMOSAR Validation Dipoles are built in accordance to the IEEE 1528, FCC KDBs and CEI/IEC 62209 standards. The product is designed for use with the COMOSAR test bench only.



**Figure 1** – MVG COMOSAR Validation Dipole

Page: 4/11

*This document shall not be reproduced, except in full or in part, without the written approval of MVG. The information contained herein is to be used only for the purpose for which it is submitted and is not to be released in whole or part without written approval of MVG.*



#### 4 MEASUREMENT METHOD

The IEEE 1528, FCC KDBs and CEI/IEC 62209 standards provide requirements for reference dipoles used for system validation measurements. The following measurements were performed to verify that the product complies with the fore mentioned standards.

##### 4.1 RETURN LOSS REQUIREMENTS

The dipole used for SAR system validation measurements and checks must have a return loss of -20 dB or better. The return loss measurement shall be performed against a liquid filled flat phantom, with the phantom constructed as outlined in the fore mentioned standards.

##### 4.2 MECHANICAL REQUIREMENTS

The IEEE Std. 1528 and CEI/IEC 62209 standards specify the mechanical components and dimensions of the validation dipoles, with the dimensions frequency and phantom shell thickness dependent. The COMOSAR test bench employs a 2 mm phantom shell thickness therefore the dipoles sold for use with the COMOSAR test bench comply with the requirements set forth for a 2 mm phantom shell thickness.

#### 5 MEASUREMENT UNCERTAINTY

All uncertainties listed below represent an expanded uncertainty expressed at approximately the 95% confidence level using a coverage factor of  $k=2$ , traceable to the Internationally Accepted Guides to Measurement Uncertainty.

##### 5.1 RETURN LOSS

The following uncertainties apply to the return loss measurement:

Frequency band	Expanded Uncertainty on Return Loss
400-6000MHz	0.1 dB

##### 5.2 DIMENSION MEASUREMENT

The following uncertainties apply to the dimension measurements:

Length (mm)	Expanded Uncertainty on Length
3 - 300	0.05 mm

##### 5.3 VALIDATION MEASUREMENT

The guidelines outlined in the IEEE 1528, FCC KDBs, CENELEC EN50361 and CEI/IEC 62209 standards were followed to generate the measurement uncertainty for validation measurements.

Scan Volume	Expanded Uncertainty
1 g	20.3 %

Page: 5/11

*This document shall not be reproduced, except in full or in part, without the written approval of MVG.  
The information contained herein is to be used only for the purpose for which it is submitted and is not to be released in whole or part without written approval of MVG.*



10 g	20.1 %
------	--------

**6 CALIBRATION MEASUREMENT RESULTS**

**6.1 RETURN LOSS AND IMPEDANCE IN HEAD LIQUID**

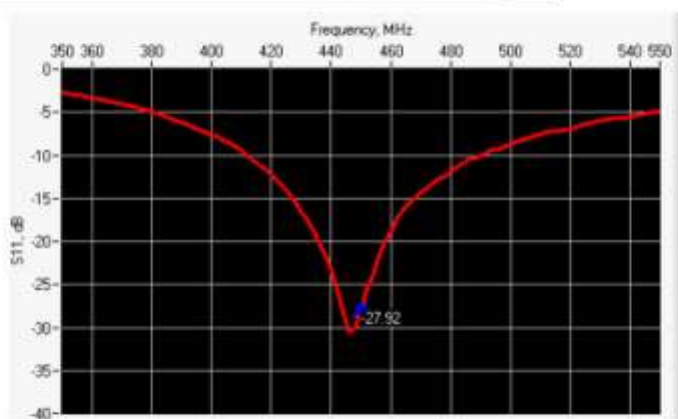

Frequency (MHz)	Return Loss (dB)	Requirement (dB)	Impedance
450	-27.92	-20	47.3 Ω - 2.8 jΩ

**6.2 RETURN LOSS AND IMPEDANCE IN BODY LIQUID**

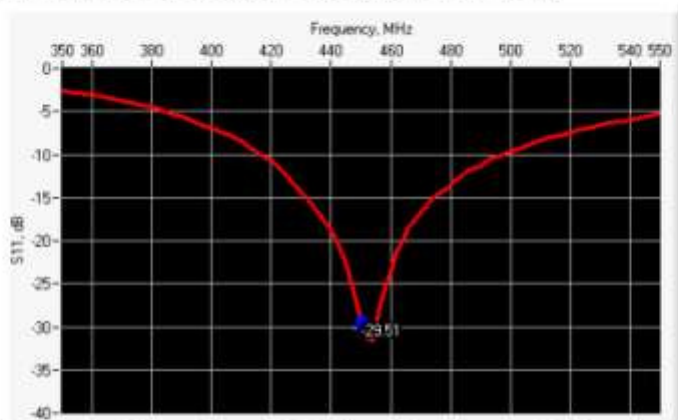

Frequency (MHz)	Return Loss (dB)	Requirement (dB)	Impedance
450	-29.51	-20	47.2 Ω + 1.6 jΩ

**6.3 MECHANICAL DIMENSIONS**

Frequency MHz	L mm		h mm		d mm	
	required	measured	required	measured	required	measured
300	420.0 ±1 %		250.0 ±1 %		6.35 ±1 %	

*This document shall not be reproduced, except in full or in part, without the written approval of MVG. The information contained herein is to be used only for the purpose for which it is submitted and is not to be released in whole or part without written approval of MVG.*





## SAR REFERENCE DIPOLE CALIBRATION REPORT

Ref: ACR.61.2.16.SATU.A

450	290.0 ±1 %	PASS	166.7 ±1 %	PASS	6.35 ±1 %	PASS
750	176.0 ±1 %		100.0 ±1 %		6.35 ±1 %	
835	161.0 ±1 %		89.8 ±1 %		3.6 ±1 %	
900	149.0 ±1 %		83.3 ±1 %		3.6 ±1 %	
1450	89.1 ±1 %		51.7 ±1 %		3.6 ±1 %	
1500	80.5 ±1 %		50.0 ±1 %		3.6 ±1 %	
1640	79.0 ±1 %		45.7 ±1 %		3.6 ±1 %	
1750	75.2 ±1 %		42.9 ±1 %		3.6 ±1 %	
1800	72.0 ±1 %		41.7 ±1 %		3.6 ±1 %	
1900	68.0 ±1 %		39.5 ±1 %		3.6 ±1 %	
1950	66.3 ±1 %		38.5 ±1 %		3.6 ±1 %	
2000	64.5 ±1 %		37.5 ±1 %		3.6 ±1 %	
2100	61.0 ±1 %		35.7 ±1 %		3.6 ±1 %	
2300	55.5 ±1 %		32.6 ±1 %		3.6 ±1 %	
2450	51.5 ±1 %		30.4 ±1 %		3.6 ±1 %	
2600	48.5 ±1 %		28.8 ±1 %		3.6 ±1 %	
3000	41.5 ±1 %		25.0 ±1 %		3.6 ±1 %	
3500	37.0 ±1 %		26.4 ±1 %		3.6 ±1 %	
3700	34.7 ±1 %		26.4 ±1 %		3.6 ±1 %	

## 7 VALIDATION MEASUREMENT

The IEEE Std. 1528, FCC KDBs and CEI/IEC 62209 standards state that the system validation measurements must be performed using a reference dipole meeting the fore mentioned return loss and mechanical dimension requirements. The validation measurement must be performed against a liquid filled flat phantom, with the phantom constructed as outlined in the fore mentioned standards. Per the standards, the dipole shall be positioned below the bottom of the phantom, with the dipole length centered and parallel to the longest dimension of the flat phantom, with the top surface of the dipole at the described distance from the bottom surface of the phantom.

### 7.1 HEAD LIQUID MEASUREMENT

Frequency MHz	Relative permittivity ( $\epsilon_r$ )		Conductivity ( $\sigma$ ) S/m	
	required	measured	required	measured
300	45.3 ±5 %		0.87 ±5 %	
450	43.5 ±5 %	PASS	0.87 ±5 %	PASS
750	41.9 ±5 %		0.89 ±5 %	
835	41.5 ±5 %		0.90 ±5 %	
900	41.5 ±5 %		0.97 ±5 %	
1450	40.5 ±5 %		1.20 ±5 %	
1500	40.4 ±5 %		1.23 ±5 %	
1640	40.2 ±5 %		1.31 ±5 %	
1750	40.1 ±5 %		1.37 ±5 %	

Page: 7/11

*This document shall not be reproduced, except in full or in part, without the written approval of MVG.  
The information contained herein is to be used only for the purpose for which it is submitted and is not to be released in whole or part without written approval of MVG.*



## SAR REFERENCE DIPOLE CALIBRATION REPORT

Ref: ACR.61.2.16.SATU.A

1800	40.0 ±5 %		1.40 ±5 %	
1900	40.0 ±5 %		1.40 ±5 %	
1950	40.0 ±5 %		1.40 ±5 %	
2000	40.0 ±5 %		1.40 ±5 %	
2100	39.8 ±5 %		1.49 ±5 %	
2300	39.5 ±5 %		1.67 ±5 %	
2450	39.2 ±5 %		1.80 ±5 %	
2600	39.0 ±5 %		1.96 ±5 %	
3000	38.5 ±5 %		2.40 ±5 %	
3500	37.9 ±5 %		2.91 ±5 %	

## 7.2 SAR MEASUREMENT RESULT WITH HEAD LIQUID

The IEEE Std. 1528 and CEI/IEC 62209 standards state that the system validation measurements should produce the SAR values shown below (for phantom thickness of 2 mm), within the uncertainty for the system validation. All SAR values are normalized to 1 W forward power. In bracket, the measured SAR is given with the used input power.

Software	OPENSAR V4
Phantom	SN 20/09 SAM71
Probe	SN 18/11 EPG122
Liquid	Head Liquid Values: $\epsilon_p' : 44, \sigma : 0.88$
Distance between dipole center and liquid	15.0 mm
Area scan resolution	$dx=8mm/dy=8mm$
Zoon Scan Resolution	$dx=8mm/dy=8mm/dz=5mm$
Frequency	450 MHz
Input power	20 dBm
Liquid Temperature	21 °C
Lab Temperature	21 °C
Lab Humidity	45 %

Frequency MHz	1 g SAR (W/kg/W)		10 g SAR (W/kg/W)	
	required	measured	required	measured
300	2.85		1.94	
450	4.58	4.68 (0.47)	3.06	2.98 (0.30)
750	8.49		5.55	
835	9.56		6.22	
900	10.9		6.99	
1450	29		16	
1500	30.5		16.8	
1640	34.2		18.4	
1750	36.4		19.3	
1800	38.4		20.1	

Page: 8/11

*This document shall not be reproduced, except in full or in part, without the written approval of MVG.  
The information contained herein is to be used only for the purpose for which it is submitted and is not to be released in whole or part without written approval of MVG.*



SAR REFERENCE DIPOLE CALIBRATION REPORT

Ref: ACR.61.2.16.SATU.A

1900	39.7		20.5	
1950	40.5		20.9	
2000	41.1		21.1	
2100	43.6		21.9	
2300	48.7		23.3	
2450	52.4		24	
2600	55.3		24.6	
3000	63.8		25.7	
3500	67.1		25	

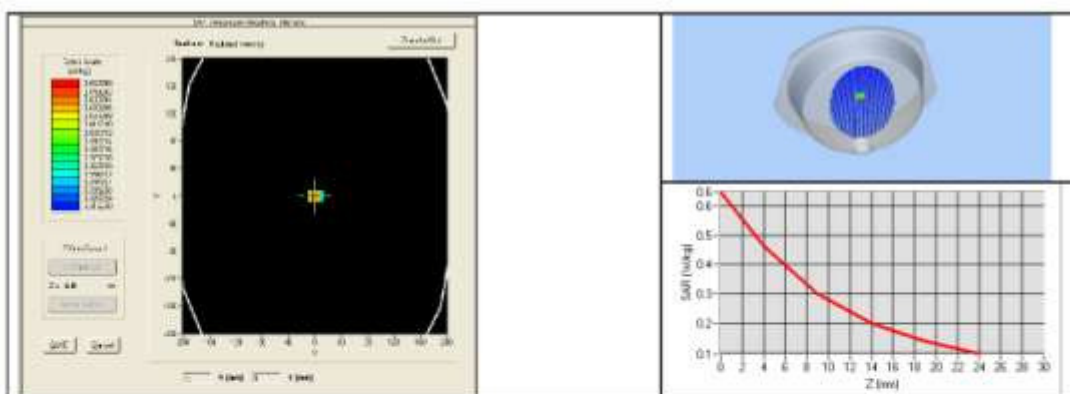

7.3 BODY LIQUID MEASUREMENT

Frequency MHz	Relative permittivity ( $\epsilon_r$ )		Conductivity ( $\sigma$ ) S/m	
	required	measured	required	measured
150	61.9 ±5 %		0.80 ±5 %	
300	58.2 ±5 %		0.92 ±5 %	
450	56.7 ±5 %	PASS	0.94 ±5 %	PASS
750	55.5 ±5 %		0.96 ±5 %	
835	55.2 ±5 %		0.97 ±5 %	
900	55.0 ±5 %		1.05 ±5 %	
915	55.0 ±5 %		1.06 ±5 %	
1450	54.0 ±5 %		1.30 ±5 %	
1610	53.8 ±5 %		1.40 ±5 %	
1800	53.3 ±5 %		1.52 ±5 %	
1900	53.3 ±5 %		1.52 ±5 %	
2000	53.3 ±5 %		1.52 ±5 %	
2100	53.2 ±5 %		1.62 ±5 %	
2450	52.7 ±5 %		1.95 ±5 %	

Page: 9/11

*This document shall not be reproduced, except in full or in part, without the written approval of MVG. The information contained herein is to be used only for the purpose for which it is submitted and is not to be released in whole or part without written approval of MVG.*





SAR REFERENCE DIPOLE CALIBRATION REPORT

Ref: ACR.61.2.16.SATU.A

2600	52.5 ±5 %		2.16 ±5 %	
3000	52.0 ±5 %		2.73 ±5 %	
3500	51.3 ±5 %		3.31 ±5 %	
5200	49.0 ±10 %		5.30 ±10 %	
5300	48.9 ±10 %		5.42 ±10 %	
5400	48.7 ±10 %		5.53 ±10 %	
5500	48.6 ±10 %		5.65 ±10 %	
5600	48.5 ±10 %		5.77 ±10 %	
5800	48.2 ±10 %		6.00 ±10 %	

7.4 SAR MEASUREMENT RESULT WITH BODY LIQUID

Software	OPENSAR V4
Phantom	SN 20/09 SAM71
Probe	SN 18/11 EPG122
Liquid	Body Liquid Values: $\epsilon_p$ : 58.9 $\sigma$ : 1.00
Distance between dipole center and liquid	15.0 mm
Area scan resolution	dx=8mm/dy=8mm
Zoon Scan Resolution	dx=8mm/dy=8mm/dz=5mm
Frequency	450 MHz
Input power	20 dBm
Liquid Temperature	21 °C
Lab Temperature	21 °C
Lab Humidity	45 %

Frequency MHz	1 g SAR (W/kg/W)	10 g SAR (W/kg/W)
	measured	measured
450	4.85 (0.49)	3.06 (0.31)

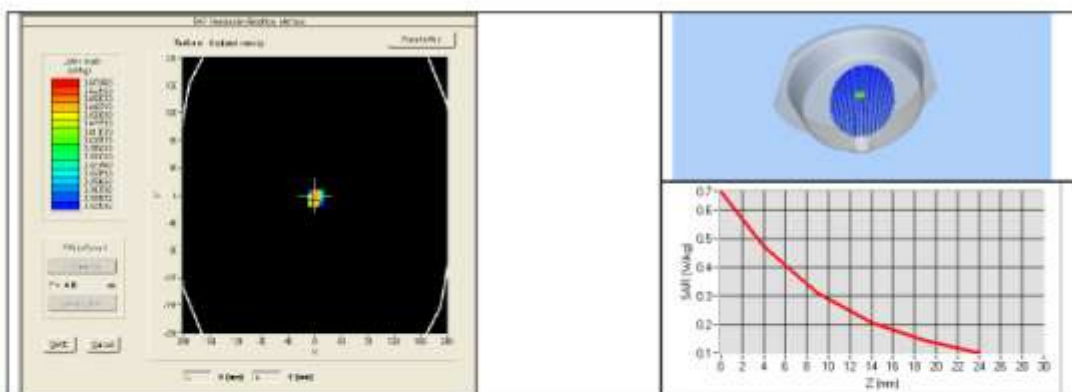

This document shall not be reproduced, except in full or in part, without the written approval of MVG. The information contained herein is to be used only for the purpose for which it is submitted and is not to be released in whole or part without written approval of MVG.



## 8 LIST OF EQUIPMENT

Equipment Summary Sheet				
Equipment Description	Manufacturer / Model	Identification No.	Current Calibration Date	Next Calibration Date
SAM Phantom	MVG	SN-20/09-SAM71	Validated. No cal required.	Validated. No cal required.
COMOSAR Test Bench	Version 3	NA	Validated. No cal required.	Validated. No cal required.
Network Analyzer	Rhode & Schwarz ZVA	SN100132	02/2016	02/2019
Calipers	Carrera	CALIPER-01	12/2013	12/2016
Reference Probe	MVG	EPG122 SN 18/11	10/2015	10/2016
Multimeter	Keithley 2000	1188656	12/2013	12/2016
Signal Generator	Agilent E4438C	MY49070581	12/2013	12/2016
Amplifier	Aethercomm	SN 046	Characterized prior to test. No cal required.	Characterized prior to test. No cal required.
Power Meter	HP E4418A	US38261498	12/2013	12/2016
Power Sensor	HP ECP-E26A	US37181460	12/2013	12/2016
Directional Coupler	Narda 4216-20	01386	Characterized prior to test. No cal required.	Characterized prior to test. No cal required.
Temperature and Humidity Sensor	Control Company	150798832	10/2015	10/2017

Page: 11/11

*This document shall not be reproduced, except in full or in part, without the written approval of MVG. The information contained herein is to be used only for the purpose for which it is submitted and is not to be released in whole or part without written approval of MVG.*