



FCC Report

Application Purpose : Original grant

Applicant Name: : Yeonhwa M Tech Co.,Ltd

FCC ID : VSODX-8400

Equipment Type : DMR(Digital Mobile Radio)

Model Name : DX-8400, DX-8500, TPD-8454, TPD-8455, CP395

Report Number : FCC18010010A-1

Standard(S) : FCC Part 90

Date Of Receipt : March 26, 2018

Date Of Issue : April 08, 2018

Test By :
(Grace Wen)

Reviewed By :
(Tom Li)

Authorized by :
(Wang Fengbing)

Prepared by :

World Standardization Certification & Testing Group Co., Ltd.

Building A-B, Baoshi Science & Technology Park, Baoshi Road, Bao'an District, Shenzhen, Guangdong, China

Note: The results contained in this report pertain only to the tested sample. This report shall not be reproduced, except in full, without written approval of World Standardization Certification & Testing Group Co.,Ltd. This report must not be used by the client to claim product certification, approval, or endorsement by NVLAP, NIST, or any agency of the U.S. Government.





For Question,
Please Contact with WSCT
www.wsct-cert.com

REPORT REVISE RECORD

Report Version	Revise Time	Issued Date	Valid Version	Notes
V1.0	/	April 08, 2018	Valid	Original Report





1. TEST STANDARDS

The tests were performed according to following standards:

[FCC Rules Part 90: 2017](#) Personal Radio Services

[TIA/EIA 603 D: June 2010](#) Land Mobile FM or PM Communications Equipment Measurement and Performance Standards.

[FCC Part 2: 2016](#) Frequency allocations and radio treaty matters, general rules and regulations.





2. GENERAL INFORMATION

Test Model	DX-8400
Applicant	Yeonhwa M Tech Co.,Ltd
Address	36, Jeonpa-ro, 44beon-gil, Manan-gu, Anyang-si, Gyeonggi-do, korea 14086
Manufacturer	Yeonhwa M Tech Co.,Ltd
Address	36, Jeonpa-ro, 44beon-gil, Manan-gu, Anyang-si, Gyeonggi-do, korea 14086
Equipment Type	DMR(Digital Mobile Radio)
Brand Name	
Hardware version:	SCT40-R2
Software version:	V1.0
Extreme Temp. Tolerance	-10°C~+55°C
EUT Power Rating	DC 7.40 V by battery
Operating Frequency	406.1 MHz to 470MHz
Channel Spacing	12.5 KHz
Modulation Type	FM, 4FSK
Antenna Type:	Detachable Antenna
Antenna gain:	0.0 dBi
Data of receipt	March 26, 2018
Date of test	March 26, 2017 to May 08, 2018
Deviation	None
Condition of Test Sample	Normal





2.1. EUT operation mode

Modulation	Channel separation	Frequency (MHz)	Operation Description
FM	12.5 KHz	406.1500	Op1
	12.5 KHz	435.0000	Op2
	12.5 KHz	469.9500	Op3
4FSK	12.5 KHz	406.1500	Op4
	12.5 KHz	435.0000	Op5
	12.5 KHz	469.9500	Op6

2.2. Block Diagram of Test Setup

Fig. 2-1 Configuration of Tested System

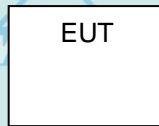

2.3. Related Submittal(s) / Grant (s)

This submittal(s) (test report) is intended for **FCC ID:VSODX-8400** filing to comply with FCC Part 2, FCC Part 90 of the FCC CFR 47 Rules.





3. TEST ENVIRONMENT

3.1. Address of the test laboratory

World Standardization Certification & Testing Group Co., Ltd.
Building A, Baoshi Science & Technology Park, Baoshi Road, Bao'an District, Shenzhen,
Guangdong, China

The sites are constructed in conformance with the requirements of ANSI C63.7, ANSI C63.4 (2003) and CISPR Publication 22.

3.2. Test Facility

Designation Number: CN5030
Test Firm Registration Number: 366353

3.3. Environmental conditions

During the measurement the environmental conditions were within the listed ranges:

Temperature:	15-35 ° C
Humidity:	30-60 %
Atmospheric pressure:	950-1050mbar

3.4. Test Description

Test Specification clause	Test case	Pass	Fail	NA	NP	Remark
§90.205 §2.1046(a)	RF Power Output	<input checked="" type="checkbox"/>	<input type="checkbox"/>	<input type="checkbox"/>	<input type="checkbox"/>	Pass
§90.205 §2.1046(a)	RF Power Output(Conducted Method)	<input checked="" type="checkbox"/>	<input type="checkbox"/>	<input type="checkbox"/>	<input type="checkbox"/>	Pass
§90.242(b)(8) §90.210 §2.1047	Modulation Characteristic	<input checked="" type="checkbox"/>	<input type="checkbox"/>	<input type="checkbox"/>	<input type="checkbox"/>	Pass
§90.209 §2.1049	99% Occupied Bandwidth	<input checked="" type="checkbox"/>	<input type="checkbox"/>	<input type="checkbox"/>	<input type="checkbox"/>	Pass
§90.210 §2.1049	Emission Mask	<input checked="" type="checkbox"/>	<input type="checkbox"/>	<input type="checkbox"/>	<input type="checkbox"/>	Pass
§90.213 §2.1055	Frequency Stability	<input checked="" type="checkbox"/>	<input type="checkbox"/>	<input type="checkbox"/>	<input type="checkbox"/>	Pass
§2.1051 §2.1053 §90.210	TX spurious emissions	<input checked="" type="checkbox"/>	<input type="checkbox"/>	<input type="checkbox"/>	<input type="checkbox"/>	Pass
§90.214	Transient frequency behavior	<input checked="" type="checkbox"/>	<input type="checkbox"/>	<input type="checkbox"/>	<input type="checkbox"/>	Pass

Note:

1. NA = Not Applicable; NP = Not Performed;





3.5. Statement of the measurement uncertainty

The data and results referenced in this document are true and accurate. The reader is cautioned that there may be errors within the calibration limits of the equipment and facilities. The measurement uncertainty was calculated for all measurements listed in this test report acc. To CISPR 16 – 4 „Specification for radio disturbance and immunity measuring apparatus and methods – Part 4: Uncertainty in EMC Measurements“ and is documented in the QTC Certification & Testing Co., Ltd. quality system acc. To DIN EN ISO/IEC 17025. Furthermore, component and process variability of devices similar to that tested may result in additional deviation. The manufacturer has the sole responsibility of continued compliance of the device.

Hereafter the best measurement capability for QTC Certification & Testing Co., Ltd. laboratory is reported:

Test	Range	Measurement Uncertainty	Notes
Radiated Emission	30~1000MHz	3.16 dB	(1)
Radiated Emission	1~18GHz	3.56 dB	(1)
Conducted Disturbance	0.15~30MHz	2.44 dB	(1)

- (1) This uncertainty represents an expanded uncertainty expressed at approximately the 95% confidence level using a coverage factor of k=2.

3.6. Equipments Used during the Test

Field Strength Spurious Emissions						
Item	Test Equipment	Manufacturer	Model No.	Serial No.	Last Cal.	Cal. Interval
1	Ultra-Broadband Antenna	ShwarzBeck	VULB9163	462	2017/04/11	3 years
2	EMI TEST Receiver	Rohde&Schwarz	ESU8	100316	2016/10/25	1 years
3	EMI TEST Software	Audix	E3	6.111111	N/A	N/A
4	Horn Antenna	EMCO	3116	00060095	2017/04/11	3 years
5	Pre-Amplifier	Rohde&Schwarz	SCU-01	10049	2016/10/25	1 years
6	Pre-Amplifier	A.H.	PAM0-0118	360	2016/10/25	1 years
7	Pre-Amplifier	A.H.	PAM-1840VH	562	2016/10/25	1 years
8	Double Ridged Horn Antenna	Rohde&Schwarz	HF907	100265	2017/04/11	3 years
9	Active Loop Antenna	Schwarz beck	FMZB1519	0.38	2017/04/11	3 years
11	TURNTABLE	MATURO	TT2.0	----	N/A	N/A
12	ANTENNA MAST	MATURO	TAM-4.0-P	----	N/A	N/A
13	Spectrum Analyzer	R&S	FSU26	1166.1660.26	2017/10/25	1 years
14	RF Communication TEST SET	HP	8920A	3813A10502	2017/10/25	1 years

Modulation Characteristics						
Item	Test Equipment	Manufacturer	Model No.	Serial No.	Last Cal.	Cal. Interval
1	RF Communication TEST SET	HP	8920A	3813A10502	2017/10/25	1 years

RF Power Output&Occupied Bandwidth&Antenna Conducted Emissions& Transient Frequency Behavior						
Item	Test Equipment	Manufacturer	Model No.	Serial No.	Last Cal.	Cal. Interval
1	RF Communication TEST SET	HP	8920A	3813A10502	2017/10/25	1 years
2	Signal Spectrum Analyzer	R&S	FSU26	101961	2017/10/25	1 years
3	Attenuator	R&S	ESH3-22	100449	2017/10/25	1 years
4	Power Meter	Agilent	E4417A	GB41292254	2017/10/25	1 years
5	Modulation Analyzer	HP	8901A	2976553	2017/10/25	1 years



4. TEST CONDITIONS AND RESULTS

4.1. RF Power Output(Conducted Method)

TEST CONFIGURATION



TEST PROCEDURE

- 1) Connect the equipmet as illuastrated.
- 2) Set EUT working in continuous mode in low,middle,high frequency,read and record the peak power value.

TEST RESULTS

Modulation	Channel Separation	Test Frequency (MHz)	Reading(dBm)	
			High Power Level	Low Power Level
FM	12.5KHz	406.1500	35.97	29.95
		435.0000	36.01	29.82
		469.9500	35.95	29.91
4FSK	12.5KHz	406.1500	35.95	29.96
		435.0000	36.02	29.87
		469.9500	35.98	29.92
Rated Power			5W(36.99dBm)	1W(30dBm)
Result Power			Pass	Pass

The rated 5W for High Power and 1W for Low power.





4.2. Modulation Characteristics

TEST CONFIGURATION

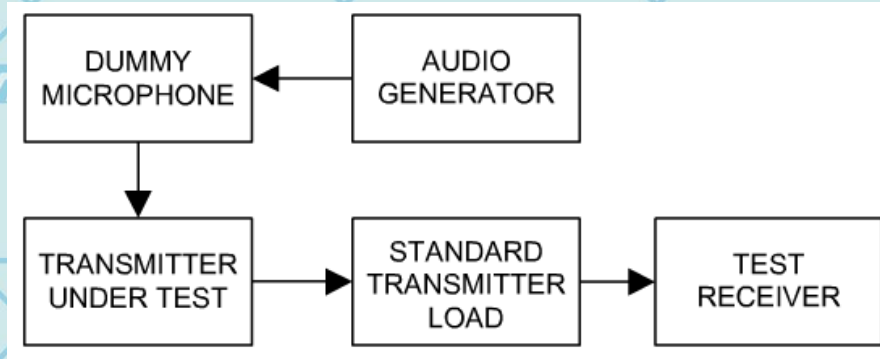

Figure 1: Modulation Limit & Audio Frequency Response

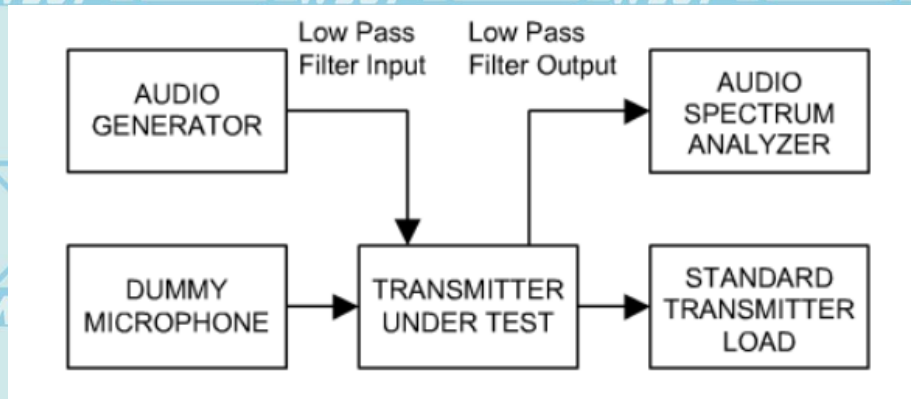

Figure 2: Audio Low Pass Filter Response

TEST PROCEDURE

Modulation limitations

- 1 Configure the EUT as shown in figure 1, adjust the audio input for 60% of rated system deviation at 1 KHz using this level as a reference (0dB) and vary the input level from -20 to +20dB. Record the frequency deviation obtained as a function of the input level.
- 2 Repeat step 1 with input frequency changing to 300 Hz, 500 Hz, 1000 Hz, 1500 Hz, 2500Hz and 3000 Hz in sequence.
- 3 Recorded the frequency deviation.

Modulation Frequency Response

- 1 Configure the EUT as shown in figure 1.
- 2 Set the audio signal generator frequency to the sound pressure level at the microphone of the EUT.
- 3 The frequency of the audio signal generator is changed from 100Hz to 5 KHz.
- 4 Recorded the frequency deviation.
- 5 Calculate the audio frequency response at each frequency as:
 $Response = 20 \log_{10} (DEV_{FREQ} / DEV_{REF})$
 $DEV_{FREQ} = \text{Frequency Deviation at } 100 - 5000\text{Hz}$
 $DEV_{REF} = \text{Frequency Deviation at } 1000\text{ Hz}$

Audio Frequency Response

- 6 Configure the EUT as shown in figure 1.
- 7 Adjust the audio input for rated system deviation at 1 KHz using this level as a reference (0dB).
- 8 Vary the Audio frequency from 1 KHz to 100 KHz and record the frequency deviation.





Audio Frequency Response = $20\log_{10}$ (Deviation of test frequency / Deviation of 1 KHz reference).

LIMIT
Modulation limitations & Modulation Frequency Response

According to CFR47 section §90.20(33), For FM transmitters, the sum of the highest modulating frequency in Hertz and the amount of the frequency deviation or swing in Hertz may not exceed 2800 Hz and the maximum deviation may not exceed 2.5 kHz.

Audio Frequency Response

According to CFR47 section §90.242(b)(8):

Audio band	Minimum Attenuation Rel. to 1KHz Attenuation
5-20KHz	$83 \log_{10} (f/5)$ decibels
20-30KHz	50dB

TEST RESULTS





4.2.1.1 Modulation Characteristics

406.1500MHz @ 12.5 KHz Channel Separation									
Modulation Input(dBC)	Peak Frequency Deviation (KHz)							Limit(KHz)	Result
	300Hz	500Hz	1KHz	1.5KHz	2KHz	2.5KHz	3KHz		
-20	0.38	0.41	0.41	0.46	0.57	0.53	0.64	2.5	Pass
-15	0.5	0.54	0.62	0.64	0.61	0.65	0.76	2.5	Pass
-10	0.59	0.76	0.86	0.92	0.86	0.89	1	2.5	Pass
-5	0.98	1.11	1.23	1.31	1.61	1.63	1.72	2.5	Pass
0	1.25	1.46	1.5	1.87	1.96	1.97	1.98	2.5	Pass
5	1.64	1.81	1.93	2.1	2.16	2.13	2.16	2.5	Pass
10	1.86	2.03	2.03	2.2	2.17	2.14	2.25	2.5	Pass
15	2.03	2.1	2.17	2.15	2.25	2.16	2.24	2.5	Pass
20	2.04	2.11	2.23	2.16	2.26	2.27	2.33	2.5	Pass

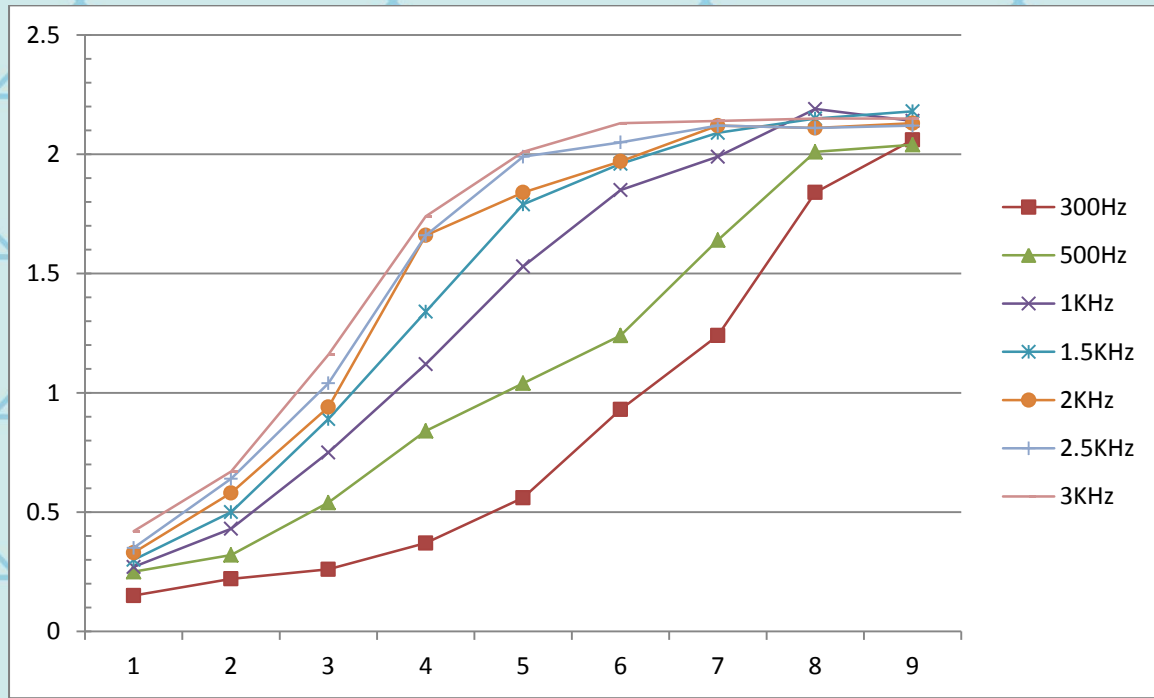



435.0000MHz @ 12.5 KHz Channel Separation

Modulation Input(dBc)	Peak Frequency Deviation (KHz)							Limit(KHz)	Result
	300Hz	500Hz	1KHz	1.5KHz	2KHz	2.5KHz	3KHz		
-20	0.38	0.41	0.41	0.46	0.57	0.53	0.64	2.5	Pass
-15	0.5	0.54	0.62	0.64	0.61	0.65	0.76	2.5	Pass
-10	0.59	0.76	0.86	0.92	0.86	0.89	1	2.5	Pass
-5	0.98	1.11	1.23	1.31	1.61	1.63	1.72	2.5	Pass
0	1.25	1.46	1.5	1.87	1.96	1.97	1.98	2.5	Pass
5	1.64	1.81	1.93	2.1	2.16	2.13	2.16	2.5	Pass
10	1.86	2.03	2.03	2.2	2.17	2.14	2.25	2.5	Pass
15	2.03	2.1	2.17	2.15	2.25	2.16	2.24	2.5	Pass
20	2.04	2.11	2.23	2.16	2.26	2.27	2.33	2.5	Pass

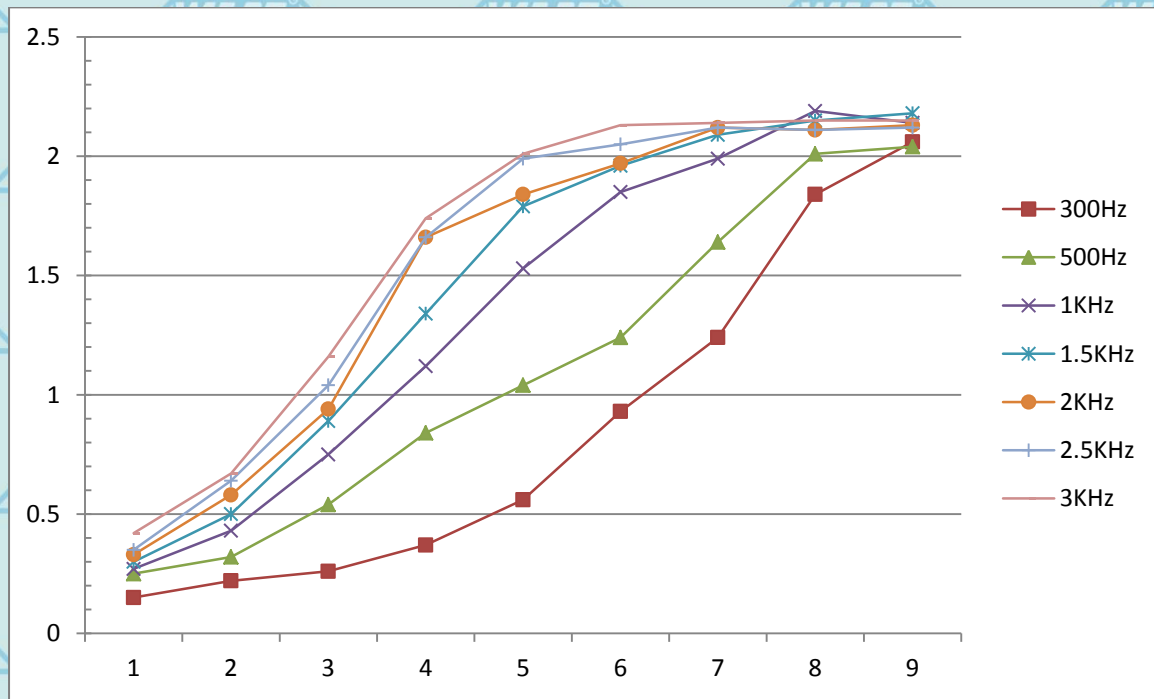



469.9500MHz @ 12.5 KHz Channel Separation

Modulation Input(dBc)	Peak Frequency Deviation (KHz)							Limit(KHz)	Result
	300Hz	500Hz	1KHz	1.5KHz	2KHz	2.5KHz	3KHz		
-20	0.38	0.41	0.41	0.46	0.57	0.53	0.64	2.5	Pass
-15	0.5	0.54	0.62	0.64	0.61	0.65	0.76	2.5	Pass
-10	0.59	0.76	0.86	0.92	0.86	0.89	1	2.5	Pass
-5	0.98	1.11	1.23	1.31	1.61	1.63	1.72	2.5	Pass
0	1.25	1.46	1.5	1.87	1.96	1.97	1.98	2.5	Pass
5	1.64	1.81	1.93	2.1	2.16	2.13	2.16	2.5	Pass
10	1.86	2.03	2.03	2.2	2.17	2.14	2.25	2.5	Pass
15	2.03	2.1	2.17	2.15	2.25	2.16	2.24	2.5	Pass
20	2.04	2.11	2.23	2.16	2.26	2.27	2.33	2.5	Pass

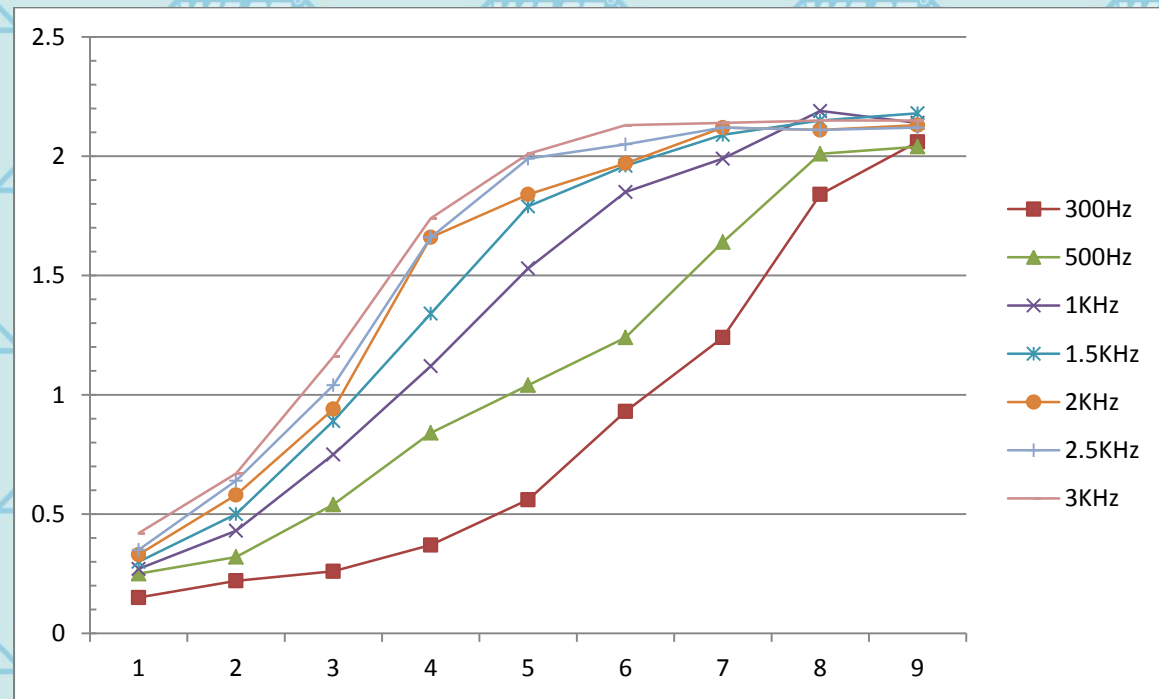



4.2.2 Modulation Frequency Response

406.1500MHz@ 12.5 KHz Channel Separation			
Audio Frequency (KHz)	Frequency Deviation (KHz)	Limit (KHz)	Result
100	0.13	2.5	Pass
300	0.16	2.5	Pass
500	0.28	2.5	Pass
700	0.35	2.5	Pass
1000	0.5	2.5	Pass
1200	0.66	2.5	Pass
1400	1.06	2.5	Pass
1600	1.1	2.5	Pass
1800	1.59	2.5	Pass
2000	1.71	2.5	Pass
2200	1.77	2.5	Pass
2400	1.9	2.5	Pass
2600	1.98	2.5	Pass
2800	2.02	2.5	Pass
3000	2.01	2.5	Pass
3500	1.88	2.5	Pass
4000	1.04	2.5	Pass
4500	0.52	2.5	Pass
5000	0.19	2.5	Pass

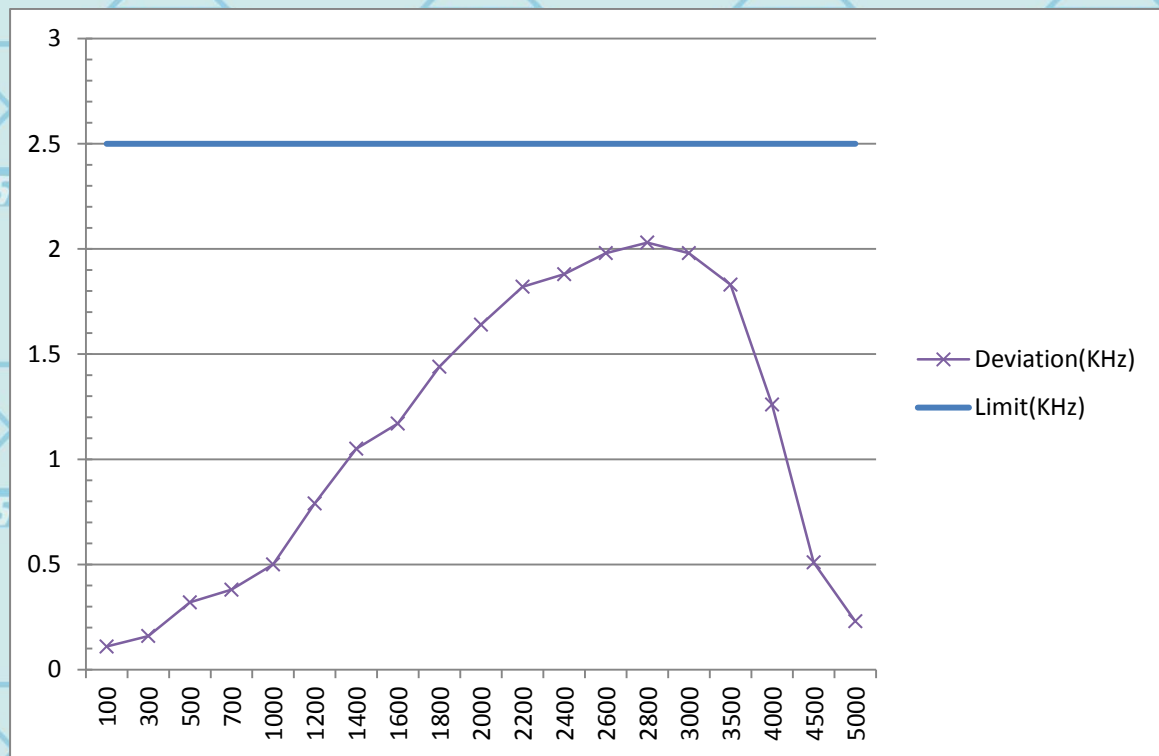



435.0000MHz@ 12.5 KHz Channel Separation

Audio Frequency (KHz)	Frequency Deviation (KHz)	Limit (KHz)	Result
100	0.14	2.5	Pass
300	0.19	2.5	Pass
500	0.3	2.5	Pass
700	0.36	2.5	Pass
1000	0.5	2.5	Pass
1200	0.72	2.5	Pass
1400	0.88	2.5	Pass
1600	1.31	2.5	Pass
1800	1.43	2.5	Pass
2000	1.66	2.5	Pass
2200	1.79	2.5	Pass
2400	1.87	2.5	Pass
2600	1.99	2.5	Pass
2800	2.02	2.5	Pass
3000	1.99	2.5	Pass
3500	1.84	2.5	Pass
4000	1.62	2.5	Pass
4500	0.87	2.5	Pass
5000	0.21	2.5	Pass

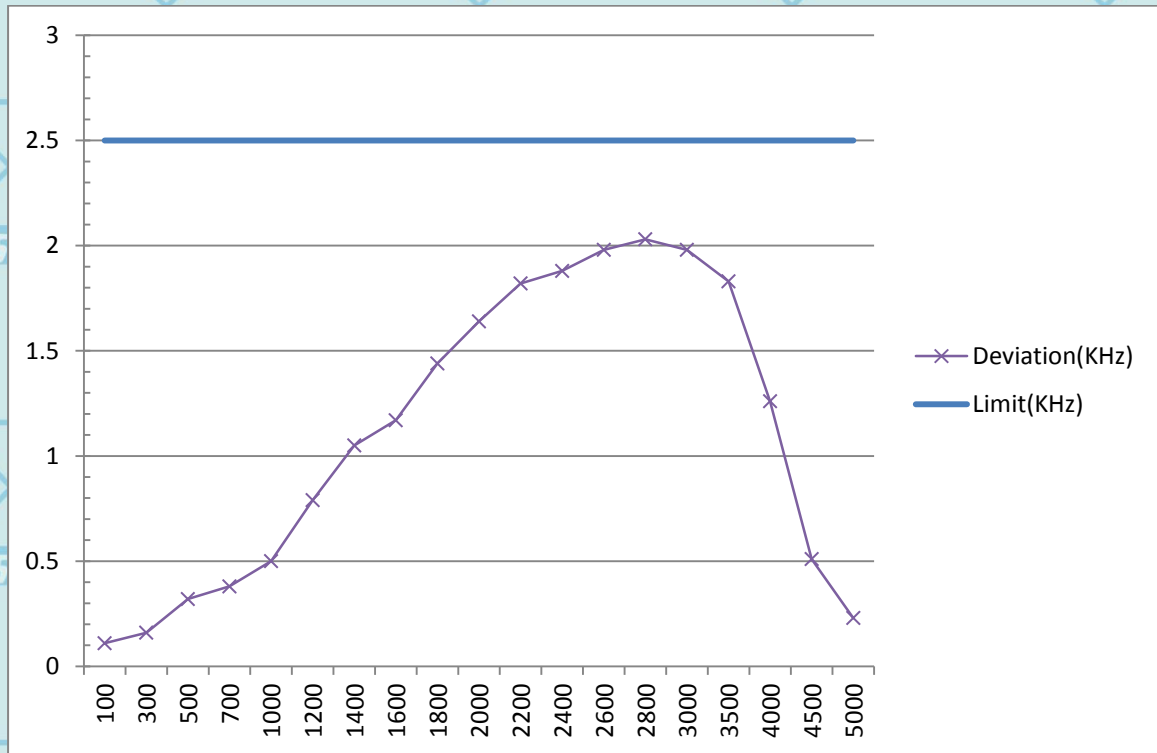



469.9500MHz@ 12.5 KHz Channel Separation

Audio Frequency (KHz)	Frequency Deviation (KHz)	Limit (KHz)	Result
100	0.11	2.5	Pass
300	0.16	2.5	Pass
500	0.32	2.5	Pass
700	0.38	2.5	Pass
1000	0.5	2.5	Pass
1200	0.79	2.5	Pass
1400	1.05	2.5	Pass
1600	1.17	2.5	Pass
1800	1.44	2.5	Pass
2000	1.64	2.5	Pass
2200	1.82	2.5	Pass
2400	1.88	2.5	Pass
2600	1.98	2.5	Pass
2800	2.03	2.5	Pass
3000	1.98	2.5	Pass
3500	1.83	2.5	Pass
4000	1.26	2.5	Pass
4500	0.51	2.5	Pass
5000	0.23	2.5	Pass

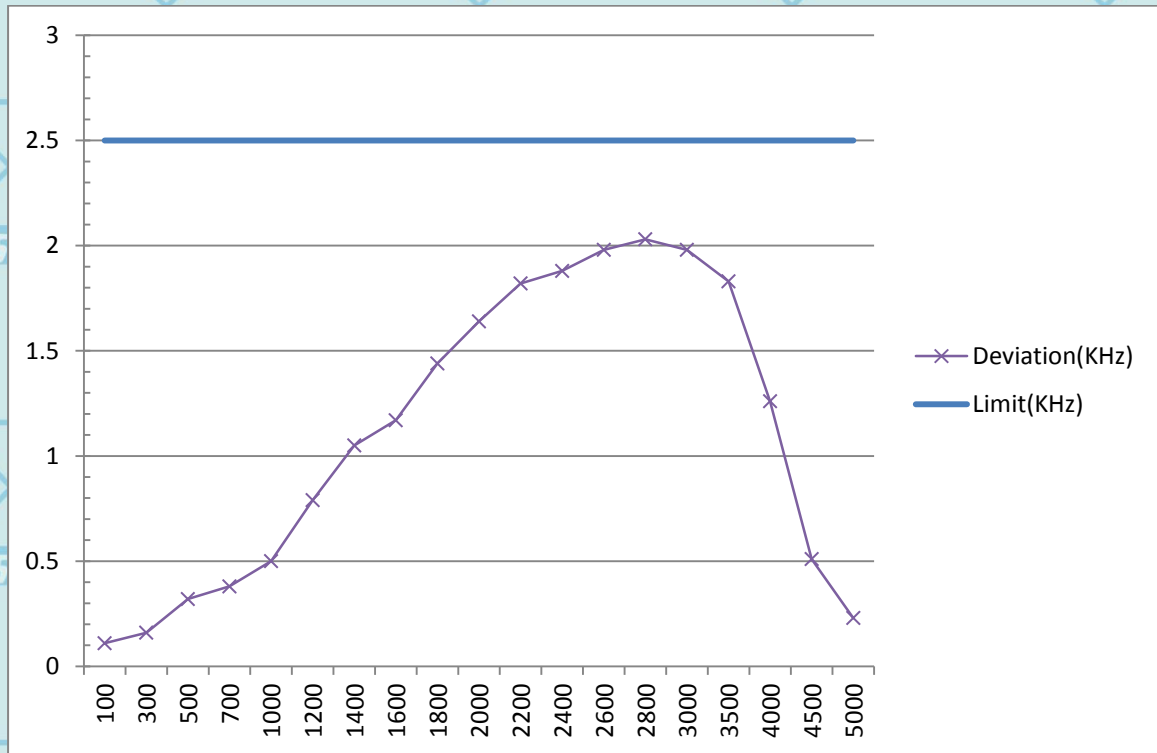



4.5.3 Audio Frequency Response

406.1500MHz@ 12.5 KHz Channel Separation		
Audio Frequency (KHz)	dB relative to 1 KHz	Limits
1	0	
3	1.4	
4	0.8	
5	-0.8	0.0
6	-11.7	-6.6
8	-49.2	-16.9
10	-54.8	-25.0
15	-54.8	-39.6
20	-54.8	-50.0
30	-54.8	-50.0
40	-54.8	-50.0
50	-54.8	-50.0
60	-54.8	-50.0
70	-54.8	-50.0
80	-54.8	-50.0
90	-54.8	-50.0
100	-54.8	-50.0

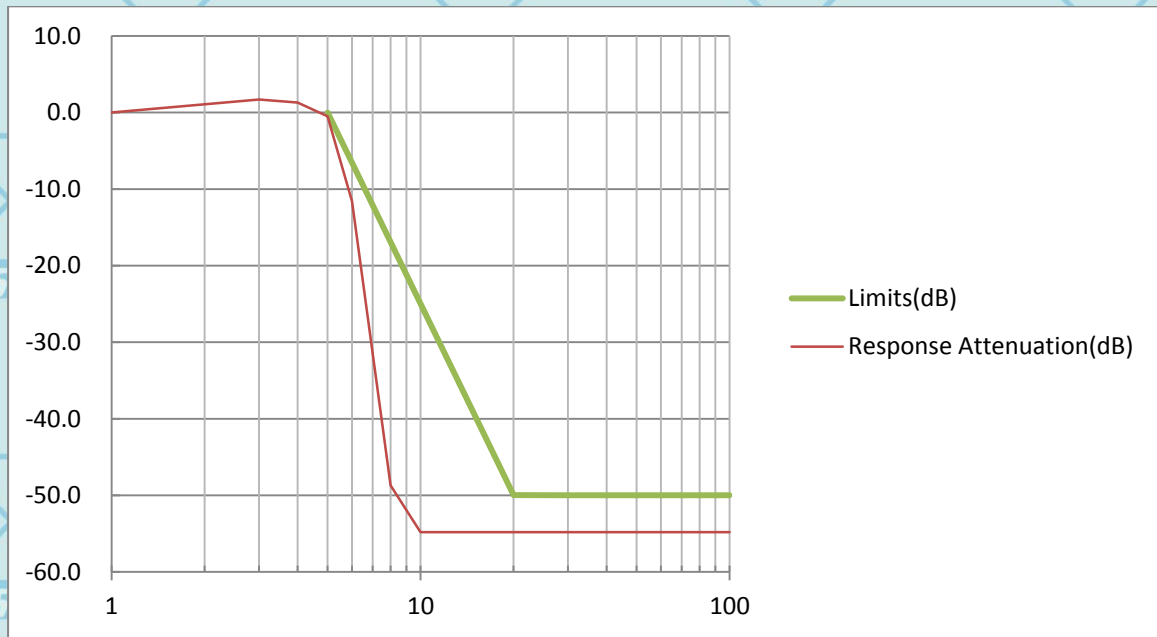



435.0000MHz@ 12.5 KHz Channel Separation

Audio Frequency (KHz)	dB relative to 1 KHz	Limits
1	0	
3	1.5	
4	1.1	
5	-0.9	0.0
6	-13.9	-6.6
8	-48.6	-16.9
10	-54.8	-25.0
15	-54.8	-39.6
20	-54.8	-50.0
30	-54.8	-50.0
40	-54.8	-50.0
50	-54.8	-50.0
60	-54.8	-50.0
70	-54.8	-50.0
80	-54.8	-50.0
90	-54.8	-50.0
100	-54.8	-50.0

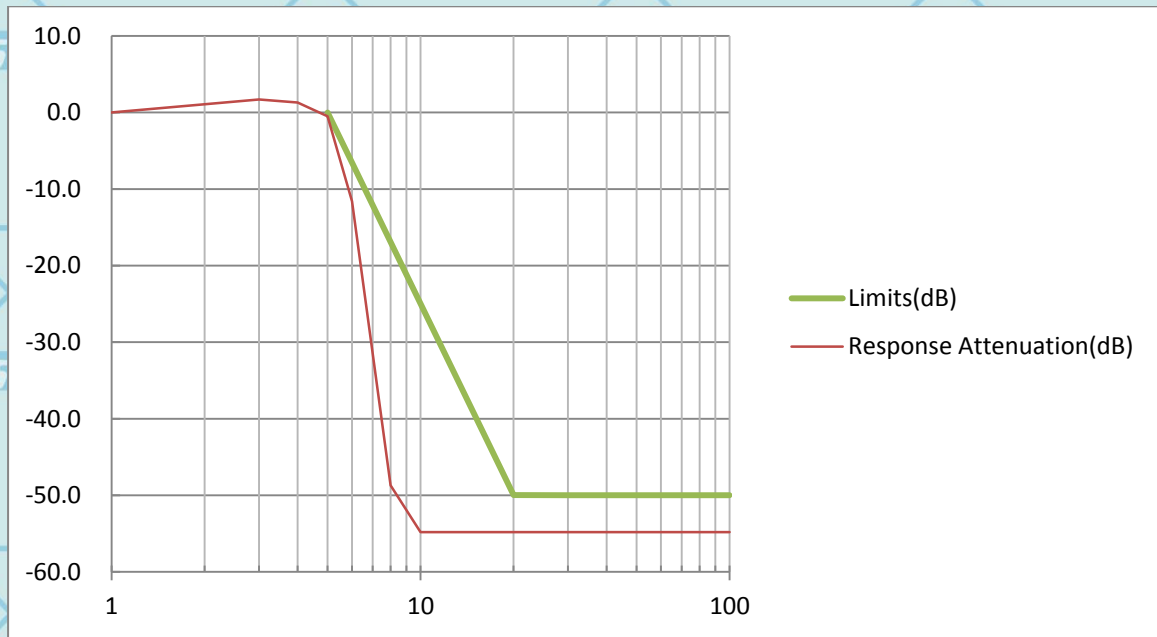



469.9500MHz@ 12.5 KHz Channel Separation

Audio Frequency (KHz)	dB relative to 1 KHz	Limits
1	0	
3	1.7	
4	1.3	
5	-0.5	0.0
6	-11.6	-6.6
8	-48.7	-16.9
10	-54.8	-25.0
15	-54.8	-39.6
20	-54.8	-50.0
30	-54.8	-50.0
40	-54.8	-50.0
50	-54.8	-50.0
60	-54.8	-50.0
70	-54.8	-50.0
80	-54.8	-50.0
90	-54.8	-50.0
100	-54.8	-50.0

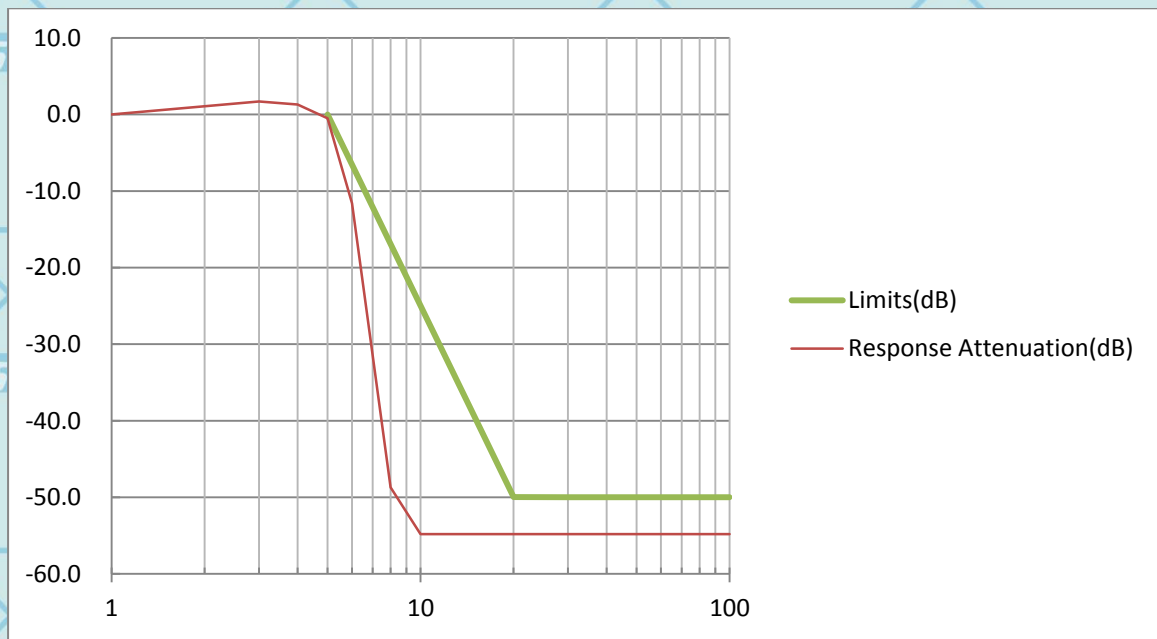



4.3. Occupied Bandwidth and Emission Mask

TEST CONFIGURATION

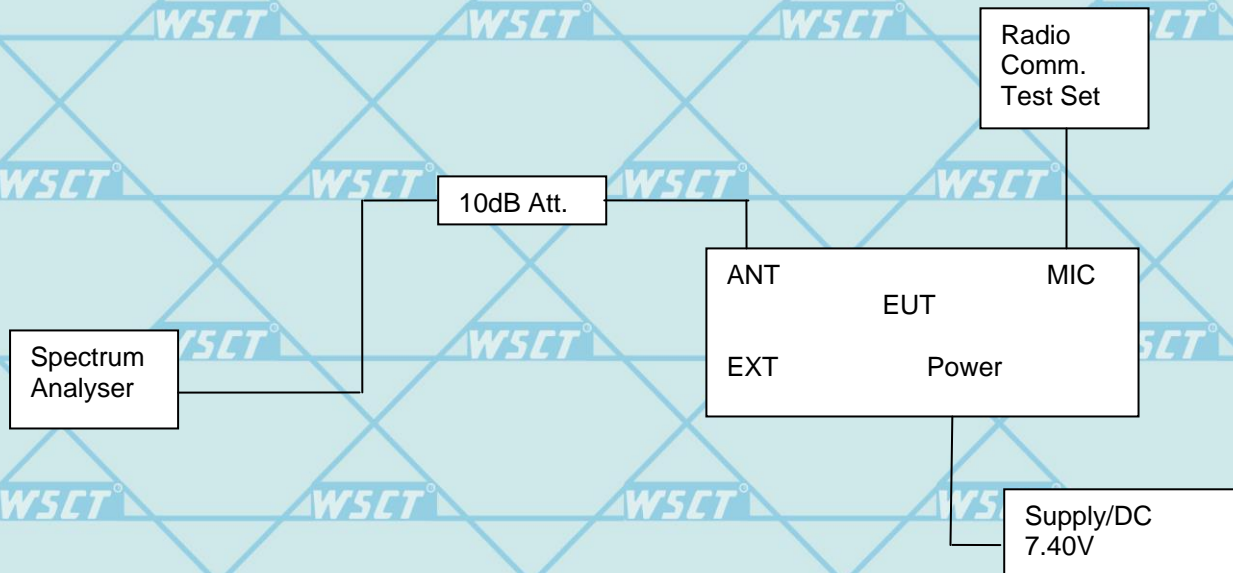

TEST PROCEDURE

- 1 The EUT was modulated by 2.5 KHz Sine wave audio signal;the level of the audio signal employed is 16 dB greater than that necessary to produce 50% of rated system deviation.
- 2 Set EUT work at continuous transmitting.
- 3 Set SPA Centre Frequency = fundamental frequency, RBW=300Hz, VBW= 1 KHz, span =100 KHz.
- 4 Set SPA Max hold. Mark peak, Set 99% Occupied Bandwidth and 26dB Occupied Bandwidth.

LIMIT

Standard Channel Spacing/Bandwidth

Frequency band (MHz)	Channel spacing (kHz)	Authorized bandwidth (kHz)
Below 25 ²		
25-50	20	20
72-76	20	20
150-174	17.5	1 ³ 20/11.25/6
216-220 ⁵	6.25	20/11.25/6
220-222	5	4
406-512 ²	16.25	136 ²⁰ /11.25/6
806-809/851-854	12.5	20
809-824/854-869	25	6 ²⁰
896-901/935-940	12.5	13.6
902-928 ⁴		
929-930	25	20
1427-1432 ⁵	12.5	12.5
³ 2450-2483.5 ²		
Above 2500 ²		

For stations authorized on or after August 18, 1995.





²Bandwidths for radiolocation stations in the 420-450 MHz band and for stations operating in bands subject to this footnote will be reviewed and authorized on a case-by-case basis.

³Operations using equipment designed to operate with a 25 kHz channel bandwidth will be authorized a 20 kHz bandwidth. Operations using equipment designed to operate with a 12.5 kHz channel bandwidth will be authorized a 11.25 kHz bandwidth. Operations using equipment designed to operate with a 6.25 kHz channel bandwidth will be authorized a 6 kHz bandwidth. All stations must operate on channels with a bandwidth of 12.5 kHz or less beginning January 1, 2013, unless the operations meet the efficiency standard of §90.203(j)(3).

⁴The maximum authorized bandwidth shall be 12 MHz for non-multilateration LMS operations in the band 909.75-921.75 MHz and 2 MHz in the band 902.00-904.00 MHz. The maximum authorized bandwidth for multilateration LMS operations shall be 5.75 MHz in the 904.00-909.75 MHz band; 2 MHz in the 919.75-921.75 MHz band; 5.75 MHz in the 921.75-927.25 MHz band and its associated 927.25-927.50 MHz narrowband forward link; and 8.00 MHz if the 919.75-921.75 MHz and 921.75-927.25 MHz bands and their associated 927.25-927.50 MHz and 927.50-927.75 MHz narrowband forward links are aggregated.

⁵See §90.259.

⁶Operations using equipment designed to operate with a 25 kHz channel bandwidth may be authorized up to a 22 kHz bandwidth if the equipment meets the Adjacent Channel Power limits of §90.221.

(6)(i) Beginning January 1, 2011, no new applications for the 150-174 MHz and/or 421-512 MHz bands will be acceptable for filing if the applicant utilizes channels with an authorized bandwidth exceeding 11.25 kHz, unless specified elsewhere or the operations meet the efficiency standards of §90.203(j)(3).

(ii) Beginning January 1, 2011, no modification applications for stations in the 150-174 MHz and/or 421-512 MHz bands that increase the station's authorized interference contour, will be acceptable for filing if the applicant utilizes channels with an authorized bandwidth exceeding 11.25 kHz, unless specified elsewhere or the operations meet the efficiency standards of §90.203(j)(3). See §90.187(b)(2)(iii) and (iv) for interference contour designations and calculations. Applications submitted pursuant to this paragraph must comply with frequency coordination requirements of §90.175.

(7) Economic Area (EA)-based licensees in frequencies 817-824/862-869 MHz (813.5-824/858.5-869 MHz in the counties listed in §90.614(c)) may exceed the standard channel spacing and authorized bandwidth listed in paragraph (b)(5) of this section in any National Public Safety Planning Advisory Committee Region when all 800 MHz public safety licensees in the Region have completed band reconfiguration consistent with this part. In any National Public Safety Planning Advisory Committee Region where the 800 MHz band reconfiguration is incomplete, EA-based licensees in frequencies 817-821/862-866 MHz (813.5-821/858.5-866 MHz in the counties listed in §90.614(c)) may exceed the standard channel spacing and authorized bandwidth listed in paragraph (b)(5) of this section. Upon all 800 MHz public safety licensees in a National Public Safety Planning Advisory Committee Region completing band reconfiguration, EA-based 800 MHz SMR licensees in the 821-824/866-869 MHz band may exceed the channel spacing and authorized bandwidth in paragraph (b)(5) of this section. Licensees authorized to exceed the standard channel spacing and authorized bandwidth under this paragraph must provide at least 30 days written notice prior to initiating such service in the bands listed herein to every 800 MHz public safety licensee with a base station in an affected National Public Safety Planning Advisory Committee Region, and every 800 MHz public safety licensee with a base station within 113 kilometers (70 miles) of an affected National Public Safety Planning Advisory Committee Region. Such notice shall include the estimated date upon which the EA-based 800 MHz SMR licensee intends to begin operations that exceed the channel spacing and authorized bandwidth in paragraph (b)(5) of this section.





Applicable Emission Masks

Frequency band (MHz)	Mask for equipment with audio low pass filter	Mask for equipment without audio low pass filter
Below 25 ¹	A or B	A or C
25-50	B	C
72-76	B	C
150-174 ²	B, D, or E	C, D or E
150 paging only	B	C
220-222	F	F
421-512 ^{2 5}	B, D, or E	C, D, or E
450 paging only	B	G
806-809/851-854 ⁶	B	H
809-824/854-869 ^{3 5}	B	G
896-901/935-940	I	J
902-928	K	K
929-930	B	G
4940-4990 MHz	L or M	L or M
5850-5925 ⁴		
All other bands	B	C

¹Equipment using single sideband J3E emission must meet the requirements of Emission Mask A. Equipment using other emissions must meet the requirements of Emission Mask B or C, as applicable.

²Equipment designed to operate with a 25 kHz channel bandwidth must meet the requirements of Emission Mask B or C, as applicable. Equipment designed to operate with a 12.5 kHz channel bandwidth must meet the requirements of Emission Mask D, and equipment designed to operate with a 6.25 kHz channel bandwidth must meet the requirements of Emission Mask E.

³Equipment used in this licensed to EA or non-EA systems shall comply with the emission mask provisions of §90.691 of this chapter.

⁴DSRCS Roadside Units equipment in the 5850-5925 MHz band is governed under subpart M of this part.

⁵Equipment may alternatively meet the Adjacent Channel Power limits of §90.221

TEST RESULTS

Modulation	Channel Separation	Test Frequency (MHz)	Reading(KHz)			
			High Power Level		Low Power Level	
			99% OBW	-26dB EBW	99% OBW	-26dB EBW
FM	12.5KHz	435.0000	10.02	10.30	10.02	10.40
4FSK	12.5KHz	435.0000	7.52	9.25	7.52	9.54
Limitation			11.25KHz		11.25KHz	
Result			Pass		Pass	

Modulation	Channel Separation	Test Frequency (MHz)	Reading(KHz)	
			High Power Level	Low Power Level
FM	12.5KHz	435.0000	Pass	Pass
4FSK	12.5KHz	435.0000	Pass	Pass
Limitation			Mask D	Mask D

Note:

- All measured including cable loss and atten.
- Please refer to following test plots;



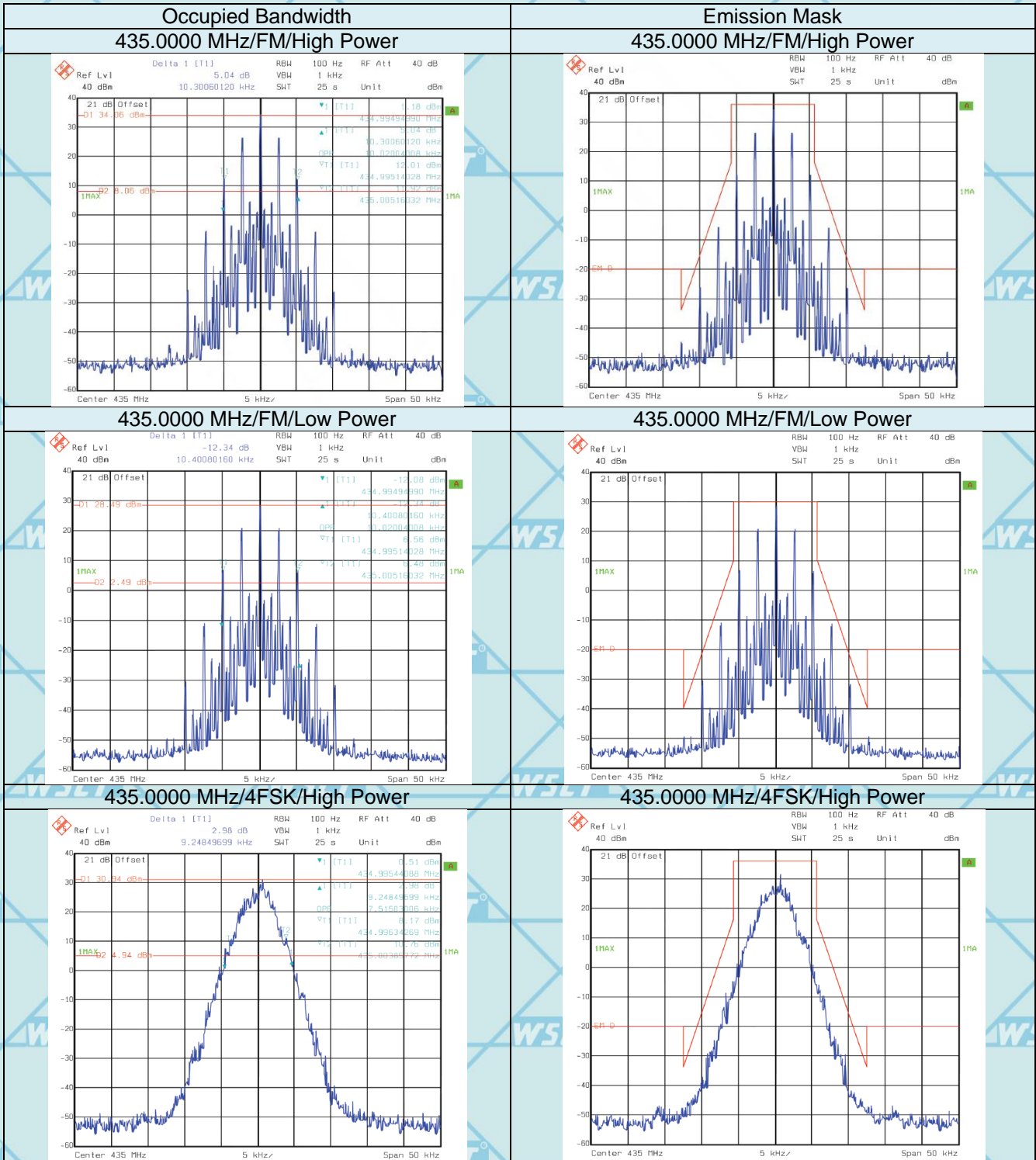



For Question,
 Please Contact with WSCT
www.wsct-cert.com

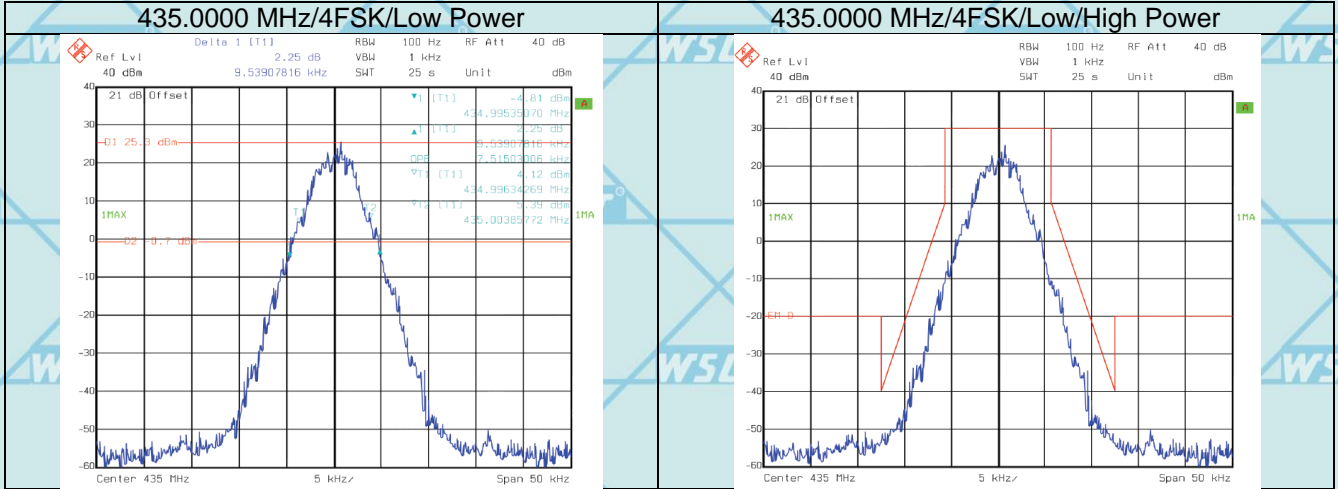



4.4. Field Strength Spurious Emissions

TEST APPLICABLE

According to the TIA/EIA 603D test method, and according to §95.635, the power of each unwanted emission shall be less than Transmitted Power as specified below:

1. At least 25 dB (decibels) on any frequency removed from the center of the authorized bandwidth by more than 50% up to and including 100% of the authorized bandwidth.
2. At least 35 dB on any frequency removed from the center of the authorized bandwidth by more than 100% up to and including 250% of the authorized bandwidth.
3. At least $43 + 10 \log_{10}(T)$ dB on any frequency removed from the center of the authorized bandwidth by more than 250%.

TEST CONFIGURATION

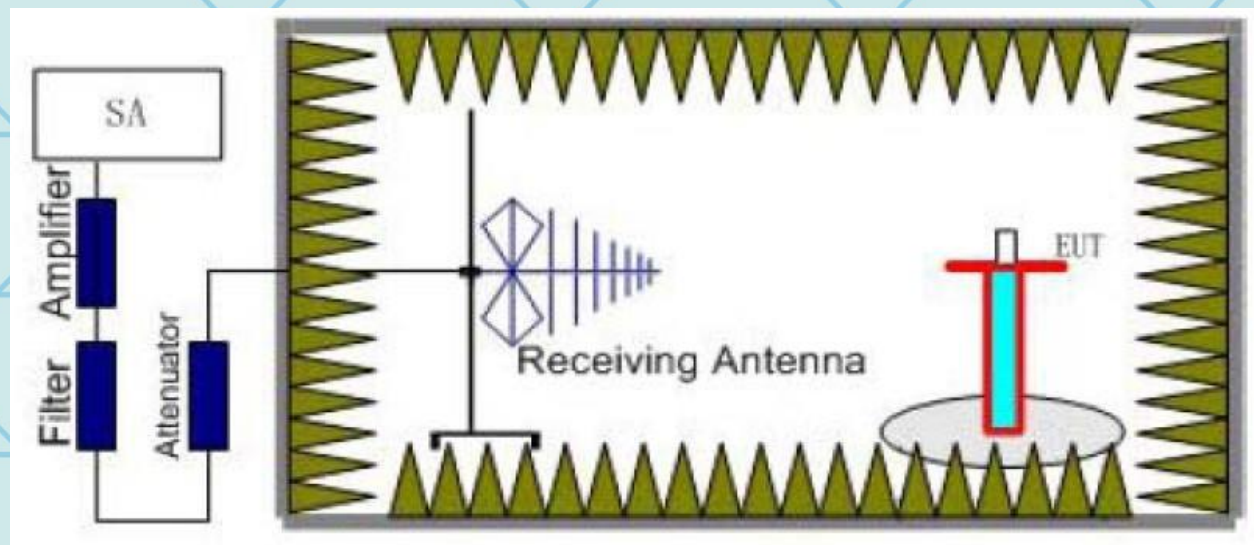
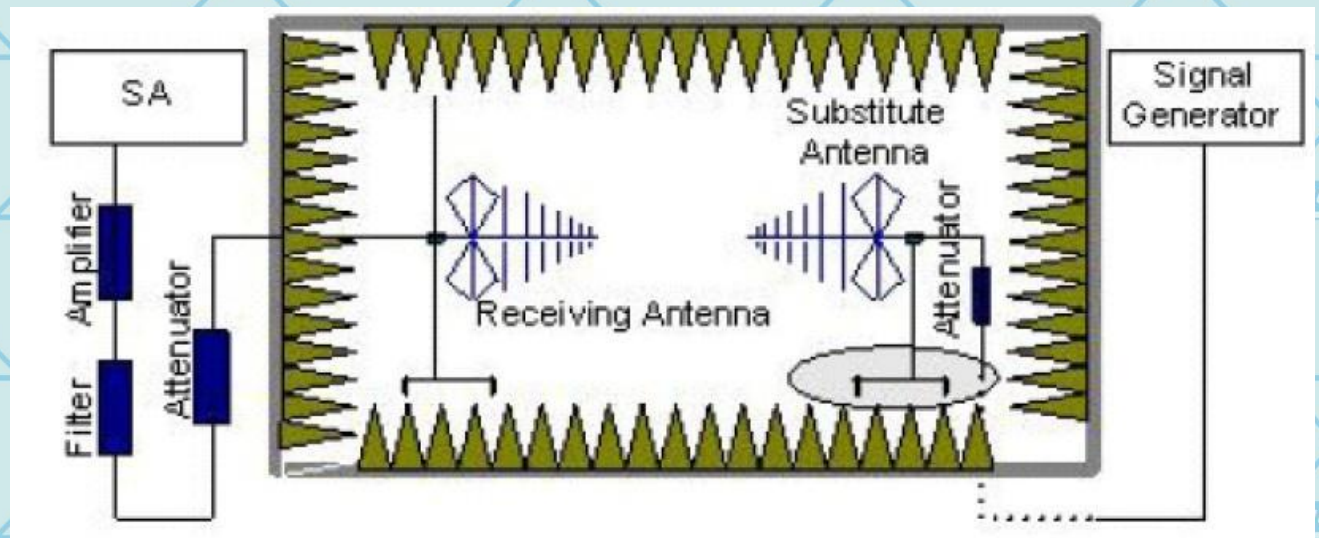

TEST PROCEDURE

1. EUT was placed on a 1.50 meter high non-conductive stand at a 3 meter test distance from the receive antenna. A receiving antenna was placed on the antenna mast 3 meters from the EUT for emission measurements. The height of receiving antenna is 1.50 m. Detected emissions were maximized at each frequency by rotating the EUT through 360° and adjusting the receiving antenna polarization. The radiated emission measurements of all transmit frequencies in six channels were measured with peak detector.

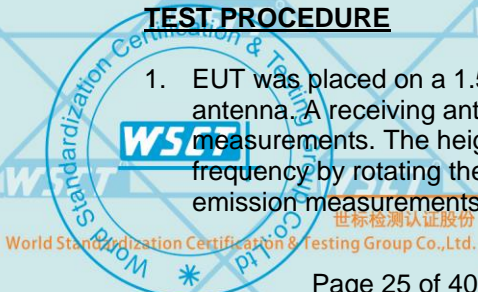



2. A log-periodic antenna or double-ridged waveguide horn antenna shall be substituted in place of the EUT. The log-periodic antenna will be driven by a signal generator and the level will be adjusted till the same power value on the spectrum analyser or receiver. The level of the spurious emissions can be calculated through the level of the signal generator, cable loss, the gain of the substitution antenna and the reading of the spectrum analyser or receiver.
3. The EUT is then put into continuously transmitting mode at its maximum power level during the test. Set Test Receiver or Spectrum RBW=1MHz,VBW=3MHz for above 1GHz and RBW=100KHz,VBW=300KHz for 30MHz to 1GHz, And the maximum value of the receiver should be recorded as (P_r).
4. The EUT shall be replaced by a substitution antenna. In the chamber, an substitution antenna for the frequency band of interest is placed at the reference point of the chamber. An RF Signal source for the frequency band of interest is disconnected to the substitution antenna with a cable that has been constructed to not interfere with the radiation pattern of the antenna. A power (P_{Mea}) is applied to the input of the substitution antenna, and adjust the level of the signal generator output until the value of the receiver reach the previously recorded (P_r). The power of signal source (P_{Mea}) is recorded. The test should be performed by rotating the test item and adjusting the receiving antenna polarization.
5. A amplifier should be connected to the Signal Source output port. And the cable should be connect between the Amplifier and the Substitution Antenna. The cable loss (P_{cl}), the Substitution Antenna Gain (G_a) and the Amplifier Gain (P_{Ag}) should be recorded after test. The measurement results are obtained as described below:

$$\text{Power(EIRP)} = P_{Mea} - P_{Ag} - P_{cl} + G_a$$

It can omit power amplifier if signal generator level meets requirement;

This value is EIRP since the measurement is calibrated using an antenna of known gain (2.15 dBi) and known input power.

6. ERP can be calculated from EIRP by subtracting the gain of the dipole, $ERP = EIRP - 2.15\text{dBi}$.

Subrange (GHz)	RBW	VBW	Sweep time (s)
0.00009~0.15	1KHz	3KHz	30
0.00015~0.03	10KHz	30KHz	10
0.03~1	100KHz	300KHz	10
1~5	1 MHz	3 MHz	5

TEST LIMIT

According to §90.210 d) (3) On any frequency removed from the center of the authorized bandwidth by a displacement frequency (f_d in kHz) of more than 12.5 kHz: At least $50 + 10 \log(P)$ dB or 70 dB, whichever is the lesser attenuation.

TEST RESULTS

Note : only the high power mode result in test report.

Note:

1. In general, the worst case attenuation requirement shown above was applied.
2. The measurement frequency range from 9KHz to 5 GHz.
3. EIRP for measure frequency above 1 GHz and ERP for below 1 GHz.
4. *** means that the emission level is too low to be measured or at least 20 dB down than the limit.





Test Frequency: 406.1500MHz				Channel Separation:12.5KHz			
Frequency (MHz)	P _{Mea} (dBm)	Path Loss	Antenna Gain	Correction (dB)	Values (dBm)	Limit (dBm)	Polarization
812.30	-47.41	0.77	6.12	2.15	-44.21	-20.00	H
1218.45	-44.38	1.12	6.38	0.00	-39.12	-20.00	H
1624.60	-54.77	1.32	10.11	0.00	-45.98	-20.00	H
...	H
812.30	-39.31	0.77	6.12	2.15	-36.11	-20.00	V
1218.45	-42.47	1.12	6.38	0.00	-37.21	-20.00	V
1624.60	-54.90	1.32	10.11	0.00	-46.11	-20.00	V
...	V

Test Frequency: 435.0000MHz				Channel Separation:12.5KHz			
Frequency (MHz)	P _{Mea} (dBm)	Path Loss	Antenna Gain	Correction (dB)	Values (dBm)	Limit (dBm)	Polarization
870.00	-45.31	0.77	6.12	2.15	-42.11	-20.00	H
1305.00	-50.38	1.12	6.38	0.00	-45.12	-20.00	H
1740.00	-57.91	1.32	10.11	0.00	-49.12	-20.00	H
...	H
870.00	-40.85	0.77	6.12	2.15	-37.65	-20.00	V
1305.00	-47.58	1.12	6.38	0.00	-42.32	-20.00	V
1740.00	-56.02	1.32	10.11	0.00	-47.23	-20.00	V
...	V

Test Frequency: 469.9500MHz				Channel Separation:12.5KHz			
Frequency (MHz)	P _{Mea} (dBm)	Path Loss	Antenna Gain	Correction (dB)	Values (dBm)	Limit (dBm)	Polarization
939.90	-47.41	0.77	6.12	2.15	-44.21	-20.00	H
1409.85	-44.38	1.12	6.38	0.00	-39.12	-20.00	H
1879.80	-54.77	1.32	10.11	0.00	-45.98	-20.00	H
...	H
939.90	-39.31	0.77	6.12	2.15	-36.11	-20.00	V
1409.85	-42.47	1.12	6.38	0.00	-37.21	-20.00	V
1879.80	-54.90	1.32	10.11	0.00	-46.11	-20.00	V
...	V





4.5. Conducted spurious emission result(at antenna terminal):
TEST CONFIGURATION



TEST PROCEDURE

- 3) Connect the equipmet as illuustrated.
- 4) Set EUT working in continuous mode in low,middle,high frequency,read and record the peak power value.

TEST LIMIT

According to §90.210 d) (3) On any frequency removed from the center of the authorized bandwidth by a displacement frequency (f_d in kHz) of more than 12.5 kHz: At least $50 + 10 \log (P)$ dB or 70 dB, whichever is the lesser attenuation.

TEST RESULTS





For Question, Please Contact with WSCT www.wsct-cert.com

406.1500 MHz- 12.5KHz@30 MHz – 1000 MHz@Pass

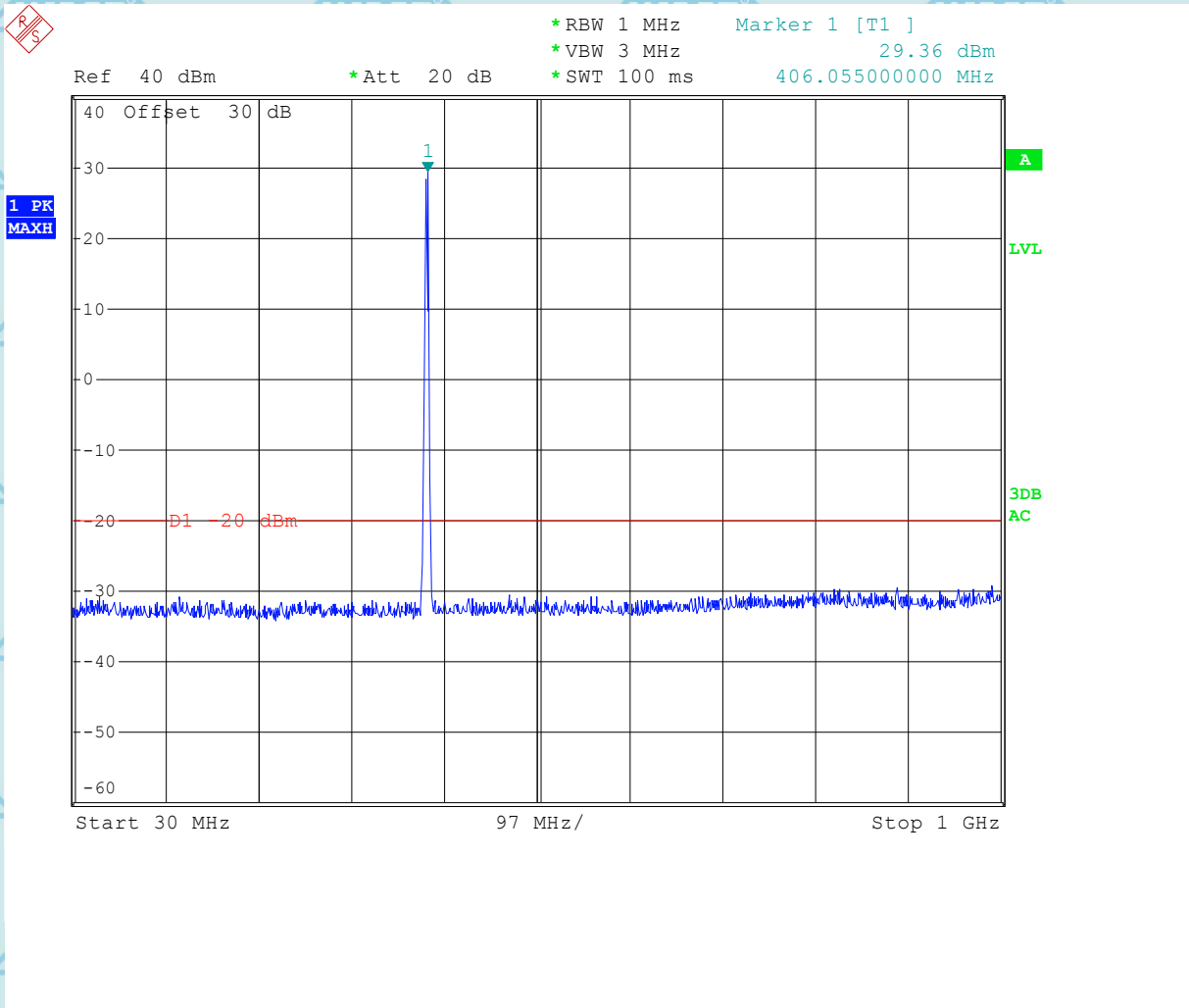



For Question,
Please Contact with WSCT
www.wsct-cert.com

406.1500 MHz- 12.5KHz@1000 MHz – 6000 MHz@Pass

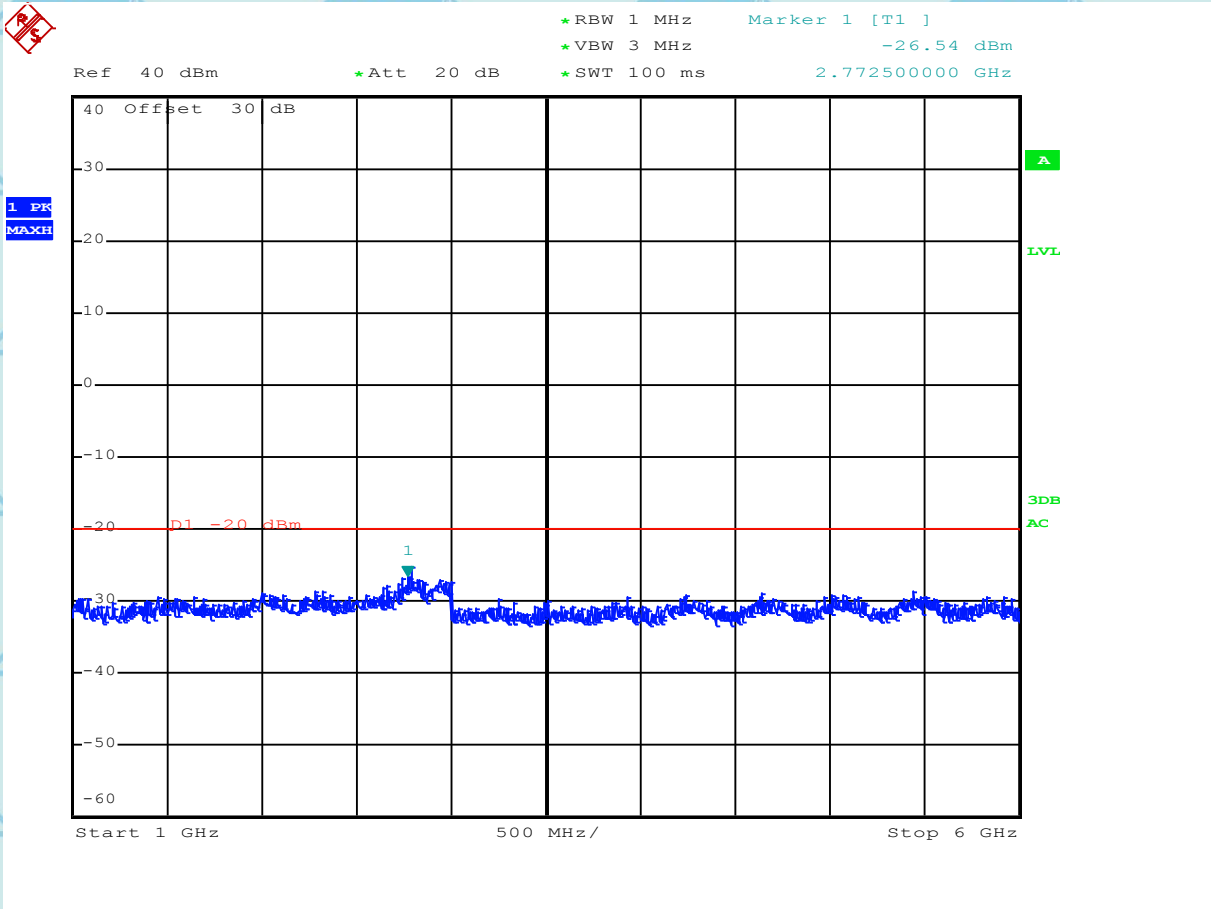



For Question,
Please Contact with WSCT
www.wsct-cert.com

435.0000 MHz- 12.5KHz@30 MHz – 1000 MHz@Pass

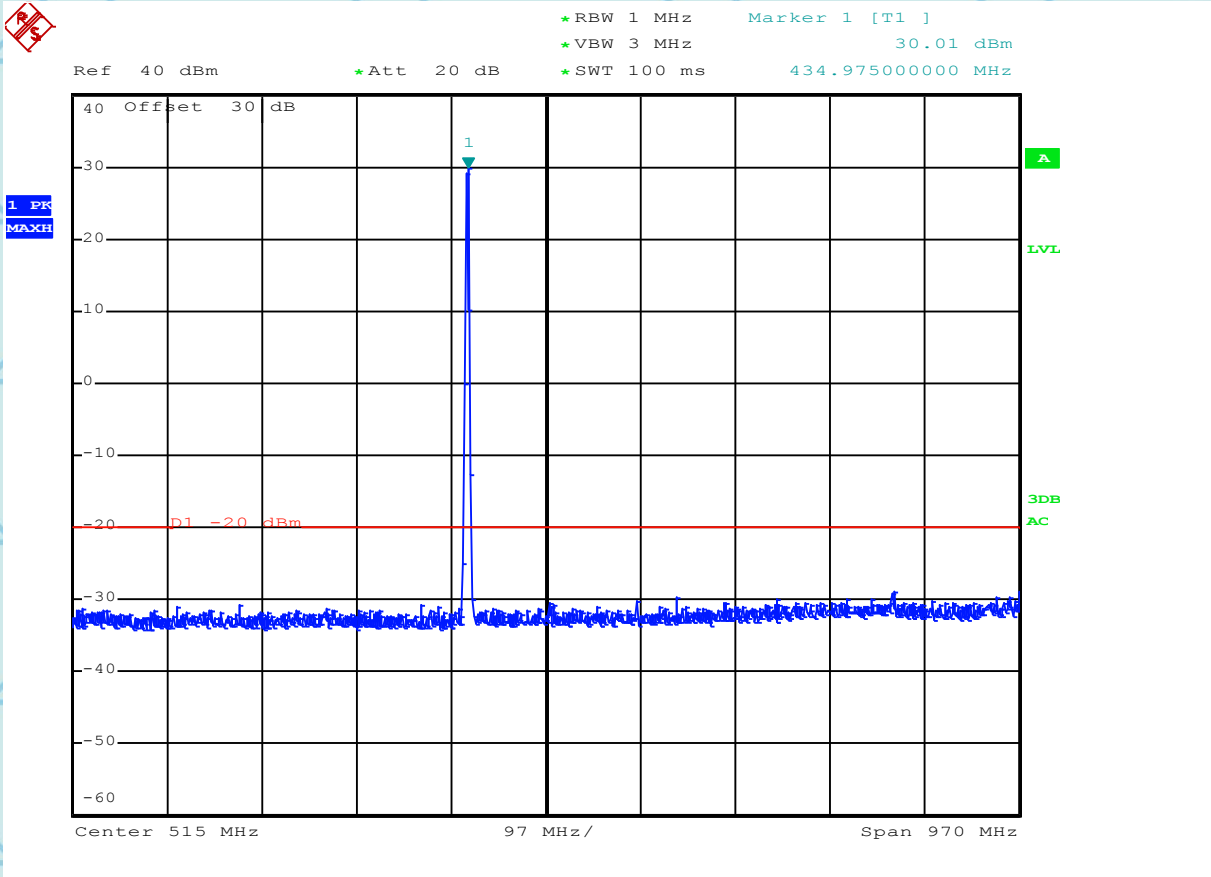



For Question,
Please Contact with WSCT
www.wsct-cert.com

435.0000 MHz- 12.5KHz@1000 MHz – 6000 MHz@Pass

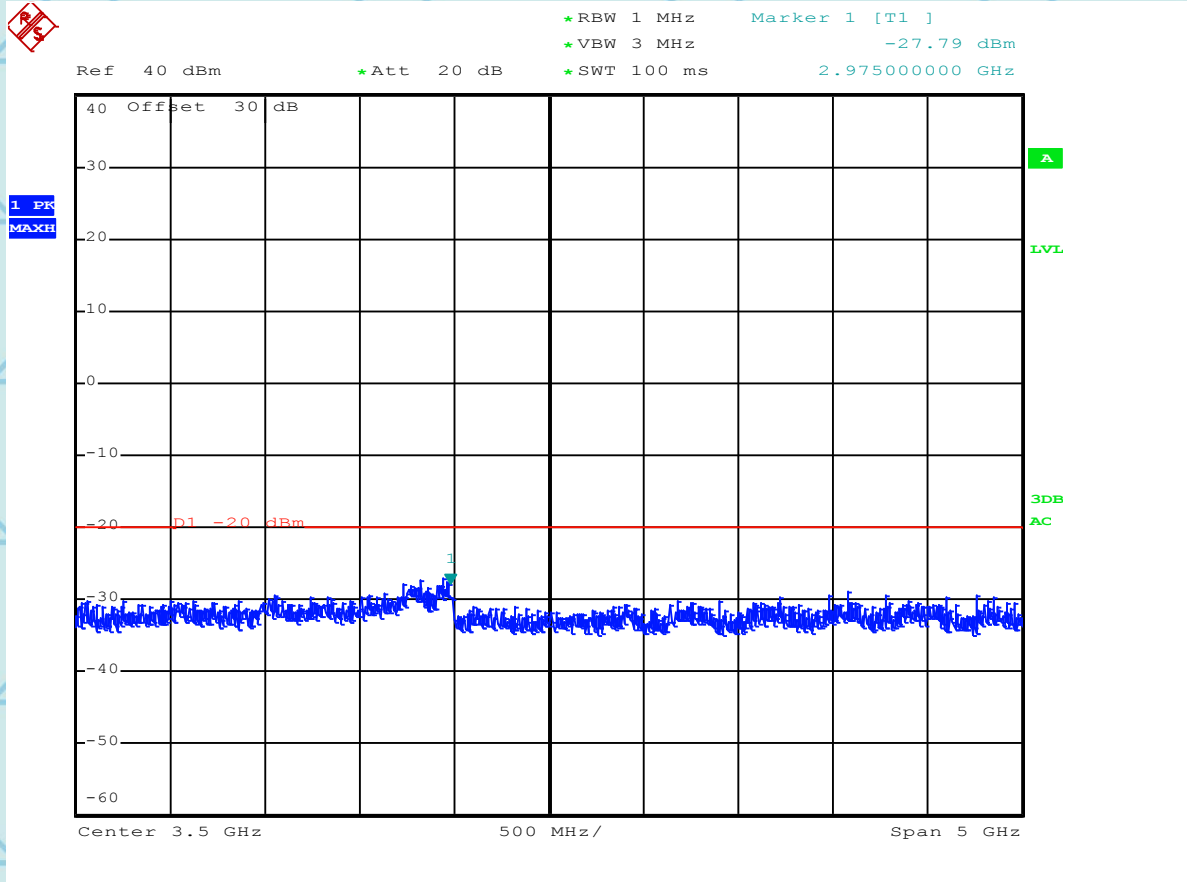



For Question, Please Contact with WSCT www.wsct-cert.com

469.9500 MHz- 12.5KHz@30 MHz – 1000 MHz@Pass

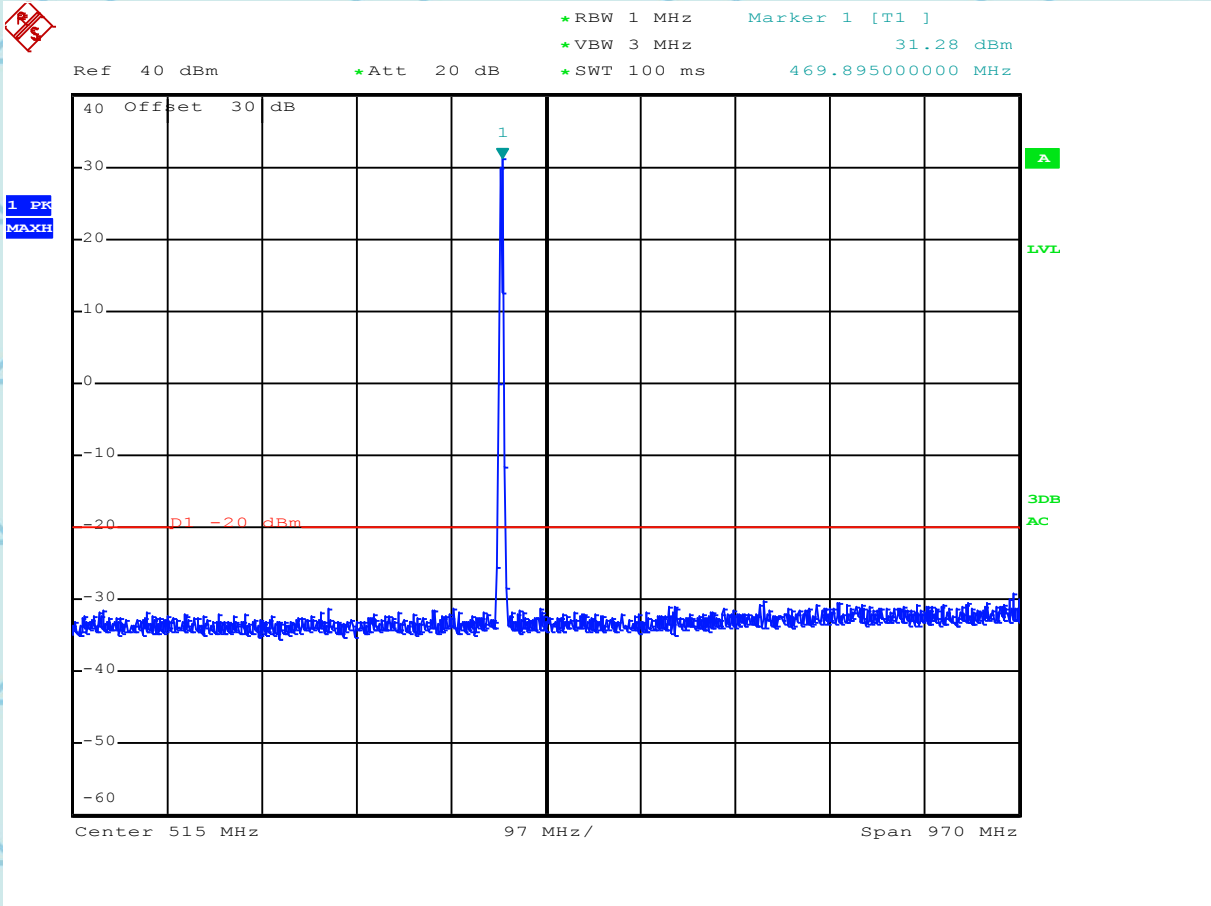



For Question,
Please Contact with WSCT
www.wsct-cert.com

469.9500 MHz- 12.5KHz@1000 MHz – 6000 MHz@Pass

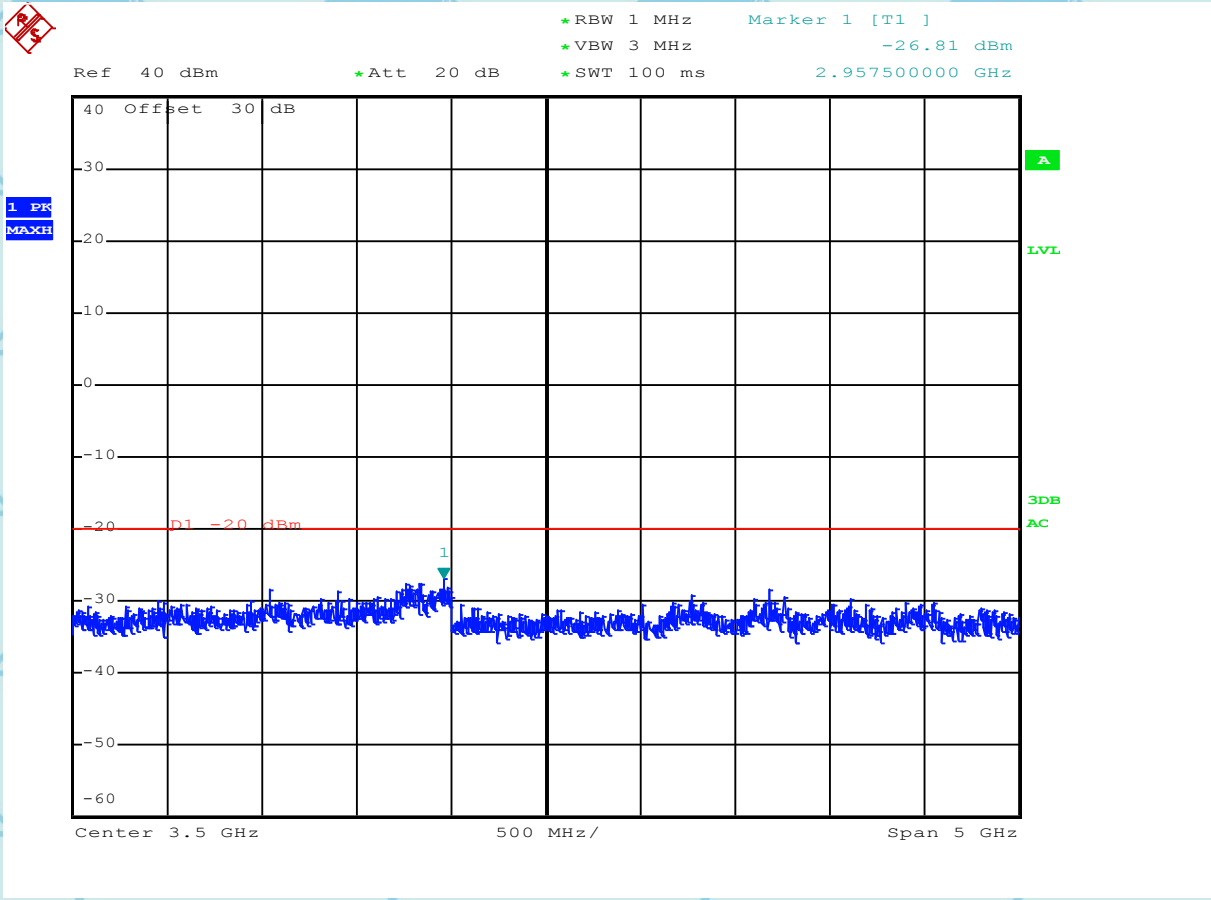



4.6. Frequency Stability

TEST CONFIGURATION

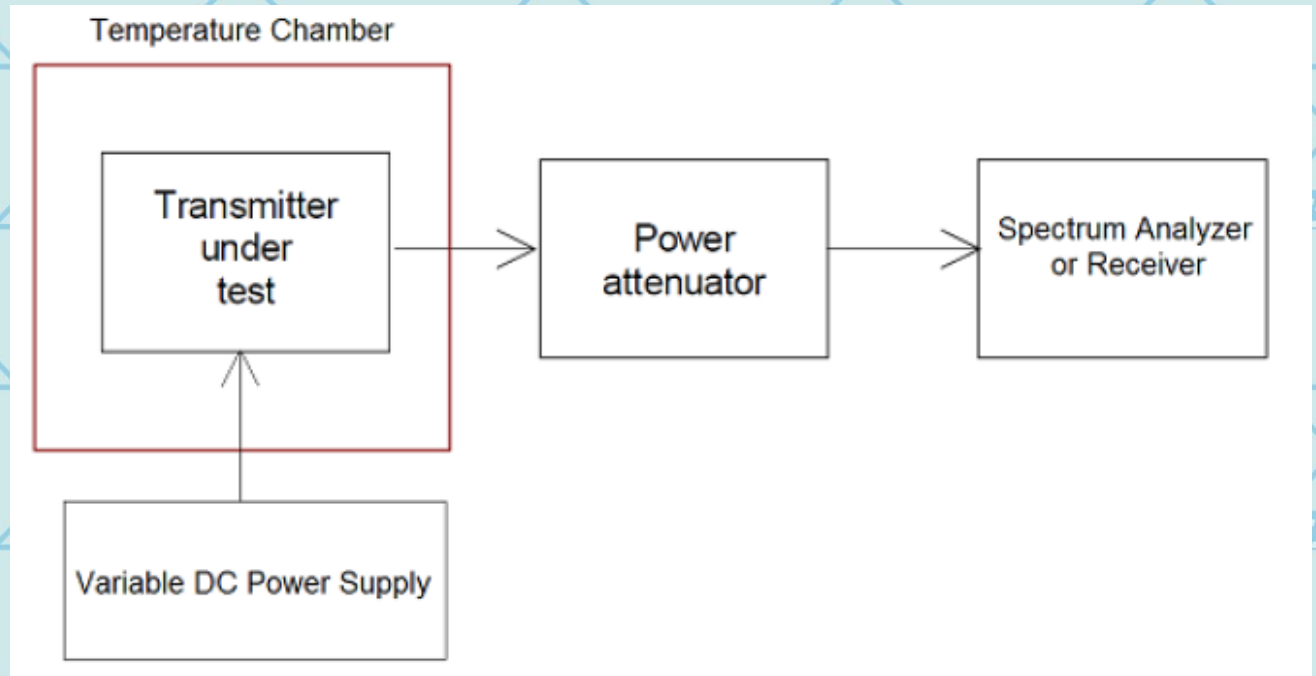

TEST PROCEDURE

The EUT was set in the climate chamber and connected to an external DC power supply. The RF output was directly connected to frequency meter. The coupling loss of the additional cables was recorded and taken in account for all the measurements. After temperature stabilization (approx. 20 min for each stage), the frequency for the lower, the middle and the highest frequency range was recorded. For Frequency stability Vs. Voltage the EUT was connected to a DC power supply and the voltage was adjusted in the required ranges. The result was recorded.

TEST APPLICABLE

- 1 According to FCC Part 2 Section 2.1055 (a)(1), the frequency stability shall be measured with variation of ambient temperature from -30°C to +60°C centigrade.
- 2 According to FCC Part 2 Section 2.1055 (a) (2), for battery powered equipment, the frequency stability shall be measured with reducing primary supply voltage to the battery operating end point, which is specified by the manufacture.
- 3 Vary primary supply voltage from 85 to 115 percent of the nominal value; if manufacturer declares extreme voltage within 85 to 115 percent of the nominal value, measured at extreme voltage declared by manufacturer.

LIMIT

According to §95.621, Each GMRS transmitter for mobile station, small base station and control station operation must be maintained within a frequency tolerance of 0.0005%. Each GMRS transmitter for base station (except small base), mobile relay station or fixed station operation must be maintained within a frequency tolerance of 0.00025%.

According to §95.625, Each FRS unit must be maintained within a frequency tolerance of 0.00025%.

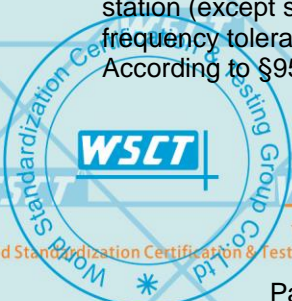



TEST RESULTS

Test conditions	Temp(°C)	Frequency error (ppm)		
		406.15 MHz	435.0000MHz	469.95MHz
Voltage Condition NV	-20	0.61	0.51	0.54
	-10	0.57	0.43	0.51
	0	0.51	0.39	0.50
	10	0.46	0.33	0.50
	20	0.36	0.26	0.46
	30	0.39	0.28	0.49
	40	0.45	0.36	0.51
	50	0.45	0.40	0.59
LV	20	0.37	0.33	0.55
HV	20	0.39	0.29	0.51
Limit(ppm)		2.50	2.50	2.50
Result		PASS	PASS	PASS

NV: Normal Voltage 7.4V
 LV: Low Voltage 6.3V
 HV: High Voltage 8.4V





4.7. Transient Frequency Behavior

6.5.2.2 of C63.26: 2015

TEST CONFIGURATION

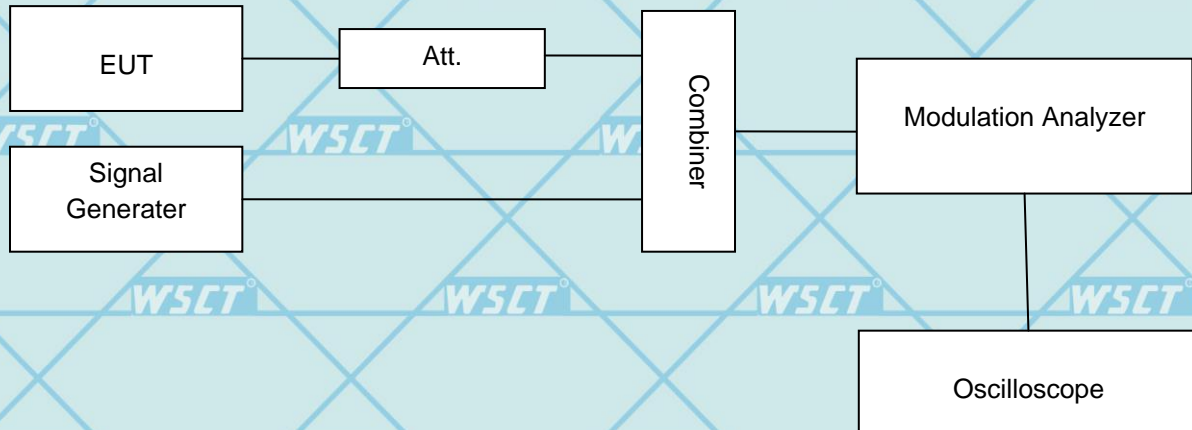

TEST PROCEDURE

1. Connect the EUT and test equipment as shown on the following block diagram.
2. Set the Spectrum Analyzer to measure FM deviation, and tune the RF frequency to the transmitter assigned frequency.
3. Set the signal generator to the assigned transmitter frequency and modulate it with a 1 kHz tone at ± 12.5 kHz deviation and set its output level to -100dBm.
4. Turn on the transmitter.
5. Supply sufficient attenuation via the RF attenuator to provide an input level to the Spectrum Analyzer that is 40 dB below the maximum allowed input power when the transmitter is operating at its rated power level. Note this power level on the Spectrum Analyzer as P0.
6. Turn off the transmitter.
7. Adjust the RF level of the signal generator to provide RF power equal to P0. This signal generator RF level shall be maintained throughout the rest of the measurement.
8. Remove the attenuation 1, so the input power to the Spectrum Analyzer is increased by 30 dB when the transmitter is turned on.
9. Adjust the vertical amplitude control of the spectrum analyzer to display the 1000 Hz at ± 4 divisions vertically centered on the display. Set trigger mode of the Spectrum Analyzer to "Video", and tune the "trigger level" on suitable level. Then set the "trigger offset" to -10ms for turn on and -15ms for turn off.
11. Turn on the transmitter and the transient wave will be captured on the screen of Spectrum Analyzer. Observe the stored display. The instant when the 1 kHz test signal is completely suppressed is considered to be ton. The trace should be maintained within the allowed divisions during the period t_1 and t_2 .
12. Then turn off the transmitter, and another transient wave will be captured on the screen of Spectrum Analyzer. The trace should be maintained within the allowed divisions during the period t_3 .



LIMIT

Time intervals	Maximum frequency difference	Requirement
		421 to 512 MHz
t1	±25.0KHz	5.0 ms
t2	±12.5KHz	20.0 ms
t3	±25.0KHz	5.0 ms





TEST RESULTS

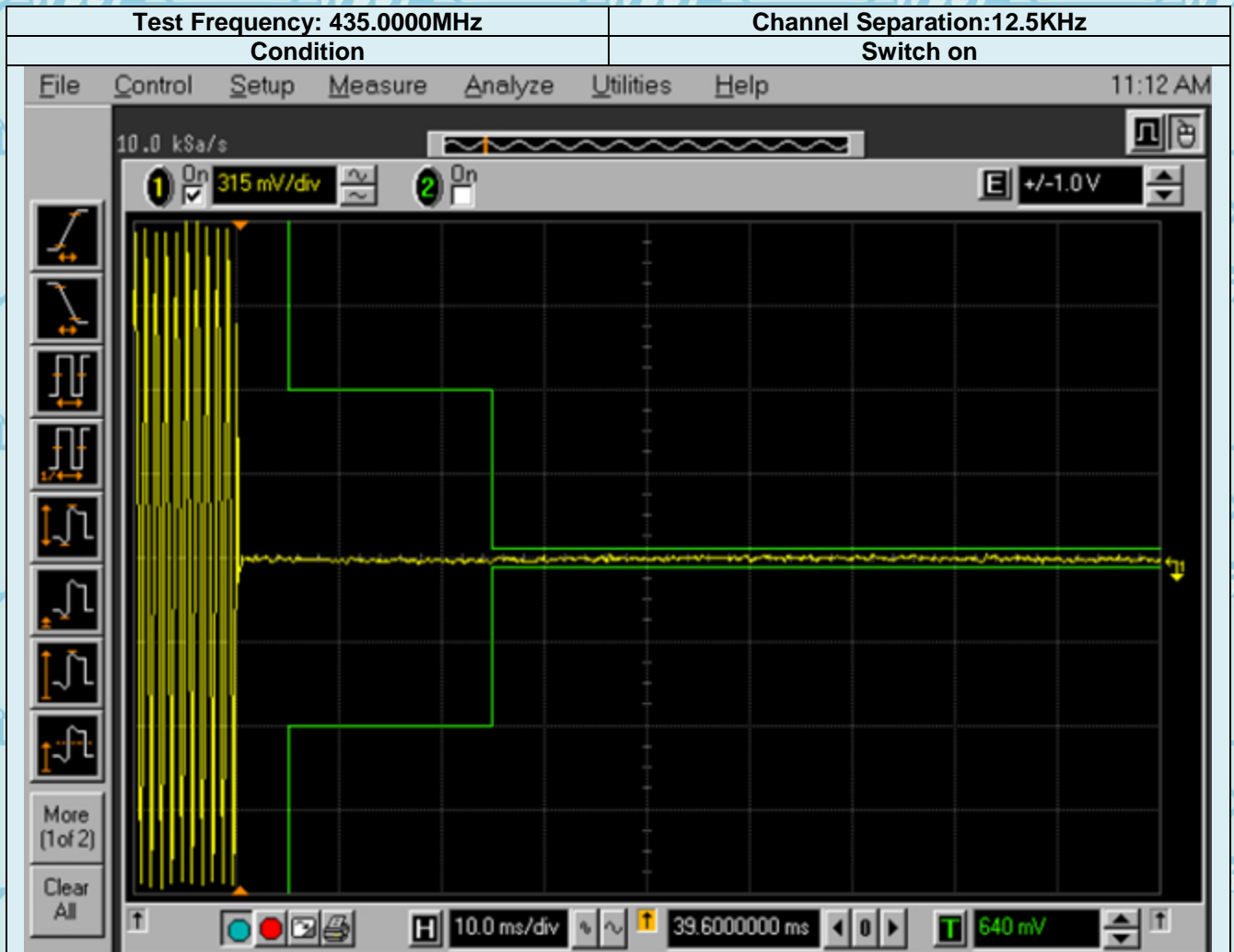

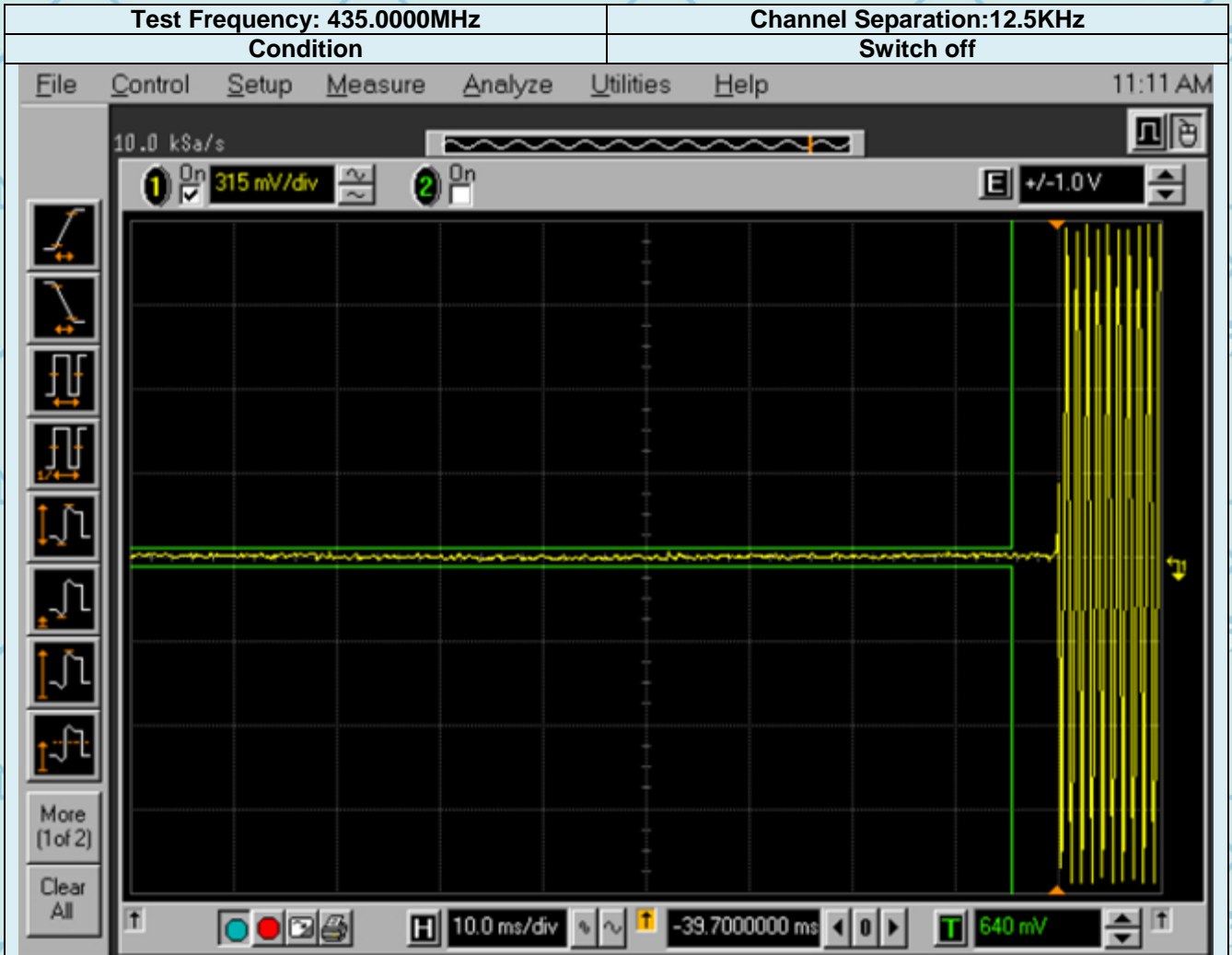

.....End of Report.....

