

RF Exposure Lab

802 N. Twin Oaks Valley Road, Suite 105 • San Marcos, CA 92069 • U.S.A.

TEL (760) 471-2100 • FAX (760) 471-2121

<http://www.rfexposurelab.com>

CERTIFICATE OF COMPLIANCE SAR EVALUATION

Juniper Systems
1132 West 1700 North
Logan, UT 84321

Dates of Test:
Test Report Number:

September 5-10, 2023
SAR.20230903
Revision B

Lab Designation Number: US1195(FCC); US0194(ISED)

FCC ID:	N7NEM75T, VSF26593, VSF27065, VSF31102
IC Certificate:	2417C-EM75T, 7980A-26593, 7980A-27065, 7980A-31102
Model(s):	MS4W
Test Sample:	Engineering Unit Same as Production
Serial Number:	356865
Equipment Type:	Wireless Rugged Tablet
Classification:	Portable Transmitter Next to Body
TX Frequency Range:	663 – 698 MHz; 699 – 716 MHz; 777 – 787 MHz; 788 – 798 MHz; 814 – 849 MHz; 902 – 928 MHz; 1710 – 1780 MHz, 1850 – 1915 MHz, 2496 – 2690 MHz
Frequency Tolerance:	± 2.5 ppm
Maximum RF Output:	750 MHz – 24.0 dBm, 850 MHz – 24.0 dBm, 900 MHz (Micro) – 31.0 dBm, 1750 MHz – 24.0 dBm, 1900 MHz (WCDMA) – 24.0 dBm, 1900 MHz (LTE) – 22.0 dBm, 2600 MHz – 24.0 dBm Conducted
Signal Modulation:	WCDMA, QPSK, 16QAM
Antenna Type:	Internal
Application Type:	Certification
FCC Rule Parts:	Part 2, 22, 24, 27
KDB Test Methodology:	KDB 447498 D01 v06, KDB 616217 D04 v01r02, KDB 941225 D01 v03r01 & D05 v02r05
Industry Canada:	RSS-102 Issue 5, Safety Code 6
Max. Stand Alone SAR Value:	1.29 W/kg Reported (1 gram); 2.03 W/kg (10 gram)
Max. Simultaneous SAR Value:	0.04 Separation Ratio (1 gram)
Maximum Power Density:	3.73 W/m ² (4 cm ²)
Separation Distance:	0 mm

This wireless mobile and/or portable device has been shown to be compliant for localized specific absorption rate (SAR) for uncontrolled environment/general exposure limits specified in ANSI/IEEE Std. C95.1-1992 and had been tested in accordance with the measurement procedures specified in IEEE 1528-2013 and IEC 62209-2:2010 (See test report).

I attest to the accuracy of the data. All measurements were performed by myself or were made under my supervision and are correct to the best of my knowledge and belief. I assume full responsibility for the completeness of these measurements and vouch for the qualifications of all persons taking them.

RF Exposure Lab, LLC certifies that no party to this application is subject to a denial of Federal benefits that includes FCC benefits pursuant to Section 5301 of the Anti-Drug Abuse Act of 1988, 21 U.S.C. 853(a).

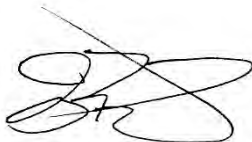

Jay M. Moulton
Vice President



Table of Contents

1. Introduction	4
SAR Definition [5]	5
2. SAR Measurement Setup	6
Robotic System	6
System Hardware	6
System Electronics	7
Probe Measurement System	7
3. Probe and Dipole Calibration	14
4. Phantom & Simulating Tissue Specifications	15
Head & Body Simulating Mixture Characterization	15
5. ANSI/IEEE C95.1 – 1992 RF Exposure Limits [2]	16
Uncontrolled Environment	16
Controlled Environment	16
6. Measurement Uncertainty	17
7. System Validation	18
Tissue Verification	18
Test System Verification	18
8. SAR Test Data Summary	19
Procedures Used To Establish Test Signal	19
Device Test Condition	19
Figure 8.1	25
WCDMA Conducted Power	26
<TDD LTE SAR Measurement>	31
9. SAR Test Results	71
10. Simultaneous Transmission Analysis	75
11. Test Equipment List	78
12. Conclusion	79
13. References	80
Appendix A – System Validation Plots and Data	81
Appendix B – SAR Test Data Plots	89
Appendix C – SAR Test Setup Photos	103
Appendix D – Probe Calibration Data Sheets	110
Appendix E – Dipole Calibration Data Sheets	120
Appendix F – DAE Calibration Data Sheets	151
Appendix G – Phantom Calibration Data Sheets	157
Appendix H – Validation Summary	159

Comment/Revision	Date
Original Release	September 21, 2023
Revision A – Correct IC ID for cellular module	November 7, 2023
Revision B – Remove FCC ID VSFMS4W and IC ID 7980A-MS4W	November 17, 2023

Note: The latest version supersedes all previous versions listed in the above table. The latest version shall be used.

1. Introduction

This measurement report shows compliance of the Juniper Systems Model MS4W FCC ID: N7NEM75T, VSF26593, VSF27065, VSF31102 with FCC Part 2, 1093, ET Docket 93-62 Rules for mobile and portable devices and IC Certificate: 2417C-EM75T, 7980A-26593, 7980A-27065, 7980A-31102 with RSS102 Issue 5 & Safety Code 6. The FCC has adopted the guidelines for evaluating the environmental effects of radio frequency radiation to protect the public and workers from the potential hazards of RF emissions due to FCC regulated portable devices. [1], [6]

The test results recorded herein are based on a single type test of Juniper Systems Model MS4W and therefore apply only to the tested sample.

The test procedures, as described in ANSI C95.1 – 1999 Standard for Safety Levels with Respect to Human Exposure to Radio Frequency Electromagnetic Fields, 3 kHz to 300 GHz [2], ANSI C95.3 – 2002 Recommended Practice for the Measurement of Potentially Hazardous Electromagnetic Fields [3], IEEE Std.1528 – 2013 Recommended Practice [4], and Industry Canada Safety Code 6 Limits of Human Exposure to Radiofrequency Electromagnetic Fields in the Frequency Range from 3kHz to 300 GHz were employed.

The following table indicates all the wireless technologies operating in the MS4W Wireless Rugged Tablet. The table also shows the tolerance for the power level for each mode.

Band	Technology	Class	3GPP Nominal Power dBm	Calibrated Nominal Power dBm	Tolerance dBm	Lower Tolerance dBm	Upper Tolerance dBm
Band 2	LTE	3	23.0	21.0	±1.0	20.0	22.0
Band 4	LTE	3	23.0	23.0	±1.0	22.0	24.0
Band 5	LTE	3	23.0	23.0	±1.0	22.0	24.0
Band 7	LTE	3	23.0	23.0	±1.0	22.0	24.0
Band 12	LTE	3	23.0	23.0	±1.0	22.0	24.0
Band 13	LTE	3	23.0	23.0	±1.0	22.0	24.0
Band 14	LTE	3	23.0	23.0	±1.0	22.0	24.0
Band 25	LTE	3	23.0	21.0	±1.0	20.0	22.0
Band 26	LTE	3	23.0	23.0	±1.0	22.0	24.0
Band 38	LTE	3	23.0	23.0	±1.0	22.0	24.0
Band 41	LTE	3	23.0	23.0	±1.0	22.0	24.0
Band 66	LTE	3	23.0	23.0	±1.0	22.0	24.0
Band 71	LTE	3	23.0	23.0	±1.0	22.0	24.0
Band 5 – 850 MHz	WCDMA/HSPA	3	23.0	23.0	±1.0	22.0	24.0
Band 4 – 1750 MHz	WCDMA/HSPA	3	23.0	23.0	±1.0	22.0	24.0
Band 2 – 1900 MHz	WCDMA/HSPA	3	23.0	23.0	±1.0	22.0	24.0
900 MHz – Micro	RFID	N/A	N/A	30.0	±1.0	29.0	31.0
WLAN – 2.4 GHz	802.11b	N/A	N/A	N/A	N/A	N/A	20.0
WLAN – 2.4 GHz	802.11g/n/ac/ax20	N/A	N/A	N/A	N/A	N/A	20.0
WLAN – 2.4 GHz	802.11n/ac/ax40	N/A	N/A	N/A	N/A	N/A	17.0
WLAN – 5 GHz	802.11a/n/ac/ax20	N/A	N/A	N/A	N/A	N/A	20.0
WLAN – 5 GHz	802.11n/ac/ax40	N/A	N/A	N/A	N/A	N/A	19.5
WLAN – 5 GHz	802.11ac/ax80	N/A	N/A	N/A	N/A	N/A	19.5
WLAN – 5 GHz	802.11ac/ax160	N/A	N/A	N/A	N/A	N/A	15.75
WLAN – 6 GHz	802.11ax20	N/A	N/A	N/A	N/A	N/A	4.5
WLAN – 6 GHz	802.11ax40	N/A	N/A	N/A	N/A	N/A	7.75
WLAN – 6 GHz	802.11ax80	N/A	N/A	N/A	N/A	N/A	10.25
WLAN – 6 GHz	802.11ax160	N/A	N/A	N/A	N/A	N/A	13.0
Bluetooth w/WiFi	802.15.1	N/A	N/A	N/A	N/A	N/A	10.0
Bluetooth Ext Range	802.15.1	N/A	N/A	19.0	±1.0	18.0	20.0

Note: Bands 42, 43 & 48 have been disabled in firmware.

SAR Definition [5]

Specific Absorption Rate is defined as the time derivative (rate) of the incremental energy (dW) absorbed by (dissipated in) an incremental mass (dm) contained in a volume element (dV) of a given density (ρ).

$$SAR = \frac{d}{dt} \left(\frac{dW}{dm} \right) = \frac{d}{dt} \left(\frac{dW}{\rho dV} \right)$$

SAR is expressed in units of watts per kilogram (W/kg). SAR can be related to the electric field at a point by

$$SAR = \frac{\sigma |E|^2}{\rho}$$

where:

σ = conductivity of the tissue (S/m)

ρ = mass density of the tissue (kg/m³)

E = rms electric field strength (V/m)

2. SAR Measurement Setup

Robotic System

These measurements are performed using the DASY52 automated dosimetric assessment system. The DASY52 is made by Schmid & Partner Engineering AG (SPEAG) in Zurich, Switzerland and consists of high precision robotics system (Staubli), robot controller, Intel Core2 computer, near-field probe, probe alignment sensor, and the generic twin phantom containing the brain equivalent material. The robot is a six-axis industrial robot performing precise movements to position the probe to the location (points) of maximum electromagnetic field (EMF) (see Fig. 2.1).

System Hardware

A cell controller system contains the power supply, robot controller teach pendant (Joystick), and a remote control used to drive the robot motors. The PC consists of the HP Intel Core2 computer with Windows XP system and SAR Measurement Software DASY52, A/D interface card, monitor, mouse, and keyboard. The Staubli Robot is connected to the cell controller to allow software manipulation of the robot. A data acquisition electronic (DAE) circuit that performs the signal amplification, signal multiplexing, AD-conversion, offset measurements, mechanical surface detection, collision detection, etc. is connected to the Electro-optical coupler (EOC). The EOC performs the conversion from the optical into digital electric signal of the DAE and transfers data to the PC plug-in card.

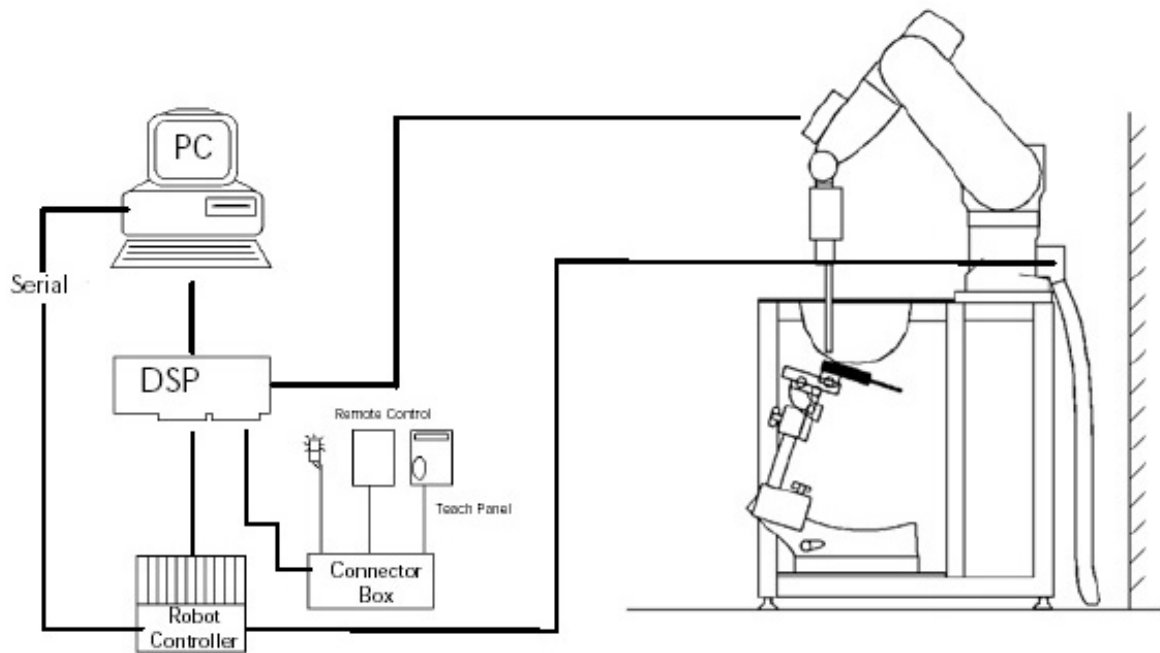

Figure 2.1 SAR Measurement System Setup

System Electronics

The DAE4 consists of a highly sensitive electrometer-grade preamplifier with auto-zeroing, a channel and gain-switching multiplexer, a fast 16 bit AD-converter and a command decoder and control logic unit. Transmission to the PC-card is accomplished through an optical downlink for data and status information and an optical uplink for commands and clock lines. The mechanical probe mounting device includes two different sensor systems for frontal and sidewise probe contacts. They are also used for mechanical surface detection and probe collision detection. The robot uses its own controller with a built in VME-bus computer. The system is described in detail in.

Probe Measurement System

The SAR measurements were conducted with the dosimetric probe EX3DV4, designed in the classical triangular configuration (see Fig. 2.2) and optimized for dosimetric evaluation. The probe is constructed using the thick film technique; with printed resistive lines on ceramic substrates. The probe is equipped with an optical multi fiber line ending at the front of the probe tip. (see Fig. 2.3) It is connected to the EOC box on the robot arm and provides an automatic detection of the phantom surface. Half of the fibers are connected to a pulsed infrared transmitter, the other half to a synchronized receiver. As the probe approaches the surface, the reflection from the surface produces a coupling from the transmitting to the receiving fibers. This reflection increases first during the approach, reaches maximum and then decreases. If the probe is flatly touching the surface, the coupling is zero. The distance of the coupling maximum to the surface is independent of the surface reflectivity and largely independent of the surface to probe angle. The DASY52 software reads the reflection during a software approach and looks for the maximum using a 2nd order fitting. The approach is stopped at reaching the maximum.



DAE System

Probe Specifications

Calibration: In air from 10 MHz to 6.0 GHz
In brain and muscle simulating tissue at Frequencies of 450 MHz, 835 MHz, 1750 MHz, 1900 MHz, 2450 MHz, 2600 MHz, 3500 MHz, 5200 MHz, 5300 MHz, 5600 MHz, 5800 MHz

Frequency: 10 MHz to 6 GHz

Linearity: ± 0.2 dB (30 MHz to 6 GHz)

Dynamic: 10 mW/kg to 100 W/kg

Range: Linearity: ± 0.2 dB

Dimensions: Overall length: 330 mm

Tip length: 20 mm

Body diameter: 12 mm

Tip diameter: 2.5 mm

Distance from probe tip to sensor center: 1 mm

Application: SAR Dosimetry Testing
Compliance tests of wireless device

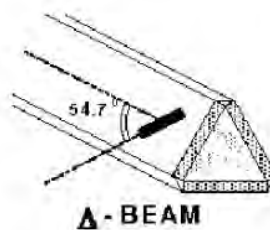

Figure 2.2 Triangular Probe Configurations



Figure 2.3 Probe Thick-Film Technique

Probe Calibration Process

Dosimetric Assessment Procedure

Each probe is calibrated according to a dosimetric assessment procedure described in with accuracy better than +/- 10%. The spherical isotropy was evaluated with the procedure described in and found to be better than +/-0.25dB. The sensitivity parameters (Norm X, Norm Y, Norm Z), the diode compression parameter (DCP) and the conversion factor (Conv F) of the probe is tested.

Free Space Assessment

The free space E-field from amplified probe outputs is determined in a test chamber. This is performed in a TEM cell for frequencies below 1 GHz, and in a waveguide above 1GHz for free space. For the free space calibration, the probe is placed in the volumetric center of the cavity at the proper orientation with the field. The probe is then rotated 360 degrees until the three channels show the maximum reading. The power density readings equates to 1 mW/cm².

Temperature Assessment *

E-field temperature correlation calibration is performed in a flat phantom filled with the appropriate simulated brain tissue. The measured free space E-field in the medium, correlates to temperature rise in a dielectric medium. For temperature correlation calibration a RF transparent thermistor based temperature probe is used in conjunction with the E-field probe

$$SAR = C \frac{\Delta T}{\Delta t}$$

$$SAR = \frac{|E|^2 \cdot \sigma}{\rho}$$

where:

where:

Δt = exposure time (30 seconds),

σ = simulated tissue conductivity,

C = heat capacity of tissue (brain or muscle),

ρ = Tissue density (1.25 g/cm³ for brain tissue)

ΔT = temperature increase due to RF exposure.

SAR is proportional to $\Delta T / \Delta t$, the initial rate of tissue heating, before thermal diffusion takes place.

Now it's possible to quantify the electric field in the simulated tissue by equating the thermally derived SAR to the E- field;

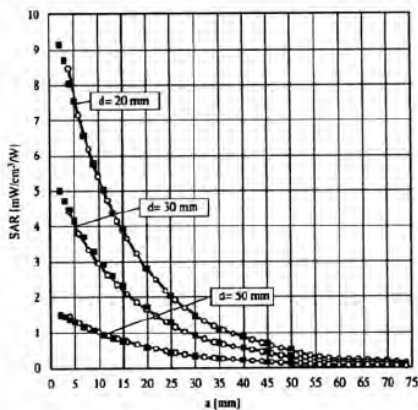

Figure 2.4 E-Field and Temperature Measurements at 900MHz

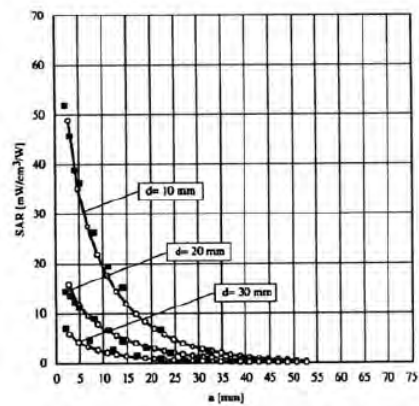

Figure 2.5 E-Field and Temperature Measurements at 1800MHz

Data Extrapolation

The DASY52 software automatically executes the following procedures to calculate the field units from the microvolt readings at the probe connector. The first step of the evaluation is a linearization of the filtered input signal to account for the compression characteristics of the detector diode. The compensation depends on the input signal, the diode type and the DC-transmission factor from the diode to the evaluation electronics. If the exciting field is pulsed, the crest factor of the signal must be known to correctly compensate for peak power. The formula for each channel can be given like below;

$$V_i = U_i + U_i^2 \cdot \frac{cf}{dcp_i}$$

with

- V_i = compensated signal of channel i (i=x,y,z)
- U_i = input signal of channel i (i=x,y,z)
- cf = crest factor of exciting field (DASY parameter)
- dcp_i = diode compression point (DASY parameter)

From the compensated input signals the primary field data for each channel can be evaluated:

E-field probes:

$$E_i = \sqrt{\frac{V_i}{Norm_i \cdot ConvF}}$$

with

- V_i = compensated signal of channel i (i = x,y,z)
- Norm_i = sensor sensitivity of channel i (i = x,y,z)
μV/(V/m)² for E-field probes
- ConvF = sensitivity of enhancement in solution
- E_i = electric field strength of channel i in V/m

The RSS value of the field components gives the total field strength (Hermetian magnitude):

$$E_{tot} = \sqrt{E_x^2 + E_y^2 + E_z^2}$$

The primary field data are used to calculate the derived field units.

$$SAR = E_{tot}^2 \cdot \frac{\sigma}{\rho \cdot 1000}$$

with

- SAR = local specific absorption rate in W/g
- E_{tot} = total field strength in V/m
- σ = conductivity in [mho/m] or [Siemens/m]
- ρ = equivalent tissue density in g/cm³

The power flow density is calculated assuming the excitation field to be a free space field.

$$P_{free} = \frac{E_{tot}^2}{3770}$$

with

- P_{pwe} = equivalent power density of a plane wave in W/cm²
- E_{tot} = total electric field strength in V/m

Scanning procedure

- The DASYS installation includes predefined files with recommended procedures for measurements and system check. They are read-only document files and destined as fully defined but unmeasured masks. All test positions (head or body-worn) are tested with the same configuration of test steps differing only in the grid definition for the different test positions.
- The „reference“ and „drift“ measurements are located at the beginning and end of the batch process. They measure the field drift at one single point in the liquid over the complete procedure. The indicated drift is mainly the variation of the DUT’s output power and should vary max. +/- 5 %.
- The highest integrated SAR value is the main concern in compliance test applications. These values can mostly be found at the inner surface of the phantom and cannot be measured directly due to the sensor offset in the probe. To extrapolate the surface values, the measurement distances to the surface must be known accurately. A distance error of 0.5mm could produce SAR errors of 6% at 1800 MHz. Using predefined locations for measurements is not accurate enough. Any shift of the phantom (e.g., slight deformations after filling it with liquid) would produce high uncertainties. For an automatic and accurate detection of the phantom surface, the DASYS5 system uses the mechanical surface detection. The detection is always at touch, but the probe will move backward from the surface the indicated distance before starting the measurement.
- The „area scan“ measures the SAR above the DUT or verification dipole on a parallel plane to the surface. It is used to locate the approximate location of the peak SAR with 2D spline interpolation. The robot performs a stepped movement along one grid axis while the local electrical field strength is measured by the probe. The probe is touching the surface of the SAM during acquisition of measurement values. The scan uses different grid spacings for different frequency measurements. Standard grid spacing for head measurements in frequency ranges ≤ 2GHz is 15 mm in x - and y- dimension. For higher frequencies a finer resolution is needed, thus for the grid spacing is reduced according the following table:

Area scan grid spacing for different frequency ranges	
Frequency range	Grid spacing
≤ 2 GHz	≤ 15 mm
2 – 4 GHz	≤ 12 mm
4 – 6 GHz	≤ 10 mm

Grid spacing and orientation have no influence on the SAR result. For special applications where the standard scan method does not find the peak SAR within the grid, e.g. mobile phones with flip cover, the grid can be adapted in orientation. Results of this coarse scan are shown in annex B.

- A „zoom scan“ measures the field in a volume around the 2D peak SAR value acquired in the previous „coarse“ scan. It uses a fine meshed grid where the robot moves the probe in steps along all the 3 axis (x,y and z-axis) starting at the bottom of the Phantom. The grid spacing for the cube measurement is varied according to the measured frequency range, the dimensions are given in the following table:

Zoom scan grid spacing and volume for different frequency ranges			
Frequency range	Grid spacing for x, y axis	Grid spacing for z axis	Minimum zoom scan volume
≤ 2 GHz	≤ 8 mm	≤ 5 mm	≥ 30 mm
2 – 3 GHz	≤ 5 mm	≤ 5 mm	≥ 28 mm
3 – 4 GHz	≤ 5 mm	≤ 4 mm	≥ 28 mm
4 – 5 GHz	≤ 4 mm	≤ 3 mm	≥ 25 mm
5 – 6 GHz	≤ 4 mm	≤ 2 mm	≥ 22 mm

DASYS is also able to perform repeated zoom scans if more than 1 peak is found during area scan. In this document, the evaluated peak 1g and 10g averaged SAR values are shown in the 2D-graphics in annex B. Test results relevant for the specified standard (see section 3) are shown in table form in section 7.

Spatial Peak SAR Evaluation

The spatial peak SAR - value for 1 and 10 g is evaluated after the Cube measurements have been done. The basis of the evaluation are the SAR values measured at the points of the fine cube grid consisting of all points in the three directions x, y and z. The algorithm that finds the maximal averaged volume is separated into three different stages.

- The data between the dipole center of the probe and the surface of the phantom are extrapolated. This data

cannot be measured since the center of the dipole is 1 to 2.7 mm away from the tip of the probe and the distance between the surface and the lowest measuring point is about 1 mm (see probe calibration sheet). The extrapolated data from a cube measurement can be visualized by selecting 'Graph Evaluated'.

- The maximum interpolated value is searched with a straight-forward algorithm. Around this maximum the SAR - values averaged over the spatial volumes (1g or 10 g) are computed using the 3d-spline interpolation algorithm. If the volume cannot be evaluated (i.e., if a part of the grid was cut off by the boundary of the measurement area) the evaluation will be started on the corners of the bottom plane of the cube.
- All neighbouring volumes are evaluated until no neighbouring volume with a higher average value is found.

Extrapolation

The extrapolation is based on a least square algorithm [W. Gander, Computermathematik, p.168-180]. Through the points in the first 3 cm along the z-axis, polynomials of order four are calculated. These polynomials are then used to evaluate the points between the surface and the probe tip. The points, calculated from the surface, have a distance of 1 mm from each other.

Interpolation

The interpolation of the points is done with a 3d-Spline. The 3d-Spline is composed of three one-dimensional splines with the "Not a knot"-condition [W. Gander, Computermathematik, p.141-150] (x, y and z -direction) [Numerical Recipes in C, Second Edition, p.123ff].

Volume Averaging

At First the size of the cube is calculated. Then the volume is integrated with the trapezoidal algorithm. 8000 points (20x20x20) are interpolated to calculate the average.

Advanced Extrapolation

DASY uses the advanced extrapolation option which is able to compensate boundary effects on E-field probes.

SAM PHANTOM

The SAM Twin Phantom V4.0 is constructed of a fiberglass shell integrated in a wooden table. The shape of the shell is based on data from an anatomical study designed to determine the maximum exposure in at least 90% of all users. It enables the dosimetric evaluation of left and right hand phone usage as well as body mounted usage at the flat phantom region. A cover prevents the evaporation of the liquid. Reference markings on the Phantom allow the complete setup of all predefined phantom positions and measurement grids by manually teaching three points in the robot. (see Fig. 2.6)

Phantom Specification

Phantom: SAM Twin Phantom (V4.0)
Shell Material: Vivac Composite
Thickness: 2.0 ± 0.2 mm

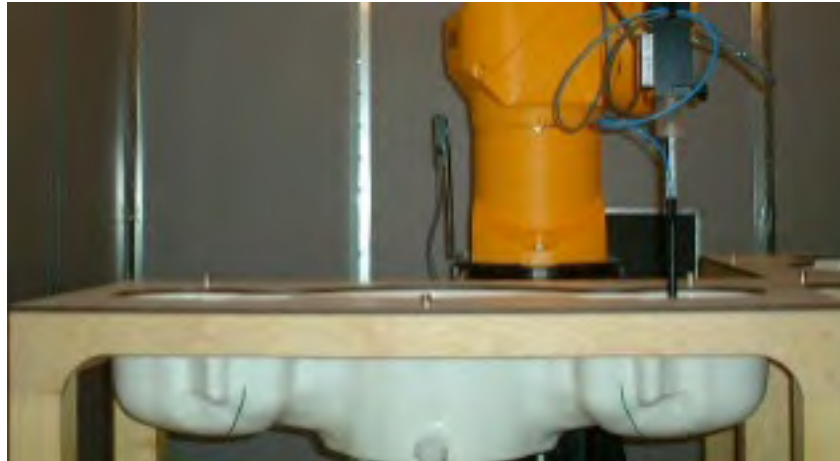

Figure 2.6 SAM Twin Phantom

Device Holder for Transmitters

In combination with the SAM Twin Phantom V4.0 the Mounting Device (see Fig. 2.7), enables the rotation of the mounted transmitter in spherical coordinates whereby the rotation point is the ear opening. The devices can be easily, accurately, and repeat ably be positioned according to the FCC, CENELEC, IEC and IEEE specifications. The device holder can be locked at different phantom locations (left head, right head, flat phantom).



Figure 2.7 Mounting Device

Note: A simulating human hand is not used due to the complex anatomical and geometrical structure of the hand that may produce infinite number of configurations. To produce the worst-case condition (the hand absorbs antenna output power), the hand is omitted during the tests.

3. Probe and Dipole Calibration

See Appendix D and E.

4. Phantom & Simulating Tissue Specifications

Head & Body Simulating Mixture Characterization

The head mixture consists of the material based on the table listed below. The mixture is calibrated to obtain proper dielectric constant (permittivity) and conductivity of the desired tissue.

Table 4.1 Typical Composition of Ingredients for Tissue

Ingredients		Simulating Tissue				
		750 MHz Head	835/900 MHz Head	1750 MHz Head	1950 MHz Head	2550 MHz Head
Mixing Percentage						
Water		Proprietary Purchased From Speag				
Sugar						
Salt						
HEC						
Bactericide						
DGBE						
Dielectric Constant	Target	41.94	41.52/41.50	40.08	40.00	39.07
Conductivity (S/m)	Target	0.89	0.91/0.97	1.37	1.40	1.91

5. ANSI/IEEE C95.1 – 1992 RF Exposure Limits [2]

Uncontrolled Environment

Uncontrolled Environments are defined as locations where there is the exposure of individuals who have no knowledge or control of their exposure. The general population/uncontrolled exposure limits are applicable to situations in which the general public may be exposed or in which persons who are exposed as a consequence of their employment may not be made fully aware of the potential for exposure or cannot exercise control over their exposure. Members of the general public would come under this category when exposure is not employment-related; for example, in the case of a wireless transmitter that exposes persons in its vicinity.

Controlled Environment

Controlled Environments are defined as locations where there is exposure that may be incurred by persons who are aware of the potential for exposure, (i.e. as a result of employment or occupation). In general, occupational/controlled exposure limits are applicable to situations in which persons are exposed as a consequence of their employment, who have been made fully aware of the potential for exposure and can exercise control over their exposure. This exposure category is also applicable when the exposure is of a transient nature due to incidental passage through a location where the exposure levels may be higher than the general population/uncontrolled limits, but the exposed person is fully aware of the potential for exposure and can exercise control over his or her exposure by leaving the area or by some other appropriate means.

Table 5.1 Human Exposure Limits

	UNCONTROLLED ENVIRONMENT General Population (W/kg) or (mW/g)	CONTROLLED ENVIROMENT Professional Population (W/kg) or (mW/g)
SPATIAL PEAK SAR ¹ Head	1.60	8.00
SPATIAL AVERAGE SAR ² Whole Body	0.08	0.40
SPATIAL PEAK SAR ³ Hands, Feet, Ankles, Wrists	4.00	20.00

¹ The Spatial Peak value of the SAR averaged over any 1 gram of tissue (defined as a tissue volume in the shape of a cube) and over the appropriate averaging time.

² The Spatial Average value of the SAR averaged over the whole body.

³ The Spatial Peak value of the SAR averaged over any 10 grams of tissue (defined as a tissue volume in the shape of a cube) and over the appropriate averaging time.

6. Measurement Uncertainty

Measurement uncertainty table is not required per KDB 865664 D01 v01 section 2.8.2 page 12. SAR measurement uncertainty analysis is required in the SAR report only when the highest measured SAR in a frequency band is ≥ 1.5 W/kg for 1-g SAR. The equivalent ratio (1.5/1.6) should be applied to extremity and occupational exposure conditions. The highest reported value is less than 1.5 W/kg. Therefore, the measurement uncertainty table is not required.

7. System Validation

Tissue Verification

Table 7.1 Measured Tissue Parameters

		750 MHz Head		900 MHz Head		1750 MHz Head	
Date(s)		Sep. 5, 2023		Sep. 6, 2023		Sep. 8, 2023	
Liquid Temperature (°C)	20.0	Target	Measured	Target	Measured	Target	Measured
Dielectric Constant: ϵ		41.94	40.89	41.50	40.86	40.08	39.39
Conductivity: σ		0.89	0.92	0.97	1.00	1.37	1.39
		1900 MHz Head		2550 MHz Head			
Date(s)		Sep. 8, 2023		Sep. 10, 2023			
Liquid Temperature (°C)	20.0	Target	Measured	Target	Measured		
Dielectric Constant: ϵ		40.00	39.65	39.08	38.69		
Conductivity: σ		1.40	1.42	1.91	1.93		

See Appendix A for data printout.

Test System Verification

Prior to assessment, the system is verified to the $\pm 10\%$ of the specifications at the test frequency by using the system kit. Power is normalized to 1 watt. (Graphic Plots Attached)

Table 7.2 System Dipole Validation Target & Measured

	Test Frequency	Targeted SAR _{1g} (W/kg)	Measure SAR _{1g} (W/kg)	Tissue Used for Verification	Deviation (%)	Plot Number
05-Sep-2023	750 MHz	8.57	8.56	Head	- 0.12	1
06-Sep-2023	900 MHz	11.20	11.70	Head	+ 4.46	2
08-Sep-2023	1750 MHz	37.70	37.70	Head	+ 0.00	3
08-Sep-2023	1900 MHz	40.40	41.70	Head	+ 3.22	4
10-Sep-2023	2550 MHz	55.30	56.60	Head	+ 2.35	6

See Appendix A for data plots.

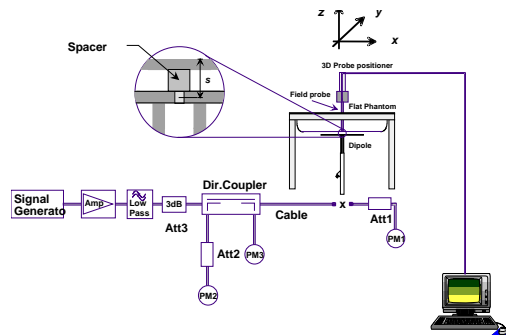

Figure 7.1 Dipole Validation Test Setup

8. SAR Test Data Summary

See Measurement Result Data Pages

See Appendix B for SAR Test Data Plots.
 See Appendix C for SAR Test Setup Photos.

Procedures Used To Establish Test Signal

The device was either placed into simulated transmit mode using the manufacturer’s test codes or the actual transmission is activated through a base station simulator or similar equipment. See data pages for actual procedure used in measurement.

Device Test Condition

In order to verify that the device was tested at full power, conducted output power measurements were performed before and after each SAR measurement to confirm the output power unless otherwise noted. If a conducted power deviation of more than 5% occurred, the test was repeated. The power drift of each test is measured at the start of the test and again at the end of the test. The drift percentage is calculated by the formula $((end/start)-1)*100$ and rounded to three decimal places. The drift percentage is calculated into the resultant SAR value on the data sheet for each test.

Required Test Positions						
Antenna	Back	Front	Right	Left	Top	Bottom
Main	Yes	No	Yes	No	No	No

The testing was conducted on all edges closest to each antenna. The back and right side was tested for the WWAN antenna. The remaining sides were not tested as the WWAN antenna was more than 2.5 cm from the side. All further test reductions are shown on page 70 for WCDMA bands and page 70 for LTE bands. See the photo in Appendix C for a pictorial of the setups and antenna locations.

When the device’s antenna is within a certain distance of the user, the sensor activates and reduces the maximum allowed output power. However, the sensor is not active when the device is moved beyond the sensor triggering distance and the maximum output power is no longer limited. Therefore, additional evaluation is needed in the vicinity of the triggering distance to ensure SAR is compliant when the device is allowed to operate at a non-reduced output power level. FCC KDB Publication 616217 D04v01r02 Section 6 was used as a guideline for selecting SAR test distances for this device at these additional test positions. Sensor triggering distance summary data is included below.

The sensor is designed to support sufficient detection range and sensitivity to cover regions of the sensors in all applicable directions since the sensor entirely covers the antennas. The device form factor will not allow the device to be sitting at an angle. Therefore, tilt measurements were not conducted on this device.

Per the May 2017 TCBC Workshop Notes, demonstration of proper functioning of the power reduction mechanisms is required to support the corresponding SAR configurations. The verification process was divided into two parts: (1) evaluation of the output power levels for individual or multiple triggering mechanisms and (2) evaluation of the triggering distances for proximity-based sensors.

8.1 Power Verification Procedure

The power verification was performed according to the following procedure.

- A base station simulator was used to establish a conducted RF connection and the output power was monitored. The power measurements were confirmed to be within the expected tolerances for all states before and after a power reduction mechanism was triggered.
- Step 1 was repeated for all relevant modes and frequency bands for the mechanism being investigated.
- Steps 1 and 2 were repeated for all individual power reduction mechanisms and combinations thereof. For the combination cases, one mechanism was switched to a “triggered” state at a time; powers were confirmed to be within the tolerances after each additional mechanism was activated.

8.2 Distance Verification Procedure

The distance verification procedure was performed according to the following procedure.

- A base station simulator was used to establish an RF connection and to monitor the power levels. The device being tested was placed below the relevant section of the phantom with the relevant side or edge of the device facing toward the phantom.
- The device was moved toward and away from the phantom to determine the distance at which the mechanism triggers and the output power is reduced, per KDB Publication 616217 D04v01r02 and FCC Guidance. Each applicable test position was evaluated. The distances were confirmed to be the same or larger (more conservative) than the minimum distances provided by the manufacturer.
- Steps 1 and 2 were repeated for low, mid and high bands, as appropriate.
- Steps 1 through 3 were repeated for all distance-based power reduction mechanisms.

8.3 WWAN Antenna Verification Summary

**Table 8.1
Power Measurement Verification for WWAN Antenna**

Mechanism	Mode/Band	Conducted Power (dBm)	
		Un-triggered (Max)	Mechanism #1 (Reduced)
Capacitive	LTE FDD Band 2	23.4	20.5
	LTE FDD Band 25	24.0	20.5

**Table 9.2
Distance Measurement Verification for WWAN Antenna**

Mechanism	Test Condition	Band	Distance Measurements (mm)		Minimum Distance per Manufacturer (mm)
			Moving Toward	Moving Away	
Capacitive	Back	Mid	9	8	8
	Right	Mid	8	9	8

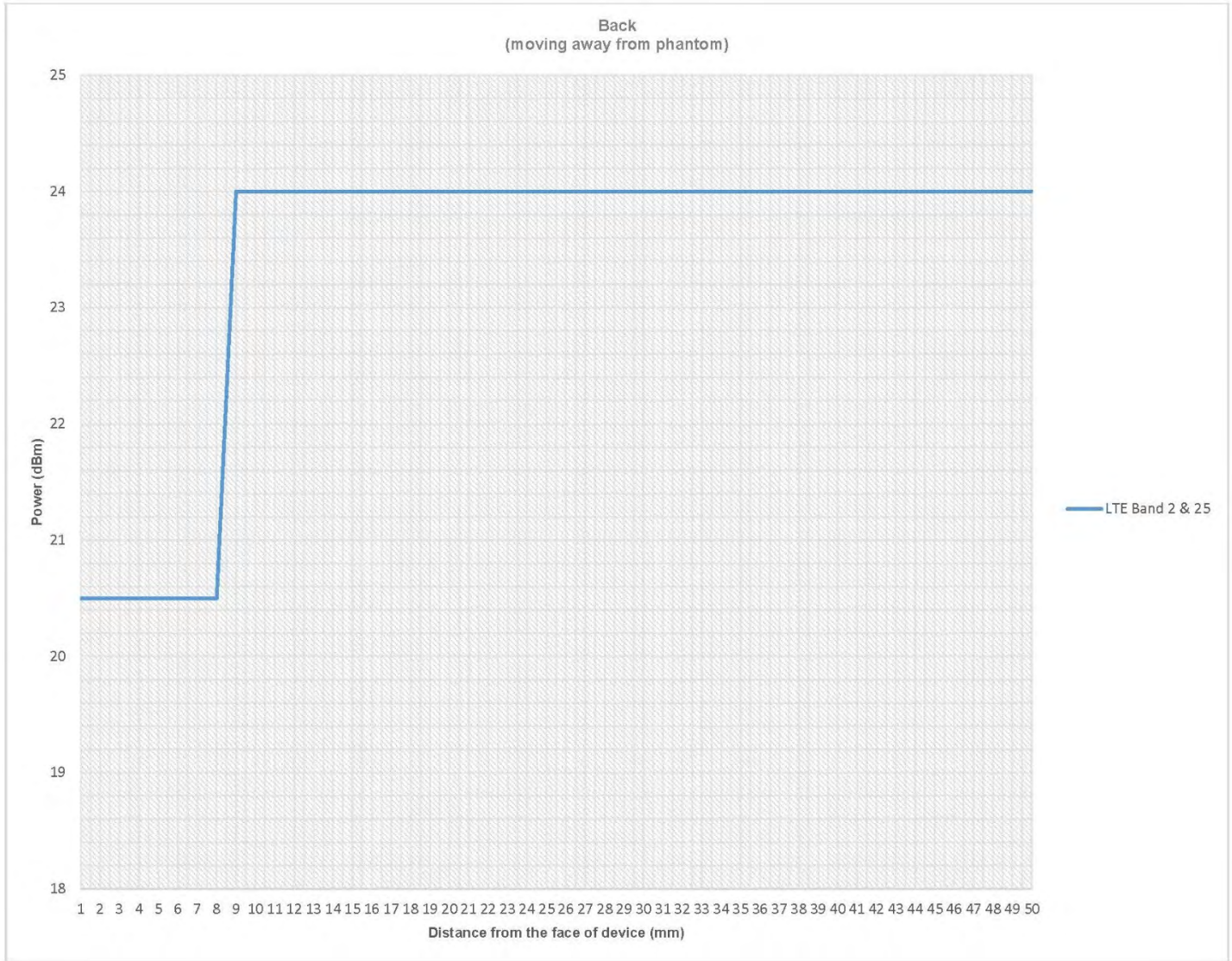

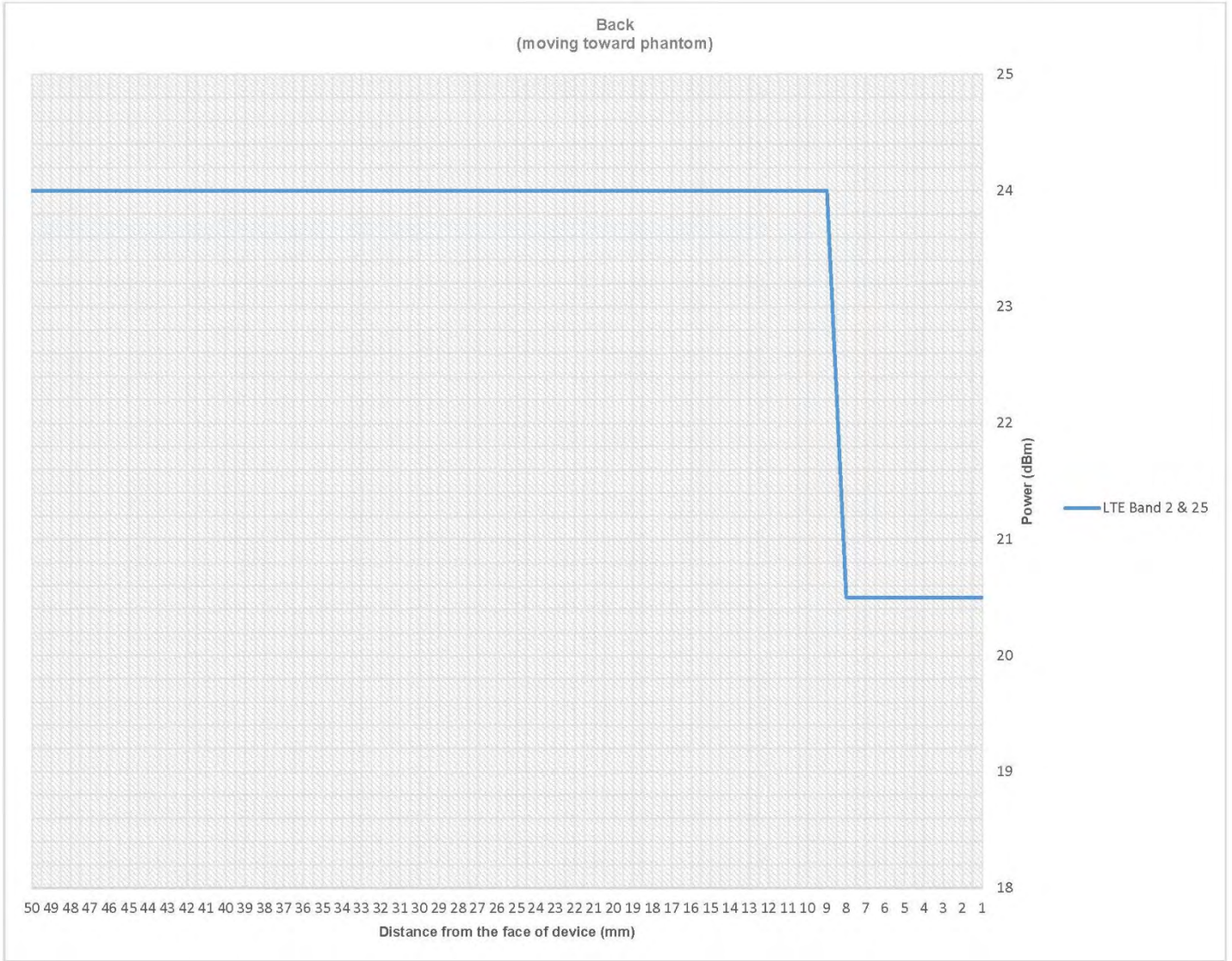

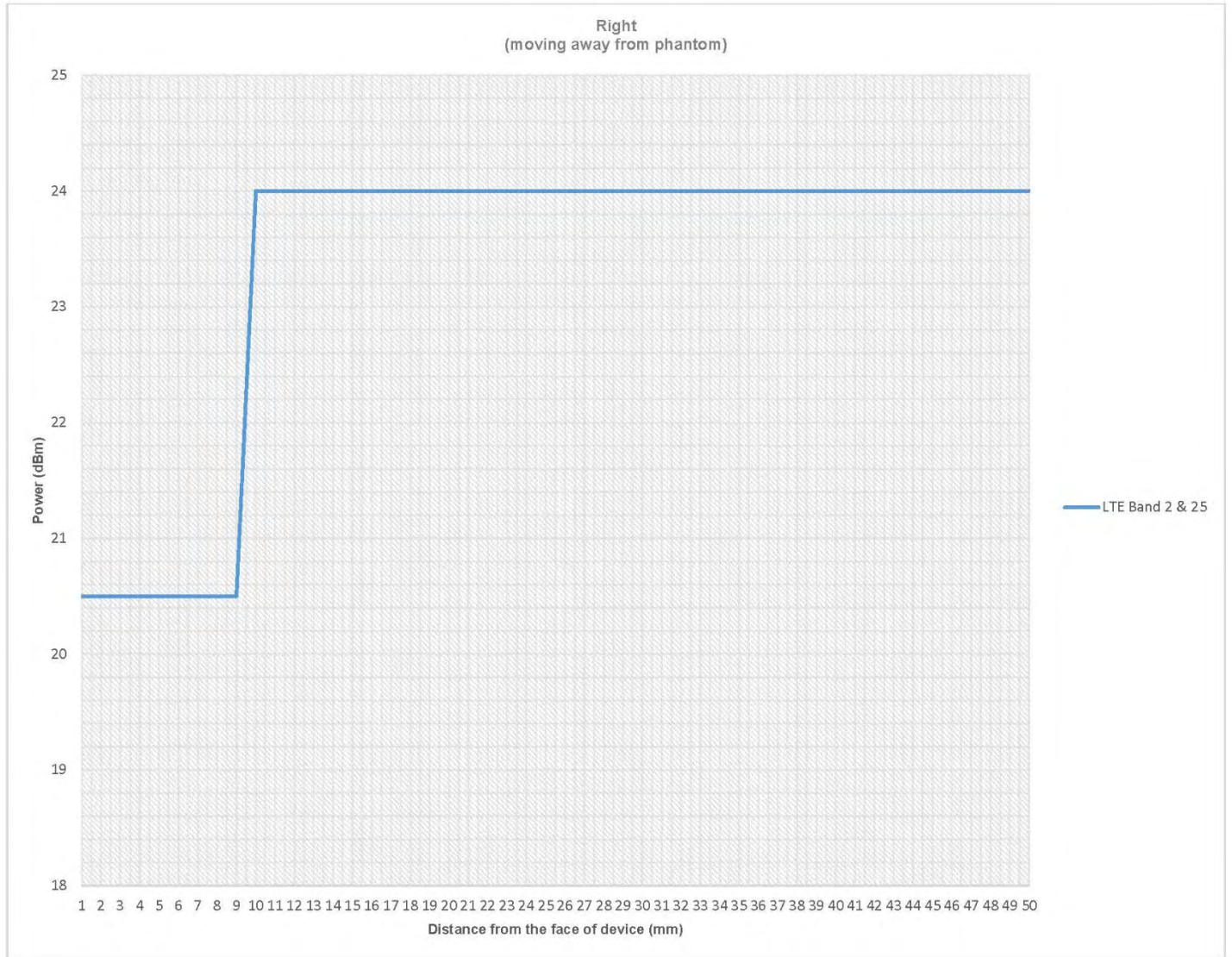

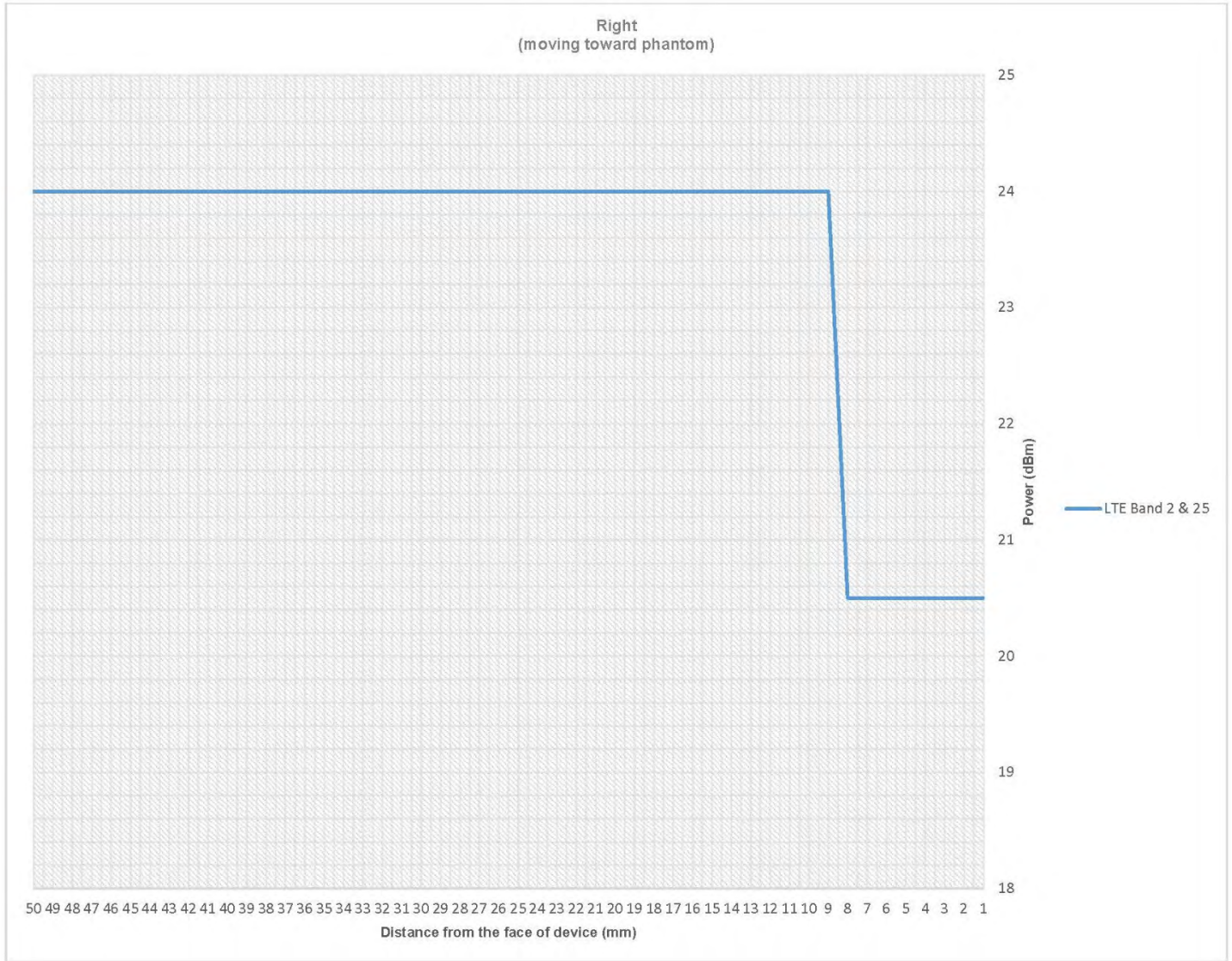
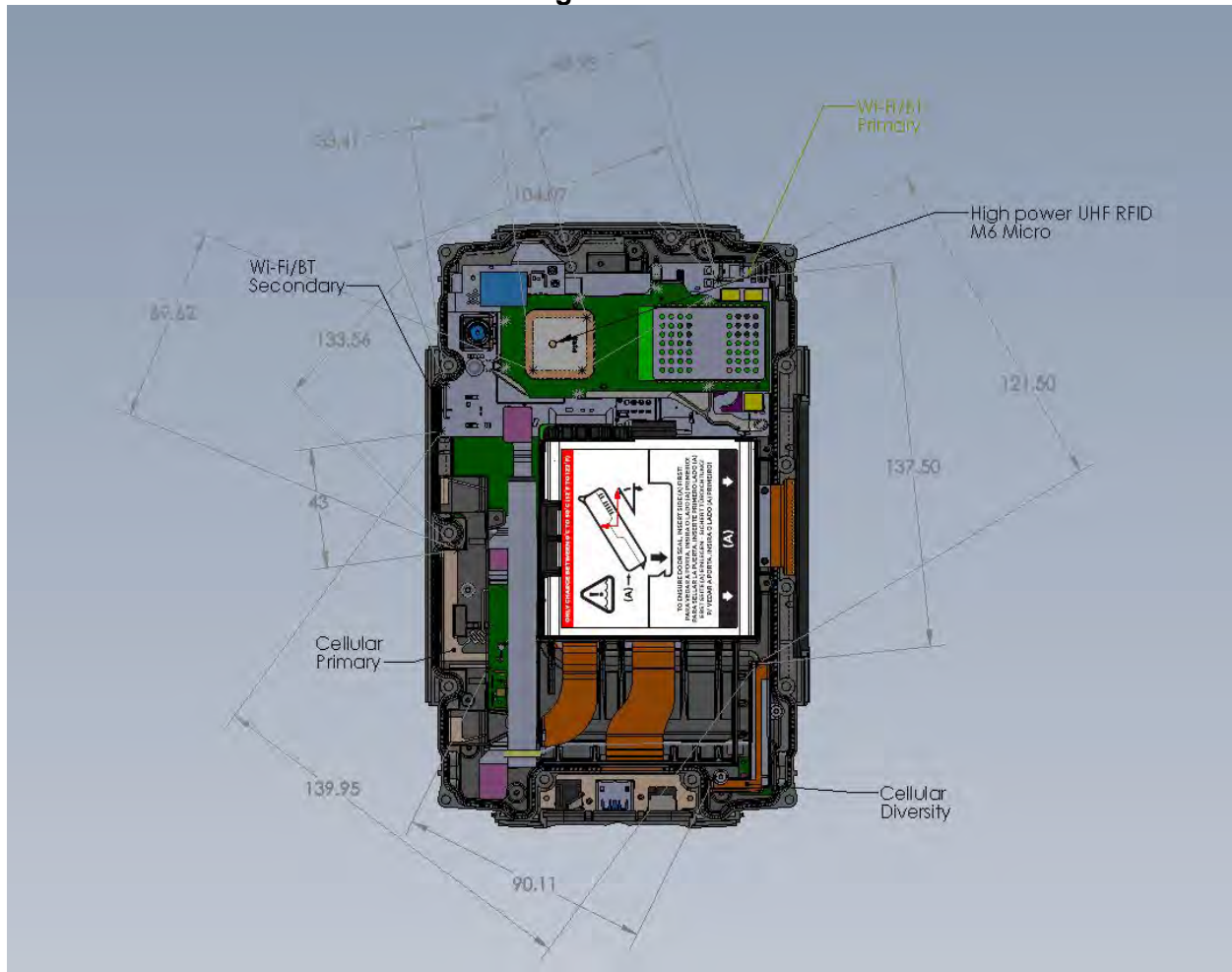

Figure 8.1
SAR Location Diagram of Antenna Distances



Antenna Distances

Cellular, WiFi and Micro RFID Configuration

WCDMA Conducted Power

1. The following tests were conducted according to the test requirements outlines in 3GPP TS 34.121 specification.
2. The procedures in KDB 941225 D01v03r01 are applied for 3GPP Rel. 6 HSPA to configure the device in the required sub-test mode(s) to determine SAR test exclusion.
3. For DC-HSDPA, the device was configured according to the H-Set 12, Fixed Reference Channel (FRC) configuration in Table C.8.1.12 of 3GPP TS 34.121-1, with the primary and the secondary serving HS-DSCH Cell enabled during the power measurement.

A summary of these settings are illustrated below:

HSDPA SETUP CONFIGURATION:

- a. The EUT was connected to Base Station Agilent E5515C referred to the Setup Configuration.
- b. The RF path losses were compensated into the measurements.
- c. A call was established between EUT and Base Station with following setting:
 - i. Set Gain Factors (β_c and β_d) and parameters were set according to each
 - ii. Specific sub-test in the following table, C10.1.4, quoted from the TS 34.121
 - iii. Set RMC 12.2Kbps + HSDPA mode.
 - iv. Set Cell Power = -86 dBm
 - v. Set HS-DSCH Configuration Type to FRC (H-set 1, QPSK)
 - vi. Select HSDPA Uplink Parameters
 - vii. Set Delta ACK, Delta NACK and Delta CQI = 8
 - viii. Set Ack-Nack Repetition Factor to 3
 - ix. Set CQI Feedback Cycle (k) to 4 ms
 - x. Set CQI Repetition Factor to 2
 - xi. Power Ctrl Mode = All Up bits
- d. The transmitted maximum output power was recorded.

Table C.10.1.4: β values for transmitter characteristics tests with HS-DPCCH

Sub-test	β_c	β_d	β_d (SF)	β_o/β_d	β_{HS} (Note 1, Note 2)	CM (dB) (Note 3)	MPR (dB) (Note 3)
1	2/15	15/15	64	2/15	4/15	0.0	0.0
2	12/15 (Note 4)	15/15 (Note 4)	64	12/15 (Note 4)	24/15	1.0	0.0
3	15/15	8/15	64	15/8	30/15	1.5	0.5
4	15/15	4/15	64	15/4	30/15	1.5	0.5

Note 1: $\Delta_{ACK}, \Delta_{NACK}$ and $\Delta_{CQI} = 30/15$ with $\beta_{HS} = 30/15 * \beta_c$.

Note 2: For the HS-DPCCH power mask requirement test in clause 5.2C, 5.7A, and the Error Vector Magnitude (EVM) with HS-DPCCH test in clause 5.13.1A, and HSDPA EVM with phase discontinuity in clause 5.13.1AA, Δ_{ACK} and $\Delta_{NACK} = 30/15$ with $\beta_{HS} = 30/15 * \beta_c$, and $\Delta_{CQI} = 24/15$ with $\beta_{HS} = 24/15 * \beta_c$.

Note 3: CM = 1 for $\beta_o/\beta_d = 12/15$, $\beta_{HS}/\beta_c = 24/15$. For all other combinations of DPDCH, DPCCH and HS-DPCCH the MPR is based on the relative CM difference. This is applicable for only UEs that support HSDPA in release 6 and later releases.

Note 4: For subtest 2 the β_o/β_d ratio of 12/15 for the TFC during the measurement period (TF1, TF0) is achieved by setting the signalled gain factors for the reference TFC (TF1, TF1) to $\beta_c = 11/15$ and $\beta_d = 15/15$.

SETUP CONFIGURATION

HSUPA SETUP CONFIGURATION:

- a. The EUT was connected to Base Station Agilent E5515C referred to the Setup Configuration.
- b. The RF path losses were compensated into the measurements.
- c. A call was established between EUT and Base Station with following setting * :
 - i. Call Configs = 5.2B, 5.9B, 5.10B, and 5.13.2B with QPSK
 - ii. Set the Gain Factors (β_c and β_d) and parameters (AG Index) were set according to each specific sub-test in the following table, C11.1.3, quoted from the TS 34.121
 - iii. Set Cell Power = -86 dBm
 - iv. Set Channel Type = 12.2k + HSPA
 - v. Set UE Target Power
 - vi. Power Ctrl Mode= Alternating bits
 - vii. Set and observe the E-TFCl
 - viii. Confirm that E-TFCl is equal to the target E-TFCl of 75 for sub-test 1, and other subtest's E-TFCl
- d. The transmitted maximum output power was recorded.

Table C.11.1.3: β values for transmitter characteristics tests with HS-DPCCH and E-DCH

Sub-test	β_c	β_d	β_d (SF)	β_c/β_d	β_{HS} (Note 1)	β_{ec}	β_{ed} (Note 4) (Note 5)	β_{ed} (SF)	β_{ed} (Codes)	CM (dB) (Note 2)	MPR (dB) (Note 2) (Note 6)	AG Index (Note 5)	E-TFCl
1	11/15 (Note 3)	15/15 (Note 3)	64	11/15 (Note 3)	22/15	209/25	1309/225	4	1	1.0	0.0	20	75
2	6/15	15/15	64	6/15	12/15	12/15	94/75	4	1	3.0	2.0	12	67
3	15/15	9/15	64	15/9	30/15	30/15	β_{ed1} : 47/15 β_{ed2} : 47/15	4 4	2	2.0	1.0	15	92
4	2/15	15/15	64	2/15	4/15	2/15	56/75	4	1	3.0	2.0	17	71
5	15/15	0	-	-	5/15	5/15	47/15	4	1	1.0	0.0	12	67

Note 1: For sub-test 1 to 4, Δ_{ACK} , Δ_{NACK} and $\Delta_{COI} = 30/15$ with $\beta_{hs} = 30/15 * \beta_c$. For sub-test 5, Δ_{ACK} , Δ_{NACK} and $\Delta_{COI} = 5/15$ with $\beta_{hs} = 5/15 * \beta_c$.

Note 2: CM = 1 for $\beta_c/\beta_d = 12/15$, $\beta_{hs}/\beta_c = 24/15$. For all other combinations of DPDCH, DPCCH, HS-DPCCH, E-DPDCH and E-DPCCH the MPR is based on the relative CM difference.

Note 3: For subtest 1 the β_c/β_d ratio of 11/15 for the TFC during the measurement period (TF1, TF0) is achieved by setting the signalled gain factors for the reference TFC (TF1, TF1) to $\beta_c = 10/15$ and $\beta_d = 15/15$.

Note 4: In case of testing by UE using E-DPDCH Physical Layer category 1, Sub-test 3 is omitted according to TS25.306 Table 5.1g.

Note 5: β_{ed} can not be set directly; it is set by Absolute Grant Value.

Note 6: For subtests 2, 3 and 4, UE may perform E-DPDCH power scaling at max power which could results in slightly smaller MPR values.

SETUP CONFIGURATION

DC-HSDPA 3GPP RELEASE 8 SETUP CONFIGURATION:

- a. The EUT was connected to Base Station Agilent E5515C referred to the Setup Configuration below
- b. The RF path losses were compensated into the measurements.
- c. A call was established between EUT and Base Station with following setting:
 - i. Set RMC 12.2Kbps + HSDPA mode.
 - ii. Set Cell Power = -25 dBm
 - iii. Set HS-DSCH Configuration Type to FRC (H-set 12, QPSK)
 - iv. Select HSDPA Uplink Parameters
 - v. Set Gain Factors (β_c and β_d) and parameters were set according to each Specific sub-test in the following table,
C10.1.4, quoted from the TS
34.121 a). Subtest 1:
 $\beta_c/\beta_d=2/15$
b). Subtest 2:
 $\beta_c/\beta_d=12/15$ c).
Subtest 3: $\beta_c/\beta_d=15/8$
d). Subtest 4:
 $\beta_c/\beta_d=15/4$
 - vi. Set Delta ACK, Delta NACK and Delta CQI = 8
 - vii. Set Ack-Nack Repetition Factor to 3
 - viii. Set CQI Feedback Cycle (k) to 4 ms
 - ix. Set CQI Repetition Factor to 2
 - x. Power Ctrl Mode = All Up bits
- d. The transmitted maximum output power was recorded.

The following tests were conducted according to the test requirements outlines in 3GPP TS 34.121 specification. A summary of these settings are illustrated below:

C.8.1.12 Fixed Reference Channel Definition H-Set 12

Table C.8.1.12: Fixed Reference Channel H-Set 12

Parameter	Unit	Value
Nominal Avg. Inf. Bit Rate	kbps	60
Inter-TTI Distance	TTI's	1
Number of HARQ Processes	Processes	6
Information Bit Payload (N_{inf})	Bits	120
Number Code Blocks	Blocks	1
Binary Channel Bits Per TTI	Bits	960
Total Available SML's in UE	SML's	19200
Number of SML's per HARQ Proc.	SML's	3200
Coding Rate		0.15
Number of Physical Channel Codes	Codes	1
Modulation		QPSK
Note 1: The RMC is intended to be used for DC-HSDPA mode and both cells shall transmit with identical parameters as listed in the table. Note 2: Maximum number of transmission is limited to 1, i.e., retransmission is not allowed. The redundancy and constellation version 0 shall be used.		

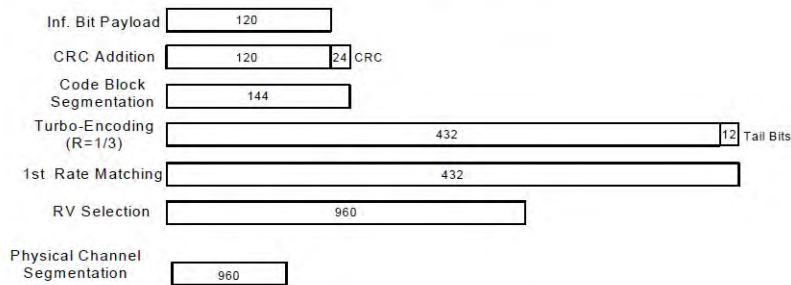

Figure C.8.19: Coding rate for Fixed reference Channel H-Set 12 (QPSK)

SETUP CONFIGURATION

<WCDMA Conducted Power>

GENERAL NOTE:

- Per KDB 941225 D01v03r01, for SAR testing is measured using a 12.2 kbps RMC with TPC bits configured to all "1's".
- Per KDB 941225 D01v03r01, RMC 12.2kbps setting is used to evaluate SAR. The maximum output power and tune-up tolerance specified for production units in HSDPA / HSUPA / DC-HSDPA is $\leq \frac{1}{4}$ dB higher than RMC 12.2Kbps or when the highest reported SAR of the RMC12.2Kbps is scaled by the ratio of specified maximum output power and tune-up tolerance of HSDPA / HSUPA / DC-HSDPA to RMC12.2Kbps and the adjusted SAR is ≤ 1.2 W/kg, SAR measurement is not required for HSDPA / HSUPA / DC-HSDPA, and according to the following RF output power, the output power results of the secondary modes (HSUPA, HSDPA, DC-HSDPA) are less than $\frac{1}{4}$ dB higher than the primary modes; therefore, SAR measurement is not required for HSDPA / HSUPA / DC-HSDPA.

Full Power

Band		WCDMA II			Tune-up Limit (dBm)	WCDMA IV			Tune-up Limit (dBm)	WCDMA V			Tune-up Limit (dBm)
TX Channel		9262	9400	9538		1312	1413	1513		4132	4182	4233	
Rx Channel		9662	9800	9938	1537	1638	1738	4357	4407	4458			
Frequency (MHz)		1852.4	1880	1907.6	1712.4	1732.6	1752.6	826.4	836.4	846.6			
3GPP Rel 99	AMR 12.2Kbps	23.70	23.79	23.67	24.00	23.88	23.65	23.51	24.00	23.59	23.54	23.89	24.00
3GPP Rel 99	RMC 12.2Kbps	23.87	23.98	23.61	24.00	23.87	23.93	23.73	24.00	23.94	23.98	23.87	24.00
3GPP Rel 6	HSDPA Subtest-1	22.55	22.75	22.58	23.00	22.96	22.66	22.77	23.00	22.99	22.79	22.66	23.00
3GPP Rel 6	HSDPA Subtest-2	22.57	22.70	22.85	23.00	22.90	22.66	22.66	23.00	22.51	22.94	22.76	23.00
3GPP Rel 6	HSDPA Subtest-3	23.32	23.18	23.10	23.50	23.31	23.05	23.33	23.50	23.30	23.23	23.34	23.50
3GPP Rel 6	HSDPA Subtest-4	23.48	23.25	23.32	23.50	23.14	23.40	23.17	23.50	23.28	23.27	23.02	23.50
3GPP Rel 8	DC-HSDPA Subtest-1	22.74	22.80	22.77	23.00	22.76	22.90	22.90	23.00	22.73	22.67	22.85	23.00
3GPP Rel 8	DC-HSDPA Subtest-2	22.78	22.78	22.72	23.00	22.58	22.62	22.73	23.00	22.79	22.66	22.84	23.00
3GPP Rel 8	DC-HSDPA Subtest-3	23.37	23.08	23.25	23.50	23.23	23.04	23.45	23.50	23.30	23.48	23.30	23.50
3GPP Rel 8	DC-HSDPA Subtest-4	23.01	23.11	23.01	23.50	23.45	23.30	23.29	23.50	23.06	23.37	23.31	23.50
3GPP Rel 6	HSUPA Subtest-1	22.52	22.97	22.63	23.00	22.79	22.70	22.55	23.00	22.86	22.54	22.77	23.00
3GPP Rel 6	HSUPA Subtest-2	20.61	20.84	20.77	21.00	20.55	20.59	20.92	21.00	20.88	20.64	20.80	21.00
3GPP Rel 6	HSUPA Subtest-3	21.72	21.84	21.78	22.00	21.50	21.63	21.69	22.00	21.98	21.59	21.89	22.00
3GPP Rel 6	HSUPA Subtest-4	20.57	20.63	20.99	21.00	20.90	20.85	20.52	21.00	20.79	20.62	20.86	21.00
3GPP Rel 6	HSUPA Subtest-5	22.88	22.85	22.97	23.00	22.69	22.56	22.83	23.00	22.83	22.56	22.76	23.00

Backoff Power

Band		WCDMA II			Tune-up Limit (dBm)
TX Channel		9262	9400	9538	
Rx Channel		9662	9800	9938	
Frequency (MHz)		1852.4	1880	1907.6	
3GPP Rel 99	AMR 12.2Kbps	21.75	21.79	21.69	22.00
3GPP Rel 99	RMC 12.2Kbps	21.72	21.84	21.87	22.00
3GPP Rel 6	HSDPA Subtest-1	20.80	20.65	20.77	21.00
3GPP Rel 6	HSDPA Subtest-2	20.67	20.96	20.57	21.00
3GPP Rel 6	HSDPA Subtest-3	21.00	21.25	21.47	21.50
3GPP Rel 6	HSDPA Subtest-4	21.09	21.45	21.12	21.50
3GPP Rel 8	DC-HSDPA Subtest-1	20.78	20.78	20.50	21.00
3GPP Rel 8	DC-HSDPA Subtest-2	20.83	20.52	20.88	21.00
3GPP Rel 8	DC-HSDPA Subtest-3	21.39	21.23	21.47	21.50
3GPP Rel 8	DC-HSDPA Subtest-4	21.39	21.13	21.39	21.50
3GPP Rel 6	HSUPA Subtest-1	20.86	20.63	20.69	21.00
3GPP Rel 6	HSUPA Subtest-2	18.99	18.99	18.56	19.00
3GPP Rel 6	HSUPA Subtest-3	19.52	19.56	19.65	20.00
3GPP Rel 6	HSUPA Subtest-4	18.92	18.81	18.91	19.00
3GPP Rel 6	HSUPA Subtest-5	20.85	20.95	20.94	21.00

LTE Conducted Power

General Note:

1. Anritsu MT8820C base station simulator was used to setup the connection with EUT; the frequency band, channel bandwidth, RB allocation configuration, modulation type are set in the base station simulator to configure EUT transmitting at maximum power and at different configurations which are requested to be reported to FCC, for conducted power measurement and SAR testing.
2. Per KDB 941225 D05v02r05, when a properly configured base station simulator is used for the SAR and power measurements, spectrum plots for each RB allocation and offset configuration is not required.
3. Per KDB 941225 D05v02r05, start with the largest channel bandwidth and measure SAR for QPSK with 1 RB allocation, using the RB offset and required test channel combination with the highest maximum output power for RB offsets at the upper edge, middle and lower edge of each required test channel.
4. Per KDB 941225 D05v02r05, 50% RB allocation for QPSK SAR testing follows 1RB QPSK allocation procedure.
5. Per KDB 941225 D05v02r05, For QPSK with 100% RB allocation, SAR is not required when the highest maximum output power for 100 % RB allocation is less than the highest maximum output power in 50% and 1 RB allocations and the highest reported SAR for 1 RB and 50% RB allocation are ≤ 0.8 W/kg. Otherwise, SAR is measured for the highest output power channel; and if the reported SAR is > 1.45 W/kg, the remaining required test channels must also be tested.
6. Per KDB 941225 D05v02r05, 16QAM output power for each RB allocation configuration is $>$ not $\frac{1}{2}$ dB higher than the same configuration in QPSK and the reported SAR for the QPSK configuration is ≤ 1.45 W/kg; Per KDB 941225 D05v02r05, 16QAM SAR testing is not required.
7. Per KDB 941225 D05v02r05, Smaller bandwidth output power for each RB allocation configuration is $>$ not $\frac{1}{2}$ dB higher than the same configuration in the largest supported bandwidth, and the reported SAR for the largest supported bandwidth is ≤ 1.45 W/kg; Per KDB 941225 D05v02r05, smaller bandwidth SAR testing is not required.
8. LTE band 2/4/5/38 SAR test was covered by Band 25/66/26/41; according to April 2015 TCB workshop, SAR test for overlapping LTE bands can be reduced if
 - a. the maximum output power, including tolerance, for the smaller band is \leq the larger band to qualify for the SAR test exclusion
 - b. the channel bandwidth and other operating parameters for the smaller band are fully supported by the larger band
9. According to 2017 TCB workshop, for 64 QAM and 16 QAM should be verified by checking the signal constellation with a call box to avoid incorrect maximum power levels due to MPR and other requirements associated with signal modulation, and the following figure is taken from the "Fundamental Measurement >> Modulation Analysis >> constellation" mode of the device connect to the MT8821C base station, therefore, the device 64QAM and 16QAM signal modulation are correct.

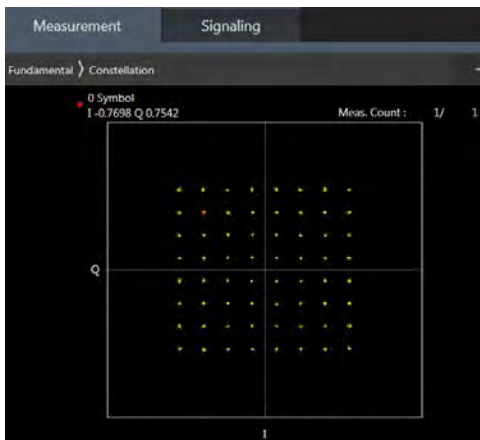

64QAM

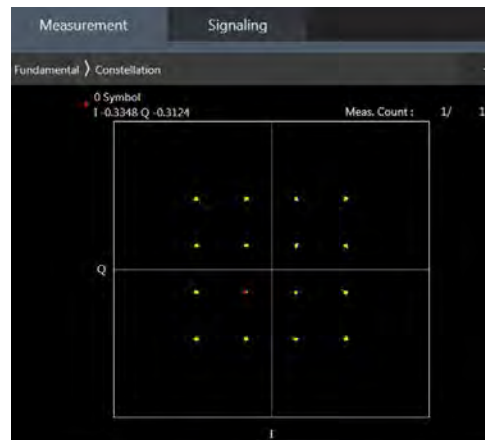

16QAM

<TDD LTE SAR Measurement>

TDD LTE configuration setup for SAR measurement

SAR was tested with a fixed periodic duty factor according to the highest transmission duty factor implemented for the device and supported by 3GPP.

- 3GPP TS 36.211 section 4.2 for Type 2 Frame Structure and Table 4.2-2 for uplink-downlink configurations
- “special subframe S” contains both uplink and downlink transmissions, it has been taken into consideration to determine the transmission duty factor according to the worst case uplink and downlink cyclic prefix requirements for UpPTS
- Establishing connections with base station simulators ensure a consistent means for testing SAR and recommended for evaluating SAR. The Anritsu MT8820C (firmware: #22.52#004) was used for LTE output power measurements and SAR testing.

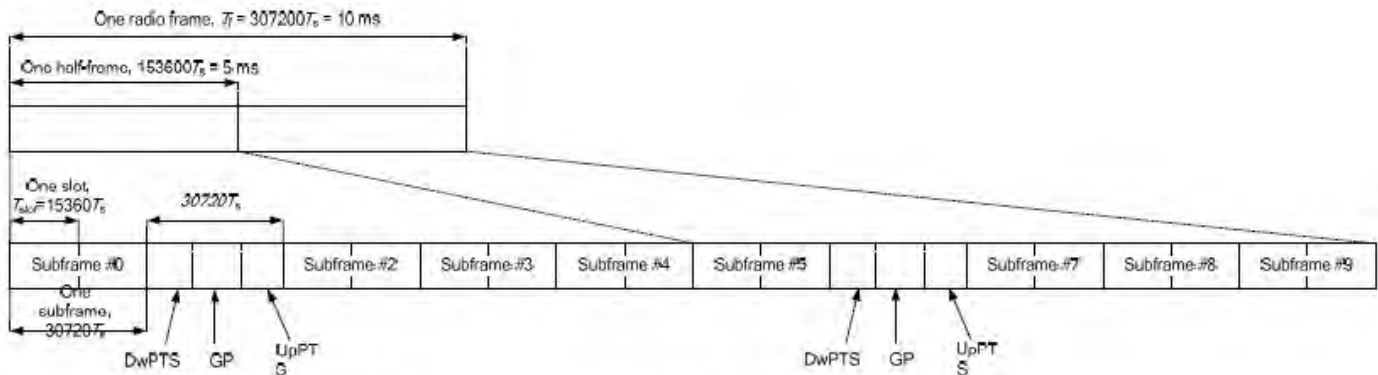

Figure 4.2-1: Frame structure type 2 (for 5 ms switch-point periodicity).

Table 4.2-2: Uplink-downlink configurations.

Uplink-downlink configuration	Downlink-to-Uplink Switch-point periodicity	Subframe number									
		0	1	2	3	4	5	6	7	8	9
0	5 ms	D	S	U	U	U	D	S	U	U	U
1	5 ms	D	S	U	U	D	D	S	U	U	D
2	5 ms	D	S	U	D	D	D	S	U	D	D
3	10 ms	D	S	U	U	U	D	D	D	D	D
4	10 ms	D	S	U	U	D	D	D	D	D	D
5	10 ms	D	S	U	D	D	D	D	D	D	D
6	5 ms	D	S	U	U	U	D	S	U	U	D

Table 4.2-1: Configuration of special subframe (lengths of DwPTS/GP/UpPTS).

Special subframe configuration	Normal cyclic prefix in downlink			Extended cyclic prefix in downlink					
	DwPTS	UpPTS		DwPTS	UpPTS				
		Normal cyclic prefix in uplink	Extended cyclic prefix in uplink		Normal cyclic prefix in uplink	Extended cyclic prefix in uplink			
0	$6592 \cdot T_s$	$2192 \cdot T_s$	$2560 \cdot T_s$	$7680 \cdot T_s$	$2192 \cdot T_s$	$2560 \cdot T_s$			
1	$19760 \cdot T_s$			$20480 \cdot T_s$					
2	$21952 \cdot T_s$			$23040 \cdot T_s$					
3	$24144 \cdot T_s$			$25600 \cdot T_s$					
4	$26336 \cdot T_s$			$7680 \cdot T_s$					
5	$6592 \cdot T_s$	$4384 \cdot T_s$	$5120 \cdot T_s$	$20480 \cdot T_s$	$4384 \cdot T_s$	$5120 \cdot T_s$			
6	$19760 \cdot T_s$			$23040 \cdot T_s$					
7	$21952 \cdot T_s$			$12800 \cdot T_s$					
8	$24144 \cdot T_s$			-			-	-	-
9	$13168 \cdot T_s$			-			-	-	-

Special subframe (30720-T _s): Normal cyclic prefix in downlink (UpPTS)			
	Special subframe configuration	Normal cyclic prefix in uplink	Extended cyclic prefix in uplink
Uplink duty factor in one special subframe	0~4	7.13%	8.33%
	5~9	14.3%	16.7%

Special subframe(30720-T _s): Extended cyclic prefix in downlink (UpPTS)			
	Special subframe configuration	Normal cyclic prefix in uplink	Extended cyclic prefix in uplink
Uplink duty factor in one special subframe	0~3	7.13%	8.33%
	4~7	14.3%	16.7%

The highest duty factor is resulted from:

- i. Uplink-downlink configuration: 0. In a half-frame consisted of 5 subframes, uplink operation is in 3 uplink subframes and 1 special subframe.
- ii. special subframe configuration: 5-9 for normal cyclic prefix in downlink, 4-7 for extended cyclic prefix in downlink
- iii. for special subframe with extended cyclic prefix in uplink, the total uplink duty factor in one half-frame is: $(3+0.167)/5 = 63.3\%$
- iv. for special subframe with normal cyclic prefix in uplink, the total uplink duty factor in one half-frame is: $(3+0.143)/5 = 62.9\%$
- v. For TDD LTE SAR measurement, the duty cycle 1:1.59 (62.9 %) was used perform testing and considering the theoretical duty cycle of 63.3% for extended cyclic prefix in the uplink, and the theoretical duty cycle of 62.9% for normal cyclic prefix in uplink, a scaling factor of extended cyclic prefix $63.3\%/62.9\% = 1.006$ is applied to scale-up the measured SAR result. The scaled TDD LTE SAR = measured SAR (W/kg)* Tune-up Scaling Factor* scaling factor for extended cyclic prefix.
- vi. The device supports Power Class 3 uplink-downlink configurations 0 and 6, and Power Class 2 uplink-downlink configurations 1 to 5 operations for LTE Band 41.
- vii. The highest available duty cycle for Power Class 2 operation is 43.3% using UL-DL configuration 1, for Power Class 3 operation is 63.3% using UL-DL configuration 0. Per FCC Guidance, all SAR tests were performed using Power Class 3. SAR with Power Class 2 at the available duty factor was additionally performed for the Power Class 3 configuration with the highest SAR among all exposure condition.

Table 8.1 LTE Full Power Measurements

Band	Bandwidth	RB Size	RB Offset	Channel	Frequency	QPSK	16QAM		
2	1.4 MHz	1	0	18607	1850.7	23.6	22.9		
				18900	1880.0	23.5	22.5		
				19193	1909.3	23.8	22.7		
			3	3	18607	1850.7	23.8	22.8	
					18900	1880.0	23.7	22.7	
					19193	1909.3	23.3	23.0	
				5	18607	1850.7	23.8	22.7	
					18900	1880.0	23.8	22.5	
					19193	1909.3	23.6	22.4	
		3	0	18607	1850.7	23.4	22.4		
				18900	1880.0	24.0	22.5		
				19193	1909.3	23.4	22.4		
			1	18607	1850.7	23.6	22.6		
				18900	1880.0	23.7	22.8		
				19193	1909.3	23.3	22.9		
			3	18607	1850.7	23.6	22.7		
				18900	1880.0	23.9	22.6		
				19193	1909.3	23.6	22.4		
		6	0	18607	1850.7	22.5	21.4		
				18900	1880.0	22.7	21.7		
				19193	1909.3	23.0	21.8		
		3 MHz	1	0	18615	1851.5	23.6	22.5	
					18900	1880.0	23.8	22.9	
					19185	1908.5	23.4	23.0	
	7				18615	1851.5	23.4	22.6	
					18900	1880.0	23.7	22.8	
					19185	1908.5	23.3	22.9	
	14			18615	1851.5	23.4	22.7		
				18900	1880.0	23.3	22.9		
				19185	1908.5	23.7	22.6		
				8	0	18615	1851.5	22.9	21.7
						18900	1880.0	22.5	21.9
						19185	1908.5	22.7	21.5
	7				18615	1851.5	22.8	21.6	
					18900	1880.0	22.8	21.5	
					19185	1908.5	22.7	22.0	
	14		18615	1851.5	22.8	21.6			
			18900	1880.0	22.5	21.6			
			19185	1908.5	22.9	21.4			
	15		0	18615	1851.5	22.8	21.5		
				18900	1880.0	22.5	21.7		
				19185	1908.5	22.3	21.6		

Band	Bandwidth	RB Size	RB Offset	Channel	Frequency	QPSK	16QAM	
2	5 MHz	1	0	18625	1852.5	23.8	22.4	
				18900	1880.0	23.3	22.4	
				19175	1907.5	23.9	22.8	
			12	18625	1852.5	23.5	22.5	
				18900	1880.0	23.4	22.7	
				19175	1907.5	23.4	22.9	
		24	18625	1852.5	23.8	22.4		
			18900	1880.0	23.4	22.8		
			19175	1907.5	23.8	22.6		
		12	0	18625	1852.5	22.7	21.3	
				18900	1880.0	22.5	21.3	
				19175	1907.5	22.4	21.9	
			6	18625	1852.5	22.7	21.8	
				18900	1880.0	22.7	21.6	
				19175	1907.5	22.7	21.9	
			13	18625	1852.5	22.4	21.6	
				18900	1880.0	23.0	21.7	
				19175	1907.5	22.7	21.5	
		25	0	18625	1852.5	22.4	21.9	
				18900	1880.0	23.0	22.0	
				19175	1907.5	22.9	21.9	
		10 MHz	1	0	18650	1855.0	23.6	22.5
					18900	1880.0	24.0	22.6
					19150	1905.0	23.5	22.6
	24			18650	1855.0	23.9	22.9	
				18900	1880.0	23.4	22.9	
				19150	1905.0	23.4	22.4	
	49			18650	1855.0	23.3	22.7	
				18900	1880.0	23.7	22.8	
				19150	1905.0	23.4	22.5	
	25			0	18650	1855.0	22.5	21.4
					18900	1880.0	22.4	21.7
					19150	1905.0	22.9	21.8
			13	18650	1855.0	22.3	21.5	
				18900	1880.0	22.7	21.7	
				19150	1905.0	22.5	21.4	
			25	18650	1855.0	22.8	21.3	
				18900	1880.0	22.4	21.7	
				19150	1905.0	22.8	21.4	
	50		0	18650	1855.0	22.7	21.6	
				18900	1880.0	22.9	21.9	
				19150	1905.0	22.5	21.4	

Band	Bandwidth	RB Size	RB Offset	Channel	Frequency	QPSK	16QAM		
2	15 MHz	1	0	18675	1857.5	23.9	22.9		
				18900	1880.0	23.4	22.4		
				19125	1902.5	23.3	22.5		
			37	18675	1857.5	23.4	22.6		
				18900	1880.0	23.5	22.6		
				19125	1902.5	23.9	22.4		
				74	18675	1857.5	23.5	22.4	
					18900	1880.0	24.0	23.0	
					19125	1902.5	23.9	22.8	
		36	0	18675	1857.5	22.4	21.4		
				18900	1880.0	22.5	22.0		
				19125	1902.5	22.4	21.7		
			19	18675	1857.5	22.7	21.7		
				18900	1880.0	22.4	21.4		
				19125	1902.5	23.0	21.7		
			39	18675	1857.5	23.0	21.4		
				18900	1880.0	22.3	21.4		
				19125	1902.5	22.8	21.8		
			75	0	18675	1857.5	23.0	21.8	
					18900	1880.0	22.6	21.8	
					19125	1902.5	22.3	21.8	
		20 MHz	1	0	18700	1860.0	23.8	22.9	
					18900	1880.0	23.6	22.5	
					19100	1900.0	23.4	22.4	
	49				18700	1860.0	23.4	22.5	
					18900	1880.0	23.4	22.7	
					19100	1900.0	23.5	22.6	
	99			18700	1860.0	23.3	22.6		
				18900	1880.0	23.6	22.5		
				19100	1900.0	24.0	22.6		
				50	0	18700	1860.0	22.4	21.5
						18900	1880.0	22.4	21.6
						19100	1900.0	22.3	21.4
	24				18700	1860.0	22.8	21.6	
					18900	1880.0	22.6	21.5	
					19100	1900.0	22.5	21.3	
	50			50	18700	1860.0	22.4	21.7	
					18900	1880.0	22.5	21.6	
					19100	1900.0	22.3	21.3	
			100	0	18700	1860.0	22.8	21.5	
					18900	1880.0	22.7	21.4	
					19100	1900.0	22.5	21.6	

Band	Bandwidth	RB Size	RB Offset	Channel	Frequency	QPSK	16QAM
4	1.4 MHz	1	0	19957	1710.7	23.9	22.6
				20175	1732.5	23.6	22.5
				20393	1754.3	23.3	22.4
			3	19957	1710.7	23.5	22.3
				20175	1732.5	23.8	22.7
				20393	1754.3	23.6	22.5
		5	19957	1710.7	23.9	23.0	
			20175	1732.5	23.3	22.7	
			20393	1754.3	23.4	22.6	
		3	0	19957	1710.7	23.8	22.7
				20175	1732.5	24.0	22.7
				20393	1754.3	23.7	22.4
			1	19957	1710.7	23.7	22.9
				20175	1732.5	23.7	22.3
				20393	1754.3	23.3	22.9
			3	19957	1710.7	23.6	22.7
				20175	1732.5	23.5	22.7
				20393	1754.3	23.5	22.8
	6	0	19957	1710.7	22.5	21.3	
			20175	1732.5	22.8	22.0	
			20393	1754.3	22.4	21.6	
	3 MHz	1	0	19965	1711.5	23.3	22.5
				20175	1732.5	23.7	22.5
				20385	1753.5	23.5	22.6
			7	19965	1711.5	23.9	22.7
				20175	1732.5	23.9	22.4
				20385	1753.5	23.8	22.4
			14	19965	1711.5	23.5	22.9
				20175	1732.5	23.6	22.3
				20385	1753.5	23.9	22.9
		8	0	19965	1711.5	22.9	21.9
				20175	1732.5	22.5	21.6
				20385	1753.5	22.6	21.6
			7	19965	1711.5	22.9	21.6
				20175	1732.5	22.6	21.8
				20385	1753.5	22.7	21.9
			14	19965	1711.5	22.5	21.6
				20175	1732.5	22.7	21.5
				20385	1753.5	22.7	21.3
	15	0	19965	1711.5	22.8	21.5	
			20175	1732.5	22.8	21.7	
			20385	1753.5	22.5	21.9	

Band	Bandwidth	RB Size	RB Offset	Channel	Frequency	QPSK	16QAM	
4	5 MHz	1	0	19975	1712.5	23.8	22.4	
				20175	1732.5	23.9	22.5	
				20375	1752.5	23.4	22.9	
			12	19975	1712.5	23.3	22.4	
				20175	1732.5	23.7	22.7	
				20375	1752.5	23.5	22.5	
			24	19975	1712.5	24.0	22.9	
				20175	1732.5	23.8	22.4	
				20375	1752.5	23.4	22.5	
		12	0	19975	1712.5	22.7	21.4	
				20175	1732.5	22.6	21.4	
				20375	1752.5	22.6	21.9	
			6	19975	1712.5	22.7	21.3	
				20175	1732.5	22.9	21.6	
				20375	1752.5	22.7	21.5	
			13	19975	1712.5	23.0	21.6	
				20175	1732.5	22.9	21.6	
				20375	1752.5	22.7	21.7	
			25	0	19975	1712.5	23.0	22.0
					20175	1732.5	22.3	21.8
					20375	1752.5	22.5	21.8
		10 MHz	1	0	20000	1715.0	23.4	23.0
					20175	1732.5	23.9	22.9
					20350	1750.0	23.9	22.8
	24			20000	1715.0	24.0	22.4	
				20175	1732.5	23.9	22.3	
				20350	1750.0	23.7	22.8	
	49			20000	1715.0	23.8	22.6	
				20175	1732.5	24.0	22.5	
				20350	1750.0	23.6	22.9	
	25			0	20000	1715.0	22.9	21.6
					20175	1732.5	22.8	21.7
					20350	1750.0	22.4	21.6
			13	20000	1715.0	22.3	21.7	
				20175	1732.5	22.6	21.6	
				20350	1750.0	22.6	21.6	
			25	20000	1715.0	22.5	22.0	
				20175	1732.5	22.9	21.6	
				20350	1750.0	22.9	21.9	
	50		0	20000	1715.0	22.5	21.6	
				20175	1732.5	22.8	21.7	
				20350	1750.0	22.7	21.7	

Band	Bandwidth	RB Size	RB Offset	Channel	Frequency	QPSK	16QAM	
4	15 MHz	1	0	20025	1717.5	23.5	22.9	
				20175	1732.5	23.9	22.8	
				20325	1747.5	23.9	22.8	
			37	20025	1717.5	23.9	22.5	
				20175	1732.5	23.4	22.8	
				20325	1747.5	23.4	22.6	
			74	20025	1717.5	23.7	22.7	
				20175	1732.5	23.5	22.6	
				20325	1747.5	23.3	22.8	
		36	0	20025	1717.5	23.0	21.8	
				20175	1732.5	22.9	21.8	
				20325	1747.5	23.0	21.8	
			19	20025	1717.5	22.5	21.8	
				20175	1732.5	23.0	21.9	
				20325	1747.5	22.9	21.6	
			39	20025	1717.5	22.4	21.8	
				20175	1732.5	22.8	21.8	
				20325	1747.5	22.9	22.0	
			75	0	20025	1717.5	22.4	21.5
					20175	1732.5	23.0	21.5
					20325	1747.5	22.7	21.4
		20 MHz	1	0	20050	1720.0	23.7	23.0
					20175	1732.5	23.8	22.6
					20300	1745.0	23.6	22.7
	49			20050	1720.0	23.8	22.5	
				20175	1732.5	23.4	22.5	
				20300	1745.0	23.9	22.8	
	99			20050	1720.0	23.6	22.3	
				20175	1732.5	23.9	22.5	
				20300	1745.0	23.5	22.5	
	50			0	20050	1720.0	22.6	21.5
					20175	1732.5	22.9	21.6
					20300	1745.0	22.3	21.8
			24	20050	1720.0	23.0	21.9	
				20175	1732.5	22.6	21.4	
				20300	1745.0	22.9	21.5	
			50	20050	1720.0	22.4	22.0	
				20175	1732.5	22.6	21.6	
				20300	1745.0	22.9	21.6	
	100		0	20050	1720.0	22.4	22.0	
				20175	1732.5	22.6	21.4	
				20300	1745.0	22.9	21.7	

Band	Bandwidth	RB Size	RB Offset	Channel	Frequency	QPSK	16QAM	
5	1.4 MHz	1	0	20407	824.7	23.3	23.0	
				20525	836.5	23.4	22.3	
				20643	848.3	23.7	23.0	
			3	0	20407	824.7	23.5	22.5
					20525	836.5	23.9	22.7
					20643	848.3	23.9	22.9
			5	0	20407	824.7	23.6	22.4
					20525	836.5	24.0	22.3
					20643	848.3	23.7	22.9
		3	0	0	20407	824.7	23.8	22.7
					20525	836.5	24.0	22.6
					20643	848.3	23.7	22.4
			1	0	20407	824.7	23.9	22.7
					20525	836.5	23.3	22.8
					20643	848.3	23.7	22.4
			3	0	20407	824.7	23.6	22.7
					20525	836.5	23.4	22.8
					20643	848.3	23.3	22.4
	6	0	0	20407	824.7	22.9	21.7	
				20525	836.5	22.5	21.6	
				20643	848.3	22.6	21.4	
	3 MHz	1	0	20415	825.5	23.9	22.6	
				20525	836.5	23.5	22.6	
				20635	847.5	23.7	23.0	
			7	0	20415	825.5	23.8	22.4
					20525	836.5	23.6	22.9
					20635	847.5	23.8	22.5
			14	0	20415	825.5	23.4	22.8
					20525	836.5	23.8	22.4
					20635	847.5	23.8	22.4
		8	0	0	20415	825.5	22.5	22.0
					20525	836.5	22.7	21.7
					20635	847.5	22.4	21.6
			7	0	20415	825.5	22.5	21.5
					20525	836.5	22.5	21.8
					20635	847.5	22.5	21.9
			14	0	20415	825.5	22.8	21.7
					20525	836.5	22.7	21.5
					20635	847.5	22.7	21.4
	15	0	0	20415	825.5	23.0	21.6	
				20525	836.5	22.4	21.7	
				20635	847.5	22.4	21.4	

Band	Bandwidth	RB Size	RB Offset	Channel	Frequency	QPSK	16QAM	
5	5 MHz	1	0	20425	826.5	23.5	22.8	
				20525	836.5	23.9	22.8	
				20625	846.5	23.9	22.4	
			12	20425	826.5	23.3	22.3	
				20525	836.5	23.6	22.7	
				20625	846.5	23.6	22.4	
			24	20425	826.5	23.6	22.8	
				20525	836.5	23.5	22.3	
				20625	846.5	23.4	22.4	
		12	0	20425	826.5	22.7	21.8	
				20525	836.5	22.6	21.5	
				20625	846.5	22.5	21.7	
			6	20425	826.5	22.7	21.4	
				20525	836.5	22.4	21.3	
				20625	846.5	22.4	21.6	
			13	20425	826.5	22.5	21.4	
				20525	836.5	22.7	21.9	
				20625	846.5	22.9	21.4	
		25	0	20425	826.5	22.8	21.3	
				20525	836.5	22.8	21.5	
				20625	846.5	23.0	21.6	
		10 MHz	1	0	20450	829.0	23.7	22.8
					20525	836.5	24.0	22.9
					20600	844.0	23.8	22.6
	24			20450	829.0	23.4	22.6	
				20525	836.5	23.6	22.3	
				20600	844.0	23.4	23.0	
	49			20450	829.0	23.4	23.0	
				20525	836.5	23.7	22.6	
				20600	844.0	23.5	22.4	
	25			0	20450	829.0	22.8	21.8
					20525	836.5	22.6	21.6
					20600	844.0	22.9	21.4
			13	20450	829.0	22.6	21.5	
				20525	836.5	22.4	22.0	
				20600	844.0	22.5	21.8	
			25	20450	829.0	22.5	21.7	
				20525	836.5	22.7	21.4	
				20600	844.0	22.6	21.4	
	50		0	20450	829.0	23.0	21.8	
				20525	836.5	22.3	21.5	
				20600	844.0	22.7	21.8	

Band	Bandwidth	RB Size	RB Offset	Channel	Frequency	QPSK	16QAM	
7	5 MHz	1	0	20775	2502.5	23.5	22.8	
				21100	2535.0	23.9	22.8	
				21425	2567.5	23.9	22.4	
			12	20775	2502.5	23.3	22.3	
				21100	2535.0	23.6	22.7	
				21425	2567.5	23.6	22.4	
			24	20775	2502.5	23.6	22.8	
				21100	2535.0	23.5	22.3	
				21425	2567.5	23.4	22.4	
		12	0	20775	2502.5	22.7	21.8	
				21100	2535.0	22.6	21.5	
				21425	2567.5	22.5	21.7	
			6	20775	2502.5	22.7	21.4	
				21100	2535.0	22.4	21.3	
				21425	2567.5	22.4	21.6	
			13	20775	2502.5	22.5	21.4	
				21100	2535.0	22.7	21.9	
				21425	2567.5	22.9	21.4	
		25	0	20775	2502.5	22.8	21.3	
				21100	2535.0	22.8	21.5	
				21425	2567.5	23.0	21.6	
		10 MHz	1	0	20800	2505.0	23.7	22.8
					21100	2535.0	24.0	22.9
					21400	2565.0	23.8	22.6
	24			20800	2505.0	23.4	22.6	
				21100	2535.0	23.6	22.3	
				21400	2565.0	23.4	23.0	
	49			20800	2505.0	23.4	23.0	
				21100	2535.0	23.7	22.6	
				21400	2565.0	23.5	22.4	
	25			0	20800	2505.0	22.8	21.8
					21100	2535.0	22.6	21.6
					21400	2565.0	22.9	21.4
			13	20800	2505.0	22.6	21.5	
				21100	2535.0	22.4	22.0	
				21400	2565.0	22.5	21.8	
			25	20800	2505.0	22.5	21.7	
				21100	2535.0	22.7	21.4	
				21400	2565.0	22.6	21.4	
	50		0	20800	2505.0	23.0	21.8	
				21100	2535.0	22.3	21.5	
				21400	2565.0	22.7	21.8	

Band	Bandwidth	RB Size	RB Offset	Channel	Frequency	QPSK	16QAM	
7	15 MHz	1	0	20825	2507.5	23.8	22.9	
				21100	2535.0	23.8	22.3	
				21375	2562.5	23.4	22.6	
			37	20825	2507.5	23.5	22.3	
				21100	2535.0	23.9	22.5	
				21375	2562.5	23.7	22.6	
			74	20825	2507.5	23.4	22.7	
				21100	2535.0	23.7	22.3	
				21375	2562.5	23.8	22.7	
		36	0	20825	2507.5	23.0	21.5	
				21100	2535.0	22.7	21.7	
				21375	2562.5	22.9	22.0	
			19	20825	2507.5	22.7	21.6	
				21100	2535.0	22.9	21.7	
				21375	2562.5	22.9	21.9	
			39	20825	2507.5	22.5	21.8	
				21100	2535.0	22.4	21.8	
				21375	2562.5	22.7	21.9	
			75	0	20825	2507.5	22.5	21.7
					21100	2535.0	22.8	21.8
					21375	2562.5	22.9	21.6
		20 MHz	1	0	20850	2510.0	23.8	22.6
					21100	2535.0	23.3	22.7
					21350	2560.0	23.8	22.7
	49			20850	2510.0	23.6	22.7	
				21100	2535.0	23.9	22.3	
				21350	2560.0	23.6	22.5	
	99			20850	2510.0	23.4	22.6	
				21100	2535.0	23.4	22.6	
				21350	2560.0	23.3	22.6	
	50			0	20850	2510.0	22.7	21.5
					21100	2535.0	22.8	21.4
					21350	2560.0	22.7	21.6
			24	20850	2510.0	22.9	21.8	
				21100	2535.0	22.9	21.6	
				21350	2560.0	22.4	21.4	
			50	20850	2510.0	22.6	21.9	
				21100	2535.0	22.3	21.9	
				21350	2560.0	22.6	21.9	
	100		0	20850	2510.0	22.6	21.7	
				21100	2535.0	22.7	22.0	
				21350	2560.0	22.7	21.9	

Band	Bandwidth	RB Size	RB Offset	Channel	Frequency	QPSK	16QAM	
12	1.4 MHz	1	0	23017	699.7	23.9	22.8	
				23095	707.5	23.9	22.9	
				23173	715.3	24.0	22.5	
			3	23017	699.7	23.9	22.9	
				23095	707.5	23.4	22.9	
				23173	715.3	23.7	22.5	
			5	23017	699.7	23.8	22.5	
				23095	707.5	23.8	22.3	
				23173	715.3	23.8	22.4	
		3	0	23017	699.7	23.9	22.5	
				23095	707.5	23.7	22.9	
				23173	715.3	23.6	22.6	
			1	23017	699.7	23.4	22.6	
				23095	707.5	23.5	22.7	
				23173	715.3	23.4	22.9	
			3	23017	699.7	23.6	22.6	
				23095	707.5	23.8	22.6	
				23173	715.3	23.4	22.7	
	6	0	23017	699.7	22.9	22.0		
			23095	707.5	22.7	21.4		
			23173	715.3	22.6	21.6		
	3 MHz	1	0	23025	700.5	23.8	22.4	
				23095	707.5	23.5	22.5	
				23165	714.5	23.6	22.5	
			7	23025	700.5	23.6	23.0	
				23095	707.5	23.7	22.7	
				23165	714.5	23.5	22.6	
			14	23025	700.5	23.9	23.0	
				23095	707.5	23.5	22.5	
				23165	714.5	23.6	22.5	
			8	0	23025	700.5	22.6	22.0
					23095	707.5	22.5	21.9
					23165	714.5	22.8	21.8
				7	23025	700.5	22.7	21.9
					23095	707.5	22.4	21.9
					23165	714.5	23.0	21.8
		14		23025	700.5	22.8	21.3	
				23095	707.5	22.6	21.9	
				23165	714.5	22.8	21.5	
		15	0	23025	700.5	22.4	21.4	
				23095	707.5	22.9	21.4	
				23165	714.5	22.7	21.8	

Band	Bandwidth	RB Size	RB Offset	Channel	Frequency	QPSK	16QAM		
12	5 MHz	1	0	23035	701.5	23.9	22.5		
				23095	707.5	23.8	22.4		
				23155	713.5	23.9	22.7		
			12	23035	701.5	23.5	22.4		
					23095	707.5	23.5	23.0	
					23155	713.5	23.5	23.0	
			24	23035	701.5	23.3	22.4		
					23095	707.5	23.9	22.7	
					23155	713.5	24.0	22.6	
		12	0	23035	701.5	22.7	21.6		
					23095	707.5	22.4	21.5	
					23155	713.5	23.0	21.4	
				6	23035	701.5	22.4	21.5	
						23095	707.5	22.7	21.7
						23155	713.5	22.9	21.8
			13	23035	701.5	22.9	21.4		
					23095	707.5	22.4	21.9	
					23155	713.5	22.5	21.9	
			25	0	23035	701.5	22.7	21.5	
						23095	707.5	22.4	21.7
						23155	713.5	22.8	21.6
		10 MHz	1	0	23060	704.0	23.4	22.8	
					23095	707.5	24.0	22.5	
					23130	711.0	23.4	23.0	
	24			23060	704.0	24.0	22.6		
					23095	707.5	23.7	22.9	
					23130	711.0	23.8	22.8	
	49			23060	704.0	23.8	22.7		
					23095	707.5	23.5	22.7	
					23130	711.0	23.8	22.9	
	25			0	23060	704.0	22.6	21.8	
						23095	707.5	22.4	21.5
						23130	711.0	22.5	21.6
			13	23060	704.0	22.9	21.9		
					23095	707.5	22.7	21.5	
					23130	711.0	22.6	21.6	
			25	23060	704.0	22.5	21.7		
					23095	707.5	22.8	21.4	
					23130	711.0	22.4	21.6	
	50		0	23060	704.0	22.4	21.8		
					23095	707.5	22.5	21.4	
					23130	711.0	22.6	21.4	

Band	Bandwidth	RB Size	RB Offset	Channel	Frequency	QPSK	16QAM		
13	5 MHz	1	0	23205	779.5	23.9	22.3		
				23230	782.0	24.0	22.8		
				23129	784.5	23.3	22.4		
			12	12	23205	779.5	23.4	22.3	
					23230	782.0	23.5	22.9	
					23129	784.5	24.0	22.7	
			24	24	23205	779.5	23.4	22.6	
					23230	782.0	23.6	22.9	
					23129	784.5	23.7	22.4	
		12	12	0	23205	779.5	22.6	21.5	
					23230	782.0	22.8	21.8	
					23129	784.5	22.7	21.4	
				6	6	23205	779.5	22.3	21.3
						23230	782.0	22.3	21.4
						23129	784.5	22.6	21.7
				13	13	23205	779.5	22.9	21.3
						23230	782.0	22.8	21.8
						23129	784.5	22.3	21.5
	25	25	0	23205	779.5	22.5	21.6		
				23230	782.0	22.4	21.4		
				23129	784.5	22.4	22.0		
	10 MHz	10 MHz	1	0	23230	782.0	23.6	22.6	
				24	23230	782.0	23.9	22.5	
				49	23230	782.0	23.5	22.4	
			25	25	0	23230	782.0	22.6	21.9
					13	23230	782.0	22.4	21.8
					25	23230	782.0	22.3	21.3
			50	0	23230	782.0	22.6	21.5	

Band	Bandwidth	RB Size	RB Offset	Channel	Frequency	QPSK	16QAM
14	5 MHz	1	0	23305	790.5	23.5	22.9
				23330	793.0	23.5	22.3
				23355	795.5	23.8	22.9
			12	23305	790.5	23.9	22.7
				23330	793.0	23.9	22.6
				23355	795.5	23.6	22.8
		24	23305	790.5	23.5	23.0	
			23330	793.0	23.5	23.0	
			23355	795.5	23.9	22.4	
		12	0	23305	790.5	22.5	21.4
				23330	793.0	22.8	21.4
				23355	795.5	22.5	21.4
			6	23305	790.5	23.0	21.7
				23330	793.0	22.3	21.7
				23355	795.5	22.9	21.9
			13	23305	790.5	22.7	21.8
				23330	793.0	22.7	21.8
				23355	795.5	22.8	21.4
	25		0	23305	790.5	22.3	22.0
				23330	793.0	22.4	21.5
				23355	795.5	22.3	21.9
	10 MHz	1	0	23330	793.0	23.9	23.0
			24	23330	793.0	23.9	22.5
			49	23330	793.0	23.3	22.3
		25	0	23330	793.0	22.3	21.8
			13	23330	793.0	22.3	21.5
			25	23330	793.0	22.6	21.7
		50	0	23330	793.0	22.5	21.7

Band	Bandwidth	RB Size	RB Offset	Channel	Frequency	QPSK	16QAM		
25	1.4 MHz	1	0	26047	1850.7	23.8	23.0		
				26365	1882.5	23.5	22.6		
				26683	1914.3	23.4	22.7		
			3	3	26047	1850.7	23.4	22.8	
					26365	1882.5	23.6	22.5	
					26683	1914.3	23.5	22.4	
				5	26047	1850.7	23.8	22.9	
					26365	1882.5	23.5	22.6	
					26683	1914.3	23.3	22.6	
		3	0	26047	1850.7	23.7	22.7		
				26365	1882.5	23.4	22.6		
				26683	1914.3	23.8	22.7		
				1	26047	1850.7	23.6	22.7	
					26365	1882.5	23.5	22.4	
					26683	1914.3	23.9	22.6	
			3	26047	1850.7	23.6	22.6		
				26365	1882.5	23.4	22.6		
				26683	1914.3	23.3	22.6		
		6	0	26047	1850.7	22.5	21.4		
				26365	1882.5	22.3	21.4		
				26683	1914.3	23.0	21.8		
		3 MHz	1	0	26055	1851.5	23.7	22.6	
					26365	1882.5	23.9	22.4	
					26675	1913.5	23.5	22.8	
	7				26055	1851.5	23.5	22.7	
					26365	1882.5	23.8	22.7	
					26675	1913.5	23.9	22.9	
	14			26055	1851.5	23.9	22.8		
				26365	1882.5	23.7	22.9		
				26675	1913.5	23.8	22.3		
				8	0	26055	1851.5	22.3	21.9
						26365	1882.5	22.9	21.4
						26675	1913.5	22.7	21.6
	7				26055	1851.5	22.6	21.3	
					26365	1882.5	22.7	21.7	
					26675	1913.5	22.7	21.5	
	14		26055		1851.5	22.9	21.4		
			26365		1882.5	22.5	22.0		
			26675		1913.5	22.5	21.4		
			15	0	26055	1851.5	22.5	21.8	
					26365	1882.5	22.4	21.4	
					26675	1913.5	22.9	21.8	

Band	Bandwidth	RB Size	RB Offset	Channel	Frequency	QPSK	16QAM	
25	5 MHz	1	0	26065	1852.5	23.3	22.4	
				26365	1882.5	23.5	22.4	
				26665	1912.5	23.5	22.9	
			12	26065	1852.5	23.6	22.5	
				26365	1882.5	23.5	22.9	
				26665	1912.5	23.7	22.9	
			24	26065	1852.5	23.9	22.9	
				26365	1882.5	23.4	22.3	
				26665	1912.5	23.4	22.4	
		12	0	26065	1852.5	22.7	21.3	
				26365	1882.5	22.5	21.8	
				26665	1912.5	22.9	21.5	
			6	26065	1852.5	23.0	22.0	
				26365	1882.5	22.8	21.6	
				26665	1912.5	22.6	21.8	
			13	26065	1852.5	22.8	21.3	
				26365	1882.5	22.9	21.4	
				26665	1912.5	22.7	21.3	
			25	0	26065	1852.5	22.7	21.9
					26365	1882.5	22.3	21.5
					26665	1912.5	22.5	21.7
		10 MHz	1	0	26090	1855.0	23.4	22.9
					26365	1882.5	23.6	22.4
					26640	1910.0	23.4	22.6
				24	26090	1855.0	23.4	22.7
					26365	1882.5	23.3	22.6
					26640	1910.0	23.7	22.8
	49			26090	1855.0	23.9	22.5	
				26365	1882.5	23.6	23.0	
				26640	1910.0	23.8	22.6	
	25			0	26090	1855.0	22.7	22.0
					26365	1882.5	22.6	21.8
					26640	1910.0	22.6	21.5
			13	26090	1855.0	22.6	21.9	
				26365	1882.5	22.8	21.6	
				26640	1910.0	22.6	21.9	
			25	26090	1855.0	22.7	21.9	
				26365	1882.5	22.6	21.9	
				26640	1910.0	22.3	21.5	
			50	0	26090	1855.0	22.7	21.9
					26365	1882.5	22.5	21.7
					26640	1910.0	22.6	21.6

Band	Bandwidth	RB Size	RB Offset	Channel	Frequency	QPSK	16QAM		
25	15 MHz	1	0		26115	1857.5	23.5	22.3	
					26365	1882.5	23.5	22.6	
					26615	1907.5	23.5	22.4	
			37		26115	1857.5	23.5	22.8	
					26365	1882.5	23.4	23.0	
					26615	1907.5	23.9	22.5	
			74		26115	1857.5	23.8	23.0	
					26365	1882.5	23.4	22.3	
					26615	1907.5	23.5	22.4	
		36	0		26115	1857.5	22.7	21.8	
					26365	1882.5	22.7	21.9	
					26615	1907.5	22.9	21.4	
				19		26115	1857.5	22.7	21.8
						26365	1882.5	22.7	21.6
						26615	1907.5	22.4	21.5
			39		26115	1857.5	22.4	21.5	
					26365	1882.5	22.8	21.6	
					26615	1907.5	22.6	21.7	
			75	0		26115	1857.5	22.4	21.8
						26365	1882.5	22.3	21.6
						26615	1907.5	22.7	21.4
		20 MHz	1	0		26140	1860.0	23.7	22.6
						26365	1882.5	23.7	22.9
						26590	1905.0	23.4	22.6
	49				26140	1860.0	23.4	22.7	
					26365	1882.5	24.0	22.5	
					26590	1905.0	23.6	22.6	
	99				26140	1860.0	23.5	22.9	
					26365	1882.5	23.9	22.8	
					26590	1905.0	23.3	22.5	
	50			0		26140	1860.0	22.4	21.5
						26365	1882.5	22.9	21.7
						26590	1905.0	22.5	21.5
			24		26140	1860.0	22.9	21.3	
					26365	1882.5	22.5	21.5	
					26590	1905.0	22.5	21.5	
			50		26140	1860.0	23.0	22.0	
					26365	1882.5	23.0	21.4	
					26590	1905.0	22.9	21.8	
	100		0		26140	1860.0	22.4	21.5	
					26365	1882.5	22.4	21.5	
					26590	1905.0	22.8	21.5	

Band	Bandwidth	RB Size	RB Offset	Channel	Frequency	QPSK	16QAM	
26	1.4 MHz	1	0	26697	814.7	23.3	22.6	
				26865	831.5	23.9	22.8	
				27033	848.3	23.8	22.4	
			3	26697	814.7	23.8	22.8	
				26865	831.5	23.4	22.5	
				27033	848.3	24.0	22.9	
			5	26697	814.7	23.4	22.6	
				26865	831.5	23.6	22.5	
				27033	848.3	23.5	22.7	
		3	0	26697	814.7	23.6	22.6	
				26865	831.5	23.6	22.8	
				27033	848.3	23.6	22.6	
			1	26697	814.7	23.3	23.0	
				26865	831.5	23.5	22.8	
				27033	848.3	23.9	22.3	
			3	26697	814.7	23.7	22.6	
				26865	831.5	23.7	22.8	
				27033	848.3	23.8	22.4	
	6	0	26697	814.7	23.0	21.8		
			26865	831.5	22.4	22.0		
			27033	848.3	22.6	21.7		
	3 MHz	1	0	26705	815.5	23.7	22.7	
				26865	831.5	23.8	22.6	
				27025	847.5	23.3	22.4	
			7	26705	815.5	23.7	22.9	
				26865	831.5	23.9	22.6	
				27025	847.5	23.3	22.7	
			14	26705	815.5	23.7	22.9	
				26865	831.5	23.7	22.9	
				27025	847.5	23.5	22.8	
			8	0	26705	815.5	22.4	21.7
					26865	831.5	22.8	21.4
					27025	847.5	22.9	21.4
		7		26705	815.5	22.5	21.9	
				26865	831.5	22.5	21.8	
				27025	847.5	22.9	21.9	
		14		26705	815.5	22.7	21.7	
				26865	831.5	22.8	21.4	
				27025	847.5	22.8	21.3	
		15	0	26705	815.5	22.9	22.0	
				26865	831.5	22.9	21.5	
				27025	847.5	22.4	21.7	

Band	Bandwidth	RB Size	RB Offset	Channel	Frequency	QPSK	16QAM		
26	5 MHz	1	0	26715	816.5	23.4	22.6		
				26865	831.5	23.7	22.8		
				27015	846.5	23.6	22.9		
			12	12	26715	816.5	23.6	22.3	
					26865	831.5	23.8	22.8	
					27015	846.5	23.8	23.0	
			24	24	26715	816.5	23.8	22.3	
					26865	831.5	23.5	22.9	
					27015	846.5	24.0	23.0	
		12	12	0	26715	816.5	22.7	21.6	
					26865	831.5	22.9	21.9	
					27015	846.5	22.8	21.4	
				6	6	26715	816.5	22.5	21.6
						26865	831.5	22.4	21.6
						27015	846.5	22.8	21.7
				13	13	26715	816.5	22.8	21.9
						26865	831.5	22.8	22.0
						27015	846.5	22.6	21.8
		25	25	0	26715	816.5	22.7	21.5	
					26865	831.5	22.4	21.5	
					27015	846.5	22.6	22.0	
		10 MHz	1	0	26740	819.0	23.4	22.7	
					26865	831.5	24.0	22.4	
					26990	844.0	23.5	22.7	
	24				24	26740	819.0	23.9	22.9
						26865	831.5	23.6	22.3
						26990	844.0	23.4	22.8
	49			49	26740	819.0	23.5	23.0	
					26865	831.5	23.9	22.8	
					26990	844.0	23.4	22.7	
	25			25	0	26740	819.0	22.5	21.5
						26865	831.5	22.4	21.8
						26990	844.0	22.3	21.3
			13		13	26740	819.0	22.3	21.4
						26865	831.5	22.5	21.5
						26990	844.0	22.9	21.4
			25		25	26740	819.0	22.3	21.8
						26865	831.5	22.9	21.6
						26990	844.0	22.8	21.8
	50		50	0	26740	819.0	22.8	21.5	
					26865	831.5	22.3	21.5	
					26990	844.0	22.8	21.3	

Band	Bandwidth	RB Size	RB Offset	Channel	Frequency	QPSK	16QAM		
26	15 MHz	1	0		26765	821.5	23.6	22.5	
					26865	831.5	23.7	22.4	
					26965	841.5	23.6	22.3	
			37		26765	821.5	23.5	22.9	
					26865	831.5	23.3	22.6	
					26965	841.5	23.6	22.7	
			74		26765	821.5	23.8	22.5	
					26865	831.5	23.5	22.5	
					26965	841.5	23.8	22.7	
		36	0			26765	821.5	22.6	21.5
						26865	831.5	22.6	21.9
						26965	841.5	22.9	21.4
			19			26765	821.5	22.7	22.0
						26865	831.5	22.8	21.9
						26965	841.5	22.6	21.8
			39			26765	821.5	22.4	21.5
						26865	831.5	22.7	21.5
						26965	841.5	22.6	21.6
		75	0			26765	821.5	22.8	21.7
						26865	831.5	22.9	21.5
						26965	841.5	22.9	21.9

Band	Bandwidth	RB Size	RB Offset	Channel	Frequency	QPSK	16QAM	
38	5 MHz	1	0	37775	2572.5	23.5	23.0	
				38000	2595.0	23.7	22.5	
				38225	2617.5	23.7	22.9	
			12	37775	2572.5	23.5	22.4	
				38000	2595.0	23.4	22.8	
				38225	2617.5	23.6	22.8	
			24	37775	2572.5	23.5	22.6	
				38000	2595.0	24.0	22.5	
				38225	2617.5	23.5	22.5	
		12	0	37775	2572.5	23.9	22.4	
				38000	2595.0	23.8	22.4	
				38225	2617.5	23.8	22.3	
			6	37775	2572.5	23.5	22.6	
				38000	2595.0	23.4	22.4	
				38225	2617.5	23.4	22.8	
			13	37775	2572.5	23.6	22.9	
				38000	2595.0	23.6	22.9	
				38225	2617.5	23.9	22.9	
		25	0	37775	2572.5	22.8	21.9	
				38000	2595.0	22.7	21.7	
				38225	2617.5	22.3	21.3	
		10 MHz	1	0	37800	2575.0	23.8	22.6
					38000	2595.0	23.4	22.8
					38200	2615.0	23.4	22.9
	24			37800	2575.0	23.5	22.9	
				38000	2595.0	23.6	22.9	
				38200	2615.0	23.3	22.4	
	49			37800	2575.0	23.5	22.5	
				38000	2595.0	23.9	22.4	
				38200	2615.0	23.6	22.7	
	25			0	37800	2575.0	22.3	21.9
					38000	2595.0	22.8	21.6
					38200	2615.0	22.3	22.0
				13	37800	2575.0	22.5	21.8
					38000	2595.0	22.9	21.6
					38200	2615.0	22.6	21.7
			25	37800	2575.0	22.9	21.6	
				38000	2595.0	22.6	21.6	
				38200	2615.0	22.4	21.8	
	50		0	37800	2575.0	23.0	21.8	
				38000	2595.0	22.5	22.0	
				38200	2615.0	22.9	21.4	

Band	Bandwidth	RB Size	RB Offset	Channel	Frequency	QPSK	16QAM	
38	15 MHz	1	0	37825	2577.5	23.4	22.4	
				38000	2595.0	23.9	22.6	
				38175	2612.5	23.9	22.9	
			37	37825	2577.5	23.9	22.6	
				38000	2595.0	24.0	22.3	
				38175	2612.5	23.9	22.4	
			74	37825	2577.5	23.9	22.7	
				38000	2595.0	23.4	22.8	
				38175	2612.5	23.5	22.4	
		36	0	37825	2577.5	22.4	21.8	
				38000	2595.0	22.7	21.5	
				38175	2612.5	22.8	21.9	
				19	37825	2577.5	23.0	22.0
					38000	2595.0	22.7	22.0
					38175	2612.5	22.6	21.9
			39	37825	2577.5	22.6	21.6	
				38000	2595.0	22.6	21.7	
				38175	2612.5	22.8	21.7	
			75	0	37825	2577.5	22.6	21.8
					38000	2595.0	22.9	21.8
					38175	2612.5	22.6	21.7
	20 MHz	1	0	37850	2580.0	23.4	22.7	
				38000	2595.0	23.3	22.6	
				38150	2610.0	23.9	22.9	
			49	37850	2580.0	23.6	22.5	
				38000	2595.0	23.8	23.0	
				38150	2610.0	23.7	22.4	
			99	37850	2580.0	23.8	22.7	
				38000	2595.0	24.0	22.7	
				38150	2610.0	23.9	22.3	
			50	0	37850	2580.0	22.7	21.8
					38000	2595.0	22.7	21.8
					38150	2610.0	22.8	21.3
				24	37850	2580.0	22.9	21.7
					38000	2595.0	22.4	22.0
					38150	2610.0	22.4	21.7
		50		37850	2580.0	22.5	22.0	
				38000	2595.0	22.5	21.9	
				38150	2610.0	22.9	21.4	
		100	0	37850	2580.0	22.7	21.6	
				38000	2595.0	22.5	21.6	
				38150	2610.0	22.8	21.5	

Band	Bandwidth	RB Size	RB Offset	Channel	Frequency	QPSK	16QAM	
41	5 MHz	1	0		39675	2498.5	23.4	23.0
					40148	2545.8	23.7	22.5
					40620	2593.0	23.5	22.5
					41093	2640.3	23.9	22.8
					41565	2687.5	23.5	23.0
			12		39675	2498.5	23.6	22.5
					40148	2545.8	23.6	22.9
					40620	2593.0	23.4	22.7
					41093	2640.3	23.7	22.4
					41565	2687.5	23.9	22.5
			24		39675	2498.5	23.6	22.6
					40148	2545.8	23.4	22.5
				40620	2593.0	23.5	22.7	
				41093	2640.3	23.8	22.4	
				41565	2687.5	23.9	22.8	
		12	0		39675	2498.5	22.8	21.6
					40148	2545.8	22.6	21.9
					40620	2593.0	22.5	21.8
					41093	2640.3	22.8	21.4
					41565	2687.5	22.8	21.6
			6		39675	2498.5	22.4	21.6
					40148	2545.8	22.5	21.3
					40620	2593.0	22.4	21.7
					41093	2640.3	22.9	21.8
					41565	2687.5	22.8	21.9
			13		39675	2498.5	22.5	21.9
					40148	2545.8	22.8	21.6
					40620	2593.0	22.6	21.8
					41093	2640.3	22.6	21.9
					41565	2687.5	22.5	21.9
		25	0		39675	2498.5	22.6	21.4
					40148	2545.8	22.4	21.5
	40620			2593.0	22.8	21.7		
	41093			2640.3	22.6	22.0		
	41565			2687.5	22.9	21.8		

Band	Bandwidth	RB Size	RB Offset	Channel	Frequency	QPSK	16QAM
41	10 MHz	1	0	39700	2501.0	23.3	22.9
				40160	2547.0	23.3	22.3
				40620	2593.0	23.8	22.9
				41080	2639.0	23.8	22.9
				41540	2685.0	23.4	22.5
			24	39700	2501.0	23.7	22.5
				40160	2547.0	23.9	22.7
				40620	2593.0	23.8	22.5
				41080	2639.0	23.7	22.4
				41540	2685.0	23.3	22.5
			49	39700	2501.0	23.4	22.5
				40160	2547.0	24.0	22.5
				40620	2593.0	23.8	22.4
				41080	2639.0	23.9	22.9
				41540	2685.0	23.6	22.7
		25	0	39700	2501.0	22.6	21.3
				40160	2547.0	22.9	21.9
				40620	2593.0	22.5	21.8
				41080	2639.0	23.0	22.0
				41540	2685.0	22.5	21.7
			13	39700	2501.0	22.9	21.5
				40160	2547.0	22.5	21.8
				40620	2593.0	22.9	21.9
				41080	2639.0	22.8	21.9
				41540	2685.0	22.7	21.3
			25	39700	2501.0	23.0	21.7
				40160	2547.0	22.5	21.5
				40620	2593.0	22.5	21.9
				41080	2639.0	22.6	21.6
				41540	2685.0	22.4	21.5
		50	0	39700	2501.0	22.4	21.4
				40160	2547.0	22.6	21.7
				40620	2593.0	22.9	21.5
				41080	2639.0	22.5	21.5
				41540	2685.0	22.9	21.6

Band	Bandwidth	RB Size	RB Offset	Channel	Frequency	QPSK	16QAM		
41	15 MHz	1	0		39725	2503.5	23.9	22.3	
					40173	2548.3	23.7	22.7	
					40620	2593.0	23.5	22.5	
					41068	2637.8	23.4	22.3	
					41515	2682.5	23.8	22.7	
				37		39725	2503.5	23.7	22.7
					40173	2548.3	24.0	22.6	
					40620	2593.0	23.9	22.8	
					41068	2637.8	23.7	22.4	
					41515	2682.5	23.3	22.3	
				74		39725	2503.5	24.0	22.9
					40173	2548.3	23.9	22.7	
			40620		2593.0	23.5	22.9		
			41068		2637.8	23.6	23.0		
			41515		2682.5	23.4	22.9		
			36	0		39725	2503.5	22.7	21.7
					40173	2548.3	22.7	21.9	
					40620	2593.0	22.9	21.4	
					41068	2637.8	22.4	21.4	
					41515	2682.5	22.8	21.9	
				19		39725	2503.5	22.7	21.9
					40173	2548.3	22.7	21.7	
					40620	2593.0	22.4	21.3	
					41068	2637.8	22.5	21.5	
					41515	2682.5	22.8	21.7	
				39		39725	2503.5	22.8	21.8
					40173	2548.3	23.0	21.9	
			40620		2593.0	22.4	21.9		
			41068		2637.8	22.3	21.6		
			41515		2682.5	22.9	22.0		
			75	0		39725	2503.5	22.8	21.8
					40173	2548.3	22.4	21.4	
	40620	2593.0			22.8	21.5			
	41068	2637.8			22.6	21.6			
	41515	2682.5			22.7	21.3			

Band	Bandwidth	RB Size	RB Offset	Channel	Frequency	QPSK	16QAM
41	20 MHz	1	0	39750	2506.0	23.4	22.4
				40185	2549.5	23.4	22.7
				40620	2593.0	23.9	22.5
				41055	2636.5	23.3	22.6
				41490	2680.0	24.0	22.9
			49	39750	2506.0	23.5	22.3
				40185	2549.5	23.9	22.3
				40620	2593.0	24.0	22.4
				41055	2636.5	23.7	22.9
				41490	2680.0	23.8	22.3
			99	39750	2506.0	23.4	22.9
				40185	2549.5	23.4	22.4
				40620	2593.0	23.8	22.7
				41055	2636.5	24.0	22.8
				41490	2680.0	23.9	22.5
		50	0	39750	2506.0	22.8	21.3
				40185	2549.5	23.0	21.9
				40620	2593.0	22.5	21.6
				41055	2636.5	22.4	21.3
				41490	2680.0	22.5	21.3
			24	39750	2506.0	22.6	21.4
				40185	2549.5	22.6	22.0
				40620	2593.0	22.9	21.4
				41055	2636.5	22.8	21.7
				41490	2680.0	22.4	21.9
50	39750		2506.0	22.4	22.0		
	40185		2549.5	23.0	21.9		
	40620		2593.0	22.3	21.3		
	41055		2636.5	22.5	21.9		
	41490		2680.0	22.4	21.4		
100	0	39750	2506.0	22.5	21.5		
		40185	2549.5	22.9	21.4		
		40620	2593.0	22.8	21.7		
		41055	2636.5	22.7	21.8		
		41490	2680.0	22.4	21.5		

Band	Bandwidth	RB Size	RB Offset	Channel	Frequency	QPSK	16QAM	
66	1.4 MHz	1	0	131979	1710.7	23.5	22.3	
				132322	1745.0	23.5	22.3	
				132665	1779.3	23.8	22.7	
			3	131979	1710.7	23.6	22.8	
				132322	1745.0	23.6	22.3	
				132665	1779.3	23.9	22.8	
			5	131979	1710.7	23.6	22.8	
				132322	1745.0	23.9	22.5	
				132665	1779.3	23.4	22.9	
		3	0	131979	1710.7	23.5	22.8	
				132322	1745.0	23.6	22.6	
				132665	1779.3	24.0	22.6	
			1	131979	1710.7	23.9	22.8	
				132322	1745.0	23.4	22.9	
				132665	1779.3	23.7	22.8	
			3	131979	1710.7	23.4	22.7	
				132322	1745.0	23.5	22.5	
				132665	1779.3	23.5	22.4	
		6	0	131979	1710.7	22.6	21.3	
				132322	1745.0	22.9	21.7	
				132665	1779.3	22.6	21.5	
		3 MHz	1	0	131987	1711.5	23.4	22.4
					132322	1745.0	23.4	22.6
					132657	1778.5	23.9	22.9
	7			131987	1711.5	23.6	22.5	
				132322	1745.0	23.7	23.0	
				132657	1778.5	23.8	22.9	
	14			131987	1711.5	23.7	22.8	
				132322	1745.0	23.9	22.5	
				132657	1778.5	23.4	22.7	
	8			0	131987	1711.5	22.7	21.5
					132322	1745.0	22.8	21.4
					132657	1778.5	22.5	21.7
			7	131987	1711.5	22.8	21.4	
				132322	1745.0	22.9	21.7	
				132657	1778.5	22.9	21.6	
			14	131987	1711.5	22.8	21.8	
				132322	1745.0	22.7	21.9	
				132657	1778.5	22.6	21.9	
	15		0	131987	1711.5	22.3	21.4	
				132322	1745.0	22.7	21.9	
				132657	1778.5	22.6	21.4	

Band	Bandwidth	RB Size	RB Offset	Channel	Frequency	QPSK	16QAM	
66	5 MHz	1	0	131997	1712.5	23.7	22.8	
				132322	1745.0	23.3	23.0	
				132646	1777.4	23.9	22.5	
			12	131997	1712.5	23.7	22.4	
				132322	1745.0	23.7	22.9	
				132646	1777.4	24.0	22.4	
			24	131997	1712.5	23.4	22.8	
				132322	1745.0	23.7	22.4	
				132646	1777.4	23.9	22.6	
		12	0	131997	1712.5	22.3	21.7	
				132322	1745.0	22.8	21.9	
				132646	1777.4	22.5	21.5	
			6	131997	1712.5	22.9	21.4	
				132322	1745.0	22.4	21.5	
				132646	1777.4	22.6	22.0	
			13	131997	1712.5	22.8	21.4	
				132322	1745.0	22.7	21.7	
				132646	1777.4	23.0	21.6	
			25	0	131997	1712.5	22.6	21.7
					132322	1745.0	22.7	21.4
					132646	1777.4	22.5	21.3
		10 MHz	1	0	132033	1716.1	23.3	22.8
					132322	1745.0	23.8	22.9
					132621	1774.9	23.7	22.7
	24			132033	1716.1	23.5	22.8	
				132322	1745.0	23.8	22.8	
				132621	1774.9	24.0	22.4	
	49			132033	1716.1	23.9	22.6	
				132322	1745.0	24.0	22.5	
				132621	1774.9	23.7	22.3	
	25			0	132033	1716.1	22.6	21.7
					132322	1745.0	22.7	21.9
					132621	1774.9	22.8	22.0
			13	132033	1716.1	22.8	21.4	
				132322	1745.0	22.9	21.9	
				132621	1774.9	22.4	21.9	
			25	132033	1716.1	22.9	21.8	
				132322	1745.0	22.8	21.4	
				132621	1774.9	22.7	21.8	
	50		0	132033	1716.1	22.5	21.3	
				132322	1745.0	22.9	21.6	
				132621	1774.9	22.8	21.8	

Band	Bandwidth	RB Size	RB Offset	Channel	Frequency	QPSK	16QAM	
66	15 MHz	1	0	132047	1717.5	23.9	22.8	
				132322	1745.0	23.8	22.7	
				132596	1772.4	23.4	22.8	
			37	132047	1717.5	23.4	22.4	
				132322	1745.0	23.9	22.3	
				132596	1772.4	23.4	22.6	
			74	132047	1717.5	24.0	22.9	
				132322	1745.0	23.8	22.5	
				132596	1772.4	23.6	22.5	
		36	0	132047	1717.5	22.5	21.8	
				132322	1745.0	22.6	21.3	
				132596	1772.4	22.8	22.0	
			19	132047	1717.5	22.7	21.7	
				132322	1745.0	23.0	21.9	
				132596	1772.4	22.7	21.4	
			39	132047	1717.5	23.0	21.4	
				132322	1745.0	22.9	21.6	
				132596	1772.4	22.4	21.9	
			75	0	132047	1717.5	22.7	21.7
					132322	1745.0	22.7	22.0
					132596	1772.4	22.6	21.8
		20 MHz	1	0	132072	1720.0	23.7	22.6
					132322	1745.0	23.5	22.6
					132571	1769.9	24.0	22.9
	49			132072	1720.0	23.7	22.8	
				132322	1745.0	23.5	22.9	
				132571	1769.9	23.6	22.7	
	99			132072	1720.0	23.9	22.5	
				132322	1745.0	23.3	22.9	
				132571	1769.9	23.4	22.4	
	50			0	132072	1720.0	22.6	21.9
					132322	1745.0	22.9	21.7
					132571	1769.9	23.0	21.8
			24	132072	1720.0	22.4	21.5	
				132322	1745.0	22.7	21.4	
				132571	1769.9	22.9	21.9	
			50	132072	1720.0	22.4	21.5	
				132322	1745.0	22.9	21.5	
				132571	1769.9	22.3	21.9	
	100		0	132072	1720.0	22.3	21.7	
				132322	1745.0	22.5	21.7	
				132571	1769.9	22.6	21.9	

Band	Bandwidth	RB Size	RB Offset	Channel	Frequency	QPSK	16QAM	
71	5 MHz	1	0	133147	665.5	24.0	22.6	
				133297	680.5	23.9	22.4	
				133447	695.5	23.8	23.0	
			12	133147	665.5	23.3	22.8	
				133297	680.5	24.0	22.9	
				133447	695.5	23.3	22.4	
			24	133147	665.5	23.9	22.6	
				133297	680.5	23.8	22.8	
				133447	695.5	23.9	22.4	
		12	0	133147	665.5	22.8	21.9	
				133297	680.5	22.5	22.0	
				133447	695.5	22.5	21.6	
				6	133147	665.5	22.3	21.3
					133297	680.5	22.3	21.9
					133447	695.5	22.8	21.7
			13	133147	665.5	22.3	21.4	
				133297	680.5	22.8	21.4	
				133447	695.5	22.8	21.6	
			25	0	133147	665.5	22.8	21.3
					133297	680.5	22.7	21.5
					133447	695.5	22.4	21.3
		10 MHz	1	0	133172	668.0	24.0	22.6
					133297	680.5	23.8	22.8
					133422	693.0	23.4	23.0
	24			133172	668.0	23.7	22.7	
				133297	680.5	23.3	22.9	
				133422	693.0	23.8	22.9	
	49			133172	668.0	23.6	23.0	
				133297	680.5	23.9	22.3	
				133422	693.0	23.5	22.6	
	25			0	133172	668.0	22.3	22.0
					133297	680.5	22.9	21.7
					133422	693.0	22.9	21.6
			13	133172	668.0	22.6	21.6	
				133297	680.5	22.8	21.7	
				133422	693.0	22.4	22.0	
			25	133172	668.0	22.9	21.4	
				133297	680.5	22.5	21.9	
				133422	693.0	22.5	21.8	
	50		0	133172	668.0	22.5	21.9	
				133297	680.5	22.7	21.6	
				133422	693.0	22.9	21.5	

Band	Bandwidth	RB Size	RB Offset	Channel	Frequency	QPSK	16QAM	
71	15 MHz	1	0	133197	670.5	23.8	22.7	
				133297	680.5	23.5	22.3	
				133397	690.5	23.8	22.9	
			37	133197	670.5	23.7	22.7	
				133297	680.5	24.0	22.7	
				133397	690.5	23.6	22.5	
			74	133197	670.5	23.6	23.0	
				133297	680.5	23.4	22.8	
				133397	690.5	23.6	22.7	
		36	0	133197	670.5	22.5	21.7	
				133297	680.5	22.5	21.6	
				133397	690.5	22.7	21.3	
				19	133197	670.5	22.8	22.0
					133297	680.5	22.7	21.9
					133397	690.5	22.7	21.5
			39	133197	670.5	22.9	21.5	
				133297	680.5	22.4	21.4	
				133397	690.5	22.7	21.7	
	75		0	133197	670.5	22.3	21.6	
				133297	680.5	22.7	22.0	
				133397	690.5	22.7	21.5	
	20 MHz	1	0	133222	673.0	23.6	22.5	
				133297	680.5	23.7	22.5	
				133372	688.0	23.7	22.7	
			49	133222	673.0	23.4	22.6	
				133297	680.5	23.3	22.3	
				133372	688.0	23.8	22.9	
			99	133222	673.0	23.6	22.8	
				133297	680.5	23.8	22.6	
				133372	688.0	23.9	22.7	
			50	0	133222	673.0	22.8	21.5
					133297	680.5	22.4	21.7
					133372	688.0	22.4	21.4
		24		133222	673.0	22.8	21.6	
				133297	680.5	22.7	21.8	
				133372	688.0	22.5	21.4	
		50		133222	673.0	22.9	21.4	
				133297	680.5	22.9	21.5	
				133372	688.0	22.3	21.9	
		100	0	133222	673.0	22.8	21.8	
				133297	680.5	22.7	21.9	
				133372	688.0	22.3	21.3	

Table 8.2 LTE Backoff Power Measurements

Band	Bandwidth	RB Size	RB Offset	Channel	Frequency	QPSK	16QAM	
2	1.4 MHz	1	0	18607	1850.7	21.6	21.0	
				18900	1880.0	21.7	20.9	
				19193	1909.3	21.4	20.9	
			3	3	18607	1850.7	22.0	20.6
					18900	1880.0	22.0	20.6
					19193	1909.3	21.5	20.6
				5	18607	1850.7	21.6	20.8
					18900	1880.0	21.3	21.0
					19193	1909.3	22.0	20.4
		3	0	18607	1850.7	21.9	20.7	
				18900	1880.0	22.0	21.0	
				19193	1909.3	21.6	20.3	
			1	18607	1850.7	21.4	20.5	
				18900	1880.0	21.3	20.6	
				19193	1909.3	21.6	20.4	
			3	18607	1850.7	21.9	20.9	
				18900	1880.0	21.7	20.6	
				19193	1909.3	21.6	20.6	
		6	0	18607	1850.7	20.6	19.4	
				18900	1880.0	20.4	19.9	
				19193	1909.3	20.6	19.7	
		3 MHz	1	0	18615	1851.5	21.6	20.3
					18900	1880.0	21.5	20.5
					19185	1908.5	21.7	20.6
	7			18615	1851.5	21.5	20.4	
				18900	1880.0	21.6	20.3	
				19185	1908.5	21.9	20.9	
	14			18615	1851.5	21.9	20.6	
				18900	1880.0	21.4	20.7	
				19185	1908.5	21.7	20.4	
	8			0	18615	1851.5	20.8	19.9
					18900	1880.0	20.5	19.8
					19185	1908.5	20.5	19.3
				7	18615	1851.5	20.4	19.7
					18900	1880.0	20.6	19.4
					19185	1908.5	21.0	19.7
			14	18615	1851.5	20.5	19.3	
				18900	1880.0	20.9	19.7	
				19185	1908.5	20.4	19.7	
	15		0	18615	1851.5	20.8	19.8	
				18900	1880.0	20.3	19.9	
				19185	1908.5	20.7	19.7	

Band	Bandwidth	RB Size	RB Offset	Channel	Frequency	QPSK	16QAM	
2	5 MHz	1	0	18625	1852.5	22.0	20.5	
				18900	1880.0	21.5	20.8	
				19175	1907.5	21.9	20.7	
			12	18625	1852.5	21.7	20.6	
				18900	1880.0	21.7	20.5	
				19175	1907.5	21.3	20.6	
		24	18625	1852.5	21.7	20.6		
			18900	1880.0	21.9	20.3		
			19175	1907.5	21.4	21.0		
		12	0	18625	1852.5	20.5	19.3	
				18900	1880.0	20.6	19.4	
				19175	1907.5	20.6	19.7	
			6	18625	1852.5	20.7	19.4	
				18900	1880.0	20.4	19.9	
				19175	1907.5	20.6	19.9	
			13	18625	1852.5	20.4	19.8	
				18900	1880.0	21.0	19.5	
				19175	1907.5	20.6	19.7	
			25	0	18625	1852.5	20.7	19.9
					18900	1880.0	20.8	19.8
					19175	1907.5	20.8	20.0
		10 MHz	1	0	18650	1855.0	21.7	20.4
					18900	1880.0	21.3	20.4
					19150	1905.0	22.0	20.3
	24			18650	1855.0	21.9	20.8	
				18900	1880.0	21.6	20.5	
				19150	1905.0	21.8	20.4	
	49			18650	1855.0	21.8	20.7	
				18900	1880.0	21.9	20.3	
				19150	1905.0	21.6	20.3	
	25			0	18650	1855.0	20.9	19.8
					18900	1880.0	20.4	19.9
					19150	1905.0	20.6	19.8
			13	18650	1855.0	20.4	19.4	
				18900	1880.0	21.0	19.8	
				19150	1905.0	20.7	19.9	
			25	18650	1855.0	20.5	19.7	
				18900	1880.0	20.6	19.9	
				19150	1905.0	20.3	19.4	
	50		0	18650	1855.0	20.9	19.8	
				18900	1880.0	20.5	19.8	
				19150	1905.0	21.0	19.3	

Band	Bandwidth	RB Size	RB Offset	Channel	Frequency	QPSK	16QAM	
2	15 MHz	1	0	18675	1857.5	21.6	20.6	
				18900	1880.0	21.8	21.0	
				19125	1902.5	21.5	20.6	
			37	18675	1857.5	21.6	20.7	
				18900	1880.0	21.9	20.5	
				19125	1902.5	21.9	20.7	
			74	18675	1857.5	21.6	20.9	
				18900	1880.0	22.0	20.5	
				19125	1902.5	21.6	20.4	
		36	0	18675	1857.5	20.8	19.7	
				18900	1880.0	20.7	19.3	
				19125	1902.5	20.4	19.5	
			19	18675	1857.5	20.6	19.8	
				18900	1880.0	20.7	19.8	
				19125	1902.5	20.5	19.8	
			39	18675	1857.5	20.8	19.5	
				18900	1880.0	20.5	19.3	
				19125	1902.5	20.9	19.8	
		75	0	18675	1857.5	20.9	19.6	
				18900	1880.0	20.6	19.7	
				19125	1902.5	20.3	19.4	
		20 MHz	1	0	18700	1860.0	21.5	21.0
					18900	1880.0	21.6	21.0
					19100	1900.0	21.5	20.4
	49			18700	1860.0	21.5	20.8	
				18900	1880.0	21.9	20.4	
				19100	1900.0	21.7	20.5	
	99			18700	1860.0	21.6	21.0	
				18900	1880.0	21.9	20.4	
				19100	1900.0	21.4	20.4	
	50			0	18700	1860.0	20.7	19.9
					18900	1880.0	20.7	19.7
					19100	1900.0	20.3	19.6
			24	18700	1860.0	20.6	19.8	
				18900	1880.0	20.4	19.7	
				19100	1900.0	20.9	19.6	
	50		18700	1860.0	20.6	19.5		
			18900	1880.0	20.6	19.3		
			19100	1900.0	20.7	20.0		
	100		0	18700	1860.0	20.7	19.6	
				18900	1880.0	20.8	19.4	
				19100	1900.0	20.9	19.4	

Band	Bandwidth	RB Size	RB Offset	Channel	Frequency	QPSK	16QAM		
25	1.4 MHz	1	0	26047	1850.7	21.8	20.3		
				26365	1882.5	21.5	20.8		
				26683	1914.3	21.5	20.8		
			3	26047	1850.7	21.8	20.8		
				26365	1882.5	21.5	20.4		
				26683	1914.3	21.8	20.9		
			5	26047	1850.7	21.5	20.3		
				26365	1882.5	21.7	20.4		
				26683	1914.3	21.6	20.6		
		3	0	26047	1850.7	21.8	20.4		
				26365	1882.5	21.9	20.5		
				26683	1914.3	22.0	20.5		
			1	26047	1850.7	21.4	20.7		
				26365	1882.5	21.4	20.6		
				26683	1914.3	21.8	20.5		
			3	26047	1850.7	21.6	20.4		
				26365	1882.5	21.3	20.9		
				26683	1914.3	21.8	20.9		
		6	0	26047	1850.7	20.5	19.6		
				26365	1882.5	20.6	19.7		
				26683	1914.3	20.5	20.0		
		3 MHz	1	0	26055	1851.5	21.7	20.7	
					26365	1882.5	21.9	21.0	
					26675	1913.5	21.7	20.5	
	7				26055	1851.5	21.9	20.9	
					26365	1882.5	21.9	20.9	
					26675	1913.5	21.8	20.6	
	14			26055	1851.5	21.8	20.4		
				26365	1882.5	21.5	20.7		
				26675	1913.5	21.6	20.9		
				8	0	26055	1851.5	20.8	19.5
						26365	1882.5	20.5	20.0
						26675	1913.5	20.4	19.9
	7				26055	1851.5	20.7	19.7	
					26365	1882.5	20.7	19.8	
					26675	1913.5	20.9	20.0	
	14		26055	1851.5	20.7	19.8			
			26365	1882.5	20.4	19.4			
			26675	1913.5	20.7	19.9			
			15	0	26055	1851.5	20.4	19.9	
					26365	1882.5	20.7	19.8	
					26675	1913.5	20.9	20.0	

Band	Bandwidth	RB Size	RB Offset	Channel	Frequency	QPSK	16QAM	
25	5 MHz	1	0	26065	1852.5	21.4	20.4	
				26365	1882.5	21.4	20.5	
				26665	1912.5	21.3	21.0	
			12	26065	1852.5	21.4	20.8	
				26365	1882.5	21.6	20.3	
				26665	1912.5	21.8	20.9	
			24	26065	1852.5	21.4	20.7	
				26365	1882.5	21.9	20.9	
				26665	1912.5	21.6	20.6	
		12	0	26065	1852.5	20.8	19.4	
				26365	1882.5	20.3	19.5	
				26665	1912.5	21.0	19.6	
			6	26065	1852.5	20.7	19.4	
				26365	1882.5	20.4	19.4	
				26665	1912.5	20.4	19.4	
			13	26065	1852.5	20.9	19.9	
				26365	1882.5	20.7	19.9	
				26665	1912.5	20.4	20.0	
			25	0	26065	1852.5	20.8	19.4
					26365	1882.5	20.5	19.8
					26665	1912.5	20.8	19.7
		10 MHz	1	0	26090	1855.0	21.7	20.4
					26365	1882.5	21.4	20.5
					26640	1910.0	21.6	21.0
	24			26090	1855.0	21.9	20.4	
				26365	1882.5	21.9	20.4	
				26640	1910.0	21.3	20.3	
	49			26090	1855.0	21.8	20.7	
				26365	1882.5	22.0	20.8	
				26640	1910.0	21.9	20.5	
	25			0	26090	1855.0	20.4	19.5
					26365	1882.5	20.6	19.9
					26640	1910.0	20.3	19.5
				13	26090	1855.0	20.5	19.7
					26365	1882.5	20.7	19.3
					26640	1910.0	20.5	19.8
			25	26090	1855.0	20.9	19.8	
				26365	1882.5	20.7	20.0	
				26640	1910.0	20.5	19.9	
	50		0	26090	1855.0	21.0	19.3	
				26365	1882.5	20.6	19.4	
				26640	1910.0	21.0	19.9	

Band	Bandwidth	RB Size	RB Offset	Channel	Frequency	QPSK	16QAM	
25	15 MHz	1	0	26115	1857.5	21.4	21.0	
				26365	1882.5	21.5	20.7	
				26615	1907.5	21.4	20.7	
			37	26115	1857.5	21.6	20.9	
				26365	1882.5	21.7	21.0	
				26615	1907.5	21.9	20.7	
			74	26115	1857.5	21.8	20.3	
				26365	1882.5	21.8	21.0	
				26615	1907.5	21.5	20.8	
		36	0	26115	1857.5	20.3	19.4	
				26365	1882.5	20.9	19.8	
				26615	1907.5	20.9	19.8	
			19	26115	1857.5	20.6	19.9	
				26365	1882.5	21.0	19.9	
				26615	1907.5	20.9	19.6	
			39	26115	1857.5	20.3	19.7	
				26365	1882.5	20.7	19.8	
				26615	1907.5	20.9	19.8	
		75	0	26115	1857.5	20.7	19.7	
				26365	1882.5	20.6	19.8	
				26615	1907.5	20.8	19.9	
	20 MHz	1	0	26140	1860.0	21.9	20.6	
				26365	1882.5	21.6	21.0	
				26590	1905.0	21.5	20.5	
			49	26140	1860.0	21.8	20.8	
				26365	1882.5	21.7	20.3	
				26590	1905.0	21.8	20.5	
			99	26140	1860.0	21.8	20.3	
				26365	1882.5	21.4	20.9	
				26590	1905.0	21.9	20.8	
			50	0	26140	1860.0	20.5	19.6
					26365	1882.5	20.7	19.4
					26590	1905.0	20.4	19.5
				24	26140	1860.0	20.6	19.5
					26365	1882.5	20.5	19.6
					26590	1905.0	20.7	19.9
		50		26140	1860.0	20.7	19.5	
				26365	1882.5	20.4	19.9	
				26590	1905.0	20.9	20.0	
		100	0	26140	1860.0	20.9	19.5	
				26365	1882.5	20.3	20.0	
				26590	1905.0	20.3	19.8	

Band	Mode	Channel	Frequency (MHz)	Power (dBm)
900 MHz	FHSS	1	917.5	29.88
		2	922.3	30.10
		3	927.1	29.93

9. SAR Test Results

General Note:

1. Per KDB 447498 D01v06, the reported SAR is the measured SAR value adjusted for maximum tune-up tolerance.
 - a. Tune-up scaling Factor = tune-up limit power (mW) / EUT RF power (mW), where tune-up limit is the maximum rated power among all production units.
 - b. For SAR testing of WLAN signal with non-100% duty cycle, the measured SAR is scaled-up by the duty cycle scaling factor which is equal to "1/(duty cycle)"
 - c. For WWAN: Reported SAR(W/kg)= Measured SAR(W/kg)*Tune-up Scaling Factor
 - d. For TDD LTE SAR measurement, the duty cycle 1:1.59 (62.9 %) was used perform testing and considering the theoretical duty cycle of 63.3% for extended cyclic prefix in the uplink, and the theoretical duty cycle of 62.9% for normal cyclic prefix in uplink, a scaling factor of extended cyclic prefix $63.3\%/62.9\% = 1.006$ is applied to scale-up the measured SAR result. The Reported TDD LTE SAR = measured SAR (W/kg)* Tune-up Scaling Factor* scaling factor for extended cyclic prefix.
2. Per KDB 447498 D01v06, for each exposure position, testing of other required channels within the operating mode of a frequency band is not required when the reported 1-g or 10-g SAR for the mid-band or highest output power channel is:
 - ≤ 0.8 W/kg or 2.0 W/kg, for 1-g or 10-g respectively, when the transmission band is ≤ 100 MHz
 - ≤ 0.6 W/kg or 1.5 W/kg, for 1-g or 10-g respectively, when the transmission band is between 100 MHz and 200 MHz
 - ≤ 0.4 W/kg or 1.0 W/kg, for 1-g or 10-g respectively, when the transmission band is ≥ 200 MHz
3. Per KDB 865664 D01v01r04, for each frequency band, repeated SAR measurement is required only when the measured SAR is ≥ 0.8 W/kg.

UMTS Note:

1. Per KDB 941225 D01v03r01, for SAR testing is measured using a 12.2 kbps RMC with TPC bits configured to all "1's".
2. Per KDB 941225 D01v03r01, RMC 12.2kbps setting is used to evaluate SAR. The maximum output power and tune-up tolerance specified for production units in HSDPA / HSUPA / DC-HSDPA is $\leq 1/4$ dB higher than RMC 12.2Kbps or when the highest reported SAR of the RMC12.2Kbps is scaled by the ratio of specified maximum output power and tune-up tolerance of HSDPA / HSUPA / DC-HSDPA to RMC12.2Kbps and the adjusted SAR is ≤ 1.2 W/kg, SAR measurement is not required for HSDPA / HSUPA / DC-HSDPA, and according to the following RF output power, the output power results of the secondary modes (HSUPA, HSDPA, DC-HSDPA) are less than $1/4$ dB higher than the primary modes; therefore, SAR measurement is not required for HSDPA / HSUPA / DC-HSDPA.

LTE Note:

1. Per KDB 941225 D05v02r05, start with the largest channel bandwidth and measure SAR for QPSK with 1 RB allocation, using the RB offset and required test channel combination with the highest maximum output power for RB offsets at the upper edge, middle and lower edge of each required test channel.
2. Per KDB 941225 D05v02r05, 50% RB allocation for QPSK SAR testing follows 1RB QPSK allocation procedure.
3. Per KDB 941225 D05v02r05, For QPSK with 100% RB allocation, SAR is not required when the highest maximum output power for 100 % RB allocation is less than the highest maximum output power in 50% and 1 RB allocations and the highest reported SAR for 1 RB and 50% RB allocation are ≤ 0.8 W/kg. Otherwise, SAR is measured for the highest output power channel; and if the reported SAR is > 1.45 W/kg, the remaining required test channels must also be tested.
4. Per KDB 941225 D05v02r05, 16QAM output power for each RB allocation configuration is $> \text{not } 1/2$ dB higher than the same configuration in QPSK and the reported SAR for the QPSK configuration is ≤ 1.45 W/kg; Per KDB 941225 D05v02r05, 16QAM SAR testing is not required.
5. Per KDB 941225 D05v02r05, Smaller bandwidth output power for each RB allocation configuration is $> \text{not } 1/2$ dB higher than the same configuration in the largest supported bandwidth, and the reported SAR for the largest supported bandwidth is ≤ 1.45 W/kg; Per KDB 941225 D05v02r05, smaller bandwidth SAR testing is not required.
6. For LTE B13/B14 the maximum bandwidth does not support three non-overlapping channels, per KDB 941225 D05v02r05, when a device supports overlapping channel assignment in a channel bandwidth configuration, the middle channel of the group of overlapping channels should be selected for testing.
7. LTE band 2/4/5/38 SAR test was covered by Band 25/66/26/41; according to TCB workshop, SAR test for overlapping LTE bands can be reduced if
 - a. The maximum output power, including tolerance, for the smaller band is \leq the larger band to qualify for the SAR test exclusion.
 - b. The channel bandwidth and other operating parameters for the smaller band are fully supported by the larger band.

Plot No.	Band	Mode	Test Position	Gap (mm)	Ch.	Freq. (MHz)	Average Power (dBm)	Tune-Up Limit (dBm)	Measured 1g SAR (W/kg)	Reported 1g SAR (W/kg)
	WCDMA II_Ant 0	RMC 12.2Kbps	Back	0mm	9400	1880	21.84	22.0	0.582	0.60
1	WCDMA II_Ant 0	RMC 12.2Kbps	Right	0mm	9262	1852.4	21.72	22.0	1.05	1.12
	WCDMA II_Ant 0	RMC 12.2Kbps		0mm	9400	1880	21.84	22.0	1.02	1.06
	WCDMA II_Ant 0	RMC 12.2Kbps		0mm	9538	1907.6	21.87	22.0	0.992	1.02
	WCDMA II_Ant 0	RMC 12.2Kbps		Right	0mm	9262	1852.4	21.72	22.0	1.03
	WCDMA II_Ant 0	RMC 12.2Kbps	Right	8mm	9262	1852.4	23.87	24.0	0.867	0.89
	WCDMA IV_Ant 0	RMC 12.2Kbps	Back	0mm	1413	1732.6	23.93	24.0	0.332	0.34
	WCDMA IV_Ant 0	RMC 12.2Kbps	Right	0mm	1312	1712.4	23.87	24.0	1.10	1.13
	WCDMA IV_Ant 0	RMC 12.2Kbps		0mm	1413	1732.6	23.93	24.0	1.16	1.18
2	WCDMA IV_Ant 0	RMC 12.2Kbps		0mm	1513	1752.6	23.73	24.0	1.21	1.29
	WCDMA IV_Ant 0	RMC 12.2Kbps		Right	0mm	1413	1732.6	23.73	24.0	1.19
	WCDMA V_Ant 0	RMC 12.2Kbps	Back	0mm	4183	836.6	23.98	24.0	0.287	0.29
3	WCDMA V_Ant 0	RMC 12.2Kbps	Right	0mm	4183	836.6	23.98	24.0	0.629	0.63

Plot No.	Band	BW (MHz)	Modulation	RB Size	RB offset	Test Position	Gap (mm)	Ch.	Freq. (MHz)	Average Power (dBm)	Tune-Up Limit (dBm)	Measured 1g SAR (W/kg)	Reported 1g SAR (W/kg)
4	LTE Band 7_Ant 0	20M	QPSK	1	49	Back	0mm	21100	2535	23.9	24.0	0.241	0.25
	LTE Band 7_Ant 0	20M	QPSK	50	24		0mm	21100	2535	22.9	23.0	0.203	0.21
	LTE Band 7_Ant 0	20M	QPSK	1	49	Right	0mm	20850	2510	23.6	24.0	1.04	1.14
	LTE Band 7_Ant 0	20M	QPSK	1	49		0mm	21100	2535	23.9	24.0	1.14	1.17
	LTE Band 7_Ant 0	20M	QPSK	1	49		0mm	21350	2560	23.6	24.0	1.06	1.16
	LTE Band 7_Ant 0	20M	QPSK	50	24		0mm	20850	2510	22.9	23.0	0.812	0.83
	LTE Band 7_Ant 0	20M	QPSK	50	24		0mm	21100	2535	22.9	23.0	0.897	0.92
	LTE Band 7_Ant 0	20M	QPSK	50	24		0mm	21350	2560	22.6	23.0	0.844	0.93
	LTE Band 7_Ant 0	20M	QPSK	100	0		0mm	21100	2535	22.7	23.0	0.786	0.84
	LTE Band 7_Ant 0	20M	QPSK	1	49		Right	0mm	21100	2535	23.9	24.0	1.12
LTE Band 12_Ant 0	10M	QPSK	1	24	Back	0mm	23095	707.5	23.7	24.0	0.268	0.29	
LTE Band 12_Ant 0	10M	QPSK	25	12		0mm	23095	707.5	22.7	23.0	0.211	0.23	
5	LTE Band 12_Ant 0	10M	QPSK	1	24	Right	0mm	23095	707.5	23.7	24.0	0.565	0.61
	LTE Band 12_Ant 0	10M	QPSK	25	12		0mm	23095	707.5	22.7	23.0	0.501	0.54
6	LTE Band 13_Ant 0	10M	QPSK	1	24	Back	0mm	23230	782	23.9	24.0	0.347	0.36
	LTE Band 13_Ant 0	10M	QPSK	25	12		0mm	23230	782	22.4	23.0	0.316	0.36
	LTE Band 13_Ant 0	10M	QPSK	1	24	Right	0mm	23230	782	23.9	24.0	0.561	0.57
	LTE Band 13_Ant 0	10M	QPSK	25	12		0mm	23230	782	22.4	23.0	0.527	0.61
7	LTE Band 14_Ant 0	10M	QPSK	1	24	Back	0mm	23330	793	23.9	24.0	0.288	0.30
	LTE Band 14_Ant 0	10M	QPSK	25	12		0mm	23330	793	22.6	23.0	0.241	0.26
	LTE Band 14_Ant 0	10M	QPSK	1	24	Right	0mm	23330	793	23.9	24.0	0.971	0.99
	LTE Band 14_Ant 0	10M	QPSK	25	12		0mm	23330	793	22.6	23.0	0.852	0.93
LTE Band 14_Ant 0	10M	QPSK	1	24	Right	0mm	23330	793	23.9	24.0	0.952	0.97	
8	LTE Band 25_Ant 0	20M	QPSK	1	49	Back	0mm	26365	1882.5	21.7	22.0	0.211	0.23
	LTE Band 25_Ant 0	20M	QPSK	50	24		0mm	26365	1882.5	20.5	21.0	0.186	0.21
	LTE Band 25_Ant 0	20M	QPSK	1	49	Right	0mm	26140	1860	21.8	22.0	1.15	1.20
	LTE Band 25_Ant 0	20M	QPSK	1	49		0mm	26365	1882.5	21.7	22.0	0.992	1.06
	LTE Band 25_Ant 0	20M	QPSK	1	49		0mm	26590	1905	21.8	22.0	1.01	1.06
	LTE Band 25_Ant 0	20M	QPSK	50	24		0mm	26140	1860	20.6	21.0	0.958	1.05
	LTE Band 25_Ant 0	20M	QPSK	50	24		0mm	26365	1882.5	20.5	21.0	0.921	1.03
	LTE Band 25_Ant 0	20M	QPSK	50	24		0mm	26590	1905	20.7	21.0	0.936	1.00
	LTE Band 25_Ant 0	20M	QPSK	100	0		0mm	26140	1860	20.3	21.0	0.852	1.00
	LTE Band 25_Ant 0	20M	QPSK	1	49		Right	0mm	26365	1860	21.8	22.0	1.14
LTE Band 25_Ant 0	20M	QPSK	1	49	Right	8mm	26365	1860	24.0	24.0	0.853	0.85	
9	LTE Band 26_Ant 0	10M	QPSK	1	24	Back	0mm	26865	831.5	23.3	24.0	0.139	0.16
	LTE Band 26_Ant 0	10M	QPSK	25	12		0mm	26865	831.5	22.8	23.0	0.101	0.11
	LTE Band 26_Ant 0	10M	QPSK	1	24	Right	0mm	26865	831.5	23.3	24.0	0.276	0.32
	LTE Band 26_Ant 0	10M	QPSK	25	12		0mm	26865	831.5	22.8	23.0	0.254	0.27
10	LTE Band 41_Ant 0	20M	QPSK	1	49	Back	0mm	40620	2593	24.0	24.0	0.120	0.12
	LTE Band 41_Ant 0	20M	QPSK	50	24		0mm	40620	2593	22.9	23.0	0.0974	0.10
	LTE Band 41_Ant 0	20M	QPSK	1	49	Right	0mm	40620	2593	24.0	24.0	0.695	0.70
	LTE Band 41_Ant 0	20M	QPSK	50	24		0mm	40620	2593	22.9	23.0	0.622	0.64
11	LTE Band 66_Ant 0	20M	QPSK	1	49	Back	0mm	132322	1745	23.5	24.0	0.180	0.20
	LTE Band 66_Ant 0	20M	QPSK	50	24		0mm	132322	1745	22.7	23.0	0.113	0.12
	LTE Band 66_Ant 0	20M	QPSK	1	49	Right	0mm	132322	1745	23.5	24.0	0.616	0.69
	LTE Band 66_Ant 0	20M	QPSK	50	24		0mm	132322	1745	22.7	23.0	0.547	0.59
12	LTE Band 71_Ant 0	20M	QPSK	1	49	Back	0mm	133222	680.5	23.3	24.0	0.153	0.18
	LTE Band 71_Ant 0	20M	QPSK	50	24		0mm	133222	680.5	22.7	23.0	0.102	0.11
	LTE Band 71_Ant 0	20M	QPSK	1	49	Right	0mm	133222	680.5	23.3	24.0	0.452	0.53
	LTE Band 71_Ant 0	20M	QPSK	50	24		0mm	133222	680.5	22.7	23.0	0.422	0.45

Plot No.	Band	Modulation	Test Position	Gap (mm)	Ch.	Freq. (MHz)	Average Power (dBm)	Tune-Up Limit (dBm)	Measured 10g SAR (W/kg)	Reported 10g SAR (W/kg)
13	Micro 900 MHz	FM	Back	0mm	Mid	915	30.1	31.0	1.65	2.03
	Micro 900 MHz	FM	Right	0mm	Mid	915	30.1	31.0	0.127	0.16
	Micro 900 MHz	FM	Top	0mm	Mid	915	30.1	31.0	0.281	0.35

10. Simultaneous Transmission Analysis

The WiFi data is located in report number SAR.20230901. The data listed in the tables below was extracted from the reports filed with this report.

Sim-Tx configuration

No.	Simultaneous Transmission Configuration	Exposure Positions
		Body
1	UMTS + 2.4 GHz Wifi 0 + 2.4 GHz WiFi 1 + BT	Yes
2	UMTS + 5 GHz Wifi 0 + 5 GHz WiFi 1 + BT	Yes
3	LTE + 2.4 GHz Wifi 0 + 2.4 GHz WiFi 1 + BT	Yes
4	LTE + 5 GHz Wifi 0 + 5 GHz WiFi 1 + BT	Yes

General Note:

1. The worst case WLAN reported SAR for each configuration was used for SAR summation, regardless of whether the WLAN channel has Hotspot capability. Therefore, the following summations represent the absolute worst cases for simultaneous transmission with WLAN.
2. The Scaled SAR summation is calculated based on the same configuration and test position.

Body Exposure Conditions

WWAN Band	Exposure Position	1	2	3	4	5	6	1+2+3+6 Summed 1g SAR (W/kg)	1+4+5+6 Summed 1g SAR (W/kg)
		WWAN	2.4GHz Wi-Fi Pri	2.4GHz Wi-Fi Sec	5-6GHz Wi-Fi Pri	5-6GHz Wi-Fi Sec	Bluetooth		
		1g SAR (W/kg)	1g SAR (W/kg)	1g SAR (W/kg)	1g SAR (W/kg)	1g SAR (W/kg)	1g SAR (W/kg)		
WCDMA II Ant 0	Back	0.60	0.21	0.13	1.00	0.67	0.55	1.71	1.73
	Top		0.27		0.65		0.37	0.67	0.79
	Right	1.12		0.57		1.25		1.18	1.33
	Left		0.26		1.15			0.21	0.26
WCDMA IV Ant 0	Back	0.34	0.21	0.13	1.00	0.67	0.55	0.59	0.72
	Top		0.27		0.65		0.37	0.44	0.54
	Right	1.29		0.57		1.25		0.80	0.82
	Left		0.26		1.15			0.32	0.44
WCDMA V Ant 0	Back	0.29	0.21	0.13	1.00	0.67	0.55	1.25	1.40
	Top		0.27		0.65		0.37	0.84	0.89
	Right	0.63		0.57		1.25		0.04	0.17
	Left		0.26		1.15			0.09	0.19
LTE Band 7 Ant 0	Back	0.25	0.21	0.13	1.00	0.67	0.55	1.63	1.65
	Top		0.27		0.65		0.37	1.20	1.32
	Right	1.17		0.57		1.25		0.65	0.80
	Left		0.26		1.15			0.21	0.26
LTE Band 12 Ant 0	Back	0.29	0.21	0.13	1.00	0.67	0.55	0.59	0.72
	Top		0.27		0.65		0.37	0.95	1.05
	Right	0.61		0.57		1.25		0.00	0.00
	Left		0.26		1.15			0.00	0.00
LTE Band 13 Ant 0	Back	0.36	0.21	0.13	1.00	0.67	0.55	0.55	0.55
	Top		0.27		0.65		0.37	0.37	0.37
	Right	0.57		0.57		1.25		0.00	0.00
	Left		0.26		1.15			0.11	0.21
LTE Band 14 Ant 0	Back	0.30	0.21	0.13	1.00	0.67	0.55	1.29	1.31
	Top		0.27		0.65		0.37	0.53	0.65
	Right	0.99		0.57		1.25		0.57	0.72
	Left		0.26		1.15			0.57	0.62
LTE Band 25 Ant 0	Back	0.23	0.21	0.13	1.00	0.67	0.55	0.59	0.72
	Top		0.27		0.65		0.37	0.78	0.88
	Right	1.20		0.57		1.25		1.14	1.16
	Left		0.26		1.15			0.09	0.21
LTE Band 26 Ant 0	Back	0.16	0.21	0.13	1.00	0.67	0.55	1.14	1.29
	Top		0.27		0.65		0.37	0.68	0.73
	Right	0.32		0.57		1.25		0.04	0.17
	Left		0.26		1.15			0.07	0.17
LTE Band 41 Ant 0	Back	0.12	0.21	0.13	1.00	0.67	0.55	1.84	1.86
	Top		0.27		0.65		0.37	1.20	1.32
	Right	0.70		0.57		1.25		0.70	0.85
	Left		0.26		1.15			0.21	0.26
LTE Band 66 Ant 0	Back	0.20	0.21	0.13	1.00	0.67	0.55	0.59	0.72
	Top		0.27		0.65		0.37	1.08	1.18
	Right	0.69		0.57		1.25		1.07	1.09
	Left		0.26		1.15			0.19	0.31
LTE Band 71 Ant 0	Back	0.18	0.21	0.13	1.00	0.67	0.55	1.69	1.84
	Top		0.27		0.65		0.37	0.78	0.83
	Right	0.53		0.57		1.25		0.04	0.17
	Left		0.26		1.15			0.96	1.06

The summation of the transmitters does not meet the limit. Therefore, below are the calculation for the separation ratio for each of the pairs of antennas with the worst cast SAR value for each antenna used in the calculation.

The formula is $(SAR_1 + SAR_2)^{0.5}/R_i \leq 0.4$

Maximum SAR Values by Antenna:

WWAN Maximum SAR = 1.29 W/kg

WiFi Primary Maximum SAR = 1.15 W/kg

WiFi Secondary Maximum SAR = 1.25 W/kg

Bluetooth Maximum SAR = 0.55 W/kg

Minimum Distance Between Antenna Pairs:

WWAN – WiFi Primary = 133 mm

WWAN – WiFi Secondary = 43 mm

WWAN – Bluetooth = 107 mm

WiFi Primary – WiFi Secondary = 104 mm

WiFi Primary – Bluetooth = 24 mm

WiFi Secondary – Bluetooth = 62 mm

The calculations are shown below:

WWAN – WiFi Primary = $(1.29+1.15)^{0.5}/133 = 0.01$

WWAN – WiFi Secondary = $(1.29+1.25)^{0.5}/43 = 0.04$

WWAN – Bluetooth = $(1.29+0.55)^{0.5}/107 = 0.01$

WiFi Primary – WiFi Secondary = $(1.15+1.25)^{0.5}/104 = 0.02$

WiFi Primary – Bluetooth = $(1.15+0.55)^{0.5}/32 = 0.04$

WiFi Secondary – Bluetooth = $(1.25+0.55)^{0.5}/62 = 0.02$

11. Test Equipment List

Table 11.1 Equipment Specifications

Type	Calibration Due Date	Calibration Done Date	Serial Number
Staubli Robot TX60L	N/A	N/A	F07/55M6A1/A/01
Measurement Controller CS8c	N/A	N/A	1012
ELI4 Flat Phantom	N/A	N/A	1065
Device Holder	N/A	N/A	N/A
Data Acquisition Electronics 4	02/15/2020	02/15/2019	1416
SPEAG E-Field Probe EX3DV4	08/27/2019	08/27/2018	7530
Speag Validation Dipole D750V2	06/04/2024	06/04/2021	1053
Speag Validation Dipole D900V2	06/04/2024	06/04/2021	1d128
Speag Validation Dipole D1750V2	06/03/2024	06/03/2021	1061
Speag Validation Dipole D1900V2	06/04/2024	06/04/2021	5d147
Speag Validation Dipole D2550V2	06/03/2024	06/03/2021	1003
Agilent N1911A Power Meter	03/14/2024	03/14/2023	GB45100254
Agilent N1922A Power Sensor	03/13/2024	03/13/2023	MY45240464
Agilent (HP) 8596E Spectrum Analyzer	03/13/2024	03/13/2023	3826A01468
Agilent (HP) 83752A Synthesized Sweeper	03/14/2024	03/14/2023	3610A01048
Agilent (HP) 8753C Vector Network Analyzer	03/14/2024	03/14/2023	3135A01724
Agilent (HP) 85047A S-Parameter Test Set	03/14/2024	03/14/2023	2904A00595
Copper Mountain R140 Vector Reflectometer	03/13/2024	03/13/2023	21390004
Agilent (HP) 8960 Base Station Sim.	N/A	N/A	MY48360364
Anritsu MT8820C	N/A	N/A	6201176199
Apriel Dielectric Probe Assembly	N/A	N/A	0011
Head Equivalent Matter (750 MHz)	N/A	N/A	N/A
Head Equivalent Matter (900 MHz)	N/A	N/A	N/A
Head Equivalent Matter (1750 MHz)	N/A	N/A	N/A
Head Equivalent Matter (1900 MHz)	N/A	N/A	N/A
Head Equivalent Matter (2550 MHz)	N/A	N/A	N/A

12. Conclusion

The SAR measurement indicates that the EUT complies with the RF radiation exposure limits of the FCC/IC. These measurements are taken to simulate the RF effects exposure under worst-case conditions. Precise laboratory measures were taken to assure repeatability of the tests. The tested device complies with the requirements in respect to all parameters subject to the test. The test results and statements relate only to the item(s) tested.

Please note that the absorption and distribution of electromagnetic energy in the body is a very complex phenomena that depends on the mass, shape, and size of the body; the orientation of the body with respect to the field vectors; and, the electrical properties of both the body and the environment. Other variables that may play a substantial role in possible biological effects are those that characterize the environment (e.g. ambient temperature, air velocity, relative humidity, and body insulation) and those that characterize the individual (e.g. age, gender, activity level, debilitation, or disease). Because innumerable factors may interact to determine the specific biological outcome of an exposure to electromagnetic fields, any protection guide shall consider maximal amplification of biological effects as a result of field-body interactions, environmental conditions, and physiological variables.

13. References

- [1] Federal Communications Commission, ET Docket 93-62, Guidelines for Evaluating the Environmental Effects of Radio Frequency Radiation, August 1996
- [2] ANSI/IEEE C95.1 – 1992, American National Standard Safety Levels with respect to Human Exposure to Radio Frequency Electromagnetic Fields, 300kHz to 100GHz, New York: IEEE, 1992.
- [3] ANSI/IEEE C95.3 – 1992, IEEE Recommended Practice for the Measurement of Potentially Hazardous Electromagnetic Fields – RF and Microwave, New York: IEEE, 1992.
- [4] International Electrotechnical Commission, IEC 62209-2 (Edition 1.0), Human Exposure to radio frequency fields from hand-held and body mounted wireless communication devices – Human models, instrumentation, and procedures – Part 2: Procedure to determine the specific absorption rate (SAR) for wireless communication devices used in close proximity to the human body (frequency range of 30 MHz to 6 GHz), March 2010.
- [5] IEEE Standard 1528 – 2013, IEEE Recommended Practice for Determining the Peak-Spatial Average Specific Absorption Rate (SAR) in the Human Head from Wireless Communication Devices: Measurement Techniques, June 2013.
- [6] Industry Canada, RSS – 102 Issue 5, Radio Frequency Exposure Compliance of Radiocommunication Apparatus (All Frequency Bands), March 2015.
- [7] Health Canada, Safety Code 6, Limits of Human Exposure to Radiofrequency Electromagnetic Fields in the Frequency Range from 3kHz to 300 GHz, 2009.

Appendix A – System Validation Plots and Data

Test Result for UIM Dielectric Parameter

Tue 05/Sep/2023

Freq Frequency(GHz)

FCC_eH Limits for Head Epsilon

FCC_sH Limits for Head Sigma

Test_e Epsilon of UIM

Test_s Sigma of UIM

Freq	FCC_eH	FCC_sH	Test_e	Test_s
0.6500	42.46	0.88	41.49	0.86
0.6600	42.41	0.88	41.43	0.87
0.6700	42.36	0.89	41.37	0.87
0.6800	42.31	0.89	41.31	0.87
0.6805	42.307	0.89	41.307	0.871*
0.6900	42.25	0.89	41.25	0.88
0.7000	42.20	0.89	41.19	0.88
0.7075	42.163	0.89	41.138	0.888*
0.7100	42.15	0.89	41.12	0.89
0.7200	42.10	0.89	41.07	0.90
0.7255	42.073	0.89	41.032	0.906*
0.7300	42.05	0.89	41.00	0.91
0.7400	41.99	0.89	40.94	0.91
0.7500	41.94	0.89	40.89	0.92
0.7600	41.89	0.89	40.83	0.93
0.7700	41.84	0.89	40.77	0.94
0.7800	41.79	0.90	40.71	0.94
0.7820	41.778	0.90	40.698	0.942*
0.7900	41.73	0.90	40.65	0.95
0.7930	41.715	0.90	40.638	0.95*
0.8000	41.68	0.90	40.61	0.95

* value interpolated

Test Result for UIM Dielectric Parameter
Wed 06/Sep/2023
Freq Frequency(GHz)
eH Limits for Head Epsilon
sH Limits for Head Sigma
Test_e Epsilon of UIM
Test_s Sigma of UIM

Freq	eH	sH	Test_e	Test_s
0.8000	41.68	0.90	41.04	0.91
0.8100	41.63	0.90	40.99	0.92
0.8200	41.58	0.90	40.93	0.93
0.8300	41.53	0.90	40.98	0.93
0.8315	41.526	0.902	40.976	0.932*
0.8365	41.511	0.907	40.961	0.937*
0.8366	41.51	0.907	40.96	0.937*
0.8400	41.50	0.91	40.95	0.94
0.8470	41.50	0.917	40.936	0.947*
0.8500	41.50	0.92	40.93	0.95
0.8600	41.50	0.93	40.91	0.96
0.8666	41.50	0.937	40.897	0.967*
0.8700	41.50	0.94	40.89	0.97
0.8800	41.50	0.95	40.88	0.98
0.8900	41.50	0.96	40.87	0.99
0.8975	41.50	0.968	40.863	0.998*
0.8976	41.50	0.968	40.862	0.998*
0.9000	41.50	0.97	40.86	1.00
0.9100	41.50	0.98	40.85	1.01
0.9150	41.495	0.98	40.845	1.01*
0.9200	41.49	0.98	40.84	1.01
0.9230	41.487	0.983	40.837	1.013*
0.9300	41.48	0.99	40.83	1.02

* value interpolated

Test Result for UIM Dielectric Parameter
Fri 08/Sep/2023
Freq Frequency(GHz)
eH Limits for Head Epsilon
sH Limits for Head Sigma
Test_e Epsilon of UIM
Test_s Sigma of UIM

Freq	eH	sH	Test_e	Test_s
1.7000	40.16	1.34	39.49	1.35
1.7100	40.14	1.35	39.47	1.36
1.7124	40.138	1.35	39.465	1.362*
1.7200	40.13	1.35	39.45	1.37
1.7300	40.11	1.36	39.43	1.37
1.7326	40.105	1.363	39.425	1.373*
1.7400	40.09	1.37	39.41	1.38
1.7450	40.085	1.37	39.40	1.385*
1.7475	40.083	1.37	39.395	1.388*
1.7500	40.08	1.37	39.39	1.39
1.7526	40.075	1.373	39.385	1.393*
1.7600	40.06	1.38	39.37	1.40
1.7700	40.05	1.38	39.35	1.41
1.7800	40.03	1.39	39.33	1.41
1.7900	40.02	1.39	39.31	1.42

* value interpolated

Test Result for UIM Dielectric Parameter
Fri 08/Sep/2023
Freq Frequency(GHz)
eH Limits for Head Epsilon
sH Limits for Head Sigma
Test_e Epsilon of UIM
Test_s Sigma of UIM

Freq	eH	sH	Test_e	Test_s
1.8500	40.00	1.40	39.75	1.40
1.8524	40.00	1.40	39.745	1.402*
1.8600	40.00	1.40	39.73	1.41
1.8700	40.00	1.40	39.71	1.41
1.8800	40.00	1.40	39.69	1.42
1.8825	40.00	1.40	39.685	1.42*
1.8900	40.00	1.40	39.67	1.42
1.9000	40.00	1.40	39.65	1.42
1.9050	40.00	1.40	39.64	1.425*
1.9100	40.00	1.40	39.63	1.43
1.9200	40.00	1.40	39.62	1.44
1.9300	40.00	1.40	39.60	1.44
1.9400	40.00	1.40	39.59	1.44
1.9500	40.00	1.40	39.58	1.45
1.9600	40.00	1.40	39.56	1.45
1.9700	40.00	1.40	39.55	1.45
1.9776	40.00	1.40	39.542	1.458*
1.9800	40.00	1.40	39.54	1.46
1.9900	40.00	1.40	39.52	1.46

* value interpolated

Test Result for UIM Dielectric Parameter
Sun 10/Sep/2023
Freq Frequency(GHz)
FCC_eH Limits for Head Epsilon
FCC_sH Limits for Head Sigma
Test_e Epsilon of UIM
Test_s Sigma of UIM

Freq	FCC_eH	FCC_sH	Test_e	Test_s
2.4900	39.15	1.84	38.83	1.85
2.5000	39.14	1.85	38.81	1.86
2.5100	39.12	1.87	38.78	1.87
2.5200	39.11	1.88	38.76	1.89
2.5300	39.10	1.89	38.74	1.90
2.5350	39.095	1.895	38.725	1.905*
2.5400	39.09	1.90	38.71	1.91
2.5500	39.075	1.91	38.69	1.925*
2.5600	39.06	1.92	38.67	1.94
2.5700	39.05	1.93	38.64	1.95
2.5800	39.03	1.94	38.62	1.97
2.5900	39.02	1.95	38.59	1.98
2.5930	39.017	1.953	38.593	1.98*
2.6000	39.01	1.96	38.60	1.98
2.6100	39.00	1.97	38.58	1.99
2.6200	38.98	1.99	38.57	2.00
2.6300	38.97	2.00	38.55	2.01
2.6400	38.96	2.01	38.53	2.02
2.6500	38.95	2.02	38.51	2.03
2.6600	38.93	2.03	38.50	2.04
2.6700	38.92	2.04	38.48	2.05
2.6800	38.91	2.05	38.46	2.06
2.6900	38.89	2.06	38.44	2.07
2.7000	38.88	2.07	38.43	2.08

* value interpolated

RF Exposure Lab

Plot 1

DUT: Dipole 750 MHz D750V3; Type: D750V3; Serial: D750V3 - SN 1053

Communication System: CW; Frequency: 750 MHz; Duty Cycle: 1:1
Medium: HSL750; Medium parameters used (interpolated): $f = 750$ MHz; $\sigma = 0.92$ S/m; $\epsilon_r = 40.89$; $\rho = 1000$ kg/m³
Phantom section: Flat Section

Test Date: Date: 9/5/2023; Ambient Temp: 23 °C; Tissue Temp: 21 °C
Probe: EX3DV4 – SN7530; ConvF(9.62, 9.26, 10.37); Calibrated: 1/17/2023;
Sensor-Surface: 2mm (Mechanical Surface Detection)
Electronics: DAE4 Sn1416; Calibrated: 4/19/2023
Phantom: ELI v4.0; Type: QDOVA001BB; Serial: 1065
Measurement SW: DASY52, Version 52.10 (0); SEMCAD X Version 14.6.10 (7417)

Procedure Notes:

750 MHz Head/Verification/Area Scan (41x121x1): Interpolated grid: dx=1.500 mm, dy=1.500 mm
Maximum value of SAR (interpolated) = 0.889 W/kg

750 MHz Head/Verification /Zoom Scan (5x5x7)/Cube 0: Measurement grid: dx=8mm, dy=8mm, dz=5mm
Reference Value = 31.369 V/m; Power Drift = -0.01 dB
Peak SAR (extrapolated) = 1.562 mW/g
 $P_{in} = 100$ mW
SAR(1 g) = 0.856 mW/g; SAR(10 g) = 0.559 mW/g
Maximum value of SAR (measured) = 0.884 W/kg

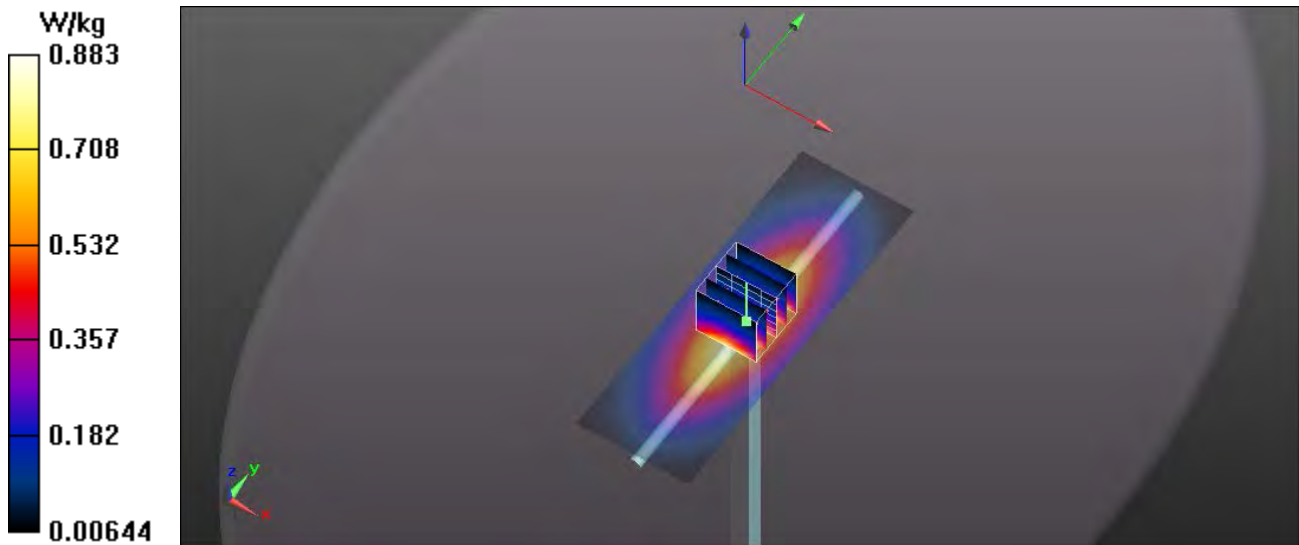

RF Exposure Lab

Plot 2

DUT: Dipole 900 MHz D900V2; Type: D900V2; Serial: D900V2 - SN:1d128

Communication System: CW; Frequency: 900 MHz; Duty Cycle: 1:1
Medium: HSL900; Medium parameters used: $f = 900 \text{ MHz}$; $\sigma = 1 \text{ S/m}$; $\epsilon_r = 40.86$; $\rho = 1000 \text{ kg/m}^3$
Phantom section: Flat Section

Test Date: Date: 9/6/2023; Ambient Temp: 23 °C; Tissue Temp: 21 °C
Probe: EX3DV4 - SN7530; ConvF(9.5, 9.25, 9.3); Calibrated: 1/17/2023;
Sensor-Surface: 2mm (Mechanical Surface Detection)
Electronics: DAE4 Sn1416; Calibrated: 4/19/2023
Phantom: ELI v4.0; Type: QDOVA001BB; Serial: 1065
Measurement SW: DASY52, Version 52.10 (0); SEMCAD X Version 14.6.10 (7417)

Procedure Notes:

900 MHz Head/Verification/Area Scan (5x11x1): Measurement grid: dx=15mm, dy=15mm
Maximum value of SAR (measured) = 1.22 W/kg

900 MHz Head/Verification/Zoom Scan (5x5x7)/Cube 0: Measurement grid: dx=8mm, dy=8mm, dz=5mm
Reference Value = 31.897 V/m; Power Drift = -0.04 dB
Peak SAR (extrapolated) = 1.46 W/kg
 $P_{in} = 100 \text{ mW}$
SAR(1 g) = 1.17 W/kg; SAR(10 g) = 0.715 W/kg
Maximum value of SAR (measured) = 1.19 W/kg

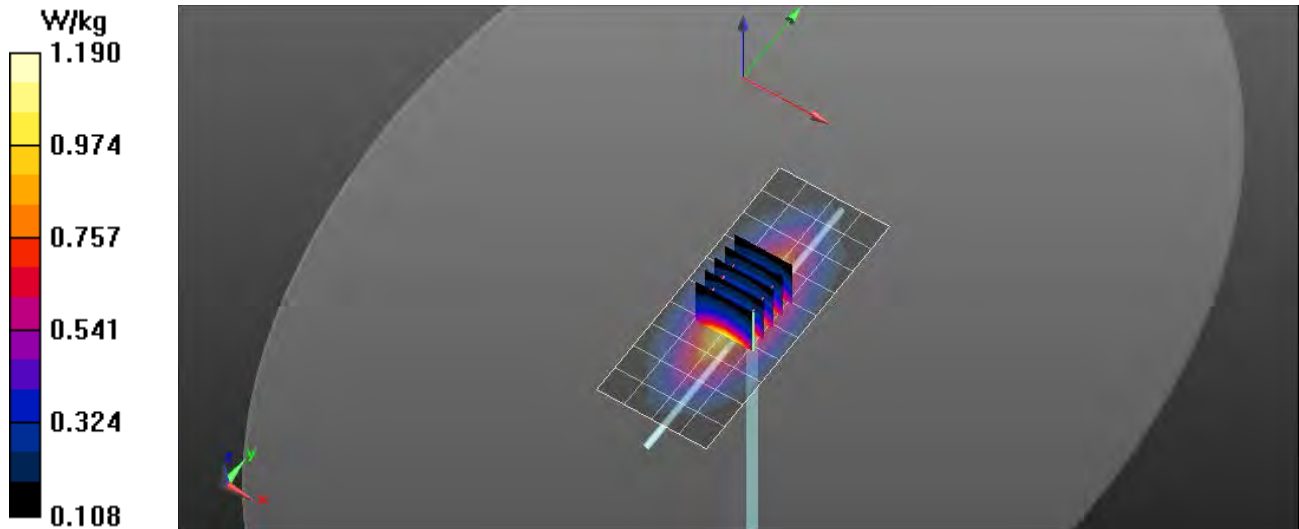

RF Exposure Lab

Plot 3

DUT: Dipole 1750 MHz D1750V2; Type: D1750V2; Serial: D1750V2 - SN:1061

Communication System: CW; Frequency: 1750 MHz; Duty Cycle: 1:1
 Medium: HSL1750; Medium parameters used: $f = 1750$ MHz; $\sigma = 1.39$ S/m; $\epsilon_r = 39.39$; $\rho = 1000$ kg/m³
 Phantom section: Flat Section

Test Date: Date: 9/8/2023; Ambient Temp: 23 °C; Tissue Temp: 21 °C
 Probe: EX3DV4 - SN7530; ConvF(8.28, 8.22, 8.47); Calibrated: 1/17/2023;
 Sensor-Surface: 2mm (Mechanical Surface Detection)
 Electronics: DAE4 Sn1416; Calibrated: 4/19/2023
 Phantom: ELI v4.0; Type: QDOVA001BB; Serial: 1065
 Measurement SW: DASY52, Version 52.10 (0); SEMCAD X Version 14.6.10 (7417)

Procedure Notes:

1750 MHz Head/Verification/Area Scan (5x7x1): Measurement grid: dx=15mm, dy=15mm
 Maximum value of SAR (measured) = 5.22 W/kg

1750 MHz Head/Verification/Zoom Scan (5x5x7)/Cube 0: Measurement grid: dx=8mm, dy=8mm, dz=5mm
 Reference Value = 33.387 V/m; Power Drift = -0.03 dB
 Peak SAR (extrapolated) = 6.84 W/kg
 $P_{in} = 100$ mW
SAR(1 g) = 3.77 W/kg; SAR(10 g) = 1.96 W/kg
 Maximum value of SAR (measured) = 5.49 W/kg

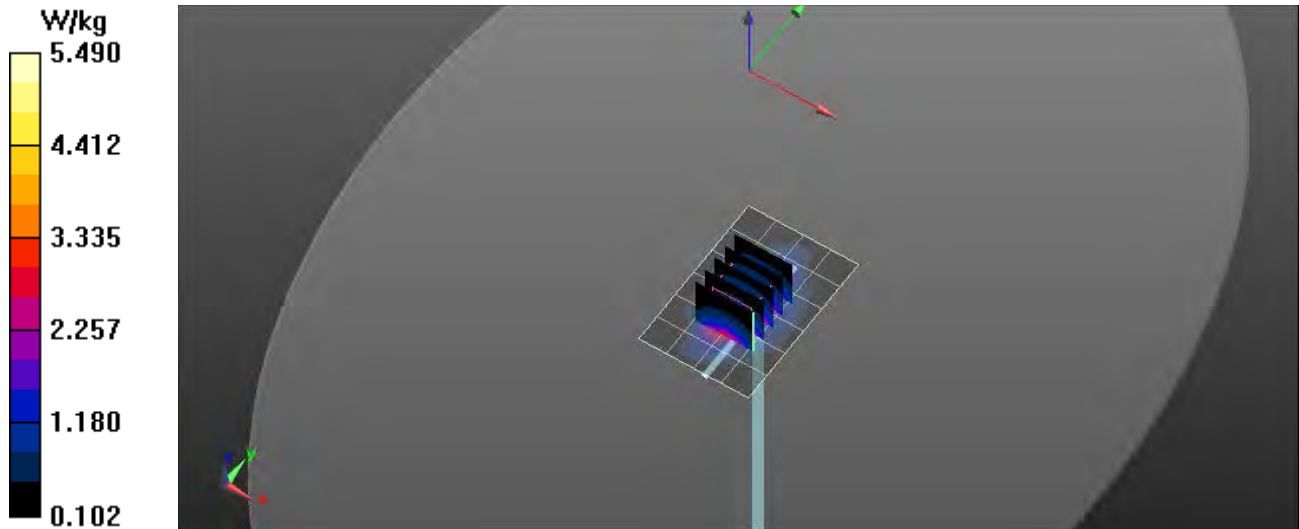

RF Exposure Lab

Plot 4

DUT: Dipole 1900 MHz D1900V2; Type: D1900V2; Serial: D1900V2 - SN: 5d147

Communication System: CW; Frequency: 1900 MHz; Duty Cycle: 1:1
Medium: HSL1900; Medium parameters used: $f = 1900$ MHz; $\sigma = 1.42$ S/m; $\epsilon_r = 39.65$; $\rho = 1000$ kg/m³
Phantom section: Flat Section

Test Date: Date: 9/8/2023; Ambient Temp: 23 °C; Tissue Temp: 21 °C
Probe: EX3DV4 - SN7530; ConvF(8.14, 8.08, 8.31); Calibrated: 1/17/2023;
Sensor-Surface: 2mm (Mechanical Surface Detection)
Electronics: DAE4 Sn1416; Calibrated: 4/19/2023
Phantom: ELI v4.0; Type: QDOVA001BB; Serial: 1065
Measurement SW: DASY52, Version 52.10 (0); SEMCAD X Version 14.6.10 (7417)

Procedure Notes:

1900 MHz Head/Verification/Area Scan (5x7x1): Measurement grid: dx=15mm, dy=15mm
Maximum value of SAR (measured) = 5.55 W/kg

1900 MHz Head/Verification/Zoom Scan (5x5x7)/Cube 0: Measurement grid: dx=8mm, dy=8mm, dz=5mm
Reference Value = 32.965 V/m; Power Drift = -0.01 dB
Peak SAR (extrapolated) = 7.22 W/kg
 $P_{in} = 100$ mW
SAR(1 g) = 4.17 W/kg; SAR(10 g) = 2.17 W/kg
Maximum value of SAR (measured) = 5.77 W/kg

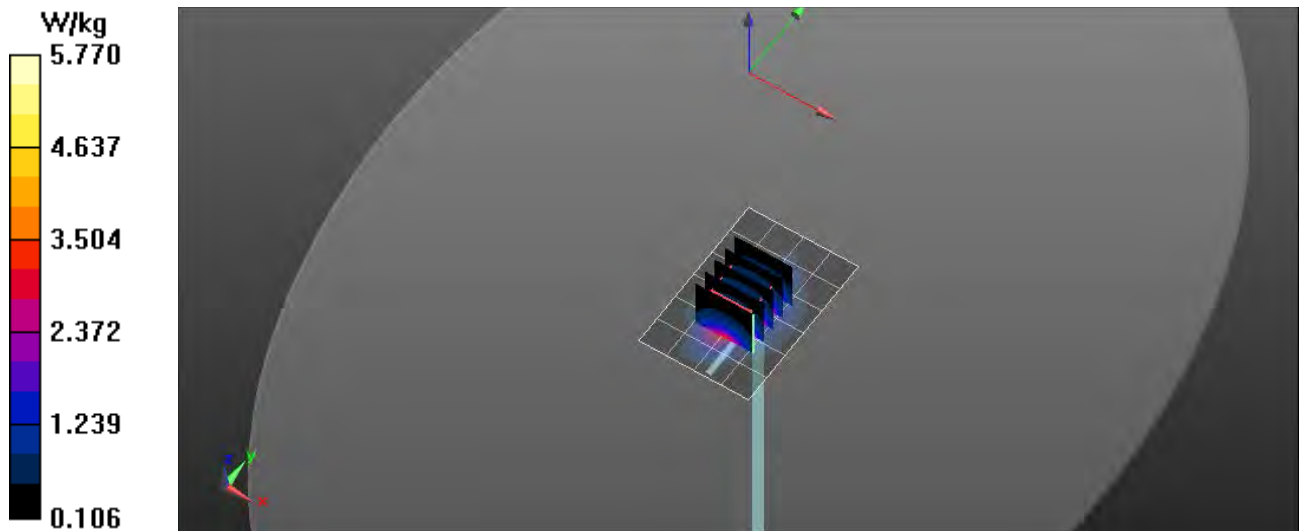

RF Exposure Lab

Plot 5

DUT: Dipole 2550 MHz D2550V2; Type: D2550V2; Serial: D2550V2 - SN:1003

Communication System: CW; Frequency: 2550 MHz; Duty Cycle: 1:1
Medium: HSL2550; Medium parameters used (interpolated): $f = 2550$ MHz; $\sigma = 1.925$ S/m; $\epsilon_r = 38.69$; $\rho = 1000$ kg/m³
Phantom section: Flat Section

Test Date: Date: 9/10/2023; Ambient Temp: 23 °C; Tissue Temp: 21 °C
Probe: EX3DV4 - SN7530; ConvF(7.54, 7.33, 7.61); Calibrated: 4/12/2022;
Sensor-Surface: 2mm (Mechanical Surface Detection)
Electronics: DAE4 Sn1416; Calibrated: 4/19/2023
Phantom: ELI v4.0; Type: QDOVA001BB; Serial: 1065
Measurement SW: DASY52, Version 52.10 (0); SEMCAD X Version 14.6.10 (7417)

Procedure Notes:

2550 MHz Head/Verification/Area Scan (61x81x1): Interpolated grid: dx=1.000 mm, dy=1.000 mm

[Info: Interpolated medium parameters used for SAR evaluation.](#)
Maximum value of SAR (interpolated) = 9.21 W/kg

2550 MHz Head/Verification/Zoom Scan (7x7x7)/Cube 0: Measurement grid: dx=5mm, dy=5mm, dz=5mm
Reference Value = 54.694 V/m; Power Drift = -0.03 dB
Peak SAR (extrapolated) = 11.6 W/kg
 $P_{in} = 100$ mW
SAR(1 g) = 5.66 W/kg; SAR(10 g) = 2.49 W/kg

[Info: Interpolated medium parameters used for SAR evaluation.](#)
Maximum value of SAR (measured) = 9.15 W/kg

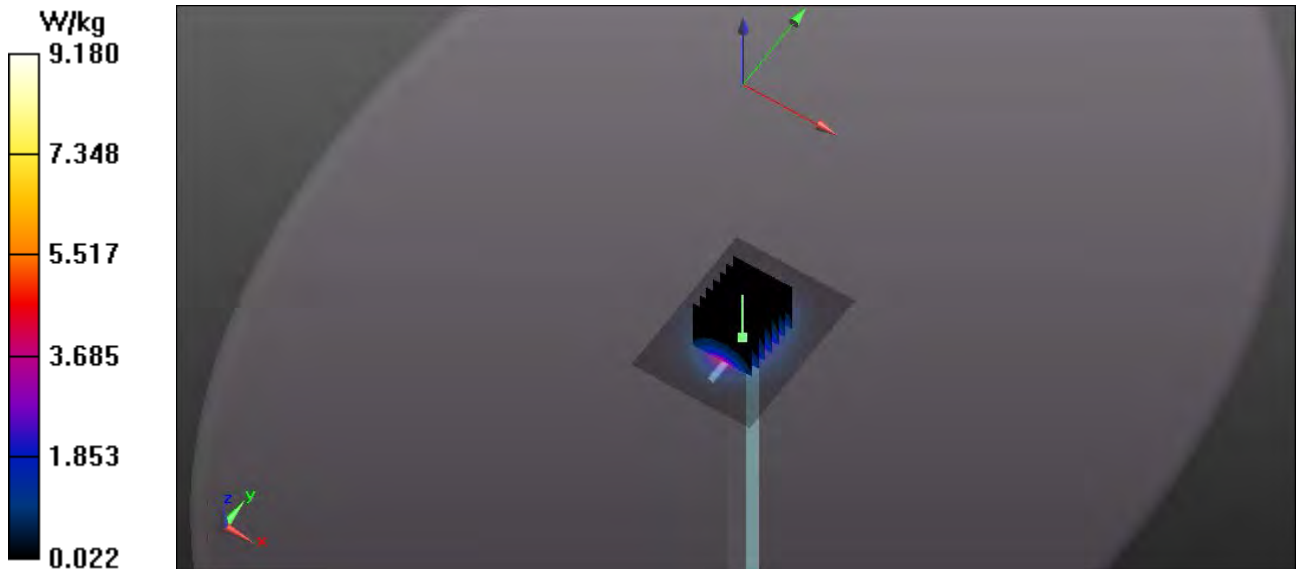

Appendix B – SAR Test Data Plots

RF Exposure Lab

Plot 1

DUT: MS4W; Type: Rugged Tablet; Serial: 356865

Communication System: UMTS (WCDMA); Frequency: 1852.4 MHz; Duty Cycle: 1:1
Medium: HSL1900; Medium parameters used (interpolated): $f = 1852.4$ MHz; $\sigma = 1.402$ S/m; $\epsilon_r = 39.745$; $\rho = 1000$ kg/m³
Phantom section: Flat Section

Test Date: Date: 9/8/2023; Ambient Temp: 23 °C; Tissue Temp: 21 °C

Probe: EX3DV4 - SN7530; ConvF(8.14, 8.08, 8.31); Calibrated: 1/17/2023
Sensor-Surface: 2mm (Mechanical Surface Detection)
Electronics: DAE4 Sn1321; Calibrated: 1/17/2023
Phantom: ELI v4.0; Type: QDOVA001BB; Serial: 1065
Measurement SW: DASY52, Version 52.10 (0); SEMCAD X Version 14.6.10 (7417)

Procedure Notes:

B2 WCDMA/Right Low/Area Scan (7x9x1): Measurement grid: dx=15mm, dy=15mm

[Info: Interpolated medium parameters used for SAR evaluation.](#)
Maximum value of SAR (measured) = 1.01 W/kg

B2 WCDMA/Right Low/Zoom Scan (5x5x7)/Cube 0: Measurement grid: dx=8mm, dy=8mm, dz=5mm
Reference Value = 19.99 V/m; Power Drift = -0.06 dB
Peak SAR (extrapolated) = 2.06 W/kg
SAR(1 g) = 1.05 W/kg; SAR(10 g) = 0.497 W/kg

[Info: Interpolated medium parameters used for SAR evaluation.](#)
Maximum value of SAR (measured) = 1.54 W/kg

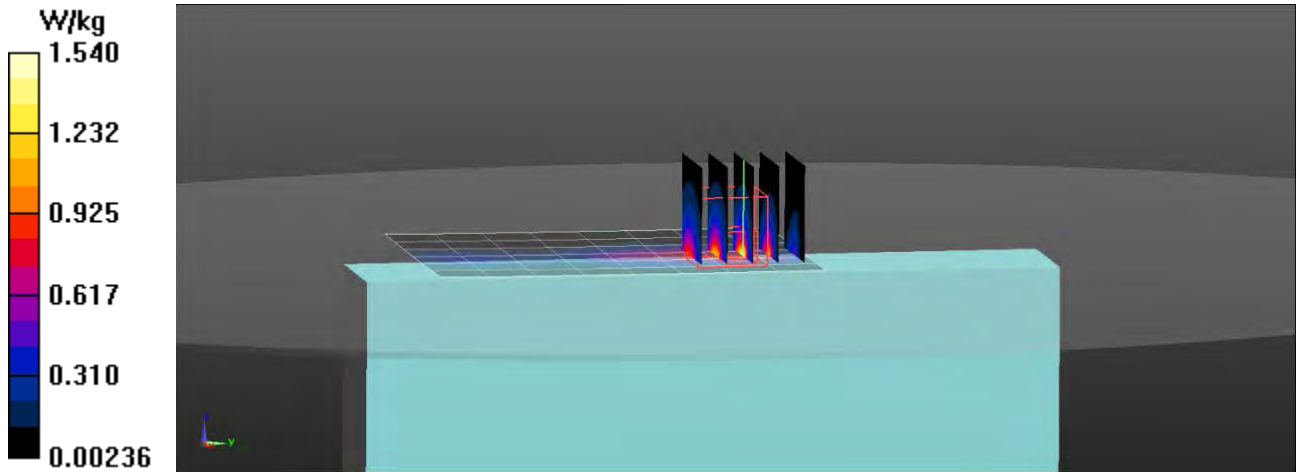

RF Exposure Lab

Plot 2

DUT: MS4W; Type: Rugged Tablet; Serial: 356865

Communication System: UMTS (WCDMA); Frequency: 1752.6 MHz; Duty Cycle: 1:1
Medium: HSL1750; Medium parameters used (interpolated): $f = 1752.6$ MHz; $\sigma = 1.393$ S/m; $\epsilon_r = 39.385$; $\rho = 1000$ kg/m³
Phantom section: Flat Section

Test Date: Date: 9/8/2023; Ambient Temp: 23 °C; Tissue Temp: 21 °C

Probe: EX3DV4 - SN7530; ConvF(8.28, 8.22, 8.47); Calibrated: 1/17/2023
Sensor-Surface: 2mm (Mechanical Surface Detection)
Electronics: DAE4 Sn1321; Calibrated: 1/17/2023
Phantom: ELI v4.0; Type: QDOVA001BB; Serial: 1065
Measurement SW: DASY52, Version 52.10 (0); SEMCAD X Version 14.6.10 (7417)

Procedure Notes:

B4 WCDMA/Right High/Area Scan (7x9x1): Measurement grid: dx=15mm, dy=15mm

Info: [Interpolated medium parameters used for SAR evaluation.](#)
Maximum value of SAR (measured) = 1.07 W/kg

B4 WCDMA/Right High/Zoom Scan (5x5x7)/Cube 0: Measurement grid: dx=8mm, dy=8mm, dz=5mm
Reference Value = 23.62 V/m; Power Drift = -0.06 dB
Peak SAR (extrapolated) = 2.32 W/kg
SAR(1 g) = 1.21 W/kg; SAR(10 g) = 0.587 W/kg

Info: [Interpolated medium parameters used for SAR evaluation.](#)
Maximum value of SAR (measured) = 1.85 W/kg

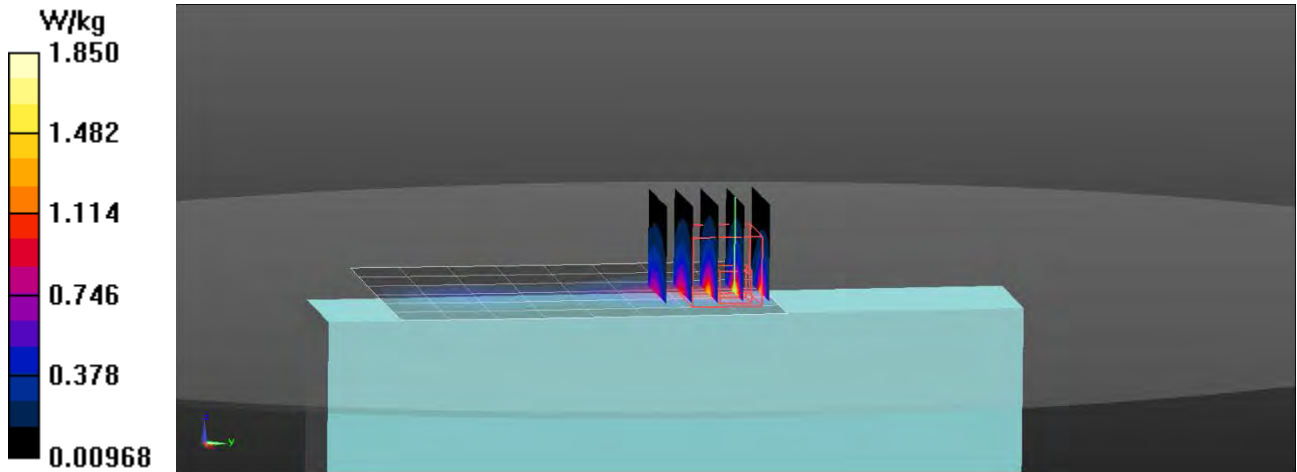

RF Exposure Lab

Plot 3

DUT: MS4W; Type: Rugged Tablet; Serial: 356865

Communication System: UMTS (WCDMA); Frequency: 836.6 MHz; Duty Cycle: 1:1
Medium: HSL900; Medium parameters used (interpolated): $f = 836.6$ MHz; $\sigma = 0.937$ S/m; $\epsilon_r = 40.96$; $\rho = 1000$ kg/m³
Phantom section: Flat Section

Test Date: Date: 9/6/2023; Ambient Temp: 23 °C; Tissue Temp: 21 °C

Probe: EX3DV4 - SN7530; ConvF(9.5, 9.25, 9.3); Calibrated: 1/17/2023
Sensor-Surface: 2mm (Mechanical Surface Detection)
Electronics: DAE4 Sn1321; Calibrated: 1/17/2023
Phantom: ELI v4.0; Type: QDOVA001BB; Serial: 1065
Measurement SW: DASY52, Version 52.10 (0); SEMCAD X Version 14.6.10 (7417)

Procedure Notes:

B5 WCDMA/Right Mid/Area Scan (7x10x1): Measurement grid: dx=15mm, dy=15mm

[Info: Interpolated medium parameters used for SAR evaluation.](#)
Maximum value of SAR (measured) = 0.778 W/kg

B5 WCDMA/Right Mid/Zoom Scan (5x6x7)/Cube 0: Measurement grid: dx=8mm, dy=8mm, dz=5mm
Reference Value = 17.43 V/m; Power Drift = -0.01 dB
Peak SAR (extrapolated) = 1.10 W/kg
SAR(1 g) = 0.629 W/kg; SAR(10 g) = 0.364 W/kg

[Info: Interpolated medium parameters used for SAR evaluation.](#)
Maximum value of SAR (measured) = 0.848 W/kg

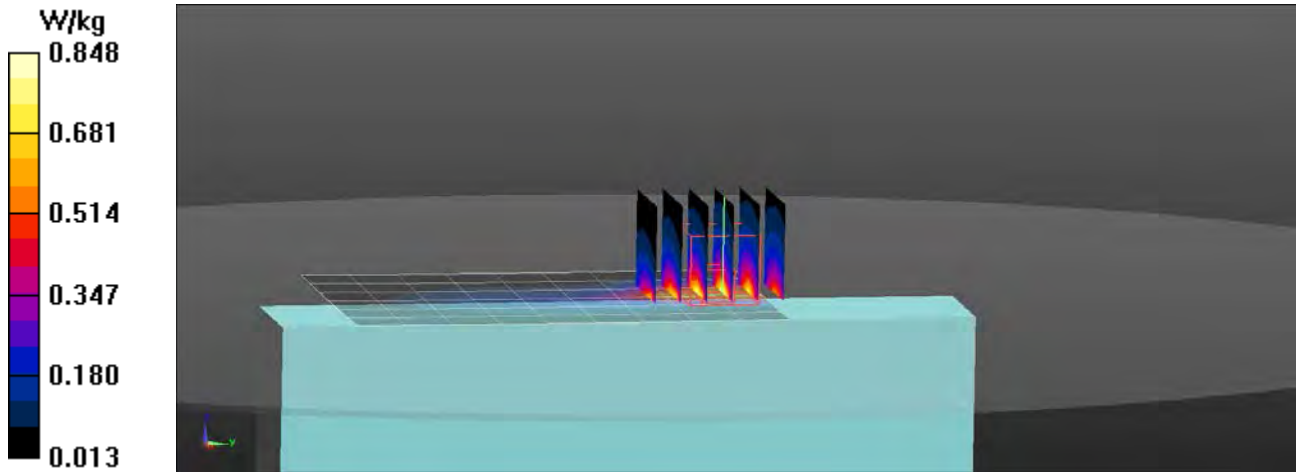

RF Exposure Lab

Plot 4

DUT: MS4W; Type: Rugged Tablet; Serial: 356865

Communication System: LTE (SC-FDMA, 1 RB, 20 MHz, QPSK); Frequency: 2535 MHz; Duty Cycle: 1:1
Medium: HSL2550; Medium parameters used (interpolated): $f = 2535$ MHz; $\sigma = 1.905$ S/m; $\epsilon_r = 38.725$; $\rho = 1000$ kg/m³
Phantom section: Flat Section

Test Date: Date: 9/10/2023; Ambient Temp: 23 °C; Tissue Temp: 21 °C

Probe: EX3DV4 - SN7530; ConvF(7.54, 7.33, 7.61); Calibrated: 1/17/2023
Sensor-Surface: 2mm (Mechanical Surface Detection)
Electronics: DAE4 Sn1321; Calibrated: 1/17/2023
Phantom: ELI v4.0; Type: QDOVA001BB; Serial: 1065
Measurement SW: DASY52, Version 52.10 (0); SEMCAD X Version 14.6.10 (7417)

Procedure Notes:

B7 LTE/Right 1 RB 49 Offset Mid/Area Scan (10x13x1): Measurement grid: dx=10mm, dy=10mm

Info: [Interpolated medium parameters used for SAR evaluation.](#)
Maximum value of SAR (measured) = 1.90 W/kg

B7 LTE/Right 1 RB 49 Offset Mid/Zoom Scan (7x8x7)/Cube 0: Measurement grid: dx=5mm, dy=5mm, dz=5mm
Reference Value = 22.89 V/m; Power Drift = -0.03 dB
Peak SAR (extrapolated) = 2.65 W/kg
SAR(1 g) = 1.14 W/kg; SAR(10 g) = 0.637 W/kg

Info: [Interpolated medium parameters used for SAR evaluation.](#)
Maximum value of SAR (measured) = 1.97 W/kg

B7 LTE/Right 1 RB 49 Offset Mid/Zoom Scan (7x8x7)/Cube 1: Measurement grid: dx=5mm, dy=5mm, dz=5mm
Reference Value = 22.89 V/m; Power Drift = -0.13 dB
Peak SAR (extrapolated) = 2.52 W/kg
SAR(1 g) = 1.02 W/kg; SAR(10 g) = 0.608 W/kg

Info: [Interpolated medium parameters used for SAR evaluation.](#)
Maximum value of SAR (measured) = 1.83 W/kg

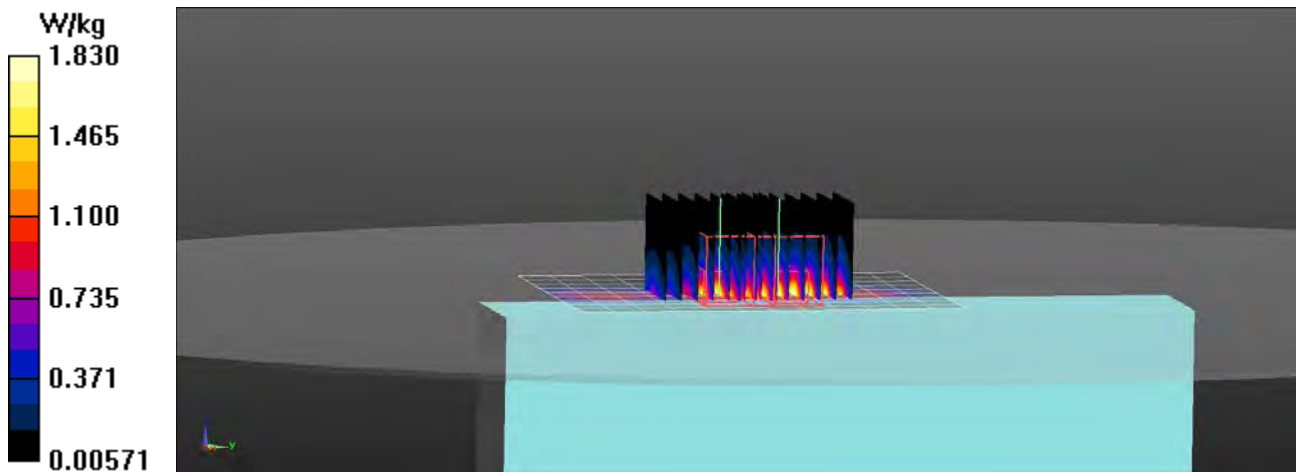

RF Exposure Lab

Plot 5

DUT: MS4W; Type: Rugged Tablet; Serial: 356865

Communication System: LTE (SC-FDMA, 1 RB, 10 MHz, QPSK); Frequency: 707.5 MHz; Duty Cycle: 1:1
Medium: HSL750; Medium parameters used (interpolated): $f = 707.5$ MHz; $\sigma = 0.888$ S/m; $\epsilon_r = 41.138$; $\rho = 1000$ kg/m³
Phantom section: Flat Section

Test Date: Date: 9/5/2023; Ambient Temp: 23 °C; Tissue Temp: 21 °C

Probe: EX3DV4 - SN7530; ConvF(9.62, 9.26, 10.37); Calibrated: 1/17/2023
Sensor-Surface: 2mm (Mechanical Surface Detection)
Electronics: DAE4 Sn1321; Calibrated: 1/17/2023
Phantom: ELI v4.0; Type: QDOVA001BB; Serial: 1065
Measurement SW: DASY52, Version 52.10 (0); SEMCAD X Version 14.6.10 (7417)

Procedure Notes:

B12 LTE/Right Mid 1 RB 24 Offset/Area Scan (7x9x1): Measurement grid: dx=15mm, dy=15mm

[Info: Interpolated medium parameters used for SAR evaluation.](#)

Maximum value of SAR (measured) = 0.779 W/kg

B12 LTE/Right Mid 1 RB 24 Offset/Zoom Scan (6x6x7)/Cube 0: Measurement grid: dx=8mm, dy=8mm, dz=5mm

Reference Value = 21.91 V/m; Power Drift = 0.05 dB

Peak SAR (extrapolated) = 1.25 W/kg

SAR(1 g) = 0.565 W/kg; SAR(10 g) = 0.331 W/kg

[Info: Interpolated medium parameters used for SAR evaluation.](#)

Maximum value of SAR (measured) = 0.829 W/kg

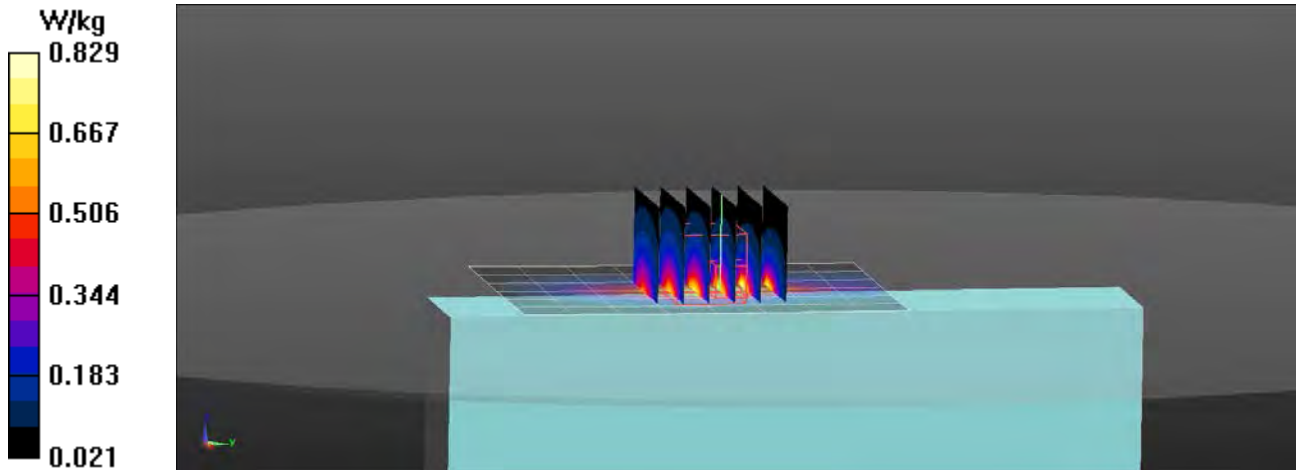

RF Exposure Lab

Plot 6

DUT: MS4W; Type: Rugged Tablet; Serial: 356865

Communication System: LTE (SC-FDMA, 1 RB, 10 MHz, QPSK); Frequency: 782 MHz; Duty Cycle: 1:1
Medium: HSL750; Medium parameters used (interpolated): $f = 782 \text{ MHz}$; $\sigma = 0.942 \text{ S/m}$; $\epsilon_r = 40.698$; $\rho = 1000 \text{ kg/m}^3$
Phantom section: Flat Section

Test Date: Date: 9/5/2023; Ambient Temp: 23 °C; Tissue Temp: 21 °C

Probe: EX3DV4 - SN7530; ConvF(9.62, 9.26, 10.37); Calibrated: 1/17/2023
Sensor-Surface: 2mm (Mechanical Surface Detection)
Electronics: DAE4 Sn1321; Calibrated: 1/17/2023
Phantom: ELI v4.0; Type: QDOVA001BB; Serial: 1065
Measurement SW: DASY52, Version 52.10 (0); SEMCAD X Version 14.6.10 (7417)

Procedure Notes:

B13 LTE/Right Mid 1RB 24 Offset/Area Scan (7x9x1): Measurement grid: $dx=15\text{mm}$, $dy=15\text{mm}$

[Info: Interpolated medium parameters used for SAR evaluation.](#)
Maximum value of SAR (measured) = 0.669 W/kg

B13 LTE/Right Mid 1RB 24 Offset/Zoom Scan (6x6x7)/Cube 0: Measurement grid: $dx=8\text{mm}$, $dy=8\text{mm}$, $dz=5\text{mm}$
Reference Value = 18.84 V/m; Power Drift = 0.07 dB
Peak SAR (extrapolated) = 1.01 W/kg
SAR(1 g) = 0.561 W/kg; SAR(10 g) = 0.330 W/kg

[Info: Interpolated medium parameters used for SAR evaluation.](#)
Maximum value of SAR (measured) = 0.759 W/kg

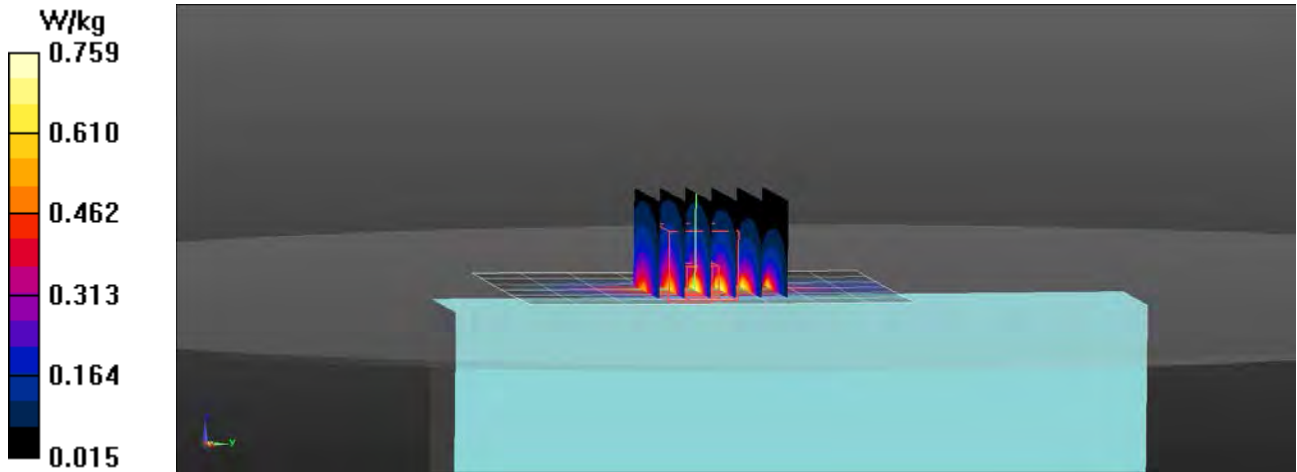

RF Exposure Lab

Plot 7

DUT: MS4W; Type: Rugged Tablet; Serial: 356865

Communication System: LTE (SC-FDMA, 1 RB, 10 MHz, QPSK); Frequency: 793 MHz; Duty Cycle: 1:1
Medium: HSL750; Medium parameters used (interpolated): $f = 793 \text{ MHz}$; $\sigma = 0.95 \text{ S/m}$; $\epsilon_r = 40.638$; $\rho = 1000 \text{ kg/m}^3$
Phantom section: Flat Section

Test Date: Date: 9/5/2023; Ambient Temp: 23 °C; Tissue Temp: 21 °C

Probe: EX3DV4 - SN7530; ConvF(9.62, 9.26, 10.37); Calibrated: 1/17/2023
Sensor-Surface: 2mm (Mechanical Surface Detection)
Electronics: DAE4 Sn1321; Calibrated: 1/17/2023
Phantom: ELI v4.0; Type: QDOVA001BB; Serial: 1065
Measurement SW: DASY52, Version 52.10 (0); SEMCAD X Version 14.6.10 (7417)

Procedure Notes:

B14 LTE/Right Mid 1RB 24 Offset/Area Scan (7x9x1): Measurement grid: dx=15mm, dy=15mm

[Info: Interpolated medium parameters used for SAR evaluation.](#)
Maximum value of SAR (measured) = 1.14 W/kg

B14 LTE/Right Mid 1RB 24 Offset/Zoom Scan (5x6x7)/Cube 0: Measurement grid: dx=8mm, dy=8mm, dz=5mm
Reference Value = 23.75 V/m; Power Drift = -0.01 dB
Peak SAR (extrapolated) = 1.68 W/kg
SAR(1 g) = 0.971 W/kg; SAR(10 g) = 0.570 W/kg

[Info: Interpolated medium parameters used for SAR evaluation.](#)
Maximum value of SAR (measured) = 1.31 W/kg

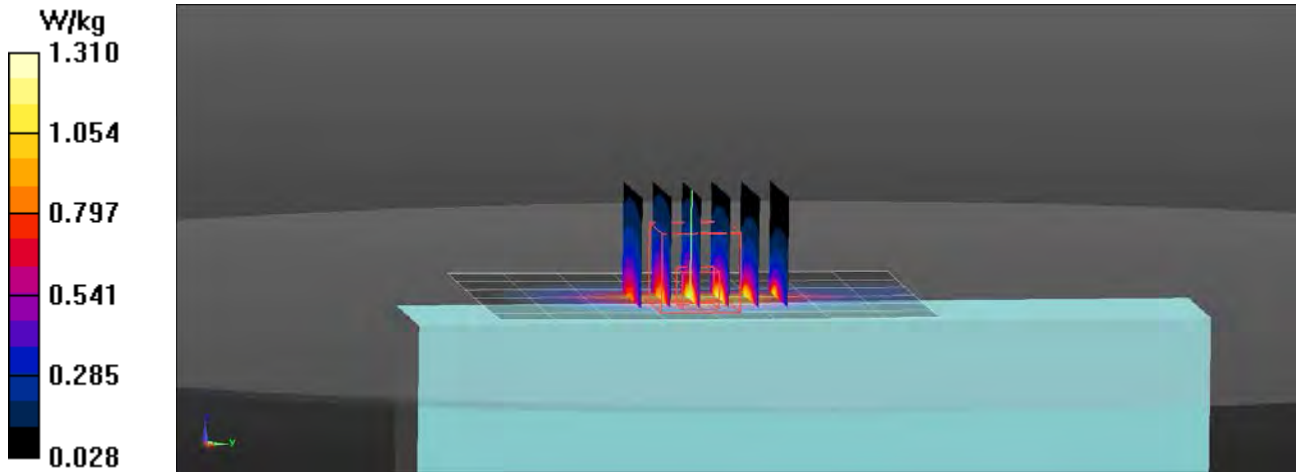

RF Exposure Lab

Plot 8

DUT: MS4W; Type: Rugged Tablet; Serial: 356865

Communication System: LTE (SC-FDMA, 1 RB, 20 MHz, QPSK); Frequency: 1860 MHz; Duty Cycle: 1:1
Medium: HSL1900; Medium parameters used: $f = 1860$ MHz; $\sigma = 1.41$ S/m; $\epsilon_r = 39.73$; $\rho = 1000$ kg/m³
Phantom section: Flat Section

Test Date: Date: 9/8/2023; Ambient Temp: 23 °C; Tissue Temp: 21 °C

Probe: EX3DV4 - SN7530; ConvF(8.14, 8.08, 8.31); Calibrated: 1/17/2023
Sensor-Surface: 2mm (Mechanical Surface Detection)
Electronics: DAE4 Sn1321; Calibrated: 1/17/2023
Phantom: ELI v4.0; Type: QDOVA001BB; Serial: 1065
Measurement SW: DASY52, Version 52.10 (0); SEMCAD X Version 14.6.10 (7417)

Procedure Notes:

B25 LTE/Right Low 1 RB 49 Offset/Area Scan (7x9x1): Measurement grid: dx=15mm, dy=15mm
Maximum value of SAR (measured) = 1.15 W/kg

B25 LTE/Right Low 1 RB 49 Offset/Zoom Scan (6x6x7)/Cube 0: Measurement grid: dx=8mm, dy=8mm, dz=5mm
Reference Value = 21.28 V/m; Power Drift = -0.04 dB
Peak SAR (extrapolated) = 2.27 W/kg
SAR(1 g) = 1.15 W/kg; SAR(10 g) = 0.538 W/kg
Maximum value of SAR (measured) = 1.69 W/kg

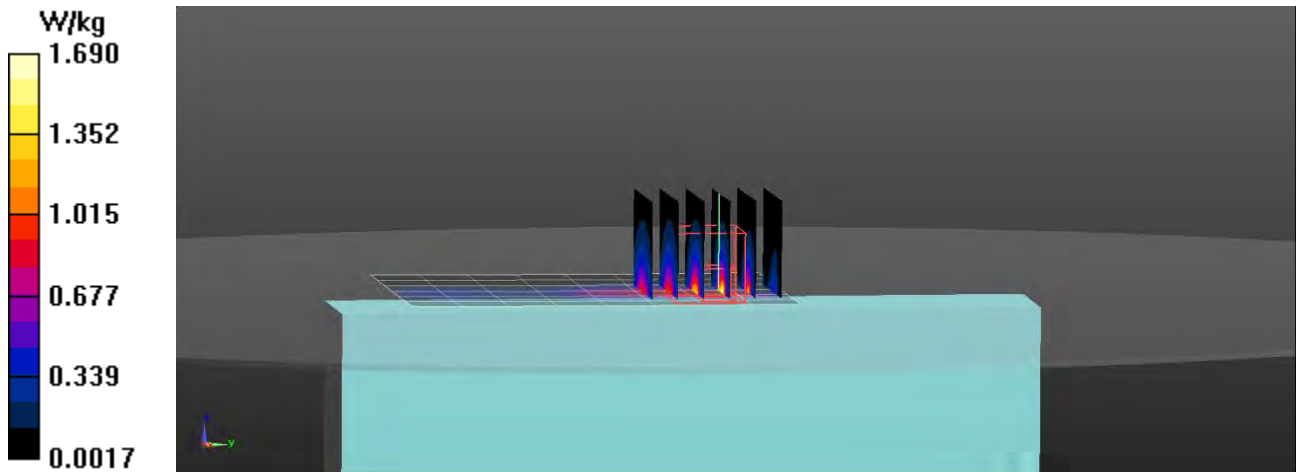

RF Exposure Lab

Plot 9

DUT: MS4W; Type: Rugged Tablet; Serial: 356865

Communication System: LTE (SC-FDMA, 1 RB, 15 MHz, QPSK); Frequency: 831.5 MHz; Duty Cycle: 1:1
Medium: HSL900; Medium parameters used (interpolated): $f = 831.5$ MHz; $\sigma = 0.932$ S/m; $\epsilon_r = 40.976$; $\rho = 1000$ kg/m³
Phantom section: Flat Section

Test Date: Date: 9/6/2023; Ambient Temp: 23 °C; Tissue Temp: 21 °C

Probe: EX3DV4 - SN7530; ConvF(9.5, 9.25, 9.3); Calibrated: 1/17/2023
Sensor-Surface: 2mm (Mechanical Surface Detection)
Electronics: DAE4 Sn1321; Calibrated: 1/17/2023
Phantom: ELI v4.0; Type: QDOVA001BB; Serial: 1065
Measurement SW: DASY52, Version 52.10 (0); SEMCAD X Version 14.6.10 (7417)

Procedure Notes:

B26 LTE/Right Mid 1 RB 37 Offset/Area Scan (7x10x1): Measurement grid: dx=15mm, dy=15mm

Info: [Interpolated medium parameters used for SAR evaluation.](#)
Maximum value of SAR (measured) = 0.340 W/kg

B26 LTE/Right Mid 1 RB 37 Offset/Zoom Scan (5x6x7)/Cube 0: Measurement grid: dx=8mm, dy=8mm, dz=5mm
Reference Value = 11.85 V/m; Power Drift = -0.03 dB
Peak SAR (extrapolated) = 0.490 W/kg
SAR(1 g) = 0.276 W/kg; SAR(10 g) = 0.159 W/kg

Info: [Interpolated medium parameters used for SAR evaluation.](#)
Maximum value of SAR (measured) = 0.374 W/kg

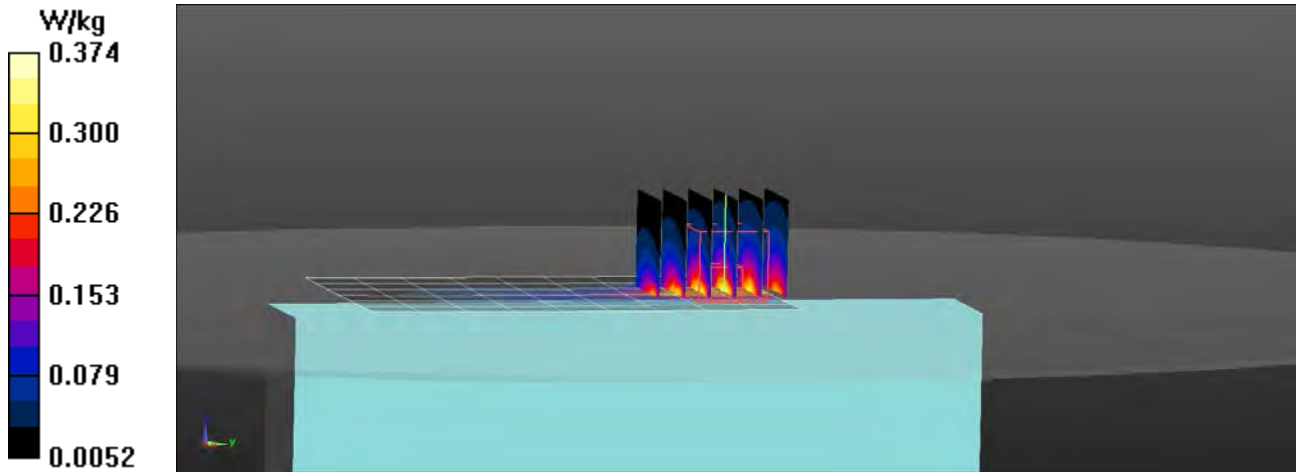

RF Exposure Lab

Plot 10

DUT: MS4W; Type: Rugged Tablet; Serial: 356865

Communication System: LTE (SC-FDMA, 1 RB, 20 MHz, QPSK); Frequency: 2593 MHz; Duty Cycle: 1:1
 Medium: HSL2550; Medium parameters used (interpolated): $f = 2593$ MHz; $\sigma = 1.98$ S/m; $\epsilon_r = 38.593$; $\rho = 1000$ kg/m³
 Phantom section: Flat Section

Test Date: Date: 9/10/2023; Ambient Temp: 23 °C; Tissue Temp: 21 °C

Probe: EX3DV4 - SN7530; ConvF(7.54, 7.33, 7.61); Calibrated: 1/17/2023
 Sensor-Surface: 2mm (Mechanical Surface Detection)
 Electronics: DAE4 Sn1321; Calibrated: 1/17/2023
 Phantom: ELI v4.0; Type: QDOVA001BB; Serial: 1065
 Measurement SW: DASY52, Version 52.10 (0); SEMCAD X Version 14.6.10 (7417)

Procedure Notes:

B41 LTE/Right 1 RB 49 Offset Mid/Area Scan (10x13x1): Measurement grid: dx=10mm, dy=10mm

Info: [Interpolated medium parameters used for SAR evaluation.](#)
 Maximum value of SAR (measured) = 1.02 W/kg

B41 LTE/Right 1 RB 49 Offset Mid/Zoom Scan (7x7x7)/Cube 0: Measurement grid: dx=5mm, dy=5mm, dz=5mm
 Reference Value = 18.43 V/m; Power Drift = -1.04 dB

Peak SAR (extrapolated) = 1.58 W/kg
SAR(1 g) = 0.695 W/kg; SAR(10 g) = 0.289 W/kg

Info: [Interpolated medium parameters used for SAR evaluation.](#)
 Maximum value of SAR (measured) = 1.15 W/kg

B41 LTE/Right 1 RB 49 Offset Mid/Zoom Scan (7x7x7)/Cube 1: Measurement grid: dx=5mm, dy=5mm, dz=5mm
 Reference Value = 18.43 V/m; Power Drift = -0.04 dB

Peak SAR (extrapolated) = 1.10 W/kg
SAR(1 g) = 0.602 W/kg; SAR(10 g) = 0.302 W/kg

Info: [Interpolated medium parameters used for SAR evaluation.](#)
 Maximum value of SAR (measured) = 0.854 W/kg

B41 LTE/Right 1 RB 49 Offset Mid/Zoom Scan (7x7x7)/Cube 2: Measurement grid: dx=5mm, dy=5mm, dz=5mm
 Reference Value = 18.43 V/m; Power Drift = -0.04 dB

Peak SAR (extrapolated) = 0.875 W/kg
SAR(1 g) = 0.420 W/kg; SAR(10 g) = 0.200 W/kg

Info: [Interpolated medium parameters used for SAR evaluation.](#)
 Maximum value of SAR (measured) = 0.647 W/kg

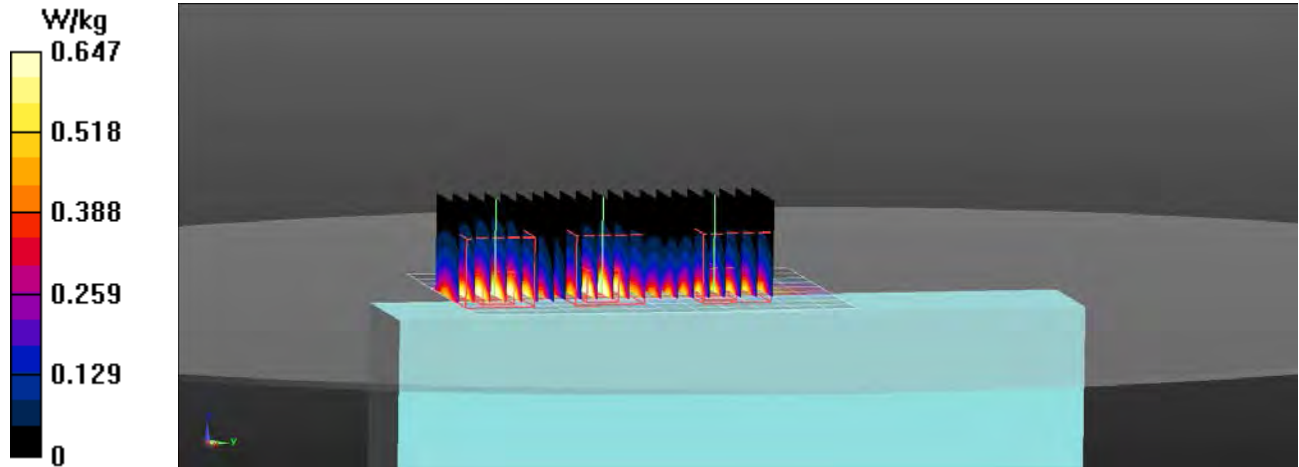

RF Exposure Lab

Plot 11

DUT: MS4W; Type: Rugged Tablet; Serial: 356865

Communication System: LTE (SC-FDMA, 1 RB, 20 MHz, QPSK); Frequency: 1745 MHz; Duty Cycle: 1:1
Medium: BH600-6000; Medium parameters used (interpolated): $f = 1745$ MHz; $\sigma = 1.385$ S/m; $\epsilon_r = 39.4$; $\rho = 1000$ kg/m³
Phantom section: Flat Section

Test Date: Date: 9/8/2023; Ambient Temp: 23 °C; Tissue Temp: 21 °C

Probe: EX3DV4 - SN7530; ConvF(8.28, 8.22, 8.47); Calibrated: 1/17/2023
Sensor-Surface: 2mm (Mechanical Surface Detection)
Electronics: DAE4 Sn1321; Calibrated: 1/17/2023
Phantom: ELI v4.0; Type: QDOVA001BB; Serial: 1065
Measurement SW: DASY52, Version 52.10 (0); SEMCAD X Version 14.6.10 (7417)

Procedure Notes:

B66 LTE/Right 1 RB 49 Offset Mid/Area Scan (7x9x1): Measurement grid: dx=15mm, dy=15mm

[Info: Interpolated medium parameters used for SAR evaluation.](#)
Maximum value of SAR (measured) = 0.599 W/kg

B66 LTE/Right 1 RB 49 Offset Mid/Zoom Scan (5x5x7)/Cube 0: Measurement grid: dx=8mm, dy=8mm, dz=5mm
Reference Value = 17.21 V/m; Power Drift = 0.01 dB
Peak SAR (extrapolated) = 1.19 W/kg
SAR(1 g) = 0.616 W/kg; SAR(10 g) = 0.298 W/kg

[Info: Interpolated medium parameters used for SAR evaluation.](#)
Maximum value of SAR (measured) = 0.888 W/kg

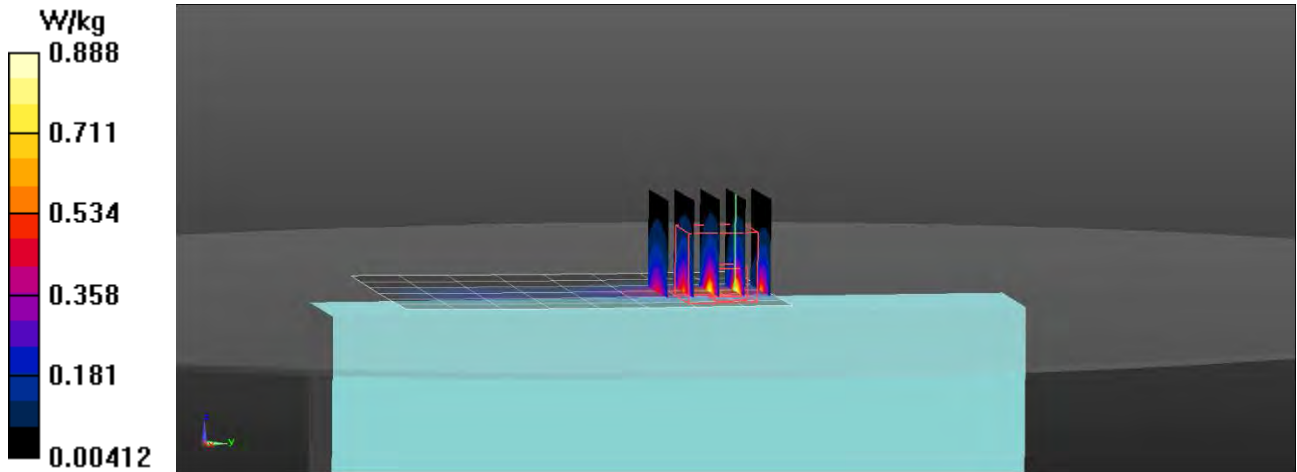

RF Exposure Lab

Plot 12

DUT: MS4W; Type: Rugged Tablet; Serial: 356865

Communication System: LTE (SC-FDMA, 1 RB, 20 MHz, QPSK); Frequency: 680.5 MHz; Duty Cycle: 1:1
Medium: HSL750; Medium parameters used (interpolated): $f = 680.5$ MHz; $\sigma = 0.871$ S/m; $\epsilon_r = 41.307$; $\rho = 1000$ kg/m³
Phantom section: Flat Section

Test Date: Date: 9/6/2023; Ambient Temp: 23 °C; Tissue Temp: 21 °C

Probe: EX3DV4 - SN7530; ConvF(9.62, 9.26, 10.37); Calibrated: 1/17/2023
Sensor-Surface: 2mm (Mechanical Surface Detection)
Electronics: DAE4 Sn1321; Calibrated: 1/17/2023
Phantom: ELI v4.0; Type: QDOVA001BB; Serial: 1065
Measurement SW: DASY52, Version 52.10 (0); SEMCAD X Version 14.6.10 (7417)

Procedure Notes:

B71 LTE/Right 1 RB 24 Offset Mid/Area Scan (7x9x1): Measurement grid: dx=15mm, dy=15mm

Info: [Interpolated medium parameters used for SAR evaluation.](#)
Maximum value of SAR (measured) = 0.615 W/kg

B71 LTE/Right 1 RB 24 Offset Mid/Zoom Scan (5x5x7)/Cube 0: Measurement grid: dx=8mm, dy=8mm, dz=5mm
Reference Value = 19.46 V/m; Power Drift = 0.05 dB
Peak SAR (extrapolated) = 1.06 W/kg
SAR(1 g) = 0.452 W/kg; SAR(10 g) = 0.247 W/kg

Info: [Interpolated medium parameters used for SAR evaluation.](#)
Maximum value of SAR (measured) = 0.691 W/kg

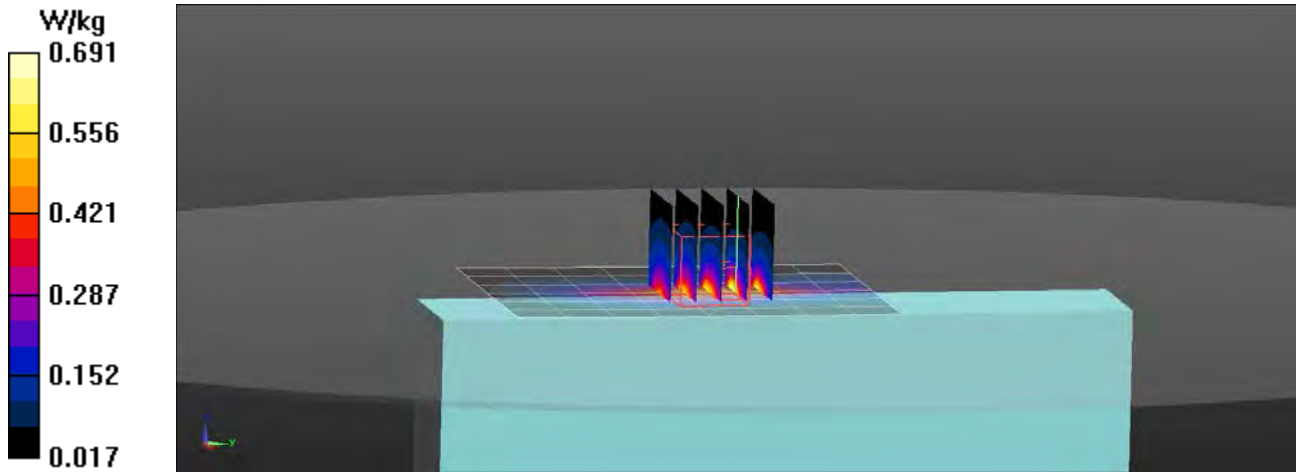

RF Exposure Lab

Plot 13

DUT: MS4W; Type: Rugged Tablet; Serial: 356865

Communication System: FM; Frequency: 915 MHz; Duty Cycle: 1:1.99986
Medium: HSL900; Medium parameters used (interpolated): $f = 915$ MHz; $\sigma = 1.01$ S/m; $\epsilon_r = 40.845$; $\rho = 1000$ kg/m³
Phantom section: Flat Section

Test Date: Date: 9/7/2023; Ambient Temp: 23 °C; Tissue Temp: 21 °C

Probe: EX3DV4 - SN7530; ConvF(9.5, 9.25, 9.3); Calibrated: 1/17/2023
Sensor-Surface: 2mm (Mechanical Surface Detection)
Electronics: DAE4 Sn1321; Calibrated: 1/17/2023
Phantom: ELI v4.0; Type: QDOVA001BB; Serial: 1065
Measurement SW: DASY52, Version 52.10 (0); SEMCAD X Version 14.6.10 (7417)

Procedure Notes:

900 MHz Micro RFID/Back Mid/Area Scan (7x7x1): Measurement grid: dx=15mm, dy=15mm

[Info: Interpolated medium parameters used for SAR evaluation.](#)
Maximum value of SAR (measured) = 4.12 W/kg

900 MHz Micro RFID/Back Mid/Zoom Scan (6x6x7)/Cube 0: Measurement grid: dx=8mm, dy=8mm, dz=5mm
Reference Value = 21.84 V/m; Power Drift = -0.04 dB
Peak SAR (extrapolated) = 12.9 W/kg
SAR(1 g) = 2.91 W/kg; SAR(10 g) = 1.65 W/kg

[Info: Interpolated medium parameters used for SAR evaluation.](#)
Maximum value of SAR (measured) = 7.39 W/kg

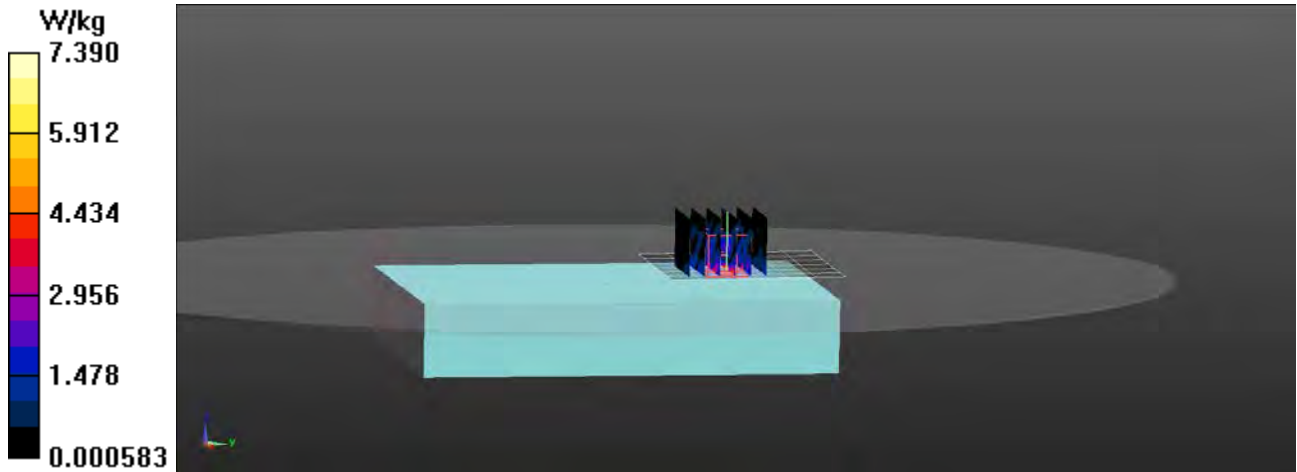

Appendix C – SAR Test Setup Photos



Test Position WWAN Back 0 mm Gap



Test Position RFID Back 0 mm Gap

Note: All cables are removed for testing.



Test Position Right 0 mm Gap



Test Position Top 0 mm Gap

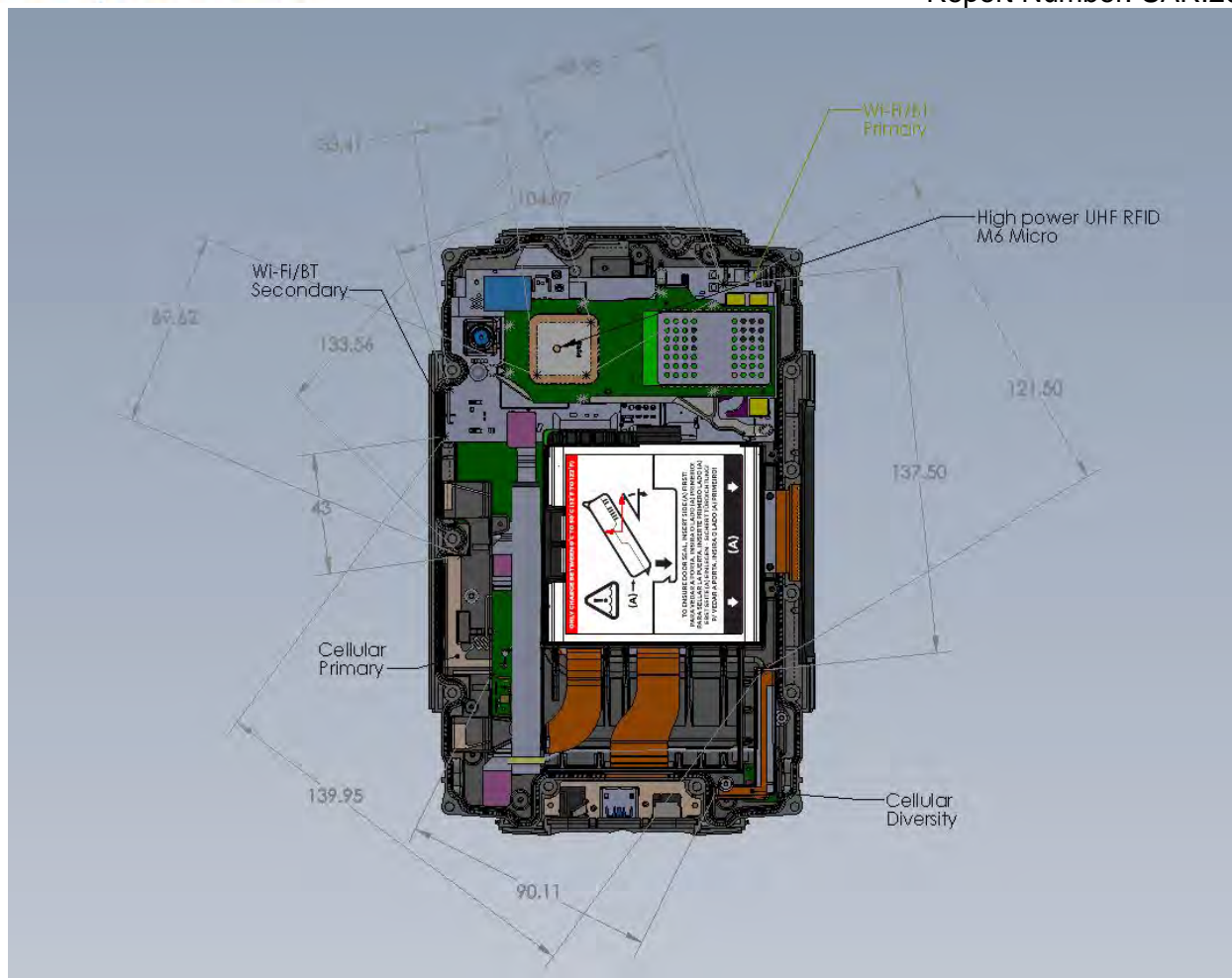

Antenna Locations with Micro RFID



Front of Device



Back of Device

Appendix D – Probe Calibration Data Sheets



Accredited by the Swiss Accreditation Service (SAS)
**The Swiss Accreditation Service is one of the signatories to the EA
Multilateral Agreement for the recognition of calibration certificates**

Accreditation No.: **SCS 0108**

Client **RF Exposure Lab**

Certificate No **EX-7530_Jan23**

CALIBRATION CERTIFICATE

Object **EX3DV4 - SN:7530**

Calibration procedure(s) **QA CAL-01.v10, QA CAL-12.v10, QA CAL-14.v7, QA CAL-23.v6,
QA CAL-25.v8
Calibration procedure for dosimetric E-field probes**

Calibration date **January 17, 2023**

This calibration certificate documents the traceability to national standards, which realize the physical units of measurements (SI).
The measurements and the uncertainties with confidence probability are given on the following pages and are part of the certificate.
All calibrations have been conducted in the closed laboratory facility: environment temperature (22 ± 3) °C and humidity < 70%.
Calibration Equipment used (M&TE critical for calibration)

Primary Standards	ID	Cal Date (Certificate No.)	Scheduled Calibration
Power meter NRP	SN: 104778	04-Apr-22 (No. 217-03525/03524)	Apr-23
Power sensor NRP-Z91	SN: 103244	04-Apr-22 (No. 217-03524)	Apr-23
OCP DAK-3.5 (weighted)	SN: 1249	20-Oct-22 (OCP-DAK3.5-1249_Oct22)	Oct-23
OCP DAK-12	SN: 1016	20-Oct-22 (OCP-DAK12-1016_Oct22)	Oct-23
Reference 20 dB Attenuator	SN: CC2552 (20x)	04-Apr-22 (No. 217-03527)	Apr-23
DAE4	SN: 660	10-Oct-22 (No. DAE4-660_Oct22)	Oct-23
Reference Probe ES3DV2	SN: 3013	06-Jan-23 (No. ES3-3013_Jan23)	Jan-24

Secondary Standards	ID	Check Date (in house)	Scheduled Check
Power meter E4419B	SN: GB41293874	06-Apr-16 (in house check Jun-22)	In house check: Jun-24
Power sensor E4412A	SN: MY41498087	06-Apr-16 (in house check Jun-22)	In house check: Jun-24
Power sensor E4412A	SN: 000110210	06-Apr-16 (in house check Jun-22)	In house check: Jun-24
RF generator HP 8648C	SN: US3642U01700	04-Aug-99 (in house check Jun-22)	In house check: Jun-24
Network Analyzer E8358A	SN: US41080477	31-Mar-14 (in house check Oct-22)	In house check: Oct-24

	Name	Function	Signature
Calibrated by	Joanna Lleshaj	Laboratory Technician	
Approved by	Sven Kühn	Technical Manager	

Issued: January 23, 2023

This calibration certificate shall not be reproduced except in full without written approval of the laboratory.



Accredited by the Swiss Accreditation Service (SAS)
**The Swiss Accreditation Service is one of the signatories to the EA
Multilateral Agreement for the recognition of calibration certificates**

Accreditation No.: SCS 0108

Glossary

TSL	tissue simulating liquid
NORM _{x,y,z}	sensitivity in free space
ConvF	sensitivity in TSL / NORM _{x,y,z}
DCP	diode compression point
CF	crest factor (1/duty_cycle) of the RF signal
A, B, C, D	modulation dependent linearization parameters
Polarization φ	φ rotation around probe axis
Polarization ϑ	ϑ rotation around an axis that is in the plane normal to probe axis (at measurement center), i.e., $\vartheta = 0$ is normal to probe axis
Connector Angle	information used in DASY system to align probe sensor X to the robot coordinate system

Calibration is Performed According to the Following Standards:

- IEC/IEEE 62209-1528, "Measurement Procedure For The Assessment Of Specific Absorption Rate Of Human Exposure To Radio Frequency Fields From Hand-Held And Body-Worn Wireless Communication Devices – Part 1528: Human Models, Instrumentation And Procedures (Frequency Range of 4 MHz to 10 GHz)", October 2020.
- KDB 865664, "SAR Measurement Requirements for 100 MHz to 6 GHz"

Methods Applied and Interpretation of Parameters:

- NORM_{x,y,z}**: Assessed for E-field polarization $\vartheta = 0$ ($f \leq 900$ MHz in TEM-cell; $f > 1800$ MHz: R22 waveguide). NORM_{x,y,z} are only intermediate values, i.e., the uncertainties of NORM_{x,y,z} does not affect the E²-field uncertainty inside TSL (see below ConvF).
- NORM(f)_{x,y,z} = NORM_{x,y,z} * frequency_response** (see Frequency Response Chart). This linearization is implemented in DASY4 software versions later than 4.2. The uncertainty of the frequency response is included in the stated uncertainty of ConvF.
- DCP_{x,y,z}**: DCP are numerical linearization parameters assessed based on the data of power sweep with CW signal. DCP does not depend on frequency nor media.
- PAR**: PAR is the Peak to Average Ratio that is not calibrated but determined based on the signal characteristics
- A_{x,y,z}; B_{x,y,z}; C_{x,y,z}; D_{x,y,z}; VR_{x,y,z}**: A, B, C, D are numerical linearization parameters assessed based on the data of power sweep for specific modulation signal. The parameters do not depend on frequency nor media. VR is the maximum calibration range expressed in RMS voltage across the diode.
- ConvF and Boundary Effect Parameters**: Assessed in flat phantom using E-field (or Temperature Transfer Standard for $f \leq 800$ MHz) and inside waveguide using analytical field distributions based on power measurements for $f > 800$ MHz. The same setups are used for assessment of the parameters applied for boundary compensation (alpha, depth) of which typical uncertainty values are given. These parameters are used in DASY4 software to improve probe accuracy close to the boundary. The sensitivity in TSL corresponds to NORM_{x,y,z} * ConvF whereby the uncertainty corresponds to that given for ConvF. A frequency dependent ConvF is used in DASY version 4.4 and higher which allows extending the validity from ± 50 MHz to ± 100 MHz.
- Spherical isotropy (3D deviation from isotropy)**: in a field of low gradients realized using a flat phantom exposed by a patch antenna.
- Sensor Offset**: The sensor offset corresponds to the offset of virtual measurement center from the probe tip (on probe axis). No tolerance required.
- Connector Angle**: The angle is assessed using the information gained by determining the NORM_x (no uncertainty required).

Parameters of Probe: EX3DV4 - SN:7530**Basic Calibration Parameters**

	Sensor X	Sensor Y	Sensor Z	Unc ($k = 2$)
Norm ($\mu\text{V}/(\text{V}/\text{m})^2$) ^A	0.42	0.53	0.42	$\pm 10.1\%$
DCP (mV) ^B	96.0	95.0	98.0	$\pm 4.7\%$

Calibration Results for Modulation Response

UID	Communication System Name		A dB	B dB $\sqrt{\mu\text{V}}$	C	D dB	VR mV	Max dev.	Max Unc ^E $k = 2$
0	CW	X	0.00	0.00	1.00	0.00	128.4	$\pm 2.5\%$	$\pm 4.7\%$
		Y	0.00	0.00	1.00		120.9		
		Z	0.00	0.00	1.00		104.7		

The reported uncertainty of measurement is stated as the standard uncertainty of measurement multiplied by the coverage factor $k=2$, which for a normal distribution corresponds to a coverage probability of approximately 95%.

^A The uncertainties of Norm X,Y,Z do not affect the E^2 -field uncertainty inside TSL (see Page 5).

^B Linearization parameter uncertainty for maximum specified field strength.

^E Uncertainty is determined using the max. deviation from linear response applying rectangular distribution and is expressed for the square of the field value.

Parameters of Probe: EX3DV4 - SN:7530**Other Probe Parameters**

Sensor Arrangement	Triangular
Connector Angle	35.7°
Mechanical Surface Detection Mode	enabled
Optical Surface Detection Mode	disabled
Probe Overall Length	337 mm
Probe Body Diameter	10 mm
Tip Length	9 mm
Tip Diameter	2.5 mm
Probe Tip to Sensor X Calibration Point	1 mm
Probe Tip to Sensor Y Calibration Point	1 mm
Probe Tip to Sensor Z Calibration Point	1 mm
Recommended Measurement Distance from Surface	1.4 mm

Note: Measurement distance from surface can be increased to 3–4 mm for an *Area Scan* job.

Parameters of Probe: EX3DV4 - SN:7530**Calibration Parameter Determined in Head Tissue Simulating Media**

f (MHz) ^C	Relative Permittivity ^F	Conductivity ^F (S/m)	ConvF X	ConvF Y	ConvF Z	Alpha ^G	Depth ^G (mm)	Unc (k = 2)
13	55.0	0.75	22.02	22.02	22.02	0.00	1.25	±13.3%
30	55.0	0.75	19.87	19.87	19.87	0.00	1.25	±13.3%
750	41.9	0.89	9.62	9.26	10.37	0.35	1.27	±12.0%
900	41.5	0.97	9.50	9.25	9.30	0.35	1.27	±12.0%
1300	40.8	1.14	8.19	8.15	8.38	0.40	1.27	±12.0%
1750	40.1	1.37	8.28	8.22	8.47	0.28	1.27	±12.0%
1900	40.0	1.40	8.14	8.08	8.31	0.29	1.27	±12.0%
2300	39.5	1.67	7.59	7.55	7.71	0.30	1.27	±12.0%
2450	39.2	1.80	7.18	7.11	7.21	0.32	1.27	±12.0%
2600	39.0	1.96	7.54	7.33	7.61	0.32	1.27	±12.0%
3300	38.2	2.71	6.92	6.92	7.03	0.35	1.27	±14.0%
3500	37.9	2.91	6.65	6.65	6.76	0.36	1.27	±14.0%
3700	37.7	3.12	6.51	6.52	6.65	0.37	1.27	±14.0%
3900	37.5	3.32	6.83	6.80	6.94	0.37	1.27	±14.0%
4200	37.1	3.63	6.47	6.47	6.61	0.37	1.27	±14.0%
4600	36.7	4.04	6.22	6.23	6.35	0.40	1.27	±14.0%
4950	36.3	4.40	5.65	5.58	5.83	0.43	1.36	±14.0%
5250	35.9	4.71	5.26	5.20	5.38	0.34	1.62	±14.0%
5600	35.5	5.07	4.49	4.39	4.63	0.41	1.67	±14.0%
5750	35.4	5.22	4.60	4.58	4.72	0.43	1.75	±14.0%

^C Frequency validity above 300 MHz of ±100 MHz only applies for DASY v4.4 and higher (see Page 2), else it is restricted to ±50 MHz. The uncertainty is the RSS of the ConvF uncertainty at calibration frequency and the uncertainty for the indicated frequency band. Frequency validity below 300 MHz is ±10, 25, 40, 50 and 70 MHz for ConvF assessments at 30, 64, 128, 150 and 220 MHz respectively. Validity of ConvF assessed at 6 MHz is 4–9 MHz, and ConvF assessed at 13 MHz is 9–19 MHz. Above 5 GHz frequency validity can be extended to ±110 MHz.

^F The probes are calibrated using tissue simulating liquids (TSL) that deviate for ϵ and σ by less than ±5% from the target values (typically better than ±3%) and are valid for TSL with deviations of up to ±10%. If TSL with deviations from the target of less than ±5% are used, the calibration uncertainties are 11.1% for 0.7 - 3 GHz and 13.1% for 3 - 6 GHz.

^G Alpha/Depth are determined during calibration. SPEAG warrants that the remaining deviation due to the boundary effect after compensation is always less than ±1% for frequencies below 3 GHz and below ±2% for frequencies between 3–6 GHz at any distance larger than half the probe tip diameter from the boundary.

Frequency Response of E-Field

(TEM-Cell:ifi110 EXX, Waveguide:R22)

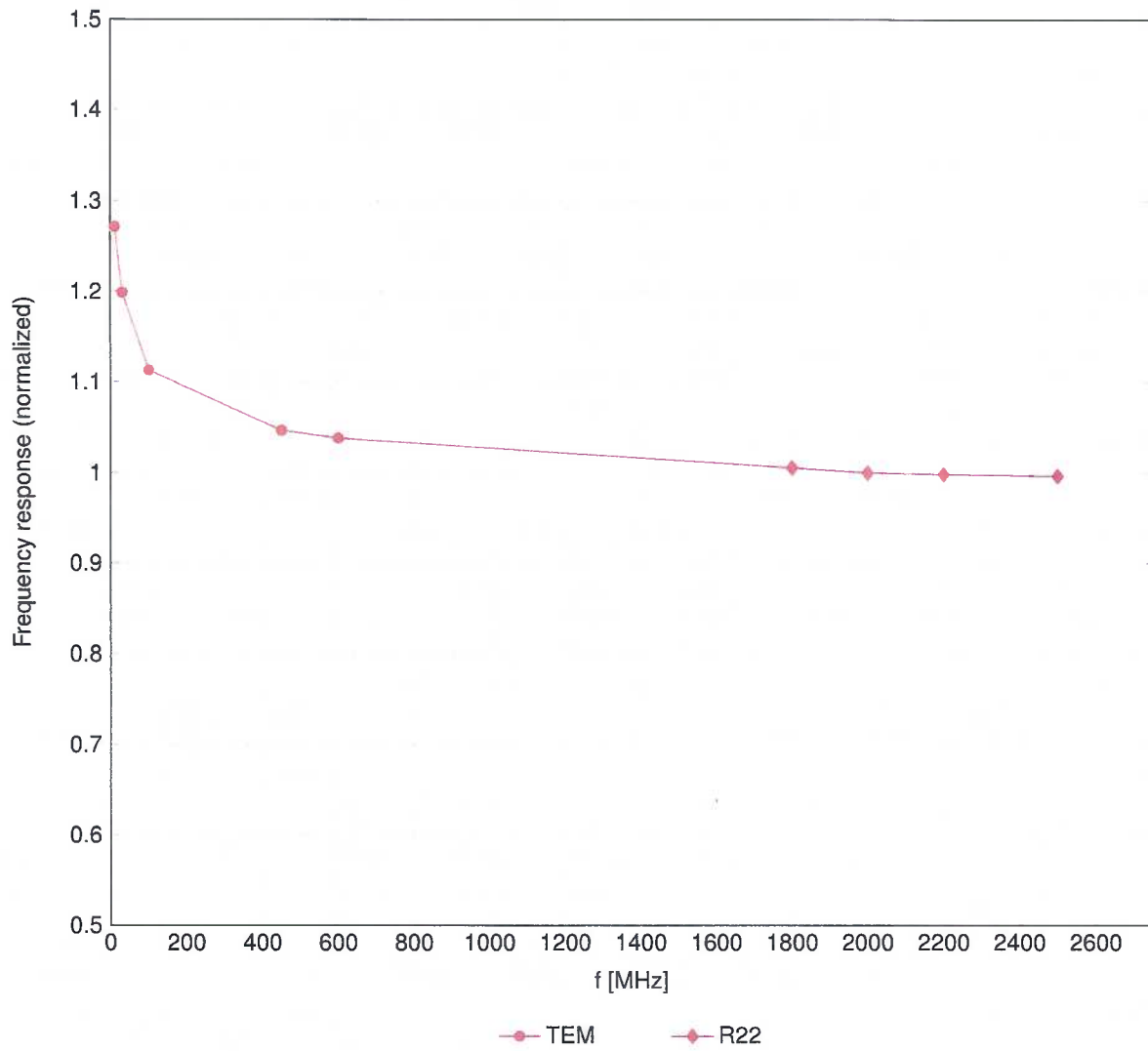

Uncertainty of Frequency Response of E-field: $\pm 6.3\%$ (k=2)

Receiving Pattern (ϕ), $\theta = 0^\circ$

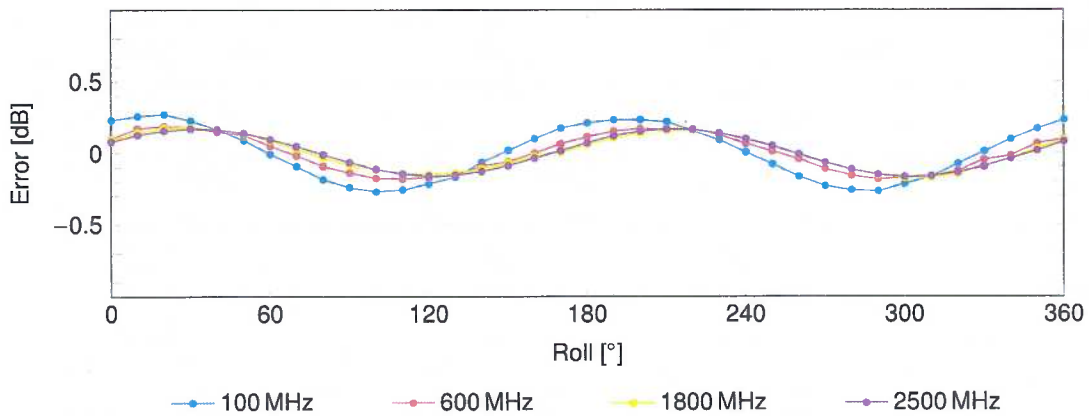
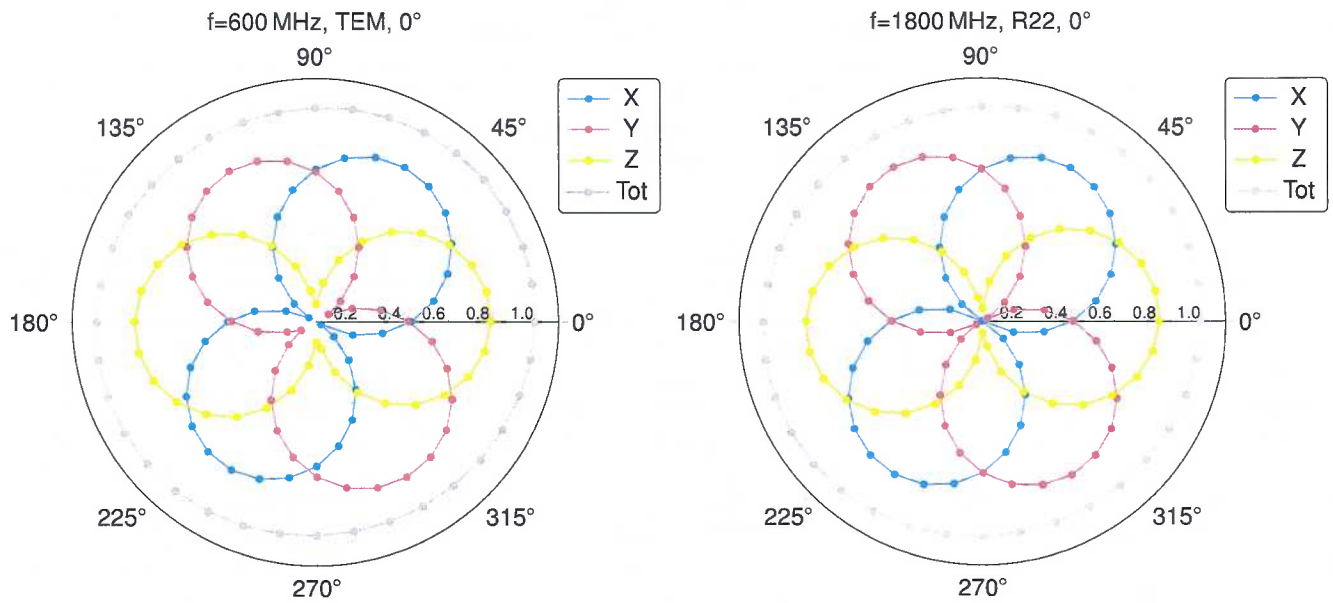

Uncertainty of Axial Isotropy Assessment: $\pm 0.5\%$ ($k=2$)

Dynamic Range $f(\text{SAR}_{\text{head}})$

(TEM cell, $f_{\text{eval}} = 1900 \text{ MHz}$)

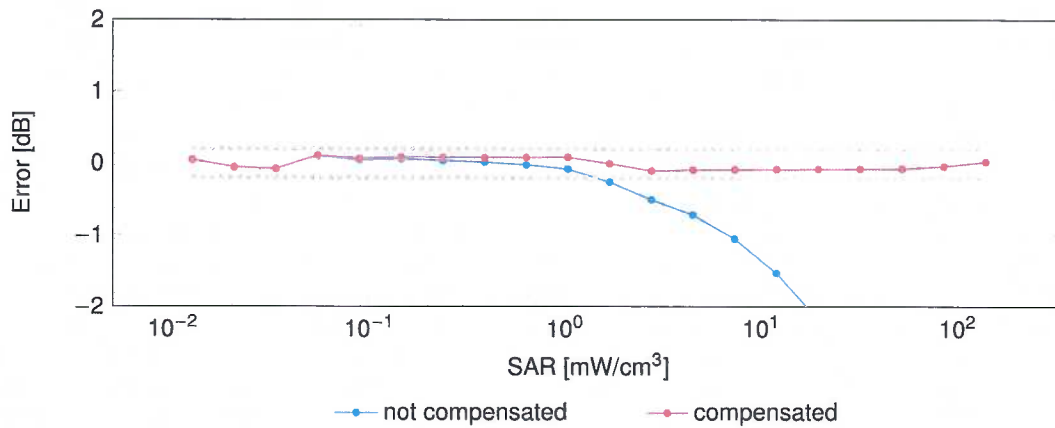
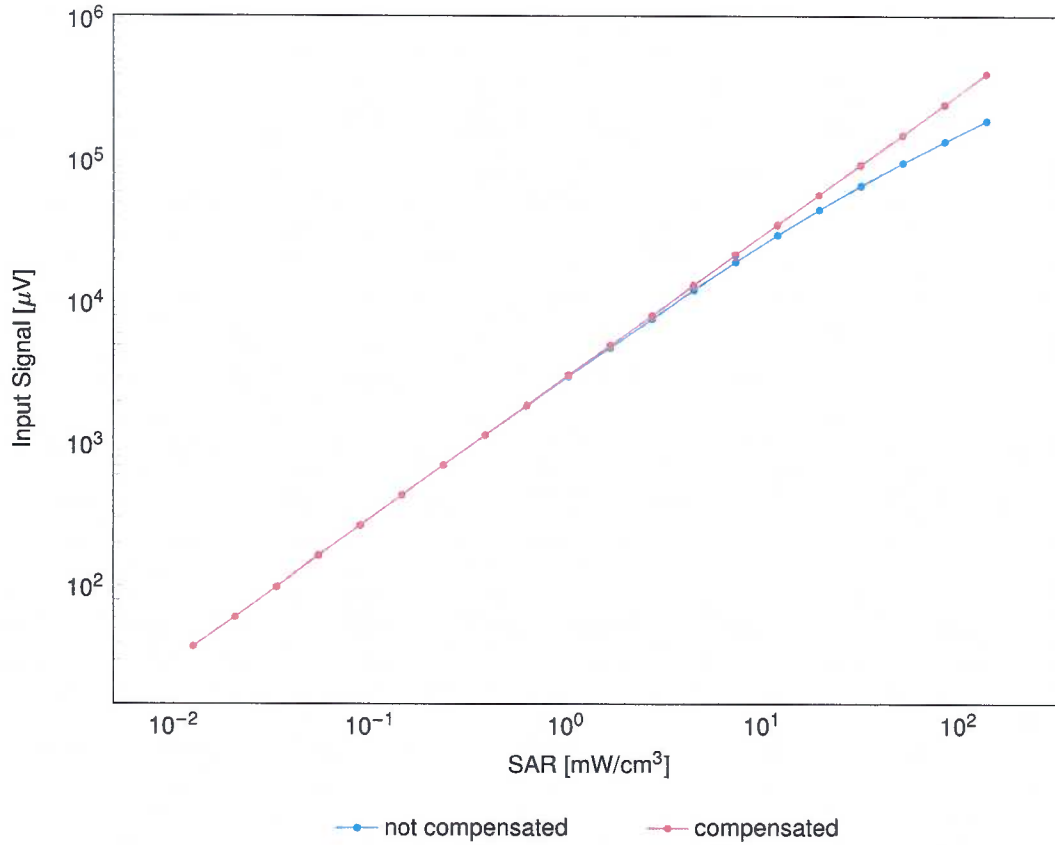

Uncertainty of Linearity Assessment: $\pm 0.6\%$ ($k=2$)

Conversion Factor Assessment

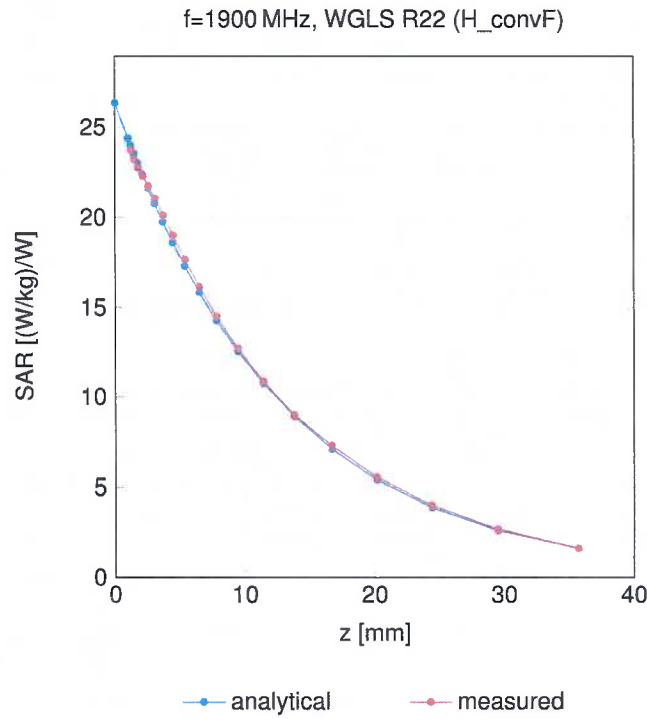

Deviation from Isotropy in Liquid

Error (ϕ, θ), f = 900 MHz

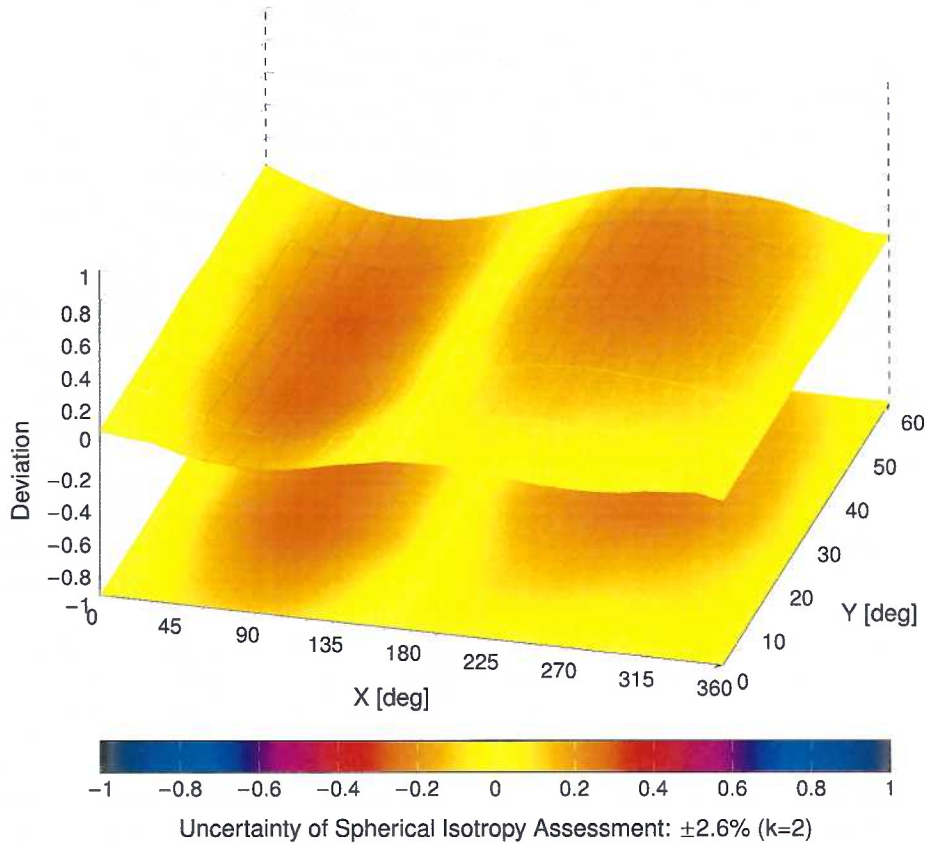

Appendix E – Dipole Calibration Data Sheets

gm

**Calibration Laboratory of
Schmid & Partner
Engineering AG**
Zeughausstrasse 43, 8004 Zurich, Switzerland



S Schweizerischer Kalibrierdienst
C Service suisse d'étalonnage
S Servizio svizzero di taratura
S Swiss Calibration Service

Accredited by the Swiss Accreditation Service (SAS)
The Swiss Accreditation Service is one of the signatories to the EA
Multilateral Agreement for the recognition of calibration certificates

Accreditation No.: **SCS 0108**

Client **RF Exposure Lab**

Certificate No: **D750V3-1053_Jun21**

CALIBRATION CERTIFICATE

Object **D750V3 - SN:1053**

Calibration procedure(s) **QA CAL-05.v11
Calibration Procedure for SAR Validation Sources between 0.7-3 GHz**

Calibration date: **June 04, 2021**

This calibration certificate documents the traceability to national standards, which realize the physical units of measurements (SI).
The measurements and the uncertainties with confidence probability are given on the following pages and are part of the certificate.

All calibrations have been conducted in the closed laboratory facility: environment temperature (22 ± 3)°C and humidity < 70%.

Calibration Equipment used (M&TE critical for calibration)

Primary Standards	ID #	Cal Date (Certificate No.)	Scheduled Calibration
Power meter NRP	SN: 104778	09-Apr-21 (No. 217-03291/03292)	Apr-22
Power sensor NRP-Z91	SN: 103244	09-Apr-21 (No. 217-03291)	Apr-22
Power sensor NRP-Z91	SN: 103245	09-Apr-21 (No. 217-03292)	Apr-22
Reference 20 dB Attenuator	SN: BH9394 (20k)	09-Apr-21 (No. 217-03343)	Apr-22
Type-N mismatch combination	SN: 310982 / 06327	09-Apr-21 (No. 217-03344)	Apr-22
Reference Probe EX3DV4	SN: 7349	28-Dec-20 (No. EX3-7349_Dec20)	Dec-21
DAE4	SN: 601	02-Nov-20 (No. DAE4-601_Nov20)	Nov-21
Secondary Standards	ID #	Check Date (in house)	Scheduled Check
Power meter E4419B	SN: GB39512475	30-Oct-14 (in house check Oct-20)	In house check: Oct-22
Power sensor HP 8481A	SN: US37292783	07-Oct-15 (in house check Oct-20)	In house check: Oct-22
Power sensor HP 8481A	SN: MY41092317	07-Oct-15 (in house check Oct-20)	In house check: Oct-22
RF generator R&S SMT-06	SN: 100972	15-Jun-15 (in house check Oct-20)	In house check: Oct-22
Network Analyzer Agilent E8358A	SN: US41080477	31-Mar-14 (in house check Oct-20)	In house check: Oct-21

Calibrated by: **Michael Weber** Name: Michael Weber Function: Laboratory Technician

Signature:

Approved by: **Katja Pokovic** Name: Katja Pokovic Function: Technical Manager

Signature:

Issued: June 8, 2021

This calibration certificate shall not be reproduced except in full without written approval of the laboratory.



Accredited by the Swiss Accreditation Service (SAS)

The Swiss Accreditation Service is one of the signatories to the EA Multilateral Agreement for the recognition of calibration certificates

Accreditation No.: **SCS 0108**

Glossary:

TSL	tissue simulating liquid
ConvF	sensitivity in TSL / NORM x,y,z
N/A	not applicable or not measured

Calibration is Performed According to the Following Standards:

- IEEE Std 1528-2013, "IEEE Recommended Practice for Determining the Peak Spatial-Averaged Specific Absorption Rate (SAR) in the Human Head from Wireless Communications Devices: Measurement Techniques", June 2013
- IEC 62209-1, "Measurement procedure for the assessment of Specific Absorption Rate (SAR) from hand-held and body-mounted devices used next to the ear (frequency range of 300 MHz to 6 GHz)", July 2016
- IEC 62209-2, "Procedure to determine the Specific Absorption Rate (SAR) for wireless communication devices used in close proximity to the human body (frequency range of 30 MHz to 6 GHz)", March 2010
- KDB 865664, "SAR Measurement Requirements for 100 MHz to 6 GHz"

Additional Documentation:

- DASY4/5 System Handbook

Methods Applied and Interpretation of Parameters:

- Measurement Conditions:** Further details are available from the Validation Report at the end of the certificate. All figures stated in the certificate are valid at the frequency indicated.
- Antenna Parameters with TSL:** The dipole is mounted with the spacer to position its feed point exactly below the center marking of the flat phantom section, with the arms oriented parallel to the body axis.
- Feed Point Impedance and Return Loss:** These parameters are measured with the dipole positioned under the liquid filled phantom. The impedance stated is transformed from the measurement at the SMA connector to the feed point. The Return Loss ensures low reflected power. No uncertainty required.
- Electrical Delay:** One-way delay between the SMA connector and the antenna feed point. No uncertainty required.
- SAR measured:** SAR measured at the stated antenna input power.
- SAR normalized:** SAR as measured, normalized to an input power of 1 W at the antenna connector.
- SAR for nominal TSL parameters:** The measured TSL parameters are used to calculate the nominal SAR result.

The reported uncertainty of measurement is stated as the standard uncertainty of measurement multiplied by the coverage factor $k=2$, which for a normal distribution corresponds to a coverage probability of approximately 95%.

Measurement Conditions

DASY system configuration, as far as not given on page 1.

DASY Version	DASY5	V52.10.4
Extrapolation	Advanced Extrapolation	
Phantom	Modular Flat Phantom	
Distance Dipole Center - TSL	15 mm	with Spacer
Zoom Scan Resolution	dx, dy, dz = 5 mm	
Frequency	750 MHz \pm 1 MHz	

Head TSL parameters

The following parameters and calculations were applied.

	Temperature	Permittivity	Conductivity
Nominal Head TSL parameters	22.0 °C	41.9	0.89 mho/m
Measured Head TSL parameters	(22.0 \pm 0.2) °C	42.7 \pm 6 %	0.91 mho/m \pm 6 %
Head TSL temperature change during test	< 0.5 °C	----	----

SAR result with Head TSL

SAR averaged over 1 cm³ (1 g) of Head TSL	Condition	
SAR measured	250 mW input power	2.17 W/kg
SAR for nominal Head TSL parameters	normalized to 1W	8.57 W/kg \pm 17.0 % (k=2)

SAR averaged over 10 cm³ (10 g) of Head TSL	condition	
SAR measured	250 mW input power	1.41 W/kg
SAR for nominal Head TSL parameters	normalized to 1W	5.58 W/kg \pm 16.5 % (k=2)

Appendix (Additional assessments outside the scope of SCS 0108)

Antenna Parameters with Head TSL

Impedance, transformed to feed point	56.5 Ω + 0.1 j Ω
Return Loss	- 24.3 dB

General Antenna Parameters and Design

Electrical Delay (one direction)	1.035 ns
----------------------------------	----------

After long term use with 100W radiated power, only a slight warming of the dipole near the feedpoint can be measured.

The dipole is made of standard semirigid coaxial cable. The center conductor of the feeding line is directly connected to the second arm of the dipole. The antenna is therefore short-circuited for DC-signals. On some of the dipoles, small end caps are added to the dipole arms in order to improve matching when loaded according to the position as explained in the "Measurement Conditions" paragraph. The SAR data are not affected by this change. The overall dipole length is still according to the Standard.

No excessive force must be applied to the dipole arms, because they might bend or the soldered connections near the feedpoint may be damaged.

Additional EUT Data

Manufactured by	SPEAG
-----------------	-------

Extended Calibration

Usage of SAR dipoles calibrated less than 3 years ago but more than 1 year ago were confirmed in maintaining return loss (<-20 dB, within 20% of prior calibration) and impedance (within 5 ohm from prior calibration) requirements per extended calibrations in KDB Publication 865664 D01 v01r04.

D750V3 SN: 1053 - Head						
Date of Measurement	Return Loss (dB)	$\Delta\%$	Impedance Real (Ω)	$\Delta\Omega$	Impedance Imaginary (j Ω)	$\Delta\Omega$
6/4/2021	-24.3		56.5		0.1	
6/4/2022	-26.2	7.8	57.9	1.4	0.3	0.2
6/6/2023	-25.6	5.3	55.2	-1.3	0.4	0.3

DASY5 Validation Report for Head TSL

Date: 04.06.2021

Test Laboratory: SPEAG, Zurich, Switzerland

DUT: Dipole 750 MHz; Type: D750V3; Serial: D750V3 - SN:1053

Communication System: UID 0 - CW; Frequency: 750 MHz

Medium parameters used: $f = 750$ MHz; $\sigma = 0.91$ S/m; $\epsilon_r = 42.7$; $\rho = 1000$ kg/m³

Phantom section: Flat Section

Measurement Standard: DASY5 (IEEE/IEC/ANSI C63.19-2011)

DASY52 Configuration:

- Probe: EX3DV4 - SN7349; ConvF(10.11, 10.11, 10.11) @ 750 MHz; Calibrated: 28.12.2020
- Sensor-Surface: 1.4mm (Mechanical Surface Detection)
- Electronics: DAE4 Sn601; Calibrated: 02.11.2020
- Phantom: Flat Phantom 4.9 (front); Type: QD 00L P49 AA; Serial: 1001
- DASY52 52.10.4(1527); SEMCAD X 14.6.14(7483)

Dipole Calibration for Head Tissue/Pin=250 mW, d=15mm/Zoom Scan (7x7x7)/Cube 0:

Measurement grid: dx=5mm, dy=5mm, dz=5mm

Reference Value = 59.74 V/m; Power Drift = 0.01 dB

Peak SAR (extrapolated) = 3.30 W/kg

SAR(1 g) = 2.17 W/kg; SAR(10 g) = 1.41 W/kg

Smallest distance from peaks to all points 3 dB below: Larger than measurement grid (> 30mm)

Ratio of SAR at M2 to SAR at M1 = 65.5%

Maximum value of SAR (measured) = 2.93 W/kg

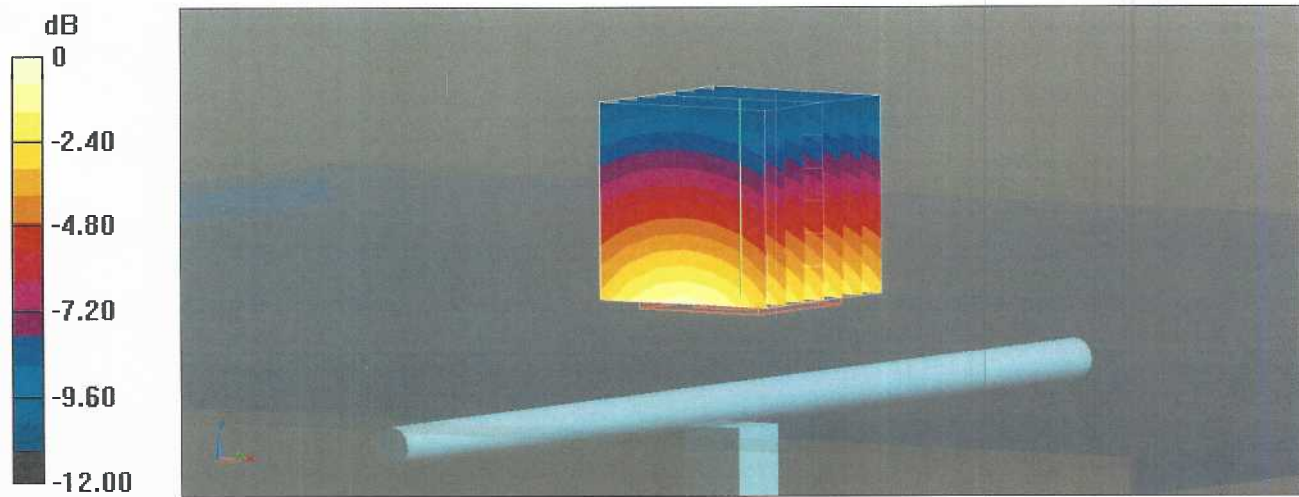

0 dB = 2.93 W/kg = 4.67 dBW/kg

Impedance Measurement Plot for Head TSL

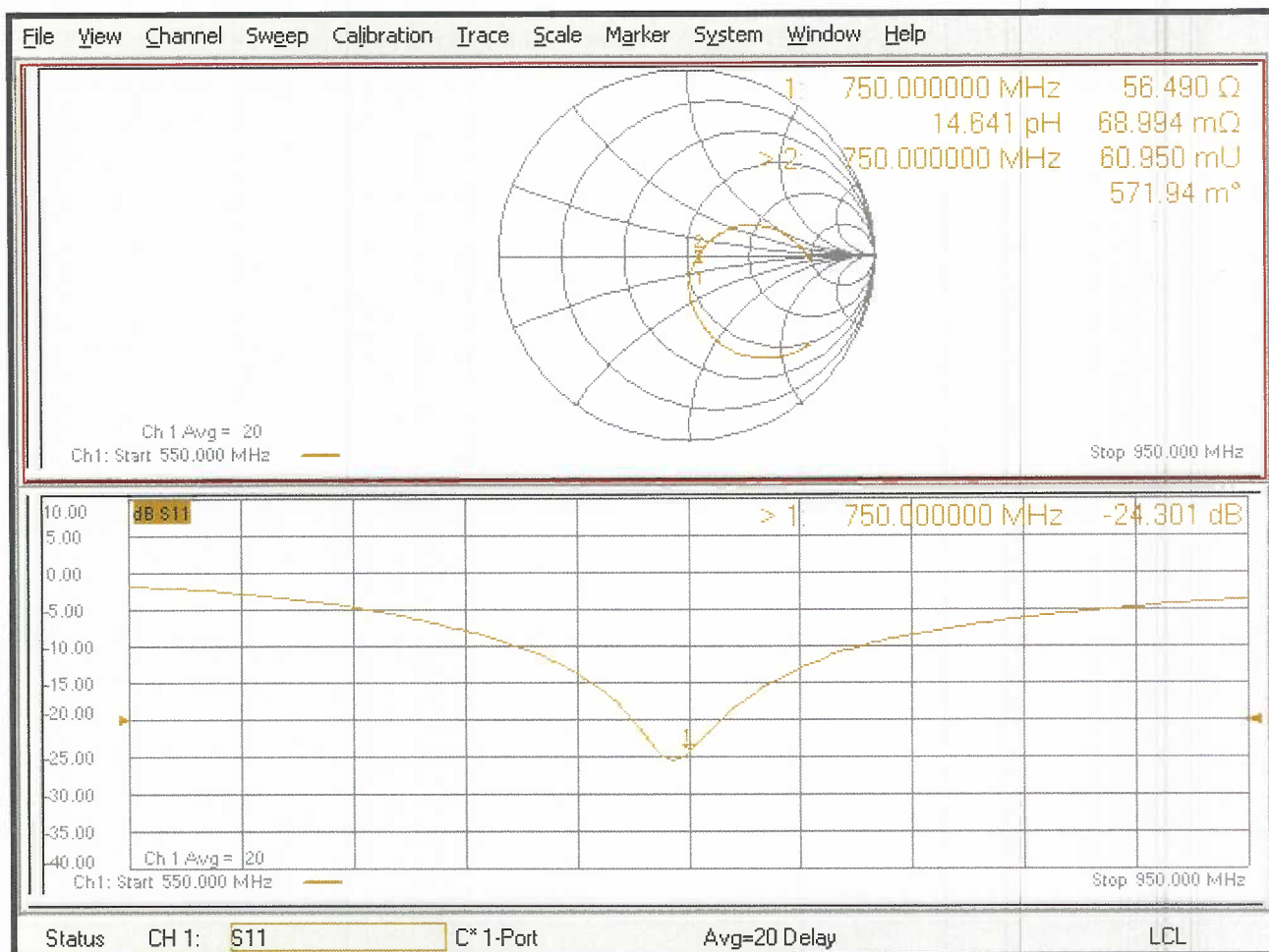

Jm

**Calibration Laboratory of
Schmid & Partner
Engineering AG**
Zeughausstrasse 43, 8004 Zurich, Switzerland



S Schweizerischer Kalibrierdienst
C Service suisse d'étalonnage
S Servizio svizzero di taratura
S Swiss Calibration Service

Accredited by the Swiss Accreditation Service (SAS)
The Swiss Accreditation Service is one of the signatories to the EA
Multilateral Agreement for the recognition of calibration certificates

Accreditation No.: **SCS 0108**

Client **RF Exposure Lab**

Certificate No: **D900V2-1d128_Jun21**

CALIBRATION CERTIFICATE

Object **D900V2 - SN:1d128**

Calibration procedure(s) **QA CAL-05.v11
Calibration Procedure for SAR Validation Sources between 0.7-3 GHz**

Calibration date: **June 04, 2021**

This calibration certificate documents the traceability to national standards, which realize the physical units of measurements (SI).
The measurements and the uncertainties with confidence probability are given on the following pages and are part of the certificate.

All calibrations have been conducted in the closed laboratory facility: environment temperature (22 ± 3)°C and humidity < 70%.

Calibration Equipment used (M&TE critical for calibration)

Primary Standards	ID #	Cal Date (Certificate No.)	Scheduled Calibration
Power meter NRP	SN: 104778	09-Apr-21 (No. 217-03291/03292)	Apr-22
Power sensor NRP-Z91	SN: 103244	09-Apr-21 (No. 217-03291)	Apr-22
Power sensor NRP-Z91	SN: 103245	09-Apr-21 (No. 217-03292)	Apr-22
Reference 20 dB Attenuator	SN: BH9394 (20k)	09-Apr-21 (No. 217-03343)	Apr-22
Type-N mismatch combination	SN: 310982 / 06327	09-Apr-21 (No. 217-03344)	Apr-22
Reference Probe EX3DV4	SN: 7349	28-Dec-20 (No. EX3-7349_Dec20)	Dec-21
DAE4	SN: 601	02-Nov-20 (No. DAE4-601_Nov20)	Nov-21
Secondary Standards	ID #	Check Date (in house)	Scheduled Check
Power meter E4419B	SN: GB39512475	30-Oct-14 (in house check Oct-20)	In house check: Oct-22
Power sensor HP 8481A	SN: US37292783	07-Oct-15 (in house check Oct-20)	In house check: Oct-22
Power sensor HP 8481A	SN: MY41092317	07-Oct-15 (in house check Oct-20)	In house check: Oct-22
RF generator R&S SMT-06	SN: 100972	15-Jun-15 (in house check Oct-20)	In house check: Oct-22
Network Analyzer Agilent E8358A	SN: US41080477	31-Mar-14 (in house check Oct-20)	In house check: Oct-21

Calibrated by: **Michael Weber** Name: **Michael Weber** Function: **Laboratory Technician**

Signature
M. Weber

Approved by: **Katja Pokovic** Name: **Katja Pokovic** Function: **Technical Manager**

Signature
K. Pokovic

Issued: June 8, 2021

This calibration certificate shall not be reproduced except in full without written approval of the laboratory.



Accredited by the Swiss Accreditation Service (SAS)

The Swiss Accreditation Service is one of the signatories to the EA
Multilateral Agreement for the recognition of calibration certificates

Accreditation No.: **SCS 0108**

Glossary:

TSL	tissue simulating liquid
ConvF	sensitivity in TSL / NORM x,y,z
N/A	not applicable or not measured

Calibration is Performed According to the Following Standards:

- IEEE Std 1528-2013, "IEEE Recommended Practice for Determining the Peak Spatial-Averaged Specific Absorption Rate (SAR) in the Human Head from Wireless Communications Devices: Measurement Techniques", June 2013
- IEC 62209-1, "Measurement procedure for the assessment of Specific Absorption Rate (SAR) from hand-held and body-mounted devices used next to the ear (frequency range of 300 MHz to 6 GHz)", July 2016
- IEC 62209-2, "Procedure to determine the Specific Absorption Rate (SAR) for wireless communication devices used in close proximity to the human body (frequency range of 30 MHz to 6 GHz)", March 2010
- KDB 865664, "SAR Measurement Requirements for 100 MHz to 6 GHz"

Additional Documentation:

- DASY4/5 System Handbook

Methods Applied and Interpretation of Parameters:

- Measurement Conditions:** Further details are available from the Validation Report at the end of the certificate. All figures stated in the certificate are valid at the frequency indicated.
- Antenna Parameters with TSL:** The dipole is mounted with the spacer to position its feed point exactly below the center marking of the flat phantom section, with the arms oriented parallel to the body axis.
- Feed Point Impedance and Return Loss:** These parameters are measured with the dipole positioned under the liquid filled phantom. The impedance stated is transformed from the measurement at the SMA connector to the feed point. The Return Loss ensures low reflected power. No uncertainty required.
- Electrical Delay:** One-way delay between the SMA connector and the antenna feed point. No uncertainty required.
- SAR measured:** SAR measured at the stated antenna input power.
- SAR normalized:** SAR as measured, normalized to an input power of 1 W at the antenna connector.
- SAR for nominal TSL parameters:** The measured TSL parameters are used to calculate the nominal SAR result.

The reported uncertainty of measurement is stated as the standard uncertainty of measurement multiplied by the coverage factor $k=2$, which for a normal distribution corresponds to a coverage probability of approximately 95%.

Measurement Conditions

DASY system configuration, as far as not given on page 1.

DASY Version	DASY5	V52.10.4
Extrapolation	Advanced Extrapolation	
Phantom	Modular Flat Phantom	
Distance Dipole Center - TSL	15 mm	with Spacer
Zoom Scan Resolution	dx, dy, dz = 5 mm	
Frequency	900 MHz ± 1 MHz	

Head TSL parameters

The following parameters and calculations were applied.

	Temperature	Permittivity	Conductivity
Nominal Head TSL parameters	22.0 °C	41.5	0.97 mho/m
Measured Head TSL parameters	(22.0 ± 0.2) °C	42.3 ± 6 %	0.96 mho/m ± 6 %
Head TSL temperature change during test	< 0.5 °C	----	----

SAR result with Head TSL

SAR averaged over 1 cm³ (1 g) of Head TSL	Condition	
SAR measured	250 mW input power	2.76 W/kg
SAR for nominal Head TSL parameters	normalized to 1W	11.2 W/kg ± 17.0 % (k=2)

SAR averaged over 10 cm³ (10 g) of Head TSL	condition	
SAR measured	250 mW input power	1.77 W/kg
SAR for nominal Head TSL parameters	normalized to 1W	7.14 W/kg ± 16.5 % (k=2)

Appendix (Additional assessments outside the scope of SCS 0108)

Antenna Parameters with Head TSL

Impedance, transformed to feed point	51.0 Ω - 0.6 $j\Omega$
Return Loss	- 38.5 dB

General Antenna Parameters and Design

Electrical Delay (one direction)	1.412 ns
----------------------------------	----------

After long term use with 100W radiated power, only a slight warming of the dipole near the feedpoint can be measured.

The dipole is made of standard semirigid coaxial cable. The center conductor of the feeding line is directly connected to the second arm of the dipole. The antenna is therefore short-circuited for DC-signals. On some of the dipoles, small end caps are added to the dipole arms in order to improve matching when loaded according to the position as explained in the "Measurement Conditions" paragraph. The SAR data are not affected by this change. The overall dipole length is still according to the Standard.

No excessive force must be applied to the dipole arms, because they might bend or the soldered connections near the feedpoint may be damaged.

Additional EUT Data

Manufactured by	SPEAG
-----------------	-------

Extended Calibration

Usage of SAR dipoles calibrated less than 3 years ago but more than 1 year ago were confirmed in maintaining return loss (<-20 dB, within 20% of prior calibration) and impedance (within 5 ohm from prior calibration) requirements per extended calibrations in KDB Publication 865664 D01 v01r04.

D900V2 SN: 1d128 - Head						
Date of Measurement	Return Loss (dB)	$\Delta\%$	Impedance Real (Ω)	$\Delta\Omega$	Impedance Imaginary ($j\Omega$)	$\Delta\Omega$
6/4/2021	-38.5		51.0		-0.6	
6/4/2022	-37.2	-3.4	52.3	1.3	-0.8	-0.2
6/6/2023	-36.8	-4.4	52.9	1.9	-0.7	-0.1

DASY5 Validation Report for Head TSL

Date: 04.06.2021

Test Laboratory: SPEAG, Zurich, Switzerland

DUT: Dipole 900 MHz; Type: D900V2; Serial: D900V2 - SN:1d128

Communication System: UID 0 - CW; Frequency: 900 MHz

Medium parameters used: $f = 900$ MHz; $\sigma = 0.96$ S/m; $\epsilon_r = 42.3$; $\rho = 1000$ kg/m³

Phantom section: Flat Section

Measurement Standard: DASY5 (IEEE/IEC/ANSI C63.19-2011)

DASY52 Configuration:

- Probe: EX3DV4 - SN7349; ConvF(9.62, 9.62, 9.62) @ 900 MHz; Calibrated: 28.12.2020
- Sensor-Surface: 1.4mm (Mechanical Surface Detection)
- Electronics: DAE4 Sn601; Calibrated: 02.11.2020
- Phantom: Flat Phantom 4.9 (front); Type: QD 00L P49 AA; Serial: 1001
- DASY52 52.10.4(1527); SEMCAD X 14.6.14(7483)

Dipole Calibration for Head Tissue/Pin=250 mW, d=15mm/Zoom Scan (7x7x7)/Cube 0:

Measurement grid: dx=5mm, dy=5mm, dz=5mm

Reference Value = 65.79 V/m; Power Drift = 0.03 dB

Peak SAR (extrapolated) = 4.23 W/kg

SAR(1 g) = 2.76 W/kg; SAR(10 g) = 1.77 W/kg

Smallest distance from peaks to all points 3 dB below = 16 mm

Ratio of SAR at M2 to SAR at M1 = 65%

Maximum value of SAR (measured) = 3.74 W/kg

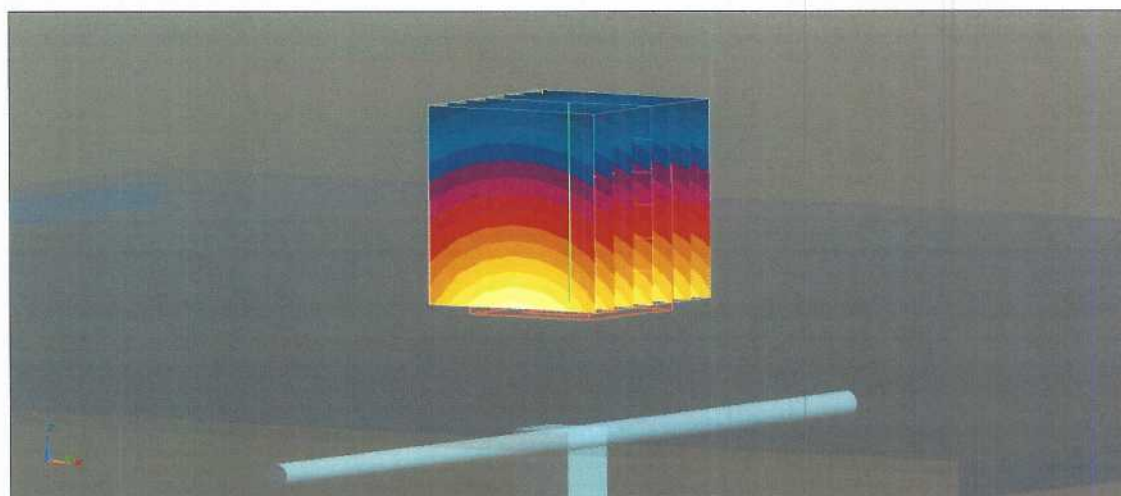
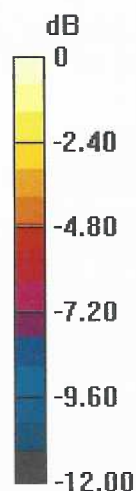

0 dB = 3.74 W/kg = 5.73 dBW/kg

Impedance Measurement Plot for Head TSL

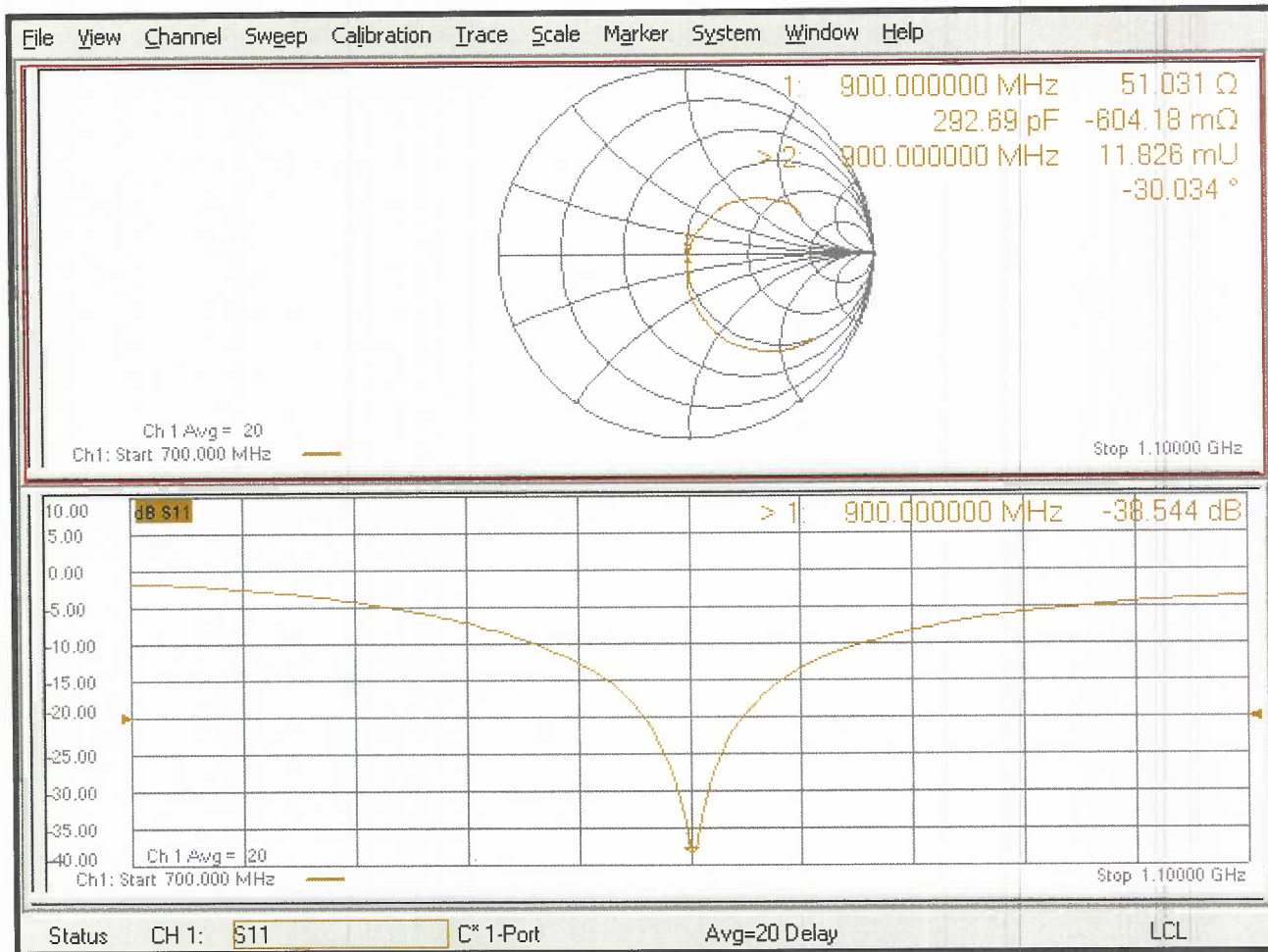

gm

Calibration Laboratory of
Schmid & Partner
Engineering AG
Zeughausstrasse 43, 8004 Zurich, Switzerland



S Schweizerischer Kalibrierdienst
C Service suisse d'étalonnage
S Servizio svizzero di taratura
S Swiss Calibration Service

Accredited by the Swiss Accreditation Service (SAS)
The Swiss Accreditation Service is one of the signatories to the EA
Multilateral Agreement for the recognition of calibration certificates

Accreditation No.: SCS 0108

Client RF Exposure Lab

Certificate No: D1750V2-1061_Jun21

CALIBRATION CERTIFICATE

Object D1750V2 - SN:1061

Calibration procedure(s) QA CAL-05 v11
Calibration Procedure for SAR Validation Sources between 0.7-3 GHz

Calibration date: June 03, 2021

This calibration certificate documents the traceability to national standards, which realize the physical units of measurements (SI).
The measurements and the uncertainties with confidence probability are given on the following pages and are part of the certificate.

All calibrations have been conducted in the closed laboratory facility: environment temperature (22 ± 3)°C and humidity < 70%.

Calibration Equipment used (M&TE critical for calibration)

Primary Standards	ID #	Cal Date (Certificate No.)	Scheduled Calibration
Power meter NRP	SN: 104778	09-Apr-21 (No. 217-03291/03292)	Apr-22
Power sensor NRP-Z91	SN: 103244	09-Apr-21 (No. 217-03291)	Apr-22
Power sensor NRP-Z91	SN: 103245	09-Apr-21 (No. 217-03292)	Apr-22
Reference 20 dB Attenuator	SN: BH9394 (20k)	09-Apr-21 (No. 217-03343)	Apr-22
Type-N mismatch combination	SN: 310982 / 06327	09-Apr-21 (No. 217-03344)	Apr-22
Reference Probe EX3DV4	SN: 7349	28-Dec-20 (No. EX3-7349_Dec20)	Dec-21
DAE4	SN: 601	02-Nov-20 (No. DAE4-601_Nov20)	Nov-21

Secondary Standards	ID #	Check Date (in house)	Scheduled Check
Power meter E4419B	SN: GB39512475	30-Oct-14 (in house check Oct-20)	In house check: Oct-22
Power sensor HP 8481A	SN: US37292783	07-Oct-15 (in house check Oct-20)	In house check: Oct-22
Power sensor HP 8481A	SN: MY41092317	07-Oct-15 (in house check Oct-20)	In house check: Oct-22
RF generator R&S SMT-06	SN: 100972	15-Jun-15 (in house check Oct-20)	In house check: Oct-22
Network Analyzer Agilent E8358A	SN: US41080477	31-Mar-14 (in house check Oct-20)	In house check: Oct-21

Calibrated by:	Name Jeffrey Katzman	Function Laboratory Technician	Signature
----------------	-------------------------	-----------------------------------	---------------

Approved by:	Name Katja Pokovic	Function Technical Manager	Signature
--------------	-----------------------	-------------------------------	---------------

Issued: June 8, 2021

This calibration certificate shall not be reproduced except in full without written approval of the laboratory.



Accredited by the Swiss Accreditation Service (SAS)

The Swiss Accreditation Service is one of the signatories to the EA
Multilateral Agreement for the recognition of calibration certificates

Accreditation No.: **SCS 0108**

Glossary:

TSL	tissue simulating liquid
ConvF	sensitivity in TSL / NORM x,y,z
N/A	not applicable or not measured

Calibration is Performed According to the Following Standards:

- IEEE Std 1528-2013, "IEEE Recommended Practice for Determining the Peak Spatial-Averaged Specific Absorption Rate (SAR) in the Human Head from Wireless Communications Devices: Measurement Techniques", June 2013
- IEC 62209-1, "Measurement procedure for the assessment of Specific Absorption Rate (SAR) from hand-held and body-mounted devices used next to the ear (frequency range of 300 MHz to 6 GHz)", July 2016
- IEC 62209-2, "Procedure to determine the Specific Absorption Rate (SAR) for wireless communication devices used in close proximity to the human body (frequency range of 30 MHz to 6 GHz)", March 2010
- KDB 865664, "SAR Measurement Requirements for 100 MHz to 6 GHz"

Additional Documentation:

- DASY4/5 System Handbook

Methods Applied and Interpretation of Parameters:

- Measurement Conditions:** Further details are available from the Validation Report at the end of the certificate. All figures stated in the certificate are valid at the frequency indicated.
- Antenna Parameters with TSL:** The dipole is mounted with the spacer to position its feed point exactly below the center marking of the flat phantom section, with the arms oriented parallel to the body axis.
- Feed Point Impedance and Return Loss:** These parameters are measured with the dipole positioned under the liquid filled phantom. The impedance stated is transformed from the measurement at the SMA connector to the feed point. The Return Loss ensures low reflected power. No uncertainty required.
- Electrical Delay:** One-way delay between the SMA connector and the antenna feed point. No uncertainty required.
- SAR measured:** SAR measured at the stated antenna input power.
- SAR normalized:** SAR as measured, normalized to an input power of 1 W at the antenna connector.
- SAR for nominal TSL parameters:** The measured TSL parameters are used to calculate the nominal SAR result.

The reported uncertainty of measurement is stated as the standard uncertainty of measurement multiplied by the coverage factor $k=2$, which for a normal distribution corresponds to a coverage probability of approximately 95%.

Measurement Conditions

DASY system configuration, as far as not given on page 1.

DASY Version	DASY5	V52.10.4
Extrapolation	Advanced Extrapolation	
Phantom	Modular Flat Phantom	
Distance Dipole Center - TSL	10 mm	with Spacer
Zoom Scan Resolution	dx, dy, dz = 5 mm	
Frequency	1750 MHz ± 1 MHz	

Head TSL parameters

The following parameters and calculations were applied.

	Temperature	Permittivity	Conductivity
Nominal Head TSL parameters	22.0 °C	40.1	1.37 mho/m
Measured Head TSL parameters	(22.0 ± 0.2) °C	40.7 ± 6 %	1.37 mho/m ± 6 %
Head TSL temperature change during test	< 0.5 °C	----	----

SAR result with Head TSL

SAR averaged over 1 cm³ (1 g) of Head TSL	Condition	
SAR measured	250 mW input power	9.38 W/kg
SAR for nominal Head TSL parameters	normalized to 1W	37.7 W/kg ± 17.0 % (k=2)

SAR averaged over 10 cm³ (10 g) of Head TSL	condition	
SAR measured	250 mW input power	4.93 W/kg
SAR for nominal Head TSL parameters	normalized to 1W	19.8 W/kg ± 16.5 % (k=2)

Appendix (Additional assessments outside the scope of SCS 0108)

Antenna Parameters with Head TSL

Impedance, transformed to feed point	49.4 Ω + 0.0 j Ω
Return Loss	- 44.5 dB

General Antenna Parameters and Design

Electrical Delay (one direction)	1.221 ns
----------------------------------	----------

After long term use with 100W radiated power, only a slight warming of the dipole near the feedpoint can be measured.

The dipole is made of standard semirigid coaxial cable. The center conductor of the feeding line is directly connected to the second arm of the dipole. The antenna is therefore short-circuited for DC-signals. On some of the dipoles, small end caps are added to the dipole arms in order to improve matching when loaded according to the position as explained in the "Measurement Conditions" paragraph. The SAR data are not affected by this change. The overall dipole length is still according to the Standard.

No excessive force must be applied to the dipole arms, because they might bend or the soldered connections near the feedpoint may be damaged.

Additional EUT Data

Manufactured by	SPEAG
-----------------	-------

Extended Calibration

Usage of SAR dipoles calibrated less than 3 years ago but more than 1 year ago were confirmed in maintaining return loss (<-20 dB, within 20% of prior calibration) and impedance (within 5 ohm from prior calibration) requirements per extended calibrations in KDB Publication 865664 D01 v01r04.

D1750V2 SN: 1061 - Head						
Date of Measurement	Return Loss (dB)	$\Delta\%$	Impedance Real (Ω)	$\Delta\Omega$	Impedance Imaginary (j Ω)	$\Delta\Omega$
6/3/2021	-44.5		49.4		0.0	
6/4/2022	-42.3	-4.9	47.9	-1.5	-0.2	-0.2
6/6/2023	-43.6	-2.0	48.5	-0.9	-0.3	-0.3

DASY5 Validation Report for Head TSL

Date: 03.06.2021

Test Laboratory: SPEAG, Zurich, Switzerland

DUT: Dipole 1750 MHz; Type: D1750V2; Serial: D1750V2 - SN:1061

Communication System: UID 0 - CW; Frequency: 1750 MHz

Medium parameters used: $f = 1750$ MHz; $\sigma = 1.37$ S/m; $\epsilon_r = 40.7$; $\rho = 1000$ kg/m³

Phantom section: Flat Section

Measurement Standard: DASY5 (IEEE/IEC/ANSI C63.19-2011)

DASY52 Configuration:

- Probe: EX3DV4 - SN7349; ConvF(8.67, 8.67, 8.67) @ 1750 MHz; Calibrated: 28.12.2020
- Sensor-Surface: 1.4mm (Mechanical Surface Detection)
- Electronics: DAE4 Sn601; Calibrated: 02.11.2020
- Phantom: Flat Phantom 5.0 (front); Type: QD 000 P50 AA; Serial: 1001
- DASY52 52.10.4(1527); SEMCAD X 14.6.14(7483)

Dipole Calibration for Head Tissue/Pin=250 mW, d=10mm/Zoom Scan (7x7x7)/Cube 0:

Measurement grid: dx=5mm, dy=5mm, dz=5mm

Reference Value = 107.4 V/m; Power Drift = 0.08 dB

Peak SAR (extrapolated) = 17.5 W/kg

SAR(1 g) = 9.38 W/kg; SAR(10 g) = 4.93 W/kg

Smallest distance from peaks to all points 3 dB below = 9.1 mm

Ratio of SAR at M2 to SAR at M1 = 54%

Maximum value of SAR (measured) = 14.6 W/kg

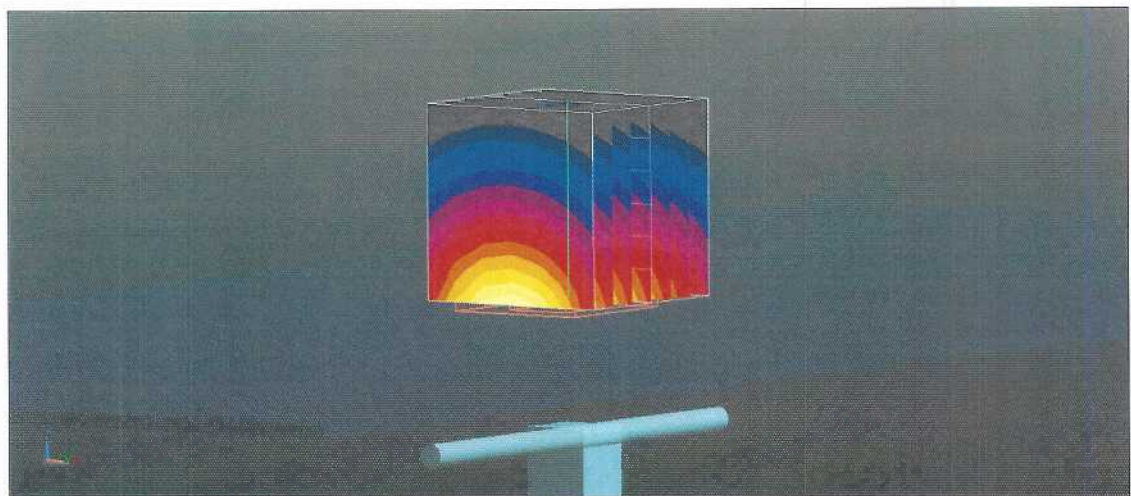
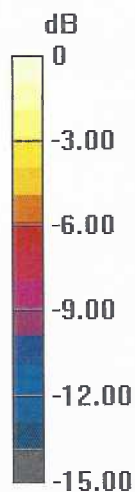

0 dB = 14.6 W/kg = 11.64 dBW/kg

Impedance Measurement Plot for Head TSL

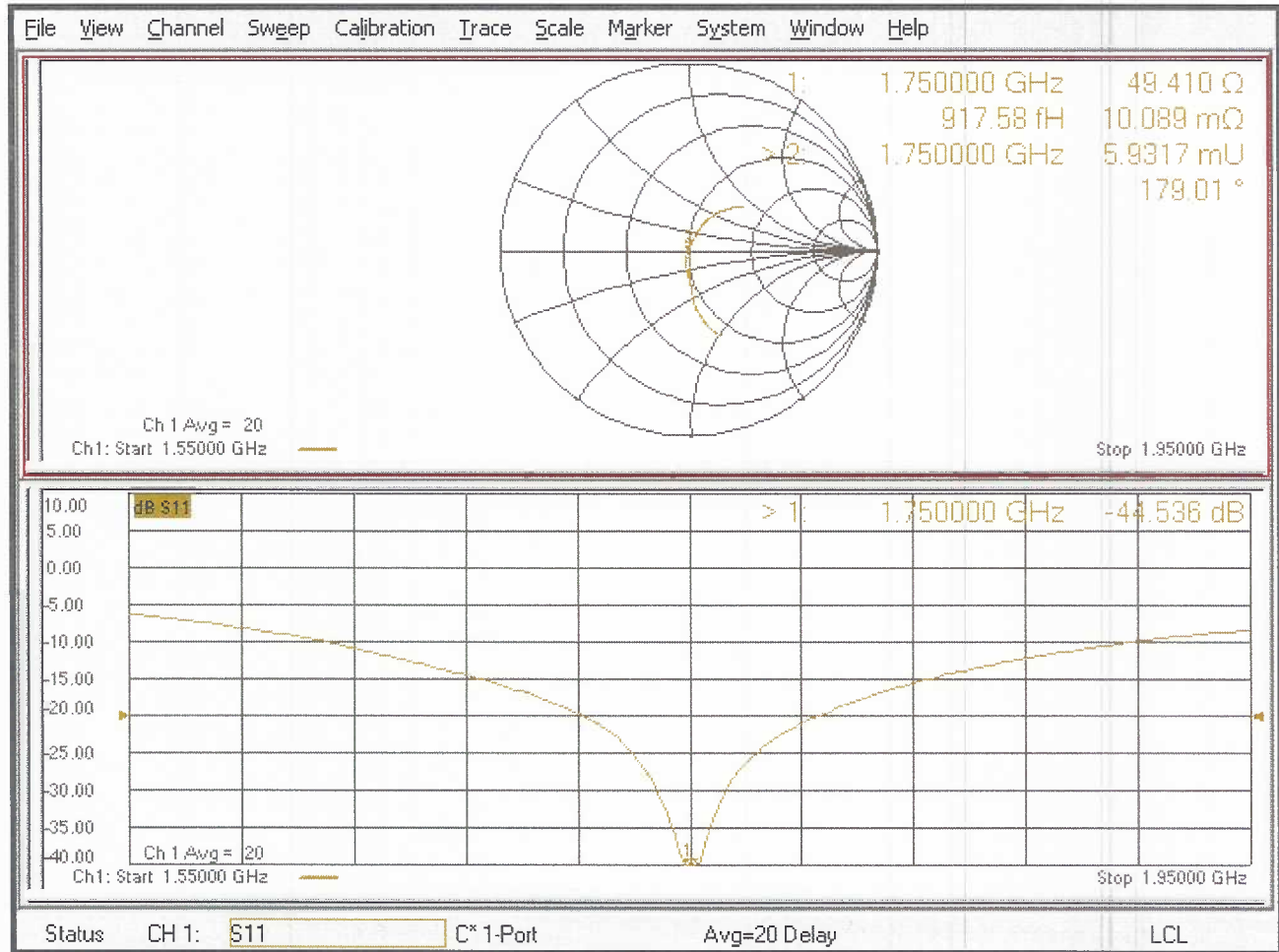

Jon

**Calibration Laboratory of
Schmid & Partner
Engineering AG**
Zeughausstrasse 43, 8004 Zurich, Switzerland



S Schweizerischer Kalibrierdienst
C Service suisse d'étalonnage
S Servizio svizzero di taratura
S Swiss Calibration Service

Accredited by the Swiss Accreditation Service (SAS)
The Swiss Accreditation Service is one of the signatories to the EA
Multilateral Agreement for the recognition of calibration certificates

Accreditation No.: **SCS 0108**

Client **RF Exposure Lab**

Certificate No: **D1900V2-5d147_Jun21**

CALIBRATION CERTIFICATE

Object **D1900V2 - SN:5d147**

Calibration procedure(s) **QA CAL-05.v11
Calibration Procedure for SAR Validation Sources between 0.7-3 GHz**

Calibration date: **June 04, 2021**

This calibration certificate documents the traceability to national standards, which realize the physical units of measurements (SI).
The measurements and the uncertainties with confidence probability are given on the following pages and are part of the certificate.

All calibrations have been conducted in the closed laboratory facility: environment temperature (22 ± 3)°C and humidity < 70%.

Calibration Equipment used (M&TE critical for calibration)

Primary Standards	ID #	Cal Date (Certificate No.)	Scheduled Calibration
Power meter NRP	SN: 104778	09-Apr-21 (No. 217-03291/03292)	Apr-22
Power sensor NRP-Z91	SN: 103244	09-Apr-21 (No. 217-03291)	Apr-22
Power sensor NRP-Z91	SN: 103245	09-Apr-21 (No. 217-03292)	Apr-22
Reference 20 dB Attenuator	SN: BH9394 (20k)	09-Apr-21 (No. 217-03343)	Apr-22
Type-N mismatch combination	SN: 310982 / 06327	09-Apr-21 (No. 217-03344)	Apr-22
Reference Probe EX3DV4	SN: 7349	28-Dec-20 (No. EX3-7349_Dec20)	Dec-21
DAE4	SN: 601	02-Nov-20 (No. DAE4-601_Nov20)	Nov-21
Secondary Standards	ID #	Check Date (in house)	Scheduled Check
Power meter E4419B	SN: GB39512475	30-Oct-14 (in house check Oct-20)	In house check: Oct-22
Power sensor HP 8481A	SN: US37292783	07-Oct-15 (in house check Oct-20)	In house check: Oct-22
Power sensor HP 8481A	SN: MY41092317	07-Oct-15 (in house check Oct-20)	In house check: Oct-22
RF generator R&S SMT-06	SN: 100972	15-Jun-15 (in house check Oct-20)	In house check: Oct-22
Network Analyzer Agilent E8358A	SN: US41080477	31-Mar-14 (in house check Oct-20)	In house check: Oct-21

Calibrated by: **Michael Weber** Laboratory Technician

Signature

Approved by: **Katja Pokovic** Technical Manager

Issued: June 8, 2021

This calibration certificate shall not be reproduced except in full without written approval of the laboratory.



Accredited by the Swiss Accreditation Service (SAS)
The Swiss Accreditation Service is one of the signatories to the EA
Multilateral Agreement for the recognition of calibration certificates

Accreditation No.: **SCS 0108**

Glossary:

TSL	tissue simulating liquid
ConvF	sensitivity in TSL / NORM x,y,z
N/A	not applicable or not measured

Calibration is Performed According to the Following Standards:

- a) IEEE Std 1528-2013, "IEEE Recommended Practice for Determining the Peak Spatial-Averaged Specific Absorption Rate (SAR) in the Human Head from Wireless Communications Devices: Measurement Techniques", June 2013
- b) IEC 62209-1, "Measurement procedure for the assessment of Specific Absorption Rate (SAR) from hand-held and body-mounted devices used next to the ear (frequency range of 300 MHz to 6 GHz)", July 2016
- c) IEC 62209-2, "Procedure to determine the Specific Absorption Rate (SAR) for wireless communication devices used in close proximity to the human body (frequency range of 30 MHz to 6 GHz)", March 2010
- d) KDB 865664, "SAR Measurement Requirements for 100 MHz to 6 GHz"

Additional Documentation:

- e) DASY4/5 System Handbook

Methods Applied and Interpretation of Parameters:

- *Measurement Conditions:* Further details are available from the Validation Report at the end of the certificate. All figures stated in the certificate are valid at the frequency indicated.
- *Antenna Parameters with TSL:* The dipole is mounted with the spacer to position its feed point exactly below the center marking of the flat phantom section, with the arms oriented parallel to the body axis.
- *Feed Point Impedance and Return Loss:* These parameters are measured with the dipole positioned under the liquid filled phantom. The impedance stated is transformed from the measurement at the SMA connector to the feed point. The Return Loss ensures low reflected power. No uncertainty required.
- *Electrical Delay:* One-way delay between the SMA connector and the antenna feed point. No uncertainty required.
- *SAR measured:* SAR measured at the stated antenna input power.
- *SAR normalized:* SAR as measured, normalized to an input power of 1 W at the antenna connector.
- *SAR for nominal TSL parameters:* The measured TSL parameters are used to calculate the nominal SAR result.

The reported uncertainty of measurement is stated as the standard uncertainty of measurement multiplied by the coverage factor $k=2$, which for a normal distribution corresponds to a coverage probability of approximately 95%.

Measurement Conditions

DASY system configuration, as far as not given on page 1.

DASY Version	DASY5	V52.10.4
Extrapolation	Advanced Extrapolation	
Phantom	Modular Flat Phantom	
Distance Dipole Center - TSL	10 mm	with Spacer
Zoom Scan Resolution	dx, dy, dz = 5 mm	
Frequency	1900 MHz \pm 1 MHz	

Head TSL parameters

The following parameters and calculations were applied.

	Temperature	Permittivity	Conductivity
Nominal Head TSL parameters	22.0 °C	40.0	1.40 mho/m
Measured Head TSL parameters	(22.0 \pm 0.2) °C	40.9 \pm 6 %	1.41 mho/m \pm 6 %
Head TSL temperature change during test	< 0.5 °C	----	----

SAR result with Head TSL

SAR averaged over 1 cm³ (1 g) of Head TSL	Condition	
SAR measured	250 mW input power	10.1 W/kg
SAR for nominal Head TSL parameters	normalized to 1W	40.4 W/kg \pm 17.0 % (k=2)

SAR averaged over 10 cm³ (10 g) of Head TSL	condition	
SAR measured	250 mW input power	5.28 W/kg
SAR for nominal Head TSL parameters	normalized to 1W	21.1 W/kg \pm 16.5 % (k=2)

Appendix (Additional assessments outside the scope of SCS 0108)

Antenna Parameters with Head TSL

Impedance, transformed to feed point	53.3 Ω + 5.4 j Ω
Return Loss	- 24.2 dB

General Antenna Parameters and Design

Electrical Delay (one direction)	1.192 ns
----------------------------------	----------

After long term use with 100W radiated power, only a slight warming of the dipole near the feedpoint can be measured.

The dipole is made of standard semirigid coaxial cable. The center conductor of the feeding line is directly connected to the second arm of the dipole. The antenna is therefore short-circuited for DC-signals. On some of the dipoles, small end caps are added to the dipole arms in order to improve matching when loaded according to the position as explained in the "Measurement Conditions" paragraph. The SAR data are not affected by this change. The overall dipole length is still according to the Standard.

No excessive force must be applied to the dipole arms, because they might bend or the soldered connections near the feedpoint may be damaged.

Additional EUT Data

Manufactured by	SPEAG
-----------------	-------

Extended Calibration

Usage of SAR dipoles calibrated less than 3 years ago but more than 1 year ago were confirmed in maintaining return loss (<-20 dB, within 20% of prior calibration) and impedance (within 5 ohm from prior calibration) requirements per extended calibrations in KDB Publication 865664 D01 v01r04.

D1900V2 SN: 5d147 - Head						
Date of Measurement	Return Loss (dB)	$\Delta\%$	Impedance Real (Ω)	$\Delta\Omega$	Impedance Imaginary (j Ω)	$\Delta\Omega$
6/4/2021	-24.2		53.3		5.4	
6/4/2022	-25.6	5.8	52.6	-0.7	5.7	0.3
6/6/2023	-26.2	8.3	54.6	1.3	5.5	0.1

DASY5 Validation Report for Head TSL

Date: 04.06.2021

Test Laboratory: SPEAG, Zurich, Switzerland

DUT: Dipole 1900 MHz; Type: D1900V2; Serial: D1900V2 - SN:5d147

Communication System: UID 0 - CW; Frequency: 1900 MHz

Medium parameters used: $f = 1900$ MHz; $\sigma = 1.41$ S/m; $\epsilon_r = 40.9$; $\rho = 1000$ kg/m³

Phantom section: Flat Section

Measurement Standard: DASY5 (IEEE/IEC/ANSI C63.19-2011)

DASY52 Configuration:

- Probe: EX3DV4 - SN7349; ConvF(8.43, 8.43, 8.43) @ 1900 MHz; Calibrated: 28.12.2020
- Sensor-Surface: 1.4mm (Mechanical Surface Detection)
- Electronics: DAE4 Sn601; Calibrated: 02.11.2020
- Phantom: Flat Phantom 5.0 (front); Type: QD 000 P50 AA; Serial: 1001
- DASY52 52.10.4(1527); SEMCAD X 14.6.14(7483)

Dipole Calibration for Head Tissue/Pin=250 mW, d=10mm/Zoom Scan (7x7x7)/Cube 0:

Measurement grid: dx=5mm, dy=5mm, dz=5mm

Reference Value = 110.2 V/m; Power Drift = 0.04 dB

Peak SAR (extrapolated) = 18.7 W/kg

SAR(1 g) = 10.1 W/kg; SAR(10 g) = 5.28 W/kg

Smallest distance from peaks to all points 3 dB below = 10 mm

Ratio of SAR at M2 to SAR at M1 = 54.6%

Maximum value of SAR (measured) = 15.6 W/kg

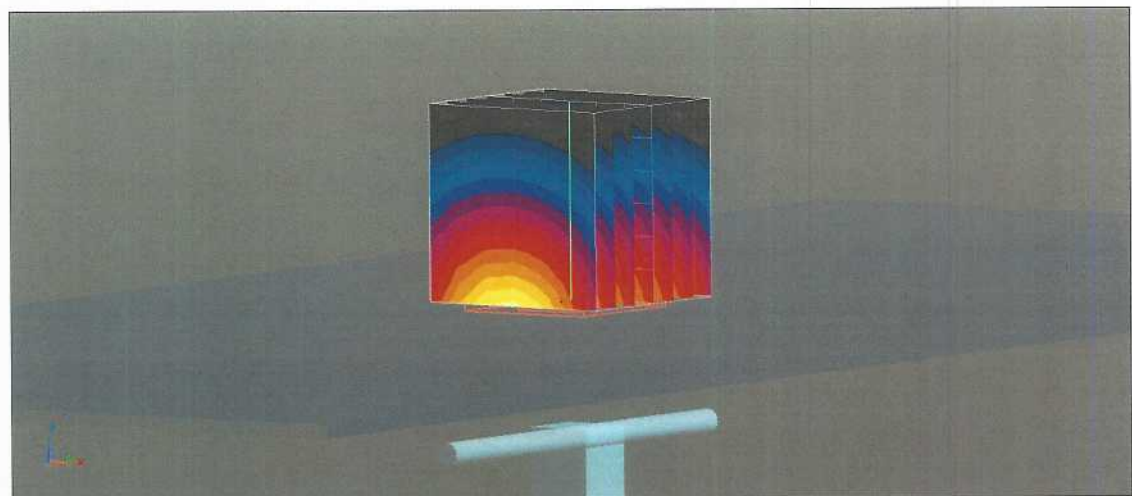
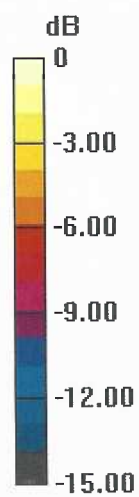

0 dB = 15.6 W/kg = 11.93 dBW/kg

Impedance Measurement Plot for Head TSL

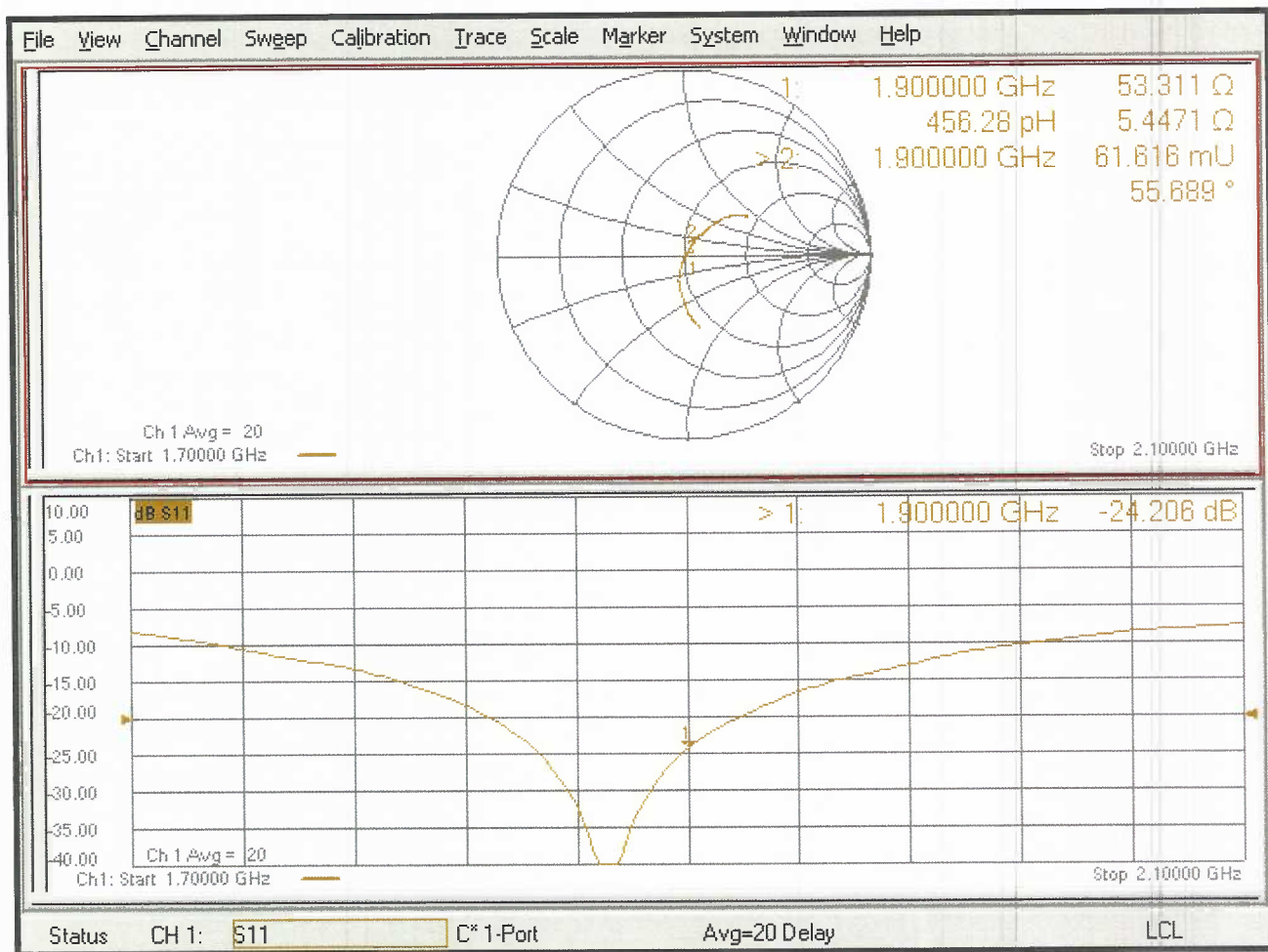

**Calibration Laboratory of
Schmid & Partner
Engineering AG**
Zeughausstrasse 43, 8004 Zurich, Switzerland



S Schweizerischer Kalibrierdienst
C Service suisse d'étalonnage
S Servizio svizzero di taratura
S Swiss Calibration Service

Accredited by the Swiss Accreditation Service (SAS)
The Swiss Accreditation Service is one of the signatories to the EA
Multilateral Agreement for the recognition of calibration certificates

Accreditation No.: **SCS 0108**

Client **RF Exposure Lab**

Certificate No: **D2550V2-1003_Jun21**

CALIBRATION CERTIFICATE

Object **D2550V2 - SN:1003**

Calibration procedure(s) **QA CAL-05.v11
Calibration Procedure for SAR Validation Sources between 0.7-3 GHz**

Calibration date: **June 03, 2021**

This calibration certificate documents the traceability to national standards, which realize the physical units of measurements (SI).
The measurements and the uncertainties with confidence probability are given on the following pages and are part of the certificate.

All calibrations have been conducted in the closed laboratory facility: environment temperature (22 ± 3)°C and humidity < 70%.

Calibration Equipment used (M&TE critical for calibration)

Primary Standards	ID #	Cal Date (Certificate No.)	Scheduled Calibration
Power meter NRP	SN: 104778	09-Apr-21 (No. 217-03291/03292)	Apr-22
Power sensor NRP-Z91	SN: 103244	09-Apr-21 (No. 217-03291)	Apr-22
Power sensor NRP-Z91	SN: 103245	09-Apr-21 (No. 217-03292)	Apr-22
Reference 20 dB Attenuator	SN: BH9394 (20k)	09-Apr-21 (No. 217-03343)	Apr-22
Type-N mismatch combination	SN: 310982 / 06327	09-Apr-21 (No. 217-03344)	Apr-22
Reference Probe EX3DV4	SN: 7349	28-Dec-20 (No. EX3-7349_Dec20)	Dec-21
DAE4	SN: 601	02-Nov-20 (No. DAE4-601_Nov20)	Nov-21

Secondary Standards	ID #	Check Date (in house)	Scheduled Check
Power meter E4419B	SN: GB39512475	30-Oct-14 (in house check Oct-20)	In house check: Oct-22
Power sensor HP 8481A	SN: US37292783	07-Oct-15 (in house check Oct-20)	In house check: Oct-22
Power sensor HP 8481A	SN: MY41092317	07-Oct-15 (in house check Oct-20)	In house check: Oct-22
RF generator R&S SMT-06	SN: 100972	15-Jun-15 (in house check Oct-20)	In house check: Oct-22
Network Analyzer Agilent E8358A	SN: US41080477	31-Mar-14 (in house check Oct-20)	In house check: Oct-21

	Name	Function	Signature
Calibrated by:	Jeffrey Katzman	Laboratory Technician	

	Name	Function	Signature
Approved by:	Katja Pokovic	Technical Manager	

Issued: June 8, 2021

This calibration certificate shall not be reproduced except in full without written approval of the laboratory.



Accredited by the Swiss Accreditation Service (SAS)

The Swiss Accreditation Service is one of the signatories to the EA
Multilateral Agreement for the recognition of calibration certificates

Accreditation No.: **SCS 0108**

Glossary:

TSL	tissue simulating liquid
ConvF	sensitivity in TSL / NORM x,y,z
N/A	not applicable or not measured

Calibration is Performed According to the Following Standards:

- IEEE Std 1528-2013, "IEEE Recommended Practice for Determining the Peak Spatial-Averaged Specific Absorption Rate (SAR) in the Human Head from Wireless Communications Devices: Measurement Techniques", June 2013
- IEC 62209-1, "Measurement procedure for the assessment of Specific Absorption Rate (SAR) from hand-held and body-mounted devices used next to the ear (frequency range of 300 MHz to 6 GHz)", July 2016
- IEC 62209-2, "Procedure to determine the Specific Absorption Rate (SAR) for wireless communication devices used in close proximity to the human body (frequency range of 30 MHz to 6 GHz)", March 2010
- KDB 865664, "SAR Measurement Requirements for 100 MHz to 6 GHz"

Additional Documentation:

- DASY4/5 System Handbook

Methods Applied and Interpretation of Parameters:

- Measurement Conditions:** Further details are available from the Validation Report at the end of the certificate. All figures stated in the certificate are valid at the frequency indicated.
- Antenna Parameters with TSL:** The dipole is mounted with the spacer to position its feed point exactly below the center marking of the flat phantom section, with the arms oriented parallel to the body axis.
- Feed Point Impedance and Return Loss:** These parameters are measured with the dipole positioned under the liquid filled phantom. The impedance stated is transformed from the measurement at the SMA connector to the feed point. The Return Loss ensures low reflected power. No uncertainty required.
- Electrical Delay:** One-way delay between the SMA connector and the antenna feed point. No uncertainty required.
- SAR measured:** SAR measured at the stated antenna input power.
- SAR normalized:** SAR as measured, normalized to an input power of 1 W at the antenna connector.
- SAR for nominal TSL parameters:** The measured TSL parameters are used to calculate the nominal SAR result.

The reported uncertainty of measurement is stated as the standard uncertainty of measurement multiplied by the coverage factor $k=2$, which for a normal distribution corresponds to a coverage probability of approximately 95%.

Measurement Conditions

DASY system configuration, as far as not given on page 1.

DASY Version	DASY5	V52.10.4
Extrapolation	Advanced Extrapolation	
Phantom	Modular Flat Phantom	
Distance Dipole Center - TSL	10 mm	with Spacer
Zoom Scan Resolution	dx, dy, dz = 5 mm	
Frequency	2550 MHz ± 1 MHz	

Head TSL parameters

The following parameters and calculations were applied.

	Temperature	Permittivity	Conductivity
Nominal Head TSL parameters	22.0 °C	39.1	1.91 mho/m
Measured Head TSL parameters	(22.0 ± 0.2) °C	37.3 ± 6 %	1.98 mho/m ± 6 %
Head TSL temperature change during test	< 0.5 °C	---	---

SAR result with Head TSL

SAR averaged over 1 cm³ (1 g) of Head TSL	Condition	
SAR measured	250 mW input power	14.2 W/kg
SAR for nominal Head TSL parameters	normalized to 1W	55.3 W/kg ± 17.0 % (k=2)

SAR averaged over 10 cm³ (10 g) of Head TSL	condition	
SAR measured	250 mW input power	6.28 W/kg
SAR for nominal Head TSL parameters	normalized to 1W	24.7 W/kg ± 16.5 % (k=2)

Appendix (Additional assessments outside the scope of SCS 0108)

Antenna Parameters with Head TSL

Impedance, transformed to feed point	49.4 Ω - 3.5 j Ω
Return Loss	- 29.0 dB

General Antenna Parameters and Design

Electrical Delay (one direction)	1.156 ns
----------------------------------	----------

After long term use with 100W radiated power, only a slight warming of the dipole near the feedpoint can be measured.

The dipole is made of standard semirigid coaxial cable. The center conductor of the feeding line is directly connected to the second arm of the dipole. The antenna is therefore short-circuited for DC-signals. On some of the dipoles, small end caps are added to the dipole arms in order to improve matching when loaded according to the position as explained in the "Measurement Conditions" paragraph. The SAR data are not affected by this change. The overall dipole length is still according to the Standard.

No excessive force must be applied to the dipole arms, because they might bend or the soldered connections near the feedpoint may be damaged.

Additional EUT Data

Manufactured by	SPEAG
-----------------	-------

Extended Calibration

Usage of SAR dipoles calibrated less than 3 years ago but more than 1 year ago were confirmed in maintaining return loss (<-20 dB, within 20% of prior calibration) and impedance (within 5 ohm from prior calibration) requirements per extended calibrations in KDB Publication 865664 D01 v01r04.

D2550V2 SN: 1003 - Head						
Date of Measurement	Return Loss (dB)	$\Delta\%$	Impedance (Ω)	$\Delta\Omega$	Impedance Imaginary (j Ω)	$\Delta\Omega$
6/3/2021	-29.0		49.4		-3.5	
6/4/2022	-28.6	-1.4	48.5	-0.9	-3.8	-0.3
6/6/2023	-27.3	-5.9	47.1	-2.3	-4.1	-0.6

DASY5 Validation Report for Head TSL

Date: 03.06.2021

Test Laboratory: SPEAG, Zurich, Switzerland

DUT: Dipole 2550 MHz; Type: D2550V2; Serial: D2550V2 - SN:1003

Communication System: UID 0 - CW; Frequency: 2550 MHz

Medium parameters used: $f = 2550$ MHz; $\sigma = 1.98$ S/m; $\epsilon_r = 37.3$; $\rho = 1000$ kg/m³

Phantom section: Flat Section

Measurement Standard: DASY5 (IEEE/IEC/ANSI C63.19-2011)

DASY52 Configuration:

- Probe: EX3DV4 - SN7349; ConvF(7.85, 7.85, 7.85) @ 2550 MHz; Calibrated: 28.12.2020
- Sensor-Surface: 1.4mm (Mechanical Surface Detection)
- Electronics: DAE4 Sn601; Calibrated: 02.11.2020
- Phantom: Flat Phantom 5.0 (front); Type: QD 000 P50 AA; Serial: 1001
- DASY52 52.10.4(1527); SEMCAD X 14.6.14(7483)

Dipole Calibration for Head Tissue/Pin=250 mW, d=10mm/Zoom Scan (7x7x7)/Cube 0:

Measurement grid: dx=5mm, dy=5mm, dz=5mm

Reference Value = 117.6 V/m; Power Drift = 0.07 dB

Peak SAR (extrapolated) = 29.9 W/kg

SAR(1 g) = 14.2 W/kg; SAR(10 g) = 6.28 W/kg

Smallest distance from peaks to all points 3 dB below = 8.5 mm

Ratio of SAR at M2 to SAR at M1 = 47.1%

Maximum value of SAR (measured) = 24.3 W/kg

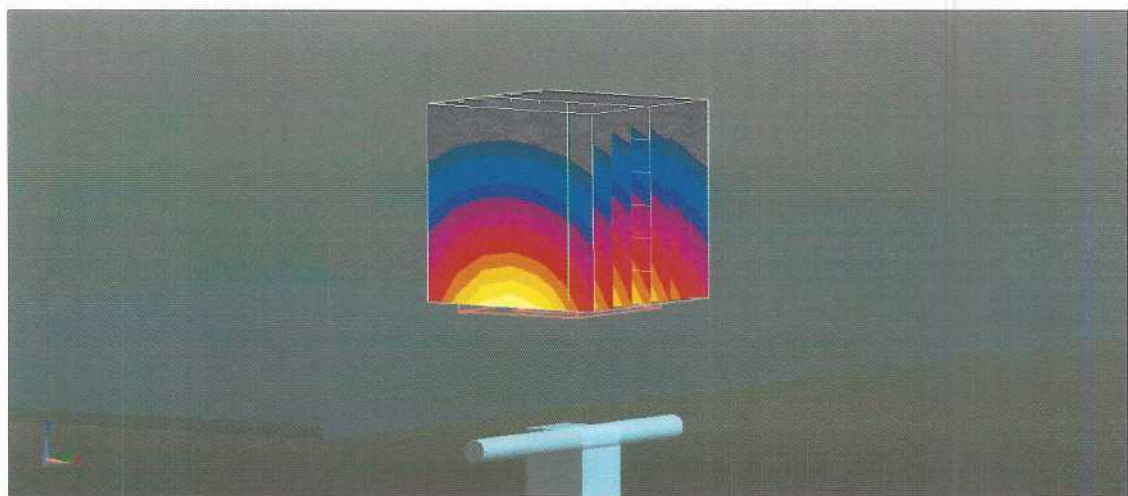
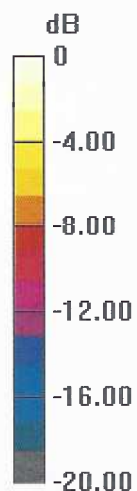

0 dB = 24.3 W/kg = 13.86 dBW/kg

Impedance Measurement Plot for Head TSL

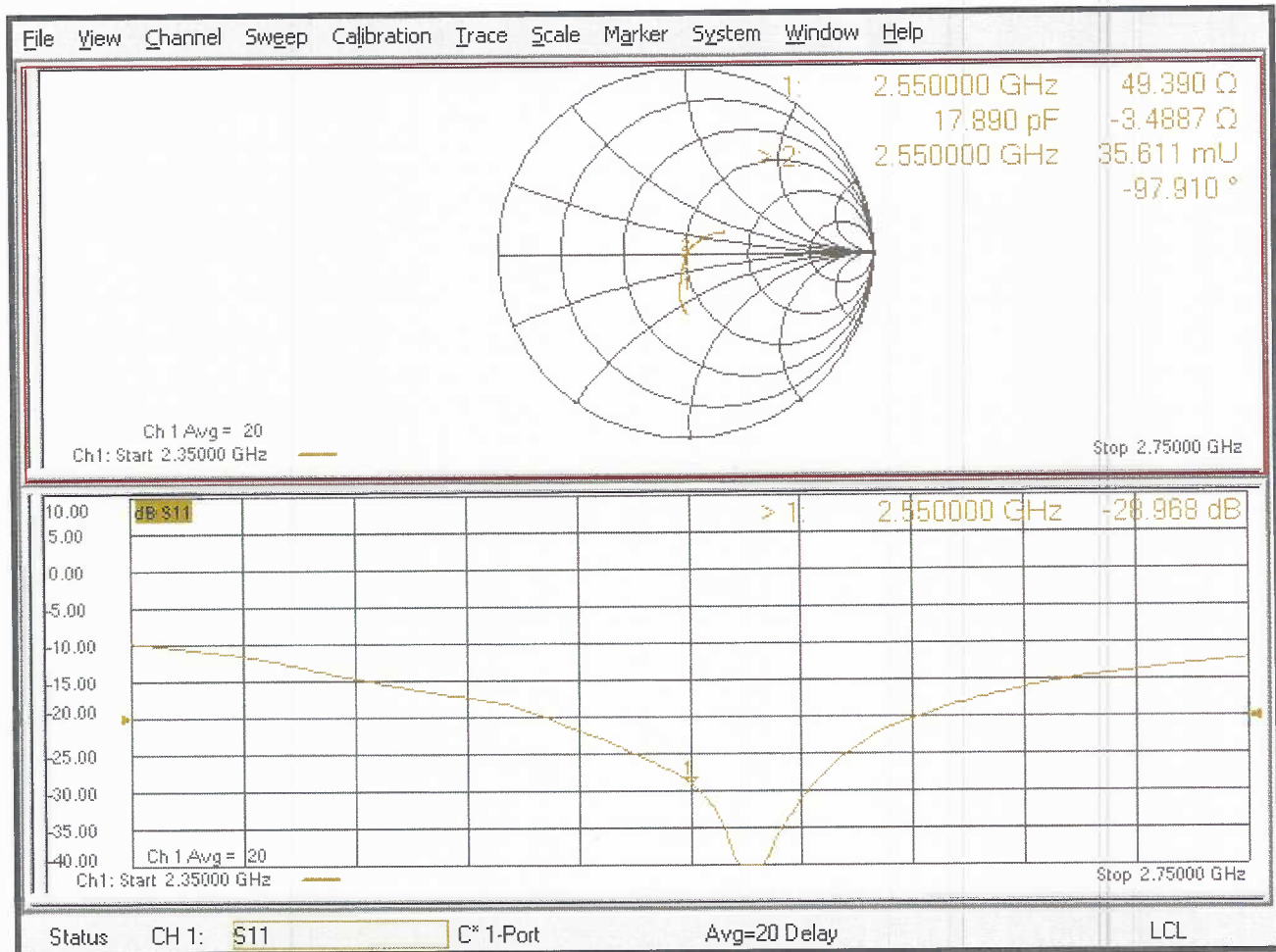

Appendix F – DAE Calibration Data Sheets



Accredited by the Swiss Accreditation Service (SAS)
The Swiss Accreditation Service is one of the signatories to the EA
Multilateral Agreement for the recognition of calibration certificates

Accreditation No.: **SCS 0108**

Client **RF Exposure Lab**
San Marcos, USA

Certificate No: **DAE4-1416_Apr23**

CALIBRATION CERTIFICATE

Object **DAE4 - SD 000 D04 BM - SN: 1416**

Calibration procedure(s) **QA CAL-06.v30**
Calibration procedure for the data acquisition electronics (DAE)

Calibration date: **April 19, 2023**

This calibration certificate documents the traceability to national standards, which realize the physical units of measurements (SI).
The measurements and the uncertainties with confidence probability are given on the following pages and are part of the certificate.

All calibrations have been conducted in the closed laboratory facility: environment temperature (22 ± 3)°C and humidity < 70%.

Calibration Equipment used (M&TE critical for calibration)

Primary Standards	ID #	Cal Date (Certificate No.)	Scheduled Calibration
Keithley Multimeter Type 2001	SN: 0810278	29-Aug-22 (No:34389)	Aug-23
Secondary Standards	ID #	Check Date (in house)	Scheduled Check
Auto DAE Calibration Unit	SE UWS 053 AA 1001	27-Jan-23 (in house check)	In house check: Jan-24
Calibrator Box V2.1	SE UMS 006 AA 1002	27-Jan-23 (in house check)	In house check: Jan-24

Calibrated by: **Adrian Gehring** **Adrian Gehring** **Adrian Gehring**
Name Function Signature
Laboratory Technician

Approved by: **Sven Kühn** **Sven Kühn** **Sven Kühn**
Technical Manager

Issued: April 19, 2023

This calibration certificate shall not be reproduced except in full without written approval of the laboratory.



Accredited by the Swiss Accreditation Service (SAS)

The Swiss Accreditation Service is one of the signatories to the EA
Multilateral Agreement for the recognition of calibration certificates

Glossary

DAE	data acquisition electronics
Connector angle	information used in DASY system to align probe sensor X to the robot coordinate system.

Methods Applied and Interpretation of Parameters

- *DC Voltage Measurement:* Calibration Factor assessed for use in DASY system by comparison with a calibrated instrument traceable to national standards. The figure given corresponds to the full scale range of the voltmeter in the respective range.
- *Connector angle:* The angle of the connector is assessed measuring the angle mechanically by a tool inserted. Uncertainty is not required.
- The following parameters as documented in the Appendix contain technical information as a result from the performance test and require no uncertainty.
 - *DC Voltage Measurement Linearity:* Verification of the Linearity at +10% and -10% of the nominal calibration voltage. Influence of offset voltage is included in this measurement.
 - *Common mode sensitivity:* Influence of a positive or negative common mode voltage on the differential measurement.
 - *Channel separation:* Influence of a voltage on the neighbor channels not subject to an input voltage.
 - *AD Converter Values with inputs shorted:* Values on the internal AD converter corresponding to zero input voltage
 - *Input Offset Measurement:* Output voltage and statistical results over a large number of zero voltage measurements.
 - *Input Offset Current:* Typical value for information; Maximum channel input offset current, not considering the input resistance.
 - *Input resistance:* Typical value for information: DAE input resistance at the connector, during internal auto-zeroing and during measurement.
 - *Low Battery Alarm Voltage:* Typical value for information. Below this voltage, a battery alarm signal is generated.
 - *Power consumption:* Typical value for information. Supply currents in various operating modes.

DC Voltage Measurement

A/D - Converter Resolution nominal

High Range: 1LSB = 6.1 μ V, full range = -100...+300 mV

Low Range: 1LSB = 61nV, full range = -1.....+3mV

DASY measurement parameters: Auto Zero Time: 3 sec; Measuring time: 3 sec

Calibration Factors	X	Y	Z
High Range	403.576 \pm 0.02% (k=2)	403.882 \pm 0.02% (k=2)	404.149 \pm 0.02% (k=2)
Low Range	3.97826 \pm 1.50% (k=2)	3.99531 \pm 1.50% (k=2)	3.97142 \pm 1.50% (k=2)

Connector Angle

Connector Angle to be used in DASY system	181.0 $^{\circ}$ \pm 1 $^{\circ}$
---	-------------------------------------

Appendix (Additional assessments outside the scope of SCS0108)

1. DC Voltage Linearity

High Range	Reading (μV)	Difference (μV)	Error (%)
Channel X + Input	199994.69	-0.41	-0.00
Channel X + Input	20001.60	-1.04	-0.01
Channel X - Input	-20000.15	1.22	-0.01
Channel Y + Input	199996.57	1.52	0.00
Channel Y + Input	20000.09	-2.36	-0.01
Channel Y - Input	-20003.05	-1.65	0.01
Channel Z + Input	199995.51	0.44	0.00
Channel Z + Input	19999.49	-2.93	-0.01
Channel Z - Input	-20003.45	-2.02	0.01

Low Range	Reading (μV)	Difference (μV)	Error (%)
Channel X + Input	2001.59	-0.18	-0.01
Channel X + Input	202.16	0.15	0.07
Channel X - Input	-197.31	0.40	-0.20
Channel Y + Input	2001.43	-0.20	-0.01
Channel Y + Input	201.00	-0.84	-0.42
Channel Y - Input	-198.62	-0.66	0.33
Channel Z + Input	2001.53	-0.06	-0.00
Channel Z + Input	200.32	-1.54	-0.76
Channel Z - Input	-199.56	-1.57	0.79

2. Common mode sensitivity

DASY measurement parameters: Auto Zero Time: 3 sec; Measuring time: 3 sec

	Common mode Input Voltage (mV)	High Range Average Reading (μV)	Low Range Average Reading (μV)
Channel X	200	-3.92	-4.61
	- 200	7.37	4.65
Channel Y	200	-5.88	-7.43
	- 200	6.96	5.86
Channel Z	200	-23.77	-23.62
	- 200	21.74	21.52

3. Channel separation

DASY measurement parameters: Auto Zero Time: 3 sec; Measuring time: 3 sec

	Input Voltage (mV)	Channel X (μV)	Channel Y (μV)	Channel Z (μV)
Channel X	200	-	2.98	-4.77
Channel Y	200	7.89	-	2.79
Channel Z	200	9.17	6.36	-

4. AD-Converter Values with inputs shorted

DASY measurement parameters: Auto Zero Time: 3 sec; Measuring time: 3 sec

	High Range (LSB)	Low Range (LSB)
Channel X	15996	17581
Channel Y	16150	16491
Channel Z	16130	15361

5. Input Offset Measurement

DASY measurement parameters: Auto Zero Time: 3 sec; Measuring time: 3 sec

Input 10M Ω

	Average (μ V)	min. Offset (μ V)	max. Offset (μ V)	Std. Deviation (μ V)
Channel X	0.78	-0.03	1.52	0.32
Channel Y	-0.79	-1.76	0.77	0.41
Channel Z	-0.57	-1.39	0.58	0.37

6. Input Offset Current

Nominal Input circuitry offset current on all channels: <25fA

7. Input Resistance (Typical values for information)

	Zeroing (kOhm)	Measuring (MOhm)
Channel X	200	200
Channel Y	200	200
Channel Z	200	200

8. Low Battery Alarm Voltage (Typical values for information)

Typical values	Alarm Level (VDC)
Supply (+ Vcc)	+7.9
Supply (- Vcc)	-7.6

9. Power Consumption (Typical values for information)

Typical values	Switched off (mA)	Stand by (mA)	Transmitting (mA)
Supply (+ Vcc)	+0.01	+6	+14
Supply (- Vcc)	-0.01	-8	-9

Appendix G – Phantom Calibration Data Sheets

Certificate of Conformity / First Article Inspection

Item	Oval Flat Phantom ELI 4.0
Type No	QD OVA 001 B
Series No	1003 and higher
Manufacturer	Untersee Composites Knebelstrasse 8 CH-8268 Mannenbach, Switzerland

Tests

Complete tests were made on the prototype units QD OVA 001 AA 1001, QD OVA 001 AB 1002, pre-series units QD OVA 001 BA 1003-1005 as well as on the series units QD OVA 001 BB, 1006 ff.

Test	Requirement	Details	Units tested
Material thickness	Compliant with the standard requirements	Bottom plate: 2.0mm +/- 0.2mm	all
Material parameters	Dielectric parameters for required frequencies	< 6 GHz: Rel. permittivity = 4 +/-1, Loss tangent ≤ 0.05	Material sample
Material resistivity	The material has been tested to be compatible with the liquids defined in the standards if handled and cleaned according to the instructions.	DGBE based simulating liquids. Observe Technical Note for material compatibility.	Equivalent phantoms, Material sample
Shape	Thickness of bottom material, Internal dimensions, Sagging compatible with standards from minimum frequency	Bottom elliptical 600 x 400 mm Depth 190 mm, Shape is within tolerance for filling height up to 155 mm, Eventual sagging is reduced or eliminated by support via DUT	Prototypes, Sample testing

Standards

- [1] CENELEC EN 50361-2001, « Basic standard for the measurement of the Specific Absorption Rate related to human exposure to electromagnetic fields from mobile phones (300 MHz – 3 GHz) », July 2001
- [2] IEEE 1528-2003, "Recommended Practice for Determining the Peak Spatial-Average Specific Absorption Rate (SAR) in the Human Head from Wireless Communications Devices: Measurement Techniques, December 2003
- [3] IEC 62209 – 1, "Specific Absorption Rate (SAR) in the frequency range of 300 MHz to 3 GHz – Measurement Procedure, Part 1: Hand-held mobile wireless communication devices", February 2005
- [4] IEC 62209 – 2, Draft, "Human Exposure to Radio Frequency Fields from Handheld and Body-Mounted Wireless Communication Devices – Human models, Instrumentation and Procedures – Part 2: Procedure to determine the Specific Absorption Rate (SAR) in the head and body for 30 MHz to 6 GHz Handheld and Body-Mounted Devices used in close proximity to the Body.", February 2005
- [5] OET Bulletin 65, Supplement C, "Evaluating Compliance with FCC Guidelines for Human Exposure to Radiofrequency Electromagnetic Fields", Edition January 2001

Based on the tests above, we certify that this item is in compliance with the standards [1] to [5] if operated according to the specific requirements and considering the thickness. The dimensions are fully compliant with [4] from 30 MHz to 6 GHz. For the other standards, the minimum lower frequency limit is limited due to the dimensional requirements ([1]: 450 MHz, [2]: 300 MHz, [3]: 800 MHz, [5]: 375 MHz) and possibly further by the dimensions of the DUT.

Date 28.4.2008 Signature / Stamp

s p e a g
Schmid & Partner Engineering AG
Zeughausstrasse 43, 8004 Zurich, Switzerland
Phone +41 44 245 9700, Fax +41 44 245 9779
info@speag.com; http://www.speag.com

Appendix H – Validation Summary

Per FCC KDB 865664 D02 v01r02, SAR system validation status should be documented to confirm measurement accuracy. The SAR systems (including SAR probes, system components and software versions) used for this device were validated against its performance specifications prior to the SAR measurements. Reference dipoles were used with the required tissue equivalent media for system validation according to the procedures outlined in FCC KDB 865664 D01 v01r04 and IEEE 1528-2013. Since SAR probe calibrations are frequency dependent, each probe calibration point was validated at a frequency within the valid frequency range of the probe calibration point using the system that normally operates with the probe for routine SAR measurements and according to the required tissue equivalent media.

A tabulated summary of the system validation status including the validation date(s), measurement frequencies, SAR probes and tissue dielectric parameters has been included.

**Table H-1
SAR System Validation Summary**

SAR System #	Freq. (MHz)	Date	Probe S/N	Probe Type	Probe Cal. Point	Cond. (σ)	Perm. (ϵ_r)	CW Validation			Modulation Validation			
								Sensitivity	Probe Linearity	Probe Isotropy	Modulation Type	Duty Factor	PAR	
2	750	1/30/2023	7530	EX3DV4	750	Head	0.91	40.99	Pass	Pass	Pass	QPSK	Pass	Pass
2	900	1/30/2023	7530	EX3DV4	835	Head	1.00	40.61	Pass	Pass	Pass	WCDMA	Pass	Pass
2	900	1/30/2023	7530	EX3DV4	835	Head	1.00	40.61	Pass	Pass	Pass	QPSK	Pass	Pass
2	900	1/30/2023	7530	EX3DV4	900	Head	1.00	40.61	Pass	Pass	Pass	FM	Pass	Pass
2	1750	1/30/2023	7530	EX3DV4	1750	Head	1.42	39.26	Pass	Pass	Pass	WCDMA	Pass	Pass
2	1750	1/30/2023	7530	EX3DV4	1750	Head	1.42	39.26	Pass	Pass	Pass	QPSK	Pass	Pass
2	1900	1/31/2023	7530	EX3DV4	1900	Head	1.49	38.75	Pass	Pass	Pass	WCDMA	Pass	Pass
2	1900	1/31/2023	7530	EX3DV4	1900	Head	1.49	38.75	Pass	Pass	Pass	QPSK	Pass	Pass
2	2550	1/31/2023	7530	EX3DV4	2600	Head	1.95	38.26	Pass	Pass	Pass	QPSK	Pass	Pass