

RF Exposure Lab

802 N. Twin Oaks Valley Road, Suite 105 • San Marcos, CA 92069 • U.S.A.

TEL (760) 471-2100 • FAX (760) 471-2121

<http://www.rfexposurelab.com>

CERTIFICATE OF COMPLIANCE SAR EVALUATION

Juniper Systems
1132 West 1700 North
Logan, UT 84321

Dates of Test: December 17-31, 2015 & November 30, 2016
Test Report Number:

SAR.20151211
Revision I

FCC ID:	VSF25271, VSFMS2, VSF26593
IC Certificate:	7980A-25271, 7980A-MS2, 7980A-26593
Model(s):	MS2GCR
Test Sample:	Engineering Unit Same as Production
Serial Number:	MS2P41
Equipment Type:	Wireless Rugged Tablet
Classification:	Portable Transmitter Next to Body
TX Frequency Range:	704 – 716 MHz, 777 – 787 MHz, 817 – 849 MHz; 1710 – 1755 MHz, 1850 – 1910 MHz, 2412 – 2462 MHz, 5150 – 5350 MHz, 5500 – 5700 MHz; 5745 – 5825 MHz, 917.4 – 927.2 MHz
Frequency Tolerance:	± 2.5 ppm
Maximum RF Output:	750 MHz (LTE) – 23.0 dBm, 850 MHz (CDMA) – 24.0 dBm, 850 MHz (GSM) – 33.0 dBm, 850 MHz (WCDMA) – 23.0 dBm, 850 MHz (LTE) – 23.0 dBm, 1735 MHz (WCDMA) – 19.0 dBm, 1735 MHz (LTE) – 19.0 dBm, 1900 MHz (CDMA) – 19.0 dBm, 1900 MHz (GSM) – 28.0 dBm, 1900 MHz (WCDMA) – 19.0 dBm, 1900 MHz (LTE) – 19.0 dBm, 2450 MHz (b) – 18.0 dBm, 2450 MHz (g) – 17.00 dBm, 2450 MHz (n20) – 16.0 dBm, 2450 MHz (n40) – 16.0 dBm, 5250 MHz (a) – 16.0 dBm, 5250 MHz (n20) – 14.0 dBm, 5250 MHz (n40) – 14.0 dBm, 5600 MHz (a) – 16.0 dBm, 5600 (n20) – 14.0 dBm, 5600 (n40) – 14.0 dBm, 5800 MHz (a) – 16.0 dBm, 5800 MHz (n20) – 14.0 dBm, 5800 MHz (n40) – 14.0 dBm, 900 MHz – 30 dBm Conducted
Signal Modulation:	WCDMA, GMSK, 8-PSK, CDMA, QPSK, 16QAM, DSSS, OFDM, FHSS
Antenna Type:	Internal
Application Type:	Certification
FCC Rule Parts:	Part 2, 15C, 15E, 22, 24, 27
KDB Test Methodology:	KDB 447498 D01 v06, KDB 248227 v02r02, KDB 616217 D04 v01r02, KDB 941225 D01 v03r01 & D05 v02r05
Industry Canada:	RSS-102 Issue 5, Safety Code 6
Max. Stand Alone SAR Value:	1.32 W/kg Reported (Body); 3.98 W/kg Reported (Extremity)
Max. Simultaneous SAR Value:	1.57 W/kg Reported & 0.04 Separation Ratio (Body); 0.09 Separation Ratio (Extremity)
Separation Distance:	0 mm

This wireless mobile and/or portable device has been shown to be compliant for localized specific absorption rate (SAR) for uncontrolled environment/general exposure limits specified in ANSI/IEEE Std. C95.1-1992 and had been tested in accordance with the measurement procedures specified in IEEE 1528-2013 and IEC 62209-2:2010 (See test report).

I attest to the accuracy of the data. All measurements were performed by myself or were made under my supervision and are correct to the best of my knowledge and belief. I assume full responsibility for the completeness of these measurements and vouch for the qualifications of all persons taking them.

RF Exposure Lab, LLC certifies that no party to this application is subject to a denial of Federal benefits that includes FCC benefits pursuant to Section 5301 of the Anti-Drug Abuse Act of 1988, 21 U.S.C. 853(a).



Jay M. Moulton
Vice President



Certificate # 2387.01

Table of Contents

1.	Introduction.....	3
	SAR Definition [5].....	4
2.	SAR Measurement Setup.....	5
	Robotic System.....	5
	System Hardware.....	5
	System Electronics.....	6
	Probe Measurement System.....	6
3.	Probe and Dipole Calibration.....	13
4.	Phantom & Simulating Tissue Specifications.....	14
	Head & Body Simulating Mixture Characterization.....	14
5.	ANSI/IEEE C95.1 – 1992 RF Exposure Limits [2].....	15
	Uncontrolled Environment.....	15
	Controlled Environment.....	15
6.	Measurement Uncertainty.....	16
7.	System Validation.....	17
	Tissue Verification.....	17
	Test System Verification.....	17
8.	LTE Document Checklist.....	19
9.	SAR Test Data Summary.....	23
	Procedures Used To Establish Test Signal.....	23
	Device Test Condition.....	23
	Figure 9.1.....	25
10.	FCC 3G Measurement Procedures.....	26
	10.1 Procedures Used to Establish RF Signal for SAR.....	26
	10.2 SAR Measurement Conditions for CDMA2000, 1xEV-DO.....	26
	10.3 SAR Measurement Conditions for WCDMA/HSDPA/HSUPA.....	28
	10.4 SAR Measurement Conditions for GSM.....	30
	10.5 SAR Measurement Conditions for LTE Bands.....	49
	SAR Data Summary – 750 MHz Body – LTE Band 17.....	68
	SAR Data Summary – 750 MHz Body – LTE Band 13.....	69
	SAR Data Summary – 835 MHz Body - CDMA.....	70
	SAR Data Summary – 835 MHz Body - GPRS.....	71
	SAR Data Summary – 835 MHz Body - WCDMA.....	72
	SAR Data Summary – 835 MHz Body – LTE Band 5.....	73
	SAR Data Summary – 1750 MHz Body - WCDMA.....	74
	SAR Data Summary – 1750 MHz Body – LTE Band 4.....	75
	SAR Data Summary – 1900 MHz Body - CDMA.....	76
	SAR Data Summary – 1900 MHz Body - GPRS.....	77
	SAR Data Summary – 1900 MHz Body - WCDMA.....	78
	SAR Data Summary – 1900 MHz Body – LTE Band 2.....	79
	SAR Data Summary – 2450 MHz Body 802.11b and Bluetooth.....	80
	SAR Data Summary – 5250 MHz Body 802.11a.....	81
	SAR Data Summary – 5600 MHz Body 802.11a.....	82
	SAR Data Summary – 5800 MHz Body 802.11a.....	83
	SAR Data Summary – 900 MHz Extremity RFID – MS2 Micro.....	84
	SAR Data Summary – Simultaneous Transmit (WWAN-WLAN Main).....	85
	SAR Data Summary – Simultaneous Transmit (WWAN-WLAN Aux).....	85
	SAR Data Summary – Simultaneous Transmit (RFID) – MS2 Micro.....	86
11.	Test Equipment List.....	87
12.	Conclusion.....	88
13.	References.....	89
	Appendix A – System Validation Plots and Data.....	90
	Appendix B – SAR Test Data Plots.....	115
	Appendix C – SAR Test Setup Photos.....	133
	Appendix D – Probe Calibration Data Sheets.....	140
	Appendix E – Dipole Calibration Data Sheets.....	185
	Appendix F – Phantom Calibration Data Sheets.....	250

1. Introduction

This measurement report shows compliance of the Juniper Systems Model MS2GCR FCC ID: VSF25271, VSFMS2, VSF26593 with FCC Part 2, 1093, ET Docket 93-62 Rules for mobile and portable devices and IC Certificate: 7980A-25271, 7980A-MS2, 7980A-26593 with RSS102 Issue 5 & Safety Code 6. The FCC has adopted the guidelines for evaluating the environmental effects of radio frequency radiation in ET Docket 93-62 on August 6, 1996 to protect the public and workers from the potential hazards of RF emissions due to FCC regulated portable devices. [1], [6]

The test results recorded herein are based on a single type test of Juniper Systems Model MS2GCR and therefore apply only to the tested sample.

The test procedures, as described in ANSI C95.1 – 1999 Standard for Safety Levels with Respect to Human Exposure to Radio Frequency Electromagnetic Fields, 3 kHz to 300 GHz [2], ANSI C95.3 – 2002 Recommended Practice for the Measurement of Potentially Hazardous Electromagnetic Fields [3], IEEE Std.1528 – 2013 Recommended Practice [4], and Industry Canada Safety Code 6 Limits of Human Exposure to Radiofrequency Electromagnetic Fields in the Frequency Range from 3kHz to 300 GHz were employed.

The following table indicates all the wireless technologies operating in the MS2GCR Wireless Rugged Tablet. The table also shows the tolerance for the power level for each mode.

Band	Technology	Class	3GPP Nominal Power dBm	Calibrated Nominal Power dBm	Tolerance dBm	Lower Tolerance dBm	Upper Tolerance dBm
Band 17 – 750 MHz	LTE	3	22.0	22.0	±1.0	21.0	23.0
Band 13 – 750 MHz	LTE	3	22.0	22.0	±1.0	21.0	23.0
Band 5 – 835 MHz	CDMA	3	23.0	23.0	±1.0	22.0	24.0
Band 5 – 850 MHz	GPRS	4	32.0	32.0	±1.0	31.0	33.0
Band 5 – 850 MHz	EDGE	E2	26.0	26.0	±1.0	25.0	27.0
Band 5 – 850 MHz	WCDMA/HSPA	3	22.0	22.0	±1.0	21.0	23.0
Band 5 – 835 MHz	LTE	3	22.0	22.0	±1.0	21.0	23.0
Band 4 – 1750 MHz	WCDMA/HSPA	3	18.0	18.0	±1.0	17.0	19.0
Band 4 – 1750 MHz	LTE	3	18.0	18.0	±1.0	17.0	19.0
Band 2 – 1900 MHz	CDMA	3	18.0	18.0	±1.0	17.0	19.0
Band 2 – 1900 MHz	GPRS	1	27.0	27.0	±1.0	26.0	28.0
Band 2 – 1900 MHz	EDGE	E2	25.0	25.0	±1.0	24.0	26.0
Band 2 – 1900 MHz	WCDMA/HSPA	3	18.0	18.0	±1.0	17.0	19.0
Band 2 – 1900 MHz	LTE	3	18.0	18.0	±1.0	17.0	19.0
WLAN – 2.4 GHz	802.11b	N/A	N/A	16	±2.0	16.0	18.0
WLAN – 2.4 GHz	802.11g	N/A	N/A	15	±2.0	13.0	17.0
WLAN – 2.4 GHz	802.11n	N/A	N/A	14	±2.0	12.0	16.0
WLAN – 5.0 GHz	802.11a	N/A	N/A	14	±2.0	12.0	16.0
WLAN – 5.0 GHz	802.11n	N/A	N/A	12	±2.0	10.0	14.0
Bluetooth	802.15.1	N/A	N/A	N/A	N/A	N/A	8.5
RFID – MS2 Micro	FHSS	N/A	N/A	N/A	N/A	N/A	30.0

SAR Definition [5]

Specific Absorption Rate is defined as the time derivative (rate) of the incremental energy (dW) absorbed by (dissipated in) an incremental mass (dm) contained in a volume element (dV) of a given density (ρ).

$$SAR = \frac{d}{dt} \left(\frac{dW}{dm} \right) = \frac{d}{dt} \left(\frac{dW}{\rho dV} \right)$$

SAR is expressed in units of watts per kilogram (W/kg). SAR can be related to the electric field at a point by

$$SAR = \frac{\sigma |E|^2}{\rho}$$

where:

σ = conductivity of the tissue (S/m)

ρ = mass density of the tissue (kg/m³)

E = rms electric field strength (V/m)

2. SAR Measurement Setup

Robotic System

These measurements are performed using the DASY52 automated dosimetric assessment system. The DASY52 is made by Schmid & Partner Engineering AG (SPEAG) in Zurich, Switzerland and consists of high precision robotics system (Staubli), robot controller, Intel Core2 computer, near-field probe, probe alignment sensor, and the generic twin phantom containing the brain equivalent material. The robot is a six-axis industrial robot performing precise movements to position the probe to the location (points) of maximum electromagnetic field (EMF) (see Fig. 2.1).

System Hardware

A cell controller system contains the power supply, robot controller teach pendant (Joystick), and a remote control used to drive the robot motors. The PC consists of the HP Intel Core2 computer with Windows XP system and SAR Measurement Software DASY52, A/D interface card, monitor, mouse, and keyboard. The Staubli Robot is connected to the cell controller to allow software manipulation of the robot. A data acquisition electronic (DAE) circuit that performs the signal amplification, signal multiplexing, AD-conversion, offset measurements, mechanical surface detection, collision detection, etc. is connected to the Electro-optical coupler (EOC). The EOC performs the conversion from the optical into digital electric signal of the DAE and transfers data to the PC plug-in card.

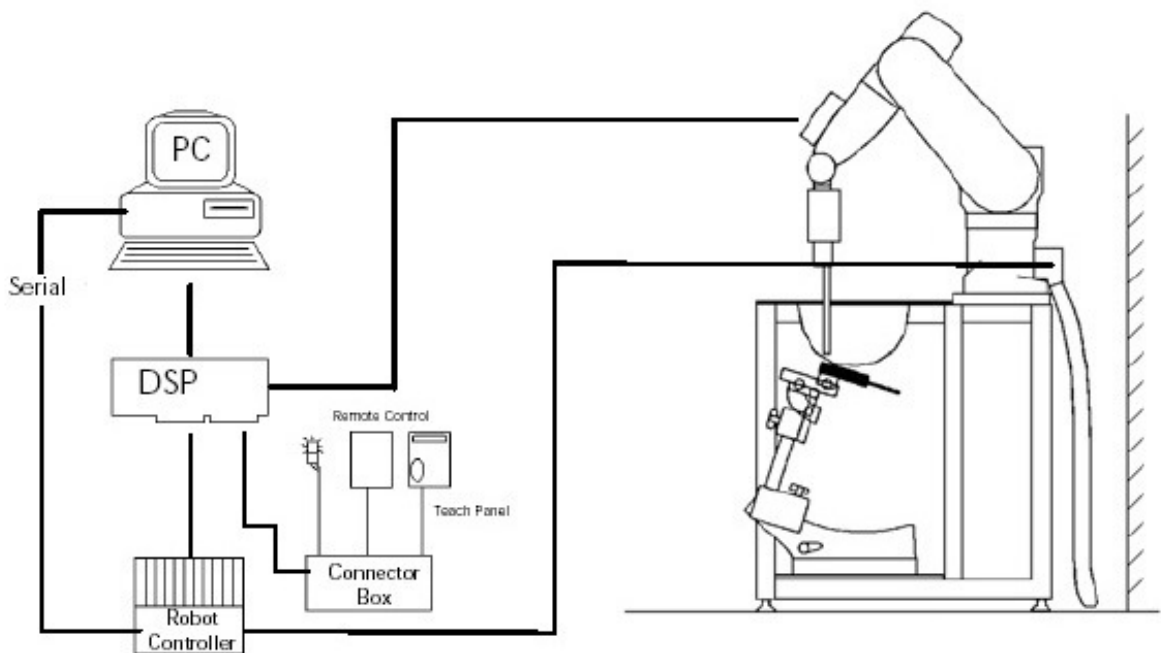

Figure 2.1 SAR Measurement System Setup

System Electronics

The DAE4 consists of a highly sensitive electrometer-grade preamplifier with auto-zeroing, a channel and gain-switching multiplexer, a fast 16 bit AD-converter and a command decoder and control logic unit. Transmission to the PC-card is accomplished through an optical downlink for data and status information and an optical uplink for commands and clock lines. The mechanical probe mounting device includes two different sensor systems for frontal and sidewise probe contacts. They are also used for mechanical surface detection and probe collision detection. The robot uses its own controller with a built in VME-bus computer. The system is described in detail in.

Probe Measurement System

The SAR measurements were conducted with the dosimetric probe EX3DV4, designed in the classical triangular configuration (see Fig. 2.2) and optimized for dosimetric evaluation. The probe is constructed using the thick film technique; with printed resistive lines on ceramic substrates. The probe is equipped with an optical multi fiber line ending at the front of the probe tip. (see Fig. 2.3) It is connected to the EOC box on the robot arm and provides an automatic detection of the phantom surface. Half of the fibers are connected to a pulsed infrared transmitter, the other half to a synchronized receiver. As the probe approaches the surface, the reflection from the surface produces a coupling from the transmitting to the receiving fibers. This reflection increases first during the approach, reaches maximum and then decreases. If the probe is flatly touching the surface, the coupling is zero. The distance of the coupling maximum to the surface is independent of the surface reflectivity and largely independent of the surface to probe angle. The DASY52 software reads the reflection during a software approach and looks for the maximum using a 2nd order fitting. The approach is stopped at reaching the maximum.



DAE System

Probe Specifications

Calibration: In air from 10 MHz to 6.0 GHz
In brain and muscle simulating tissue at Frequencies of 450 MHz, 835 MHz, 1750 MHz, 1900 MHz, 2450 MHz, 2600 MHz, 3500 MHz, 5200 MHz, 5300 MHz, 5600 MHz, 5800 MHz

Frequency: 10 MHz to 6 GHz

Linearity: ± 0.2 dB (30 MHz to 6 GHz)

Dynamic: 10 mW/kg to 100 W/kg

Range: Linearity: ± 0.2 dB

Dimensions: Overall length: 330 mm

Tip length: 20 mm

Body diameter: 12 mm

Tip diameter: 2.5 mm

Distance from probe tip to sensor center: 1 mm

Application: SAR Dosimetry Testing
Compliance tests of wireless device

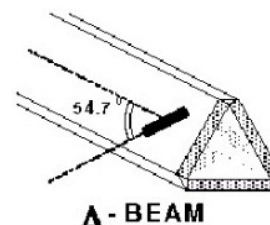

Figure 2.2 Triangular Probe Configurations



Figure 2.3 Probe Thick-Film Technique

Probe Calibration Process

Dosimetric Assessment Procedure

Each probe is calibrated according to a dosimetric assessment procedure described in with accuracy better than +/- 10%. The spherical isotropy was evaluated with the procedure described in and found to be better than +/-0.25dB. The sensitivity parameters (Norm X, Norm Y, Norm Z), the diode compression parameter (DCP) and the conversion factor (Conv F) of the probe is tested.

Free Space Assessment

The free space E-field from amplified probe outputs is determined in a test chamber. This is performed in a TEM cell for frequencies below 1 GHz, and in a waveguide above 1GHz for free space. For the free space calibration, the probe is placed in the volumetric center of the cavity at the proper orientation with the field. The probe is then rotated 360 degrees until the three channels show the maximum reading. The power density readings equates to 1 mW/cm².

Temperature Assessment *

E-field temperature correlation calibration is performed in a flat phantom filled with the appropriate simulated brain tissue. The measured free space E-field in the medium, correlates to temperature rise in a dielectric medium. For temperature correlation calibration a RF transparent thermistor based temperature probe is used in conjunction with the E-field probe

$$SAR = C \frac{\Delta T}{\Delta t}$$

$$SAR = \frac{|E|^2 \cdot \sigma}{\rho}$$

where:

where:

Δt = exposure time (30 seconds),

σ = simulated tissue conductivity,

C = heat capacity of tissue (brain or muscle),

ρ = Tissue density (1.25 g/cm³ for brain tissue)

ΔT = temperature increase due to RF exposure.

SAR is proportional to $\Delta T / \Delta t$, the initial rate of tissue heating, before thermal diffusion takes place.

Now it's possible to quantify the electric field in the simulated tissue by equating the thermally derived SAR to the E- field;

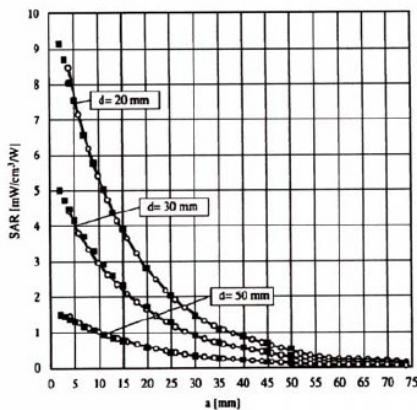

Figure 2.4 E-Field and Temperature Measurements at 900MHz

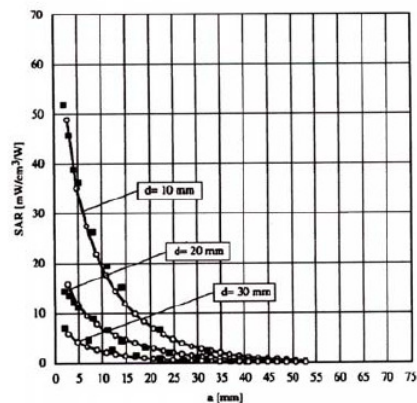

Figure 2.5 E-Field and Temperature Measurements at 1800MHz

Data Extrapolation

The DASY52 software automatically executes the following procedures to calculate the field units from the microvolt readings at the probe connector. The first step of the evaluation is a linearization of the filtered input signal to account for the compression characteristics of the detector diode. The compensation depends on the input signal, the diode type and the DC-transmission factor from the diode to the evaluation electronics. If the exciting field is pulsed, the crest factor of the signal must be known to correctly compensate for peak power. The formula for each channel can be given like below;

$$V_i = U_i + U_i^2 \cdot \frac{cf}{dcp_i}$$

with V_i = compensated signal of channel i (i=x,y,z)
 U_i = input signal of channel i (i=x,y,z)
 cf = crest factor of exciting field (DASY parameter)
 dcp_i = diode compression point (DASY parameter)

From the compensated input signals the primary field data for each channel can be evaluated:

E-field probes:

$$E_i = \sqrt{\frac{V_i}{Norm_i \cdot ConvF}}$$

with V_i = compensated signal of channel i (i = x,y,z)
 $Norm_i$ = sensor sensitivity of channel i (i = x,y,z)
 $\mu V/(V/m)^2$ for E-field probes
 $ConvF$ = sensitivity of enhancement in solution
 E_i = electric field strength of channel i in V/m

The RSS value of the field components gives the total field strength (Hermetian magnitude):

$$E_{tot} = \sqrt{E_x^2 + E_y^2 + E_z^2}$$

The primary field data are used to calculate the derived field units.

$$SAR = E_{tot}^2 \cdot \frac{\sigma}{\rho \cdot 1000}$$

with SAR = local specific absorption rate in W/g
 E_{tot} = total field strength in V/m
 σ = conductivity in [mho/m] or [Siemens/m]
 ρ = equivalent tissue density in g/cm³

The power flow density is calculated assuming the excitation field to be a free space field.

$$P_{pwe} = \frac{E_{tot}^2}{3770}$$

with P_{pwe} = equivalent power density of a plane wave in W/cm²
 E_{tot} = total electric field strength in V/m

Scanning procedure

- The DASY installation includes predefined files with recommended procedures for measurements and system check. They are read-only document files and destined as fully defined but unmeasured masks. All test positions (head or body-worn) are tested with the same configuration of test steps differing only in the grid definition for the different test positions.
- The „reference“ and „drift“ measurements are located at the beginning and end of the batch process. They measure the field drift at one single point in the liquid over the complete procedure. The indicated drift is mainly the variation of the DUT’s output power and should vary max. +/- 5 %.
- The highest integrated SAR value is the main concern in compliance test applications. These values can mostly be found at the inner surface of the phantom and cannot be measured directly due to the sensor offset in the probe. To extrapolate the surface values, the measurement distances to the surface must be known accurately. A distance error of 0.5mm could produce SAR errors of 6% at 1800 MHz. Using predefined locations for measurements is not accurate enough. Any shift of the phantom (e.g., slight deformations after filling it with liquid) would produce high uncertainties. For an automatic and accurate detection of the phantom surface, the DASY5 system uses the mechanical surface detection. The detection is always at touch, but the probe will move backward from the surface the indicated distance before starting the measurement.
- The „area scan“ measures the SAR above the DUT or verification dipole on a parallel plane to the surface. It is used to locate the approximate location of the peak SAR with 2D spline interpolation. The robot performs a stepped movement along one grid axis while the local electrical field strength is measured by the probe. The probe is touching the surface of the SAM during acquisition of measurement values. The scan uses different grid spacings for different frequency measurements. Standard grid spacing for head measurements in frequency ranges ≤ 2GHz is 15 mm in x - and y-dimension. For higher frequencies a finer resolution is needed, thus for the grid spacing is reduced according the following table:

Area scan grid spacing for different frequency ranges	
Frequency range	Grid spacing
≤ 2 GHz	≤ 15 mm
2 – 4 GHz	≤ 12 mm
4 – 6 GHz	≤ 10 mm

Grid spacing and orientation have no influence on the SAR result. For special applications where the standard scan method does not find the peak SAR within the grid, e.g. mobile phones with flip cover, the grid can be adapted in orientation. Results of this coarse scan are shown in annex B.

- A „zoom scan“ measures the field in a volume around the 2D peak SAR value acquired in the previous „coarse“ scan. It uses a fine meshed grid where the robot moves the probe in steps along all the 3 axis (x,y and z-axis) starting at the bottom of the Phantom. The grid spacing for the cube measurement is varied according to the measured frequency range, the dimensions are given in the following table:

Zoom scan grid spacing and volume for different frequency ranges			
Frequency range	Grid spacing for x, y axis	Grid spacing for z axis	Minimum zoom scan volume
≤ 2 GHz	≤ 8 mm	≤ 5 mm	≥ 30 mm
2 – 3 GHz	≤ 5 mm	≤ 5 mm	≥ 28 mm
3 – 4 GHz	≤ 5 mm	≤ 4 mm	≥ 28 mm
4 – 5 GHz	≤ 4 mm	≤ 3 mm	≥ 25 mm
5 – 6 GHz	≤ 4 mm	≤ 2 mm	≥ 22 mm

DASY is also able to perform repeated zoom scans if more than 1 peak is found during area scan. In this document, the evaluated peak 1g and 10g averaged SAR values are shown in the 2D-graphics in annex B. Test results relevant for the specified standard (see section 3) are shown in table form in section 7.

Spatial Peak SAR Evaluation

The spatial peak SAR - value for 1 and 10 g is evaluated after the Cube measurements have been done. The basis of the evaluation are the SAR values measured at the points of the fine cube grid consisting of all points in the three directions x, y and z. The algorithm that finds the maximal averaged volume is separated into three different stages.

- The data between the dipole center of the probe and the surface of the phantom are extrapolated. This data cannot be measured since the center of the dipole is 1 to 2.7 mm away from the tip of the probe and the distance between the surface and the lowest measuring point is about 1 mm (see probe calibration sheet). The extrapolated data from a cube measurement can be visualized by selecting 'Graph Evaluated'.
- The maximum interpolated value is searched with a straight-forward algorithm. Around this maximum the SAR - values averaged over the spatial volumes (1g or 10 g) are computed using the 3d-spline interpolation algorithm. If the volume cannot be evaluated (i.e., if a part of the grid was cut off by the boundary of the measurement area) the evaluation will be started on the corners of the bottom plane of the cube.
- All neighbouring volumes are evaluated until no neighbouring volume with a higher average value is found.

Extrapolation

The extrapolation is based on a least square algorithm [W. Gander, Computermathematik, p.168-180]. Through the points in the first 3 cm along the z-axis, polynomials of order four are calculated. These polynomials are then used to evaluate the points between the surface and the probe tip. The points, calculated from the surface, have a distance of 1 mm from each other.

Interpolation

The interpolation of the points is done with a 3d-Spline. The 3d-Spline is composed of three one-dimensional splines with the "Not a knot"-condition [W. Gander, Computermathematik, p.141-150] (x, y and z -direction) [Numerical Recipes in C, Second Edition, p.123ff].

Volume Averaging

At First the size of the cube is calculated. Then the volume is integrated with the trapezoidal algorithm. 8000 points (20x20x20) are interpolated to calculate the average.

Advanced Extrapolation

DASY uses the advanced extrapolation option which is able to compensate boundary effects on E-field probes.

SAM PHANTOM

The SAM Twin Phantom V4.0 is constructed of a fiberglass shell integrated in a wooden table. The shape of the shell is based on data from an anatomical study designed to determine the maximum exposure in at least 90% of all users. It enables the dosimetric evaluation of left and right hand phone usage as well as body mounted usage at the flat phantom region. A cover prevents the evaporation of the liquid. Reference markings on the Phantom allow the complete setup of all predefined phantom positions and measurement grids by manually teaching three points in the robot. (see Fig. 2.6)

Phantom Specification

Phantom: SAM Twin Phantom (V4.0)
Shell Material: Vivac Composite
Thickness: 2.0 ± 0.2 mm

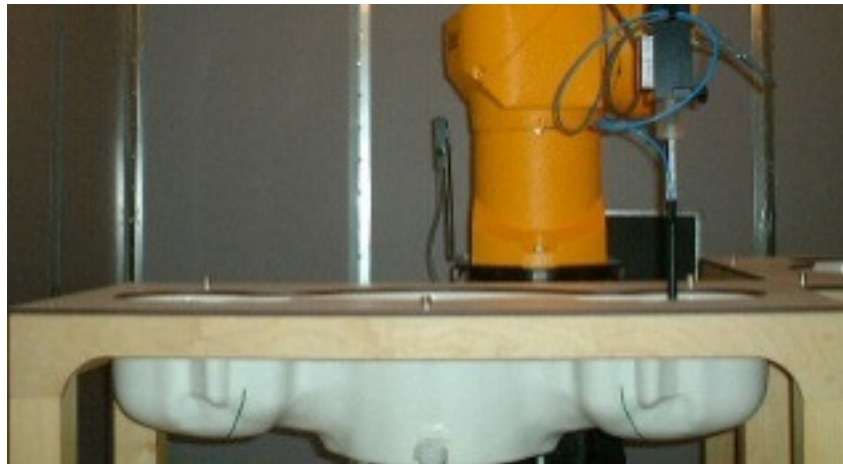

Figure 2.6 SAM Twin Phantom

Device Holder for Transmitters

In combination with the SAM Twin Phantom V4.0 the Mounting Device (see Fig. 2.7), enables the rotation of the mounted transmitter in spherical coordinates whereby the rotation point is the ear opening. The devices can be easily, accurately, and repeatedly positioned according to the FCC, CENELEC, IEC and IEEE specifications. The device holder can be locked at different phantom locations (left head, right head, flat phantom).



Figure 2.7 Mounting Device

Note: A simulating human hand is not used due to the complex anatomical and geometrical structure of the hand that may produce infinite number of configurations. To produce the worst-case condition (the hand absorbs antenna output power), the hand is omitted during the tests.

3. Probe and Dipole Calibration

See Appendix D and E.

4. Phantom & Simulating Tissue Specifications

Head & Body Simulating Mixture Characterization

The head and body mixtures consist of the material based on the table listed below. The mixture is calibrated to obtain proper dielectric constant (permittivity) and conductivity of the desired tissue. Body tissue parameters that have not been specified in IEEE1528 – 2013 are derived from the issue dielectric parameters computed from the 4-Cole-Cole equations.

Table 4.1 Typical Composition of Ingredients for Tissue

Ingredients		Simulating Tissue					
		750 MHz Body	835/900 MHz Body	1750 MHz Body	1900 MHz Body	2450 MHz Body	5 GHz Body
Mixing Percentage							
Water		Proprietary Purchased From Speag	52.50	Proprietary Purchased From Speag	69.91	73.20	Proprietary Purchased From Speag
Sugar			45.00		0.00	0.00	
Salt			1.40		0.13	0.10	
HEC			1.00		0.00	0.00	
Bactericide			0.10		0.00	0.00	
DGBE			0.00		29.96	26.70	
Dielectric Constant	Target	55.53	55.20	53.43	53.30	52.70	Various
Conductivity (S/m)	Target	0.96	0.97	1.49	1.52	1.95	Various

5. ANSI/IEEE C95.1 – 1992 RF Exposure Limits [2]

Uncontrolled Environment

Uncontrolled Environments are defined as locations where there is the exposure of individuals who have no knowledge or control of their exposure. The general population/uncontrolled exposure limits are applicable to situations in which the general public may be exposed or in which persons who are exposed as a consequence of their employment may not be made fully aware of the potential for exposure or cannot exercise control over their exposure. Members of the general public would come under this category when exposure is not employment-related; for example, in the case of a wireless transmitter that exposes persons in its vicinity.

Controlled Environment

Controlled Environments are defined as locations where there is exposure that may be incurred by persons who are aware of the potential for exposure, (i.e. as a result of employment or occupation). In general, occupational/controlled exposure limits are applicable to situations in which persons are exposed as a consequence of their employment, who have been made fully aware of the potential for exposure and can exercise control over their exposure. This exposure category is also applicable when the exposure is of a transient nature due to incidental passage through a location where the exposure levels may be higher than the general population/uncontrolled limits, but the exposed person is fully aware of the potential for exposure and can exercise control over his or her exposure by leaving the area or by some other appropriate means.

Table 5.1 Human Exposure Limits

	UNCONTROLLED ENVIRONMENT General Population (W/kg) or (mW/g)	CONTROLLED ENVIROMENT Professional Population (W/kg) or (mW/g)
SPATIAL PEAK SAR ¹ Head	1.60	8.00
SPATIAL AVERAGE SAR ² Whole Body	0.08	0.40
SPATIAL PEAK SAR ³ Hands, Feet, Ankles, Wrists	4.00	20.00

¹ The Spatial Peak value of the SAR averaged over any 1 gram of tissue (defined as a tissue volume in the shape of a cube) and over the appropriate averaging time.

² The Spatial Average value of the SAR averaged over the whole body.

³ The Spatial Peak value of the SAR averaged over any 10 grams of tissue (defined as a tissue volume in the shape of a cube) and over the appropriate averaging time.

6. Measurement Uncertainty

Exposure Assessment Measurement Uncertainty

Relative DASYS Uncertainty Budget for SAR Tests								
According to IEC62209-2/2010 (30 MHz - 6 GHz range)								
Error Description	Uncertainty Value	Probability Distribution	Divisor	c_i	c_i	Standard Uncertainty		v_i^2 or
				(1g)	(10g)	$\pm \%$, (1g)	$\pm \%$, (10g)	v_{eff}
Measurement System								
Probe calibration	$\pm 6.6\%$	Normal	1	1	1	$\pm 6.6\%$	$\pm 6.6\%$	∞
Axial isotropy	$\pm 4.7\%$	Rectangular	$\sqrt{3}$	0.7	0.7	$\pm 1.9\%$	$\pm 1.9\%$	∞
Hemispherical isotropy	$\pm 9.6\%$	Rectangular	$\sqrt{3}$	0.7	0.7	$\pm 3.9\%$	$\pm 3.9\%$	∞
Boundary effects	$\pm 2.0\%$	Rectangular	$\sqrt{3}$	1	1	$\pm 1.2\%$	$\pm 1.2\%$	∞
Probe linearity	$\pm 4.7\%$	Rectangular	$\sqrt{3}$	1	1	$\pm 2.7\%$	$\pm 2.7\%$	∞
System detection limits	$\pm 1.0\%$	Rectangular	$\sqrt{3}$	1	1	$\pm 0.6\%$	$\pm 0.6\%$	∞
Modulation response	$\pm 2.4\%$	Rectangular	$\sqrt{3}$	1	1	$\pm 1.4\%$	$\pm 1.4\%$	∞
Readout electronics	$\pm 0.3\%$	Normal	1	1	1	$\pm 0.3\%$	$\pm 0.3\%$	∞
Response time	$\pm 0.8\%$	Rectangular	$\sqrt{3}$	1	1	$\pm 0.5\%$	$\pm 0.5\%$	∞
Integration time	$\pm 2.6\%$	Rectangular	$\sqrt{3}$	1	1	$\pm 1.5\%$	$\pm 1.5\%$	∞
RF ambient noise	$\pm 3.0\%$	Rectangular	$\sqrt{3}$	1	1	$\pm 1.7\%$	$\pm 1.7\%$	∞
RF ambient reflections	$\pm 3.0\%$	Rectangular	$\sqrt{3}$	1	1	$\pm 1.7\%$	$\pm 1.7\%$	∞
Probe positioner	$\pm 0.8\%$	Rectangular	$\sqrt{3}$	1	1	$\pm 0.5\%$	$\pm 0.5\%$	∞
Probe positioning	$\pm 6.7\%$	Rectangular	$\sqrt{3}$	1	1	$\pm 3.9\%$	$\pm 3.9\%$	∞
Post-processing	$\pm 4.0\%$	Rectangular	$\sqrt{3}$	1	1	$\pm 2.3\%$	$\pm 2.3\%$	∞
Test Sample Related								
Device positioning	$\pm 2.9\%$	Normal	1	1	1	$\pm 2.9\%$	$\pm 2.9\%$	145
Device holder uncertainty	$\pm 3.6\%$	Normal	1	1	1	$\pm 3.6\%$	$\pm 3.6\%$	5
Power drift	$\pm 5.0\%$	Rectangular	$\sqrt{3}$	1	1	$\pm 2.9\%$	$\pm 2.9\%$	∞
Phantom and Setup								
Phantom uncertainty	$\pm 7.9\%$	Rectangular	$\sqrt{3}$	1	1	$\pm 4.6\%$	$\pm 4.6\%$	∞
SAR algorithm correction	$\pm 1.9\%$	Normal	1	1	0.84	$\pm 1.9\%$	$\pm 1.9\%$	∞
Liquid conductivity (meas.)	$\pm 5.0\%$	Rectangular	$\sqrt{3}$	0.78	0.71	$\pm 0.1\%$	$\pm 0.1\%$	∞
Liquid permittivity (meas.)	$\pm 5.0\%$	Rectangular	$\sqrt{3}$	0.26	0.26	$\pm 0.1\%$	$\pm 0.1\%$	∞
Temp. Unc. – Conductivity	$\pm 3.4\%$	Rectangular	$\sqrt{3}$	0.78	0.71	$\pm 1.5\%$	$\pm 1.5\%$	∞
Temp. Unc. – Permittivity	$\pm 0.4\%$	Rectangular	$\sqrt{3}$	0.23	0.26	$\pm 0.1\%$	$\pm 0.1\%$	∞
Combined Uncertainty						$\pm 12.4\%$	$\pm 12.3\%$	330
Expanded Std. Uncertainty						$\pm 24.8\%$	$\pm 24.6\%$	

Worst case uncertainty budget for DASYS assessed according to IEC62209-2/2010 standard. The budget is valid for the frequency range 30 MHz – 6 GHz and represents a worst-case analysis. For specific tests and configurations, the uncertainty could be considerable smaller.

7. System Validation

Tissue Verification

Table 7.1 Measured Tissue Parameters

		750 MHz Body		835 MHz Body		1750 MHz Body	
Date(s)		Dec. 30, 2015		Dec. 29, 2015		Dec. 28, 2015	
Liquid Temperature (°C)	20.0	Target	Measured	Target	Measured	Target	Measured
Dielectric Constant: ϵ		55.35	54.69	55.20	54.37	53.43	52.68
Conductivity: σ		0.96	0.94	0.97	0.98	1.49	1.56
		1900 MHz Body		2450 MHz Body		5200 MHz Body	
Date(s)		Dec. 21, 2015		Dec. 17, 2015		Dec. 18, 2015	
Liquid Temperature (°C)	20.0	Target	Measured	Target	Measured	Target	Measured
Dielectric Constant: ϵ		53.30	53.17	52.70	52.77	49.01	49.07
Conductivity: σ		1.52	1.54	1.95	1.92	5.30	5.21
		5600 MHz Body		5800 MHz Body		2450 MHz Body	
Date(s)		Dec. 18, 2015		Dec. 18, 2015		Mar. 19, 2016	
Liquid Temperature (°C)	20.0	Target	Measured	Target	Measured	Target	Measured
Dielectric Constant: ϵ		48.47	48.47	48.20	48.17	52.70	52.64
Conductivity: σ		5.77	5.73	6.00	5.99	1.95	1.96
		900 MHz Body					
Date(s)		Nov. 30, 2016					
Liquid Temperature (°C)	20.0	Target	Measured				
Dielectric Constant: ϵ		55.00	54.83				
Conductivity: σ		1.05	1.07				

See Appendix A for data printout.

Test System Verification

Prior to assessment, the system is verified to the $\pm 10\%$ of the specifications at the test frequency by using the system kit. Power is normalized to 1 watt. (Graphic Plots Attached)

Table 7.2 System Dipole Validation Target & Measured

	Test Frequency	Targeted SAR _{1g} (W/kg)	Measure SAR _{1g} (W/kg)	Tissue Used for Verification	Deviation (%)	Plot Number
30-Dec-2015	750 MHz	8.48	8.65	Body	+ 2.00	1
30-Dec-2015	835 MHz	9.28	9.43	Body	+ 1.62	2
30-Dec-2015	1750 MHz	37.70	38.50	Body	+ 2.12	3
30-Dec-2015	1900 MHz	40.40	40.20	Body	- 0.50	4
30-Dec-2015	2450 MHz	52.10	51.20	Body	- 1.73	5
30-Dec-2015	5200 MHz	77.40	76.30	Body	- 1.42	6
30-Dec-2015	5600 MHz	80.70	78.30	Body	- 2.97	7
30-Dec-2015	5800 MHz	78.80	74.90	Body	- 4.95	8
19-Mar-2016	2450 MHz	52.10	52.00	Body	- 0.19	9
30-Nov-2016	900 MHz	10.60	11.00	Body	+ 3.77	10

See Appendix A for data plots.

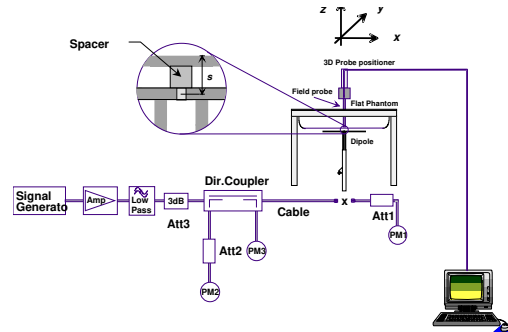

Figure 7.1 Dipole Validation Test Setup

8. LTE Document Checklist

- 1) Identify the operating frequency range of each LTE transmission band used by the device

LTE Operating Band	Uplink (transmit)	Downlink (Receive)	Duplex mode (FDD/TDD)
	Low - high	Low - high	
2	1850-1910	1930-1990	FDD
4	1710-1755	2110-2155	FDD
5	824-849	869-894	FDD
13	777-787	746-756	FDD
17	704-716	734-746	FDD

- 2) Identify the channel bandwidths used in each frequency band; 1.4, 3, 5, 10, 15, 20 MHz etc

LTE Band Class	Bandwidth (MHz)	Frequency or Freq. Band (MHz)
2	1.4, 3, 5, 10, 15, 20	1850-1910 MHz
4	1.4, 3, 5, 10, 15, 20	1710-1755 MHz
5	5, 10	824-849 MHz
13	5, 10	777-787 MHz
17	5, 10	704-716 MHz

- 3) Identify the high, middle and low (H, M, L) channel numbers and frequencies in each LTE frequency band

LTE Band Class	Bandwidth (MHz)	Frequency (MHz)/Channel #					
		Low		Mid		High	
2	1.4	1850.7	18607	1880.0	18900	1909.3	19193
2	3	1851.5	18615	1880.0	18900	1908.5	19185
2	5	1852.5	18625	1880.0	18900	1907.5	19175
2	10	1855.0	18650	1880.0	18900	1905.0	19150
2	15	1857.5	18675	1880.0	18900	1902.5	19125
2	20	1860.0	18700	1880.0	18900	1900.0	19100
4	1.4	1710.7	19957	1732.5	20175	1754.3	20393
4	3	1711.5	19965	1732.5	20175	1753.5	20385
4	5	1712.5	19975	1732.5	20175	1752.5	20375
4	10	1715.0	20000	1732.5	20175	1750.0	20350
4	15	1717.5	20025	1732.5	20175	1747.5	20325
4	20	1720.0	20050	1732.5	20175	1745.0	20300
5	5	826.5	20425	836.5	20525	846.5	20625
5	10	829.0	20450	836.5	20525	844.0	20600
13	5	-----	-----	782.0	23230	-----	-----
13	10	-----	-----	782.0	23230	-----	-----
17	5	706.5	23755	710.0	23790	713.5	23825
17	10	709.0	23780	710.0	23790	711.0	23800

- 4) Specify the UE category and uplink modulations used:
 - UE Category: 3
 - Uplink modulations: QPSK and 16QAM
- 5) Include descriptions of the LTE transmitter and antenna implementation; and also identify whether it is a standalone transmitter operating independently of other wireless transmitters in the device or sharing hardware components and/or antenna(s) with other transmitters etc

The device has 4 antennas:

- WWAN Main (Transmit and Receive) Antenna
- WLAN Main and Aux (Transmit and Receive) Antenna
- Diversity (Receive Only) Antenna

Transmission relationship

- All transmission (TX) is limited to the WWAN and WLAN antennas only
- The device is unable to transmit CDMA/EDGE/GPRS/WCDMA/HSPA and LTE simultaneously.
- The Diversity antenna is receive only antenna which is reserved for the WWAN operation.
- Rx is simultaneous on Main and Diversity
- Simultaneous Tx with the WWAN and WLAN is allowed.

Antenna port	CDMA/EDGE/GPRS/WCDMA/HSPA		LTE		802.11 b/g/n	
	TX	RX	TX	RX	TX	RX
#1 WWAN Main	Yes	Yes	Yes	Yes	No	No
#2 WLAN Main	No	No	No	No	Yes	Yes
#3 WLAN Aux	No	No	No	No	Yes	Yes
#4 (Diversity)	No	Yes	No	Yes	No	No

- 6) Identify the LTE voice/data requirements in each operating mode and exposure condition with respect to head and body test configurations, antenna locations, handset flip-cover or slide positions, antenna diversity conditions etc

The device is a data only. Data mode was tested in each operating mode and exposure condition in the body configuration. See test setup photos to see all configurations tested.

- 7) Identify if Maximum Power Reduction (MPR) is optional or mandatory, i.e. built-in by design:
 - a) Only mandatory MPR may be considered during SAR testing, when the maximum output power is permanently limited by the MPR implemented within the UE; and only for the applicable RB (resource block) configurations specified in LTE standards

MPR is mandatory, built-in by design on all production units. It was enabled during testing.

Modulation	Channel Bandwidth/transmission Bandwidth Configuration (RB)						MPR (dB)
	1.4 MHz	3.0 MHz	5 MHz	10 MHz	15 MHz	20 MHz	
QPSK	> 5	> 4	> 8	> 12	> 16	> 18	≤ 1
16QAM	≤ 5	≤ 4	≤ 8	≤ 12	≤ 16	≤ 18	≤ 1
16QAM	> 5	> 4	> 8	> 12	> 16	> 18	≤ 2

- b) A-MPR (additional MPR) must be disabled
- c) A-MPR was disabled during testing.

- 8) Include the maximum average conducted output power measured on the required test channels for each channel bandwidth and UL modulation used in each frequency band:

The maximum average conducted output power measured for the testing is listed on pages 48-60 of this report. The below table shows the factory set point with the allowable tolerance.

Band	Technology	Class	3GPP Nominal Power dBm	Calibrated Nominal Power dBm	Tolerance dBm	Lower Tolerance dBm	Upper Tolerance dBm
Band 17 – 750 MHz	LTE	3	22.0	22.0	±1.0	21.0	23.0
Band 13 – 750 MHz	LTE	3	22.0	22.0	±1.0	21.0	23.0
Band 5 – 835 MHz	LTE	3	22.0	22.0	±1.0	21.0	23.0
Band 4 – 1750 MHz	LTE	3	18.0	18.0	±1.0	17.0	19.0
Band 2 – 1900 MHz	LTE	3	18.0	18.0	±1.0	17.0	19.0

- 9) Identify all other U.S. wireless operating modes (3G, Wi-Fi, WiMax, Bluetooth etc), device/exposure configurations (head and body, antenna and handset flip-cover or slide positions, antenna diversity conditions etc.) and frequency bands used for these modes

Other wireless modes:

Band	Technology	Class	3GPP Nominal Power dBm	Calibrated Nominal Power dBm	Tolerance dBm	Lower Tolerance dBm	Upper Tolerance dBm
Band 5 – 835 MHz	CDMA	3	23.0	23.0	±1.0	22.0	24.0
Band 5 – 850 MHz	GPRS	4	32.0	32.0	±1.0	31.0	33.0
Band 5 – 850 MHz	EDGE	E2	26.0	26.0	±1.0	25.0	27.0
Band 5 – 850 MHz	WCDMA/HSPA	3	22.0	22.0	±1.0	21.0	23.0
Band 4 – 1750 MHz	WCDMA/HSPA	3	18.0	18.0	±1.0	17.0	19.0
Band 2 – 1900 MHz	CDMA	3	18.0	18.0	±1.0	17.0	19.0
Band 2 – 1900 MHz	GPRS	1	27.0	27.0	±1.0	26.0	28.0
Band 2 – 1900 MHz	EDGE	E2	25.0	25.0	±1.0	24.0	26.0
Band 2 – 1900 MHz	WCDMA/HSPA	3	18.0	18.0	±1.0	17.0	19.0

- 10) Include the maximum average conducted output power measured for the other wireless modes and frequency bands.

The maximum average conducted output power measured for the testing is listed on pages 25-29 of this report. The table in item 9 shows the factory set point with the allowable tolerance.

- 11) Identify the simultaneous transmission conditions for the voice and data configurations supported by all wireless modes, device configurations and frequency bands, for the head and body exposure conditions and device operating configurations (handset flip or cover positions, antenna diversity conditions etc.)

The device is unable to transmit WCDMA/GPRS/EDGE/CDMA and LTE simultaneously.

The device is able to transmit WWAN and WLAN simultaneously.

TX Modes	WCDMA/GPRS/EDGE/CDMA	LTE	802.11 b/g/n
1	ON	OFF	ON
2	OFF	ON	ON

- 12) When power reduction is applied to certain wireless modes to satisfy SAR compliance for simultaneous transmission conditions, other equipment certification or operating requirements, include the maximum average conducted output power measured in each power reduction mode applicable to the simultaneous voice/data transmission configurations for such wireless configurations and frequency bands; and also include details of the power reduction implementation and measurement setup

Power reduction is not required to satisfy SAR compliance.

- 13) Include descriptions of the test equipment, test software, built-in test firmware etc. required to support testing the device when power reduction is applied to one or more transmitters/antennas for simultaneous voice/data transmission

Power reduction is not required to satisfy SAR compliance.

- 14) When appropriate, include a SAR test plan proposal with respect to the above

Power reduction is not required to satisfy SAR compliance.

- 15) If applicable, include preliminary SAR test data and/or supporting information in laboratory testing inquiries to address specific issues and concerns or for requesting further test reduction considerations appropriate for the device; for example, simultaneous transmission configurations.

Not applicable.

9. SAR Test Data Summary

See Measurement Result Data Pages

See Appendix B for SAR Test Data Plots.
See Appendix C for SAR Test Setup Photos.

Procedures Used To Establish Test Signal

The device was either placed into simulated transmit mode using the manufacturer's test codes or the actual transmission is activated through a base station simulator or similar equipment. See data pages for actual procedure used in measurement.

Device Test Condition

In order to verify that the device was tested at full power, conducted output power measurements were performed before and after each SAR measurement to confirm the output power unless otherwise noted. If a conducted power deviation of more than 5% occurred, the test was repeated. The power drift of each test is measured at the start of the test and again at the end of the test. The drift percentage is calculated by the formula $((\text{end}/\text{start})-1)*100$ and rounded to three decimal places. The drift percentage is calculated into the resultant SAR value on the data sheet for each test.

The testing was conducted on all edges closest to each antenna. The back and right side was tested for the WWAN antenna. The remaining sides were not tested as the WWAN antenna was more than 2.5 cm from the side. The back, top, left and right sides were tested for the WLAN antennas. The remaining sides were not tested as the antenna was more than 2.5 cm from these sides. The back, left, right and top sides were tested for the RFID antenna. The remaining side was not tested as the RFID antenna was more than 2.5 cm for this side. All further test reductions are shown on pages 45-47 for CDMA/GSM/WCDMA bands, page 34-44 for WLAN, page 48 for RFID and pages 63-67 for LTE bands. See the photo in Appendix C for a pictorial of the setups and antenna locations.

The main antenna was evaluated for stand-alone SAR per RSS-102 Issue 5 for BT. Please see data sheet summary on page 80.

This device is capable of operating in 850/1900 GPRS/EDGE frequency bands. In GPRS mode, the device is in Class 4 for 850 MHz and Class 1 for 1900 MHz. In EDGE mode, the device is in Class E2 for 850/1900 MHz. The testing was conducted in the GPRS mode. The GPRS mode has 1-slot, 2-slot, 3-slot and 4-slot configurations. The power measured is peak power. The average power in all GPRS Slots calculated and the 1-slot had the highest average power. Therefore, the testing was conducted in 1-Slot. The EDGE mode is >5 dB lower than its equivalent slot configuration for GPRS. Therefore, the device was only tested in the highest power configuration which was 1-slot GPRS.

The WCDMA testing was conducted using 12.2 kbps RMC configured in Test Loop Mode 1. The HSPA testing was conducted with HS-DPCCH, E-DPCCH and E-DPDCH all enabled and a 12.2 kbps RMC. FRC was configured according to HS-DPCCH Sub-Test 1 using H-set 1 and QPSK.

The 1xRTT testing was conducted in RC3 with the device configured using TDSO/SO32 with FCH transmitting at full rate. The power control was set to “All Bits Up.” 1xRTT did not require SAR testing due to the measured power being less than ¼ dB higher than Rev. 0.

The Rev. 0 testing was conducted with the Reverse Data Channel rate of 153.6 kbps. The Forward Traffic Channel data rate is set to the 2-slot version of 307.2 kbps with the ACK Channel transmitting in all slots. The power control was set to “All Bits Up.” Other rates were not tested due to the conducted power measured was less than ¼ dB higher than 153.6 kbps.

The Rev. A Subtype 2 testing was conducted with the Reverse Data Channel payload size of 4096 bits and Termination Target of 16 slots. The Forward Traffic Channel data rate is set to the 2-slot version of 307.2 kbps with the ACK Channel transmitting in all slots. The power control was set to “All Bits Up.” Rev. A did not require SAR testing due to the measured power being less than ¼ dB higher than Rev. 0.

**Figure 9.1
SAR Location Diagram of Antenna Distances**

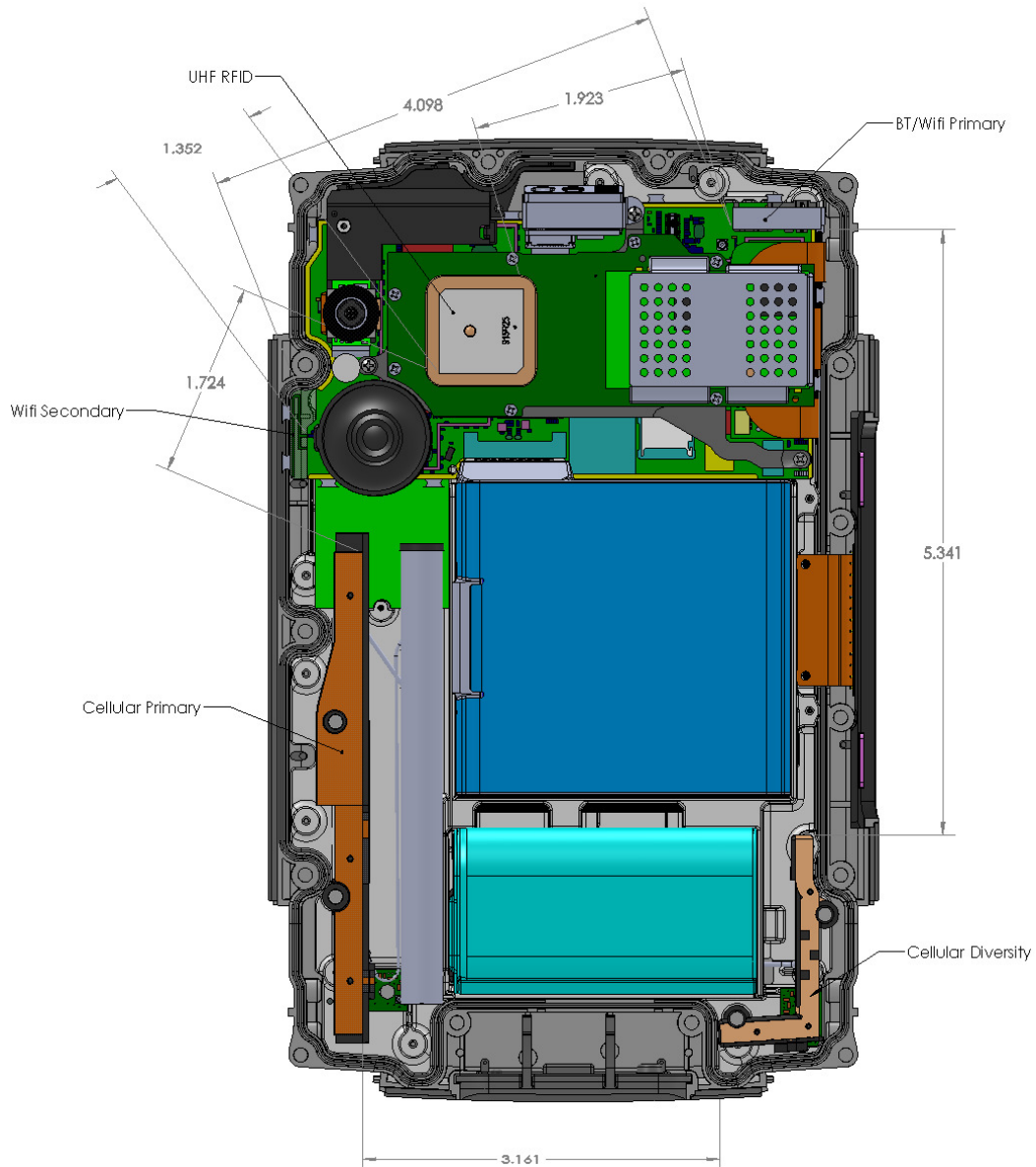

Antenna Distances

WWAN main to WLAN (Chain 1) (mm):	112.85 mm
WWAN main to WLAN (Chain 2) (mm):	23.67 mm

10. FCC 3G Measurement Procedures

Power measurements were performed using a base station simulator under average power.

10.1 Procedures Used to Establish RF Signal for SAR

The device was placed into a simulated call using a base station simulator in a screen room. Such test signals offer a consistent means for testing SAR and recommended for evaluating SAR. The SAR measurement software calculates a reference point at the start and end of the test to check for power drifts. If conducted power deviations of more than 5% occurred, the tests were repeated.

10.2 SAR Measurement Conditions for CDMA2000, 1xEV-DO

10.2.1 Output Power Verification 1xRTT

Use CDMA2000 Rev 6 protocol in the call box.

- 1) Test for RC 3 Reverse FCH, RC3 Reverse SCH0 and demodulation of RC 3, 4 and 5.
 - a. Set up a call using Supplemental Channel Test Mode 3 (RC 3, SO 32) with 9600 bps Fundamental Channel and 9600 bps SCH0 data rate.
 - b. As per C.S0011 or TIA/EIA-98-F Table 4.4.5.2-2, set the test parameters.
 - c. Send alternating '0' and '1' power control bit to the device
 - d. Determine the active channel configuration. If the desired channel configuration is not the active channel configuration, increase $\hat{\rho}$ by 1 dB and repeat the verification. Repeat this step until the desired channel configuration becomes active.
 - e. Measure the output power at the device antenna connector.
 - f. Decrease $\hat{\rho}$ by 0.5 dB.
 - g. Determine the active channel configuration. If the active channel configuration is the desired channel configuration, measure the output power at the device antenna connector.
 - h. Repeat step f and g until the output power no longer increases or the desired channel configuration is no longer active. Record the highest output power achieved with the desired channel configuration active.
 - i. Repeat step a through h ten times and average the result.

10.2.2 Output Power Verification 1xEvDo

- 1) Use 1xEV-DO Rel 0 protocol in the call box 8960.
 - a. FTAP
 - Select Test Application Protocol to FTAP
 - Set FTAP Rate to 307.2 kbps (2 Slot, QPSK)
 - Generator Info -> Termination Parameters -> Max Forward Packet Duration -> 16 Slots
 - Set $\hat{\rho}$ to -60 dBm/1.23 MHz
 - Send continuously '0' power control bits
 - Measure the power at device antenna connector
 - b. RTAP
 - Select Test Application Protocol to RTAP
 - Set RTAP Rate to 9.6 kbps

- Generator Info -> Termination Parameters -> Max Forward Packet Duration -> 16 Slots
 - Set \hat{I} or to -60 dBm/1.23 MHz
 - Send continuously '0' power control bits
 - Measure the power at device antenna connector
 - Repeat above steps for RTAP Rate = 19.2 kbps, 38.4 kbps, 76.8 kbps and 153.6 kbps respectively
- 2) Use 1xEV-DO Rev A protocol in the call box 8960
- a. FETAP
 - Select Test Application Protocol to FETAP
 - Set FETAP Rate to 307.2 kbps (2 Slot, QPSK)
 - Generator Info -> Termination Parameters -> Max Forward Packet Duration -> 16 Slots
 - Set \hat{I} or to -60 dBm/1.23 MHz
 - Send continuously '0' power control bits
 - Measure the power at device antenna connector
 - b. RETAP
 - Select Test Application Protocol to RETAP
 - F-Traffic Format -> 4 (1024, 2, 128) Canonical (307.2k, QPSK) • Set R-Data Pkt Size to 128
 - Protocol Subtype Config -> Release A Physical Layer Subtype -> Subtype 2 -> PL Subtype 2 Access Channel MAC Subtype -> Default (Subtype 0)
 - Generator Info -> Termination Parameters -> Max Forward Packet Duration -> 16 Slots ->ACK R-Data After -> Subpacket 0 (All ACK)
 - Set \hat{I} or to -60 dBm/1.23 MHz
 - Send continuously '0' power control bits
 - Measure the power at device antenna connector
 - Repeat above steps for R-Data Pkt Size = 256, 512, 768, 1024, 1536, 2048, 3072, 4096, 6144, 8192, 12288 respectively.

		IS-2000	1Xev-Do Rev. 0	1Xev-Do Rev. A Subtype 0/1
	Channel	TDSO SO32 RC3	RTAP [dBm]	RTAP [dBm]
Cellular BC0	1013	23.40	23.40	23.46
	384	23.36	23.35	23.40
	777	23.42	23.40	23.45
Cellular BC10	450	23.45	23.41	23.42
	584	23.39	23.39	23.45
	719	23.48	23.38	23.41
PCS	25	18.50	18.70	18.38
	600	18.49	18.70	18.44
	1175	18.50	18.71	18.43

CDMA Power Measurements
Power Control was set in "All Bits Up" for all measurements.

10.3 SAR Measurement Conditions for WCDMA/HSDPA/HSUPA

Configure the call box 8960 to support all WCDMA tests in respect to the 3GPP 34.121 (listed in Table below). Measure the power at Ch4132, 4182 and 4233 for US cell; Ch9262, 9400 and 9538 for US PCS band.

For Rel99

- Set a Test Mode 1 loop back with a 12.2kbps Reference Measurement Channel (RMC).
- Set and send continuously Up power control commands to the device
- Measure the power at the device antenna connector using the power meter with average detector.

For HSDPA Rel 6

- Establish a Test Mode 1 look back with both 1 12.2kbps RMC channel and a H-Set1 Fixed Reference Channel (FRC). With the 8960 this is accomplished by setting the signal Channel Coding to “Fixed Reference Channel” and configuring for HSET-1 QKSP.
- Set beta values and HSDPA settings for HSDPA Subtest1 according to Table below.
- Send continuously Up power control commands to the device
- Measure the power at the device antenna connector using the power meter with modulated average detector.
- Repeat the measurement for the HSDPA Subtest2, 3 and 4 as given in Table below.

For HSUPA Rel 6

- Use UL RMC 12.2kbps and FRC H-Set1 QPSK, Test Mode 1 loop back. With the 8960 this is accomplished by setting the signal Channel Coding to “E-DCH Test Channel” and configuring the equipment category to Cat5_10ms.
- Set the Absolute Grant for HSUPA Subtest1 according to Table below.
- Set the device power to be at least 5dB lower than the Maximum output power
- Send power control bits to give one TPC_cmd = +1 command to the device. If device doesn’t send any E-DPCH data with decreased E-TFCl within 500ms, then repeat this process until the decreased E-TFCl is reported.
- Confirm that the E-TFCl transmitted by the device is equal to the target E-TFCl in Table below. If the E-TFCl transmitted by the device is not equal to the target E-TFCl, then send power control bits to give one TPC_cmd = -1 command to the UE. If UE sends any E-DPCH data with decreased E-TFCl within 500 ms, send new power control bits to give one TPC_cmd = -1 command to the UE. Then confirm that the E-TFCl transmitted by the UE is equal to the target E-TFCl in Table below.
- Measure the power using the power meter with modulated average detector.
- Repeat the measurement for the HSUPA Subtest2, 3, 4 and 5 as given in Table below.

3GPP Release Version	Mode	Cellular Band [dBm]			Sub-Test (See Table Below)	MPR
		4132	4183	4233		
99	WCDMA	22.99	22.98	22.99	-	-
6	HSDPA	22.86	22.87	22.79	1	0
6		22.82	22.89	22.85	2	0
6		22.39	22.42	22.37	3	0.5
6		22.94	22.49	22.40	4	0.5
6	HSUPA	22.80	22.90	22.83	1	0
6		20.95	20.99	20.96	2	2
6		21.97	22.08	21.99	3	1
6		21.06	21.01	21.04	4	2
6		22.82	22.84	22.87	5	0

3GPP Release Version	Mode	AWS Band [dBm]			Sub-Test (See Table Below)	MPR
		1312	1413	1513		
99	WCDMA	18.88	18.90	18.95	-	-
6	HSDPA	18.79	18.82	18.76	1	0
6		18.81	18.75	18.79	2	0
6		18.36	18.34	18.36	3	0.5
6		18.41	18.31	18.39	4	0.5
6	HSUPA	18.84	18.82	18.75	1	0
6		16.97	17.01	16.89	2	2
6		17.94	18.05	17.94	3	1
6		16.99	16.95	17.03	4	2
6		17.82	18.80	18.71	5	0

3GPP Release Version	Mode	PCS Band [dBm]			Sub-Test (See Table Below)	MPR
		9262	9400	9538		
99	WCDMA	18.92	18.97	18.95	-	-
6	HSDPA	18.81	18.85	18.79	1	0
6		18.75	18.79	18.74	2	0
6		18.42	18.36	18.38	3	0.5
6		18.44	18.36	18.40	4	0.5
6	HSUPA	18.88	18.85	18.72	1	0
6		16.92	17.05	16.93	2	2
6		17.91	18.03	17.99	3	1
6		16.95	16.97	17.00	4	2
6		17.85	18.81	18.78	5	0

Sub-Test Setup for Release 6 HSDPA

Sub-Test	β_c	β_d	B_c / β_d	β_{hs}
1	2/15	15/15	2/15	4/15
2	12/15	15/15	15/15	24/15
3	15/15	8/15	15/8	30/15
4	15/15	4/15	15/4	30/15

$\Delta_{ack}, \Delta_{nack}$ and $\Delta_{cqi} = 8$

Sub-Test Setup for Release 6 HSUPA

Sub-Test	β_c	β_d	B_c / β_d	β_{hs}	B_{ec}	B_{ed}	MPR	AG Index	E-TFCI
1	11/15	15/15	11/15	22/15	209/225	1039/225	0.0	20	75
2	6/15	15/15	6/15	12/15	12/15	94/75	2.0	12	67
3	15/15	9/15	15/9	30/15	30/15	47/15	1.0	15	92
4	2/15	15/15	2/15	4/15	2/15	56/15	2.0	17	71
5	15/15	15/15	15/15	30/15	24/15	134/15	0.0	21	81

$\Delta_{ack}, \Delta_{nack}$ and $\Delta_{cqi} = 8$

10.4 SAR Measurement Conditions for GSM

Configure the 8960 box to support GMSK and 8PSK call respectively, and set one timeslot and two timeslot transmission for GMSK GSM/GPRS and 8PSK EDGE. Measure and record power outputs for both modulations.

GPRS-GMSK/1 slot			
Band	Channel	Peak Power	Frame Average
Cellular	128	32.50	23.47
	190	32.45	23.42
	251	32.44	23.41
PCS	512	27.45	18.42
	661	27.20	18.17
	810	27.50	18.47

GPRS-GMSK/2 slot			
Band	Channel	Peak Power	Frame Average
Cellular	128	29.87	23.85
	190	29.87	23.85
	251	29.85	23.83
PCS	512	24.96	18.94
	661	24.91	18.89
	810	24.95	18.93

GPRS-GMSK/3 slot			
Band	Channel	Peak Power	Frame Average
Cellular	128	27.25	22.99
	190	27.16	22.90
	251	27.23	22.97
PCS	512	22.35	18.09
	661	22.22	17.96
	810	22.46	18.02

GPRS-GMSK/4 slot			
Band	Channel	Peak Power	Frame Average
Cellular	128	26.87	23.86
	190	26.76	23.75
	251	26.70	23.69
PCS	512	21.03	18.02
	661	21.93	17.92
	810	21.03	18.02

EDGE-8PSK/1 slot			
Band	Channel	Peak Power	Frame Average
Cellular	128	26.59	17.56
	190	26.53	17.50
	251	26.68	17.65
PCS	512	25.62	16.59
	661	25.46	16.43
	810	25.55	16.52

EDGE-8PSK/2 slot			
Band	Channel	Peak Power	Frame Average
Cellular	128	23.99	17.97
	190	23.95	17.93
	251	23.99	17.97
PCS	512	22.99	16.97
	661	22.89	16.87
	810	23.06	17.04

EDGE-8PSK/3 slot			
Band	Channel	Peak Power	Frame Average
Cellular	128	22.35	18.09
	190	22.29	18.03
	251	22.45	18.19
PCS	512	21.38	17.12
	661	21.34	17.08
	810	21.52	17.26

EDGE-8PSK/4 slot			
Band	Channel	Peak Power	Frame Average
Cellular	128	21.18	18.17
	190	21.16	18.15
	251	21.21	18.20
PCS	512	20.22	17.21
	661	20.17	17.16
	810	20.28	17.27

Band	Mode	Bandwidth (MHz)	Channel	Frequency (MHz)	Data Rate	Antenna	Power (dBm)	
2450 MHz	802.11b	20	1	2412	1 Mbps	Chain A	17.91	
			6	2437			18.00	
			11	2462			17.96	
			1	2412		Chain B	17.95	
			6	2437			17.98	
			11	2462			17.96	
	802.11g	20	1	2412	6 Mbps	Chain A	16.93	
			6	2437			16.98	
			11	2462			16.96	
			1	2412		Chain B	16.95	
			6	2437			16.99	
			11	2462			16.92	
	802.11n	20	1	2412	HT4	Chain A	15.90	
			6	2437			15.97	
			11	2462			15.89	
			1	2412		Chain B	15.91	
			6	2437			15.92	
			11	2462			15.96	
	802.11n	40	3	2422	HT4	Chain A	13.92	
			6	2437			13.95	
			9	2452			13.98	
			3	2422		Chain B	13.91	
			6	2437			13.96	
			9	2452			13.97	
5.15-5.25 GHz	802.11a	20	36	5180	6 Mbps	Chain A	15.92	
			40	5200			15.97	
			44	5220			16.00	
			48	5240			15.96	
			36	5180		Chain B	15.96	
			40	5200			15.92	
			44	5220			16.00	
			48	5240			15.99	
	802.11n	20	36	5180	HT4	Chain A	13.89	
			40	5200			13.93	
			44	5220			13.96	
			48	5240			13.92	
			36	5180		Chain B	13.88	
			40	5200			13.85	
			44	5220			13.93	
			48	5240			13.90	
	802.11n	40	38	5190	HT4	Chain A	13.86	
			46	5230			13.89	
			38	5190		Chain B	13.85	
			46	5230			13.88	
			52	5260	6 Mbps		Chain A	15.98
			56	5280				15.96
			60	5300		16.00		
			64	5320		15.86		
5.25-5.35 GHz	802.11a	20	52	5260		6 Mbps	Chain B	15.94
			56	5280				15.95
			60	5300				16.00
			52	5260			Chain A	15.92
			56	5280	13.91			
			64	5320	13.90			
	802.11n	20	52	5260	HT4	Chain A	13.91	
			56	5280			13.87	
			60	5300			13.89	
			52	5260		Chain B	13.83	
			56	5280			13.91	
			60	5300			13.88	
802.11n	40	54	5270	HT4	Chain A	13.92		
		62	5310			13.89		
		54	5270	Chain B		13.85		
		62	5310		13.87			

Conducted Average Power Measurements

Band	Mode	Bandwidth (MHz)	Channel	Frequency (MHz)	Data Rate	Antenna	Power (dBm)
5600 MHz	802.11a	20	100	5500	6 Mbps	Chain A	15.96
			104	5520			15.89
			108	5540			15.92
			112	5560			15.91
			116	5580			16.00
			120	5600			15.94
			124	5620			16.00
			128	5640			15.92
			132	5660			16.00
			136	5680			15.93
			140	5700			15.90
			100	5500			15.94
			104	5520		15.92	
			108	5540		15.90	
			112	5560		15.95	
			116	5580		16.00	
			120	5600		15.89	
			124	5620		16.00	
			128	5640		15.92	
			132	5660		16.00	
			136	5680		15.91	
			140	5700		15.94	
			100	5500		13.95	
			104	5520		13.90	
	108	5540	13.89				
	112	5560	13.87				
	116	5580	13.88				
	120	5600	13.90				
	124	5620	13.94				
	128	5640	13.85				
	132	5660	13.82				
	136	5680	13.87				
	140	5700	13.83				
	100	5500	13.84				
	104	5520	13.96				
	108	5540	13.92				
	112	5560	13.90				
	116	5580	13.93				
	120	5600	13.97				
	124	5620	13.89				
	128	5640	13.87				
	132	5660	13.94				
	136	5680	13.82				
	140	5700	13.91				
	102	5510	13.92				
	110	5550	13.91				
	118	5580	13.87				
	126	5610	13.89				
134	5670	13.90					
102	5510	13.91					
110	5550	13.90					
118	5580	13.84					
126	5610	13.81					
134	5670	13.89					

Conducted Average Power Measurements

Band	Mode	Bandwidth (MHz)	Channel	Frequency (MHz)	Data Rate	Antenna	Power (dBm)	
5800 MHz	802.11a	20	149	5745	6 Mbps	Chain A	15.92	
			153	5765			15.98	
			157	5785			16.00	
			161	5805			15.94	
			165	5825			16.00	
			149	5745			15.96	
			153	5765		15.91		
			157	5785		16.00		
			161	5805		15.95		
			165	5825		16.00		
			149	5745		13.91		
			153	5765		13.90		
	157	5785	13.89					
	161	5805	13.93					
	165	5825	13.88					
	149	5745	13.96					
	153	5765	13.91					
	157	5785	13.90					
	161	5805	13.93					
	165	5825	13.97					
	802.11n	20	40	151	5755	HT8	Chain A	13.89
				159	5795			13.85
				151	5755			13.84
				159	5795		Chain B	13.87

Conducted Average Power Measurements

Band	Mode	Channel	Frequency (MHz)	Antenna	Power (dBm)
2450 MHz	802.15.1	1	2402	Chain A	8.26
		39	2440		3.55

BT Conducted Average Power Measurements

Band	Mode	Channel	Frequency (MHz)	Antenna	Power (dBm)
900 MHz	FHSS	1	917.2	Chain A	29.92
		2	922.4		29.96
		3	927.2		29.89

RFID Conducted Average Power Measurements

Figure 10.1 Test Reduction Table – WiFi 2.4 GHz Main

Mode	Side	Required Channel	Tested/Reduced
802.11b	Back	1 – 2412 MHz	Reduced ¹
		6 – 2437 MHz	Tested
		11 – 2462 MHz	Reduced ¹
	Top	1 – 2412 MHz	Reduced ¹
		6 – 2437 MHz	Tested
		11 – 2462 MHz	Reduced ¹
	Left Side	1 – 2412 MHz	Reduced ¹
		6 – 2437 MHz	Tested
		11 – 2462 MHz	Reduced ¹
	Remaining Sides		
802.11g	Back	1 – 2412 MHz	Reduced ²
		6 – 2437 MHz	Reduced ²
		11 – 2462 MHz	Reduced ²
	Top	1 – 2412 MHz	Reduced ²
		6 – 2437 MHz	Reduced ²
		11 – 2462 MHz	Reduced ²
	Left Side	1 – 2412 MHz	Reduced ²
		6 – 2437 MHz	Reduced ²
		11 – 2462 MHz	Reduced ²
	Remaining Sides		
802.11n	Back	1 – 2412 MHz	Reduced ²
		6 – 2437 MHz	Reduced ²
		11 – 2462 MHz	Reduced ²
	Top	1 – 2412 MHz	Reduced ²
		6 – 2437 MHz	Reduced ²
		11 – 2462 MHz	Reduced ²
	Left Side	1 – 2412 MHz	Reduced ²
		6 – 2437 MHz	Reduced ²
		11 – 2462 MHz	Reduced ²
	Remaining Sides		

Reduced¹ – When the reported SAR is ≤ 0.4 W/kg, SAR is not required for the remaining test configuration per KDB 248227 D01 v02r02 section 5.1.1 1) page 9.

Reduced² – When the highest reported SAR for DSSS is adjusted by the ratio of OFDM to DSSS specified maximum output power and the adjusted SAR is ≤ 1.2 W/kg, SAR is not required per KDB 248227 D01 v02 section 5.2.2 2) page 10.

Reduced³ – When the antenna is more than 25 mm from a side, the test can be reduced per KDB447498 D01 v06 section 4.3.1 2) page 11. See below for calculations.

Maximum power: 63.1 mW

Closest Distance to Right: 90.0 mm

Closest Distance to Bottom: 180.0 mm

The closest distance is from the right side. Therefore, if the right side is excluded the bottom would also be excluded.

$$[{\frac{3.0}{\sqrt{2.462}} * 50 \text{ mm}}] + [90 - 50 \text{ mm}] * 10 = 495 \text{ mW}$$

which is greater than 63.1 mW

Figure 10.2 Test Reduction Table – WiFi 2.4 GHz Aux

Mode	Side	Required Channel	Tested/Reduced
802.11b	Back	1 – 2412 MHz	Reduced ¹
		6 – 2437 MHz	Tested
		11 – 2462 MHz	Reduced ¹
	Right Side	1 – 2412 MHz	Reduced ¹
		6 – 2437 MHz	Tested
		11 – 2462 MHz	Reduced ¹
Remaining Sides			Reduced ³
802.11g	Back	1 – 2412 MHz	Reduced ²
		6 – 2437 MHz	Reduced ²
		11 – 2462 MHz	Reduced ²
	Right Side	1 – 2412 MHz	Reduced ²
		6 – 2437 MHz	Reduced ²
		11 – 2462 MHz	Reduced ²
Remaining Sides			Reduced ³
802.11n	Back	1 – 2412 MHz	Reduced ²
		6 – 2437 MHz	Reduced ²
		11 – 2462 MHz	Reduced ²
	Right Side	1 – 2412 MHz	Reduced ²
		6 – 2437 MHz	Reduced ²
		11 – 2462 MHz	Reduced ²
Remaining Sides			Reduced ³

Reduced¹ – When the reported SAR is ≤ 0.4 W/kg, SAR is not required for the remaining test configuration per KDB 248227 D01 v02r02 section 5.1.1 1) page 9.

Reduced² – When the highest reported SAR for DSSS is adjusted by the ratio of OFDM to DSSS specified maximum output power and the adjusted SAR is ≤ 1.2 W/kg, SAR is not required per KDB 248227 D01 v02 section 5.2.2 2) page 10.

Reduced³ – When the antenna is more than 25 mm from a side, the test can be reduced per KDB447498 D01 v06 section 4.3.1 2) page 11. See below for calculations.

Maximum power: 63.1 mW
 Closest Distance to Left: 128.0 mm
 Closest Distance to Bottom: 126.0 mm
 Closest Distance to Top: 55 mm

The closest distance is from the top side. Therefore, if the top side is excluded the bottom and left sides would also be excluded.

$$[[{(3.0)/(\sqrt{2.462})}*50 \text{ mm}]]+[[{55-50 \text{ mm}}]*10]=145 \text{ mW which is greater than 63.1 mW}$$

Figure 10.3 Test Reduction Table – WiFi 5.1 GHz Main

Mode	Side	Required Channel	Tested/Reduced
802.11a 5150 MHz	Back	36 – 5180 MHz	Reduced ¹
		40 – 5200 MHz	Reduced ¹
		44 – 5220 MHz	Reduced ¹
		48 – 5240 MHz	Reduced ¹
	Top	36 – 5180 MHz	Reduced ¹
		40 – 5200 MHz	Reduced ¹
		44 – 5220 MHz	Reduced ¹
		48 – 5240 MHz	Reduced ¹
	Left	36 – 5180 MHz	Reduced ¹
		40 – 5200 MHz	Reduced ¹
		44 – 5220 MHz	Reduced ¹
		48 – 5240 MHz	Reduced ¹
	Remaining Sides		
802.11n 5150 MHz	Back	36 – 5180 MHz	Reduced ¹
		40 – 5200 MHz	Reduced ¹
		44 – 5220 MHz	Reduced ¹
		48 – 5240 MHz	Reduced ¹
	Top	36 – 5180 MHz	Reduced ¹
		40 – 5200 MHz	Reduced ¹
		44 – 5220 MHz	Reduced ¹
		48 – 5240 MHz	Reduced ¹
	Left	36 – 5180 MHz	Reduced ¹
		40 – 5200 MHz	Reduced ¹
		44 – 5220 MHz	Reduced ¹
		48 – 5240 MHz	Reduced ¹
	Remaining Sides		

Reduced¹ – When the adjusted SAR is ≤ 1.2 W/kg, SAR is not required for the UNII-1 with the same or lower maximum output power in that test configuration per KDB 248227 D01 v02r02 section 5.3.1 1) page 11.

Reduced² – When the antenna is more than 25 mm from a side, the test can be reduced per KDB447498 D01 v06 section 4.3.1 1) page 11. See below for calculations.

Maximum power: 39.8 mW
 Closest Distance to Right: 90.0 mm
 Closest Distance to Bottom: 180.0 mm

The closest distance is from the right side. Therefore, if the right side is excluded the bottom would also be excluded.

$$[{\frac{3.0}{\sqrt{5.24}}}] * 50 \text{ mm}] + [90 - 50 \text{ mm}] * 10 = 465 \text{ mW which is greater than } 39.8 \text{ mW}$$

Figure 10.4 Test Reduction Table – WiFi 5.1 GHz Aux

Mode	Side	Required Channel	Tested/Reduced
802.11a 5150 MHz	Back	36 – 5180 MHz	Reduced ¹
		40 – 5200 MHz	Reduced ¹
		44 – 5220 MHz	Reduced ¹
		48 – 5240 MHz	Reduced ¹
	Right	36 – 5180 MHz	Reduced ¹
		40 – 5200 MHz	Reduced ¹
		44 – 5220 MHz	Reduced ¹
		48 – 5240 MHz	Reduced ¹
Remaining Sides			Reduced ²
802.11n 5150 MHz	Back	36 – 5180 MHz	Reduced ¹
		40 – 5200 MHz	Reduced ¹
		44 – 5220 MHz	Reduced ¹
		48 – 5240 MHz	Reduced ¹
	Right	36 – 5180 MHz	Reduced ¹
		40 – 5200 MHz	Reduced ¹
		44 – 5220 MHz	Reduced ¹
		48 – 5240 MHz	Reduced ¹
Remaining Sides			Reduced ²

Reduced¹ – When the adjusted SAR is ≤ 1.2 W/kg, SAR is not required for the UNII-1 with the same or lower maximum output power in that test configuration per KDB 248227 D01 v02r02 section 5.3.1 1) page 11.

Reduced² – When the antenna is more than 25 mm from a side, the test can be reduced per KDB447498 D01 v06 section 4.3.1 1) page 11. See below for calculations.

Maximum power: 39.8 mW
 Closest Distance to Left: 128.0 mm
 Closest Distance to Bottom: 126.0 mm
 Closest Distance to Top: 55 mm

The closest distance is from the top side. Therefore, if the top side is excluded the bottom and left sides would also be excluded.

$$[[{(3.0)/(\sqrt{5.24})]*50 \text{ mm}}]+[55-50 \text{ mm}]*10]=115 \text{ mW}$$

which is greater than 39.8 mW

Figure 10.5 Test Reduction Table – WiFi 5.2 GHz Main

Mode	Side	Required Channel	Tested/Reduced
802.11a 5250 MHz	Back	52 – 5260 MHz	Reduced ³
		56 – 5280 MHz	Reduced ³
		60 – 5300 MHz	Tested
		64 – 5320 MHz	Tested
	Top	52 – 5260 MHz	Reduced ¹
		56 – 5280 MHz	Reduced ¹
		60 – 5300 MHz	Tested
		64 – 5320 MHz	Reduced ¹
	Left	52 – 5260 MHz	Reduced ³
		56 – 5280 MHz	Reduced ³
		60 – 5300 MHz	Tested
		64 – 5320 MHz	Tested
Remaining Sides			Reduced ²
802.11n 5250 MHz	Back	52 – 5260 MHz	Reduced ³
		56 – 5280 MHz	Reduced ³
		60 – 5300 MHz	Reduced ³
		64 – 5320 MHz	Reduced ³
	Top	52 – 5260 MHz	Reduced ¹
		56 – 5280 MHz	Reduced ¹
		60 – 5300 MHz	Reduced ¹
		64 – 5320 MHz	Reduced ¹
	Left	52 – 5260 MHz	Reduced ³
		56 – 5280 MHz	Reduced ³
		60 – 5300 MHz	Reduced ³
		64 – 5320 MHz	Reduced ³
Remaining Sides			Reduced ²

Reduced¹ – When the reported SAR is ≤ 0.4 W/kg, SAR is not required for the remaining test configuration per KDB 248227 D01 v02r02 section 5.1.1 1) page 9.

Reduced² – When the antenna is more than 25 mm from a side, the test can be reduced per KDB447498 D01 v06 section 4.3.1 1) page 11. See below for calculations.

Reduced³ – When the reported SAR is >0.4 W/kg, test the next highest configuration until the SAR value is ≤ 0.8 W/kg per KDB 248227 D01 v02r02 section 5.1.1 2) page 9.

Maximum power: 39.8 mW
 Closest Distance to Right: 90.0 mm
 Closest Distance to Bottom: 180.0 mm

The closest distance is from the right side. Therefore, if the right side is excluded the bottom would also be excluded.

$$[{\{(3.0)/(\sqrt{5.32})\} * 50 \text{ mm}}] + {\{90 - 50 \text{ mm}\} * 10} = 465 \text{ mW} \text{ which is greater than } 39.8 \text{ mW}$$

Figure 10.6 Test Reduction Table – WiFi 5.2 GHz Aux

Mode	Side	Required Channel	Tested/Reduced	
802.11a 5250 MHz	Back	52 – 5260 MHz	Reduced ¹	
		56 – 5280 MHz	Reduced ¹	
		60 – 5300 MHz	Tested	
		64 – 5320 MHz	Reduced ¹	
	Right	52 – 5260 MHz	Reduced ¹	
		56 – 5280 MHz	Reduced ¹	
		60 – 5300 MHz	Tested	
		64 – 5320 MHz	Reduced ¹	
	Remaining Sides			Reduced ²
	802.11n 5250 MHz	Back	52 – 5260 MHz	Reduced ¹
56 – 5280 MHz			Reduced ¹	
60 – 5300 MHz			Reduced ¹	
64 – 5320 MHz			Reduced ¹	
Right		52 – 5260 MHz	Reduced ¹	
		56 – 5280 MHz	Reduced ¹	
		60 – 5300 MHz	Reduced ¹	
		64 – 5320 MHz	Reduced ¹	
Remaining Sides			Reduced ²	

Reduced¹ – When the reported SAR is ≤ 0.4 W/kg, SAR is not required for the remaining test configuration per KDB 248227 D01 v02r02 section 5.1.1 1) page 9.

Reduced² – When the antenna is more than 25 mm from a side, the test can be reduced per KDB447498 D01 v06 section 4.3.1 1) page 11. See below for calculations.

Reduced³ – When the reported SAR is >0.4 W/kg, test the next highest configuration until the SAR value is ≤ 0.8 W/kg per KDB 248227 D01 v02r02 section 5.1.1 2) page 9.

Maximum power: 39.8 mW
 Closest Distance to Left: 128.0 mm
 Closest Distance to Bottom: 126.0 mm
 Closest Distance to Top: 55 mm

The closest distance is from the top side. Therefore, if the top side is excluded the bottom and left sides would also be excluded.

$$[[(3.0)/(\sqrt{5.24})]*50 \text{ mm}]+[(55-50 \text{ mm})*10]=115 \text{ mW which is greater than } 39.8 \text{ mW}$$

Figure 10.7 Test Reduction Table – WiFi 5.6 GHz Main

Mode	Side	Required Channel	Tested/Reduced
802.11a 5600 MHz	Back	100 – 5500 MHz	Reduced ¹
		104 – 5520 MHz	Reduced ¹
		108 – 5540 MHz	Reduced ¹
		112 – 5560 MHz	Reduced ¹
		116 – 5580 MHz	Tested
		120 – 5600 MHz	Reduced ¹
		124 – 5620 MHz	Tested
		128 – 5640 MHz	Reduced ¹
		132 – 5660 MHz	Reduced ¹
		136 – 5680 MHz	Reduced ¹
	140 – 5700 MHz	Reduced ¹	
	Top	100 – 5500 MHz	Reduced ³
		104 – 5520 MHz	Reduced ³
		108 – 5540 MHz	Reduced ³
		112 – 5560 MHz	Reduced ³
		116 – 5580 MHz	Tested
		120 – 5600 MHz	Reduced ³
		124 – 5620 MHz	Tested
		128 – 5640 MHz	Reduced ³
		132 – 5660 MHz	Reduced ³
		136 – 5680 MHz	Reduced ³
	140 – 5700 MHz	Reduced ³	
	Left	100 – 5500 MHz	Reduced ³
		104 – 5520 MHz	Reduced ³
		108 – 5540 MHz	Reduced ³
		112 – 5560 MHz	Reduced ³
		116 – 5580 MHz	Tested
		120 – 5600 MHz	Reduced ³
		124 – 5620 MHz	Tested
		128 – 5640 MHz	Reduced ³
		132 – 5660 MHz	Reduced ³
		136 – 5680 MHz	Reduced ³
	140 – 5700 MHz	Reduced ³	
Remaining Sides			Reduced ²

Reduced¹ – When the reported SAR is >0.8 W/kg, test the next highest configuration until the SAR value is ≤ 1.2 W/kg per KDB 248227 D01 v02r02 section 5.1.1 3) page 9.

Reduced² – When the antenna is more than 25 mm from a side, the test can be reduced per KDB447498 D01 v06 section 4.3.1 1) page 11. See below for calculations.

Reduced³ – When the reported SAR is >0.4 W/kg, test the next highest configuration until the SAR value is ≤ 0.8 W/kg per KDB 248227 D01 v02r02 section 5.1.1 2) page 9.

Maximum power: 39.8 mW

Closest Distance to Right: 90.0 mm

Closest Distance to Bottom: 180.0 mm

The closest distance is from the right side. Therefore, if the right side is excluded the bottom would also be excluded.

$$[[(3.0)/(\sqrt{5.70})]*50 \text{ mm}]+[90-50 \text{ mm}]*10]=462 \text{ mW which is greater than } 39.8 \text{ mW}$$

Figure 10.8 Test Reduction Table – WiFi 5.6 GHz Main

Mode	Side	Required Channel	Tested/Reduced
802.11n 5600 MHz	Back	100 – 5500 MHz	Reduced ¹
		104 – 5520 MHz	Reduced ¹
		108 – 5540 MHz	Reduced ¹
		112 – 5560 MHz	Reduced ¹
		116 – 5580 MHz	Reduced ¹
		120 – 5600 MHz	Reduced ¹
		124 – 5620 MHz	Reduced ¹
		128 – 5640 MHz	Reduced ¹
		132 – 5660 MHz	Reduced ¹
		136 – 5680 MHz	Reduced ¹
	140 – 5700 MHz	Reduced ¹	
	Top	100 – 5500 MHz	Reduced ³
		104 – 5520 MHz	Reduced ³
		108 – 5540 MHz	Reduced ³
		112 – 5560 MHz	Reduced ³
		116 – 5580 MHz	Reduced ³
		120 – 5600 MHz	Reduced ³
		124 – 5620 MHz	Reduced ³
		128 – 5640 MHz	Reduced ³
		132 – 5660 MHz	Reduced ³
		136 – 5680 MHz	Reduced ³
	140 – 5700 MHz	Reduced ³	
	Left	100 – 5500 MHz	Reduced ³
		104 – 5520 MHz	Reduced ³
		108 – 5540 MHz	Reduced ³
		112 – 5560 MHz	Reduced ³
		116 – 5580 MHz	Reduced ³
		120 – 5600 MHz	Reduced ³
		124 – 5620 MHz	Reduced ³
		128 – 5640 MHz	Reduced ³
		132 – 5660 MHz	Reduced ³
		136 – 5680 MHz	Reduced ³
	140 – 5700 MHz	Reduced ³	
Remaining Sides			Reduced ²

Reduced¹ – When the reported SAR is >0.8 W/kg, test the next highest configuration until the SAR value is ≤ 1.2 W/kg per KDB 248227 D01 v02r02 section 5.1.1 3) page 9.

Reduced² – When the antenna is more than 25 mm from a side, the test can be reduced per KDB447498 D01 v06 section 4.3.1 1) page 11. See below for calculations.

Reduced³ – When the reported SAR is >0.4 W/kg, test the next highest configuration until the SAR value is ≤ 0.8 W/kg per KDB 248227 D01 v02r02 section 5.1.1 2) page 9.

Maximum power: 39.8 mW

Closest Distance to Right: 90.0 mm

Closest Distance to Bottom: 180.0 mm

The closest distance is from the right side. Therefore, if the right side is excluded the bottom would also be excluded.

$$[[(3.0)/(\sqrt{5.70})]*50 \text{ mm}]+[90-50 \text{ mm}]*10]=462 \text{ mW which is greater than } 39.8 \text{ mW}$$

Figure 10.9 Test Reduction Table – WiFi 5.6 GHz Aux

Mode	Side	Required Channel	Tested/Reduced
802.11a 5600 MHz	Back	100 – 5500 MHz	Reduced ¹
		104 – 5520 MHz	Reduced ¹
		108 – 5540 MHz	Reduced ¹
		112 – 5560 MHz	Reduced ¹
		116 – 5580 MHz	Reduced ¹
		120 – 5600 MHz	Reduced ¹
		124 – 5620 MHz	Tested
		128 – 5640 MHz	Reduced ¹
		132 – 5660 MHz	Reduced ¹
		136 – 5680 MHz	Reduced ¹
	Right	100 – 5500 MHz	Reduced ¹
		104 – 5520 MHz	Reduced ¹
		108 – 5540 MHz	Reduced ¹
		112 – 5560 MHz	Reduced ¹
		116 – 5580 MHz	Reduced ¹
		120 – 5600 MHz	Reduced ¹
		124 – 5620 MHz	Tested
		128 – 5640 MHz	Reduced ¹
		132 – 5660 MHz	Reduced ¹
		136 – 5680 MHz	Reduced ¹
Remaining Sides			Reduced ²
802.11n 5600 MHz	Back	100 – 5500 MHz	Reduced ¹
		104 – 5520 MHz	Reduced ¹
		108 – 5540 MHz	Reduced ¹
		112 – 5560 MHz	Reduced ¹
		116 – 5580 MHz	Reduced ¹
		120 – 5600 MHz	Reduced ¹
		124 – 5620 MHz	Reduced ¹
		128 – 5640 MHz	Reduced ¹
		132 – 5660 MHz	Reduced ¹
		136 – 5680 MHz	Reduced ¹
	Right	100 – 5500 MHz	Reduced ¹
		104 – 5520 MHz	Reduced ¹
		108 – 5540 MHz	Reduced ¹
		112 – 5560 MHz	Reduced ¹
		116 – 5580 MHz	Reduced ¹
		120 – 5600 MHz	Reduced ¹
		124 – 5620 MHz	Reduced ¹
		128 – 5640 MHz	Reduced ¹
		132 – 5660 MHz	Reduced ¹
		136 – 5680 MHz	Reduced ¹
Remaining Sides			Reduced ²

Reduced¹ – When the reported SAR is ≤ 0.4 W/kg, SAR is not required for the remaining test configuration per KDB 248227 D01 v02r02 section 5.1.1 1) page 9.

Reduced² – When the antenna is more than 25 mm from a side, the test can be reduced per KDB447498 D01 v06 section 4.3.1 1) page 11. See below for calculations.

Maximum power: 39.8 mW
 Closest Distance to Left: 128.0 mm
 Closest Distance to Bottom: 126.0 mm
 Closest Distance to Top: 55 mm

The closest distance is from the top side. Therefore, if the top side is excluded the bottom and left sides would also be excluded.

$$[[(3.0)/(\sqrt{5.70})]*50 \text{ mm}]+[(55-50 \text{ mm})*10]=112 \text{ mW which is greater than } 39.8 \text{ mW}$$

Figure 10.10 Test Reduction Table – WiFi 5.8 GHz Main

Mode	Side	Required Channel	Tested/Reduced	
802.11a 5800 MHz	Back	149 – 5745 MHz	Reduced ¹	
		153 – 5765 MHz	Reduced ¹	
		157 – 5785 MHz	Tested	
		161 – 5805 MHz	Reduced ¹	
		165 – 5825 MHz	Tested	
	Top	149 – 5745 MHz	Reduced ⁴	
		153 – 5765 MHz	Reduced ⁴	
		157 – 5785 MHz	Tested	
		161 – 5805 MHz	Reduced ⁴	
	Left	165 – 5825 MHz	Reduced ⁴	
		149 – 5745 MHz	Reduced ³	
		153 – 5765 MHz	Reduced ³	
		157 – 5785 MHz	Tested	
	802.11n 5800 MHz	Back	161 – 5805 MHz	Reduced ³
			165 – 5825 MHz	Tested
Remaining Sides			Reduced ²	
Top			149 – 5745 MHz	Reduced ¹
			153 – 5765 MHz	Reduced ¹
		157 – 5785 MHz	Reduced ¹	
		161 – 5805 MHz	Reduced ¹	
Left		165 – 5825 MHz	Reduced ¹	
		149 – 5745 MHz	Reduced ⁴	
		153 – 5765 MHz	Reduced ⁴	
		157 – 5785 MHz	Reduced ⁴	
Left		161 – 5805 MHz	Reduced ⁴	
		165 – 5825 MHz	Reduced ⁴	
		149 – 5745 MHz	Reduced ³	
		153 – 5765 MHz	Reduced ³	
Left	157 – 5785 MHz	Reduced ³		
	161 – 5805 MHz	Reduced ³		
	165 – 5825 MHz	Reduced ³		
	Remaining Sides		Reduced ²	

Reduced¹ – When the reported SAR is >0.8 W/kg, test the next highest configuration until the SAR value is ≤ 1.2 W/kg per KDB 248227 D01 v02r02 section 5.1.1 3) page 9.

Reduced² – When the antenna is more than 25 mm from a side, the test can be reduced per KDB447498 D01 v06 section 4.3.1 1) page 11. See below for calculations.

Reduced³ – When the reported SAR is >0.4 W/kg, test the next highest configuration until the SAR value is ≤ 0.8 W/kg per KDB 248227 D01 v02r02 section 5.1.1 2) page 9.

Reduced⁴ – When the reported SAR is ≤ 0.4 W/kg, SAR is not required for the remaining test configuration per KDB 248227 D01 v02r02 section 5.1.1 1) page 9.

Maximum power: 39.8 mW

Closest Distance to Right: 90.0 mm

Closest Distance to Bottom: 180.0 mm

The closest distance is from the right side. Therefore, if the right side is excluded the bottom would also be excluded.

$$[[(3.0)/(\sqrt{5.825})]*50 \text{ mm}]+[(90-50 \text{ mm})*10]=462 \text{ mW which is greater than } 39.8 \text{ mW}$$

Figure 10.11 Test Reduction Table – WiFi 5.8 GHz Aux

Mode	Side	Required Channel	Tested/Reduced	
802.11a 5800 MHz	Back	149 – 5745 MHz	Reduced ¹	
		153 – 5765 MHz	Reduced ¹	
		157 – 5785 MHz	Tested	
		161 – 5805 MHz	Reduced ¹	
		165 – 5825 MHz	Reduced ¹	
	Right	149 – 5745 MHz	Reduced ¹	
		153 – 5765 MHz	Reduced ¹	
		157 – 5785 MHz	Tested	
		161 – 5805 MHz	Reduced ¹	
	Remaining Sides			Reduced ²
	802.11n 5800 MHz	Back	149 – 5745 MHz	Reduced ¹
			153 – 5765 MHz	Reduced ¹
			157 – 5785 MHz	Reduced ¹
161 – 5805 MHz			Reduced ¹	
165 – 5825 MHz			Reduced ¹	
Right		149 – 5745 MHz	Reduced ¹	
		153 – 5765 MHz	Reduced ¹	
		157 – 5785 MHz	Reduced ¹	
		161 – 5805 MHz	Reduced ¹	
Remaining Sides			Reduced ²	

Reduced¹ – When the reported SAR is ≤ 0.4 W/kg, SAR is not required for the remaining test configuration per KDB 248227 D01 v02r02 section 5.1.1.1) page 9.

Reduced² – When the antenna is more than 25 mm from a side, the test can be reduced per KDB447498 D01 v06 section 4.3.1.1) page 11. See below for calculations.

Maximum power: 39.8 mW

Closest Distance to Left: 128.0 mm

Closest Distance to Bottom: 126.0 mm

Closest Distance to Top: 55 mm

The closest distance is from the top side. Therefore, if the top side is excluded the bottom and left sides would also be excluded.

$[(3.0)/(\sqrt{5.825}) * 50 \text{ mm}] + [(55 - 50 \text{ mm}) * 10] = 112 \text{ mW}$ which is greater than 39.8 mW

Figure 10.12 Test Reduction Table – 3G 850 MHz

Band/ Frequency (MHz)	Technology	Side	Required Channel	Tested/ Reduced	
Band 5 824-849 MHz	CDMA	Back	450	Tested	
			267	Tested	
			777	Tested	
		Right	450	Reduced ¹	
			267	Tested	
			777	Reduced ¹	
		Remaining Sides			Reduced ²
		GSM	Back	128	Tested
				190	Tested
	251			Tested	
	Right		128	Reduced ¹	
			190	Tested	
			251	Reduced ¹	
	Remaining Sides			Reduced ²	
	WCDMA		Back	4132	Tested
				4183	Tested
		4233		Tested	
		Right	4132	Reduced ¹	
			4183	Tested	
			4233	Reduced ¹	
		Remaining Sides			Reduced ²
All HSPA			Reduced ³		

Reduced¹ – When the mid channel is 3 dB below the limit, the remaining channels are not required per KDB 447498 D01 v06 section 4.3.3 page 14.

Reduced² – When the antenna is more than 25 mm from a side, the test can be reduced per KDB447498 D01 v06 section 4.3.1 1) page 11. See below for calculations.

Reduced³ – When the conducted power for HSPA \leq ¼ dB higher than WCDMA mode, SAR testing is reduced for HSPA per KDB941225 D01 v03r01 section 2.1 page 2.

Maximum power: 251.19 mW

Closest Distance to Left: 117.0 mm

Closest Distance to Bottom: 67.0 mm

Closest Distance to Top: 82 mm

The closest distance is from the bottom side. Therefore, if the bottom side is excluded the top and left sides would also be excluded.

$[\{(3.0)/(\sqrt{0.849})\} * 50 \text{ mm}] + \{67 - 50 \text{ mm}\} * 10 = 332 \text{ mW}$ which is greater than 251.19 mW

Figure 10.13 Test Reduction Table – 3G 1750 MHz

Band/ Frequency (MHz)	Technology	Side	Required Channel	Tested/ Reduced		
Band 4 1710-1755 MHz	WCDMA	Back	1312	Tested		
			1413	Tested		
			1513	Tested		
		Right	1312	Tested		
			1413	Tested		
			1513	Tested		
		Remaining Sides				Reduced ²
		All HSPA				Reduced ³

Reduced¹ – When the mid channel is 3 dB below the limit, the remaining channels are not required per KDB 447498 D01 v05r02 section 4.3.3 page 14.

Reduced² – When the antenna is more than 25 mm from a side, the test can be reduced per KDB447498 D01 v05r02 section 4.3.1 1) page 11. See below for calculations.

Reduced³ – When the conducted power for HSPA ≤ ¼ dB higher than WCDMA mode, SAR testing is reduced for HSPA per KDB941225 D01 v03r01 section 2.1 page 2.

Maximum power: 79.43 mW
 Closest Distance to Left: 117.0 mm
 Closest Distance to Bottom: 67.0 mm
 Closest Distance to Top: 82 mm

The closest distance is from the bottom side. Therefore, if the bottom side is excluded the top and left sides would also be excluded.

$$[{\frac{3.0}{\sqrt{1.755}}}] * 50 \text{ mm}] + [67 - 50 \text{ mm}] * 10 = 283 \text{ mW}$$

which is greater than 79.43 mW

Figure 10.14 Test Reduction Table – 3G 1900 MHz

Band/ Frequency (MHz)	Technology	Side	Required Channel	Tested/ Reduced		
Band 2 1850-1910 MHz	CDMA	Back	25	Tested		
			600	Tested		
			1175	Tested		
		Right	25	Tested		
			600	Tested		
			1175	Tested		
		Remaining Sides			Reduced ²	
		GSM	Back	512	Tested	
				661	Tested	
	810			Tested		
	Right		512	Reduced ¹		
			661	Tested		
			810	Reduced ¹		
	Remaining Sides			Reduced ²		
	WCDMA	Back	9262	Tested		
			9400	Tested		
			9538	Tested		
		Right	9262	Tested		
			9400	Tested		
			9538	Tested		
		Remaining Sides			Reduced ²	
All HSPA			Reduced ³			

Reduced¹ – When the mid channel is 3 dB below the limit, the remaining channels are not required per KDB 447498 D01 v05r02 section 4.3.3 page 14.

Reduced² – When the antenna is more than 25 mm from a side, the test can be reduced per KDB447498 D01 v05r02 section 4.3.1 1) page 11. See below for calculations.

Reduced³ – When the conducted power for HSPA ≤ ¼ dB higher than WCDMA mode, SAR testing is reduced for HSPA per KDB941225 D01 v03r01 section 2.1 page 2.

Maximum power: 79.43 mW
 Closest Distance to Left: 117.0 mm
 Closest Distance to Bottom: 67.0 mm
 Closest Distance to Top: 82 mm

The closest distance is from the bottom side. Therefore, if the bottom side is excluded the top and left sides would also be excluded.

$$[{\{(3.0)/(\sqrt{1.91})\} * 50 \text{ mm}}] + {\{67 - 50\} * 10} = 278 \text{ mW which is greater than } 79.43 \text{ mW}$$

Figure 10.15 Test Reduction Table –900 MHz RFID – MS2 Micro

Band/ Frequency (MHz)	Technology	Side	Required Frequency	Tested/ Reduced	
917.4-927.2 MHz	FHSS	Back	917.4	Tested	
			922.3	Tested	
			927.2	Tested	
		Left	922.3	Tested	
			Right	922.3	Tested
			Top	922.3	Tested
			Bottom	922.3	Reduced ¹

Reduced¹ – When the antenna is more than 25 mm from a side, the test can be reduced per KDB447498 D01 v05r02 section 4.3.1 1) page 11. See below for calculations.

Maximum power: 100 mW
 Closest Distance to Bottom: 160.8 mm

$$[[(3.0)/(\sqrt{0.928}) * 50 \text{ mm}]] + [(160.8 - 50 \text{ mm}) * 10] = 1263 \text{ mW}$$

which is greater than 100 mW

10.5 SAR Measurement Conditions for LTE Bands

10.5.1 LTE Functionality

The follow table identifies all the channel bandwidths in each frequency band supported by this device.

LTE Band Class	Bandwidth (MHz)	Frequency or Freq. Band (MHz)
2	1.4, 3, 5, 10, 15, 20	1850-1910 MHz
4	1.4, 3, 5, 10, 15, 20	1710-1755 MHz
5	5, 10	824-849 MHz
13	5, 10	777-787 MHz
17	5, 10	704-716 MHz

10.5.2 Test Conditions

All SAR measurements for LTE were performed using the Anritsu MT8820C. A closed loop power control setting allowed the UE to transmit at the maximum output power during the SAR measurements. The Figure 11.1 table indicates all the test reduction utilized for this report.

MPR was enabled for this device. A-MPR was disabled for all SAR test measurements.

Table 10.5.1 LTE Power Measurements

Band	Modulation	Bandwidth	RB Size	RB Offset	Channel	Frequency	Power
2	QPSK	1.4 MHz	6	0	18607	1850.7	17.95
					18900	1880	18.20
					19193	1909.3	17.19
			3	1	18607	1850.7	19.00
					18900	1880	19.00
					19193	1909.3	18.70
			1	0	18607	1850.7	19.00
					18900	1880	18.61
					19193	1909.3	18.85
		1	5	18607	1850.7	18.99	
				18900	1880	19.00	
				19193	1909.3	18.99	
		3 MHz	15	0	18615	1851.5	18.01
					18900	1880	18.11
					19185	1908.5	17.91
			8	3	18615	1851.5	17.95
					18900	1880	18.05
					19185	1908.5	17.81
			1	0	18615	1851.5	19.00
					18900	1880	18.74
					19185	1908.5	18.99
		1	14	18615	1851.5	18.99	
				18900	1880	18.73	
				19185	1908.5	19.00	
		5 MHz	25	0	18625	1852.5	17.93
					18900	1880	17.98
					19175	1907.5	17.92
			12	6	18625	1852.5	17.83
					18900	1880	18.13
					19175	1907.5	17.88
			1	0	18625	1852.5	18.95
					18900	1880	18.56
					19175	1907.5	18.32
		1	24	18625	1852.5	18.45	
				18900	1880	18.36	
				19175	1907.5	18.98	

Band	Modulation	Bandwidth	RB Size	RB Offset	Channel	Frequency	Power
2	QPSK	10 MHz	50	0	18650	1855	17.52
					18900	1880	17.55
					19150	1905	17.57
			25	12	18650	1855	17.30
					18900	1880	17.95
					19150	1905	17.42
			1	0	18650	1855	18.95
					18900	1880	18.30
					19150	1905	18.23
		1	24	18650	1855	18.46	
				18900	1880	19.00	
				19150	1905	18.35	
		15 MHz	75	0	18675	1857.5	17.38
					18900	1880	17.51
					19125	1902.5	17.46
			36	19	18675	1857.5	17.16
					18900	1880	17.86
					19125	1902.5	17.31
			1	0	18675	1857.5	18.89
					18900	1880	18.38
					19125	1902.5	18.42
		1	74	18675	1857.5	18.48	
				18900	1880	18.31	
				19125	1902.5	19.00	
		20 MHz	100	0	18625	1852.5	17.50
					18900	1880	17.52
					19175	1907.5	17.40
			50	25	18700	1860	17.89
					18900	1880	17.91
					19100	1900	17.92
			1	0	18700	1860	18.98
					18900	1880	18.97
					19100	1900	18.94
		1	99	18700	1860	18.33	
				18900	1880	18.35	
				19100	1900	18.43	

Band	Modulation	Bandwidth	RB Size	RB Offset	Channel	Frequency	Power
2	16QAM	1.4 MHz	6	0	18607	1850.7	16.96
					18900	1880	17.11
					19193	1909.3	16.92
			3	1	18607	1850.7	16.95
					18900	1880	17.14
					19193	1909.3	16.88
			1	0	18607	1850.7	16.94
					18900	1880	17.12
					19193	1909.3	16.91
		1	5	18607	1850.7	16.91	
				18900	1880	17.10	
				19193	1909.3	16.93	
		3 MHz	15	0	18615	1851.5	16.98
					18900	1880	17.14
					19185	1908.5	16.92
			8	3	18615	1851.5	16.76
					18900	1880	17.10
					19185	1908.5	16.82
			1	0	18615	1851.5	17.92
					18900	1880	17.63
					19185	1908.5	17.75
		1	14	18615	1851.5	17.69	
				18900	1880	17.39	
				19185	1908.5	17.74	
		5 MHz	25	0	18625	1852.5	17.01
					18900	1880	16.96
					19175	1907.5	17.01
			12	6	18625	1852.5	16.84
					18900	1880	17.21
					19175	1907.5	16.88
			1	0	18625	1852.5	17.79
					18900	1880	17.44
					19175	1907.5	17.37
		1	24	18625	1852.5	17.21	
				18900	1880	17.07	
				19175	1907.5	17.75	

Band	Modulation	Bandwidth	RB Size	RB Offset	Channel	Frequency	Power
2	16QAM	10 MHz	50	0	18650	1855	16.30
					18900	1880	16.62
					19150	1905	16.53
			25	12	18650	1855	16.17
					18900	1880	16.81
					19150	1905	16.42
			1	0	18650	1855	17.77
					18900	1880	17.19
					19150	1905	17.07
		1	24	18650	1855	17.24	
				18900	1880	17.96	
				19150	1905	17.25	
		15 MHz	75	0	18675	1857.5	16.35
					18900	1880	16.25
					19125	1902.5	16.46
			36	19	18675	1857.5	16.17
					18900	1880	16.64
					19125	1902.5	16.23
			1	0	18675	1857.5	17.79
					18900	1880	17.07
					19125	1902.5	17.21
		1	74	18675	1857.5	17.13	
				18900	1880	16.96	
				19125	1902.5	17.76	
		20 MHz	100	0	18625	1852.5	16.54
					18900	1880	16.50
					19175	1907.5	16.32
			50	25	18700	1860	16.39
					18900	1880	16.54
					19100	1900	16.16
			1	0	18700	1860	17.68
					18900	1880	17.38
					19100	1900	16.74
		1	99	18700	1860	17.01	
				18900	1880	16.71	
				19100	1900	17.68	

Band	Modulation	Bandwidth	RB Size	RB Offset	Channel	Frequency	Power
4	QPSK	1.4 MHz	6	0	19957	1710.7	18.67
					20175	1732.5	18.06
					20393	1754.3	18.61
			3	1	19957	1710.7	18.99
					20175	1732.5	19.00
					20393	1754.3	18.99
			1	0	19957	1710.7	18.98
					20175	1732.5	18.58
					20393	1754.3	18.99
			1	5	19957	1710.7	18.98
					20175	1732.5	18.93
					20393	1754.3	19.00
		3 MHz	15	0	19965	1711.5	18.11
					20175	1732.5	18.09
					20385	1753.5	18.15
			8	3	19965	1711.5	18.02
					20175	1732.5	17.93
					20385	1753.5	18.07
			1	0	19965	1711.5	19.00
					20175	1732.5	18.40
					20385	1753.5	18.53
			1	14	19965	1711.5	18.34
					20175	1732.5	18.99
					20385	1753.5	18.94
		5 MHz	25	0	19975	1712.5	17.49
					20175	1732.5	18.19
					20375	1752.5	17.87
			12	6	19975	1712.5	17.44
					20175	1732.5	18.13
					20375	1752.5	17.64
			1	0	19975	1712.5	18.99
					20175	1732.5	18.31
					20375	1752.5	18.67
			1	24	19975	1712.5	18.19
					20175	1732.5	19.00
					20375	1752.5	18.99

Band	Modulation	Bandwidth	RB Size	RB Offset	Channel	Frequency	Power
4	QPSK	10 MHz	50	0	20000	1715	17.36
					20175	1732.5	17.99
					20350	1750	17.80
			25	12	20000	1715	16.92
					20175	1732.5	18.04
					20350	1750	17.57
			1	0	20000	1715	19.00
					20175	1732.5	18.31
					20350	1750	18.60
			1	24	20000	1715	18.14
					20175	1732.5	18.92
					20350	1750	18.67
		15 MHz	75	0	20025	1717.5	17.29
					20175	1732.5	17.67
					20325	1747.5	17.62
			36	19	20025	1717.5	17.01
					20175	1732.5	18.17
					20325	1747.5	17.64
			1	0	20025	1717.5	18.99
					20175	1732.5	18.13
					20325	1747.5	18.38
			1	74	20025	1717.5	18.18
					20175	1732.5	18.45
					20325	1747.5	18.60
		20 MHz	100	0	20050	1720	17.23
					20175	1732.5	17.68
					20300	1745	17.52
			50	25	20050	1720	17.81
					20175	1732.5	18.00
					20300	1745	17.91
			1	0	20050	1720	19.00
					20175	1732.5	18.90
					20300	1745	18.98
			1	99	20050	1720	18.28
					20175	1732.5	18.56
					20300	1745	19.00

Band	Modulation	Bandwidth	RB Size	RB Offset	Channel	Frequency	Power
4	16QAM	1.4 MHz	6	0	19957	1710.7	17.51
					20175	1732.5	17.02
					20393	1754.3	17.52
			3	1	19957	1710.7	18.44
					20175	1732.5	17.90
					20393	1754.3	18.25
			1	0	19957	1710.7	18.39
					20175	1732.5	17.52
					20393	1754.3	18.25
			1	5	19957	1710.7	18.09
					20175	1732.5	18.05
					20393	1754.3	18.21
		3 MHz	15	0	19965	1711.5	17.12
					20175	1732.5	17.19
					20385	1753.5	17.22
			8	3	19965	1711.5	17.02
					20175	1732.5	17.05
					20385	1753.5	17.27
			1	0	19965	1711.5	18.20
					20175	1732.5	17.22
					20385	1753.5	17.51
			1	14	19965	1711.5	17.18
					20175	1732.5	18.32
					20385	1753.5	18.50
		5 MHz	25	0	19975	1712.5	16.53
					20175	1732.5	17.19
					20375	1752.5	16.94
			12	6	19975	1712.5	16.51
					20175	1732.5	17.00
					20375	1752.5	16.59
			1	0	19975	1712.5	18.40
					20175	1732.5	17.03
					20375	1752.5	17.33
			1	24	19975	1712.5	16.62
					20175	1732.5	18.26
					20375	1752.5	18.33

Band	Modulation	Bandwidth	RB Size	RB Offset	Channel	Frequency	Power
4	16QAM	10 MHz	50	0	20000	1715	16.37
					20175	1732.5	17.06
					20350	1750	16.69
			25	12	20000	1715	16.11
					20175	1732.5	16.96
					20350	1750	16.44
			1	0	20000	1715	18.35
					20175	1732.5	16.91
					20350	1750	17.26
		1	24	20000	1715	17.00	
				20175	1732.5	17.83	
				20350	1750	17.33	
		15 MHz	75	0	20025	1717.5	16.23
					20175	1732.5	16.58
					20325	1747.5	16.61
			36	19	20025	1717.5	16.13
					20175	1732.5	17.17
					20325	1747.5	16.55
			1	0	20025	1717.5	18.38
					20175	1732.5	16.79
					20325	1747.5	17.15
		1	74	20025	1717.5	16.96	
				20175	1732.5	17.32	
				20325	1747.5	18.19	
		20 MHz	100	0	20050	1720	16.30
					20175	1732.5	16.65
					20300	1745	16.57
			50	25	20050	1720	16.21
					20175	1732.5	17.12
					20300	1745	16.58
1	0		20050	1720	18.20		
			20175	1732.5	18.13		
			20300	1745	17.75		
1	99	20050	1720	16.94			
		20175	1732.5	17.35			
		20300	1745	18.24			

Band	Modulation	Bandwidth	RB Size	RB Offset	Channel	Frequency	Power
5	QPSK	5 MHz	25	0	20425	826.5	22.01
					20525	836.5	22.06
					20625	846.5	22.18
			12	6	20425	826.5	22.76
					20525	836.5	22.85
					20625	846.5	22.97
			1	0	20425	826.5	22.91
					20525	836.5	22.97
					20625	846.5	23.00
		1	24	20425	826.5	22.89	
				20525	836.5	23.00	
				20625	846.5	23.00	
		10 MHz	50	0	20450	829.0	22.01
					20525	836.5	22.05
					20600	844.0	22.11
			25	12	20450	829.0	22.87
					20525	836.5	22.91
					20600	844.0	22.93
			1	0	20450	829.0	22.96
					20525	836.5	22.97
					20600	844.0	23.00
1	24	20450	829.0	22.89			
		20525	836.5	22.94			
		20600	844.0	23.00			

Band	Modulation	Bandwidth	RB Size	RB Offset	Channel	Frequency	Power
5	16QAM	5 MHz	25	0	20425	826.5	20.12
					20525	836.5	20.08
					20625	846.5	20.16
			12	6	20425	826.5	21.89
					20525	836.5	21.92
					20625	846.5	21.99
			1	0	20425	826.5	21.96
					20525	836.5	21.98
					20625	846.5	22.13
			1	24	20425	826.5	21.92
					20525	836.5	22.16
					20625	846.5	22.33
		10 MHz	50	0	20450	829.0	20.08
					20525	836.5	20.10
					20600	844.0	20.16
			25	12	20450	829.0	21.92
					20525	836.5	21.97
					20600	844.0	21.96
			1	0	20450	829.0	21.98
					20525	836.5	21.99
					20600	844.0	22.11
			1	24	20450	829.0	21.93
					20525	836.5	21.97
					20600	844.0	22.15

Band	Modulation	Bandwidth	RB Size	RB Offset	Channel	Frequency	Power
13	QPSK	5 MHz	25	0	23230	782.0	22.23
			12	6	23230	782.0	22.24
			1	0	23230	782.0	23.00
			1	24	23230	782.0	23.00
		10 MHz	50	0	23230	782.0	22.19
			25	12	23230	782.0	23.00
			1	0	23230	782.0	23.00
			1	24	23230	782.0	23.00
	16QAM	5 MHz	25	0	23230	782.0	20.32
			12	6	23230	782.0	22.11
			1	0	23230	782.0	22.26
			1	24	23230	782.0	22.22
		10 MHz	50	0	23230	782.0	20.29
			25	12	23230	782.0	22.10
			1	0	23230	782.0	22.20
			1	24	23230	782.0	22.29

Band	Modulation	Bandwidth	RB Size	RB Offset	Channel	Frequency	Power
17	QPSK	5 MHz	25	0	23755	706.5	22.19
					23790	710.0	22.20
					23825	713.5	22.15
			12	6	23755	706.5	23.00
					23790	710.0	23.00
					23825	713.5	23.00
			1	0	23755	706.5	23.00
					23790	710.0	23.00
					23825	713.5	23.00
			1	24	23755	706.5	23.00
					23790	710.0	23.00
					23825	713.5	23.00
		10 MHz	50	0	23780	709.0	22.08
					23790	710.0	22.15
					23800	711.0	22.21
			25	12	23780	709.0	23.00
					23790	710.0	23.00
					23800	711.0	23.00
			1	0	23780	709.0	23.00
					23790	710.0	23.00
					23800	711.0	23.00
			1	24	23780	709.0	23.00
					23790	710.0	23.00
					23800	711.0	23.00

Band	Modulation	Bandwidth	RB Size	RB Offset	Channel	Frequency	Power
17	16QAM	5 MHz	25	0	23755	706.5	20.29
					23790	710.0	20.23
					23775	713.5	20.19
			12	6	23755	706.5	22.10
					23790	710.0	22.08
					23775	713.5	22.13
			1	0	23755	706.5	22.18
					23790	710.0	22.24
					23775	713.5	22.26
			1	24	23755	706.5	22.29
					23790	710.0	22.18
					23775	713.5	22.27
		10 MHz	50	0	23780	709.0	20.14
					23790	710.0	20.26
					23800	711.0	20.30
			25	12	23780	709.0	22.05
					23790	710.0	22.08
					23800	711.0	22.14
			1	0	23780	709.0	22.07
					23790	710.0	22.18
					23800	711.0	22.15
			1	24	23780	709.0	22.22
					23790	710.0	22.27
					23800	711.0	22.20

Table 10.5.2 Test Reduction Table – LTE

Band/ Frequency (MHz)	Side	Required Test Channel	Bandwidth	Modulation	RB Allocation	RB Offset	Tested/ Reduced				
Band 2 1850-1910 MHz	Back	18700	20 MHz	QPSK	50	0	Tested				
		18900					Tested				
		19100					Tested				
		18700			100	0	Reduced ¹				
		18900					Reduced ¹				
		19100					Reduced ¹				
		18700			1	0	Tested				
		18900					Tested				
		19100					Tested				
		18700		99	0	Reduced ²					
		18900				Reduced ²					
		19100				Reduced ²					
		18700		50	25	16QAM	50	25	Reduced ³		
		18900							Reduced ³		
		19100							Reduced ³		
		18700		100	0	16QAM	100	0	Reduced ¹		
		18900							Reduced ¹		
		19100							Reduced ¹		
		18700		1	0	16QAM	1	0	Reduced ⁴		
		18900							Reduced ⁴		
		19100							Reduced ⁴		
	18700	99	0	16QAM	1	99	Reduced ⁴				
	18900						Reduced ⁴				
	19100						Reduced ⁴				
	All lower bandwidths (15 MHz, 10 MHz, 5 MHz, 3 MHz, 1.4 MHz)							Reduced ⁵			
	Back	Right	18700	20 MHz	QPSK	50	25	Tested			
			18900					Tested			
			19100					Tested			
			18700			100	0	QPSK	100	0	Reduced ¹
			18900								Reduced ¹
			19100								Reduced ¹
			18700			1	0	QPSK	1	0	Tested
			18900								Tested
			19100								Tested
			18700		99	0	QPSK	1	99	Reduced ²	
			18900							Reduced ²	
			19100							Reduced ²	
			18700		50	25	16QAM	50	25	Reduced ³	
			18900							Reduced ³	
			19100							Reduced ³	
			18700		100	0	16QAM	100	0	Reduced ¹	
			18900							Reduced ¹	
19100			Reduced ¹								
18700			1		0	16QAM	1	0	Reduced ⁴		
18900									Reduced ⁴		
19100									Reduced ⁴		
18700	99	0	16QAM	1	99	Reduced ⁴					
18900						Reduced ⁴					
19100						Reduced ⁴					
All lower bandwidths (15 MHz, 10 MHz, 5 MHz, 3 MHz, 1.4 MHz)							Reduced ⁵				
All remaining sides							Reduced ⁶				

Reduced¹ – If the SAR value in the 50% RB testing is less than 1.45 W/kg, the 100% RB testing is reduced per KDB941225 D05 3) A) I) page 4.
 Reduced² - If the SAR value in the 1 RB testing is less than 1.45 W/kg, the remaining channels are reduced per KDB941225 D05 3) B) I) page 4.
 Reduced³ - If the SAR value in the 50% RB testing is less than 1.45 W/kg, the remaining channels are reduced per KDB941225 D05 4) A) I) page 4.
 Reduced⁴ - If the SAR value in the 1 RB testing is less than 1.45 W/kg, the remaining channels are reduced per KDB941225 D05 4) B) I) page 5.
 Reduced⁵ - If the conducted power is within ±0.5 dB, all testing where the SAR value is less than 1.45 W/kg is reduced per KDB941225 D05 5) B) I) page 5.
 Reduced⁶ – When the antenna is more than 25 mm from a side, the test can be reduced per KDB447498 D01 v06 section 4.3.1 1) page 11. See below for calculations.

Maximum power: 79.43 mW
 Closest Distance to Left: 117.0 mm
 Closest Distance to Bottom: 67.0 mm
 Closest Distance to Top: 82 mm

The closest distance is from the bottom side. Therefore, if the bottom side is excluded the top and left sides would also be excluded.

$$[[[(3.0)/(\sqrt{1.91})]*50 \text{ mm}]]+[(67-50 \text{ mm})*10]=278 \text{ mW which is greater than } 79.43 \text{ mW}$$

Band/ Frequency (MHz)	Side	Required Test Channel	Bandwidth	Modulation	RB Allocation	RB Offset	Tested/ Reduced	
Band 4 1710-1755 MHz	Back	18700	20 MHz	QPSK	50	25	Tested	
		18900					Tested	
		19100					Tested	
		18700			100	0	Reduced ¹	
		18900					Reduced ¹	
		19100					Reduced ¹	
		18700			1	0	Tested	
		18900					Tested	
		19100					Tested	
		18700			99	99	Reduced ²	
		18900					Reduced ²	
		19100					Reduced ²	
		18700		50	25	Reduced ³		
		18900				Reduced ³		
		19100				Reduced ³		
		18700		100	0	Reduced ¹		
		18900				Reduced ¹		
		19100				Reduced ¹		
		18700		1	0	Reduced ⁴		
		18900				Reduced ⁴		
		19100				Reduced ⁴		
		18700		99	99	Reduced ⁴		
		18900				Reduced ⁴		
		19100				Reduced ⁴		
	All lower bandwidths (15 MHz, 10 MHz, 5 MHz, 3 MHz, 1.4 MHz)							Reduced ⁵
	Right	QPSK	18700	20 MHz	50	25	Tested	
			18900				Tested	
			19100				Tested	
			18700		100	0	Reduced ¹	
			18900				Reduced ¹	
			19100				Reduced ¹	
			18700		1	0	Tested	
			18900				Tested	
			19100				Tested	
			18700		99	99	Reduced ²	
			18900				Reduced ²	
			19100				Reduced ²	
		18700	50		25	Reduced ³		
		18900				Reduced ³		
		19100				Reduced ³		
		18700	100		0	Reduced ¹		
		18900				Reduced ¹		
		19100				Reduced ¹		
		18700	1		0	Reduced ⁴		
		18900				Reduced ⁴		
		19100				Reduced ⁴		
		18700	99		99	Reduced ⁴		
		18900				Reduced ⁴		
19100		Reduced ⁴						
All lower bandwidths (15 MHz, 10 MHz, 5 MHz, 3 MHz, 1.4 MHz)							Reduced ⁵	
All remaining sides							Reduced ⁶	

Reduced¹ - If the SAR value in the 50% RB testing is less than 1.45 W/kg, the 100% RB testing is reduced per KDB941225 D05 3) A) I) page 4.
 Reduced² - If the SAR value in the 1 RB testing is less than 1.45 W/kg, the remaining channels are reduced per KDB941225 D05 3) B) I) page 4.
 Reduced³ - If the SAR value in the 50% RB testing is less than 1.45 W/kg, the remaining channels are reduced per KDB941225 D05 4) A) I) page 4.
 Reduced⁴ - If the SAR value in the 1 RB testing is less than 1.45 W/kg, the remaining channels are reduced per KDB941225 D05 4) B) I) page 5.
 Reduced⁵ - If the conducted power is within ±0.5 dB, all testing where the SAR value is less than 1.45 W/kg is reduced per KDB941225 D05 5) B) I) page 5.
 Reduced⁶ - When the antenna is more than 25 mm from a side, the test can be reduced per KDB447498 D01 v06 section 4.3.1 1) page 11. See below for calculations.

Maximum power: 79.43 mW
 Closest Distance to Left: 117.0 mm
 Closest Distance to Bottom: 67.0 mm
 Closest Distance to Top: 82 mm

The closest distance is from the bottom side. Therefore, if the bottom side is excluded the top and left sides would also be excluded.

$$[[[(3.0)/(\sqrt{1.755})]*50 \text{ mm}]]+[[67-50 \text{ mm}]*10]=283 \text{ mW which is greater than } 79.43 \text{ mW}$$

Band/ Frequency (MHz)	Side	Required Test Channel	Bandwidth	Modulation	RB Allocation	RB Offset	Tested/ Reduced	
Band 5 824-849 MHz	Back	20450	10 MHz	QPSK	25	12	Tested	
		20525					Tested	
		20600					Tested	
		20450			50	0	Reduced ¹	
		20525					Reduced ¹	
		20600					Reduced ¹	
		20450			1	0	Tested	
		20525					Tested	
		20600					Tested	
		20450			1	24	Reduced ²	
		20525					Reduced ²	
		20600					Reduced ²	
		20450		25	12	Reduced ³		
		20525				Reduced ³		
		20600				Reduced ³		
		20450		50	0	Reduced ¹		
		20525				Reduced ¹		
		20600				Reduced ¹		
		20450		1	0	Reduced ⁴		
		20525				Reduced ⁴		
		20600				Reduced ⁴		
		20450		1	24	Reduced ⁴		
		20525				Reduced ⁴		
		20600				Reduced ⁴		
	All lower bandwidths (5 MHz)							Reduced ⁵
	All remaining sides							Reduced ⁵
	Right	QPSK	20450	10 MHz	QPSK	25	12	Tested
			20525					Reduced ⁵
			20600					Reduced ⁵
			20450			50	0	Reduced ¹
			20525					Reduced ¹
			20600					Reduced ¹
			20450			1	0	Reduced ⁶
			20525					Tested
			20600					Reduced ⁶
			20450			1	24	Reduced ²
			20525					Reduced ²
			20600					Reduced ²
		20450	25		12	Reduced ³		
		20525				Reduced ³		
		20600				Reduced ³		
		20450	50		0	Reduced ¹		
		20525				Reduced ¹		
		20600				Reduced ¹		
		20450	1		0	Reduced ⁴		
		20525				Reduced ⁴		
		20600				Reduced ⁴		
		20450	1		24	Reduced ⁴		
20525		Reduced ⁴						
20600		Reduced ⁴						
All lower bandwidths (5 MHz)							Reduced ⁵	
All remaining sides							Reduced ⁷	

Reduced¹ - If the SAR value in the 50% RB testing is less than 1.45 W/kg, the 100% RB testing is reduced per KDB941225 D05 3) A) I) page 4.
 Reduced² - If the SAR value in the 1 RB testing is less than 1.45 W/kg, the remaining channels are reduced per KDB941225 D05 3) B) I) page 4.
 Reduced³ - If the SAR value in the 50% RB testing is less than 1.45 W/kg, the remaining channels are reduced per KDB941225 D05 4) A) I) page 4.
 Reduced⁴ - If the SAR value in the 1 RB testing is less than 1.45 W/kg, the remaining channels are reduced per KDB941225 D05 4) B) I) page 5.
 Reduced⁵ - If the conducted power is within ±0.5 dB, all testing where the SAR value is less than 1.45 W/kg is reduced per KDB941225 D05 5) B) I) page 5.
 Reduced⁶ - If the SAR value measured on the middle channel is less than 0.8 W/kg and the conducted power is within ±0.5 dB, the remaining channels are reduced per KDB941225 D05 page 4 footnote 2.
 Reduced⁷ - When the antenna is more than 25 mm from a side, the test can be reduced per KDB447498 D01 v06 section 4.3.1 1) page 11. See below for calculations.

Maximum power: 199.53 mW
 Closest Distance to Left: 117.0 mm
 Closest Distance to Bottom: 67.0 mm
 Closest Distance to Top: 82 mm

The closest distance is from the bottom side. Therefore, if the bottom side is excluded the top and left sides would also be excluded.

$$[[[(3.0)/(\sqrt{0.849})]*50 \text{ mm}]]+[(67-50 \text{ mm})*10]=332 \text{ mW which is greater than } 199.53 \text{ mW}$$

Band/ Frequency (MHz)	Side	Required Test Channel	Bandwidth	Modulation	RB Allocation	RB Offset	Tested/ Reduced	
Band 13 777-787 MHz	Back	23095	10 MHz	QPSK	25	12	Tested	
		23095			50	0	Reduced ¹	
		23095			1	0	Tested	
		23095				24	Reduced ²	
		23095		16QAM	25	12	Reduced ³	
		23095			50	0	Reduced ¹	
		23095			1	0	Reduced ⁴	
		23095				24	Reduced ⁴	
	All lower bandwidths (5 MHz)							Reduced ⁵
	Right	Right	23095	10 MHz	QPSK	25	12	Tested
			23095			50	0	Reduced ¹
			23095			1	0	Tested
			23095				24	Reduced ²
			23095		16QAM	25	12	Reduced ³
			23095			50	0	Reduced ¹
			23095			1	0	Reduced ⁴
			23095				24	Reduced ⁴
	All lower bandwidths (5 MHz)							Reduced ⁵
	All remaining sides							Reduced ⁷

Reduced¹ - If the SAR value in the 50% RB testing is less than 1.45 W/kg, the 100% RB testing is reduced per KDB941225 D05 3) A) I) page 4.

Reduced² - If the SAR value in the 1 RB testing is less than 1.45 W/kg, the remaining channels are reduced per KDB941225 D05 3) B) I) page 4.

Reduced³ - If the SAR value in the 50% RB testing is less than 1.45 W/kg, the remaining channels are reduced per KDB941225 D05 4) A) I) page 4.

Reduced⁴ - If the SAR value in the 1 RB testing is less than 1.45 W/kg, the remaining channels are reduced per KDB941225 D05 4) B) I) page 5.

Reduced⁵ - If the conducted power is within ±0.5 dB, all testing where the SAR value is less than 1.45 W/kg is reduced per KDB941225 D05 5) B) I) page 5.

Reduced⁶ - If the SAR value measured on the middle channel is less than 0.8 W/kg and the conducted power is within ±0.5 dB, the remaining channels are reduced per KDB941225 D05 page 4 footnote 2.

Reduced⁷ - When the antenna is more than 25 mm from a side, the test can be reduced per KDB447498 D01 v06 section 4.3.1 1) page 11. See below for calculations.

Maximum power: 199.53 mW
 Closest Distance to Left: 117.0 mm
 Closest Distance to Bottom: 67.0 mm
 Closest Distance to Top: 82 mm

The closest distance is from the bottom side. Therefore, if the bottom side is excluded the top and left sides would also be excluded.

$$[[{(3.0)/(\sqrt{0.787})]*50 \text{ mm}}]+[(67-50 \text{ mm})*10]=339 \text{ mW which is greater than } 199.53 \text{ mW}$$

Band/ Frequency (MHz)	Side	Required Test Channel	Bandwidth	Modulation	RB Allocation	RB Offset	Tested/ Reduced	
Band 17 704-716 MHz	Back	23780	10 MHz	QPSK	25	12	Tested	
		23790					Tested	
		23800					Tested	
		23780			50	0	Reduced ¹	
		23790					Reduced ¹	
		23800					Reduced ¹	
		23780			1	0	Tested	
		23790					Tested	
		23800					Tested	
		23780			1	24	Reduced ²	
		23790					Reduced ²	
		23800					Reduced ²	
		23780		25	12	Reduced ³		
		23790				Reduced ³		
		23800				Reduced ³		
		23780		50	0	Reduced ¹		
		23790				Reduced ¹		
		23800				Reduced ¹		
		23780		1	0	Reduced ⁴		
		23790				Reduced ⁴		
		23800				Reduced ⁴		
		23780		1	24	Reduced ⁴		
		23790				Reduced ⁴		
		23800				Reduced ⁴		
	All lower bandwidths (5 MHz)							Reduced ⁵
	Right	QPSK	23780	10 MHz	QPSK	25	12	Reduced ⁶
			23790					Tested
			23800					Reduced ⁶
			23780			50	0	Reduced ¹
			23790					Reduced ¹
			23800					Reduced ¹
			23780			1	0	Reduced ⁶
			23790					Tested
			23800					Reduced ⁶
			23780			1	24	Reduced ²
			23790					Reduced ²
			23800					Reduced ²
		23780	25		12	Reduced ³		
		23790				Reduced ³		
		23800				Reduced ³		
		23780	50		0	Reduced ¹		
		23790				Reduced ¹		
		23800				Reduced ¹		
		23780	1		0	Reduced ⁴		
		23790				Reduced ⁴		
		23800				Reduced ⁴		
		23780	1		24	Reduced ⁴		
		23790				Reduced ⁴		
23800		Reduced ⁴						
All lower bandwidths (5 MHz)							Reduced ⁵	
All remaining sides							Reduced ⁷	

Reduced¹ - If the SAR value in the 50% RB testing is less than 1.45 W/kg, the 100% RB testing is reduced per KDB941225 D05 3) A) I) page 4.
 Reduced² - If the SAR value in the 1 RB testing is less than 1.45 W/kg, the remaining channels are reduced per KDB941225 D05 3) B) I) page 4.
 Reduced³ - If the SAR value in the 50% RB testing is less than 1.45 W/kg, the remaining channels are reduced per KDB941225 D05 4) A) I) page 4.
 Reduced⁴ - If the SAR value in the 1 RB testing is less than 1.45 W/kg, the remaining channels are reduced per KDB941225 D05 4) B) I) page 5.
 Reduced⁵ - If the conducted power is within ±0.5 dB, all testing where the SAR value is less than 1.45 W/kg is reduced per KDB941225 D05 5) B) I) page 5.
 Reduced⁶ - If the SAR value measured on the middle channel is less than 0.8 W/kg and the conducted power is within ±0.5 dB, the remaining channels are reduced per KDB941225 D05 page 4 footnote 2.
 Reduced⁷ - When the antenna is more than 25 mm from a side, the test can be reduced per KDB447498 D01 v06 section 4.3.1 1) page 11. See below for calculations.

Maximum power: 199.53 mW
 Closest Distance to Left: 117.0 mm
 Closest Distance to Bottom: 67.0 mm
 Closest Distance to Top: 82 mm

The closest distance is from the bottom side. Therefore, if the bottom side is excluded the top and left sides would also be excluded.

$$[(((3.0)/(\sqrt{0.716})) * 50 \text{ mm})] + [(67 - 50 \text{ mm}) * 10] = 347 \text{ mW which is greater than } 199.53 \text{ mW}$$

SAR Data Summary – 750 MHz Body – LTE Band 17

MEASUREMENT RESULTS

Gap	Plot	Position	Frequency		BW/ Modulation	RB Size	RB Offset	MPR Target	End Power (dBm)	Measured SAR (W/kg)	Reported SAR (W/kg)
			MHz	Ch.							
0 mm	1	Back	710.0	23790	10 MHz/QPSK	1	0	0	23.00	0.392	0.39
	-----		710.0	23790	10 MHz/QPSK	25	12	1	23.00	0.218	0.22
	-----	Right	710.0	23790	10 MHz/QPSK	1	0	0	23.00	0.147	0.15
	-----		710.0	23790	10 MHz/QPSK	25	0	1	23.00	0.120	0.12

Body
1.6 W/kg (mW/g)
averaged over 1 gram

1. SAR Measurement
 Phantom Configuration Left Head Eli4 Right Head
 SAR Configuration Head Body
2. Test Signal Call Mode Test Code Base Station Simulator
3. Test Configuration With Belt Clip Without Belt Clip N/A
4. Tissue Depth is at least 15.0 cm



Jay M. Moulton
Vice President

SAR Data Summary – 750 MHz Body – LTE Band 13

MEASUREMENT RESULTS

Gap	Plot	Position	Frequency		BW/ Modulation	RB Size	RB Offset	MPR Target	End Power (dBm)	Measured SAR (W/kg)	Reported SAR (W/kg)
			MHz	Ch.							
0 mm	2	Back	782.0	23230	10 MHz/QPSK	1	0	0	23.00	0.721	0.72
	----		782.0	23230	10 MHz/QPSK	25	12	1	23.00	0.577	0.58
	----	Right	782.0	23230	10 MHz/QPSK	1	0	0	23.00	0.572	0.57
	----		782.0	23230	10 MHz/QPSK	25	0	1	23.00	0.458	0.46

Body
1.6 W/kg (mW/g)
averaged over 1 gram

1. SAR Measurement
 Phantom Configuration Left Head Eli4 Right Head
 SAR Configuration Head Body
 Test Signal Call Mode Test Code Base Station Simulator
 Test Configuration With Belt Clip Without Belt Clip N/A
4. Tissue Depth is at least 15.0 cm



Jay M. Moulton
Vice President

SAR Data Summary – 835 MHz Body - CDMA

MEASUREMENT RESULTS

Gap	Plot	Frequency		Modulation	Position	End Power (dBm)	Reverse Channel	Forward Channel	Measured SAR (W/kg)	Reported SAR (W/kg)
		MHz	Ch.							
0 mm	3	817.25	450	CDMA	Back	23.40	153.6 kbps	2 Slot 307.2 kbps	1.11	1.27
	----	833.01	267	CDMA		23.35	153.6 kbps	2 Slot 307.2 kbps	1.00	1.16
	----	848.31	777	CDMA		23.40	153.6 kbps	2 Slot 307.2 kbps	0.893	1.03
	----	833.01	267	CDMA	Right	23.35	153.6 kbps	2 Slot 307.2 kbps	0.597	0.69
	----	817.25	450	CDMA	Repeat	23.40	153.6 kbps	2 Slot 307.2 kbps	1.08	1.24

Body
1.6 W/kg (mW/g)
 averaged over 1 gram

1. SAR Measurement
 Phantom Configuration Left Head Eli4 Right Head
 SAR Configuration Head Body
2. Test Signal Call Mode Test Code Base Station Simulator
3. Test Configuration With Belt Clip Without Belt Clip N/A
4. Tissue Depth is at least 15.0 cm



Jay M. Moulton
 Vice President

SAR Data Summary – 835 MHz Body - GPRS

MEASUREMENT RESULTS

Gap	Plot	Frequency		Rev Level/ Modulation	Position	End Power (dBm)	TX Level	Multislot Configuration	Measured SAR (W/kg)	Reported SAR (W/kg)
		MHz	Ch.							
0 mm	4	824.2	128	GMSK	Back	29.87	5	2 Slot	1.16	1.20
	----	836.6	190	GMSK		29.87	5	2 Slot	1.09	1.12
	----	848.8	251	GMSK		29.85	5	2 Slot	0.945	0.98
	----	836.6	190	GMSK	Right	29.87	5	2 Slot	0.583	0.60
	----	824.2	128	GMSK	Repeat	29.87	5	2 Slot	1.11	1.14

Body
1.6 W/kg (mW/g)
 averaged over 1 gram

1. SAR Measurement
 - Phantom Configuration Left Head Eli4 Right Head
 - SAR Configuration Head Body
2. Test Signal Call Mode Test Code Base Station Simulator
3. Test Configuration With Belt Clip Without Belt Clip N/A
4. Tissue Depth is at least 15.0 cm

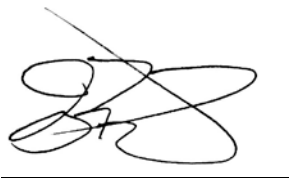

Jay M. Moulton
 Vice President

SAR Data Summary – 835 MHz Body – LTE Band 5

MEASUREMENT RESULTS											
Gap	Plot	Position	Frequency		BW/ Modulation	RB Size	RB Offset	MPR Target	End Power (dBm)	Measured SAR (W/kg)	Reported SAR (W/kg)
			MHz	Ch.							
0 mm	----	Back	829.0	20450	10 MHz/QPSK	1	0	0	22.91	0.812	0.83
	----		829.0	20450	10 MHz/QPSK	25	0	1	22.76	0.718	0.76
	6		836.5	20525	10 MHz/QPSK	1	0	0	22.97	0.885	0.89
	----		836.5	20525	10 MHz/QPSK	25	0	1	22.85	0.712	0.74
	----		844.0	20600	10 MHz/QPSK	1	0	0	23.00	0.830	0.83
	----		844.0	20600	10 MHz/QPSK	25	0	1	22.97	0.671	0.68
	----	Right	836.5	20525	10 MHz/QPSK	1	0	0	22.97	0.530	0.53
	----		836.5	20525	10 MHz/QPSK	25	0	1	22.85	0.403	0.42
	----	Repeat	836.5	20525	10 MHz/QPSK	1	0	0	22.97	0.846	0.85

Body
1.6 W/kg (mW/g)
 averaged over 1 gram

1. SAR Measurement
 - Phantom Configuration Left Head Eli4 Right Head
 - SAR Configuration Head Body
2. Test Signal Call Mode Test Code Base Station Simulator
3. Test Configuration With Belt Clip Without Belt Clip N/A
4. Tissue Depth is at least 15.0 cm



Jay M. Moulton
Vice President

SAR Data Summary – 1750 MHz Body - WCDMA

MEASUREMENT RESULTS

Gap	Plot	Frequency		Rev Level/ Modulation	Position	End Power (dBm)	RMC	Test Set Up	Measured SAR (W/kg)	Reported SAR (W/kg)
		MHz	Ch.							
0 mm	----	1712.4	1312	WCDMA	Back	18.88	12.2 kbps	Test Loop 1	1.24	1.28
	7	1732.6	1413	WCDMA		18.90	12.2 kbps	Test Loop 1	1.27	1.30
	----	1752.6	1513	WCDMA		18.95	12.2 kbps	Test Loop 1	1.18	1.19
	----	1712.4	1312	WCDMA	Right	18.88	12.2 kbps	Test Loop 1	0.815	0.84
	----	1732.6	1413	WCDMA		18.90	12.2 kbps	Test Loop 1	0.882	0.90
	----	1752.6	1513	WCDMA		18.95	12.2 kbps	Test Loop 1	0.864	0.87
	----	1732.6	1413	WCDMA	Repeat	18.90	12.2 kbps	Test Loop 1	1.25	1.28

Body
1.6 W/kg (mW/g)
 averaged over 1 gram

1. SAR Measurement
 Phantom Configuration Left Head Eli4 Right Head
 SAR Configuration Head Body
2. Test Signal Call Mode Test Code Base Station Simulator
3. Test Configuration With Belt Clip Without Belt Clip N/A
4. Tissue Depth is at least 15.0 cm



Jay M. Moulton
 Vice President

SAR Data Summary – 1750 MHz Body – LTE Band 4

MEASUREMENT RESULTS											
Gap	Plot	Position	Frequency		BW/ Modulation	RB Size	RB Offset	MPR Target	End Power (dBm)	Measured SAR (W/kg)	Reported SAR (W/kg)
			MHz	Ch.							
0 mm	----	Back	1720.0	20050	20 MHz/QPSK	1	0	0	19.00	1.12	1.12
	----		1720.0	20050	20 MHz/QPSK	50	0	1	17.81	1.13	1.18
	8		1732.5	20175	20 MHz/QPSK	1	0	0	18.90	1.24	1.27
	----		1732.5	20175	20 MHz/QPSK	50	0	1	18.00	1.13	1.13
	----		1745.0	20300	20 MHz/QPSK	1	0	0	18.98	1.16	1.17
	----		1745.0	20300	20 MHz//QPSK	50	0	1	17.91	1.14	1.16
	----	Right	1720.0	20050	20 MHz/QPSK	1	0	0	19.00	0.860	0.86
	----		1720.0	20050	20 MHz/QPSK	50	0	1	17.81	0.868	0.91
	----		1732.5	20175	20 MHz/QPSK	1	0	0	18.90	0.912	0.93
	----		1732.5	20175	20 MHz/QPSK	50	0	1	18.00	0.888	0.89
	----		1745.0	20300	20 MHz/QPSK	1	0	0	18.98	0.909	0.91
	----		1745.0	20300	20 MHz//QPSK	50	0	1	17.91	0.928	0.95
	----	Repeat	1732.5	20175	20 MHz/QPSK	1	0	0	18.90	1.22	1.25

Body
1.6 W/kg (mW/g)
averaged over 1 gram

1. SAR Measurement
Phantom Configuration Left Head Eli4 Right Head
SAR Configuration Head Body
2. Test Signal Call Mode Test Code Base Station Simulator
3. Test Configuration With Belt Clip Without Belt Clip N/A
4. Tissue Depth is at least 15.0 cm



Jay M. Moulton
Vice President

SAR Data Summary – 1900 MHz Body - CDMA

MEASUREMENT RESULTS

Gap	Plot	Frequency		Modulation	Position	End Power (dBm)	Reverse Channel	Forward Channel	Measured SAR (W/kg)	Reported SAR (W/kg)
		MHz	Ch.							
0 mm	----	1851.25	25	CDMA	Back	18.70	153.6 kbps	2 Slot 307.2 kbps	1.19	1.28
	9	1880.00	600	CDMA		18.70	153.6 kbps	2 Slot 307.2 kbps	1.23	1.32
	----	1908.75	1175	CDMA		18.71	153.6 kbps	2 Slot 307.2 kbps	1.15	1.23
	----	1851.25	25	CDMA	Right	18.70	153.6 kbps	2 Slot 307.2 kbps	0.850	0.91
	----	1880.00	600	CDMA		18.70	153.6 kbps	2 Slot 307.2 kbps	0.815	0.87
	----	1908.75	1175	CDMA		18.71	153.6 kbps	2 Slot 307.2 kbps	0.761	0.81
	----	1880.00	600	CDMA	Repeat	18.70	153.6 kbps	2 Slot 307.2 kbps	1.21	1.30

Body
1.6 W/kg (mW/g)
 averaged over 1 gram

1. SAR Measurement
 Phantom Configuration Left Head Eli4 Right Head
 SAR Configuration Head Body
2. Test Signal Call Mode Test Code Base Station Simulator
3. Test Configuration With Belt Clip Without Belt Clip N/A
4. Tissue Depth is at least 15.0 cm



Jay M. Moulton
 Vice President

SAR Data Summary – 1900 MHz Body - GPRS

MEASUREMENT RESULTS

Gap	Plot	Frequency		Rev Level/ Modulation	Position	End Power (dBm)	TX Level	Multislot Configuration	Measured SAR (W/kg)	Reported SAR (W/kg)
		MHz	Ch.							
0 mm	10	1850.2	512	GMSK	Back	24.96	0	2 Slot	1.21	1.22
	----	1880.0	661	GMSK		24.91	0	2 Slot	1.13	1.15
	----	1909.8	810	GMSK		24.95	0	2 Slot	1.01	1.02
	----	1880.0	661	GMSK	Right	24.91	0	2 Slot	0.658	0.67
	----	1850.2	512	GMSK	Repeat	24.96	0	2 Slot	1.19	1.20

Body
1.6 W/kg (mW/g)
 averaged over 1 gram

1. SAR Measurement
 - Phantom Configuration Left Head Eli4 Right Head
 - SAR Configuration Head Body
2. Test Signal Call Mode Test Code Base Station Simulator
3. Test Configuration With Belt Clip Without Belt Clip N/A
4. Tissue Depth is at least 15.0 cm



Jay M. Moulton
 Vice President

SAR Data Summary – 1900 MHz Body - WCDMA

MEASUREMENT RESULTS

Gap	Plot	Frequency		Rev Level/ Modulation	Position	End Power (dBm)	RMC	Test Set Up	Measured SAR (W/kg)	Reported SAR (W/kg)
		MHz	Ch.							
0 mm	----	1852.4	9262	WCDMA	Back	18.92	12.2 kbps	Test Loop 1	1.25	1.27
	11	1880.0	9400	WCDMA		18.97	12.2 kbps	Test Loop 1	1.27	1.28
	----	1907.6	9538	WCDMA		18.95	12.2 kbps	Test Loop 1	1.23	1.24
	----	1852.4	9262	WCDMA	Right	18.92	12.2 kbps	Test Loop 1	0.871	0.89
	----	1880.0	9400	WCDMA		18.97	12.2 kbps	Test Loop 1	0.828	0.83
	----	1907.6	9538	WCDMA		18.95	12.2 kbps	Test Loop 1	0.807	0.82
	----	1880.0	9400	WCDMA	Repeat	18.97	12.2 kbps	Test Loop 1	1.25	1.26

Body
1.6 W/kg (mW/g)
 averaged over 1 gram

1. SAR Measurement
 Phantom Configuration Left Head Eli4 Right Head
 SAR Configuration Head Body
2. Test Signal Call Mode Test Code Base Station Simulator
3. Test Configuration With Belt Clip Without Belt Clip N/A
4. Tissue Depth is at least 15.0 cm



Jay M. Moulton
 Vice President

SAR Data Summary – 1900 MHz Body – LTE Band 2

MEASUREMENT RESULTS											
Gap	Plot	Position	Frequency		BW/ Modulation	RB Size	RB Offset	MPR Target	End Power (dBm)	Measured SAR (W/kg)	Reported SAR (W/kg)
			MHz	Ch.							
0 mm	----	Back	1860.0	18700	20 MHz/QPSK	1	0	0	18.98	1.16	1.17
	----		1860.0	18700	20 MHz/QPSK	50	0	0	17.89	1.13	1.16
	12		1880.0	18900	20 MHz/QPSK	1	0	0	18.97	1.21	1.22
	----		1880.0	18900	20 MHz/QPSK	50	0	1	17.91	1.11	1.13
	----		1900.0	19100	20 MHz/QPSK	1	0	0	18.94	1.19	1.21
	----		1900.0	19100	20 MHz/QPSK	50	0	1	17.92	1.15	1.17
	----	Right	1860.0	18700	20 MHz/QPSK	1	0	0	18.98	0.856	0.86
	----		1860.0	18700	20 MHz/QPSK	50	0	0	17.89	0.869	0.89
	----		1880.0	18900	20 MHz/QPSK	1	0	0	18.97	0.828	0.83
	----		1880.0	18900	20 MHz/QPSK	50	0	1	17.91	0.826	0.84
	----		1900.0	19100	20 MHz/QPSK	1	0	0	18.94	0.802	0.81
	----		1900.0	19100	20 MHz/QPSK	50	0	1	17.92	0.806	0.82
	----	Repeat	1880.0	18900	20 MHz/QPSK	1	0	0	18.97	1.19	1.20

Body
1.6 W/kg (mW/g)
 averaged over 1 gram

1. SAR Measurement
 Phantom Configuration Left Head Eli4 Right Head
 SAR Configuration Head Body
 2. Test Signal Call Mode Test Code Base Station Simulator
 3. Test Configuration With Belt Clip Without Belt Clip N/A
 4. Tissue Depth is at least 15.0 cm

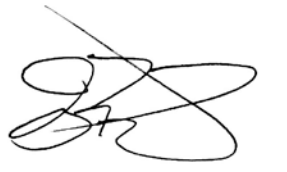

Jay M. Moulton
 Vice President

SAR Data Summary – 2450 MHz Body 802.11b and Bluetooth

MEASUREMENT RESULTS

Gap	Plot	Position	Frequency		Modulation	Antenna	End Power	Measured SAR (W/kg)	Reported SAR (W/kg)
			MHz	Ch.			(dBm)		
0 mm	-----	Back	2437	6	DSSS	Main	18.00	0.0338	0.03
	-----	Top	2437	6	DSSS		18.00	0.0191	0.02
	-----	Left	2437	6	DSSS		18.00	0.0246	0.02
	13	Back	2437	6	OFDM	Aux	17.98	0.0564	0.06
	-----	Right	2437	6	OFDM		17.98	0.0383	0.04
	-----	Back	2402	1	GFSK	Main	8.26	0.00422	<0.01
	-----	Top	2402	1	GFSK		8.26	0.00238	<0.01
	-----	Left	2402	1	GFSK		8.26	0.00307	<0.01

Body
1.6 W/kg (mW/g)
 averaged over 1 gram

1. SAR Measurement
 - Phantom Configuration Left Head Eli4 Right Head
 - SAR Configuration Head Body
2. Test Signal Call Mode Test Code Base Station Simulator
3. Test Configuration With Belt Clip Without Belt Clip N/A
4. Tissue Depth is at least 15.0 cm



Jay M. Moulton
 Vice President

SAR Data Summary – 5600 MHz Body 802.11a

MEASUREMENT RESULTS

Gap	Plot	Position	Frequency		Modulation	Antenna	End Power	Measured SAR (W/kg)	Reported SAR (W/kg)	
			MHz	Ch.			(dBm)			
0 mm	-----	Back	5580	116	OFDM	Main	16.00	0.919	0.92	
	15		5620	124	OFDM		16.00	0.933	0.93	
	-----	Top	5580	116	OFDM		16.00	0.468	0.47	
	-----		5620	124	OFDM		16.00	0.474	0.47	
	-----	Left	5580	116	OFDM		16.00	0.751	0.75	
	-----		5620	124	OFDM		16.00	0.782	0.78	
	-----	Back	5620	124	OFDM		Aux	16.00	0.212	0.21
	-----	Right	5620	124	OFDM			16.00	0.172	0.17
	-----	Repeat	5620	124	OFDM		Main	16.00	0.927	0.93

Body
1.6 W/kg (mW/g)
 averaged over 1 gram

1. SAR Measurement
 Phantom Configuration Left Head Eli4 Right Head
 SAR Configuration Head Body
2. Test Signal Call Mode Test Code Base Station Simulator
3. Test Configuration With Belt Clip Without Belt Clip N/A
4. Tissue Depth is at least 15.0 cm



Jay M. Moulton
 Vice President

SAR Data Summary – 5800 MHz Body 802.11a

MEASUREMENT RESULTS

Gap	Plot	Position	Frequency		Modulation	Antenna	End Power	Measured SAR (W/kg)	Reported SAR (W/kg)
			MHz	Ch.			(dBm)		
0 mm	-----	Back	5785	157	OFDM	Main	16.00	0.805	0.81
	16		5825	165	OFDM		16.00	0.836	0.84
	-----	Top	5785	157	OFDM		16.00	0.398	0.40
	-----	Left	5785	157	OFDM		16.00	0.704	0.70
	-----		5825	165	OFDM		16.00	0.744	0.74
	-----	Back	5785	157	OFDM		Aux	16.00	0.209
	-----	Right	5785	157	OFDM	16.00		0.169	0.17
	-----	Repeat	5825	165	OFDM	Main	16.00	0.825	0.83

Body
1.6 W/kg (mW/g)
 averaged over 1 gram

1. SAR Measurement
 - Phantom Configuration Left Head Eli4 Right Head
 - SAR Configuration Head Body
2. Test Signal Call Mode Test Code Base Station Simulator
3. Test Configuration With Belt Clip Without Belt Clip N/A
4. Tissue Depth is at least 15.0 cm



Jay M. Moulton
 Vice President

SAR Data Summary – 900 MHz Extremity RFID – MS2 Micro

MEASUREMENT RESULTS									
Gap	Plot	Position	Frequency		Modulation	Antenna	End Power	Measured SAR (W/kg)	Reported SAR (W/kg)
			MHz	Ch.			(dBm)		
0 mm	-----	Back	917.4	Low	FHSS	Main	29.92	3.02	3.08
	18		922.4	Mid	FHSS		29.96	3.94	3.98
	-----		927.2	High	FHSS		29.89	2.99	3.07
	-----	Left	922.4	Mid	FHSS		29.96	0.421	0.43
	-----	Right	922.4	Mid	FHSS		29.96	0.442	0.45
	-----	Top	922.4	Mid	FHSS		29.96	1.32	1.33
	-----	Repeat #1	922.4	Mid	FHSS		29.96	3.86	3.90
	-----	Repeat #2	922.4	Mid	FHSS		29.96	3.91	3.95

Extremity
4.0 W/kg (mW/g)
averaged over 10 gram

1. SAR Measurement
 - Phantom Configuration Left Head Eli4 Right Head
 - SAR Configuration Head Body
2. Test Signal Call Mode Test Code Base Station Simulator
3. Test Configuration With Belt Clip Without Belt Clip N/A
4. Tissue Depth is at least 15.0 cm



Jay M. Moulton
Vice President

SAR Data Summary – Simultaneous Transmit (WWAN-WLAN Main)

MEASUREMENT RESULTS				
Plot	Position	SAR (W/kg) WLAN	SAR (W/kg) WWAN	Total SAR (W/kg)
-----	Back	0.93	1.32	2.25
Body 1.6 W/kg (mW/g) averaged over 1 gram				

The WWAN and WLAN Main antennas are a minimum of 112.85 mm apart. Using the highest reported SAR to calculate the simultaneous Tx using peak separation ratio, the highest ratio would be 0.03 which meets the requirements of KDB 447498 D01 v06 section 4.3.2 3) on page 13. The calculation is shown below.

Simultaneous Separation Ratio Calculation

$$(SAR_1 + SAR_2)^{1.5}/R_i \leq 0.04 \text{ rounded to two digits}$$

$$(0.93 + 1.32)^{1.5}/112.85 = 0.03$$

SAR Data Summary – Simultaneous Transmit (WWAN-WLAN Aux)

MEASUREMENT RESULTS				
Plot	Position	SAR (W/kg) WLAN	SAR (W/kg) WWAN	Total SAR (W/kg)
-----	Back	0.25	1.32	1.57
Body 1.6 W/kg (mW/g) averaged over 1 gram				

The sum of the two transmitters is less than the limit; therefore, the simultaneous transmission meets the requirements of KDB447498 D01 v06 section 4.3.2 page 11.

SAR Data Summary – Simultaneous Transmit (RFID) – MS2 Micro

MEASUREMENT RESULTS				
Plot	Transmitter	SAR (W/kg) WLAN/WWAN	SAR (W/kg) RFID	Total SAR (W/kg)
-----	WWAN	0.81	3.98	4.79
-----	WLAN Main	0.16	3.98	4.14
-----	WLAN Aux	0.02	3.98	4.00
Extremity 4.0 W/kg (mW/g) averaged over 10 gram				

The RFID and WWAN hotspots are a minimum of 132 mm apart. Using the highest reported SAR to calculate the simultaneous Tx using peak separation ratio, the highest ratio would be 0.08 which meets the requirements of KDB 447498 D01 v06 section 4.3.2 3) on page 13. The calculation is shown below.

Simultaneous Separation Ratio Calculation

$$(SAR_1 + SAR_2)^{1.5}/R_i \leq 0.10 \text{ rounded to two digits}$$

$$(0.81 + 3.98)^{1.5}/132 = 0.08$$

The location of the hotspot for the RFID is (12,5). The location of the hotspot for the WWAN is (65,-116). The calculation for the distance between the hotspots is as follows:

$$z = \sqrt{(x^2 + y^2)} = \sqrt{[(65-12)^2 + (5-{-116})^2]} = 132.09$$

The RFID and WLAN Main hotspots are a minimum of 92 mm apart. Using the highest reported SAR to calculate the simultaneous Tx using peak separation ratio, the highest ratio would be 0.09 which meets the requirements of KDB 447498 D01 v06 section 4.3.2 3) on page 13. The calculation is shown below.

Simultaneous Separation Ratio Calculation

$$(SAR_1 + SAR_2)^{1.5}/R_i \leq 0.10 \text{ rounded to two digits}$$

$$(0.16 + 3.98)^{1.5}/92 = 0.09$$

The location of the hotspot for the RFID is (12,5). The location of the hotspot for the WiFi is (-78,26). The calculation for the distance between the hotspots is as follows:

$$z = \sqrt{(x^2 + y^2)} = \sqrt{[(12-{-78})^2 + (26-5)^2]} = 92.42$$

The sum of the two transmitters (RFID and WLAN Aux) is less than the limit; therefore, the simultaneous transmission meets the requirements of KDB447498 D01 v06 section 4.3.2 page 11.

All three transmitters can transmit simultaneously. Each pair is evaluated individually per KDB447498 v06 section 4.3.2 c) on page 15.

11. Test Equipment List

Table 11.1 Equipment Specifications

Type	Calibration Due Date	Calibration Done Date	Serial Number
Staubli Robot TX60L	N/A	N/A	F07/55M6A1/A/01
Measurement Controller CS8c	N/A	N/A	1012
ELI4 Flat Phantom	N/A	N/A	1065
ELI4 Flat Phantom	N/A	N/A	1251
Device Holder	N/A	N/A	N/A
Data Acquisition Electronics 4	04/15/2016	04/15/2015	1416
Data Acquisition Electronics 4	01/14/2017	01/14/2016	1321
Data Acquisition Electronics 4	08/13/2016	08/13/2015	759
Data Acquisition Electronics 4	08/17/2017	08/17/2016	759
SPEAG E-Field Probe EX3DV4	04/27/2016	04/27/2015	3662
SPEAG E-Field Probe EX3DV4	04/27/2017	04/27/2016	3662
SPEAG E-Field Probe EX3DV4	01/27/2017	01/27/2016	3833
SPEAG E-Field Probe EX3DV4	08/20/2016	08/20/2015	3693
Speag Validation Dipole D750V2	08/10/2016	08/10/2015	1053
Speag Validation Dipole D835V2	08/10/2016	08/10/2015	4d131
Speag Validation Dipole D900V2	08/10/2017	08/10/2015	1d128
Speag Validation Dipole D1750V2	08/13/2016	08/13/2015	1061
Speag Validation Dipole D1900V2	08/13/2016	08/13/2015	5d147
Speag Validation Dipole D2450V2	08/10/2016	08/10/2015	881
Speag Validation Dipole D5GHzV2	08/11/2016	08/11/2015	1119
Agilent N1911A Power Meter	05/20/2017	05/20/2015	GB45100254
Agilent N1922A Power Sensor	06/25/2017	06/25/2015	MY45240464
Advantest R3261A Spectrum Analyzer	03/26/2017	03/26/2015	31720068
Agilent (HP) 8350B Signal Generator	03/26/2017	03/26/2015	2749A10226
Agilent (HP) 83525A RF Plug-In	03/26/2017	03/26/2015	2647A01172
Agilent (HP) 8753C Vector Network Analyzer	03/26/2017	03/26/2015	3135A01724
Agilent (HP) 85047A S-Parameter Test Set	03/26/2017	03/26/2015	2904A00595
Agilent (HP) 8960 Base Station Sim.	03/31/2017	03/31/2015	MY48360364
Anritsu MT8820C	07/28/2017	07/28/2015	6201176199
Aprel Dielectric Probe Assembly	N/A	N/A	0011
Body Equivalent Matter (750 MHz)	N/A	N/A	N/A
Body Equivalent Matter (835/900 MHz)	N/A	N/A	N/A
Body Equivalent Matter (1750 MHz)	N/A	N/A	N/A
Body Equivalent Matter (1900 MHz)	N/A	N/A	N/A
Body Equivalent Matter (2450 MHz)	N/A	N/A	N/A
Body Equivalent Matter (5 GHz)	N/A	N/A	N/A

12. Conclusion

The SAR measurement indicates that the EUT complies with the RF radiation exposure limits of the FCC/IC. These measurements are taken to simulate the RF effects exposure under worst-case conditions. Precise laboratory measures were taken to assure repeatability of the tests. The tested device complies with the requirements in respect to all parameters subject to the test. The test results and statements relate only to the item(s) tested.

Please note that the absorption and distribution of electromagnetic energy in the body is a very complex phenomena that depends on the mass, shape, and size of the body; the orientation of the body with respect to the field vectors; and, the electrical properties of both the body and the environment. Other variables that may play a substantial role in possible biological effects are those that characterize the environment (e.g. ambient temperature, air velocity, relative humidity, and body insulation) and those that characterize the individual (e.g. age, gender, activity level, debilitation, or disease). Because innumerable factors may interact to determine the specific biological outcome of an exposure to electromagnetic fields, any protection guide shall consider maximal amplification of biological effects as a result of field-body interactions, environmental conditions, and physiological variables.

13. References

- [1] Federal Communications Commission, ET Docket 93-62, Guidelines for Evaluating the Environmental Effects of Radio Frequency Radiation, August 1996

- [2] ANSI/IEEE C95.1 – 1992, American National Standard Safety Levels with respect to Human Exposure to Radio Frequency Electromagnetic Fields, 300kHz to 100GHz, New York: IEEE, 1992.

- [3] ANSI/IEEE C95.3 – 1992, IEEE Recommended Practice for the Measurement of Potentially Hazardous Electromagnetic Fields – RF and Microwave, New York: IEEE, 1992.

- [4] International Electrotechnical Commission, IEC 62209-2 (Edition 1.0), Human Exposure to radio frequency fields from hand-held and body mounted wireless communication devices – Human models, instrumentation, and procedures – Part 2: Procedure to determine the specific absorption rate (SAR) for wireless communication devices used in close proximity to the human body (frequency range of 30 MHz to 6 GHz), March 2010.

- [5] IEEE Standard 1528 – 2013, IEEE Recommended Practice for Determining the Peak-Spatial Average Specific Absorption Rate (SAR) in the Human Head from Wireless Communication Devices: Measurement Techniques, June 2013.

- [6] Industry Canada, RSS – 102 Issue 5, Radio Frequency Exposure Compliance of Radiocommunication Apparatus (All Frequency Bands), March 2015.

- [7] Health Canada, Safety Code 6, Limits of Human Exposure to Radiofrequency Electromagnetic Fields in the Frequency Range from 3kHz to 300 GHz, 2009.

Appendix A – System Validation Plots and Data

Test Result for UIM Dielectric Parameter

Wed 30/Dec/2015

Freq Frequency (GHz)

FCC_eH Limits for Head Epsilon

FCC_sH Limits for Head Sigma

FCC_eB Limits for Body Epsilon

FCC_sB Limits for Body Sigma

Test_e Epsilon of UIM

Test_s Sigma of UIM

Freq	FCC_eB	FCC_sB	Test_e	Test_s
0.7000	55.73	0.96	54.98	0.89
0.7090	55.694	0.96	54.926	0.899*
0.7100	55.69	0.96	54.92	0.90
0.7110	55.686	0.96	54.915	0.901*
0.7200	55.65	0.96	54.87	0.91
0.7300	55.61	0.96	54.81	0.92
0.7400	55.57	0.96	54.77	0.93
0.7500	55.53	0.96	54.69	0.94
0.7600	55.49	0.96	54.62	0.95
0.7700	55.45	0.96	54.58	0.96
0.7800	55.41	0.97	54.57	0.97
0.7820	55.404	0.97	54.556	0.972*
0.7900	55.38	0.97	54.50	0.98

* value interpolated

Test Result for UIM Dielectric Parameter

Tue 29/Dec/2015

Freq Frequency (GHz)

FCC_eH Limits for Head Epsilon

FCC_sH Limits for Head Sigma

FCC_eB Limits for Body Epsilon

FCC_sB Limits for Body Sigma

Test_e Epsilon of UIM

Test_s Sigma of UIM

Freq	FCC_eB	FCC_sB	Test_e	Test_s
0.8150	55.28	0.97	54.28	0.95
0.8173	55.271	0.97	54.292	0.952*
0.8242	55.243	0.97	54.326	0.959*
0.8247	55.241	0.97	54.329	0.96*
0.8250	55.24	0.97	54.33	0.96
0.8264	55.234	0.97	54.336	0.963*
0.8290	55.224	0.97	54.346	0.968*
0.8330	55.208	0.97	54.362	0.976*
0.8350	55.20	0.97	54.37	0.98
0.8365	55.196	0.972	54.375	0.982*
0.8366	55.195	0.972	54.375	0.982*
0.8440	55.173	0.979	54.397	0.989*
0.8450	55.17	0.98	54.40	0.99
0.8466	55.165	0.982	54.406	0.995*
0.8483	55.16	0.983	54.413	1.00*
0.8488	55.159	0.984	54.415	1.001*
0.8550	55.14	0.99	54.44	1.02

* value interpolated

Test Result for UIM Dielectric Parameter

Mon 28/Dec/2015

Freq Frequency (GHz)

FCC_eH Limits for Head Epsilon

FCC_sH Limits for Head Sigma

FCC_eB Limits for Body Epsilon

FCC_sB Limits for Body Sigma

Test_e Epsilon of UIM

Test_s Sigma of UIM

Freq	FCC_eB	FCC_sB	Test_e	Test_s
1.6900	53.59	1.45	52.89	1.51
1.7000	53.56	1.46	52.85	1.52
1.7100	53.54	1.46	52.81	1.53
1.7124	53.533	1.462	52.803	1.532*
1.7200	53.51	1.47	52.78	1.54
1.7300	53.48	1.48	52.74	1.55
1.7325	53.475	1.48	52.73	1.55*
1.7326	53.475	1.48	52.73	1.55*
1.7400	53.46	1.48	52.70	1.55
1.7450	53.445	1.485	52.69	1.555*
1.7500	53.43	1.49	52.68	1.56
1.7526	53.425	1.49	52.675	1.56*
1.7600	53.41	1.49	52.66	1.56
1.7700	53.38	1.50	52.65	1.57
1.7800	53.35	1.51	52.61	1.58
1.7900	53.33	1.51	52.58	1.59

* value interpolated

Test Result for UIM Dielectric Parameter

Mon 21/Dec/2015

Freq Frequency (GHz)

FCC_eH Limits for Head Epsilon

FCC_sH Limits for Head Sigma

FCC_eB Limits for Body Epsilon

FCC_sB Limits for Body Sigma

Test_e Epsilon of UIM

Test_s Sigma of UIM

Freq	FCC_eB	FCC_sB	Test_e	Test_s
1.8500	53.30	1.52	53.27	1.49
1.8502	53.30	1.52	53.27	1.49*
1.8513	53.30	1.52	53.267	1.491*
1.8524	53.30	1.52	53.265	1.492*
1.8600	53.30	1.52	53.25	1.50
1.8700	53.30	1.52	53.23	1.51
1.8800	53.30	1.52	53.21	1.52
1.8900	53.30	1.52	53.19	1.53
1.9000	53.30	1.52	53.17	1.54
1.9076	53.30	1.52	53.155	1.548*
1.9088	53.30	1.52	53.152	1.549*
1.9098	53.30	1.52	53.15	1.55*
1.9100	53.30	1.52	53.15	1.55
1.9200	53.30	1.52	53.14	1.57
1.9300	53.30	1.52	53.12	1.58

* value interpolated

Test Result for UIM Dielectric Parameter

Thu 17/Dec/2015

Freq Frequency (GHz)

FCC_eH Limits for Head Epsilon

FCC_sH Limits for Head Sigma

FCC_eB Limits for Body Epsilon

FCC_sB Limits for Body Sigma

Test_e Epsilon of UIM

Test_s Sigma of UIM

Freq	FCC_eB	FCC_sB	Test_e	Test_s
2.4100	52.75	1.91	52.85	1.88
2.4120	52.748	1.912	52.846	1.882*
2.4200	52.74	1.92	52.83	1.89
2.4300	52.73	1.93	52.81	1.90
2.4370	52.716	1.937	52.796	1.907*
2.4400	52.71	1.94	52.79	1.91
2.4500	52.70	1.95	52.77	1.92
2.4600	52.69	1.96	52.75	1.93
2.4620	52.686	1.964	52.746	1.932*
2.4700	52.67	1.98	52.73	1.94
2.4800	52.66	1.99	52.71	1.95

* value interpolated

Test Result for UIM Dielectric Parameter

Fri 18/Dec/2015

Freq Frequency (GHz)

FCC_eH Limits for Head Epsilon

FCC_sH Limits for Head Sigma

FCC_eB Limits for Body Epsilon

FCC_sB Limits for Body Sigma

Test_e Epsilon of UIM

Test_s Sigma of UIM

Freq	FCC_eB	FCC_sB	Test_e	Test_s
5.1000	49.15	5.18	49.22	5.10
5.1200	49.12	5.21	49.19	5.12
5.1400	49.10	5.23	49.16	5.14
5.1600	49.07	5.25	49.13	5.16
5.1800	49.04	5.28	49.10	5.19
5.2000	49.01	5.30	49.07	5.21
5.2200	48.99	5.32	49.04	5.23
5.2400	48.96	5.35	49.01	5.25
5.2600	48.93	5.37	48.98	5.28
5.2800	48.91	5.39	48.95	5.31
5.3000	48.88	5.42	48.92	5.33
5.3200	48.85	5.44	48.89	5.36
5.3400	48.82	5.46	48.86	5.38
5.3600	48.80	5.49	48.83	5.40
5.3800	48.77	5.51	48.80	5.43
5.4000	48.74	5.53	48.77	5.46
5.4200	48.72	5.56	48.74	5.49
5.4400	48.69	5.58	48.71	5.51
5.4600	48.66	5.60	48.68	5.53
5.4800	48.63	5.63	48.65	5.55
5.5000	48.61	5.65	48.62	5.58
5.5200	48.58	5.67	48.59	5.61
5.5400	48.55	5.70	48.56	5.64
5.5600	48.53	5.72	48.53	5.67
5.5800	48.50	5.74	48.50	5.70
5.6000	48.47	5.77	48.47	5.73
5.6200	48.44	5.79	48.44	5.75
5.6400	48.42	5.81	48.41	5.78
5.6600	48.39	5.84	48.38	5.81
5.6800	48.36	5.86	48.35	5.84
5.7000	48.34	5.88	48.32	5.86
5.7200	48.31	5.91	48.29	5.89
5.7400	48.28	5.93	48.26	5.91
5.7450	48.273	5.935	48.253	5.918*
5.7600	48.25	5.95	48.23	5.94
5.7800	48.23	5.98	48.20	5.97
5.7850	48.223	5.985	48.193	5.975*
5.8000	48.20	6.00	48.17	5.99
5.8200	48.17	6.02	48.14	6.02
5.8250	48.165	6.028	48.133	6.025*
5.8400	48.15	6.05	48.11	6.04

* value interpolated

Test Result for UIM Dielectric Parameter

Sat 19/Mar/2016

Freq Frequency (GHz)

FCC_eH Limits for Head Epsilon

FCC_sH Limits for Head Sigma

FCC_eB Limits for Body Epsilon

FCC_sB Limits for Body Sigma

Test_e Epsilon of UIM

Test_s Sigma of UIM

Freq	FCC_eB	FCC_sB	Test_e	Test_s
2.4000	52.76	1.90	52.73	1.91
2.4020	52.758	1.902	52.726	1.912*
2.4100	52.75	1.91	52.71	1.92
2.4200	52.74	1.92	52.69	1.93
2.4300	52.73	1.93	52.68	1.94
2.4400	52.71	1.94	52.66	1.95
2.4500	52.70	1.95	52.64	1.96
2.4600	52.69	1.96	52.63	1.98
2.4700	52.67	1.98	52.61	1.99
2.4800	52.66	1.99	52.60	2.00

* value interpolated

Test Result for UIM Dielectric Parameter

Wed 30/Nov/2016

Freq Frequency (GHz)

FCC_eH Limits for Head Epsilon

FCC_sH Limits for Head Sigma

FCC_eB Limits for Body Epsilon

FCC_sB Limits for Body Sigma

Test_e Epsilon of UIM

Test_s Sigma of UIM

Freq	FCC_eB	FCC_sB	Test_e	Test_s
0.8700	55.09	1.01	54.92	1.02
0.8800	55.06	1.03	54.88	1.04
0.8900	55.03	1.04	54.85	1.05
0.9000	55.00	1.05	54.83	1.07
0.9100	55.00	1.06	54.80	1.08
0.9174	54.993	1.06	54.778	1.087*
0.9200	54.99	1.06	54.77	1.09
0.9223	54.985	1.062	54.763	1.095*
0.9272	54.976	1.067	54.748	1.104*
0.9300	54.97	1.07	54.74	1.11
0.9400	54.95	1.07	54.72	1.12
0.9500	54.93	1.08	54.69	1.13
0.9600	54.91	1.08	54.67	1.14
0.9700	54.89	1.09	54.64	1.15

* value interpolated

RF Exposure Lab

Plot 1

DUT: Dipole 750 MHz D750V3; Type: D750V3; Serial: D750V3 - SN:1053

Communication System: CW; Frequency: 750 MHz; Duty Cycle: 1:1
 Medium: MSL750; Medium parameters used: $f = 750 \text{ MHz}$; $\sigma = 0.94 \text{ S/m}$; $\epsilon_r = 54.69$; $\rho = 1000 \text{ kg/m}^3$
 Phantom section: Flat Section

Test Date: Date: 12/30/2015; Ambient Temp: 23 °C; Tissue Temp: 21 °C

Probe: EX3DV4 - SN3662; ConvF(8.92, 8.92, 8.92); Calibrated: 4/27/2015;
 Sensor-Surface: 2mm (Mechanical Surface Detection)
 Electronics: DAE4 Sn1416; Calibrated: 4/15/2015
 Phantom: ELI v4.0; Type: QDOVA001BB; Serial: 1065
 Measurement SW: DASY52, Version 52.8 (8); SEMCAD X Version 14.6.10 (7331)

Procedure Notes:

750 MHz/Verification/Area Scan (5x11x1): Measurement grid: $dx=15\text{mm}$, $dy=15\text{mm}$
 Maximum value of SAR (measured) = 1.08 W/kg

750 MHz/Verification/Zoom Scan (5x5x7)/Cube 0: Measurement grid: $dx=8\text{mm}$, $dy=8\text{mm}$, $dz=5\text{mm}$
 Reference Value = 31.227 V/m; Power Drift = 0.02 dB
 Peak SAR (extrapolated) = 1.30 W/kg
SAR(1 g) = 0.865 W/kg; SAR(10 g) = 0.569 W/kg
 Maximum value of SAR (measured) = 1.10 W/kg

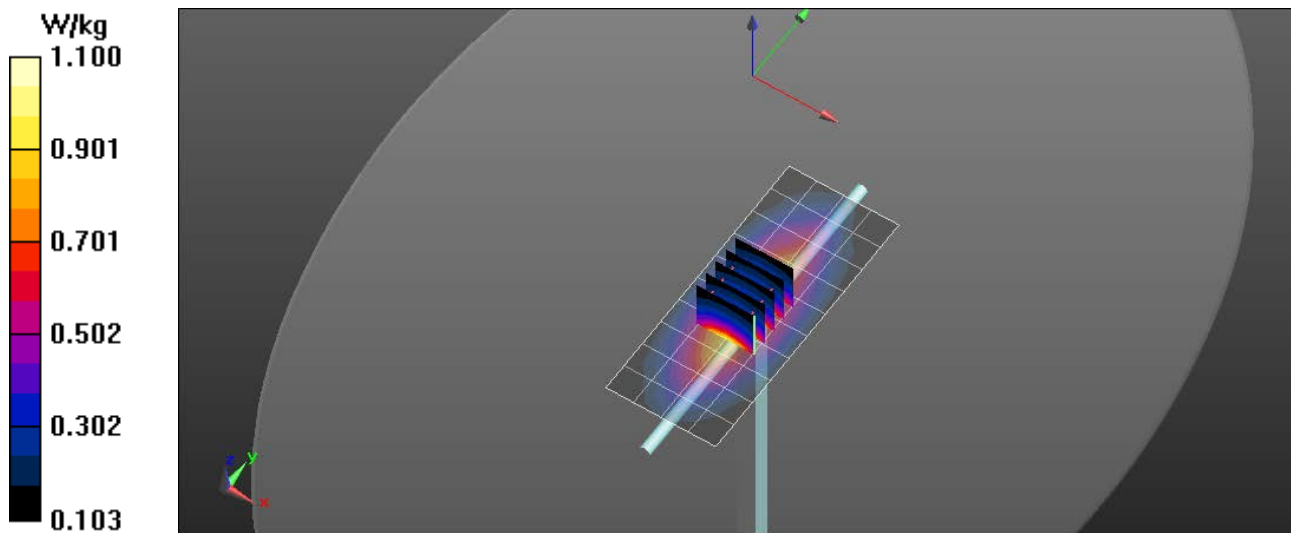

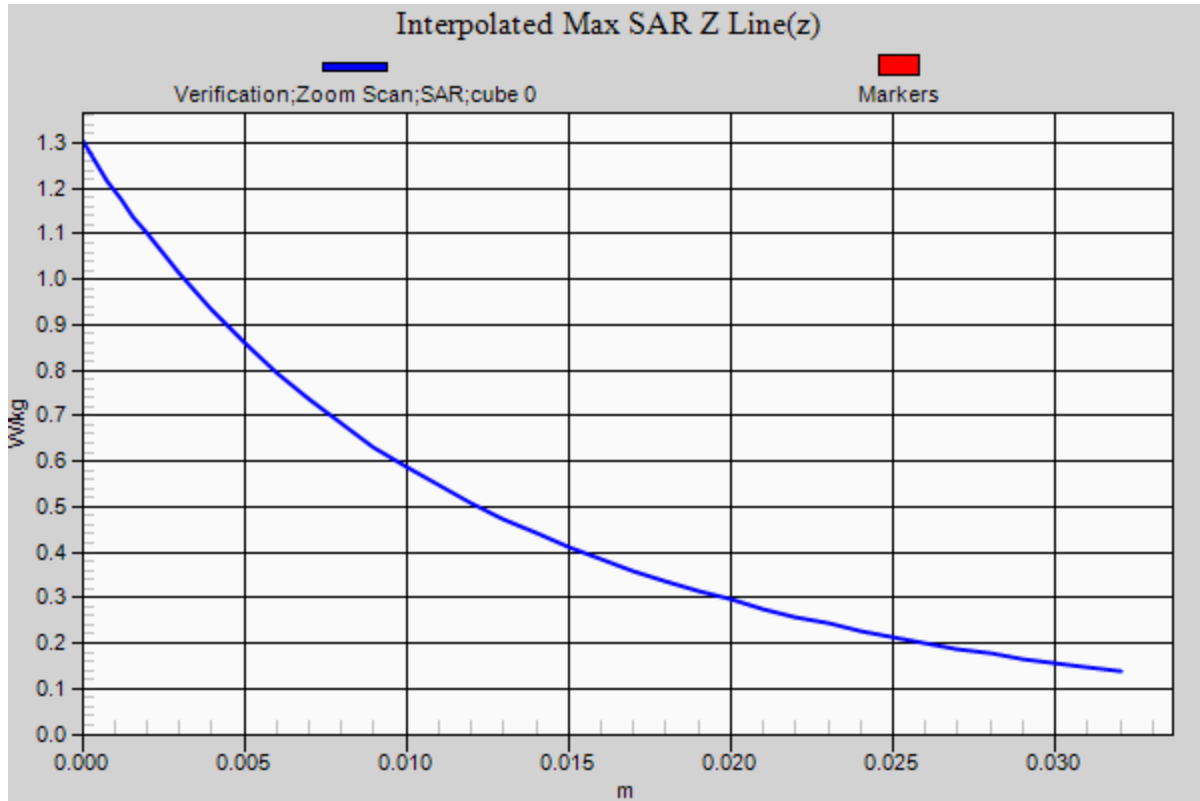

RF Exposure Lab

Plot 2

DUT: Dipole 835 MHz D835V2; Type: D835V2; Serial: D835V2 - SN:4d131

Communication System: CW; Frequency: 835 MHz; Duty Cycle: 1:1
Medium: MSL835; Medium parameters used: $f = 835$ MHz; $\sigma = 0.98$ S/m; $\epsilon_r = 54.37$; $\rho = 1000$ kg/m³
Phantom section: Flat Section

Test Date: Date: 12/29/2015; Ambient Temp: 23 °C; Tissue Temp: 21 °C

Probe: EX3DV4 - SN3662; ConvF(8.86, 8.86, 8.86); Calibrated: 4/27/2015;
Sensor-Surface: 2mm (Mechanical Surface Detection)
Electronics: DAE4 Sn1416; Calibrated: 4/15/2015
Phantom: ELI v4.0; Type: QDOVA001BB; Serial: 1065
Measurement SW: DASY52, Version 52.8 (8); SEMCAD X Version 14.6.10 (7331)

Procedure Notes:

835 MHz/Verification/Area Scan (5x11x1): Measurement grid: dx=15mm, dy=15mm
Maximum value of SAR (measured) = 1.18 W/kg

835 MHz/Verification/Zoom Scan (5x5x7)/Cube 0: Measurement grid: dx=8mm, dy=8mm, dz=5mm
Reference Value = 31.227 V/m; Power Drift = -0.01 dB
Peak SAR (extrapolated) = 1.47 W/kg
SAR(1 g) = 0.943 W/kg; SAR(10 g) = 0.619 W/kg

Info: [Interpolated medium parameters used for SAR evaluation.](#)
Maximum value of SAR (measured) = 1.19 W/kg

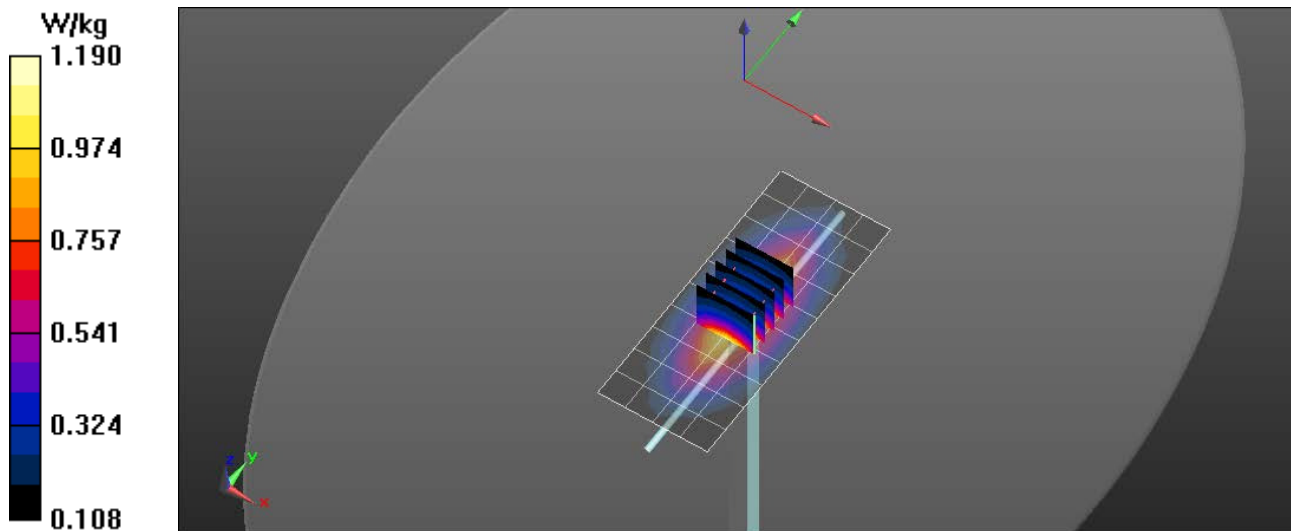

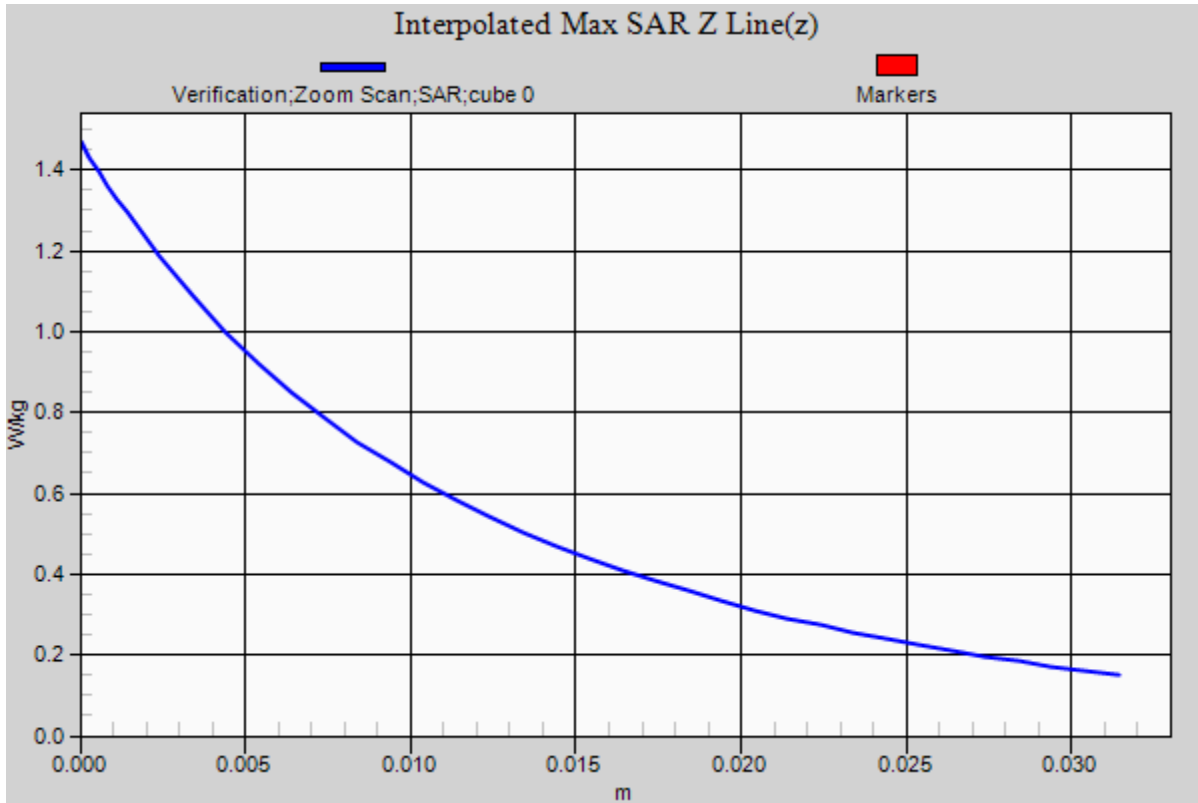

RF Exposure Lab

Plot 3

DUT: Dipole 1750 MHz D1750V2; Type: D1750V2; Serial: D1750V2 - SN:1061

Communication System: CW; Frequency: 1750 MHz; Duty Cycle: 1:1
 Medium: MSL1750; Medium parameters used: $f = 1750$ MHz; $\sigma = 1.56$ S/m; $\epsilon_r = 52.68$; $\rho = 1000$ kg/m³
 Phantom section: Flat Section

Test Date: Date: 12/28/2015; Ambient Temp: 23 °C; Tissue Temp: 21 °C

Probe: EX3DV4 - SN3662; ConvF(7.49, 7.49, 7.49); Calibrated: 4/27/2015;
 Sensor-Surface: 2mm (Mechanical Surface Detection)
 Electronics: DAE4 Sn1416; Calibrated: 4/15/2015
 Phantom: ELI v4.0; Type: QDOVA001BB; Serial: 1065
 Measurement SW: DASY52, Version 52.8 (8); SEMCAD X Version 14.6.10 (7331)

Procedure Notes:

1750 MHz/Verification/Area Scan (5x7x1): Measurement grid: dx=15mm, dy=15mm
 Maximum value of SAR (measured) = 5.33 W/kg

1750 MHz/Verification/Zoom Scan (5x5x7)/Cube 0: Measurement grid: dx=8mm, dy=8mm, dz=5mm
 Reference Value = 31.227 V/m; Power Drift = -0.01 dB
 Peak SAR (extrapolated) = 6.89 W/kg
SAR(1 g) = 3.85 W/kg; SAR(10 g) = 2.03 W/kg
 Maximum value of SAR (measured) = 5.49 W/kg

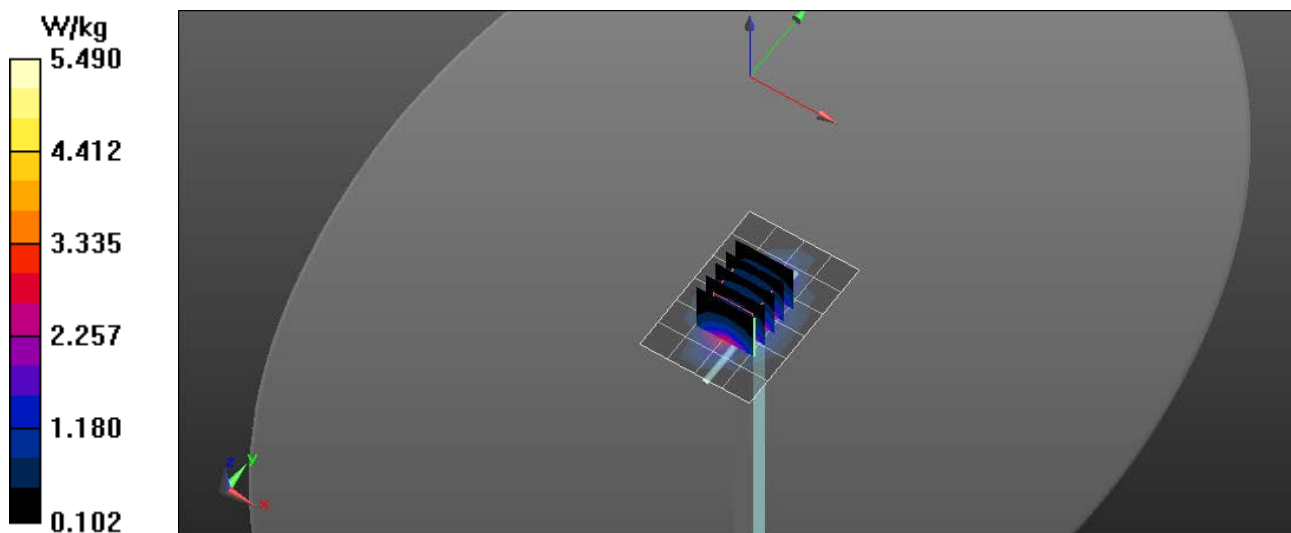

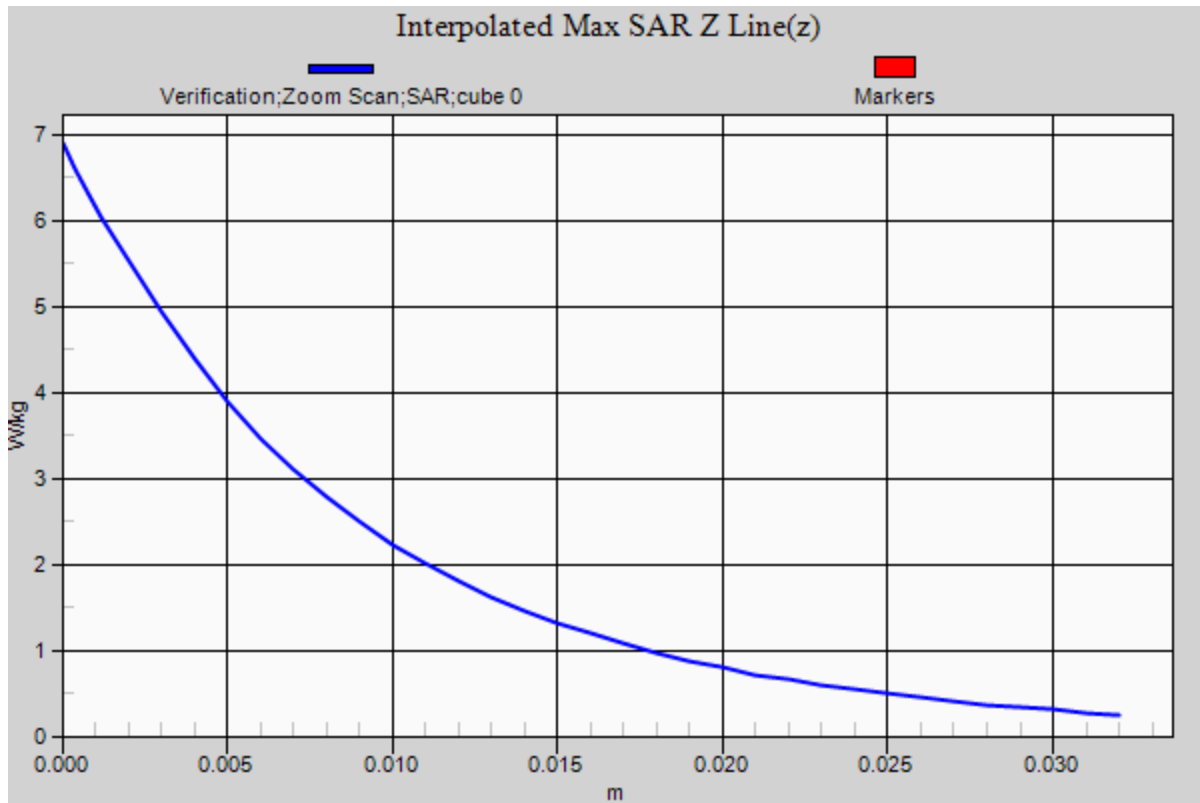

RF Exposure Lab

Plot 4

DUT: Dipole 1900 MHz D1900V2; Type: D1900V2; Serial: D1900V2 - SN:5d147

Communication System: CW; Frequency: 1900 MHz; Duty Cycle: 1:1
 Medium: MSL1900; Medium parameters used: $f = 1900$ MHz; $\sigma = 1.54$ S/m; $\epsilon_r = 53.17$; $\rho = 1000$ kg/m³
 Phantom section: Flat Section

Test Date: Date: 12/21/2015; Ambient Temp: 23 °C; Tissue Temp: 21 °C

Probe: EX3DV4 - SN3662; ConvF(7.31, 7.31, 7.31); Calibrated: 4/27/2015;
 Sensor-Surface: 2mm (Mechanical Surface Detection)
 Electronics: DAE4 Sn1416; Calibrated: 4/15/2015
 Phantom: ELI v4.0; Type: QDOVA001BB; Serial: 1065
 Measurement SW: DASY52, Version 52.8 (8); SEMCAD X Version 14.6.10 (7331)

Procedure Notes:

1900 MHz/Verification/Area Scan (5x7x1): Measurement grid: dx=15mm, dy=15mm
 Maximum value of SAR (measured) = 5.44 W/kg

1900 MHz/Verification/Zoom Scan (5x5x7)/Cube 0: Measurement grid: dx=8mm, dy=8mm, dz=5mm
 Reference Value = 31.227 V/m; Power Drift = -0.01 dB
 Peak SAR (extrapolated) = 7.22 W/kg
SAR(1 g) = 4.02 W/kg; SAR(10 g) = 2.1 W/kg
 Maximum value of SAR (measured) = 5.77 W/kg

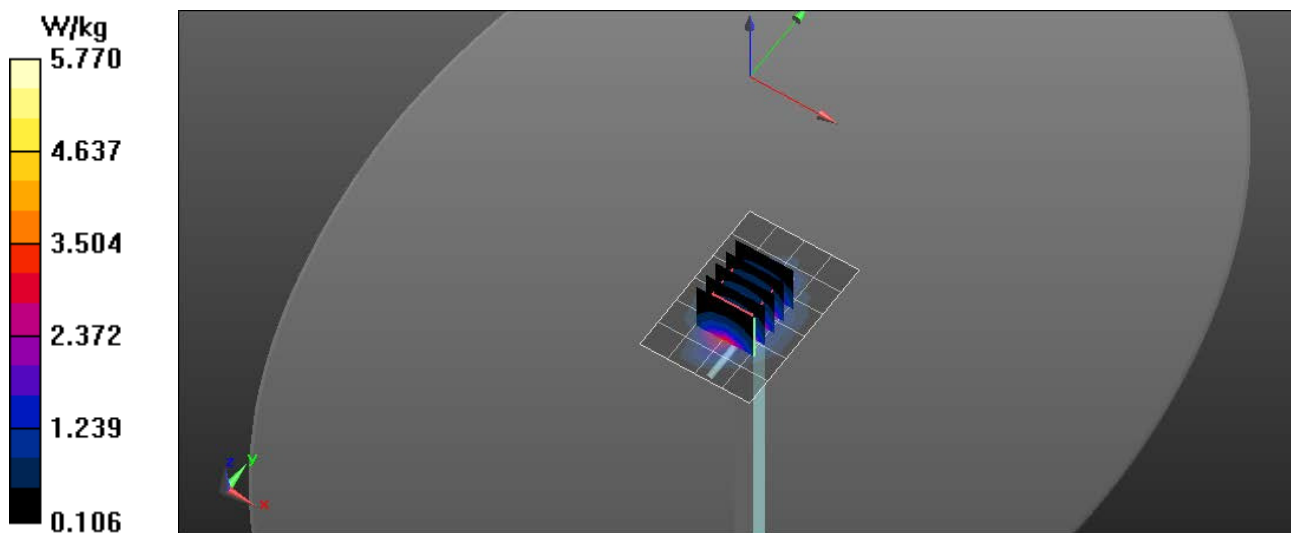

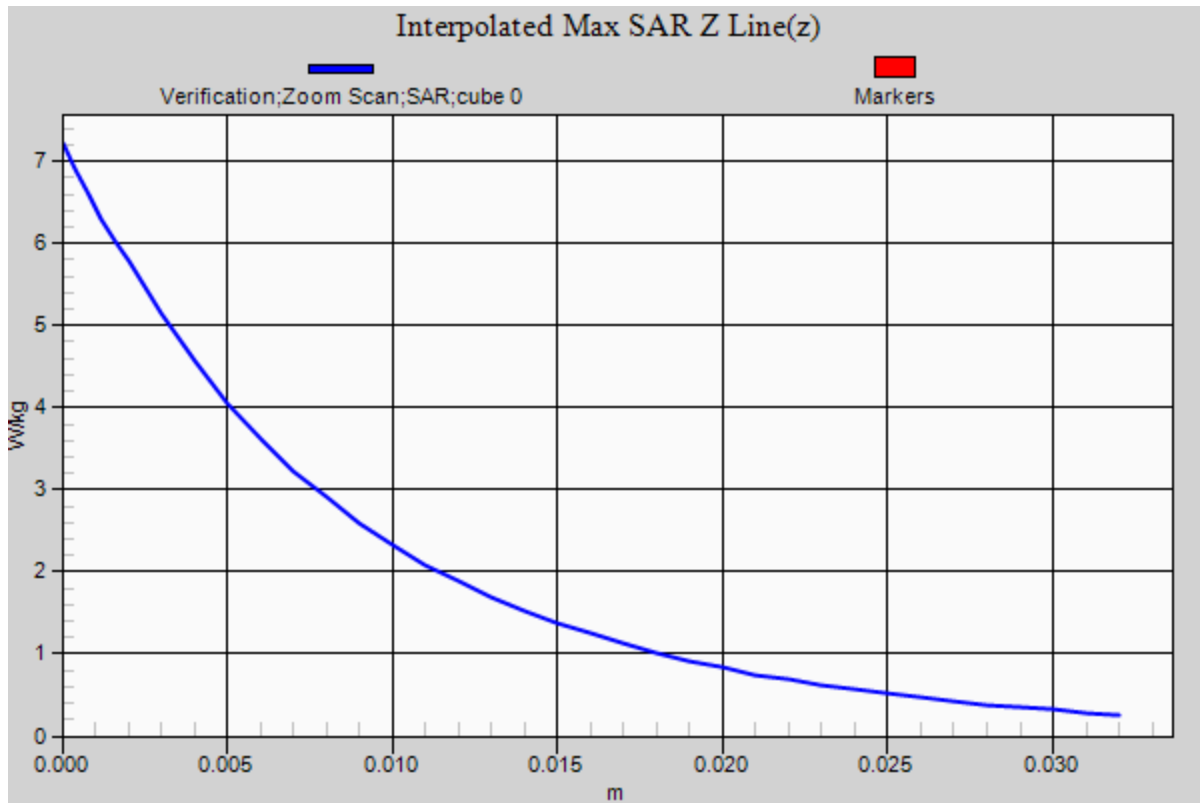

RF Exposure Lab

Plot 5

DUT: Dipole 2450 MHz D2450V2; Type: D2450V2; Serial: D2450V2 - SN: 881

Communication System: CW; Frequency: 2450 MHz; Duty Cycle: 1:1
 Medium: MSL2450; Medium parameters used: $f = 2450$ MHz; $\sigma = 1.92$ S/m; $\epsilon_r = 52.77$; $\rho = 1000$ kg/m³
 Phantom section: Flat Section

Test Date: Date: 12/17/2015; Ambient Temp: 23 °C; Tissue Temp: 21 °C
 Probe: EX3DV4 - SN3662; ConvF(7.08, 7.08, 7.08); Calibrated: 4/27/2015;
 Sensor-Surface: 2mm (Mechanical Surface Detection)
 Electronics: DAE4 Sn1416; Calibrated: 4/15/2015
 Phantom: ELI v4.0; Type: QDOVA001BB; Serial: 1065
 Measurement SW: DASY52, Version 52.8 (8); SEMCAD X Version 14.6.10 (7331)

Procedure Notes:

Body Verification/2450 MHz/Area Scan (61x101x1): Interpolated grid: dx=1.200 mm, dy=1.200 mm
 Maximum value of SAR (interpolated) = 8.92 W/kg

Body Verification/2450 MHz/Zoom Scan (7x7x7)/Cube 0: Measurement grid: dx=5mm, dy=5mm, dz=5mm
 Reference Value = 53.359 V/m; Power Drift = -0.02 dB
 Peak SAR (extrapolated) = 11.04 W/kg
SAR(1 g) = 5.12 W/kg; SAR(10 g) = 2.37 W/kg
 Maximum value of SAR (measured) = 8.79 W/kg

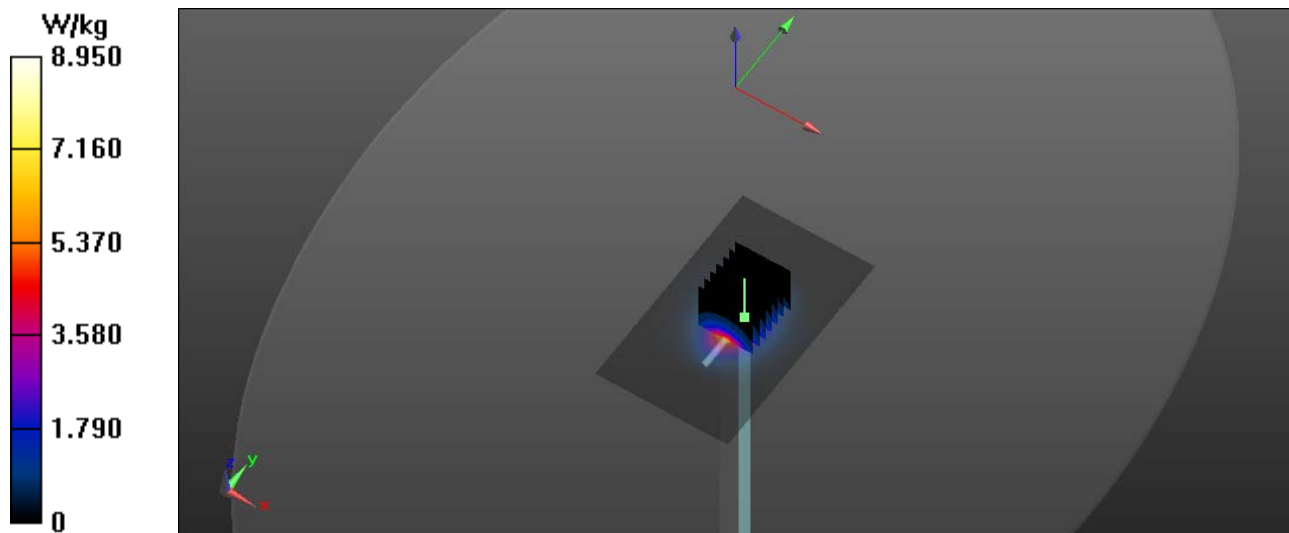

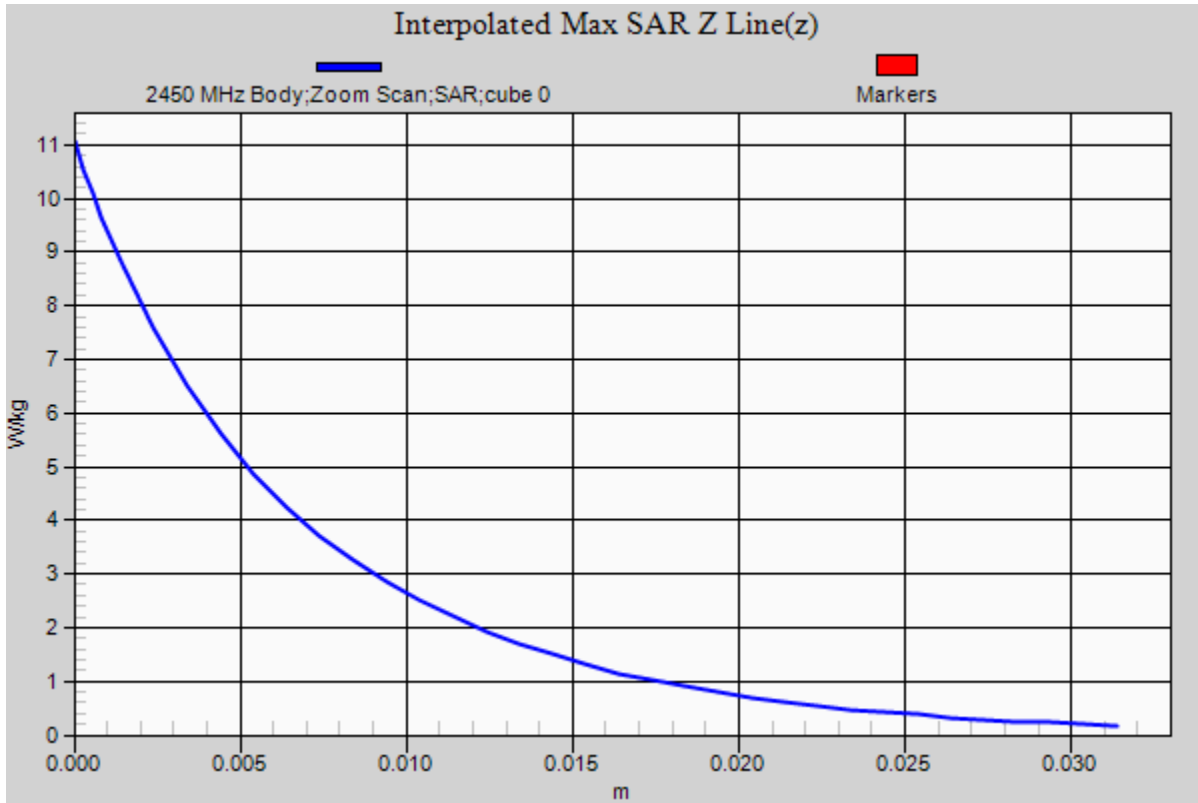

RF Exposure Lab

Plot 6

DUT: Dipole D5GHzV2; Type: D5GHzV2; Serial: D5GHzV2 - SN:1119

Communication System: CW; Frequency: 5200 MHz; Duty Cycle: 1:1
 Medium: MSL 3-6 GHz; Medium parameters used: $f = 5200$ MHz; $\sigma = 5.21$ S/m; $\epsilon_r = 49.07$; $\rho = 1000$ kg/m³
 Phantom section: Flat Section

Test Date: Date: 12/18/2015; Ambient Temp: 23 °C; Tissue Temp: 21 °C
 Probe: EX3DV4 - SN3662; ConvF(4.45, 4.45, 4.45); Calibrated: 4/27/2015;
 Sensor-Surface: 2mm (Mechanical Surface Detection)
 Electronics: DAE4 Sn1416; Calibrated: 4/15/2015
 Phantom: ELI v4.0; Type: QDOVA001BB; Serial: 1065
 Measurement SW: DASY52, Version 52.8 (8); SEMCAD X Version 14.6.10 (7331)

Procedure Notes:

5200 MHz Body/Verification/Area Scan (7x9x1): Measurement grid: dx=10mm, dy=10mm
 Maximum value of SAR (measured) = 1.58 W/kg

5200 MHz Body/Verification/Zoom Scan (7x7x12)/Cube 0: Measurement grid: dx=4mm, dy=4mm, dz=2mm
 Reference Value = 11.705 V/m; Power Drift = 0.01 dB
 Peak SAR (extrapolated) = 3.75 W/kg
SAR(1 g) = 0.763 W/kg; SAR(10 g) = 0.211 W/kg
 Maximum value of SAR (measured) = 1.65 W/kg

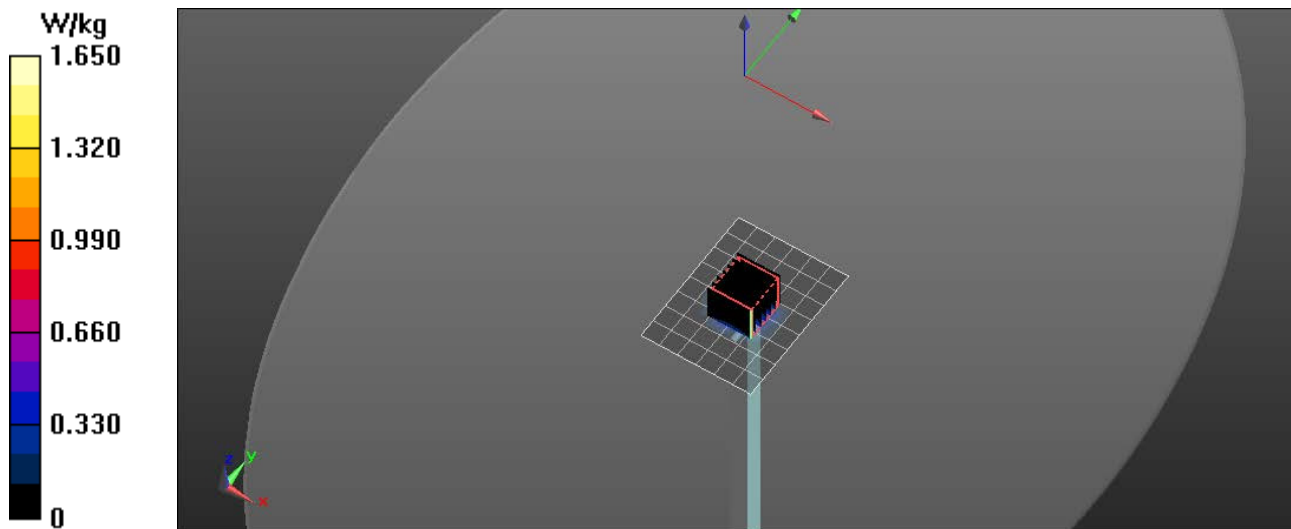

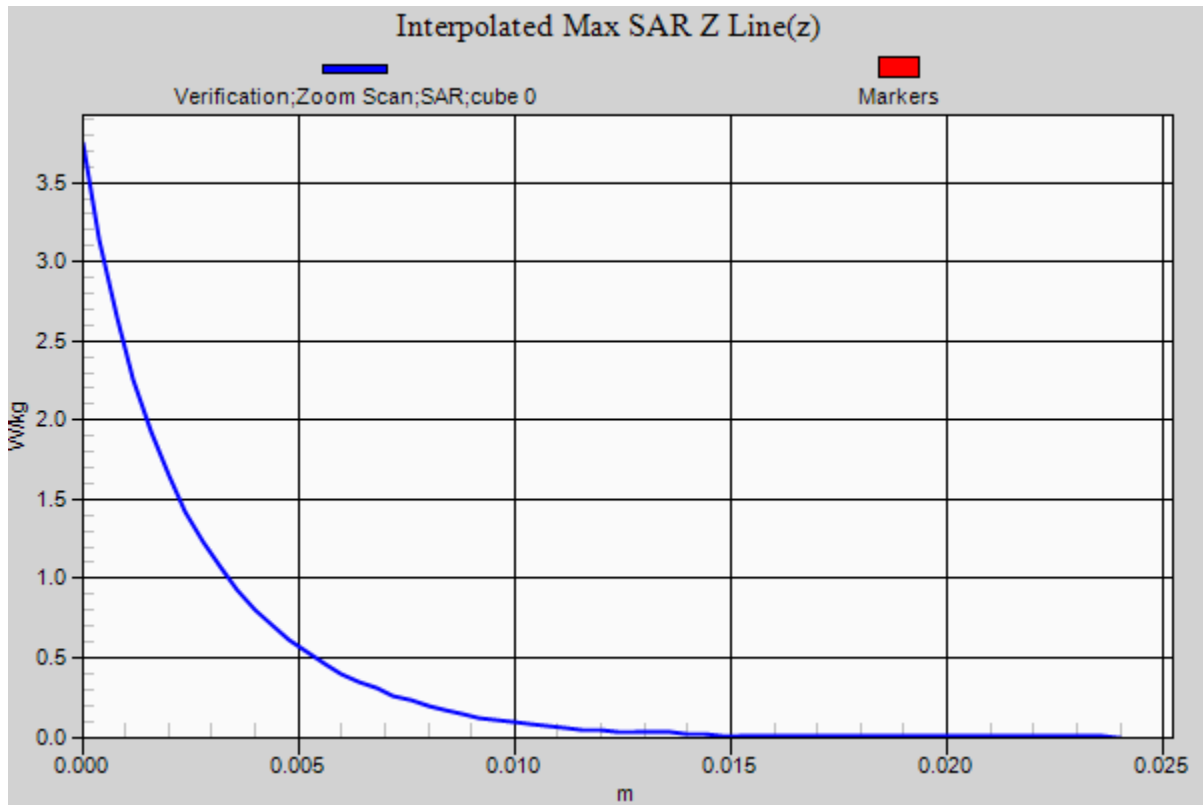

RF Exposure Lab

Plot 7

DUT: Dipole D5GHzV2; Type: D5GHzV2; Serial: D5GHzV2 - SN:1119

Communication System: CW; Frequency: 5600 MHz; Duty Cycle: 1:1
 Medium: MSL 3-6 GHz; Medium parameters used: $f = 5600$ MHz; $\sigma = 5.73$ S/m; $\epsilon_r = 48.47$; $\rho = 1000$ kg/m³
 Phantom section: Flat Section

Test Date: Date: 12/18/2015; Ambient Temp: 23 °C; Tissue Temp: 21 °C
 Probe: EX3DV4 - SN3662; ConvF(3.8, 3.8, 3.8); Calibrated: 4/27/2015;
 Sensor-Surface: 2mm (Mechanical Surface Detection)
 Electronics: DAE4 Sn1416; Calibrated: 4/15/2015
 Phantom: ELI v4.0; Type: QDOVA001BB; Serial: 1065
 Measurement SW: DASY52, Version 52.8 (8); SEMCAD X Version 14.6.10 (7331)

Procedure Notes:

5600 MHz Body/Verification/Area Scan (7x9x1): Measurement grid: dx=10mm, dy=10mm
 Maximum value of SAR (measured) = 1.64 W/kg

5600 MHz Body/Verification/Zoom Scan (7x7x12)/Cube 0: Measurement grid: dx=4mm, dy=4mm, dz=2mm
 Reference Value = 11.892 V/m; Power Drift = 0.01 dB
 Peak SAR (extrapolated) = 3.63 W/kg
SAR(1 g) = 0.783 W/kg; SAR(10 g) = 0.216 W/kg
 Maximum value of SAR (measured) = 1.70 W/kg

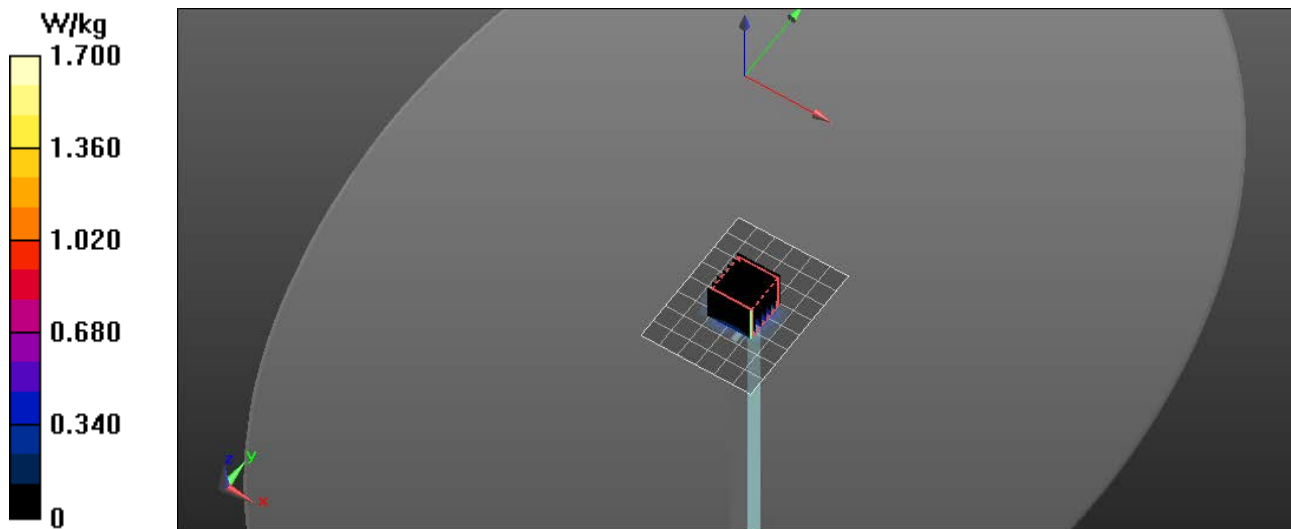

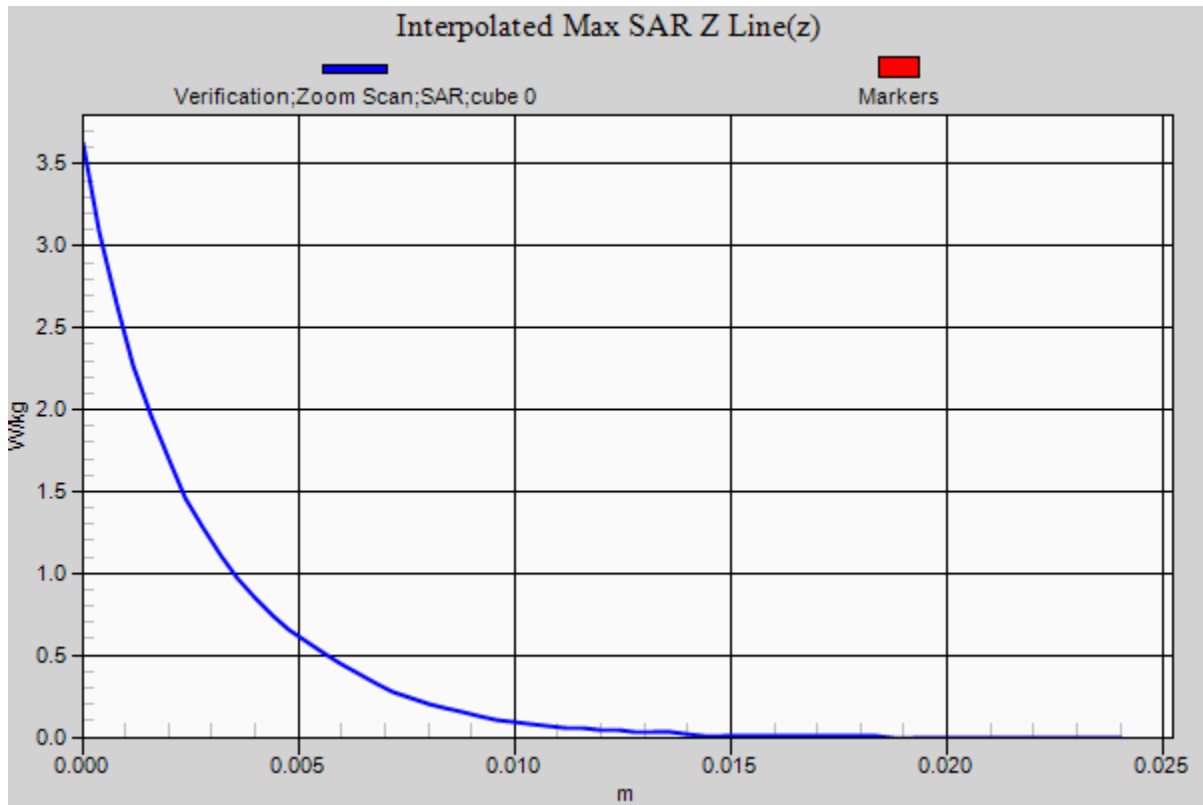

RF Exposure Lab

Plot 8

DUT: Dipole D5GHzV2; Type: D5GHzV2; Serial: D5GHzV2 - SN:1119

Communication System: CW; Frequency: 5800 MHz; Duty Cycle: 1:1
 Medium: MSL 3-6 GHz; Medium parameters used: $f = 5800$ MHz; $\sigma = 5.99$ S/m; $\epsilon_r = 48.17$; $\rho = 1000$ kg/m³
 Phantom section: Flat Section

Test Date: Date: 12/18/2015; Ambient Temp: 23 °C; Tissue Temp: 21 °C
 Probe: EX3DV4 - SN3662; ConvF(3.99, 3.99, 3.99); Calibrated: 4/27/2015;
 Sensor-Surface: 2mm (Mechanical Surface Detection)
 Electronics: DAE4 Sn1416; Calibrated: 4/15/2015
 Phantom: ELI v4.0; Type: QDOVA001BB; Serial: 1065
 Measurement SW: DASY52, Version 52.8 (8); SEMCAD X Version 14.6.10 (7331)

Procedure Notes:

5800 MHz Body/Verification/Area Scan (7x9x1): Measurement grid: dx=10mm, dy=10mm
 Maximum value of SAR (measured) = 1.56 W/kg

5800 MHz Body/Verification/Zoom Scan (7x7x12)/Cube 0: Measurement grid: dx=4mm, dy=4mm, dz=2mm
 Reference Value = 11.621 V/m; Power Drift = -0.01 dB
 Peak SAR (extrapolated) = 3.47 W/kg
SAR(1 g) = 0.749 W/kg; SAR(10 g) = 0.208 W/kg
 Maximum value of SAR (measured) = 1.63 W/kg

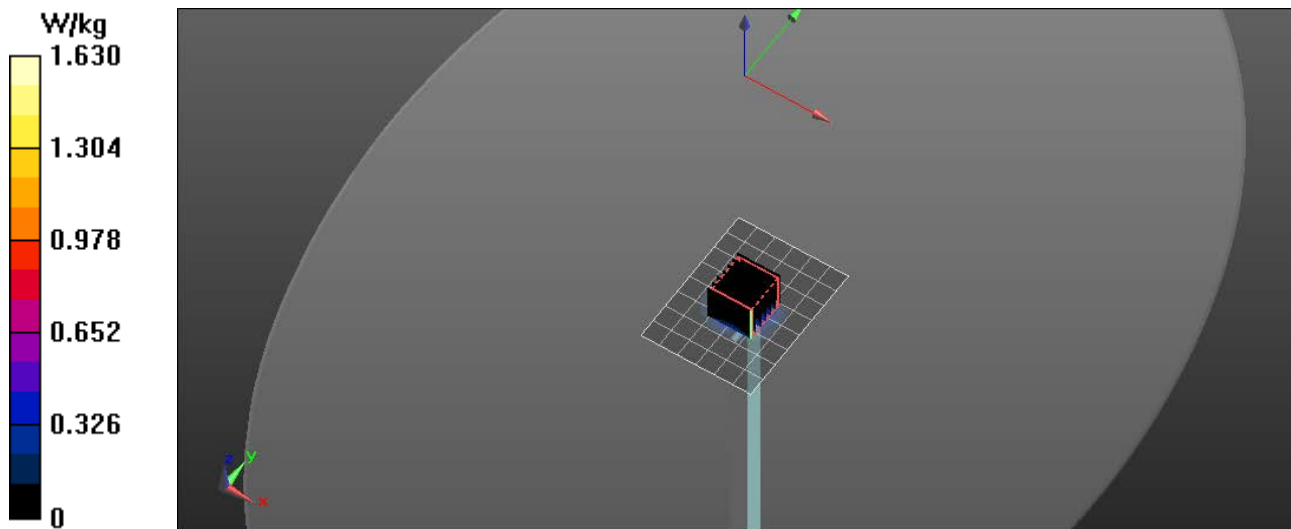

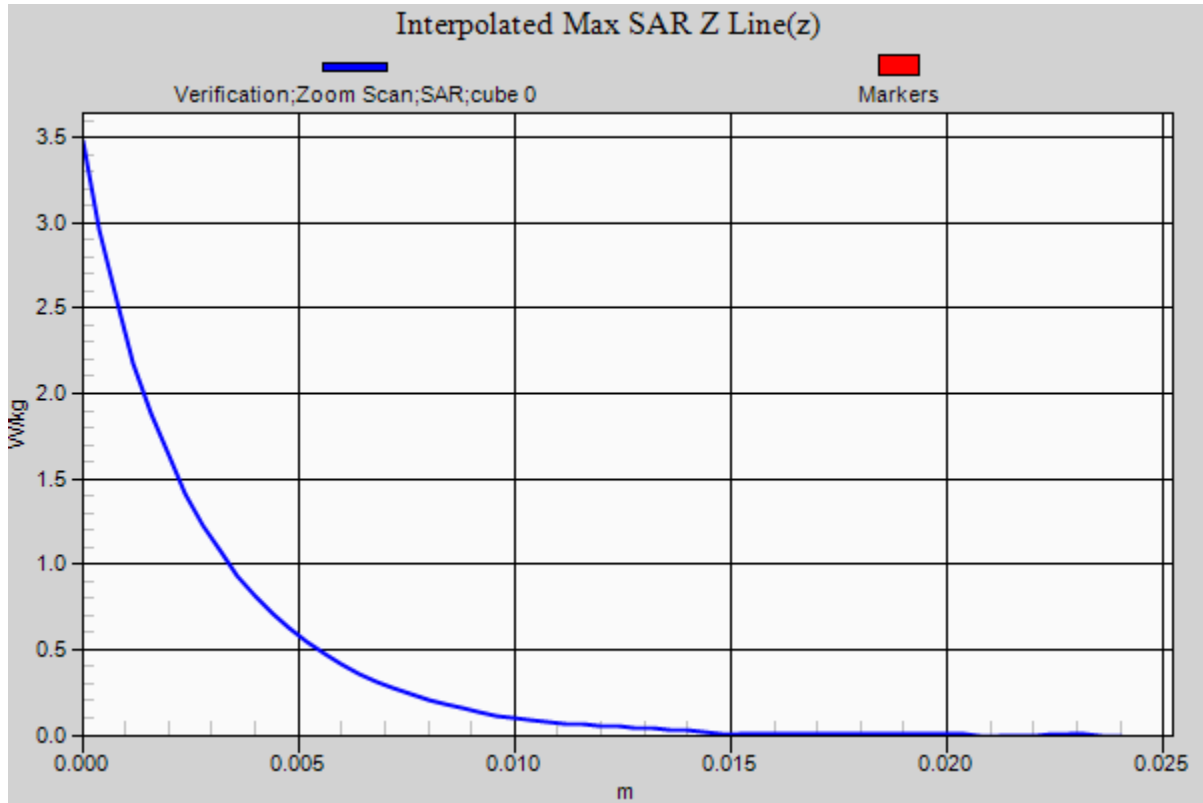

RF Exposure Lab

Plot 9

DUT: Dipole 2450 MHz D2450V2; Type: D2450V2; Serial: D2450V2 - SN:881

Communication System: CW; Frequency: 2450 MHz; Duty Cycle: 1:1
 Medium: MSL2450; Medium parameters used: $f = 2450$ MHz; $\sigma = 1.96$ S/m; $\epsilon_r = 52.64$; $\rho = 1000$ kg/m³
 Phantom section: Flat Section

Test Date: Date: 3/19/2016; Ambient Temp: 23 °C; Tissue Temp: 21 °C
 Probe: EX3DV4 - SN3833; ConvF(6.87, 6.87, 6.87); Calibrated: 1/27/2016;
 Sensor-Surface: 2mm (Mechanical Surface Detection)
 Electronics: DAE4 Sn1321; Calibrated: 1/14/2016
 Phantom: ELI v4.0; Type: QDOVA001BB; Serial: 1251
 Measurement SW: DASY52, Version 52.8 (8); SEMCAD X Version 14.6.10 (7331)

Procedure Notes:

2450 MHz Body/Verification/Area Scan (61x81x1): Interpolated grid: dx=1.000 mm, dy=1.000 mm
 Maximum value of SAR (interpolated) = 8.68 W/kg

2450 MHz Body/Verification/Zoom Scan (7x7x7)/Cube 0: Measurement grid: dx=5mm, dy=5mm, dz=5mm
 Reference Value = 55.751 V/m; Power Drift = -0.01 dB
 Peak SAR (extrapolated) = 10.7 W/kg
SAR(1 g) = 5.2 W/kg; SAR(10 g) = 2.4 W/kg
 Maximum value of SAR (measured) = 5.91 W/kg

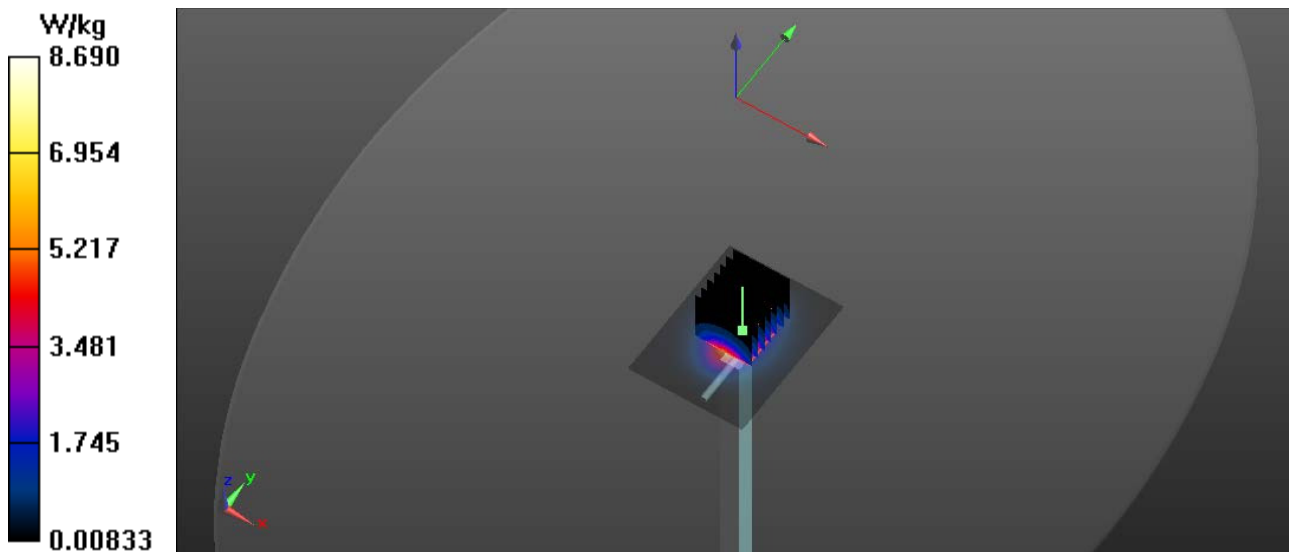

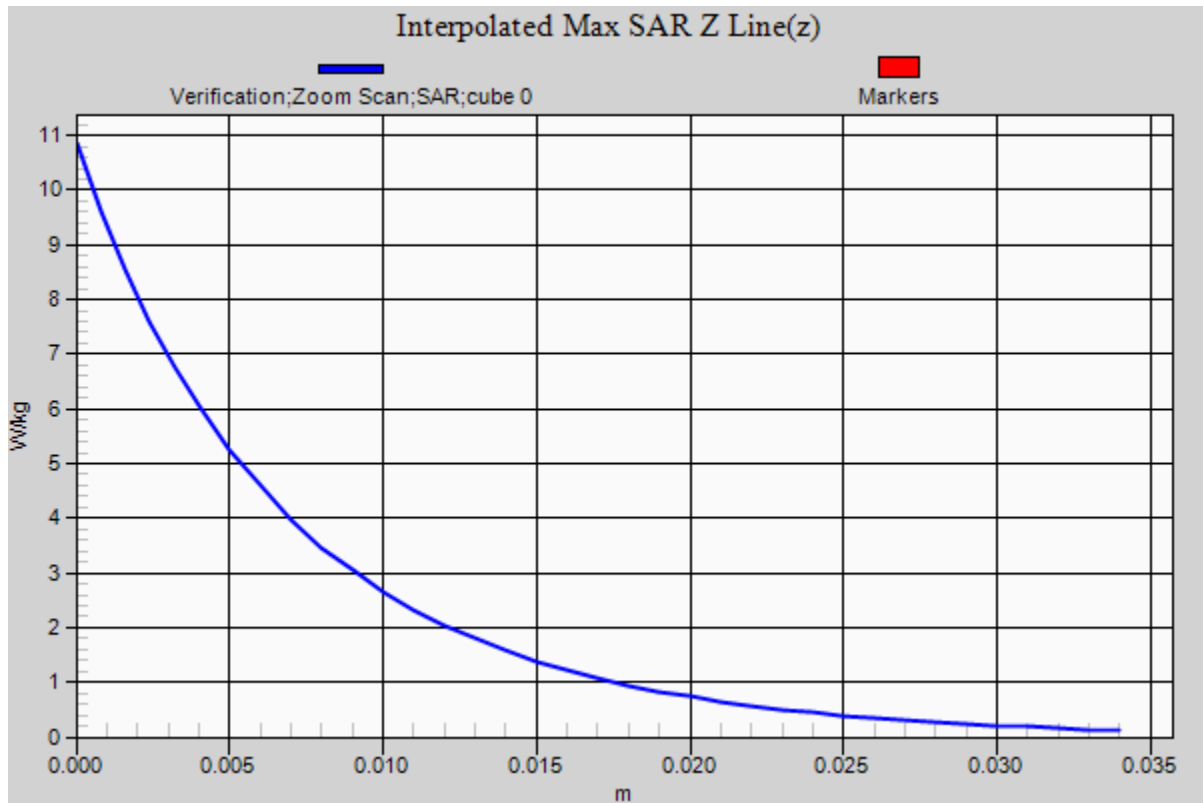

RF Exposure Lab

Plot 10

DUT: Dipole 900 MHz D900V2; Type: D900V2; Serial: D900V2 - SN: 1d128

Communication System: CW; Frequency: 900 MHz; Duty Cycle: 1:1
 Medium: MSL900; Medium parameters used: $f = 900 \text{ MHz}$; $\sigma = 1.07 \text{ S/m}$; $\epsilon_r = 54.83$; $\rho = 1000 \text{ kg/m}^3$
 Phantom section: Flat Section

Test Date: Date: 11/30/2016; Ambient Temp: 23 °C; Tissue Temp: 21 °C
 Probe: EX3DV4 - SN3662; ConvF(8.94, 8.94, 8.94); Calibrated: 4/27/2016;
 Sensor-Surface: 2mm (Mechanical Surface Detection)
 Electronics: DAE4 Sn759; Calibrated: 8/17/2016
 Phantom: ELI v5.0; Type: QDOVA002AA; Serial: 2037
 Measurement SW: DASY52, Version 52.8 (8); SEMCAD X Version 14.6.10 (7331)

Procedure Notes:

900 MHz Body/Verification/Area Scan (41x81x1): Interpolated grid: $dx=1.500 \text{ mm}$, $dy=1.500 \text{ mm}$
 Maximum value of SAR (interpolated) = 1.09 W/kg

900 MHz Body/Verification/Zoom Scan (5x5x7)/Cube 0: Measurement grid: $dx=8\text{mm}$, $dy=8\text{mm}$, $dz=5\text{mm}$
 Reference Value = 33.592 V/m; Power Drift = -0.02 dB
 Peak SAR (extrapolated) = 1.43 W/kg
SAR(1 g) = 1.1 W/kg; SAR(10 g) = 0.621 W/kg
 Maximum value of SAR (measured) = 1.10 W/kg

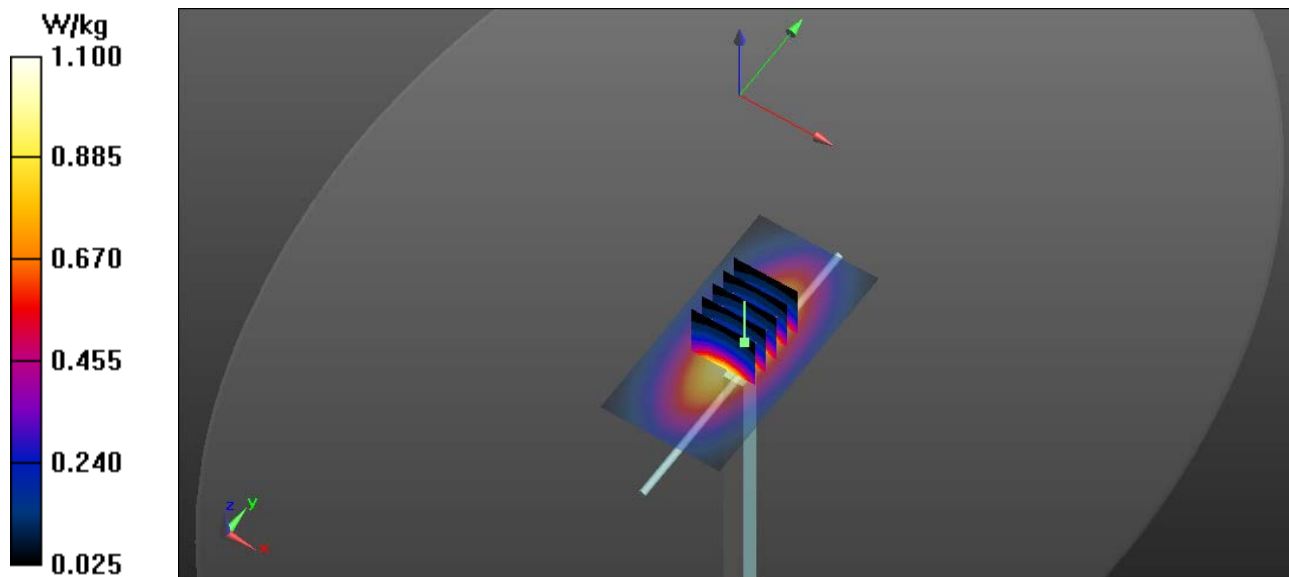

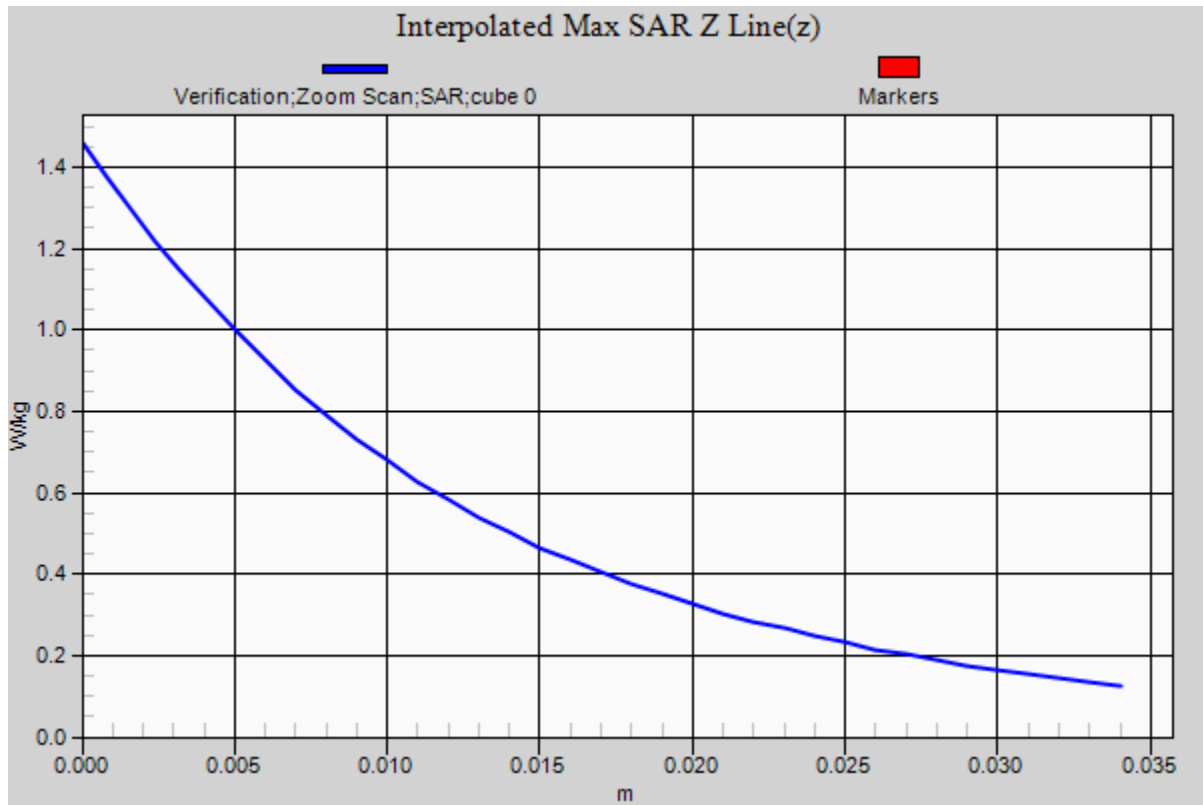

Appendix B – SAR Test Data Plots

RF Exposure Lab

Plot 1

DUT: MS2GCR; Type: Tablet Computer; Serial: MS2P41

Communication System: LTE (SC-FDMA, 1 RB, 10 MHz, QPSK); Frequency: 710 MHz; Duty Cycle: 1:1
 Medium: MSL750; Medium parameters used (interpolated): $f = 710 \text{ MHz}$; $\sigma = 0.9 \text{ S/m}$; $\epsilon_r = 54.92$; $\rho = 1000 \text{ kg/m}^3$
 Phantom section: Flat Section

Test Date: Date: 12/30/2015; Ambient Temp: 23 °C; Tissue Temp: 21 °C

Probe: EX3DV4 - SN3662; ConvF(9.42, 9.42, 9.42); Calibrated: 4/27/2015;
 Sensor-Surface: 2mm (Mechanical Surface Detection)
 Electronics: DAE4 Sn1416; Calibrated: 4/15/2015
 Phantom: ELI v4.0; Type: QDOVA001BB; Serial: 1065
 Measurement SW: DASY52, Version 52.8 (8); SEMCAD X Version 14.6.10 (7331)

Procedure Notes:

750 MHz LTE B17/Back Mid 1RB 0 Offset/Area Scan (7x9x1): Measurement grid: dx=15mm, dy=15mm

[Info: Interpolated medium parameters used for SAR evaluation.](#)

Maximum value of SAR (measured) = 0.402 W/kg

750 MHz LTE B17/Back Mid 1RB 0 Offset/Zoom Scan (5x5x7)/Cube 0: Measurement grid: dx=8mm, dy=8mm, dz=5mm

Reference Value = 20.73 V/m; Power Drift = -0.03 dB

Peak SAR (extrapolated) = 0.728 W/kg

SAR(1 g) = 0.392 W/kg; SAR(10 g) = 0.225 W/kg

[Info: Interpolated medium parameters used for SAR evaluation.](#)

Maximum value of SAR (measured) = 0.557 W/kg

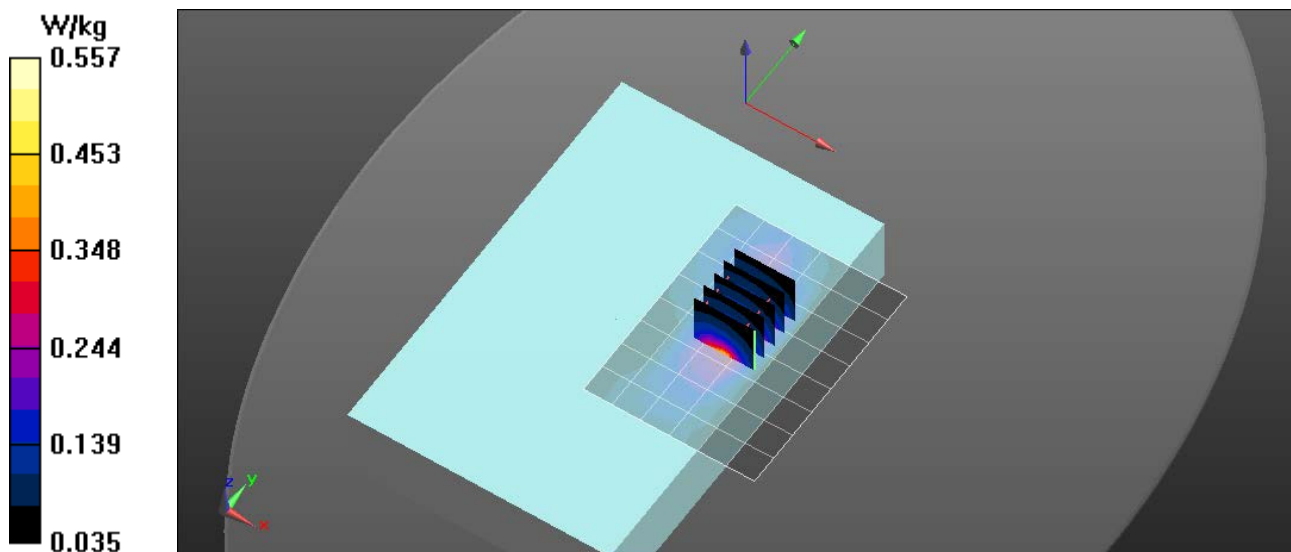

RF Exposure Lab

Plot 2

DUT: MS2GCR; Type: Tablet Computer; Serial: MS2P41

Communication System: LTE (SC-FDMA, 1 RB, 10 MHz, QPSK); Frequency: 782 MHz; Duty Cycle: 1:1
 Medium: MSL750; Medium parameters used (interpolated): $f = 782 \text{ MHz}$; $\sigma = 0.972 \text{ S/m}$; $\epsilon_r = 54.556$; $\rho = 1000 \text{ kg/m}^3$
 Phantom section: Flat Section

Test Date: Date: 12/30/2015; Ambient Temp: 23 °C; Tissue Temp: 21 °C

Probe: EX3DV4 - SN3662; ConvF(9.42, 9.42, 9.42); Calibrated: 4/27/2015;
 Sensor-Surface: 2mm (Mechanical Surface Detection)
 Electronics: DAE4 Sn1416; Calibrated: 4/15/2015
 Phantom: ELI v4.0; Type: QDOVA001BB; Serial: 1065
 Measurement SW: DASY52, Version 52.8 (8); SEMCAD X Version 14.6.10 (7331)

Procedure Notes:

750 MHz LTE B13/Back Mid 1RB 0 Offset/Area Scan (7x9x1): Measurement grid: dx=15mm, dy=15mm

[Info: Interpolated medium parameters used for SAR evaluation.](#)

Maximum value of SAR (measured) = 0.743 W/kg

750 MHz LTE B13/Back Mid 1RB 0 Offset/Zoom Scan (5x5x7)/Cube 0: Measurement grid: dx=8mm, dy=8mm, dz=5mm

Reference Value = 22.91 V/m; Power Drift = 0.04 dB

Peak SAR (extrapolated) = 1.24 W/kg

SAR(1 g) = 0.721 W/kg; SAR(10 g) = 0.414 W/kg

[Info: Interpolated medium parameters used for SAR evaluation.](#)

Maximum value of SAR (measured) = 0.983 W/kg

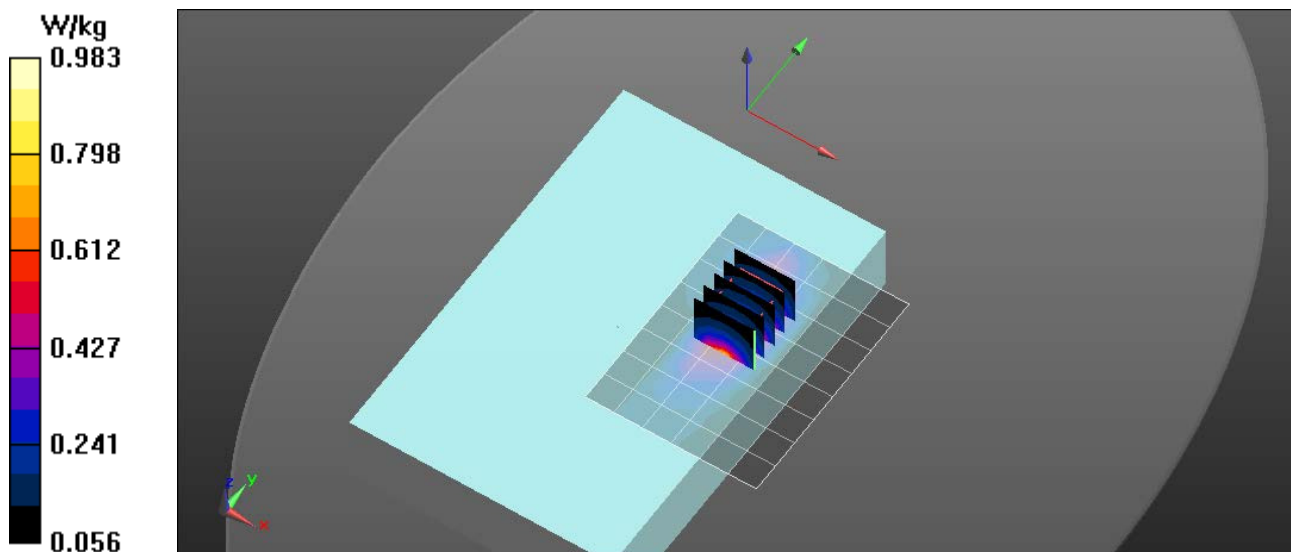

RF Exposure Lab

Plot 3

DUT: MS2GCR; Type: Tablet Computer; Serial: MS2P41

Communication System: CDMA2000 (1xRTT); Frequency: 817.25 MHz; Duty Cycle: 1:1
 Medium: MSL835; Medium parameters used (interpolated): $f = 817.25$ MHz; $\sigma = 0.952$ S/m; $\epsilon_r = 54.292$; $\rho = 1000$ kg/m³
 Phantom section: Flat Section

Test Date: Date: 12/29/2015; Ambient Temp: 23 °C; Tissue Temp: 21 °C

Probe: EX3DV4 - SN3662; ConvF(8.86, 8.86, 8.86); Calibrated: 4/27/2015;
 Sensor-Surface: 2mm (Mechanical Surface Detection)
 Electronics: DAE4 Sn1416; Calibrated: 4/15/2015
 Phantom: ELI v4.0; Type: QDOVA001BB; Serial: 1065
 Measurement SW: DASY52, Version 52.8 (8); SEMCAD X Version 14.6.10 (7331)

Procedure Notes:

835 MHz CDMA/Back Low/Area Scan (7x9x1): Measurement grid: dx=15mm, dy=15mm

[Info: Interpolated medium parameters used for SAR evaluation.](#)

Maximum value of SAR (measured) = 1.26 W/kg

835 MHz CDMA/Back Low/Zoom Scan (5x5x7)/Cube 0: Measurement grid: dx=8mm, dy=8mm, dz=5mm

Reference Value = 26.69 V/m; Power Drift = -0.02 dB

Peak SAR (extrapolated) = 1.83 W/kg

SAR(1 g) = 1.11 W/kg; SAR(10 g) = 0.585 W/kg

[Info: Interpolated medium parameters used for SAR evaluation.](#)

Maximum value of SAR (measured) = 1.28 W/kg

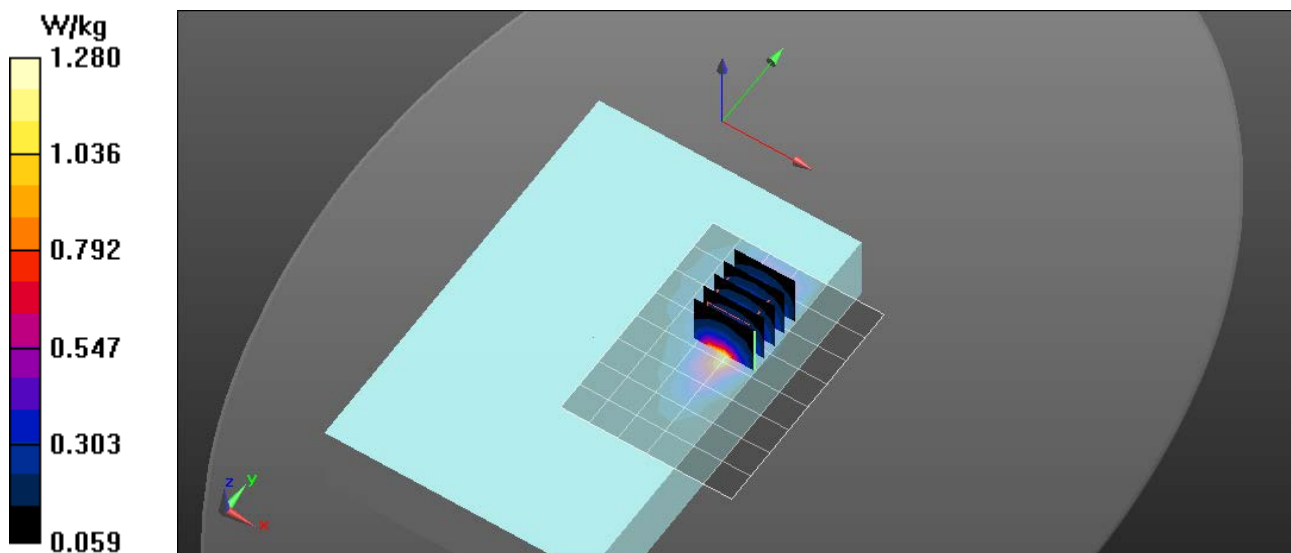

RF Exposure Lab

Plot 4

DUT: MS2GCR; Type: Tablet Computer; Serial: MS2P41

Communication System: GPRS 2-Slot (GMSK); Frequency: 836.6 MHz; Duty Cycle: 1:4.00037
 Medium: MSL835; Medium parameters used (interpolated): $f = 836.6$ MHz; $\sigma = 0.982$ S/m; $\epsilon_r = 54.375$; $\rho = 1000$ kg/m³
 Phantom section: Flat Section

Test Date: Date: 12/30/2015; Ambient Temp: 23 °C; Tissue Temp: 21 °C

Probe: EX3DV4 - SN3662; ConvF(8.86, 8.86, 8.86); Calibrated: 4/27/2015;
 Sensor-Surface: 2mm (Mechanical Surface Detection)
 Electronics: DAE4 Sn1416; Calibrated: 4/15/2015
 Phantom: ELI v4.0; Type: QDOVA001BB; Serial: 1065
 Measurement SW: DASY52, Version 52.8 (8); SEMCAD X Version 14.6.10 (7331)

Procedure Notes:

835 MHz GSM/Back Mid/Area Scan (7x9x1): Measurement grid: dx=15mm, dy=15mm

[Info: Interpolated medium parameters used for SAR evaluation.](#)

Maximum value of SAR (measured) = 1.47 W/kg

835 MHz GSM/Back Mid/Zoom Scan (5x5x7)/Cube 0: Measurement grid: dx=8mm, dy=8mm, dz=5mm

Reference Value = 30.53 V/m; Power Drift = -0.02 dB

Peak SAR (extrapolated) = 1.97 W/kg

SAR(1 g) = 1.09 W/kg; SAR(10 g) = 0.596 W/kg

[Info: Interpolated medium parameters used for SAR evaluation.](#)

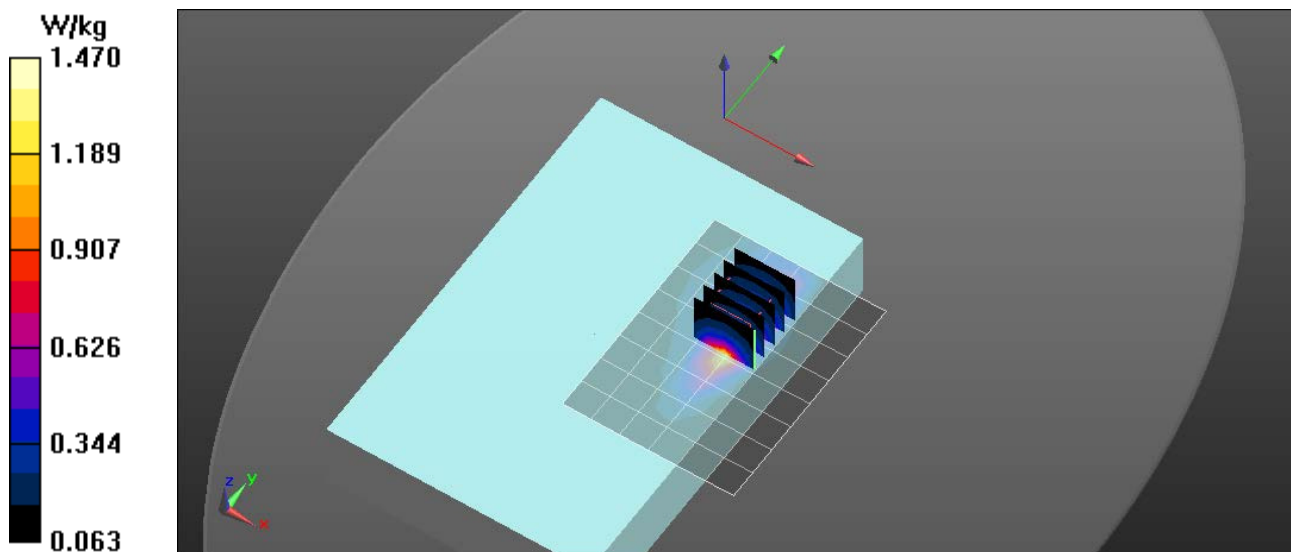

RF Exposure Lab

Plot 5

DUT: MS2GCR; Type: Tablet Computer; Serial: MS2P41

Communication System: UMTS (WCDMA); Frequency: 836.6 MHz; Duty Cycle: 1:1
 Medium: MSL835; Medium parameters used (interpolated): $f = 836.6$ MHz; $\sigma = 0.982$ S/m; $\epsilon_r = 54.375$; $\rho = 1000$ kg/m³
 Phantom section: Flat Section

Test Date: Date: 12/30/2015; Ambient Temp: 23 °C; Tissue Temp: 21 °C

Probe: EX3DV4 - SN3662; ConvF(8.86, 8.86, 8.86); Calibrated: 4/27/2015;
 Sensor-Surface: 2mm (Mechanical Surface Detection)
 Electronics: DAE4 Sn1416; Calibrated: 4/15/2015
 Phantom: ELI v4.0; Type: QDOVA001BB; Serial: 1065
 Measurement SW: DASY52, Version 52.8 (8); SEMCAD X Version 14.6.10 (7331)

Procedure Notes:

835 MHz WCDMA/Back Mid/Area Scan (7x9x1): Measurement grid: dx=15mm, dy=15mm

[Info: Interpolated medium parameters used for SAR evaluation.](#)

Maximum value of SAR (measured) = 1.18 W/kg

835 MHz WCDMA/Back Mid/Zoom Scan (5x5x7)/Cube 0: Measurement grid: dx=8mm, dy=8mm, dz=5mm

Reference Value = 28.04 V/m; Power Drift = -0.01 dB

Peak SAR (extrapolated) = 1.66 W/kg

SAR(1 g) = 0.936 W/kg; SAR(10 g) = 0.521 W/kg

[Info: Interpolated medium parameters used for SAR evaluation.](#)

Maximum value of SAR (measured) = 1.28 W/kg

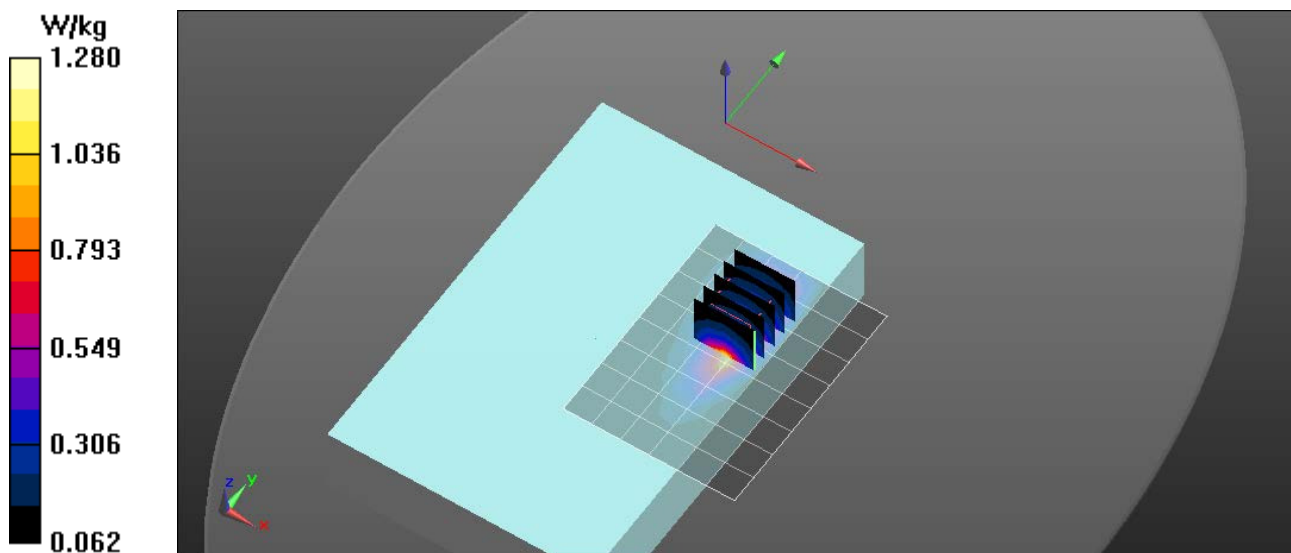

RF Exposure Lab

Plot 6

DUT: MS2GCR; Type: Tablet Computer; Serial: MS2P41

Communication System: LTE (SC-FDMA, 1 RB, 10 MHz, QPSK); Frequency: 836.5 MHz; Duty Cycle: 1:1
 Medium: MSL835; Medium parameters used (interpolated): $f = 836.5$ MHz; $\sigma = 0.982$ S/m; $\epsilon_r = 54.375$; $\rho = 1000$ kg/m³
 Phantom section: Flat Section

Test Date: Date: 12/29/2015; Ambient Temp: 23 °C; Tissue Temp: 21 °C

Probe: EX3DV4 - SN3662; ConvF(8.86, 8.86, 8.86); Calibrated: 4/27/2015;
 Sensor-Surface: 2mm (Mechanical Surface Detection)
 Electronics: DAE4 Sn1416; Calibrated: 4/15/2015
 Phantom: ELI v4.0; Type: QDOVA001BB; Serial: 1065
 Measurement SW: DASY52, Version 52.8 (8); SEMCAD X Version 14.6.10 (7331)

Procedure Notes:

850 MHz LTE/Back Mid 1RB 0 Offset/Area Scan (7x9x1): Measurement grid: dx=15mm, dy=15mm

[Info: Interpolated medium parameters used for SAR evaluation.](#)

Maximum value of SAR (measured) = 1.11 W/kg

850 MHz LTE/Back Mid 1RB 0 Offset/Zoom Scan (5x5x7)/Cube 0: Measurement grid: dx=8mm, dy=8mm, dz=5mm

Reference Value = 29.03 V/m; Power Drift = -0.03 dB

Peak SAR (extrapolated) = 1.57 W/kg

SAR(1 g) = 0.885 W/kg; SAR(10 g) = 0.497 W/kg

[Info: Interpolated medium parameters used for SAR evaluation.](#)

Maximum value of SAR (measured) = 1.16 W/kg

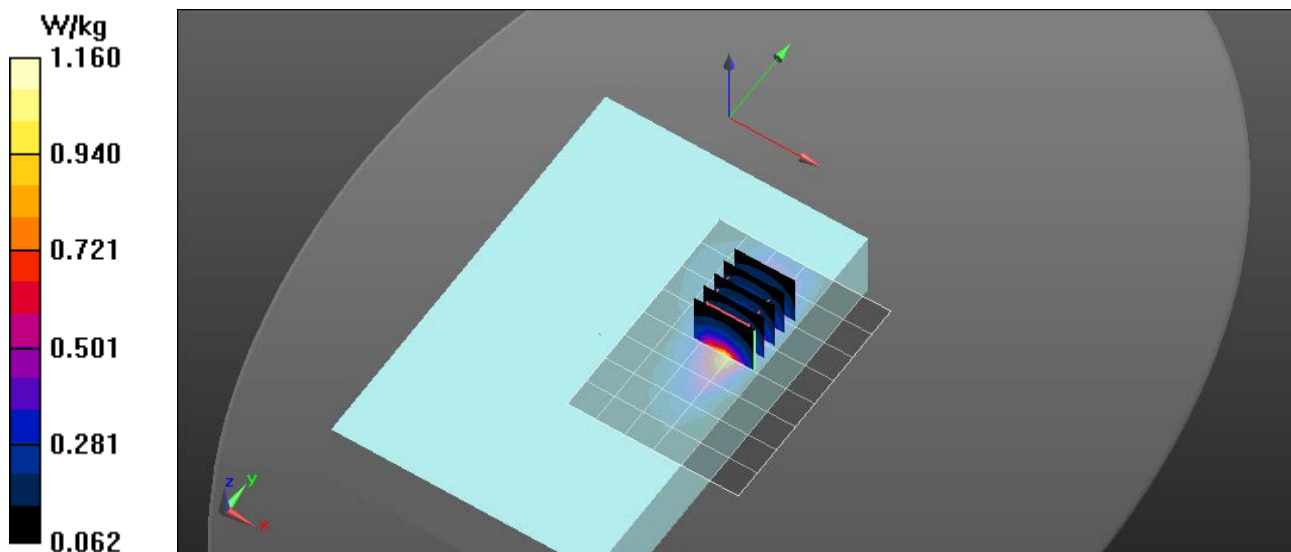

RF Exposure Lab

Plot 7

DUT: MS2GCR; Type: Tablet Computer; Serial: MS2P41

Communication System: UMTS (WCDMA); Frequency: 1732.6 MHz; Duty Cycle: 1:1
 Medium: MSL1750; Medium parameters used (interpolated): $f = 1732.6$ MHz; $\sigma = 1.55$ S/m; $\epsilon_r = 52.73$; $\rho = 1000$ kg/m³
 Phantom section: Flat Section

Test Date: Date: 12/28/2015; Ambient Temp: 23 °C; Tissue Temp: 21 °C

Probe: EX3DV4 - SN3662; ConvF(7.49, 7.49, 7.49); Calibrated: 4/27/2015;
 Sensor-Surface: 2mm (Mechanical Surface Detection)
 Electronics: DAE4 Sn1416; Calibrated: 4/15/2015
 Phantom: ELI v4.0; Type: QDOVA001BB; Serial: 1065
 Measurement SW: DASY52, Version 52.8 (8); SEMCAD X Version 14.6.10 (7331)

Procedure Notes:

1750 MHz WCDMA/Back Mid/Area Scan (7x9x1): Measurement grid: dx=15mm, dy=15mm

[Info: Interpolated medium parameters used for SAR evaluation.](#)

Maximum value of SAR (measured) = 2.23 W/kg

1750 MHz WCDMA/Back Mid/Zoom Scan (5x5x7)/Cube 0: Measurement grid: dx=8mm, dy=8mm, dz=5mm

Reference Value = 34.90 V/m; Power Drift = -0.02 dB

Peak SAR (extrapolated) = 2.77 W/kg

SAR(1 g) = 1.27 W/kg; SAR(10 g) = 0.704 W/kg

[Info: Interpolated medium parameters used for SAR evaluation.](#)

Maximum value of SAR (measured) = 2.02 W/kg

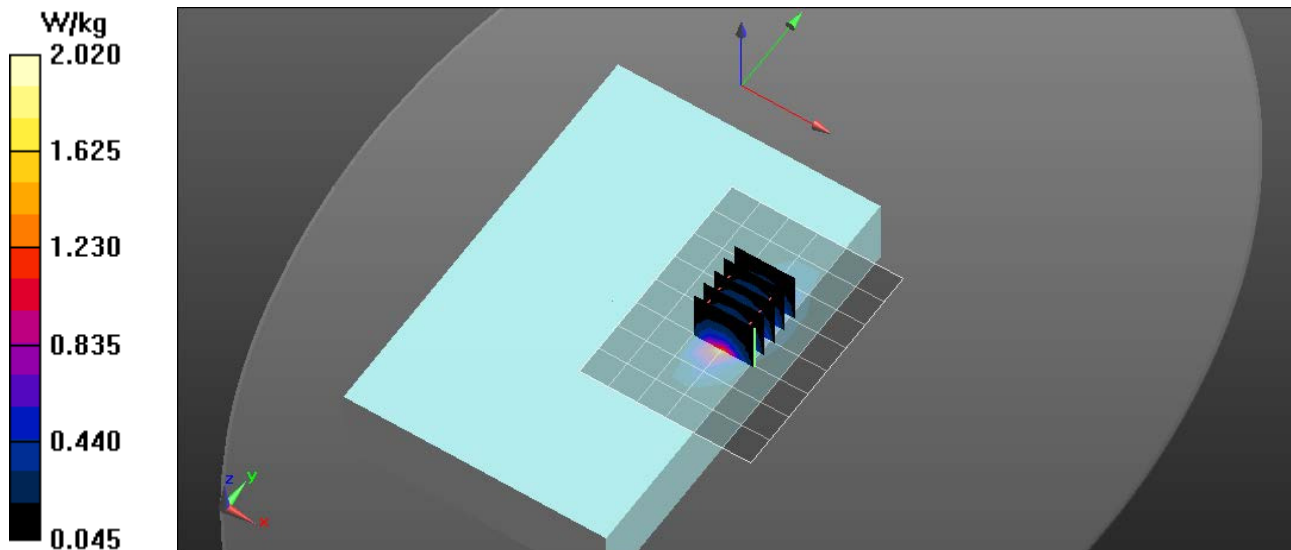

RF Exposure Lab

Plot 8

DUT: MS2GCR; Type: Tablet Computer; Serial: MS2P41

Communication System: LTE (SC-FDMA, 1 RB, 20 MHz, QPSK); Frequency: 1732.5 MHz; Duty Cycle: 1:1
 Medium: MSL1750; Medium parameters used (interpolated): $f = 1732.5$ MHz; $\sigma = 1.55$ S/m; $\epsilon_r = 52.73$; $\rho = 1000$ kg/m³
 Phantom section: Flat Section

Test Date: Date: 12/28/2015; Ambient Temp: 23 °C; Tissue Temp: 21 °C

Probe: EX3DV4 - SN3662; ConvF(7.49, 7.49, 7.49); Calibrated: 4/27/2015;
 Sensor-Surface: 2mm (Mechanical Surface Detection)
 Electronics: DAE4 Sn1416; Calibrated: 4/15/2015
 Phantom: ELI v4.0; Type: QDOVA001BB; Serial: 1065
 Measurement SW: DASY52, Version 52.8 (8); SEMCAD X Version 14.6.10 (7331)

Procedure Notes:

1750 MHz LTE/Back Mid 1RB 0 Offset/Area Scan (7x9x1): Measurement grid: dx=15mm, dy=15mm

[Info: Interpolated medium parameters used for SAR evaluation.](#)

Maximum value of SAR (measured) = 2.22 W/kg

1750 MHz LTE/Back Mid 1RB 0 Offset/Zoom Scan (5x5x7)/Cube 0: Measurement grid: dx=8mm, dy=8mm, dz=5mm

Reference Value = 36.35 V/m; Power Drift = -0.02 dB

Peak SAR (extrapolated) = 2.85 W/kg

SAR(1 g) = 1.24 W/kg; SAR(10 g) = 0.746 W/kg

[Info: Interpolated medium parameters used for SAR evaluation.](#)

Maximum value of SAR (measured) = 2.11 W/kg

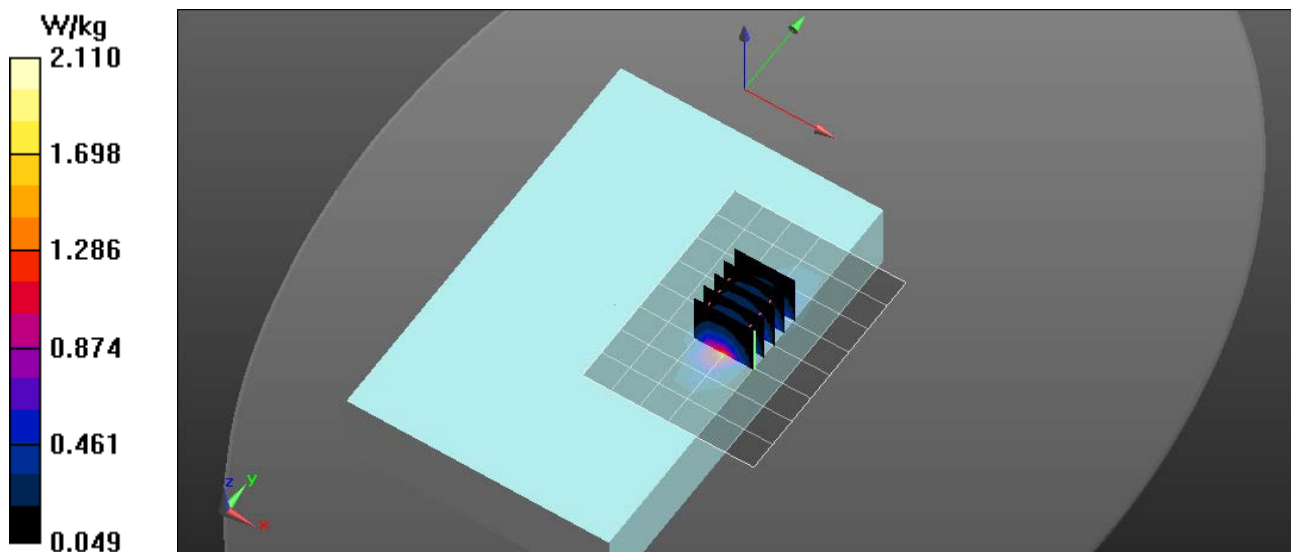

RF Exposure Lab

Plot 9

DUT: MS2GCR; Type: Tablet Computer; Serial: MS2P41

Communication System: CDMA2000 (1xRTT); Frequency: 1880 MHz; Duty Cycle: 1:1
 Medium: MSL1900; Medium parameters used: $f = 1880$ MHz; $\sigma = 1.52$ S/m; $\epsilon_r = 53.21$; $\rho = 1000$ kg/m³
 Phantom section: Flat Section

Test Date: Date: 12/22/2015; Ambient Temp: 23 °C; Tissue Temp: 21 °C

Probe: EX3DV4 - SN3662; ConvF(7.31, 7.31, 7.31); Calibrated: 4/27/2015;
 Sensor-Surface: 2mm (Mechanical Surface Detection)
 Electronics: DAE4 Sn1416; Calibrated: 4/15/2015
 Phantom: ELI v4.0; Type: QDOVA001BB; Serial: 1065
 Measurement SW: DASY52, Version 52.8 (8); SEMCAD X Version 14.6.10 (7331)

Procedure Notes:

1900 MHz CDMA/Back Mid/Area Scan (7x9x1): Measurement grid: dx=15mm, dy=15mm
 Maximum value of SAR (measured) = 2.07 W/kg

1900 MHz CDMA/Back Mid/Zoom Scan (5x5x7)/Cube 0: Measurement grid: dx=8mm, dy=8mm, dz=5mm
 Reference Value = 34.76 V/m; Power Drift = -0.01 dB
 Peak SAR (extrapolated) = 2.68 W/kg
SAR(1 g) = 1.23 W/kg; SAR(10 g) = 0.774 W/kg
 Maximum value of SAR (measured) = 2.10 W/kg

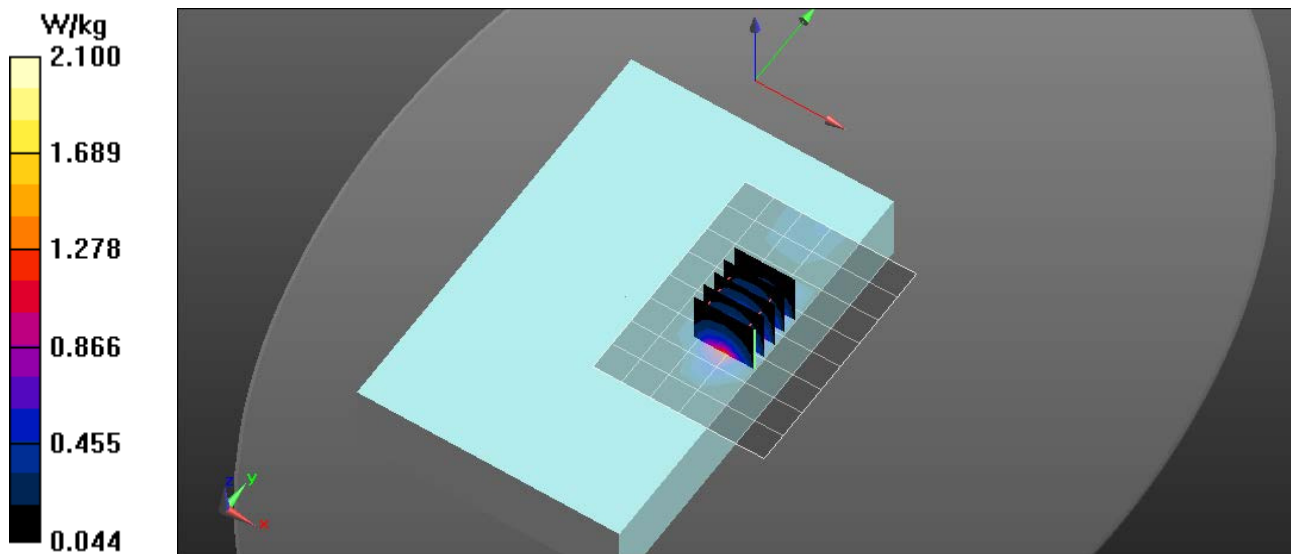

RF Exposure Lab

Plot 10

DUT: MS2GCR; Type: Tablet Computer; Serial: MS2P41

Communication System: GPRS 2-Slot (GMSK); Frequency: 1850.2 MHz; Duty Cycle: 1:4.00037
 Medium: MSL1900; Medium parameters used (interpolated): $f = 1850.2$ MHz; $\sigma = 1.49$ S/m; $\epsilon_r = 53.27$; $\rho = 1000$ kg/m³
 Phantom section: Flat Section

Test Date: Date: 12/23/2015; Ambient Temp: 23 °C; Tissue Temp: 21 °C

Probe: EX3DV4 - SN3662; ConvF(7.31, 7.31, 7.31); Calibrated: 4/27/2015;
 Sensor-Surface: 2mm (Mechanical Surface Detection)
 Electronics: DAE4 Sn1416; Calibrated: 4/15/2015
 Phantom: ELI v4.0; Type: QDOVA001BB; Serial: 1065
 Measurement SW: DASY52, Version 52.8 (8); SEMCAD X Version 14.6.10 (7331)

Procedure Notes:

1900 MHz GSM/Back Low/Area Scan (7x9x1): Measurement grid: dx=15mm, dy=15mm

[Info: Interpolated medium parameters used for SAR evaluation.](#)

Maximum value of SAR (measured) = 1.80 W/kg

1900 MHz GSM/Back Low/Zoom Scan (5x5x7)/Cube 0: Measurement grid: dx=8mm, dy=8mm, dz=5mm

Reference Value = 32.90 V/m; Power Drift = -0.02 dB

Peak SAR (extrapolated) = 2.44 W/kg

SAR(1 g) = 1.21 W/kg; SAR(10 g) = 0.714 W/kg

[Info: Interpolated medium parameters used for SAR evaluation.](#)

Maximum value of SAR (measured) = 1.92 W/kg

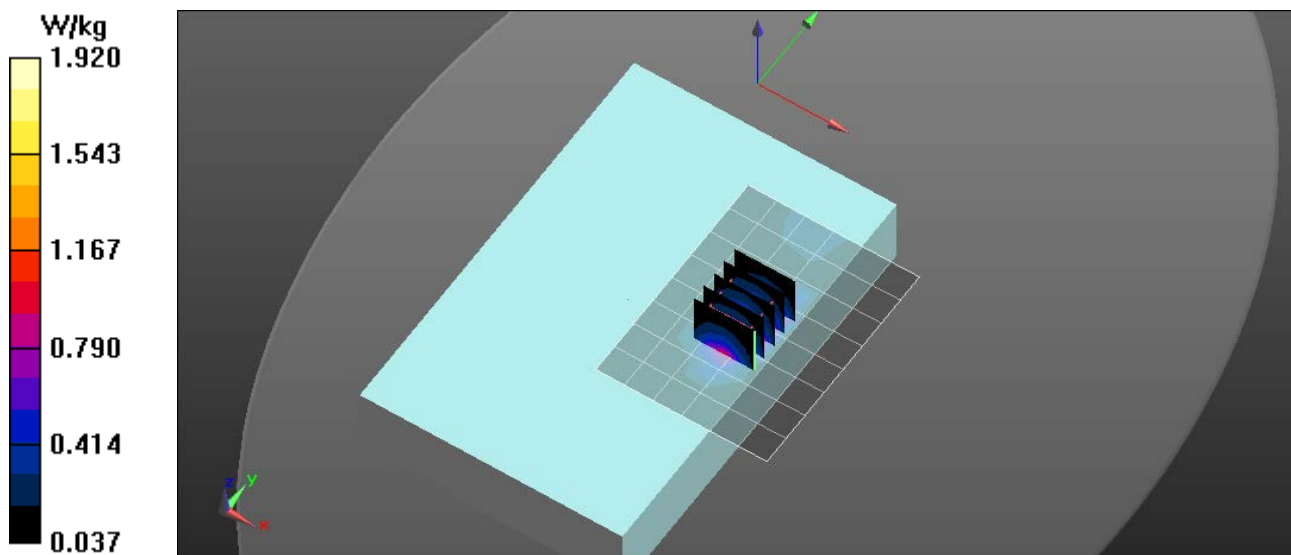

RF Exposure Lab

Plot 11

DUT: MS2GCR; Type: Tablet Computer; Serial: MS2P41

Communication System: UMTS (WCDMA); Frequency: 1880 MHz; Duty Cycle: 1:1
 Medium: MSL1900; Medium parameters used: $f = 1880$ MHz; $\sigma = 1.52$ S/m; $\epsilon_r = 53.21$; $\rho = 1000$ kg/m³
 Phantom section: Flat Section

Test Date: Date: 12/22/2015; Ambient Temp: 23 °C; Tissue Temp: 21 °C

Probe: EX3DV4 - SN3662; ConvF(7.31, 7.31, 7.31); Calibrated: 4/27/2015;
 Sensor-Surface: 2mm (Mechanical Surface Detection)
 Electronics: DAE4 Sn1416; Calibrated: 4/15/2015
 Phantom: ELI v4.0; Type: QDOVA001BB; Serial: 1065
 Measurement SW: DASY52, Version 52.8 (8); SEMCAD X Version 14.6.10 (7331)

Procedure Notes:

1900 MHz WCDMA/Back Mid/Area Scan (7x9x1): Measurement grid: dx=15mm, dy=15mm
 Maximum value of SAR (measured) = 2.05 W/kg

1900 MHz WCDMA/Back Mid/Zoom Scan (5x5x7)/Cube 0: Measurement grid: dx=8mm, dy=8mm, dz=5mm
 Reference Value = 34.20 V/m; Power Drift = -0.01 dB
 Peak SAR (extrapolated) = 2.54 W/kg
SAR(1 g) = 1.27 W/kg; SAR(10 g) = 0.748 W/kg
 Maximum value of SAR (measured) = 2.04 W/kg

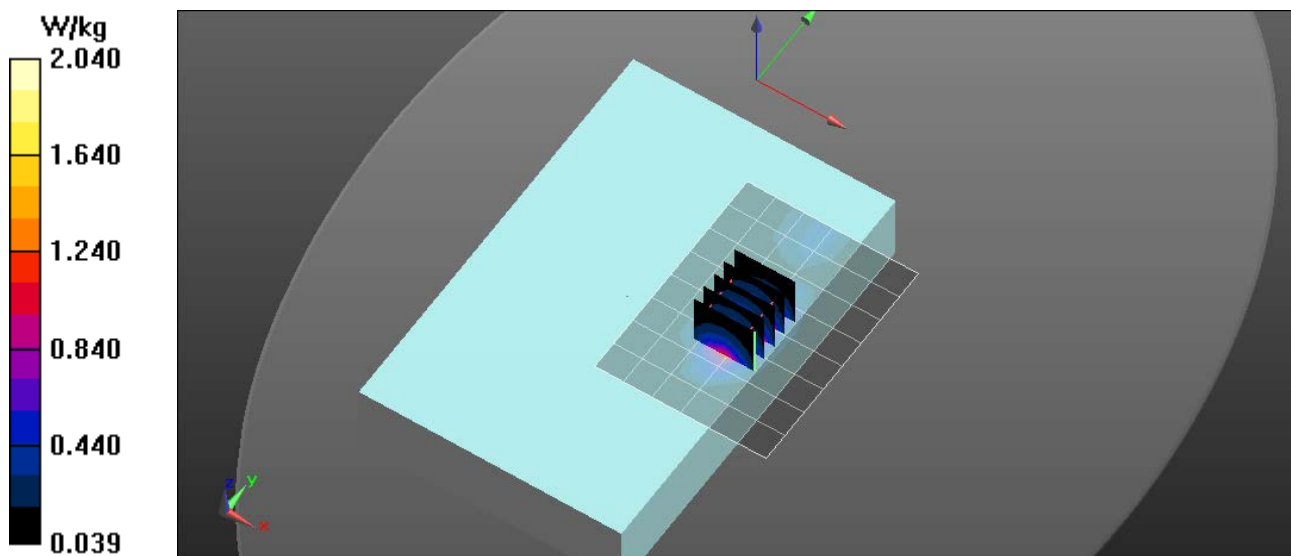

RF Exposure Lab

Plot 12

DUT: MS2GCR; Type: Tablet Computer; Serial: MS2P41

Communication System: LTE (SC-FDMA, 1 RB, 20 MHz, QPSK); Frequency: 1880 MHz; Duty Cycle: 1:1
 Medium: MSL1900; Medium parameters used: $f = 1880$ MHz; $\sigma = 1.52$ S/m; $\epsilon_r = 53.21$; $\rho = 1000$ kg/m³
 Phantom section: Flat Section

Test Date: Date: 12/23/2015; Ambient Temp: 23 °C; Tissue Temp: 21 °C

Probe: EX3DV4 - SN3662; ConvF(7.31, 7.31, 7.31); Calibrated: 4/27/2015;
 Sensor-Surface: 2mm (Mechanical Surface Detection)
 Electronics: DAE4 Sn1416; Calibrated: 4/15/2015
 Phantom: ELI v4.0; Type: QDOVA001BB; Serial: 1065
 Measurement SW: DASY52, Version 52.8 (8); SEMCAD X Version 14.6.10 (7331)

Procedure Notes:

1900 MHz LTE/Back Mid 1RB 0 Offset/Area Scan (7x9x1): Measurement grid: dx=15mm, dy=15mm
 Maximum value of SAR (measured) = 2.01 W/kg

1900 MHz LTE/Back Mid 1RB 0 Offset/Zoom Scan (5x5x7)/Cube 0: Measurement grid: dx=8mm, dy=8mm, dz=5mm
 Reference Value = 33.10 V/m; Power Drift = -0.01 dB
 Peak SAR (extrapolated) = 2.42 W/kg
SAR(1 g) = 1.21 W/kg; SAR(10 g) = 0.720 W/kg
 Maximum value of SAR (measured) = 1.91 W/kg

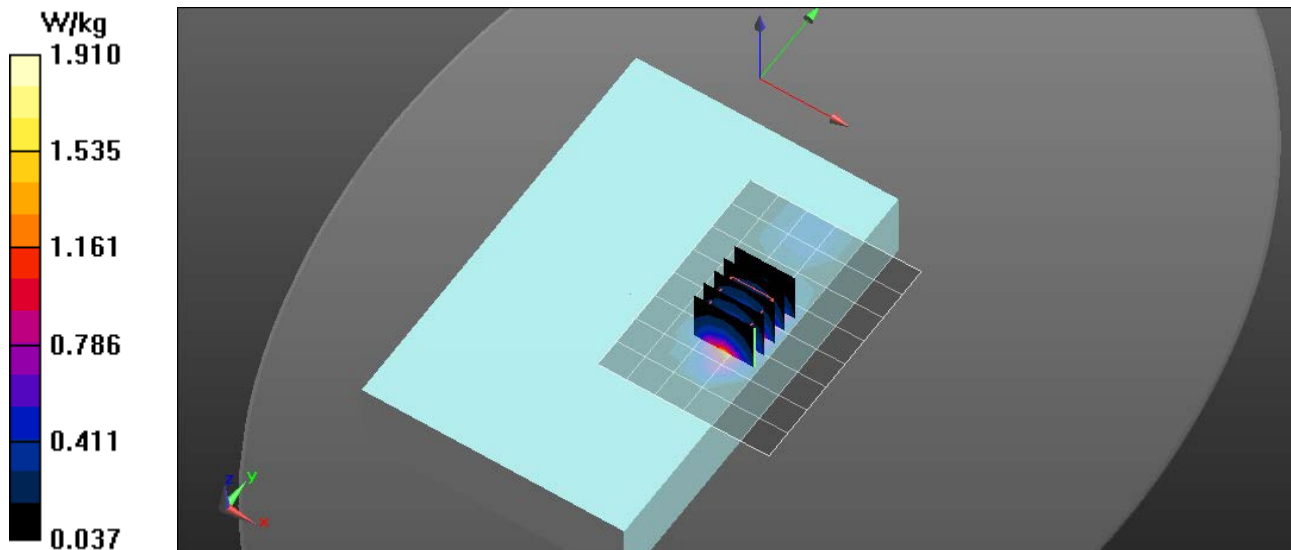

RF Exposure Lab

Plot 13

DUT: MS2GCR; Type: Tablet Computer; Serial: MS2P41

Communication System: WiFi 802.11b (DSSS, 1 Mbps); Frequency: 2437 MHz; Duty Cycle: 1:1
 Medium: MSL2450; Medium parameters used (interpolated): $f = 2437$ MHz; $\sigma = 1.907$ S/m; $\epsilon_r = 52.796$; $\rho = 1000$ kg/m³
 Phantom section: Flat Section

Test Date: Date: 12/17/2015; Ambient Temp: 23 °C; Tissue Temp: 21 °C

Probe: EX3DV4 - SN3662; ConvF(7.08, 7.08, 7.08); Calibrated: 4/27/2015;
 Sensor-Surface: 2mm (Mechanical Surface Detection)
 Electronics: DAE4 Sn1416; Calibrated: 4/15/2015
 Phantom: ELI v4.0; Type: QDOVA001BB; Serial: 1065
 Measurement SW: DASY52, Version 52.8 (8); SEMCAD X Version 14.6.10 (7331)

Procedure Notes:

2.4 GHz/Primary Back 6/Area Scan (7x9x1): Measurement grid: dx=10mm, dy=10mm

[Info: Interpolated medium parameters used for SAR evaluation.](#)

Maximum value of SAR (measured) = 0.0269 W/kg

2.4 GHz/Primary Back 6/Zoom Scan (7x7x7)/Cube 0: Measurement grid: dx=5mm, dy=5mm, dz=5mm

Reference Value = 3.430 V/m; Power Drift = 0.03 dB

Peak SAR (extrapolated) = 0.0400 W/kg

SAR(1 g) = 0.034 W/kg; SAR(10 g) = 0.030 W/kg

[Info: Interpolated medium parameters used for SAR evaluation.](#)

Maximum value of SAR (measured) = 0.0395 W/kg

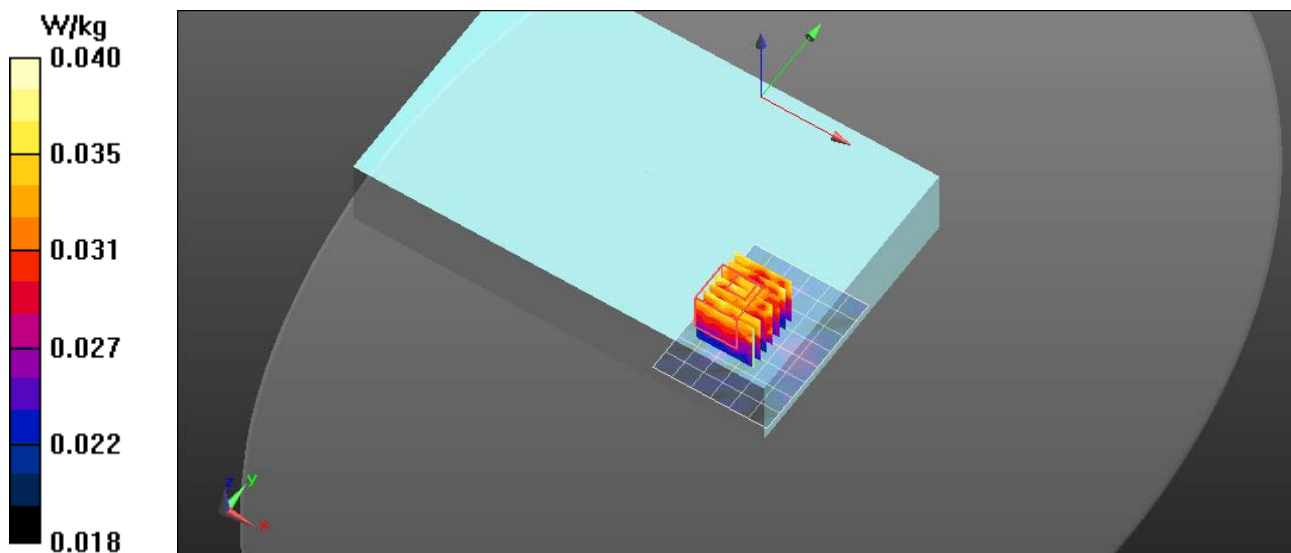

RF Exposure Lab

Plot 14

DUT: MS2GCR; Type: Tablet Computer; Serial: MS2P41

Communication System: WiFi 802.11a (OFDM, 6 Mbps); Frequency: 5300 MHz; Duty Cycle: 1:1
 Medium: MSL 3-6 GHz; Medium parameters used: $f = 5300 \text{ MHz}$; $\sigma = 5.33 \text{ S/m}$; $\epsilon_r = 48.92$; $\rho = 1000 \text{ kg/m}^3$
 Phantom section: Flat Section

Test Date: Date: 12/18/2015; Ambient Temp: 23 °C; Tissue Temp: 21 °C

Probe: EX3DV4 - SN3662; ConvF(4.3, 4.3, 4.3); Calibrated: 4/27/2015;
 Sensor-Surface: 2mm (Mechanical Surface Detection)
 Electronics: DAE4 Sn1416; Calibrated: 4/15/2015
 Phantom: ELI v4.0; Type: QDOVA001BB; Serial: 1065
 Measurement SW: DASY52, Version 52.8 (8); SEMCAD X Version 14.6.10 (7331)

Procedure Notes:

5.2 GHz/Primary Back 60/Area Scan (7x9x1): Measurement grid: dx=10mm, dy=10mm
 Maximum value of SAR (measured) = 1.09 W/kg

5.2 GHz/Primary Back 60/Zoom Scan (7x7x12)/Cube 0: Measurement grid: dx=4mm, dy=4mm, dz=2mm
 Reference Value = 10.81 V/m; Power Drift = 0.02 dB
 Peak SAR (extrapolated) = 3.87 W/kg
SAR(1 g) = 0.749 W/kg
 Maximum value of SAR (measured) = 1.18 W/kg

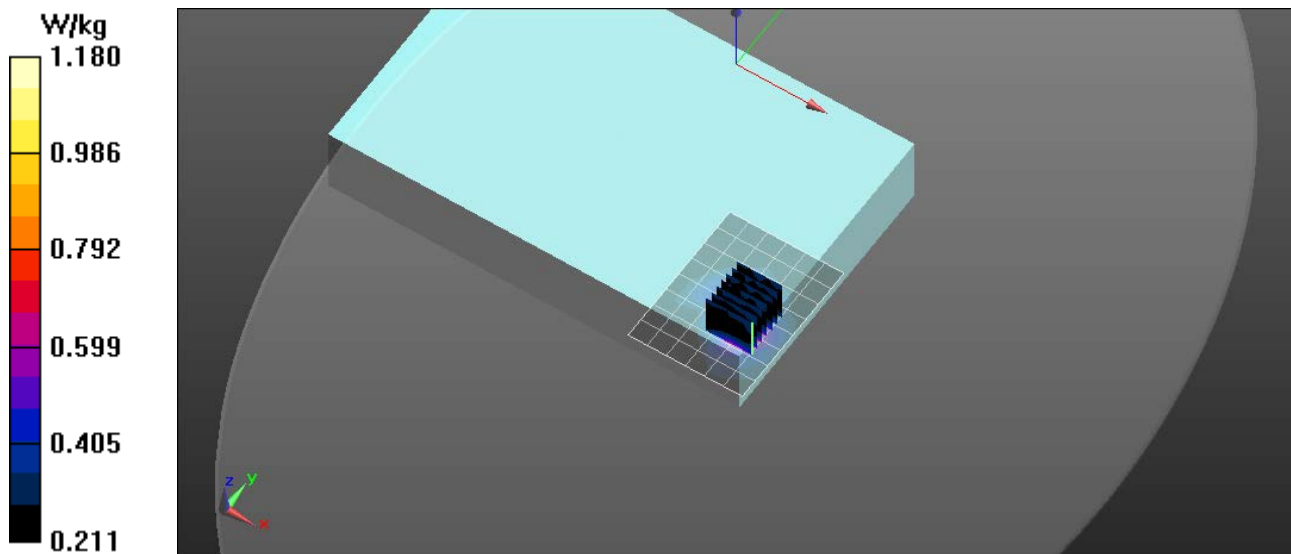

RF Exposure Lab

Plot 15

DUT: MS2GCR; Type: Tablet Computer; Serial: MS2P41

Communication System: WiFi 802.11a (OFDM, 6 Mbps); Frequency: 5620 MHz; Duty Cycle: 1:1
 Medium: MSL 3-6 GHz; Medium parameters used: $f = 5620$ MHz; $\sigma = 5.75$ S/m; $\epsilon_r = 48.44$; $\rho = 1000$ kg/m³
 Phantom section: Flat Section

Test Date: Date: 12/18/2015; Ambient Temp: 23 °C; Tissue Temp: 21 °C

Probe: EX3DV4 - SN3662; ConvF(3.8, 3.8, 3.8); Calibrated: 4/27/2015;
 Sensor-Surface: 2mm (Mechanical Surface Detection)
 Electronics: DAE4 Sn1416; Calibrated: 4/15/2015
 Phantom: ELI v4.0; Type: QDOVA001BB; Serial: 1065
 Measurement SW: DASY52, Version 52.8 (8); SEMCAD X Version 14.6.10 (7331)

Procedure Notes:

5.6 GHz/Primary Back 124/Area Scan (7x9x1): Measurement grid: dx=10mm, dy=10mm
 Maximum value of SAR (measured) = 1.24 W/kg

5.6 GHz/Primary Back 124/Zoom Scan (7x7x12)/Cube 0: Measurement grid: dx=4mm, dy=4mm, dz=2mm
 Reference Value = 11.49 V/m; Power Drift = -0.03 dB
 Peak SAR (extrapolated) = 5.33 W/kg
SAR(1 g) = 0.933 W/kg; SAR(10 g) = 0.164 W/kg
 Maximum value of SAR (measured) = 1.48 W/kg

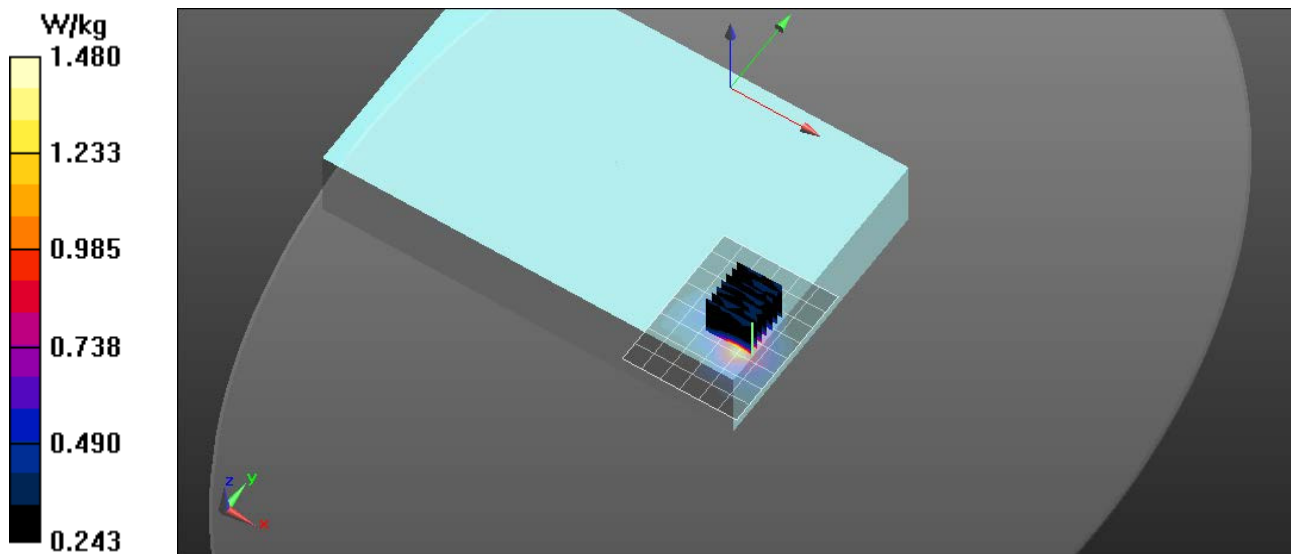

RF Exposure Lab

Plot 16

DUT: MS2GCR; Type: Tablet Computer; Serial: MS2P41

Communication System: WiFi 802.11a (OFDM, 6 Mbps); Frequency: 5825 MHz; Duty Cycle: 1:1
 Medium: MSL 3-6 GHz; Medium parameters used (interpolated): $f = 5825$ MHz; $\sigma = 6.025$ S/m; $\epsilon_r = 48.133$; $\rho = 1000$ kg/m³
 Phantom section: Flat Section

Test Date: Date: 12/18/2015; Ambient Temp: 23 °C; Tissue Temp: 21 °C

Probe: EX3DV4 - SN3662; ConvF(3.99, 3.99, 3.99); Calibrated: 4/27/2015;
 Sensor-Surface: 2mm (Mechanical Surface Detection)
 Electronics: DAE4 Sn1416; Calibrated: 4/15/2015
 Phantom: ELI v4.0; Type: QDOVA001BB; Serial: 1065
 Measurement SW: DASY52, Version 52.8 (8); SEMCAD X Version 14.6.10 (7331)

Procedure Notes:

5.8 GHz/Primary Back 165/Area Scan (7x9x1): Measurement grid: dx=10mm, dy=10mm

[Info: Interpolated medium parameters used for SAR evaluation.](#)

Maximum value of SAR (measured) = 1.11 W/kg

5.8 GHz/Primary Back 165/Zoom Scan (7x7x12)/Cube 0: Measurement grid: dx=4mm, dy=4mm, dz=2mm

Reference Value = 10.68 V/m; Power Drift = 0.02 dB

Peak SAR (extrapolated) = 5.84 W/kg

SAR(1 g) = 0.836 W/kg

[Info: Interpolated medium parameters used for SAR evaluation.](#)

Maximum value of SAR (measured) = 1.29 W/kg

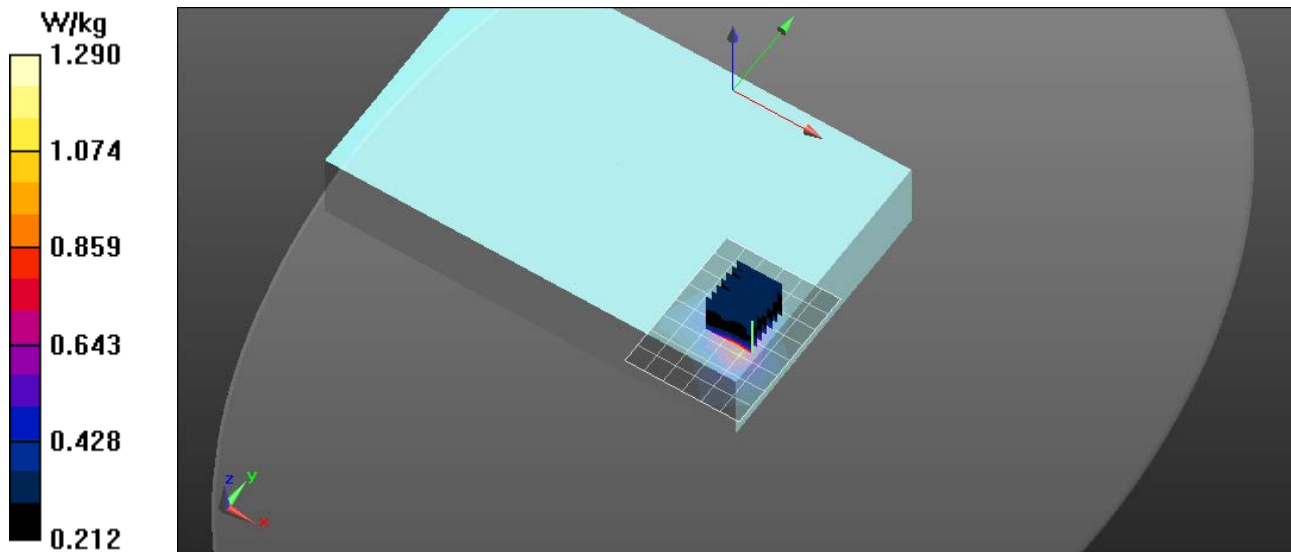

RF Exposure Lab

Plot 17

DUT: MS2GCR; Type: Tablet Computer; Serial: MS2P41

Communication System: FM; Frequency: 922.3 MHz; Duty Cycle: 1:1
 Medium: MSL900; Medium parameters used (interpolated): $f = 922.3$ MHz; $\sigma = 1.095$ S/m; $\epsilon_r = 54.763$; $\rho = 1000$ kg/m³
 Phantom section: Flat Section

Test Date: Date: 11/30/2016; Ambient Temp: 23 °C; Tissue Temp: 21 °C

Probe: EX3DV4 - SN3662; ConvF(8.94, 8.94, 8.94); Calibrated: 4/27/2016;
 Sensor-Surface: 2mm (Mechanical Surface Detection)
 Electronics: DAE4 Sn759; Calibrated: 8/17/2016
 Phantom: ELI v5.0; Type: QDOVA002AA; Serial: 2037
 Measurement SW: DASY52, Version 52.8 (8); SEMCAD X Version 14.6.10 (7331)

Procedure Notes:

RFID NA/Back/Area Scan (7x9x1): Measurement grid: dx=15mm, dy=15mm

[Info: Interpolated medium parameters used for SAR evaluation.](#)

Maximum value of SAR (measured) = 9.09 W/kg

RFID NA/Back/Zoom Scan (5x5x7)/Cube 0: Measurement grid: dx=8mm, dy=8mm, dz=5mm

Reference Value = 39.34 V/m; Power Drift = 0.04 dB

Peak SAR (extrapolated) = 12.4 W/kg

SAR(1 g) = 7.34 W/kg; SAR(10 g) = 3.94 W/kg

[Info: Interpolated medium parameters used for SAR evaluation.](#)

Maximum value of SAR (measured) = 9.73 W/kg

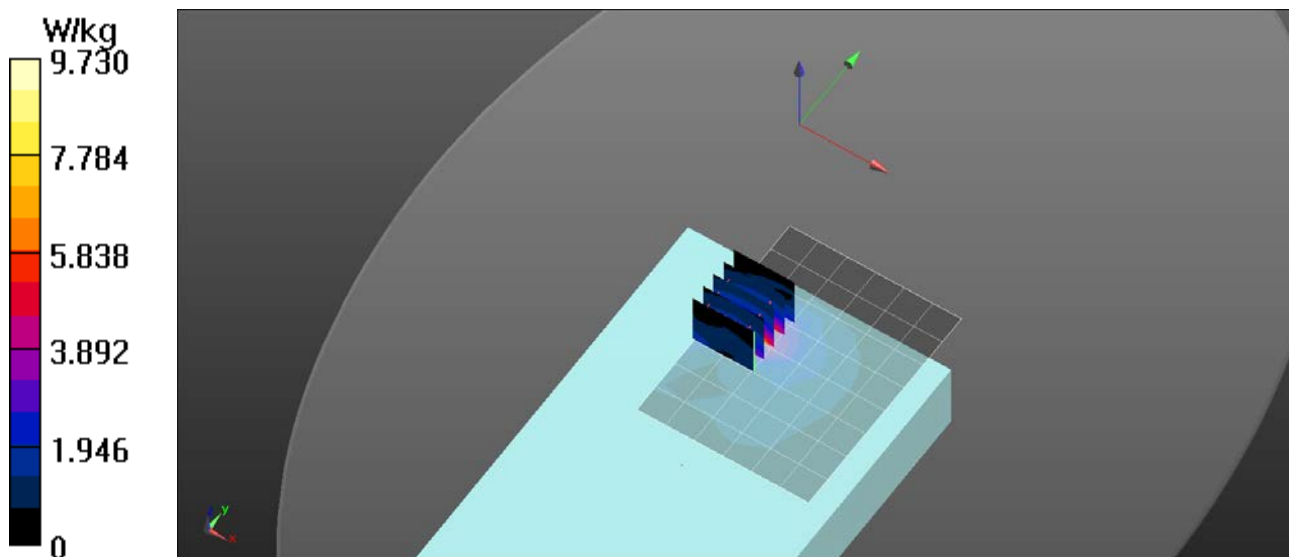

Appendix C – SAR Test Setup Photos



Test Position Back 0 mm Gap



Test Position Left 0 mm Gap



Test Position Right 0 mm Gap



Test Position Top 0 mm Gap

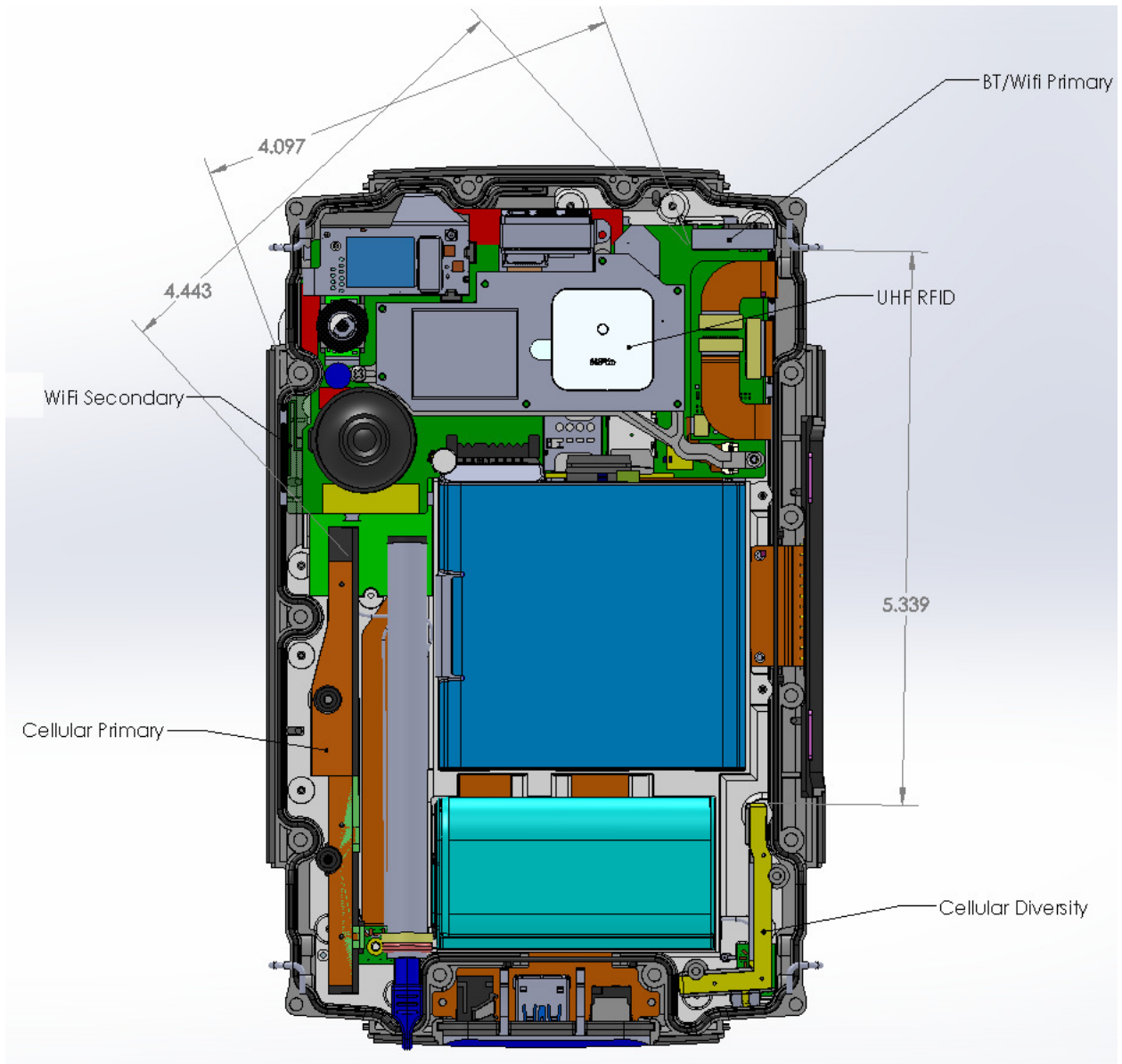

Antenna Locations



Front of Device



Back of Device

Appendix D – Probe Calibration Data Sheets

Jm

**Calibration Laboratory of
Schmid & Partner
Engineering AG**
Zeughausstrasse 43, 8004 Zurich, Switzerland



S Schweizerischer Kalibrierdienst
C Service suisse d'étalonnage
S Servizio svizzero di taratura
Swiss Calibration Service

Accredited by the Swiss Accreditation Service (SAS)
The Swiss Accreditation Service is one of the signatories to the EA
Multilateral Agreement for the recognition of calibration certificates

Accreditation No.: **SCS 0108**

Client **RF Exposure Lab**

Certificate No: **EX3-3662_Apr15**

CALIBRATION CERTIFICATE

Object **EX3DV4 - SN:3662**

Calibration procedure(s) **QA CAL-01.v9, QA CAL-12.v9, QA CAL-14.v4, QA CAL-23.v5,
QA CAL-25.v6
Calibration procedure for dosimetric E-field probes**

Calibration date: **April 27, 2015**

This calibration certificate documents the traceability to national standards, which realize the physical units of measurements (SI).
The measurements and the uncertainties with confidence probability are given on the following pages and are part of the certificate.

All calibrations have been conducted in the closed laboratory facility: environment temperature (22 ± 3)°C and humidity < 70%.

Calibration Equipment used (M&TE critical for calibration)

Primary Standards	ID	Cal Date (Certificate No.)	Scheduled Calibration
Power meter E4419B	GB41293874	01-Apr-15 (No. 217-02128)	Mar-16
Power sensor E4412A	MY41498087	01-Apr-15 (No. 217-02128)	Mar-16
Reference 3 dB Attenuator	SN: S5054 (3c)	01-Apr-15 (No. 217-02129)	Mar-16
Reference 20 dB Attenuator	SN: S5277 (20x)	01-Apr-15 (No. 217-02132)	Mar-16
Reference 30 dB Attenuator	SN: S5129 (30b)	01-Apr-15 (No. 217-02133)	Mar-16
Reference Probe ES3DV2	SN: 3013	30-Dec-14 (No. ES3-3013_Dec14)	Dec-15
DAE4	SN: 660	14-Jan-15 (No. DAE4-660_Jan15)	Jan-16
Secondary Standards	ID	Check Date (in house)	Scheduled Check
RF generator HP 8648C	US3642U01700	4-Aug-99 (in house check Apr-13)	In house check: Apr-16
Network Analyzer HP 8753E	US37390585	18-Oct-01 (in house check Oct-14)	In house check: Oct-15

Calibrated by:	Name Jeton Kastrati	Function Laboratory Technician	Signature
Approved by:	Name Katja Pokovic	Function Technical Manager	

Issued: April 28, 2015

This calibration certificate shall not be reproduced except in full without written approval of the laboratory.



Accredited by the Swiss Accreditation Service (SAS)

Accreditation No.: **SCS 0108**

The Swiss Accreditation Service is one of the signatories to the EA
Multilateral Agreement for the recognition of calibration certificates

Glossary:

TSL	tissue simulating liquid
NORM _{x,y,z}	sensitivity in free space
ConvF	sensitivity in TSL / NORM _{x,y,z}
DCP	diode compression point
CF	crest factor (1/duty_cycle) of the RF signal
A, B, C, D	modulation dependent linearization parameters
Polarization φ	φ rotation around probe axis
Polarization ϑ	ϑ rotation around an axis that is in the plane normal to probe axis (at measurement center), i.e., $\vartheta = 0$ is normal to probe axis
Connector Angle	information used in DASY system to align probe sensor X to the robot coordinate system

Calibration is Performed According to the Following Standards:

- IEEE Std 1528-2013, "IEEE Recommended Practice for Determining the Peak Spatial-Averaged Specific Absorption Rate (SAR) in the Human Head from Wireless Communications Devices: Measurement Techniques", June 2013
- IEC 62209-1, "Procedure to measure the Specific Absorption Rate (SAR) for hand-held devices used in close proximity to the ear (frequency range of 300 MHz to 3 GHz)", February 2005

Methods Applied and Interpretation of Parameters:

- NORM_{x,y,z}**: Assessed for E-field polarization $\vartheta = 0$ ($f \leq 900$ MHz in TEM-cell; $f > 1800$ MHz: R22 waveguide). NORM_{x,y,z} are only intermediate values, i.e., the uncertainties of NORM_{x,y,z} does not affect the E²-field uncertainty inside TSL (see below ConvF).
- NORM(f)_{x,y,z}** = NORM_{x,y,z} * frequency_response (see Frequency Response Chart). This linearization is implemented in DASY4 software versions later than 4.2. The uncertainty of the frequency response is included in the stated uncertainty of ConvF.
- DCP_{x,y,z}**: DCP are numerical linearization parameters assessed based on the data of power sweep with CW signal (no uncertainty required). DCP does not depend on frequency nor media.
- PAR**: PAR is the Peak to Average Ratio that is not calibrated but determined based on the signal characteristics
- A_{x,y,z}; B_{x,y,z}; C_{x,y,z}; D_{x,y,z}; VR_{x,y,z}**: A, B, C, D are numerical linearization parameters assessed based on the data of power sweep for specific modulation signal. The parameters do not depend on frequency nor media. VR is the maximum calibration range expressed in RMS voltage across the diode.
- ConvF and Boundary Effect Parameters**: Assessed in flat phantom using E-field (or Temperature Transfer Standard for $f \leq 800$ MHz) and inside waveguide using analytical field distributions based on power measurements for $f > 800$ MHz. The same setups are used for assessment of the parameters applied for boundary compensation (alpha, depth) of which typical uncertainty values are given. These parameters are used in DASY4 software to improve probe accuracy close to the boundary. The sensitivity in TSL corresponds to NORM_{x,y,z} * ConvF whereby the uncertainty corresponds to that given for ConvF. A frequency dependent ConvF is used in DASY version 4.4 and higher which allows extending the validity from ± 50 MHz to ± 100 MHz.
- Spherical isotropy (3D deviation from isotropy)**: in a field of low gradients realized using a flat phantom exposed by a patch antenna.
- Sensor Offset**: The sensor offset corresponds to the offset of virtual measurement center from the probe tip (on probe axis). No tolerance required.
- Connector Angle**: The angle is assessed using the information gained by determining the NORM_x (no uncertainty required).

Probe EX3DV4

SN:3662

Manufactured: October 20, 2008
Calibrated: April 27, 2015

Calibrated for DASY/EASY Systems
(Note: non-compatible with DASY2 system!)

DASY/EASY - Parameters of Probe: EX3DV4 - SN:3662

Basic Calibration Parameters

	Sensor X	Sensor Y	Sensor Z	Unc (k=2)
Norm ($\mu\text{V}/(\text{V}/\text{m})^2$) ^A	0.44	0.47	0.52	± 10.1 %
DCP (mV) ^B	101.9	95.6	97.9	

Modulation Calibration Parameters

UID	Communication System Name		A dB	B dB/ μV	C	D dB	VR mV	Unc ^E (k=2)
0	CW	X	0.0	0.0	1.0	0.00	153.2	±3.0 %
		Y	0.0	0.0	1.0		140.2	
		Z	0.0	0.0	1.0		142.2	

The reported uncertainty of measurement is stated as the standard uncertainty of measurement multiplied by the coverage factor $k=2$, which for a normal distribution corresponds to a coverage probability of approximately 95%.

^A The uncertainties of NormX,Y,Z do not affect the E^2 -field uncertainty inside TSL (see Pages 5 and 6).

^B Numerical linearization parameter: uncertainty not required.

^E Uncertainty is determined using the max. deviation from linear response applying rectangular distribution and is expressed for the square of the field value.

DASY/EASY - Parameters of Probe: EX3DV4 - SN:3662

Calibration Parameter Determined in Head Tissue Simulating Media

f (MHz) ^C	Relative Permittivity ^F	Conductivity (S/m) ^F	ConvF X	ConvF Y	ConvF Z	Alpha ^G	Depth ^G (mm)	Unct. (k=2)
150	52.3	0.76	10.87	10.87	10.87	0.00	1.00	± 13.3 %
220	49.0	0.81	11.06	11.06	11.06	0.00	1.00	± 13.3 %
450	43.5	0.87	10.63	10.63	10.63	0.16	1.20	± 13.3 %
750	41.9	0.89	9.42	9.42	9.42	0.23	1.33	± 12.0 %
835	41.5	0.90	9.00	9.00	9.00	0.34	0.93	± 12.0 %
900	41.5	0.97	8.79	8.79	8.79	0.21	1.31	± 12.0 %
1750	40.1	1.37	7.76	7.76	7.76	0.19	1.18	± 12.0 %
1900	40.0	1.40	7.48	7.48	7.48	0.34	0.85	± 12.0 %
2450	39.2	1.80	6.95	6.95	6.95	0.37	0.80	± 12.0 %
2600	39.0	1.96	6.84	6.84	6.84	0.42	0.80	± 12.0 %
5200	36.0	4.66	5.05	5.05	5.05	0.35	1.80	± 13.1 %
5300	35.9	4.76	4.81	4.81	4.81	0.35	1.80	± 13.1 %
5500	35.6	4.96	4.81	4.81	4.81	0.40	1.80	± 13.1 %
5600	35.5	5.07	4.73	4.73	4.73	0.40	1.80	± 13.1 %
5800	35.3	5.27	4.68	4.68	4.68	0.40	1.80	± 13.1 %

^C Frequency validity above 300 MHz of ± 100 MHz only applies for DASY v4.4 and higher (see Page 2), else it is restricted to ± 50 MHz. The uncertainty is the RSS of the ConvF uncertainty at calibration frequency and the uncertainty for the indicated frequency band. Frequency validity below 300 MHz is ± 10, 25, 40, 50 and 70 MHz for ConvF assessments at 30, 64, 128, 150 and 220 MHz respectively. Above 5 GHz frequency validity can be extended to ± 110 MHz.

^F At frequencies below 3 GHz, the validity of tissue parameters (ϵ and σ) can be relaxed to ± 10% if liquid compensation formula is applied to measured SAR values. At frequencies above 3 GHz, the validity of tissue parameters (ϵ and σ) is restricted to ± 5%. The uncertainty is the RSS of the ConvF uncertainty for indicated target tissue parameters.

^G Alpha/Depth are determined during calibration. SPEAG warrants that the remaining deviation due to the boundary effect after compensation is always less than ± 1% for frequencies below 3 GHz and below ± 2% for frequencies between 3-6 GHz at any distance larger than half the probe tip diameter from the boundary.

DASY/EASY - Parameters of Probe: EX3DV4 - SN:3662

Calibration Parameter Determined in Body Tissue Simulating Media

f (MHz) ^C	Relative Permittivity ^F	Conductivity (S/m) ^F	ConvF X	ConvF Y	ConvF Z	Alpha ^G	Depth ^G (mm)	Unct. (k=2)
150	61.9	0.80	10.83	10.83	10.83	0.00	1.00	± 13.3 %
220	60.2	0.86	10.42	10.42	10.42	0.00	1.00	± 13.3 %
450	56.7	0.94	10.37	10.37	10.37	0.08	1.20	± 13.3 %
750	55.5	0.96	8.92	8.92	8.92	0.25	1.26	± 12.0 %
835	55.2	0.97	8.86	8.86	8.86	0.41	0.88	± 12.0 %
900	55.0	1.05	8.59	8.59	8.59	0.35	1.07	± 12.0 %
1750	53.4	1.49	7.49	7.49	7.49	0.25	1.07	± 12.0 %
1900	53.3	1.52	7.31	7.31	7.31	0.37	0.89	± 12.0 %
2450	52.7	1.95	7.08	7.08	7.08	0.34	0.90	± 12.0 %
2600	52.5	2.16	6.84	6.84	6.84	0.34	0.90	± 12.0 %
5200	49.0	5.30	4.45	4.45	4.45	0.45	1.90	± 13.1 %
5300	48.9	5.42	4.30	4.30	4.30	0.45	1.90	± 13.1 %
5500	48.6	5.65	3.89	3.89	3.89	0.50	1.90	± 13.1 %
5600	48.5	5.77	3.80	3.80	3.80	0.50	1.90	± 13.1 %
5800	48.2	6.00	3.99	3.99	3.99	0.50	1.90	± 13.1 %

^C Frequency validity above 300 MHz of ± 100 MHz only applies for DASY v4.4 and higher (see Page 2), else it is restricted to ± 50 MHz. The uncertainty is the RSS of the ConvF uncertainty at calibration frequency and the uncertainty for the indicated frequency band. Frequency validity below 300 MHz is ± 10, 25, 40, 50 and 70 MHz for ConvF assessments at 30, 64, 128, 150 and 220 MHz respectively. Above 5 GHz frequency validity can be extended to ± 110 MHz.

^F At frequencies below 3 GHz, the validity of tissue parameters (ϵ and σ) can be relaxed to ± 10% if liquid compensation formula is applied to measured SAR values. At frequencies above 3 GHz, the validity of tissue parameters (ϵ and σ) is restricted to ± 5%. The uncertainty is the RSS of the ConvF uncertainty for indicated target tissue parameters.

^G Alpha/Depth are determined during calibration. SPEAG warrants that the remaining deviation due to the boundary effect after compensation is always less than ± 1% for frequencies below 3 GHz and below ± 2% for frequencies between 3-6 GHz at any distance larger than half the probe tip diameter from the boundary.

Frequency Response of E-Field (TEM-Cell:ifi110 EXX, Waveguide: R22)

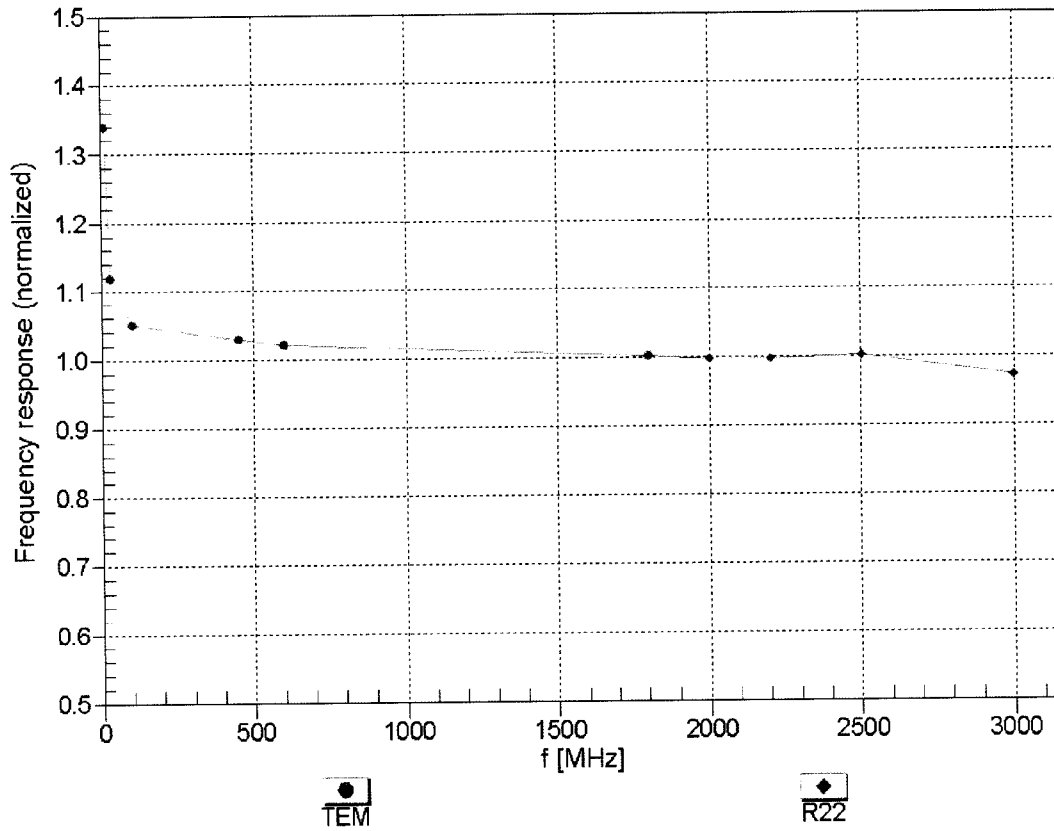

Uncertainty of Frequency Response of E-field: $\pm 6.3\%$ (k=2)

Receiving Pattern (ϕ), $\theta = 0^\circ$

f=600 MHz,TEM

f=1800 MHz,R22

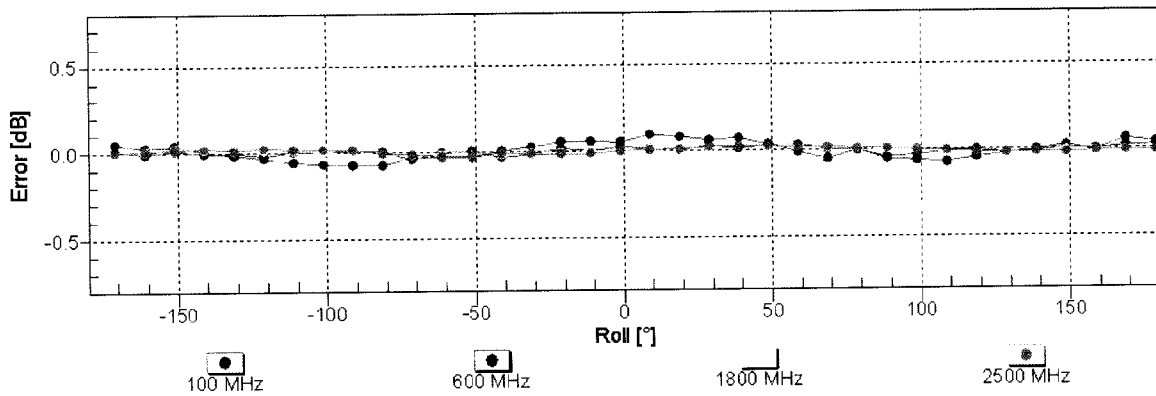
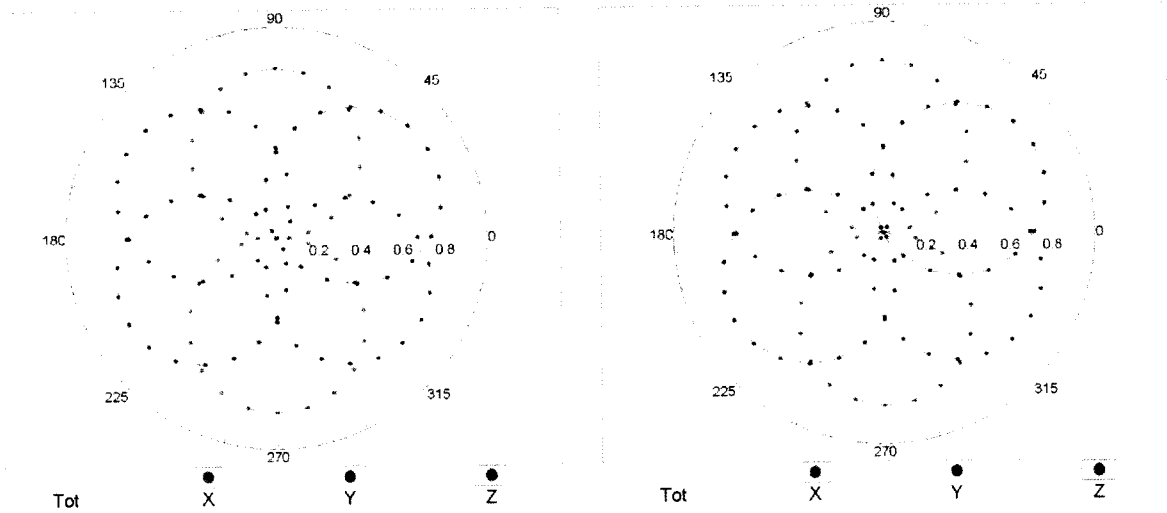

Uncertainty of Axial Isotropy Assessment: $\pm 0.5\%$ (k=2)

Dynamic Range f(SAR_{head}) (TEM cell , f_{eval}= 1900 MHz)

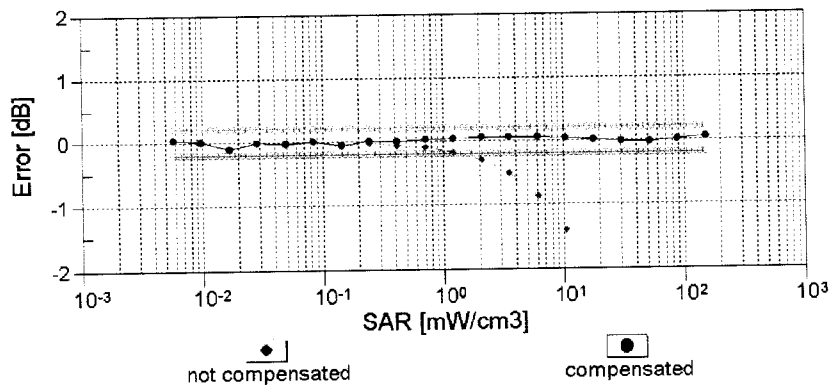
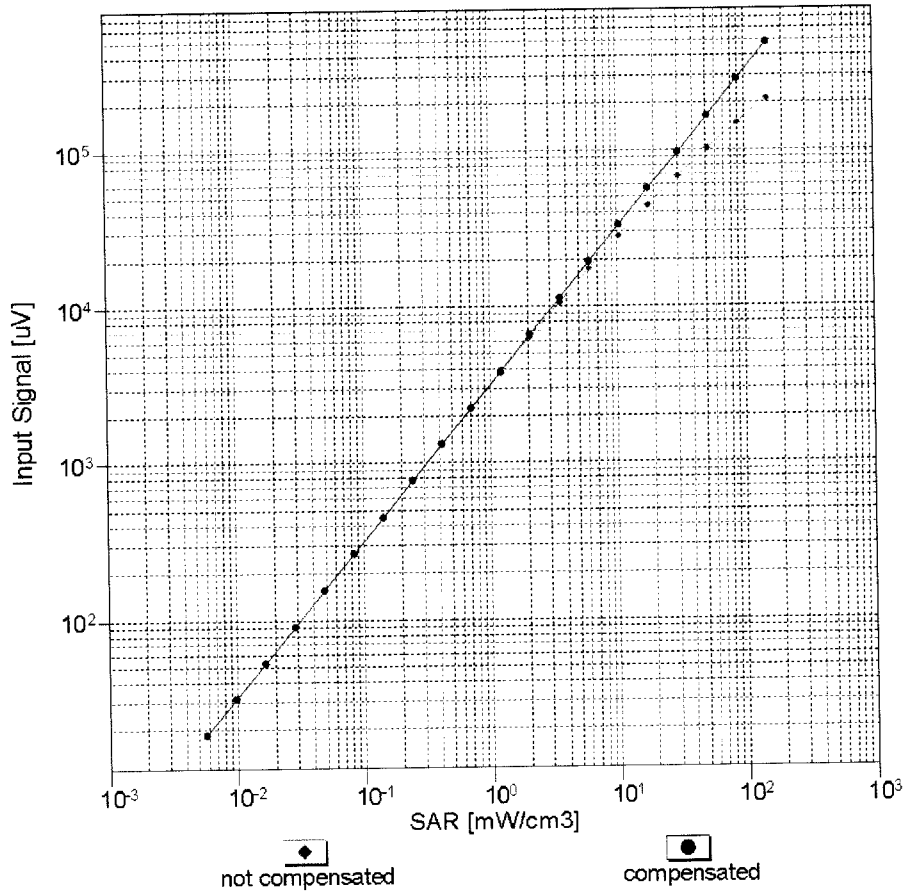

Uncertainty of Linearity Assessment: ± 0.6% (k=2)

Conversion Factor Assessment

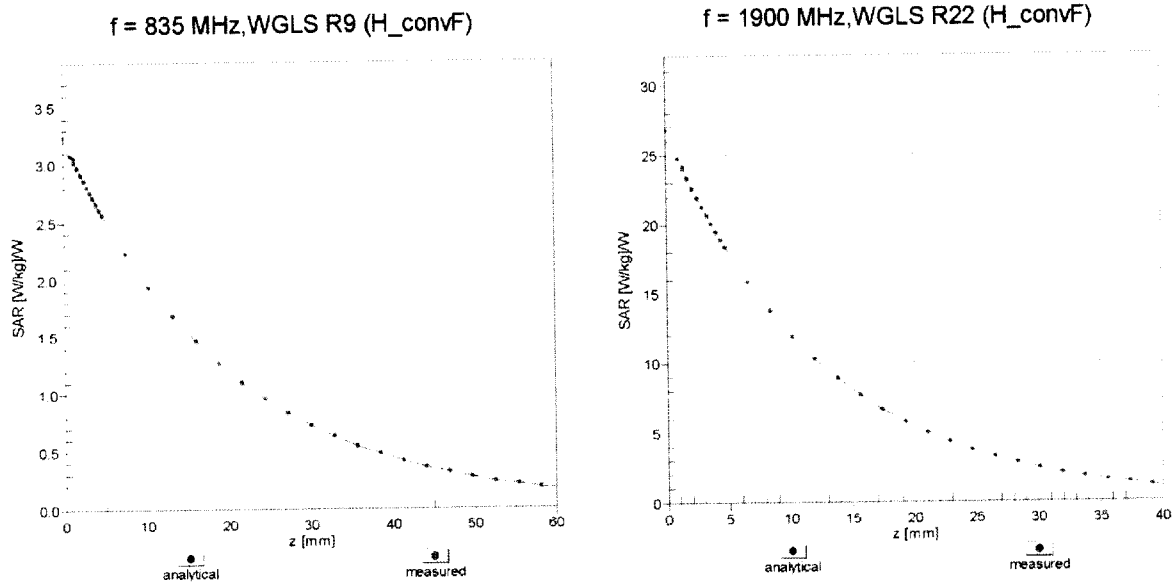

Deviation from Isotropy in Liquid Error (ϕ, ϑ), f = 900 MHz

