

# RF Exposure Lab

802 N. Twin Oaks Valley Road, Suite 105 • San Marcos, CA 92069 • U.S.A.

TEL (760) 471-2100 • FAX (760) 471-2121

<http://www.rfexposurelab.com>

## CERTIFICATE OF COMPLIANCE SAR EVALUATION

Juniper Systems  
1132 West 1700 North  
Logan, UT 84321

Dates of Test: June 26-29, 2018, July 17, Oct. 10, 2018  
Test Report Number:

SAR.20180708  
Revision B

FCC ID:	VSF27582, VSF-AG3
IC Certificate:	7980A-27582, 7980A-AG3
Model(s):	AG3
Test Sample:	Engineering Unit Same as Production
Serial Number:	AG3102
Equipment Type:	Wireless Rugged Handheld
Classification:	Portable Transmitter Next to Body
TX Frequency Range:	699 – 716 MHz, 824 – 849 MHz; 1710 – 1755 MHz, 1850 – 1910 MHz, 2412 – 2462 MHz, 2402 – 2480 MHz
Frequency Tolerance:	± 2.5 ppm
Maximum RF Output:	750 MHz (LTE) – 24.0 dBm, 850 MHz (WCDMA) – 24.0 dBm, 850 MHz (LTE) – 24.0 dBm, 1750 MHz (WCDMA) – 24.0 dBm, 1750 MHz (LTE) – 24.0 dBm, 1900 MHz (WCDMA) – 24.0 dBm, 1900 MHz (LTE) – 19.0 dBm, 2450 MHz (b) – 20.5 dBm, 2450 MHz (g) – 19.00 dBm, 2450 MHz (n20) – 19.0 dBm, 2450 MHz (n40) – 19.0 dBm Conducted
Signal Modulation:	WCDMA, QPSK, 16QAM, DSSS, OFDM
Antenna Type:	Internal
Application Type:	Certification
FCC Rule Parts:	Part 2, 15C, 22, 24, 27
KDB Test Methodology:	KDB 447498 D01 v06, KDB 248227 v02r02, KDB 941225 D01 v03r01, D02 v02r01 & D05 v02r05
Industry Canada:	RSS-102 Issue 5, Safety Code 6
Max. Stand Alone SAR Value:	1.38 W/kg Reported
Max. Simultaneous SAR Value:	0.01 Separation Ratio
Separation Distance:	0 mm

This wireless mobile and/or portable device has been shown to be compliant for localized specific absorption rate (SAR) for uncontrolled environment/general exposure limits specified in ANSI/IEEE Std. C95.1-1992 and had been tested in accordance with the measurement procedures specified in IEEE 1528-2013 and IEC 62209-2:2010 (See test report).

I attest to the accuracy of the data. All measurements were performed by myself or were made under my supervision and are correct to the best of my knowledge and belief. I assume full responsibility for the completeness of these measurements and vouch for the qualifications of all persons taking them.

RF Exposure Lab, LLC certifies that no party to this application is subject to a denial of Federal benefits that includes FCC benefits pursuant to Section 5301 of the Anti-Drug Abuse Act of 1988, 21 U.S.C. 853(a).



Jay M. Moulton  
Vice President



Testing Cert. # 2387.01

## Table of Contents

1. Introduction .....	3
SAR Definition [5] .....	4
2. SAR Measurement Setup .....	5
Robotic System .....	5
System Hardware .....	5
System Electronics .....	6
Probe Measurement System .....	6
3. Probe and Dipole Calibration .....	13
4. Phantom & Simulating Tissue Specifications .....	14
Head & Body Simulating Mixture Characterization .....	14
5. ANSI/IEEE C95.1 – 1992 RF Exposure Limits [2] .....	15
Uncontrolled Environment .....	15
Controlled Environment .....	15
6. Measurement Uncertainty .....	16
7. System Validation .....	17
Tissue Verification .....	17
Test System Verification .....	17
8. LTE Document Checklist .....	18
9. SAR Test Data Summary .....	22
Procedures Used To Establish Test Signal .....	22
Device Test Condition .....	22
Figure 9.1 .....	23
10.1 SAR Measurement Conditions for WCDMA/HSDPA/HSUPA .....	24
SAR Data Summary – 750 MHz Body – LTE Band 12 .....	51
SAR Data Summary – 835 MHz Body - WCDMA .....	52
SAR Data Summary – 835 MHz Body – LTE Band 5 .....	53
SAR Data Summary – 1750 MHz Body - WCDMA .....	54
SAR Data Summary – 1750 MHz Body – LTE Band 4 .....	55
SAR Data Summary – 1900 MHz Body - WCDMA .....	56
SAR Data Summary – 1900 MHz Body – LTE Band 2 .....	57
SAR Data Summary – 2450 MHz Body 802.11b and Bluetooth .....	58
SAR Data Summary – Simultaneous Transmit (WWAN-WLAN Main) .....	59
SAR Data Summary – Simultaneous Transmit (WWAN-BT Main) .....	59
11. Test Equipment List .....	60
12. Conclusion .....	61
13. References .....	62
Appendix A – System Validation Plots and Data .....	63
Appendix B – SAR Test Data Plots .....	76
Appendix C – SAR Test Setup Photos .....	85
Appendix D – Probe Calibration Data Sheets .....	94
Appendix E – Dipole Calibration Data Sheets .....	145
Appendix F – Phantom Calibration Data Sheets .....	186
Appendix G – Validation Summary .....	188

## 1. Introduction

This measurement report shows compliance of the Juniper Systems Model AG3 FCC ID: VSF27582, VSF-AG3 with FCC Part 2, 1093, ET Docket 93-62 Rules for mobile and portable devices and IC Certificate: 7980A-27582, 7980A-AG3 with RSS102 Issue 5 & Safety Code 6. The FCC has adopted the guidelines for evaluating the environmental effects of radio frequency radiation in ET Docket 93-62 on August 6, 1996 to protect the public and workers from the potential hazards of RF emissions due to FCC regulated portable devices. [1], [6]

The test results recorded herein are based on a single type test of Juniper Systems Model AG3 and therefore apply only to the tested sample.

The test procedures, as described in ANSI C95.1 – 1999 Standard for Safety Levels with Respect to Human Exposure to Radio Frequency Electromagnetic Fields, 3 kHz to 300 GHz [2], ANSI C95.3 – 2002 Recommended Practice for the Measurement of Potentially Hazardous Electromagnetic Fields [3], IEEE Std.1528 – 2013 Recommended Practice [4], and Industry Canada Safety Code 6 Limits of Human Exposure to Radiofrequency Electromagnetic Fields in the Frequency Range from 3kHz to 300 GHz were employed.

The following table indicates all the wireless technologies operating in the AG3 Wireless Rugged Handheld. The table also shows the tolerance for the power level for each mode.

Band	Technology	Class	3GPP Nominal Power dBm	Calibrated Nominal Power dBm	Tolerance dBm	Lower Tolerance dBm	Upper Tolerance dBm
Band 12 – 750 MHz	LTE	3	23.0	23.0	±1.0	22.0	24.0
Band 5 – 850 MHz	WCDMA/HSPA	3	23.0	23.0	±1.0	22.0	24.0
Band 5 – 835 MHz	LTE	3	23.0	23.0	±1.0	22.0	24.0
Band 4 – 1750 MHz	WCDMA/HSPA	3	23.0	23.0	±1.0	22.0	24.0
Band 4 – 1750 MHz	LTE	3	23.0	23.0	±1.0	22.0	24.0
Band 2 – 1900 MHz	WCDMA/HSPA	3	23.0	23.0	±1.0	22.0	24.0
Band 2 – 1900 MHz	LTE	3	23.0	23.0	±1.0	22.0	24.0
WLAN – 2.4 GHz	802.11b	N/A	18.0	18.0	±2.5	15.5	20.5
WLAN – 2.4 GHz	802.11g	N/A	16.5	16.5	±2.5	14.0	19.0
WLAN – 2.4 GHz	802.11n	N/A	16.5	16.5	±2.5	14.0	19.0
Bluetooth	802.15.1	N/A	N/A	N/A	N/A	N/A	6.7

**SAR Definition [5]**

Specific Absorption Rate is defined as the time derivative (rate) of the incremental energy ( $dW$ ) absorbed by (dissipated in) an incremental mass ( $dm$ ) contained in a volume element ( $dV$ ) of a given density ( $\rho$ ).

$$SAR = \frac{d}{dt} \left( \frac{dW}{dm} \right) = \frac{d}{dt} \left( \frac{dW}{\rho dV} \right)$$

SAR is expressed in units of watts per kilogram (W/kg). SAR can be related to the electric field at a point by

$$SAR = \frac{\sigma |E|^2}{\rho}$$

where:

$\sigma$  = conductivity of the tissue (S/m)

$\rho$  = mass density of the tissue (kg/m<sup>3</sup>)

$E$  = rms electric field strength (V/m)

## 2. SAR Measurement Setup

### Robotic System

These measurements are performed using the DASY52 automated dosimetric assessment system. The DASY52 is made by Schmid & Partner Engineering AG (SPEAG) in Zurich, Switzerland and consists of high precision robotics system (Staubli), robot controller, Intel Core2 computer, near-field probe, probe alignment sensor, and the generic twin phantom containing the brain equivalent material. The robot is a six-axis industrial robot performing precise movements to position the probe to the location (points) of maximum electromagnetic field (EMF) (see Fig. 2.1).

### System Hardware

A cell controller system contains the power supply, robot controller teach pendant (Joystick), and a remote control used to drive the robot motors. The PC consists of the HP Intel Core2 computer with Windows XP system and SAR Measurement Software DASY52, A/D interface card, monitor, mouse, and keyboard. The Staubli Robot is connected to the cell controller to allow software manipulation of the robot. A data acquisition electronic (DAE) circuit that performs the signal amplification, signal multiplexing, AD-conversion, offset measurements, mechanical surface detection, collision detection, etc. is connected to the Electro-optical coupler (EOC). The EOC performs the conversion from the optical into digital electric signal of the DAE and transfers data to the PC plug-in card.

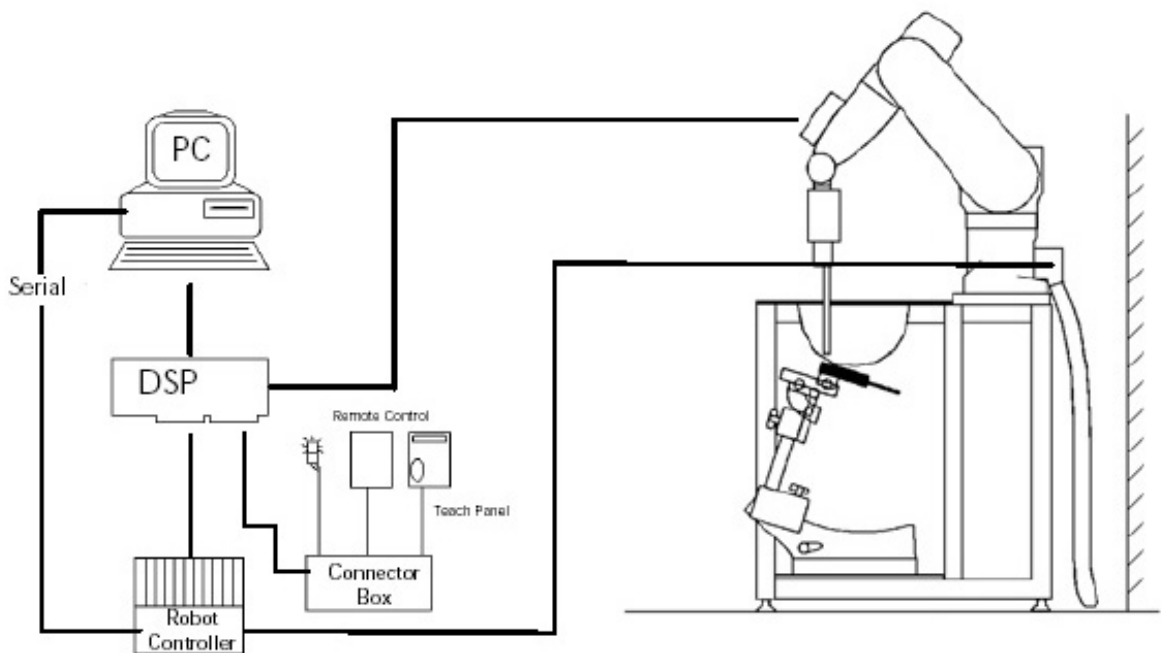

**Figure 2.1 SAR Measurement System Setup**

## System Electronics

The DAE4 consists of a highly sensitive electrometer-grade preamplifier with auto-zeroing, a channel and gain-switching multiplexer, a fast 16 bit AD-converter and a command decoder and control logic unit. Transmission to the PC-card is accomplished through an optical downlink for data and status information and an optical uplink for commands and clock lines. The mechanical probe mounting device includes two different sensor systems for frontal and sidewise probe contacts. They are also used for mechanical surface detection and probe collision detection. The robot uses its own controller with a built in VME-bus computer. The system is described in detail in.

## Probe Measurement System

The SAR measurements were conducted with the dosimetric probe EX3DV4, designed in the classical triangular configuration (see Fig. 2.2) and optimized for dosimetric evaluation. The probe is constructed using the thick film technique; with printed resistive lines on ceramic substrates. The probe is equipped with an optical multi fiber line ending at the front of the probe tip. (see Fig. 2.3) It is connected to the EOC box on the robot arm and provides an automatic detection of the phantom surface. Half of the fibers are connected to a pulsed infrared transmitter, the other half to a synchronized receiver. As the probe approaches the surface, the reflection from the surface produces a coupling from the transmitting to the receiving fibers. This reflection increases first during the approach, reaches maximum and then decreases. If the probe is flatly touching the surface, the coupling is zero. The distance of the coupling maximum to the surface is independent of the surface reflectivity and largely independent of the surface to probe angle. The DASY52 software reads the reflection during a software approach and looks for the maximum using a 2nd order fitting. The approach is stopped at reaching the maximum.



**DAE System**

**Probe Specifications**

**Calibration:** In air from 10 MHz to 6.0 GHz  
 In brain and muscle simulating tissue at Frequencies of 450 MHz, 835 MHz, 1750 MHz, 1900 MHz, 2450 MHz, 2600 MHz, 3500 MHz, 5200 MHz, 5300 MHz, 5600 MHz, 5800 MHz

**Frequency:** 10 MHz to 6 GHz

**Linearity:** ±0.2dB (30 MHz to 6 GHz)

**Dynamic:** 10 mW/kg to 100 W/kg

**Range:** Linearity: ±0.2dB

**Dimensions:** Overall length: 330 mm

**Tip length:** 20 mm

**Body diameter:** 12 mm

**Tip diameter:** 2.5 mm

**Distance from probe tip to sensor center:** 1 mm

**Application:** SAR Dosimetry Testing  
 Compliance tests of wireless device

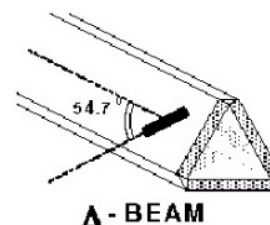

Figure 2.2 Triangular Probe Configurations



Figure 2.3 Probe Thick-Film Technique

**Probe Calibration Process**

**Dosimetric Assessment Procedure**

Each probe is calibrated according to a dosimetric assessment procedure described in with accuracy better than +/- 10%. The spherical isotropy was evaluated with the procedure described in and found to be better than +/-0.25dB. The sensitivity parameters (Norm X, Norm Y, Norm Z), the diode compression parameter (DCP) and the conversion factor (Conv F) of the probe is tested.

**Free Space Assessment**

The free space E-field from amplified probe outputs is determined in a test chamber. This is performed in a TEM cell for frequencies below 1 GHz, and in a waveguide above 1GHz for free space. For the free space calibration, the probe is placed in the volumetric center of the cavity at the proper orientation with the field. The probe is then rotated 360 degrees until the three channels show the maximum reading. The power density readings equates to 1 mW/cm<sup>2</sup>.

**Temperature Assessment \***

E-field temperature correlation calibration is performed in a flat phantom filled with the appropriate simulated brain tissue. The measured free space E-field in the medium, correlates to temperature rise in a dielectric medium. For temperature correlation calibration a RF transparent thermistor based temperature probe is used in conjunction with the E-field probe

$$SAR = C \frac{\Delta T}{\Delta t}$$

$$SAR = \frac{|E|^2 \cdot \sigma}{\rho}$$

where:

where:

$\Delta t$  = exposure time (30 seconds),

$\sigma$  = simulated tissue conductivity,

C = heat capacity of tissue (brain or muscle),

$\rho$  = Tissue density (1.25 g/cm<sup>3</sup> for brain tissue)

$\Delta T$  = temperature increase due to RF exposure.

SAR is proportional to  $\Delta T / \Delta t$ , the initial rate of tissue heating, before thermal diffusion takes place.

Now it's possible to quantify the electric field in the simulated tissue by equating the thermally derived SAR to the E- field;

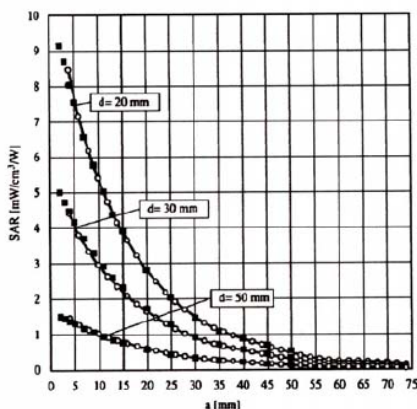

**Figure 2.4 E-Field and Temperature Measurements at 900MHz**

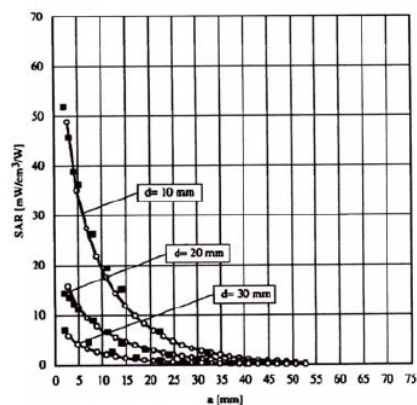

**Figure 2.5 E-Field and Temperature Measurements at 1800MHz**



## Data Extrapolation

The DASY52 software automatically executes the following procedures to calculate the field units from the microvolt readings at the probe connector. The first step of the evaluation is a linearization of the filtered input signal to account for the compression characteristics of the detector diode. The compensation depends on the input signal, the diode type and the DC-transmission factor from the diode to the evaluation electronics. If the exciting field is pulsed, the crest factor of the signal must be known to correctly compensate for peak power. The formula for each channel can be given like below;

$$V_i = U_i + U_i^2 \cdot \frac{cf}{dcp_i}$$

with  $V_i$  = compensated signal of channel i (i=x,y,z)  
 $U_i$  = input signal of channel i (i=x,y,z)  
 $cf$  = crest factor of exciting field (DASY parameter)  
 $dcp_i$  = diode compression point (DASY parameter)

From the compensated input signals the primary field data for each channel can be evaluated:

E-field probes:

$$E_i = \sqrt{\frac{V_i}{Norm_i \cdot ConvF}}$$

with  $V_i$  = compensated signal of channel i (i = x,y,z)  
 $Norm_i$  = sensor sensitivity of channel i (i = x,y,z)  
 $\mu V/(V/m)^2$  for E-field probes  
 $ConvF$  = sensitivity of enhancement in solution  
 $E_i$  = electric field strength of channel i in V/m

The RSS value of the field components gives the total field strength (Hermetian magnitude):

$$E_{tot} = \sqrt{E_x^2 + E_y^2 + E_z^2}$$

The primary field data are used to calculate the derived field units.

$$SAR = E_{tot}^2 \cdot \frac{\sigma}{\rho \cdot 1000}$$

with  $SAR$  = local specific absorption rate in W/g  
 $E_{tot}$  = total field strength in V/m  
 $\sigma$  = conductivity in [mho/m] or [Siemens/m]  
 $\rho$  = equivalent tissue density in g/cm<sup>3</sup>

The power flow density is calculated assuming the excitation field to be a free space field.

$$P_{pwe} = \frac{E_{tot}^2}{3770}$$

with  $P_{pwe}$  = equivalent power density of a plane wave in W/cm<sup>2</sup>  
 $E_{tot}$  = total electric field strength in V/m

**Scanning procedure**

- The DASY installation includes predefined files with recommended procedures for measurements and system check. They are read-only document files and destined as fully defined but unmeasured masks. All test positions (head or body-worn) are tested with the same configuration of test steps differing only in the grid definition for the different test positions.
- The „reference“ and „drift“ measurements are located at the beginning and end of the batch process. They measure the field drift at one single point in the liquid over the complete procedure. The indicated drift is mainly the variation of the DUT’s output power and should vary max. +/- 5 %.
- The highest integrated SAR value is the main concern in compliance test applications. These values can mostly be found at the inner surface of the phantom and cannot be measured directly due to the sensor offset in the probe. To extrapolate the surface values, the measurement distances to the surface must be known accurately. A distance error of 0.5mm could produce SAR errors of 6% at 1800 MHz. Using predefined locations for measurements is not accurate enough. Any shift of the phantom (e.g., slight deformations after filling it with liquid) would produce high uncertainties. For an automatic and accurate detection of the phantom surface, the DASY5 system uses the mechanical surface detection. The detection is always at touch, but the probe will move backward from the surface the indicated distance before starting the measurement.
- The „area scan“ measures the SAR above the DUT or verification dipole on a parallel plane to the surface. It is used to locate the approximate location of the peak SAR with 2D spline interpolation. The robot performs a stepped movement along one grid axis while the local electrical field strength is measured by the probe. The probe is touching the surface of the SAM during acquisition of measurement values. The scan uses different grid spacings for different frequency measurements. Standard grid spacing for head measurements in frequency ranges ≤ 2GHz is 15 mm in x - and y-dimension. For higher frequencies a finer resolution is needed, thus for the grid spacing is reduced according the following table:

<b>Area scan grid spacing for different frequency ranges</b>	
Frequency range	Grid spacing
≤ 2 GHz	≤ 15 mm
2 – 4 GHz	≤ 12 mm
4 – 6 GHz	≤ 10 mm

Grid spacing and orientation have no influence on the SAR result. For special applications where the standard scan method does not find the peak SAR within the grid, e.g. mobile phones with flip cover, the grid can be adapted in orientation. Results of this coarse scan are shown in annex B.

- A „zoom scan“ measures the field in a volume around the 2D peak SAR value acquired in the previous „coarse“ scan. It uses a fine meshed grid where the robot moves the probe in steps along all the 3 axis (x,y and z-axis) starting at the bottom of the Phantom. The grid spacing for the cube measurement is varied according to the measured frequency range, the dimensions are given in the following table:

<b>Zoom scan grid spacing and volume for different frequency ranges</b>			
Frequency range	Grid spacing for x, y axis	Grid spacing for z axis	Minimum zoom scan volume
≤ 2 GHz	≤ 8 mm	≤ 5 mm	≥ 30 mm
2 – 3 GHz	≤ 5 mm	≤ 5 mm	≥ 28 mm
3 – 4 GHz	≤ 5 mm	≤ 4 mm	≥ 28 mm
4 – 5 GHz	≤ 4 mm	≤ 3 mm	≥ 25 mm
5 – 6 GHz	≤ 4 mm	≤ 2 mm	≥ 22 mm

DASY is also able to perform repeated zoom scans if more than 1 peak is found during area scan. In this document, the evaluated peak 1g and 10g averaged SAR values are shown in the 2D-graphics in annex B. Test results relevant for the specified standard (see section 3) are shown in table form in section 7.

## Spatial Peak SAR Evaluation

The spatial peak SAR - value for 1 and 10 g is evaluated after the Cube measurements have been done. The basis of the evaluation are the SAR values measured at the points of the fine cube grid consisting of all points in the three directions x, y and z. The algorithm that finds the maximal averaged volume is separated into three different stages.

- The data between the dipole center of the probe and the surface of the phantom are extrapolated. This data cannot be measured since the center of the dipole is 1 to 2.7 mm away from the tip of the probe and the distance between the surface and the lowest measuring point is about 1 mm (see probe calibration sheet). The extrapolated data from a cube measurement can be visualized by selecting 'Graph Evaluated'.
- The maximum interpolated value is searched with a straight-forward algorithm. Around this maximum the SAR - values averaged over the spatial volumes (1g or 10 g) are computed using the 3d-spline interpolation algorithm. If the volume cannot be evaluated (i.e., if a part of the grid was cut off by the boundary of the measurement area) the evaluation will be started on the corners of the bottom plane of the cube.
- All neighbouring volumes are evaluated until no neighbouring volume with a higher average value is found.

## Extrapolation

The extrapolation is based on a least square algorithm [W. Gander, Computermathematik, p.168-180]. Through the points in the first 3 cm along the z-axis, polynomials of order four are calculated. These polynomials are then used to evaluate the points between the surface and the probe tip. The points, calculated from the surface, have a distance of 1 mm from each other.

## Interpolation

The interpolation of the points is done with a 3d-Spline. The 3d-Spline is composed of three one-dimensional splines with the "Not a knot"-condition [W. Gander, Computermathematik, p.141-150] (x, y and z -direction) [Numerical Recipes in C, Second Edition, p.123ff ].

## Volume Averaging

At First the size of the cube is calculated. Then the volume is integrated with the trapezoidal algorithm. 8000 points (20x20x20) are interpolated to calculate the average.

## Advanced Extrapolation

DASY uses the advanced extrapolation option which is able to compensate boundary effects on E-field probes.

**SAM PHANTOM**

The SAM Twin Phantom V4.0 is constructed of a fiberglass shell integrated in a wooden table. The shape of the shell is based on data from an anatomical study designed to determine the maximum exposure in at least 90% of all users. It enables the dosimetric evaluation of left and right hand phone usage as well as body mounted usage at the flat phantom region. A cover prevents the evaporation of the liquid. Reference markings on the Phantom allow the complete setup of all predefined phantom positions and measurement grids by manually teaching three points in the robot. (see Fig. 2.6)

**Phantom Specification**

**Phantom:** SAM Twin Phantom (V4.0)  
**Shell Material:** Vivac Composite  
**Thickness:**  $2.0 \pm 0.2$  mm

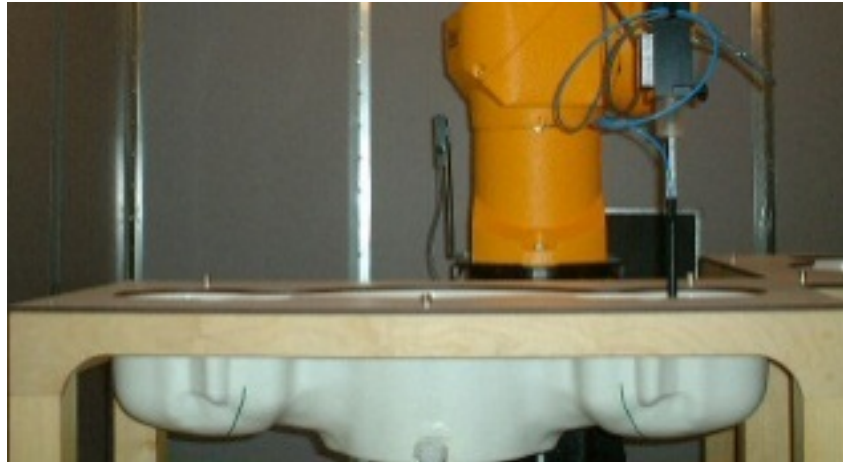

**Figure 2.6 SAM Twin Phantom**

**Device Holder for Transmitters**

In combination with the SAM Twin Phantom V4.0 the Mounting Device (see Fig. 2.7), enables the rotation of the mounted transmitter in spherical coordinates whereby the rotation point is the ear opening. The devices can be easily, accurately, and repeatedly positioned according to the FCC, CENELEC, IEC and IEEE specifications. The device holder can be locked at different phantom locations (left head, right head, flat phantom).



**Figure 2.7 Mounting Device**

Note: A simulating human hand is not used due to the complex anatomical and geometrical structure of the hand that may produce infinite number of configurations. To produce the worst-case condition (the hand absorbs antenna output power), the hand is omitted during the tests.

### **3. Probe and Dipole Calibration**

**See Appendix D and E.**

## 4. Phantom & Simulating Tissue Specifications

### Head & Body Simulating Mixture Characterization

The head and body mixtures consist of the material based on the table listed below. The mixture is calibrated to obtain proper dielectric constant (permittivity) and conductivity of the desired tissue. Body tissue parameters that have not been specified in IEEE1528 – 2013 are derived from the issue dielectric parameters computed from the 4-Cole-Cole equations.

**Table 4.1 Typical Composition of Ingredients for Tissue**

Ingredients		Simulating Tissue				
		750 MHz Body	835 MHz Body	1750 MHz Body	1900 MHz Body	2450 MHz Body
Mixing Percentage						
Water		Proprietary Purchased From Speag	52.50	Proprietary Purchased From Speag	69.91	73.20
Sugar			45.00		0.00	0.00
Salt			1.40		0.13	0.10
HEC			1.00		0.00	0.00
Bactericide			0.10		0.00	0.00
DGBE			0.00		29.96	26.70
Dielectric Constant	Target	55.53	55.20	53.43	53.30	52.70
Conductivity (S/m)	Target	0.96	0.97	1.49	1.52	1.95

## 5. ANSI/IEEE C95.1 – 1992 RF Exposure Limits [2]

### Uncontrolled Environment

Uncontrolled Environments are defined as locations where there is the exposure of individuals who have no knowledge or control of their exposure. The general population/uncontrolled exposure limits are applicable to situations in which the general public may be exposed or in which persons who are exposed as a consequence of their employment may not be made fully aware of the potential for exposure or cannot exercise control over their exposure. Members of the general public would come under this category when exposure is not employment-related; for example, in the case of a wireless transmitter that exposes persons in its vicinity.

### Controlled Environment

Controlled Environments are defined as locations where there is exposure that may be incurred by persons who are aware of the potential for exposure, (i.e. as a result of employment or occupation). In general, occupational/controlled exposure limits are applicable to situations in which persons are exposed as a consequence of their employment, who have been made fully aware of the potential for exposure and can exercise control over their exposure. This exposure category is also applicable when the exposure is of a transient nature due to incidental passage through a location where the exposure levels may be higher than the general population/uncontrolled limits, but the exposed person is fully aware of the potential for exposure and can exercise control over his or her exposure by leaving the area or by some other appropriate means.

**Table 5.1 Human Exposure Limits**

	UNCONTROLLED ENVIRONMENT General Population (W/kg) or (mW/g)	CONTROLLED ENVIROMENT Professional Population (W/kg) or (mW/g)
SPATIAL PEAK SAR <sup>1</sup> Head	1.60	8.00
SPATIAL AVERAGE SAR <sup>2</sup> Whole Body	0.08	0.40
SPATIAL PEAK SAR <sup>3</sup> Hands, Feet, Ankles, Wrists	4.00	20.00

<sup>1</sup> The Spatial Peak value of the SAR averaged over any 1 gram of tissue (defined as a tissue volume in the shape of a cube) and over the appropriate averaging time.

<sup>2</sup> The Spatial Average value of the SAR averaged over the whole body.

<sup>3</sup> The Spatial Peak value of the SAR averaged over any 10 grams of tissue (defined as a tissue volume in the shape of a cube) and over the appropriate averaging time.

## 6. Measurement Uncertainty

Measurement uncertainty table is not required per KDB 865664 D01 v01r04 section 2.8.2 page 12. SAR measurement uncertainty analysis is required in the SAR report only when the highest measured SAR in a frequency band is  $\geq 1.5$  W/kg for 1-g SAR. The equivalent ratio (1.5/1.6) should be applied to extremity and occupational exposure conditions. The highest reported value is less than 1.5 W/kg. Therefore, the measurement uncertainty table is not required.



## 7. System Validation

### Tissue Verification

**Table 7.1 Measured Tissue Parameters**

		750 MHz Body		835 MHz Body		1750 MHz Body	
Date(s)		June 28, 2018		June 28, 2018		June 26, 2018	
Liquid Temperature (°C)	20.0	Target	Measured	Target	Measured	Target	Measured
Dielectric Constant: $\epsilon$		55.35	55.57	55.20	55.91	53.43	53.32
Conductivity: $\sigma$		0.96	0.99	0.97	0.99	1.49	1.52
		1900 MHz Body		2450 MHz Body			
Date(s)		June 27, 2018		Oct. 10, 2018			
Liquid Temperature (°C)	20.0	Target	Measured	Target	Measured		
Dielectric Constant: $\epsilon$		53.30	52.07	52.70	52.64		
Conductivity: $\sigma$		1.52	1.47	1.95	1.96		

See Appendix A for data printout.

### Test System Verification

Prior to assessment, the system is verified to the  $\pm 10\%$  of the specifications at the test frequency by using the system kit. Power is normalized to 1 watt. (Graphic Plots Attached)

**Table 7.2 System Dipole Validation Target & Measured**

	Test Frequency	Targeted SAR <sub>1g</sub> (W/kg)	Measure SAR <sub>1g</sub> (W/kg)	Tissue Used for Verification	Deviation (%)	Plot Number
28-Jun-2018	750 MHz	8.48	8.65	Body	+ 2.00	1
28-Jun-2018	835 MHz	9.28	9.53	Body	+ 2.69	2
26-Jun-2018	1750 MHz	37.70	38.50	Body	+ 2.12	3
27-Jun-2018	1900 MHz	40.40	39.80	Body	- 1.49	4
10-Oct-2018	2450 MHz	51.00	52.00	Body	+ 0.20	5

See Appendix A for data plots.

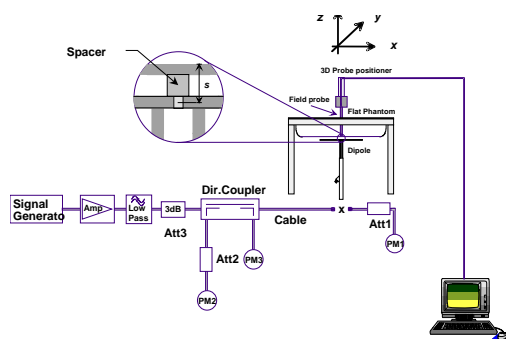

**Figure 7.1 Dipole Validation Test Setup**

## 8. LTE Document Checklist

- 1) Identify the operating frequency range of each LTE transmission band used by the device

LTE Operating Band	Uplink (transmit)	Downlink (Receive)	Duplex mode (FDD/TDD)
	Low - high	Low - high	
2	1850-1910	1930-1990	FDD
4	1710-1755	2110-2155	FDD
5	824-849	869-894	FDD
12	699-716	729-746	FDD

- 2) Identify the channel bandwidths used in each frequency band; 1.4, 3, 5, 10, 15, 20 MHz etc

LTE Band Class	Bandwidth (MHz)	Frequency or Freq. Band (MHz)
2	1.4, 3, 5, 10, 15, 20	1850-1910 MHz
4	1.4, 3, 5, 10, 15, 20	1710-1755 MHz
5	5, 10	824-849 MHz
12	5, 10	699-716 MHz

- 3) Identify the high, middle and low (H, M, L) channel numbers and frequencies in each LTE frequency band

LTE Band Class	Bandwidth (MHz)	Frequency (MHz)/Channel #					
		Low		Mid		High	
2	1.4	1850.7	18607	1880.0	18900	1909.3	19193
2	3	1851.5	18615	1880.0	18900	1908.5	19185
2	5	1852.5	18625	1880.0	18900	1907.5	19175
2	10	1855.0	18650	1880.0	18900	1905.0	19150
2	15	1857.5	18675	1880.0	18900	1902.5	19125
2	20	1860.0	18700	1880.0	18900	1900.0	19100
4	1.4	1710.7	19957	1732.5	20175	1754.3	20393
4	3	1711.5	19965	1732.5	20175	1753.5	20385
4	5	1712.5	19975	1732.5	20175	1752.5	20375
4	10	1715.0	20000	1732.5	20175	1750.0	20350
4	15	1717.5	20025	1732.5	20175	1747.5	20325
4	20	1720.0	20050	1732.5	20175	1745.0	20300
5	5	826.5	20425	836.5	20525	846.5	20625
5	10	829.0	20450	836.5	20525	844.0	20600
12	5	701.5	23035	707.5	23095	713.5	23155
12	10	704.0	23060	707.5	23095	711.0	23129

- 4) Specify the UE category and uplink modulations used:

- UE Category: 3
- Uplink modulations: QPSK and 16QAM

- 5) Include descriptions of the LTE transmitter and antenna implementation; and also identify whether it is a standalone transmitter operating independently of other wireless transmitters in the device or sharing hardware components and/or antenna(s) with other transmitters etc

The device has 3 antennas:

- WWAN Main (Transmit and Receive) Antenna
- WLAN Main (Transmit and Receive) Antenna
- Diversity (Receive Only) Antenna

Transmission relationship

- All transmission (TX) is limited to the WWAN and WLAN antennas only
- The device is unable to transmit WCDMA/HSPA and LTE simultaneously.
- The Diversity antenna is receive only antenna which is reserved for the WWAN operation.
- Rx is simultaneous on Main and Diversity
- Simultaneous Tx with the WWAN and WLAN/BT is allowed.

Antenna port	WCDMA/HSPA		LTE		802.11 b/g/n/BT	
	TX	RX	TX	RX	TX	RX
#1 WWAN Main	Yes	Yes	Yes	Yes	No	No
#2 WLAN Main	No	No	No	No	Yes	Yes
#3 (Diversity)	No	Yes	No	Yes	No	No

- 6) Identify the LTE voice/data requirements in each operating mode and exposure condition with respect to head and body test configurations, antenna locations, handset flip-cover or slide positions, antenna diversity conditions etc

The device is a data only. Data mode was tested in each operating mode and exposure condition in the body configuration. See test setup photos to see all configurations tested.

- 7) Identify if Maximum Power Reduction (MPR) is optional or mandatory, i.e. built-in by design:
- a) Only mandatory MPR may be considered during SAR testing, when the maximum output power is permanently limited by the MPR implemented within the UE; and only for the applicable RB (resource block) configurations specified in LTE standards

MPR is mandatory, built-in by design on all production units. It was enabled during testing.

Modulation	Channel Bandwidth/transmission Bandwidth Configuration (RB)						MPR (dB)
	1.4 MHz	3.0 MHz	5 MHz	10 MHz	15 MHz	20 MHz	
QPSK	> 5	> 4	> 8	> 12	> 16	> 18	≤ 1
16QAM	≤ 5	≤ 4	≤ 8	≤ 12	≤ 16	≤ 18	≤ 1
16QAM	> 5	> 4	> 8	> 12	> 16	> 18	≤ 2

- b) A-MPR (additional MPR) must be disabled
- c) A-MPR was disabled during testing.

- 8) Include the maximum average conducted output power measured on the required test channels for each channel bandwidth and UL modulation used in each frequency band:

The maximum average conducted output power measured for the testing is listed on pages 32-44 of this report. The below table shows the factory set point with the allowable tolerance.

Band	Technology	Class	3GPP Nominal Power dBm	Calibrated Nominal Power dBm	Tolerance dBm	Lower Tolerance dBm	Upper Tolerance dBm
Band 12 – 750 MHz	LTE	3	23.0	23.0	±1.0	22.0	24.0
Band 5 – 835 MHz	LTE	3	23.0	23.0	±1.0	22.0	24.0
Band 4 – 1750 MHz	LTE	3	23.0	23.0	±1.0	22.0	24.0
Band 2 – 1900 MHz	LTE	3	23.0	23.0	±1.0	22.0	24.0

- 9) Identify all other U.S. wireless operating modes (3G, Wi-Fi, WiMax, Bluetooth etc), device/exposure configurations (head and body, antenna and handset flip-cover or slide positions, antenna diversity conditions etc.) and frequency bands used for these modes

Other wireless modes:

Band	Technology	Class	3GPP Nominal Power dBm	Calibrated Nominal Power dBm	Tolerance dBm	Lower Tolerance dBm	Upper Tolerance dBm
Band 5 – 850 MHz	WCDMA/HSPA	3	23.0	23.0	±1.0	22.0	24.0
Band 4 – 1750 MHz	WCDMA/HSPA	3	23.0	23.0	±1.0	22.0	24.0
Band 2 – 1900 MHz	WCDMA/HSPA	3	23.0	23.0	±1.0	22.0	24.0
WLAN – 2.4 GHz	802.11bgn	N/A	N/A	N/A	N/A	N/A	18.0
Bluetooth	802.15.1	N/A	N/A	N/A	N/A	N/A	15.0

- 10) Include the maximum average conducted output power measured for the other wireless modes and frequency bands.

The maximum average conducted output power measured for the testing is listed on pages 25&27 of this report. The table in item 9 shows the factory set point with the allowable tolerance.

- 11) Identify the simultaneous transmission conditions for the voice and data configurations supported by all wireless modes, device configurations and frequency bands, for the head and body exposure conditions and device operating configurations (handset flip or cover positions, antenna diversity conditions etc.)

The device is unable to transmit WCDMA & LTE simultaneously and WLAN & Bluetooth simultaneously.

The device is able to transmit WWAN and WLAN/BT simultaneously.

TX Modes	WCDMA	LTE	802.11 b/g/n	Bluetooth
1	ON	OFF	ON	OFF
2	OFF	ON	ON	OFF
3	ON	OFF	OFF	ON
4	OFF	ON	OFF	ON

- 12) When power reduction is applied to certain wireless modes to satisfy SAR compliance for simultaneous transmission conditions, other equipment certification or operating requirements, include the maximum average conducted output power measured in each power reduction mode applicable to the simultaneous voice/data transmission configurations for such wireless configurations and frequency bands; and also include details of the power reduction implementation and measurement setup

Power reduction is not required to satisfy SAR compliance.

- 13) Include descriptions of the test equipment, test software, built-in test firmware etc. required to support testing the device when power reduction is applied to one or more transmitters/antennas for simultaneous voice/data transmission

Power reduction is not required to satisfy SAR compliance.

- 14) When appropriate, include a SAR test plan proposal with respect to the above

Power reduction is not required to satisfy SAR compliance.

- 15) If applicable, include preliminary SAR test data and/or supporting information in laboratory testing inquiries to address specific issues and concerns or for requesting further test reduction considerations appropriate for the device; for example, simultaneous transmission configurations.

Not applicable.

## 9. SAR Test Data Summary

### See Measurement Result Data Pages

See Appendix B for SAR Test Data Plots.  
See Appendix C for SAR Test Setup Photos.

### Procedures Used To Establish Test Signal

The device was either placed into simulated transmit mode using the manufacturer's test codes or the actual transmission is activated through a base station simulator or similar equipment. See data pages for actual procedure used in measurement.

### Device Test Condition

In order to verify that the device was tested at full power, conducted output power measurements were performed before and after each SAR measurement to confirm the output power unless otherwise noted. If a conducted power deviation of more than 5% occurred, the test was repeated. The power drift of each test is measured at the start of the test and again at the end of the test. The drift percentage is calculated by the formula  $((\text{end}/\text{start})-1)*100$  and rounded to three decimal places. The drift percentage is calculated into the resultant SAR value on the data sheet for each test.

The testing was conducted on all edges closest to each antenna. The back, left and top sides were tested for the WWAN antenna. The remaining sides were not tested as the WWAN antenna was more than 2.5 cm from the side. The back, right and bottom sides were tested for the WLAN antennas. The remaining sides were not tested as the antenna was more than 2.5 cm from these sides. All further test reductions are shown on pages 30 for WCDMA bands, page 28-29 for WLAN/BT and pages 44-51 for LTE bands. See the photo in Appendix C for a pictorial of the setups and antenna locations.

The Bluetooth was excluded due to low transmit power. The maximum Tx power for Bluetooth is 6.7 dBm (4.7 mW). The minimum distance the user can get to the antenna is 10 mm. Please see the calculations below.

For FCC,  $[(\text{max. power, mW})/(\text{min. distance, mm})]^*\sqrt{f_{(\text{GHz})}} \leq 3.0$ . Therefore, the calculation is  $(4.7/10)^*\sqrt{2.48} = 0.74$  which is less than 3.0.

For ISED, at 10 mm distance the maximum Tx power must be below 7 mW which 4.7 mW is less than 7 mW.

The WCDMA testing was conducted using 12.2 kbps RMC configured in Test Loop Mode 1. The HSPA testing was conducted with HS-DPCCH, E-DPCCH and E-DPDCH all enabled and a 12.2 kbps RMC. FRC was configured according to HS-DPCCH Sub-Test 1 using H-set 1 and QPSK.

**Figure 9.1**  
**SAR Location Diagram of Antenna Distances**



**Antenna Distances**

WWAN main to WLAN/BT (mm): 178.75 mm

## 10.1 SAR Measurement Conditions for WCDMA/HSDPA/HSUPA

Configure the call box 8960 to support all WCDMA tests in respect to the 3GPP 34.121 (listed in Table below). Measure the power at Ch4132, 4182 and 4233 for US cell; Ch9262, 9400 and 9538 for US PCS band.

For Rel99

- Set a Test Mode 1 loop back with a 12.2kbps Reference Measurement Channel (RMC).
- Set and send continuously Up power control commands to the device
- Measure the power at the device antenna connector using the power meter with average detector.

For HSDPA Rel 6

- Establish a Test Mode 1 look back with both 1 12.2kbps RMC channel and a H-Set1 Fixed Reference Channel (FRC). With the 8960 this is accomplished by setting the signal Channel Coding to "Fixed Reference Channel" and configuring for HSET-1 QKSP.
- Set beta values and HSDPA settings for HSDPA Subtest1 according to Table below.
- Send continuously Up power control commands to the device
- Measure the power at the device antenna connector using the power meter with modulated average detector.
- Repeat the measurement for the HSDPA Subtest2, 3 and 4 as given in Table below.

For HSUPA Rel 6

- Use UL RMC 12.2kbps and FRC H-Set1 QPSK, Test Mode 1 loop back. With the 8960 this is accomplished by setting the signal Channel Coding to "E-DCH Test Channel" and configuring the equipment category to Cat5\_10ms.
- Set the Absolute Grant for HSUPA Subtest1 according to Table below.
- Set the device power to be at least 5dB lower than the Maximum output power
- Send power control bits to give one TPC\_cmd = +1 command to the device. If device doesn't send any E-DPCH data with decreased E-TFCI within 500ms, then repeat this process until the decreased E-TFCI is reported.
- Confirm that the E-TFCI transmitted by the device is equal to the target E-TFCI in Table below. If the E-TFCI transmitted by the device is not equal to the target E-TFCI, then send power control bits to give one TPC\_cmd = -1 command to the UE. If UE sends any E-DPCH data with decreased E-TFCI within 500 ms, send new power control bits to give one TPC\_cmd = -1 command to the UE. Then confirm that the E-TFCI transmitted by the UE is equal to the target E-TFCI in Table below.
- Measure the power using the power meter with modulated average detector.
- Repeat the measurement for the HSUPA Subtest2, 3, 4 and 5 as given in Table below.



3GPP Release Version	Mode	Cellular Band [dBm]			Sub-Test (See Table Below)	MPR
		4132	4183	4233		
99	WCDMA	23.75	23.89	23.82	-	-
6	HSDPA	23.79	23.82	23.71	1	0
6		23.72	23.79	23.75	2	0
6		23.42	23.47	23.36	3	0.5
6		23.41	23.44	23.39	4	0.5
6	HSUPA	23.71	23.81	23.75	1	0
6		21.91	21.90	21.88	2	2
6		22.95	22.93	22.91	3	1
6		21.84	21.90	21.89	4	2
6		23.69	23.80	23.74	5	0

3GPP Release Version	Mode	AWS Band [dBm]			Sub-Test (See Table Below)	MPR
		1312	1413	1513		
99	WCDMA	23.88	23.90	23.95	-	-
6	HSDPA	23.79	23.82	23.76	1	0
6		23.81	23.75	23.79	2	0
6		23.36	23.34	23.36	3	0.5
6		23.41	23.31	23.39	4	0.5
6	HSUPA	23.84	23.82	23.75	1	0
6		21.97	22.01	21.89	2	2
6		22.94	23.05	22.94	3	1
6		21.99	21.95	22.03	4	2
6		23.82	23.80	23.71	5	0

3GPP Release Version	Mode	PCS Band [dBm]			Sub-Test (See Table Below)	MPR
		9262	9400	9538		
99	WCDMA	23.92	23.97	23.95	-	-
6	HSDPA	23.81	23.85	23.79	1	0
6		23.75	23.79	23.74	2	0
6		23.42	23.36	23.38	3	0.5
6		23.44	23.36	23.40	4	0.5
6	HSUPA	23.88	23.85	23.72	1	0
6		21.92	22.05	21.93	2	2
6		22.91	23.03	22.99	3	1
6		21.95	21.97	22.00	4	2
6		23.85	23.81	23.78	5	0

**Sub-Test Setup for Release 6 HSDPA**

Sub-Test	$\beta_c$	$\beta_d$	$B_c / \beta_d$	$\beta_{hs}$
1	2/15	15/15	2/15	4/15
2	12/15	15/15	15/15	24/15
3	15/15	8/15	15/8	30/15
4	15/15	4/15	15/4	30/15
$\Delta_{ack}, \Delta_{nack}$ and $\Delta_{cqi} = 8$				

**Sub-Test Setup for Release 6 HSUPA**

Sub-Test	$\beta_c$	$\beta_d$	$B_c / \beta_d$	$\beta_{hs}$	$B_{ec}$	$B_{ed}$	MPR	AG Index	E-TFCI
1	11/15	15/15	11/15	22/15	209/225	1039/225	0.0	20	75
2	6/15	15/15	6/15	12/15	12/15	94/75	2.0	12	67
3	15/15	9/15	15/9	30/15	30/15	47/15	1.0	15	92
4	2/15	15/15	2/15	4/15	2/15	56/15	2.0	17	71
5	15/15	15/15	15/15	30/15	24/15	134/15	0.0	21	81
$\Delta_{ack}, \Delta_{nack}$ and $\Delta_{cqi} = 8$									

Band	Mode	Bandwidth (MHz)	Channel	Frequency (MHz)	Data Rate	Avg Power (dBm)	Tune-up Pwr (dBm)
2450 MHz	802.11b	20	1	2412	1 Mbps	20.45	20.50
			6	2437		20.50	20.50
			11	2462		20.40	20.50
	802.11g	20	1	2412	6 Mbps	18.97	19.00
			6	2437		18.94	19.00
			11	2462		18.94	19.00
	802.11n	20	1	2412	HTO	18.95	19.00
			6	2437		18.87	19.00
			11	2462		18.90	19.00
	802.11n	40	3	2422	HTO	18.95	19.00
			6	2437		18.87	19.00
			9	2452		18.90	19.00

Band	Mode	Channel	Frequency (MHz)	Data Rate	Avg Power (dBm)	Tune-up Pwr (dBm)
2450 MHz	Bluetooth v4.0	0	2402	BDR	4.53	6.70
		39	2441		5.19	6.70
		78	2480		5.42	6.70
		0	2402	EDR	3.79	6.70
		39	2441		4.44	6.70
		78	2480		4.81	6.70

**Figure 10.1 Test Reduction Table – WiFi 2.4 GHz Main**

Mode	Side	Required Channel	Tested/Reduced
802.11b	Back	1 – 2412 MHz	Reduced <sup>1</sup>
		6 – 2437 MHz	Tested
		11 – 2462 MHz	Reduced <sup>1</sup>
	Right	1 – 2412 MHz	Reduced <sup>1</sup>
		6 – 2437 MHz	Tested
		11 – 2462 MHz	Reduced <sup>1</sup>
	Bottom	1 – 2412 MHz	Tested
		6 – 2437 MHz	Tested
		11 – 2462 MHz	Tested
	Remaining Sides		
802.11g	Back	1 – 2412 MHz	Reduced <sup>2</sup>
		6 – 2437 MHz	Reduced <sup>2</sup>
		11 – 2462 MHz	Reduced <sup>2</sup>
	Right	1 – 2412 MHz	Reduced <sup>2</sup>
		6 – 2437 MHz	Reduced <sup>2</sup>
		11 – 2462 MHz	Reduced <sup>2</sup>
	Bottom	1 – 2412 MHz	Reduced <sup>2</sup>
		6 – 2437 MHz	Reduced <sup>2</sup>
		11 – 2462 MHz	Reduced <sup>2</sup>
	Remaining Sides		
802.11n	Back	1 – 2412 MHz	Reduced <sup>2</sup>
		6 – 2437 MHz	Reduced <sup>2</sup>
		11 – 2462 MHz	Reduced <sup>2</sup>
	Right	1 – 2412 MHz	Reduced <sup>2</sup>
		6 – 2437 MHz	Reduced <sup>2</sup>
		11 – 2462 MHz	Reduced <sup>2</sup>
	Bottom	1 – 2412 MHz	Reduced <sup>2</sup>
		6 – 2437 MHz	Reduced <sup>2</sup>
		11 – 2462 MHz	Reduced <sup>2</sup>
	Remaining Sides		

Reduced<sup>1</sup> – When the reported SAR is ≤ 0.4 W/kg, SAR is not required for the remaining test configuration per KDB 248227 D01 v02r02 section 5.1.1 1) page 9.

Reduced<sup>2</sup> – When the highest reported SAR for DSSS is adjusted by the ratio of OFDM to DSSS specified maximum output power and the adjusted SAR is ≤ 1.2 W/kg, SAR is not required per KDB 248227 D01 v02 section 5.2.2 2) page 10.

Reduced<sup>3</sup> – When the antenna is more than 25 mm from a side, the test can be reduced per KDB447498 D01 v06 section 4.3.1 2) page 11. See below for calculations.

Maximum power: 112.2 mW  
 Closest Distance to Left: 95 mm  
 Closest Distance to Top: 210 mm

The closest distance is from the left side. Therefore, if the left side is excluded the top would also be excluded.

$$[(((3.0)/(\sqrt{2.462})) * 50 \text{ mm})] + [(95 - 50 \text{ mm}) * 10] = 545 \text{ mW which is greater than } 112.2 \text{ mW}$$

**Figure 10.2 Test Reduction Table – 3G WCDMA**

Band/ Frequency (MHz)	Technology	Side	Required Channel	Tested/ Reduced		
Band 5 824-849 MHz	WCDMA	Back	4132	Reduced <sup>1</sup>		
			4183	Tested		
			4233	Reduced <sup>1</sup>		
		Left	4132	Reduced <sup>1</sup>		
			4183	Tested		
			4233	Reduced <sup>1</sup>		
		Top	4132	Reduced <sup>1</sup>		
			4183	Tested		
			4233	Reduced <sup>1</sup>		
		Remaining Sides				Reduced <sup>2</sup>
		Band 4 1710-1755 MHz	WCDMA	Back	1312	Reduced <sup>1</sup>
					1413	Tested
1513	Reduced <sup>1</sup>					
Left	1312			Tested		
	1413			Tested		
	1513			Tested		
Top	1312			Reduced <sup>1</sup>		
	1413			Tested		
	1513			Reduced <sup>1</sup>		
Remaining Sides					Reduced <sup>2</sup>	
Band 2 1850-1910 MHz	WCDMA			Back	9262	Reduced <sup>1</sup>
					9400	Tested
		9538	Reduced <sup>1</sup>			
		Left	9262	Tested		
			9400	Tested		
			9538	Tested		
		Top	9262	Reduced <sup>1</sup>		
			9400	Tested		
			9538	Reduced <sup>1</sup>		
		Remaining Sides				Reduced <sup>2</sup>

Reduced<sup>1</sup> – When the mid channel is 3 dB below the limit, the remaining channels are not required per KDB 447498 D01 v06 section 4.3.3 page 14.

Reduced<sup>2</sup> – When the antenna is more than 25 mm from a side, the test can be reduced per KDB447498 D01 v06 section 4.3.1 1) page 11. See below for calculations.

Maximum power: 251.2 mW  
 Closest Distance to Right: 115 mm  
 Closest Distance to Bottom: 160 mm

The closest distance is from the right side. Therefore, if the right side is excluded the bottom side would also be excluded.

$$[{\{(3.0)/(\sqrt{0.849})\} * 50 \text{ mm}}] + [115 - 50 \text{ mm}] * 10 = 812 \text{ mW which is greater than 251.2 mW}$$

$$[{\{(3.0)/(\sqrt{1.755})\} * 50 \text{ mm}}] + [115 - 50 \text{ mm}] * 10 = 763 \text{ mW which is greater than 251.2 mW}$$

$$[{\{(3.0)/(\sqrt{1.91})\} * 50 \text{ mm}}] + [115 - 50 \text{ mm}] * 10 = 758 \text{ mW which is greater than 251.2 mW}$$

### 10.1.1 LTE Functionality

The follow table identifies all the channel bandwidths in each frequency band supported by this device.

LTE Band Class	Bandwidth (MHz)	Frequency or Freq. Band (MHz)
2	1.4, 3, 5, 10, 15, 20	1850-1910 MHz
4	1.4, 3, 5, 10, 15, 20	1710-1755 MHz
5	5, 10	824-849 MHz
12	5, 10	699-716 MHz

### 10.1.2 Test Conditions

All SAR measurements for LTE were performed using the Anritsu MT8820C. A closed loop power control setting allowed the UE to transmit at the maximum output power during the SAR measurements. The Figure 11.1 table indicates all the test reduction utilized for this report.

MPR was enabled for this device. A-MPR was disabled for all SAR test measurements.

**Table 10.1.1 LTE Power Measurements**

Band	Modulation	Bandwidth	RB Size	RB Offset	Channel	Frequency	Power
2	QPSK	1.4 MHz	6	0	18607	1850.7	21.95
					18900	1880	22.20
					19193	1909.3	21.19
			3	1	18607	1850.7	23.00
					18900	1880	23.00
					19193	1909.3	22.70
			1	0	18607	1850.7	24.00
					18900	1880	23.61
					19193	1909.3	23.85
			1	5	18607	1850.7	23.99
					18900	1880	24.00
					19193	1909.3	23.99
		3 MHz	15	0	18615	1851.5	22.01
					18900	1880	22.11
					19185	1908.5	21.91
			8	3	18615	1851.5	21.95
					18900	1880	22.05
					19185	1908.5	21.81
			1	0	18615	1851.5	24.00
					18900	1880	23.74
					19185	1908.5	23.99
			1	14	18615	1851.5	23.99
					18900	1880	23.73
					19185	1908.5	24.00
		5 MHz	25	0	18625	1852.5	21.93
					18900	1880	21.98
					19175	1907.5	21.92
			12	6	18625	1852.5	21.83
					18900	1880	22.13
					19175	1907.5	21.88
			1	0	18625	1852.5	22.95
					18900	1880	22.56
					19175	1907.5	22.32
			1	24	18625	1852.5	22.45
					18900	1880	22.36
					19175	1907.5	22.98

**Table 10.1.2 LTE Power Measurements**

Band	Modulation	Bandwidth	RB Size	RB Offset	Channel	Frequency	Power
2	QPSK	10 MHz	50	0	18650	1855	21.52
					18900	1880	21.55
					19150	1905	21.57
			25	12	18650	1855	21.30
					18900	1880	21.95
					19150	1905	21.42
			1	0	18650	1855	23.95
					18900	1880	23.30
					19150	1905	23.23
		1	24	18650	1855	23.46	
				18900	1880	24.00	
				19150	1905	23.35	
		15 MHz	75	0	18675	1857.5	21.38
					18900	1880	21.51
					19125	1902.5	21.46
			36	19	18675	1857.5	21.16
					18900	1880	21.86
					19125	1902.5	21.31
			1	0	18675	1857.5	23.89
					18900	1880	23.38
					19125	1902.5	23.42
		1	74	18675	1857.5	23.48	
				18900	1880	23.31	
				19125	1902.5	24.00	
		20 MHz	100	0	18625	1852.5	21.50
					18900	1880	21.52
					19175	1907.5	21.40
			50	25	18700	1860	21.89
					18900	1880	21.91
					19100	1900	21.92
1	0		18700	1860	23.98		
			18900	1880	23.97		
			19100	1900	23.94		
1	49	18700	1860	23.33			
		18900	1880	23.35			
		19100	1900	23.43			



**Table 10.1.3 LTE Power Measurements**

Band	Modulation	Bandwidth	RB Size	RB Offset	Channel	Frequency	Power
2	16QAM	1.4 MHz	6	0	18607	1850.7	20.96
					18900	1880	21.11
					19193	1909.3	20.92
			3	1	18607	1850.7	20.95
					18900	1880	21.14
					19193	1909.3	20.88
			1	0	18607	1850.7	20.94
					18900	1880	21.12
					19193	1909.3	20.91
		1	5	18607	1850.7	20.91	
				18900	1880	21.10	
				19193	1909.3	20.93	
		3 MHz	15	0	18615	1851.5	20.98
					18900	1880	21.14
					19185	1908.5	20.92
			8	3	18615	1851.5	20.76
					18900	1880	21.10
					19185	1908.5	20.82
			1	0	18615	1851.5	21.92
					18900	1880	21.63
					19185	1908.5	21.75
		1	14	18615	1851.5	21.69	
				18900	1880	21.39	
				19185	1908.5	21.74	
		5 MHz	25	0	18625	1852.5	21.01
					18900	1880	20.96
					19175	1907.5	21.01
			12	6	18625	1852.5	20.84
					18900	1880	21.21
					19175	1907.5	20.88
1	0		18625	1852.5	21.79		
			18900	1880	21.44		
			19175	1907.5	21.37		
1	24	18625	1852.5	21.21			
		18900	1880	21.07			
		19175	1907.5	21.75			

**Table 10.1.4 LTE Power Measurements**

Band	Modulation	Bandwidth	RB Size	RB Offset	Channel	Frequency	Power
2	16QAM	10 MHz	50	0	18650	1855	20.30
					18900	1880	20.62
					19150	1905	20.53
			25	12	18650	1855	20.17
					18900	1880	20.81
					19150	1905	20.42
			1	0	18650	1855	21.77
					18900	1880	21.19
					19150	1905	21.07
			1	24	18650	1855	21.24
					18900	1880	21.96
					19150	1905	21.25
		15 MHz	75	0	18675	1857.5	20.35
					18900	1880	20.25
					19125	1902.5	20.46
			36	19	18675	1857.5	20.17
					18900	1880	20.64
					19125	1902.5	20.23
			1	0	18675	1857.5	21.79
					18900	1880	21.07
					19125	1902.5	21.21
			1	74	18675	1857.5	21.13
					18900	1880	20.96
					19125	1902.5	21.76
		20 MHz	100	0	18625	1852.5	20.54
					18900	1880	20.50
					19175	1907.5	20.32
			50	25	18700	1860	20.39
					18900	1880	20.54
					19100	1900	20.16
			1	0	18700	1860	21.68
					18900	1880	21.38
					19100	1900	20.74
			1	99	18700	1860	21.01
					18900	1880	20.71
					19100	1900	21.68

**Table 10.1.5 LTE Power Measurements**

Band	Modulation	Bandwidth	RB Size	RB Offset	Channel	Frequency	Power
4	QPSK	1.4 MHz	6	0	19957	1710.7	22.67
					20175	1732.5	22.06
					20393	1754.3	22.61
			3	1	19957	1710.7	22.99
					20175	1732.5	23.00
					20393	1754.3	22.99
			1	0	19957	1710.7	23.98
					20175	1732.5	23.58
					20393	1754.3	23.99
		1	5	19957	1710.7	23.98	
				20175	1732.5	23.93	
				20393	1754.3	24.00	
		3 MHz	15	0	19965	1711.5	22.11
					20175	1732.5	22.09
					20385	1753.5	22.15
			8	3	19965	1711.5	22.02
					20175	1732.5	21.93
					20385	1753.5	22.07
			1	0	19965	1711.5	24.00
					20175	1732.5	23.40
					20385	1753.5	23.53
			1	14	19965	1711.5	23.34
					20175	1732.5	23.99
					20385	1753.5	23.94
		5 MHz	25	0	19975	1712.5	21.49
					20175	1732.5	22.19
					20375	1752.5	21.87
			12	6	19975	1712.5	21.44
					20175	1732.5	22.13
					20375	1752.5	21.64
			1	0	19975	1712.5	23.99
					20175	1732.5	23.31
					20375	1752.5	23.67
			1	24	19975	1712.5	23.19
					20175	1732.5	24.00
					20375	1752.5	23.99

**Table 10.1.6 LTE Power Measurements**

Band	Modulation	Bandwidth	RB Size	RB Offset	Channel	Frequency	Power
4	QPSK	10 MHz	50	0	20000	1715	21.36
					20175	1732.5	21.99
					20350	1750	21.80
			25	12	20000	1715	20.92
					20175	1732.5	22.04
					20350	1750	21.57
			1	0	20000	1715	24.00
					20175	1732.5	23.31
					20350	1750	23.60
		1	24	20000	1715	23.14	
				20175	1732.5	23.92	
				20350	1750	23.67	
		15 MHz	75	0	20025	1717.5	21.29
					20175	1732.5	21.67
					20325	1747.5	21.62
			36	19	20025	1717.5	21.01
					20175	1732.5	22.17
					20325	1747.5	21.64
			1	0	20025	1717.5	23.99
					20175	1732.5	23.13
					20325	1747.5	23.38
		1	74	20025	1717.5	23.18	
				20175	1732.5	23.45	
				20325	1747.5	23.60	
		20 MHz	100	0	20050	1720	21.23
					20175	1732.5	21.68
					20300	1745	21.52
			50	25	20050	1720	22.35
					20175	1732.5	22.00
					20300	1745	21.91
1	0		20050	1720	24.00		
			20175	1732.5	23.90		
			20300	1745	23.98		
1	49	20050	1720	23.68			
		20175	1732.5	23.56			
		20300	1745	24.00			

**Table 10.1.7 LTE Power Measurements**

Band	Modulation	Bandwidth	RB Size	RB Offset	Channel	Frequency	Power
4	16QAM	1.4 MHz	6	0	19957	1710.7	21.51
					20175	1732.5	21.02
					20393	1754.3	21.52
			3	1	19957	1710.7	22.44
					20175	1732.5	21.90
					20393	1754.3	22.25
			1	0	19957	1710.7	22.39
					20175	1732.5	22.52
					20393	1754.3	22.25
		1	5	19957	1710.7	22.09	
				20175	1732.5	22.05	
				20393	1754.3	22.21	
		3 MHz	15	0	19965	1711.5	21.12
					20175	1732.5	21.19
					20385	1753.5	21.22
			8	3	19965	1711.5	21.02
					20175	1732.5	21.05
					20385	1753.5	21.27
			1	0	19965	1711.5	22.20
					20175	1732.5	22.22
					20385	1753.5	22.51
		1	14	19965	1711.5	22.18	
				20175	1732.5	22.32	
				20385	1753.5	22.50	
		5 MHz	25	0	19975	1712.5	20.53
					20175	1732.5	21.19
					20375	1752.5	20.94
			12	6	19975	1712.5	20.51
					20175	1732.5	21.00
					20375	1752.5	20.59
1	0		19975	1712.5	22.40		
			20175	1732.5	22.03		
			20375	1752.5	22.33		
1	24	19975	1712.5	22.62			
		20175	1732.5	22.26			
		20375	1752.5	22.33			

**Table 10.1.8 LTE Power Measurements**

Band	Modulation	Bandwidth	RB Size	RB Offset	Channel	Frequency	Power
4	16QAM	10 MHz	50	0	20000	1715	20.37
					20175	1732.5	21.06
					20350	1750	20.69
			25	12	20000	1715	20.11
					20175	1732.5	20.96
					20350	1750	20.44
			1	0	20000	1715	22.35
					20175	1732.5	20.91
					20350	1750	21.26
		1	24	20000	1715	21.00	
				20175	1732.5	21.83	
				20350	1750	21.33	
		15 MHz	75	0	20025	1717.5	20.23
					20175	1732.5	20.58
					20325	1747.5	20.61
			36	19	20025	1717.5	20.13
					20175	1732.5	21.17
					20325	1747.5	20.55
			1	0	20025	1717.5	22.38
					20175	1732.5	20.79
					20325	1747.5	21.15
		1	74	20025	1717.5	20.96	
				20175	1732.5	21.32	
				20325	1747.5	22.19	
		20 MHz	100	0	20050	1720	20.30
					20175	1732.5	20.65
					20300	1745	20.57
			50	25	20050	1720	20.21
					20175	1732.5	21.12
					20300	1745	20.58
1	0		20050	1720	22.20		
			20175	1732.5	22.13		
			20300	1745	21.75		
1	99	20050	1720	20.94			
		20175	1732.5	21.35			
		20300	1745	22.24			

**Table 10.1.9 LTE Power Measurements**

Band	Modulation	Bandwidth	RB Size	RB Offset	Channel	Frequency	Power
5	QPSK	5 MHz	25	0	20425	826.5	23.01
					20525	836.5	23.06
					20625	846.5	23.18
			12	6	20425	826.5	23.76
					20525	836.5	23.85
					20625	846.5	23.97
			1	0	20425	826.5	23.91
					20525	836.5	23.97
					20625	846.5	24.00
			1	24	20425	826.5	23.89
					20525	836.5	24.00
					20625	846.5	24.00
		10 MHz	50	0	20450	829.0	23.01
					20525	836.5	23.05
					20600	844.0	23.11
			25	12	20450	829.0	23.87
					20525	836.5	23.91
					20600	844.0	23.93
			1	0	20450	829.0	23.96
					20525	836.5	23.97
					20600	844.0	24.00
			1	24	20450	829.0	23.89
					20525	836.5	23.94
					20600	844.0	24.00

**Table 10.1.10 LTE Power Measurements**

Band	Modulation	Bandwidth	RB Size	RB Offset	Channel	Frequency	Power
5	16QAM	5 MHz	25	0	20425	826.5	21.12
					20525	836.5	21.08
					20625	846.5	21.16
			12	6	20425	826.5	22.89
					20525	836.5	22.92
					20625	846.5	22.99
			1	0	20425	826.5	22.96
					20525	836.5	22.98
					20625	846.5	21.13
		1	24	20425	826.5	22.92	
				20525	836.5	21.16	
				20625	846.5	21.33	
		10 MHz	50	0	20450	829.0	21.08
					20525	836.5	21.10
					20600	844.0	21.16
			25	12	20450	829.0	22.92
					20525	836.5	22.97
					20600	844.0	22.96
			1	0	20450	829.0	22.98
					20525	836.5	22.99
					20600	844.0	21.11
1	24		20450	829.0	22.93		
			20525	836.5	22.97		
			20600	844.0	21.15		



**Table 10.1.11 LTE Power Measurements**

Band	Modulation	Bandwidth	RB Size	RB Offset	Channel	Frequency	Power
12	QPSK	5 MHz	25	0	23035	701.5	23.19
					23095	707.5	23.20
					23155	713.5	23.15
			12	6	23035	701.5	24.00
					23095	707.5	24.00
					23155	713.5	24.00
			1	0	23035	701.5	24.00
					23095	707.5	24.00
					23155	713.5	24.00
			1	24	23035	701.5	24.00
					23095	707.5	24.00
					23155	713.5	24.00
		10 MHz	50	0	23060	704.0	23.08
					23095	707.5	23.15
					23129	711.0	23.21
			25	12	23060	704.0	24.00
					23095	707.5	24.00
					23129	711.0	24.00
			1	0	23060	704.0	24.00
					23095	707.5	24.00
					23129	711.0	24.00
			1	24	23060	704.0	24.00
					23095	707.5	24.00
					23129	711.0	24.00

**Table 10.1.12 LTE Power Measurements**

Band	Modulation	Bandwidth	RB Size	RB Offset	Channel	Frequency	Power
12	16QAM	5 MHz	25	0	23035	701.5	21.29
					23095	707.5	21.23
					23155	713.5	21.19
			12	6	23035	701.5	23.10
					23095	707.5	23.08
					23155	713.5	23.13
			1	0	23035	701.5	23.18
					23095	707.5	23.24
					23155	713.5	23.26
			1	24	23035	701.5	23.29
					23095	707.5	23.18
					23155	713.5	23.27
		10 MHz	50	0	23060	704.0	21.14
					23095	707.5	21.26
					23129	711.0	21.30
			25	12	23060	704.0	23.05
					23095	707.5	23.08
					23129	711.0	23.14
			1	0	23060	704.0	23.07
					23095	707.5	23.18
					23129	711.0	23.15
			1	24	23060	704.0	23.22
					23095	707.5	23.27
					23129	711.0	23.20

**Table 10.4.1 Test Reduction Table – LTE**

Band/ Frequency (MHz)	Side	Required Test Channel	Bandwidth	Modulation	RB Allocation	RB Offset	Tested/ Reduced		
Band 2 1850-1910 MHz	Back	18700	20 MHz	QPSK	50	0	Reduced <sup>7</sup>		
		18900					Tested		
		19100					Reduced <sup>7</sup>		
		18700					100	0	Reduced <sup>1</sup>
		18900							Reduced <sup>1</sup>
		19100							Reduced <sup>1</sup>
		18700			1	49	Reduced <sup>7</sup>		
		18900					Tested		
		19100					Reduced <sup>7</sup>		
		18700					99	99	Reduced <sup>2</sup>
		18900							Reduced <sup>2</sup>
		19100			16QAM	25	Reduced <sup>3</sup>		
		18700					50	25	Reduced <sup>3</sup>
		18900							Reduced <sup>3</sup>
		19100		Reduced <sup>3</sup>					
		18700		100			0	Reduced <sup>1</sup>	
		18900						Reduced <sup>1</sup>	
		19100			Reduced <sup>1</sup>				
		18700		1	49	Reduced <sup>4</sup>			
		18900				Reduced <sup>4</sup>			
		19100				Reduced <sup>4</sup>			
	18700	99	99			Reduced <sup>4</sup>			
	18900					Reduced <sup>4</sup>			
	19100					Reduced <sup>4</sup>			
	All lower bandwidths (15 MHz, 10 MHz, 5 MHz, 3 MHz, 1.4 MHz)							Reduced <sup>5</sup>	
	Left	QPSK	18700	20 MHz	50	25	Reduced <sup>7</sup>		
			18900				Tested		
			19100				Reduced <sup>7</sup>		
			18700				100	0	Reduced <sup>7</sup>
			18900						Tested
			19100						Reduced <sup>7</sup>
			18700		1	0	Tested		
			18900				Tested		
			19100				Tested		
			18700				99	99	Reduced <sup>2</sup>
			18900						Reduced <sup>2</sup>
			19100		16QAM	25	Reduced <sup>2</sup>		
			18700				50	25	Reduced <sup>3</sup>
			18900						Reduced <sup>3</sup>
		19100	Reduced <sup>3</sup>						
		18700	100	0			Reduced <sup>1</sup>		
		18900					Reduced <sup>1</sup>		
19100		Reduced <sup>1</sup>							
18700		1	0	Reduced <sup>4</sup>					
18900				Reduced <sup>4</sup>					
19100				Reduced <sup>4</sup>					
18700	99			99	Reduced <sup>4</sup>				
18900					Reduced <sup>4</sup>				
19100					Reduced <sup>4</sup>				
All lower bandwidths (15 MHz, 10 MHz, 5 MHz, 3 MHz, 1.4 MHz)							Reduced <sup>5</sup>		

Reduced<sup>1</sup> – If the SAR value in the 50% RB testing is less than 1.45 W/kg, the 100% RB testing is reduced per KDB941225 D05 3) A) I) page 4.  
 Reduced<sup>2</sup> – If the SAR value in the 1 RB testing is less than 1.45 W/kg, the remaining channels are reduced per KDB941225 D05 3) B) I) page 4.  
 Reduced<sup>3</sup> – If the SAR value in the 50% RB testing is less than 1.45 W/kg, the remaining channels are reduced per KDB941225 D05 4) A) I) page 4.  
 Reduced<sup>4</sup> – If the SAR value in the 1 RB testing is less than 1.45 W/kg, the remaining channels are reduced per KDB941225 D05 4) B) I) page 5.  
 Reduced<sup>5</sup> – If the conducted power is within ±0.5 dB, all testing where the SAR value is less than 1.45 W/kg is reduced per KDB941225 D05 5) B) I) page 5.  
 Reduced<sup>6</sup> – When the antenna is more than 25 mm from a side, the test can be reduced per KDB447498 D01 v06 section 4.3.1 1) page 11. See below for calculations.  
 Reduced<sup>7</sup> – When the measured channel is less than 3 dB from the limit, the remaining channels are not required per KDB447498 D01 v06 section 4.3.3 page 14.

Maximum power: 251.2 mW  
 Closest Distance to Right: 115 mm  
 Closest Distance to Bottom: 160 mm

The closest distance is from the right side. Therefore, if the right side is excluded the bottom side would also be excluded.

$$[[[(3.0)/(\sqrt{1.91})]*50 \text{ mm}]]+[(115-50 \text{ mm})*10]=758 \text{ mW which is greater than } 251.2 \text{ mW}$$

**Table 10.4.2 Test Reduction Table – LTE**

Band/ Frequency (MHz)	Side	Required Test Channel	Bandwidth	Modulation	RB Allocation	RB Offset	Tested/ Reduced				
Band 2 1850-1910 MHz	Top	18700	20 MHz	QPSK	50	0	Reduced <sup>7</sup>				
		18900					Tested				
		19100					Reduced <sup>7</sup>				
		18700					100	0	Reduced <sup>1</sup>		
		18900							Reduced <sup>1</sup>		
		19100							Reduced <sup>1</sup>		
		18700			1	0	Reduced <sup>7</sup>				
		18900					Tested				
		19100				99	Reduced <sup>7</sup>				
		18700					Reduced <sup>2</sup>				
		18900			16QAM	50	25	Reduced <sup>2</sup>			
		19100						Reduced <sup>2</sup>			
		18700						100	0	Reduced <sup>3</sup>	
		18900								Reduced <sup>3</sup>	
		19100		Reduced <sup>1</sup>							
		18700		1				0	Reduced <sup>1</sup>		
		18900				Reduced <sup>1</sup>					
		19100				Reduced <sup>4</sup>					
		18700				99	Reduced <sup>4</sup>				
		18900					Reduced <sup>4</sup>				
		19100		Reduced <sup>4</sup>							
		All lower bandwidths (15 MHz, 10 MHz, 5 MHz, 3 MHz, 1.4 MHz)							Reduced <sup>5</sup>		
		All remaining sides							Reduced <sup>6</sup>		

Reduced<sup>1</sup> – If the SAR value in the 50% RB testing is less than 1.45 W/kg, the 100% RB testing is reduced per KDB941225 D05 3) A) I) page 4.

Reduced<sup>2</sup> – If the SAR value in the 1 RB testing is less than 1.45 W/kg, the remaining channels are reduced per KDB941225 D05 3) B) I) page 4.

Reduced<sup>3</sup> – If the SAR value in the 50% RB testing is less than 1.45 W/kg, the remaining channels are reduced per KDB941225 D05 4) A) I) page 4.

Reduced<sup>4</sup> – If the SAR value in the 1 RB testing is less than 1.45 W/kg, the remaining channels are reduced per KDB941225 D05 4) B) I) page 5.

Reduced<sup>5</sup> – If the conducted power is within ±0.5 dB, all testing where the SAR value is less than 1.45 W/kg is reduced per KDB941225 D05 5) B) I) page 5.

Reduced<sup>6</sup> – When the antenna is more than 25 mm from a side, the test can be reduced per KDB447498 D01 v06 section 4.3.1 1) page 11. See below for calculations.

Reduced<sup>7</sup> – When the measured channel is less than 3 dB from the limit, the remaining channels are not required per KDB447498 D01 v06 section 4.3.3 page 14.

Maximum power: 251.2 mW

Closest Distance to Right: 115 mm

Closest Distance to Bottom: 160 mm

The closest distance is from the right side. Therefore, if the right side is excluded the bottom side would also be excluded.

$$[[(3.0)/(\sqrt{1.91})]^*50 \text{ mm}]+[(115-50 \text{ mm})^*10]=758 \text{ mW which is greater than } 251.2 \text{ mW}$$

**Table 10.4.3 Test Reduction Table – LTE**

Band/ Frequency (MHz)	Side	Required Test Channel	Bandwidth	Modulation	RB Allocation	RB Offset	Tested/ Reduced	
Band 4 1710-1755 MHz	Back	18700	20 MHz	QPSK	50	25	Reduced <sup>7</sup>	
		18900					Tested	
		19100					Reduced <sup>7</sup>	
		18700			100	0	Reduced <sup>1</sup>	
		18900					Reduced <sup>1</sup>	
		19100					Reduced <sup>1</sup>	
		18700			1	0	Reduced <sup>7</sup>	
		18900					Tested	
		19100					Reduced <sup>7</sup>	
		18700			99	99	Reduced <sup>2</sup>	
		18900					Reduced <sup>2</sup>	
		19100					Reduced <sup>2</sup>	
		18700			50	25	Reduced <sup>3</sup>	
		18900					Reduced <sup>3</sup>	
		19100					Reduced <sup>3</sup>	
		18700			100	0	Reduced <sup>1</sup>	
		18900					Reduced <sup>1</sup>	
		19100					Reduced <sup>1</sup>	
		18700			1	0	Reduced <sup>4</sup>	
		18900					Reduced <sup>4</sup>	
		19100					Reduced <sup>4</sup>	
	18700	99	99	Reduced <sup>4</sup>				
	18900			Reduced <sup>4</sup>				
	19100			Reduced <sup>4</sup>				
	All lower bandwidths (15 MHz, 10 MHz, 5 MHz, 3 MHz, 1.4 MHz)							Reduced <sup>5</sup>
	Left	Left	18700	20 MHz	QPSK	50	25	Tested
			18900					Tested
			19100					Tested
			18700			100	0	Reduced <sup>1</sup>
			18900					Tested
			19100					Reduced <sup>1</sup>
			18700			1	0	Tested
			18900					Tested
			19100					Tested
			18700			99	99	Reduced <sup>2</sup>
			18900					Reduced <sup>2</sup>
			19100					Reduced <sup>2</sup>
			18700			50	25	Reduced <sup>3</sup>
			18900					Reduced <sup>3</sup>
			19100					Reduced <sup>3</sup>
			18700			100	0	Reduced <sup>1</sup>
			18900					Reduced <sup>1</sup>
19100			Reduced <sup>1</sup>					
18700			1			0	Reduced <sup>4</sup>	
18900							Reduced <sup>4</sup>	
19100							Reduced <sup>4</sup>	
18700	99	99	Reduced <sup>4</sup>					
18900			Reduced <sup>4</sup>					
19100			Reduced <sup>4</sup>					
All lower bandwidths (15 MHz, 10 MHz, 5 MHz, 3 MHz, 1.4 MHz)							Reduced <sup>5</sup>	
All remaining sides							Reduced <sup>6</sup>	

Reduced<sup>1</sup> – If the SAR value in the 50% RB testing is less than 1.45 W/kg, the 100% RB testing is reduced per KDB941225 D05 3) A) I) page 4.  
 Reduced<sup>2</sup> – If the SAR value in the 1 RB testing is less than 1.45 W/kg, the remaining channels are reduced per KDB941225 D05 3) B) I) page 4.  
 Reduced<sup>3</sup> – If the SAR value in the 50% RB testing is less than 1.45 W/kg, the remaining channels are reduced per KDB941225 D05 4) A) I) page 4.  
 Reduced<sup>4</sup> – If the SAR value in the 1 RB testing is less than 1.45 W/kg, the remaining channels are reduced per KDB941225 D05 4) B) I) page 5.  
 Reduced<sup>5</sup> – If the conducted power is within ±0.5 dB, all testing where the SAR value is less than 1.45 W/kg is reduced per KDB941225 D05 5) B) I) page 5.  
 Reduced<sup>6</sup> – When the antenna is more than 25 mm from a side, the test can be reduced per KDB447498 D01 v06 section 4.3.1 1) page 11. See below for calculations.  
 Reduced<sup>7</sup> – When the measured channel is less than 3 dB from the limit, the remaining channels are not required per KDB447498 D01 v06 section 4.3.3 page 14.

Maximum power: 251.2 mW  
 Closest Distance to Right: 115 mm  
 Closest Distance to Bottom: 160 mm

The closest distance is from the right side. Therefore, if the right side is excluded the bottom side would also be excluded.

$$[[[(3.0)/(\sqrt{1.755})]*50 \text{ mm}]]+[[115-50 \text{ mm}]*10]=763 \text{ mW which is greater than 251.2 mW}$$

**Table 10.4.4 Test Reduction Table – LTE**

Band/ Frequency (MHz)	Side	Required Test Channel	Bandwidth	Modulation	RB Allocation	RB Offset	Tested/ Reduced				
Band 4 1710-1755 MHz	Top	18700	20 MHz	QPSK	50	25	Reduced <sup>7</sup>				
		18900					Tested				
		19100					Reduced <sup>7</sup>				
		18700					Reduced <sup>1</sup>				
		18900			100	0	Reduced <sup>1</sup>				
		19100					Reduced <sup>1</sup>				
		18700			1	0	Reduced <sup>7</sup>				
		18900					Tested				
		19100					Reduced <sup>7</sup>				
		18700				99	Reduced <sup>2</sup>				
		18900					Reduced <sup>2</sup>				
		19100					Reduced <sup>2</sup>				
		18700			16QAM	50	25	Reduced <sup>3</sup>			
		18900						Reduced <sup>3</sup>			
		19100		Reduced <sup>1</sup>							
		18700		Reduced <sup>1</sup>							
		18900		100		0	Reduced <sup>1</sup>				
		19100					Reduced <sup>1</sup>				
		18700		1		0	Reduced <sup>4</sup>				
		18900					Reduced <sup>4</sup>				
		19100					Reduced <sup>4</sup>				
		18700				99	Reduced <sup>4</sup>				
		18900					Reduced <sup>4</sup>				
		19100					Reduced <sup>4</sup>				
		All lower bandwidths (15 MHz, 10 MHz, 5 MHz, 3 MHz, 1.4 MHz)							Reduced <sup>5</sup>		
		All remaining sides							Reduced <sup>6</sup>		

Reduced<sup>1</sup> – If the SAR value in the 50% RB testing is less than 1.45 W/kg, the 100% RB testing is reduced per KDB941225 D05 3) A) I) page 4.

Reduced<sup>2</sup> – If the SAR value in the 1 RB testing is less than 1.45 W/kg, the remaining channels are reduced per KDB941225 D05 3) B) I) page 4.

Reduced<sup>3</sup> – If the SAR value in the 50% RB testing is less than 1.45 W/kg, the remaining channels are reduced per KDB941225 D05 4) A) I) page 4.

Reduced<sup>4</sup> – If the SAR value in the 1 RB testing is less than 1.45 W/kg, the remaining channels are reduced per KDB941225 D05 4) B) I) page 5.

Reduced<sup>5</sup> – If the conducted power is within ±0.5 dB, all testing where the SAR value is less than 1.45 W/kg is reduced per KDB941225 D05 5) B) I) page 5.

Reduced<sup>6</sup> – When the antenna is more than 25 mm from a side, the test can be reduced per KDB447498 D01 v06 section 4.3.1 1) page 11. See below for calculations.

Reduced<sup>7</sup> – When the measured channel is less than 3 dB from the limit, the remaining channels are not required per KDB447498 D01 v06 section 4.3.3 page 14.

Maximum power: 251.2 mW

Closest Distance to Right: 115 mm

Closest Distance to Bottom: 160 mm

The closest distance is from the right side. Therefore, if the right side is excluded the bottom side would also be excluded.

$$[[(3.0)/(\sqrt{1.755})]^2 * 50 \text{ mm}] + [(115 - 50 \text{ mm})^2 * 10] = 763 \text{ mW}$$

which is greater than 251.2 mW

**Table 10.4.5 Test Reduction Table – LTE**

Band/ Frequency (MHz)	Side	Required Test Channel	Bandwidth	Modulation	RB Allocation	RB Offset	Tested/ Reduced	
Band 5 824-849 MHz	Back	20450	10 MHz	QPSK	25	12	Reduced <sup>7</sup>	
		20525					Tested	
		20600					Reduced <sup>7</sup>	
		20450			50	0	Reduced <sup>1</sup>	
		20525					Reduced <sup>1</sup>	
		20600					Reduced <sup>1</sup>	
		20450			1	0	Reduced <sup>7</sup>	
		20525					Tested	
		20600					Reduced <sup>7</sup>	
		20450			1	24	Reduced <sup>2</sup>	
		20525					Reduced <sup>2</sup>	
		20600					Reduced <sup>2</sup>	
		20450			25	12	Reduced <sup>3</sup>	
		20525					Reduced <sup>3</sup>	
		20600					Reduced <sup>3</sup>	
		20450			50	0	Reduced <sup>1</sup>	
		20525					Reduced <sup>1</sup>	
		20600					Reduced <sup>1</sup>	
		20450			1	0	Reduced <sup>4</sup>	
		20525					Reduced <sup>4</sup>	
		20600					Reduced <sup>4</sup>	
	20450	1	24	Reduced <sup>4</sup>				
	20525			Reduced <sup>4</sup>				
	20600			Reduced <sup>4</sup>				
	All lower bandwidths (5 MHz)							Reduced <sup>5</sup>
	Back	Left	20450	10 MHz	QPSK	25	12	Reduced <sup>7</sup>
			20525					Tested
			20600					Reduced <sup>7</sup>
			20450			50	0	Reduced <sup>1</sup>
			20525					Reduced <sup>1</sup>
			20600					Reduced <sup>1</sup>
			20450			1	0	Reduced <sup>7</sup>
			20525					Tested
			20600					Reduced <sup>7</sup>
			20450			1	24	Reduced <sup>2</sup>
			20525					Reduced <sup>2</sup>
			20600					Reduced <sup>2</sup>
			20450			25	12	Reduced <sup>3</sup>
			20525					Reduced <sup>3</sup>
			20600					Reduced <sup>3</sup>
			20450			50	0	Reduced <sup>1</sup>
			20525					Reduced <sup>1</sup>
20600			Reduced <sup>1</sup>					
20450			1			0	Reduced <sup>4</sup>	
20525							Reduced <sup>4</sup>	
20600							Reduced <sup>4</sup>	
20450	1	24	Reduced <sup>4</sup>					
20525			Reduced <sup>4</sup>					
20600			Reduced <sup>4</sup>					
All lower bandwidths (5 MHz)							Reduced <sup>5</sup>	

Reduced<sup>1</sup> – If the SAR value in the 50% RB testing is less than 1.45 W/kg, the 100% RB testing is reduced per KDB941225 D05 3) A) I) page 4.  
 Reduced<sup>2</sup> – If the SAR value in the 1 RB testing is less than 1.45 W/kg, the remaining channels are reduced per KDB941225 D05 3) B) I) page 4.  
 Reduced<sup>3</sup> – If the SAR value in the 50% RB testing is less than 1.45 W/kg, the remaining channels are reduced per KDB941225 D05 4) A) I) page 4.  
 Reduced<sup>4</sup> – If the SAR value in the 1 RB testing is less than 1.45 W/kg, the remaining channels are reduced per KDB941225 D05 4) B) I) page 5.  
 Reduced<sup>5</sup> – If the conducted power is within ±0.5 dB, all testing where the SAR value is less than 1.45 W/kg is reduced per KDB941225 D05 5) B) I) page 5.  
 Reduced<sup>6</sup> – When the antenna is more than 25 mm from a side, the test can be reduced per KDB447498 D01 v06 section 4.3.1 1) page 11. See below for calculations.  
 Reduced<sup>7</sup> – When the measured channel is less than 3 dB from the limit, the remaining measured channels are not required per KDB447498 D01 v06 section 4.3.3 page 14.

Maximum power: 251.2 mW  
 Closest Distance to Right: 115 mm  
 Closest Distance to Bottom: 160 mm

The closest distance is from the right side. Therefore, if the right side is excluded the bottom side would also be excluded.

$$[[[(3.0)/(\sqrt{0.849})]*50 \text{ mm}]]+[(115-50 \text{ mm})*10]=812 \text{ mW which is greater than } 251.2 \text{ mW}$$

**Table 10.4.6 Test Reduction Table – LTE**

Band/ Frequency (MHz)	Side	Required Test Channel	Bandwidth	Modulation	RB Allocation	RB Offset	Tested/ Reduced				
Band 5 824-849 MHz	Top	20450	10 MHz	QPSK	25	12	Reduced <sup>7</sup>				
		20525					Tested				
		20600					Reduced <sup>7</sup>				
		20450			50	0	Reduced <sup>1</sup>				
		20525					Reduced <sup>1</sup>				
		20600					Reduced <sup>1</sup>				
		20450			1	0	Reduced <sup>7</sup>				
		20525					Tested				
		20600				Reduced <sup>7</sup>					
		20450				24	Reduced <sup>2</sup>				
		20525			Reduced <sup>2</sup>						
		20600			16QAM	25	12	Reduced <sup>2</sup>			
		20450						Reduced <sup>3</sup>			
		20525						Reduced <sup>3</sup>			
		20600		50		0	Reduced <sup>1</sup>				
		20450					Reduced <sup>1</sup>				
		20525					Reduced <sup>1</sup>				
		20600		1		0	Reduced <sup>4</sup>				
		20450					Reduced <sup>4</sup>				
		20525				24	Reduced <sup>4</sup>				
		20600					Reduced <sup>4</sup>				
		All lower bandwidths (5 MHz)							Reduced <sup>4</sup>		
		All remaining sides							Reduced <sup>5</sup>		

Reduced<sup>1</sup> – If the SAR value in the 50% RB testing is less than 1.45 W/kg, the 100% RB testing is reduced per KDB941225 D05 3) A) I) page 4.

Reduced<sup>2</sup> – If the SAR value in the 1 RB testing is less than 1.45 W/kg, the remaining channels are reduced per KDB941225 D05 3) B) I) page 4.

Reduced<sup>3</sup> – If the SAR value in the 50% RB testing is less than 1.45 W/kg, the remaining channels are reduced per KDB941225 D05 4) A) I) page 4.

Reduced<sup>4</sup> – If the SAR value in the 1 RB testing is less than 1.45 W/kg, the remaining channels are reduced per KDB941225 D05 4) B) I) page 5.

Reduced<sup>5</sup> – If the conducted power is within ±0.5 dB, all testing where the SAR value is less than 1.45 W/kg is reduced per KDB941225 D05 5) B) I) page 5.

Reduced<sup>6</sup> – When the antenna is more than 25 mm from a side, the test can be reduced per KDB447498 D01 v06 section 4.3.1 1) page 11. See below for calculations.

Reduced<sup>7</sup> – When the measured channel is less than 3 dB from the limit, the remaining channels are not required per KDB447498 D01 v06 section 4.3.3 page 14.

Maximum power: 251.2 mW

Closest Distance to Right: 115 mm

Closest Distance to Bottom: 160 mm

The closest distance is from the right side. Therefore, if the right side is excluded the bottom side would also be excluded.

$$[[(3.0)/(\sqrt{0.849})]*50 \text{ mm}]+[(115-50 \text{ mm})*10]=812 \text{ mW which is greater than } 251.2 \text{ mW}$$



**Table 10.4.7 Test Reduction Table – LTE**

Band/ Frequency (MHz)	Side	Required Test Channel	Bandwidth	Modulation	RB Allocation	RB Offset	Tested/ Reduced	
Band 12 699-716 MHz	Back	23060	10 MHz	QPSK	25	12	Reduced <sup>7</sup>	
		23095					Tested	
		23129					Reduced <sup>7</sup>	
		23060					Reduced <sup>1</sup>	
		23095					Reduced <sup>1</sup>	
		23129					Reduced <sup>1</sup>	
		23060			50	Reduced <sup>7</sup>		
		23095				Tested		
		23129				Reduced <sup>7</sup>		
		23060				Reduced <sup>2</sup>		
		23095				Reduced <sup>2</sup>		
		23129				Reduced <sup>2</sup>		
		23060			1	0	Reduced <sup>3</sup>	
		23095					Reduced <sup>3</sup>	
		23129					Reduced <sup>1</sup>	
		23060					Reduced <sup>1</sup>	
		23095					Reduced <sup>1</sup>	
		23129					Reduced <sup>1</sup>	
		23060			25	12	Reduced <sup>4</sup>	
		23095					Reduced <sup>4</sup>	
		23129					Reduced <sup>4</sup>	
	23060	Reduced <sup>4</sup>						
	23095	Reduced <sup>4</sup>						
	23129	Reduced <sup>4</sup>						
	23060	50	0	Reduced <sup>4</sup>				
	23095			Reduced <sup>4</sup>				
	23129			Reduced <sup>4</sup>				
	23060			Reduced <sup>4</sup>				
	23095			Reduced <sup>4</sup>				
	23129			Reduced <sup>4</sup>				
	23060	1	0	Reduced <sup>4</sup>				
	23095			Reduced <sup>4</sup>				
	23129			Reduced <sup>4</sup>				
	23060			Reduced <sup>4</sup>				
	23095			Reduced <sup>4</sup>				
	23129			Reduced <sup>4</sup>				
	All lower bandwidths (5 MHz)							Reduced <sup>5</sup>
	Left	Left	23060	10 MHz	QPSK	25	12	Reduced <sup>7</sup>
			23095					Tested
			23129					Reduced <sup>7</sup>
			23060					Reduced <sup>1</sup>
			23095					Reduced <sup>1</sup>
23129			Reduced <sup>1</sup>					
23060			50			Reduced <sup>7</sup>		
23095						Tested		
23129						Reduced <sup>7</sup>		
23060						Reduced <sup>2</sup>		
23095						Reduced <sup>2</sup>		
23129						Reduced <sup>2</sup>		
23060			1			0	Reduced <sup>3</sup>	
23095							Reduced <sup>3</sup>	
23129							Reduced <sup>1</sup>	
23060							Reduced <sup>1</sup>	
23095							Reduced <sup>1</sup>	
23129							Reduced <sup>1</sup>	
23060			25			12	Reduced <sup>4</sup>	
23095							Reduced <sup>4</sup>	
23129							Reduced <sup>4</sup>	
23060	Reduced <sup>4</sup>							
23095	Reduced <sup>4</sup>							
23129	Reduced <sup>4</sup>							
23060	50	0	Reduced <sup>4</sup>					
23095			Reduced <sup>4</sup>					
23129			Reduced <sup>4</sup>					
23060			Reduced <sup>4</sup>					
23095			Reduced <sup>4</sup>					
23129			Reduced <sup>4</sup>					
23060	1	0	Reduced <sup>4</sup>					
23095			Reduced <sup>4</sup>					
23129			Reduced <sup>4</sup>					
23060			Reduced <sup>4</sup>					
23095			Reduced <sup>4</sup>					
23129			Reduced <sup>4</sup>					
All lower bandwidths (5 MHz)							Reduced <sup>5</sup>	

Reduced<sup>1</sup> – If the SAR value in the 50% RB testing is less than 1.45 W/kg, the 100% RB testing is reduced per KDB941225 D05 3) A) I) page 4.  
 Reduced<sup>2</sup> – If the SAR value in the 1 RB testing is less than 1.45 W/kg, the remaining channels are reduced per KDB941225 D05 3) B) I) page 4.  
 Reduced<sup>3</sup> – If the SAR value in the 50% RB testing is less than 1.45 W/kg, the remaining channels are reduced per KDB941225 D05 4) A) I) page 4.  
 Reduced<sup>4</sup> – If the SAR value in the 1 RB testing is less than 1.45 W/kg, the remaining channels are reduced per KDB941225 D05 4) B) I) page 5.  
 Reduced<sup>5</sup> – If the conducted power is within ±0.5 dB, all testing where the SAR value is less than 1.45 W/kg is reduced per KDB941225 D05 5) B) I) page 5.  
 Reduced<sup>6</sup> – When the antenna is more than 25 mm from a side, the test can be reduced per KDB447498 D01 v06 section 4.3.1 1) page 11. See below for calculations.  
 Reduced<sup>7</sup> – When the measured channel is less than 3 dB from the limit, the remaining measured channels are not required per KDB447498 D01 v06 section 4.3.3 page 14.

Maximum power: 251.2 mW  
 Closest Distance to Right: 115 mm  
 Closest Distance to Bottom: 160 mm

The closest distance is from the right side. Therefore, if the right side is excluded the bottom side would also be excluded.

$$[[{(3.0)/(\sqrt{0.716})]^*50 \text{ mm}}]+[(115-50 \text{ mm})^*10]=827 \text{ mW which is greater than } 251.2 \text{ mW}$$

**Table 10.4.8 Test Reduction Table – LTE**

Band/ Frequency (MHz)	Side	Required Test Channel	Bandwidth	Modulation	RB Allocation	RB Offset	Tested/ Reduced			
Band 12 699-716 MHz	Top	23060	10 MHz	QPSK	25	12	Reduced <sup>7</sup>			
		23095					Tested			
		23129					Reduced <sup>7</sup>			
		23060					Reduced <sup>1</sup>			
		23095			50	0	Reduced <sup>1</sup>			
		23129					Reduced <sup>1</sup>			
		23060					Reduced <sup>7</sup>			
		23095			1	0	Tested			
		23129					Reduced <sup>7</sup>			
		23060					Reduced <sup>2</sup>			
		23095					Reduced <sup>2</sup>			
		23129			24		Reduced <sup>2</sup>			
		23060					Reduced <sup>3</sup>			
		23095			25	12	Reduced <sup>3</sup>			
		23129		Reduced <sup>3</sup>						
		23060		Reduced <sup>1</sup>						
		23095		Reduced <sup>1</sup>						
		23129		50	0	Reduced <sup>1</sup>				
		23060				Reduced <sup>1</sup>				
		23095				Reduced <sup>4</sup>				
		23129		1	0	Reduced <sup>4</sup>				
		23060				Reduced <sup>4</sup>				
		23095				Reduced <sup>4</sup>				
		23129				Reduced <sup>4</sup>				
		23060		24		Reduced <sup>4</sup>				
		23095				Reduced <sup>4</sup>				
		23129		All lower bandwidths (5 MHz)						Reduced <sup>5</sup>
		All remaining sides							Reduced <sup>6</sup>	

Reduced<sup>1</sup> – If the SAR value in the 50% RB testing is less than 1.45 W/kg, the 100% RB testing is reduced per KDB941225 D05 3) A) I) page 4.  
 Reduced<sup>2</sup> – If the SAR value in the 1 RB testing is less than 1.45 W/kg, the remaining channels are reduced per KDB941225 D05 3) B) I) page 4.  
 Reduced<sup>3</sup> – If the SAR value in the 50% RB testing is less than 1.45 W/kg, the remaining channels are reduced per KDB941225 D05 4) A) I) page 4.  
 Reduced<sup>4</sup> – If the SAR value in the 1 RB testing is less than 1.45 W/kg, the remaining channels are reduced per KDB941225 D05 4) B) I) page 5.  
 Reduced<sup>5</sup> – If the conducted power is within ±0.5 dB, all testing where the SAR value is less than 1.45 W/kg is reduced per KDB941225 D05 5) B) I) page 5.  
 Reduced<sup>6</sup> – When the antenna is more than 25 mm from a side, the test can be reduced per KDB447498 D01 v06 section 4.3.1 1) page 11. See below for calculations.  
 Reduced<sup>7</sup> – When the measured channel is less than 3 dB from the limit, the remaining channels are not required per KDB447498 D01 v06 section 4.3.3 page 14.

Maximum power: 251.2 mW  
 Closest Distance to Right: 115 mm  
 Closest Distance to Bottom: 160 mm

The closest distance is from the right side. Therefore, if the right side is excluded the bottom side would also be excluded.

$$[[(3.0)/(\sqrt{0.716})]^2 * 50 \text{ mm}] + [(115 - 50) * 10] = 827 \text{ mW which is greater than } 251.2 \text{ mW}$$

**SAR Data Summary – 750 MHz Body – LTE Band 12**

**MEASUREMENT RESULTS**

Gap	Plot	Position	Frequency		BW/ Modulation	RB Size	RB Offset	MPR Target	End Power (dBm)	Measured SAR (W/kg)	Reported SAR (W/kg)
			MHz	Ch.							
0 mm	-----	Back	707.5	23095	10 MHz/QPSK	1	24	0	24.00	0.288	0.29
	-----		707.5	23095	10 MHz/QPSK	25	12	1	24.00	0.231	0.23
	1	Left	707.5	23095	10 MHz/QPSK	1	24	0	24.00	0.616	0.62
	-----		707.5	23095	10 MHz/QPSK	25	12	1	24.00	0.503	0.50
	-----	Top	707.5	23095	10 MHz/QPSK	1	24	0	24.00	0.290	0.29
	-----		707.5	23095	10 MHz/QPSK	25	12	1	24.00	0.227	0.23

**Body**  
**1.6 W/kg (mW/g)**  
 averaged over 1 gram

1. SAR Measurement  
 Phantom Configuration  Left Head  Eli4  Right Head  
 SAR Configuration  Head  Body  
 2. Test Signal Call Mode  Test Code  Base Station Simulator  
 3. Test Configuration  With Belt Clip  Without Belt Clip  N/A  
 4. Tissue Depth is at least 15.0 cm

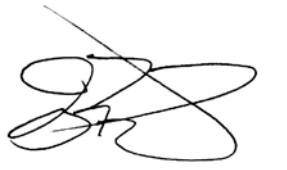

Jay M. Moulton  
 Vice President

**SAR Data Summary – 835 MHz Body - WCDMA**

**MEASUREMENT RESULTS**

Gap	Plot	Frequency		Modulation	Position	End Power (dBm)	RMC	Test Set Up	Measured SAR (W/kg)	Reported SAR (W/kg)
		MHz	Ch.							
0 mm	----	836.6	4183	WCDMA	Back	23.89	12.2 kbps	Test Loop 1	0.137	0.14
	2	836.6	4183	WCDMA	Left	23.89	12.2 kbps	Test Loop 1	0.572	0.59
	----	836.6	4183	WCDMA	Top	23.89	12.2 kbps	Test Loop 1	0.170	0.17

**Body**  
**1.6 W/kg (mW/g)**  
 averaged over 1 gram

1. SAR Measurement  
 Phantom Configuration  Left Head  Eli4  Right Head  
 SAR Configuration  Head  Body
2. Test Signal Call Mode  Test Code  Base Station Simulator
3. Test Configuration  With Belt Clip  Without Belt Clip  N/A
4. Tissue Depth is at least 15.0 cm



Jay M. Moulton  
 Vice President

**SAR Data Summary – 835 MHz Body – LTE Band 5**

MEASUREMENT RESULTS											
Gap	Plot	Position	Frequency		BW/ Modulation	RB Size	RB Offset	MPR Target	End Power (dBm)	Measured SAR (W/kg)	Reported SAR (W/kg)
			MHz	Ch.							
0 mm	----	Back	836.5	20525	10 MHz/QPSK	1	24	0	23.94	0.119	0.12
	----		836.5	20525	10 MHz/QPSK	25	12	1	23.91	0.103	0.11
	3	Left	836.5	20525	10 MHz/QPSK	1	24	0	23.94	0.510	0.52
	----		836.5	20525	10 MHz/QPSK	25	12	1	23.91	0.397	0.41
	----	Top	836.5	20525	10 MHz/QPSK	1	24	0	23.94	0.165	0.17
	----		836.5	20525	10 MHz/QPSK	25	12	1	23.91	0.132	0.14

**Body**  
**1.6 W/kg (mW/g)**  
 averaged over 1 gram

1. SAR Measurement  
 Phantom Configuration  Left Head  Eli4  Right Head  
 SAR Configuration  Head  Body
2. Test Signal Call Mode  Test Code  Base Station Simulator
3. Test Configuration  With Belt Clip  Without Belt Clip  N/A
4. Tissue Depth is at least 15.0 cm

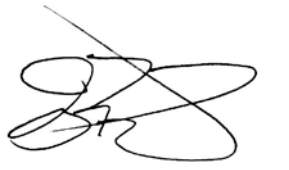

Jay M. Moulton  
 Vice President

## SAR Data Summary – 1750 MHz Body - WCDMA

### MEASUREMENT RESULTS

Gap	Plot	Frequency		Rev Level/ Modulation	Position	End Power (dBm)	RMC	Test Set Up	Measured SAR (W/kg)	Reported SAR (W/kg)
		MHz	Ch.							
0 mm	----	1732.6	1413	WCDMA	Back	23.90	12.2 kbps	Test Loop 1	0.723	0.74
	4	1712.4	1312	WCDMA	Left	23.88	12.2 kbps	Test Loop 1	1.24	1.28
	----	1732.6	1413	WCDMA		23.90	12.2 kbps	Test Loop 1	1.21	1.24
	----	1752.6	1513	WCDMA		23.95	12.2 kbps	Test Loop 1	1.14	1.15
	----	1732.6	1413	WCDMA	Top	23.90	12.2 kbps	Test Loop 1	0.366	0.38
	----	1712.4	1312	WCDMA	Repeat	23.88	12.2 kbps	Test Loop 1	1.22	1.25

**Body**  
**1.6 W/kg (mW/g)**  
 averaged over 1 gram

1. SAR Measurement
  - Phantom Configuration  Left Head  Eli4  Right Head
  - SAR Configuration  Head  Body
2. Test Signal Call Mode  Test Code  Base Station Simulator
3. Test Configuration  With Belt Clip  Without Belt Clip  N/A
4. Tissue Depth is at least 15.0 cm



Jay M. Moulton  
 Vice President

**SAR Data Summary – 1750 MHz Body – LTE Band 4**

MEASUREMENT RESULTS											
Gap	Plot	Position	Frequency		BW/ Modulation	RB Size	RB Offset	MPR Target	End Power (dBm)	Measured SAR (W/kg)	Reported SAR (W/kg)
			MHz	Ch.							
0 mm	-----	Back	1732.5	20175	20 MHz/QPSK	1	49	0	23.56	0.626	0.69
	-----		1732.5	20175	20 MHz/QPSK	50	24	1	22.00	0.511	0.64
	5	Left	1720.0	20050	20 MHz/QPSK	1	49	0	23.68	1.28	1.38
	-----		1732.5	20175	20 MHz/QPSK	1	49	0	23.56	1.15	1.27
	-----		1745.0	20300	20 MHz/QPSK	1	49	0	24.00	1.14	1.14
	-----		1720.0	20050	20 MHz/QPSK	50	24	1	22.35	1.03	1.20
	-----		1732.5	20175	20 MHz/QPSK	50	24	1	22.00	0.936	1.18
	-----		1745.0	20300	20 MHz//QPSK	50	24	1	21.91	0.916	1.18
	-----		1720.0	20050	20 MHz/QPSK	100	0	1	21.50	0.849	1.20
	-----		1732.5	20175	20 MHz/QPSK	1	49	0	23.56	0.293	0.32
	-----	1732.5	20175	20 MHz/QPSK	50	24	1	22.00	0.238	0.30	
	-----	Repeat	1720.0	20050	20 MHz/QPSK	1	49	0	23.68	1.25	1.35

**Body**  
**1.6 W/kg (mW/g)**  
 averaged over 1 gram

1. SAR Measurement
  - Phantom Configuration  Left Head  Eli4  Right Head
  - SAR Configuration  Head  Body
2. Test Signal Call Mode  Test Code  Base Station Simulator
3. Test Configuration  With Belt Clip  Without Belt Clip  N/A
4. Tissue Depth is at least 15.0 cm

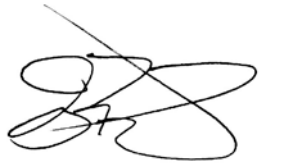

Jay M. Moulton  
 Vice President

### SAR Data Summary – 1900 MHz Body - WCDMA

## MEASUREMENT RESULTS

Gap	Plot	Frequency		Rev Level/ Modulation	Position	End Power (dBm)	RMC	Test Set Up	Measured SAR (W/kg)	Reported SAR (W/kg)
		MHz	Ch.							
0 mm	----	1880.0	9400	WCDMA	Back	23.97	12.2 kbps	Test Loop 1	0.638	0.64
	6	1852.4	9262	WCDMA	Left	23.92	12.2 kbps	Test Loop 1	1.04	1.06
	----	1880.0	9400	WCDMA		23.97	12.2 kbps	Test Loop 1	1.03	1.04
	----	1907.6	9538	WCDMA		23.95	12.2 kbps	Test Loop 1	0.935	0.95
	----	1880.0	9400	WCDMA	Top	23.97	12.2 kbps	Test Loop 1	0.211	0.21
	----	1880.0	9400	WCDMA	Repeat	23.92	12.2 kbps	Test Loop 1	1.01	1.03

**Body**  
**1.6 W/kg (mW/g)**  
 averaged over 1 gram

- SAR Measurement  
 Phantom Configuration  Left Head       Eli4       Right Head  
                                    Head             Body
- Test Signal Call Mode       Test Code       Base Station Simulator
- Test Configuration       With Belt Clip       Without Belt Clip       N/A
- Tissue Depth is at least 15.0 cm

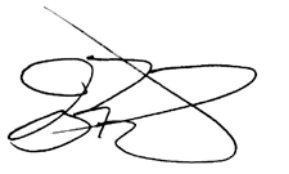

Jay M. Moulton  
 Vice President



**SAR Data Summary – 1900 MHz Body – LTE Band 2**

MEASUREMENT RESULTS											
Gap	Plot	Position	Frequency		BW/ Modulation	RB Size	RB Offset	MPR Target	End Power (dBm)	Measured SAR (W/kg)	Reported SAR (W/kg)
			MHz	Ch.							
0 mm	----	Back	1880.0	18900	20 MHz/QPSK	1	49	0	23.35	0.511	0.59
	----		1880.0	18900	20 MHz/QPSK	50	24	1	21.91	0.404	0.52
	----	Left	1860.0	18700	20 MHz/QPSK	1	49	0	23.33	0.736	0.86
	7		1880.0	18900	20 MHz/QPSK	1	49	0	23.35	0.770	0.89
	----		1900.0	19100	20 MHz/QPSK	1	49	0	23.43	0.721	0.82
	----		1880.0	18900	20 MHz/QPSK	50	24	1	21.91	0.609	0.78
	----		1880.0	18900	20 MHz/QPSK	100	0	1	21.52	0.539	0.76
	----		Top	1880.0	18900	20 MHz/QPSK	1	49	0	23.35	0.223
	----	1880.0		18900	20 MHz/QPSK	50	24	1	21.91	0.184	0.24
	----	Repeat	1880.0	18900	20 MHz/QPSK	1	49	0	23.35	0.751	0.87

**Body**  
**1.6 W/kg (mW/g)**  
 averaged over 1 gram

1. SAR Measurement  
 Phantom Configuration  Left Head  Eli4  Right Head  
 SAR Configuration  Head  Body  
 Test Signal Call Mode  Test Code  Base Station Simulator  
 Test Configuration  With Belt Clip  Without Belt Clip  N/A
4. Tissue Depth is at least 15.0 cm



\_\_\_\_\_  
 Jay M. Moulton  
 Vice President

**SAR Data Summary – 2450 MHz Body 802.11b and Bluetooth**

**MEASUREMENT RESULTS**

Gap	Plot	Position	Frequency		Modulation	Antenna	End Power	Measured SAR (W/kg)	Reported SAR (W/kg)
			MHz	Ch.			(dBm)		
0 mm	-----	Back	2437	6	DSSS	Main	20.50	0.379	0.38
	-----	Right	2437	6	DSSS		20.50	0.135	0.14
	-----	Bottom	2412	1	DSSS		20.45	0.287	0.29
	8		2437	6	DSSS		20.50	0.395	0.40
	-----		2462	11	DSSS		20.40	0.356	0.36

**Body**  
**1.6 W/kg (mW/g)**  
 averaged over 1 gram

1. SAR Measurement
  - Phantom Configuration  Left Head  Eli4  Right Head
  - SAR Configuration  Head  Body
2. Test Signal Call Mode  Test Code  Base Station Simulator
3. Test Configuration  With Belt Clip  Without Belt Clip  N/A
4. Tissue Depth is at least 15.0 cm



Jay M. Moulton  
 Vice President

### SAR Data Summary – Simultaneous Transmit (WWAN-WLAN Main)

MEASUREMENT RESULTS				
Plot	Position	SAR (W/kg) WLAN	SAR (W/kg) WWAN	Total SAR (W/kg)
-----	Left	0.40	1.38	1.78
			Body 1.6 W/kg (mW/g) averaged over 1 gram	

The WWAN and WLAN Main antennas are a minimum of 178.75 mm apart. Using the highest reported SAR to calculate the simultaneous Tx using peak separation ratio, the highest ratio would be 0.01 which meets the requirements of KDB 447498 D01 v06 section 4.3.2 3) on page 13. The calculation is shown below.

Simultaneous Separation Ratio Calculation

$$(SAR_1 + SAR_2)^{1.5}/R_i \leq 0.04 \text{ rounded to two digits}$$

$$(0.40 + 1.38)^{1.5}/178.75 = 0.01$$

### SAR Data Summary – Simultaneous Transmit (WWAN-BT Main)

MEASUREMENT RESULTS				
Plot	Position	SAR (W/kg) BT	SAR (W/kg) WWAN	Total SAR (W/kg)
-----	Left	0.10	1.38	1.48
			Body 1.6 W/kg (mW/g) averaged over 1 gram	

The BT SAR was calculated per KDB447498 D01 v06 section 4.3.2 b) 1). The formula is listed below.

$$[(\text{max. power, mW})/(\text{min. distance, mm})]^2 \cdot \sqrt{f_{(\text{GHz})}/x}], \text{ where } x=7.5 \text{ for } 1 \text{ gram SAR}$$

$$(4.7/10)^2 \cdot (\sqrt{2.48/7.5}) = 0.10$$

The sum of the two transmitters is less than the limit; therefore, the simultaneous transmission meets the requirements of KDB447498 D01 v06 section 4.3.2 page 11.

## 11. Test Equipment List

**Table 11.1 Equipment Specifications**

Type	Calibration Due Date	Calibration Done Date	Serial Number
Staubli Robot TX60L	N/A	N/A	F07/55M6A1/A/01
Measurement Controller CS8c	N/A	N/A	1012
ELI4 Flat Phantom	N/A	N/A	1065
ELI5 Flat Phantom	N/A	N/A	1251
Device Holder	N/A	N/A	N/A
Data Acquisition Electronics 4	04/13/2019	04/13/2018	1416
Data Acquisition Electronics 4	08/20/2019	08/20/2018	759
SPEAG E-Field Probe EX3DV4	04/20/2019	04/20/2018	3662
SPEAG E-Field Probe EX3DV4	08/27/2019	08/27/2018	3693
Speag Validation Dipole D750V2	08/10/2018	08/10/2015	1053
Speag Validation Dipole D835V2	08/10/2018	08/10/2015	4d131
Speag Validation Dipole D1750V2	08/13/2018	08/13/2015	1061
Speag Validation Dipole D1900V2	08/13/2018	08/13/2015	5d147
Speag Validation Dipole D2450V2	07/12/2019	07/12/2018	829
Agilent N1911A Power Meter	05/20/2019	03/20/2017	GB45100254
Agilent N1922A Power Sensor	06/21/2019	06/21/2017	MY45240464
Advantest R3261A Spectrum Analyzer	03/26/2019	03/20/2017	31720068
Agilent (HP) 8350B Signal Generator	03/26/2019	03/20/2017	2749A10226
Agilent (HP) 83525A RF Plug-In	03/26/2019	03/20/2017	2647A01172
Agilent (HP) 8753C Vector Network Analyzer	03/26/2019	03/20/2017	3135A01724
Agilent (HP) 85047A S-Parameter Test Set	03/26/2019	03/20/2017	2904A00595
Agilent (HP) 8960 Base Station Sim.	03/30/2019	03/30/2017	MY48360364
Anritsu MT8820C	07/27/2019	07/27/2017	6201176199
Aprel Dielectric Probe Assembly	N/A	N/A	0011
Body Equivalent Matter (750 MHz)	N/A	N/A	N/A
Body Equivalent Matter (835 MHz)	N/A	N/A	N/A
Body Equivalent Matter (1750 MHz)	N/A	N/A	N/A
Body Equivalent Matter (1900 MHz)	N/A	N/A	N/A
Body Equivalent Matter (2450 MHz)	N/A	N/A	N/A

## 12. Conclusion

The SAR measurement indicates that the EUT complies with the RF radiation exposure limits of the FCC/IC. These measurements are taken to simulate the RF effects exposure under worst-case conditions. Precise laboratory measures were taken to assure repeatability of the tests. The tested device complies with the requirements in respect to all parameters subject to the test. The test results and statements relate only to the item(s) tested.

Please note that the absorption and distribution of electromagnetic energy in the body is a very complex phenomena that depends on the mass, shape, and size of the body; the orientation of the body with respect to the field vectors; and, the electrical properties of both the body and the environment. Other variables that may play a substantial role in possible biological effects are those that characterize the environment (e.g. ambient temperature, air velocity, relative humidity, and body insulation) and those that characterize the individual (e.g. age, gender, activity level, debilitation, or disease). Because innumerable factors may interact to determine the specific biological outcome of an exposure to electromagnetic fields, any protection guide shall consider maximal amplification of biological effects as a result of field-body interactions, environmental conditions, and physiological variables.

### 13. References

- [1] Federal Communications Commission, ET Docket 93-62, Guidelines for Evaluating the Environmental Effects of Radio Frequency Radiation, August 1996
- [2] ANSI/IEEE C95.1 – 1992, American National Standard Safety Levels with respect to Human Exposure to Radio Frequency Electromagnetic Fields, 300kHz to 100GHz, New York: IEEE, 1992.
- [3] ANSI/IEEE C95.3 – 1992, IEEE Recommended Practice for the Measurement of Potentially Hazardous Electromagnetic Fields – RF and Microwave, New York: IEEE, 1992.
- [4] International Electrotechnical Commission, IEC 62209-2 (Edition 1.0), Human Exposure to radio frequency fields from hand-held and body mounted wireless communication devices – Human models, instrumentation, and procedures – Part 2: Procedure to determine the specific absorption rate (SAR) for wireless communication devices used in close proximity to the human body (frequency range of 30 MHz to 6 GHz), March 2010.
- [5] IEEE Standard 1528 – 2013, IEEE Recommended Practice for Determining the Peak-Spatial Average Specific Absorption Rate (SAR) in the Human Head from Wireless Communication Devices: Measurement Techniques, June 2013.
- [6] Industry Canada, RSS – 102 Issue 5, Radio Frequency Exposure Compliance of Radiocommunication Apparatus (All Frequency Bands), March 2015.
- [7] Health Canada, Safety Code 6, Limits of Human Exposure to Radiofrequency Electromagnetic Fields in the Frequency Range from 3kHz to 300 GHz, 2009.

## Appendix A – System Validation Plots and Data

\*\*\*\*\*

Test Result for UIM Dielectric Parameter

Thu 28/Jun/2018

Freq Frequency(GHz)

FCC\_eH Limits for Head Epsilon

FCC\_sH Limits for Head Sigma

FCC\_eB Limits for Body Epsilon

FCC\_sB Limits for Body Sigma

Test\_e Epsilon of UIM

Test\_s Sigma of UIM

\*\*\*\*\*

Freq	FCC_eB	FCC_sB	Test_e	Test_s
0.7000	55.73	0.96	55.72	0.97
0.7040	55.714	0.96	55.708	0.974*
0.7075	55.70	0.96	55.698	0.978*
0.7100	55.69	0.96	55.69	0.98
0.7110	55.686	0.96	55.687	0.98*
0.7200	55.65	0.96	55.66	0.98
0.7300	55.61	0.96	55.63	0.98
0.7400	55.57	0.96	55.60	0.99
0.7500	55.53	0.96	55.57	0.99
0.7600	55.49	0.96	55.54	0.99
0.7700	55.45	0.96	55.50	1.00
0.7800	55.41	0.97	55.46	1.00
0.7900	55.38	0.97	55.42	1.00
0.8000	55.34	0.97	55.38	1.01

\* value interpolated

\*\*\*\*\*

Test Result for UIM Dielectric Parameter

Thu 28/Jun/2018

Freq Frequency(GHz)

FCC\_eH Limits for Head Epsilon

FCC\_sH Limits for Head Sigma

FCC\_eB Limits for Body Epsilon

FCC\_sB Limits for Body Sigma

Test\_e Epsilon of UIM

Test\_s Sigma of UIM

\*\*\*\*\*

Freq	FCC_eB	FCC_sB	Test_e	Test_s
0.8050	55.32	0.97	56.05	0.96
0.8150	55.28	0.97	56.00	0.98
0.8250	55.24	0.97	55.95	0.98
0.8264	55.234	0.97	55.944	0.981*
0.8290	55.224	0.97	55.934	0.984*
0.8350	55.20	0.97	55.91	0.99
0.8365	55.196	0.972	55.905	0.991*
0.8366	55.195	0.972	55.902	0.99*
0.8440	55.173	0.979	55.879	0.995*
0.8466	55.165	0.982	55.857	0.992*
0.8550	55.14	0.99	55.84	1.00
0.8650	55.11	1.01	55.80	1.01
0.8750	55.08	1.02	55.78	1.03
0.8850	55.05	1.03	55.73	1.03
0.8950	55.02	1.04	55.70	1.04

\* value interpolated

\*\*\*\*\*

Test Result for UIM Dielectric Parameter

Tue 26/Jun/2018

Freq Frequency(GHz)

FCC\_eH Limits for Head Epsilon

FCC\_sH Limits for Head Sigma

FCC\_eB Limits for Body Epsilon

FCC\_sB Limits for Body Sigma

Test\_e Epsilon of UIM

Test\_s Sigma of UIM

\*\*\*\*\*

Freq	FCC_eB	FCC_sB	Test_e	Test_s
1.7100	53.53	1.47	53.55	1.48
1.7124	53.525	1.47	53.543	1.482*
1.7200	53.51	1.47	53.52	1.49
1.7300	53.48	1.48	53.38	1.50
1.7325	53.475	1.48	53.375	1.503*
1.7326	53.475	1.48	53.375	1.503*
1.7400	53.46	1.48	53.36	1.51
1.7450	53.445	1.485	53.34	1.515*
1.7500	53.43	1.49	53.32	1.52
1.7526	53.425	1.49	53.315	1.523*
1.7600	53.41	1.49	53.30	1.53
1.7700	53.38	1.50	53.27	1.55
1.7800	53.35	1.51	53.23	1.55

\* value interpolated

\*\*\*\*\*

Test Result for UIM Dielectric Parameter

Wed 27/Jun/2018

Freq Frequency(GHz)

FCC\_eH Limits for Head Epsilon

FCC\_sH Limits for Head Sigma

FCC\_eB Limits for Body Epsilon

FCC\_sB Limits for Body Sigma

Test\_e Epsilon of UIM

Test\_s Sigma of UIM

\*\*\*\*\*

Freq	FCC_eB	FCC_sB	Test_e	Test_s
1.8400	53.30	1.52	52.04	1.43
1.8500	53.30	1.52	52.03	1.44
1.8524	53.30	1.52	52.03	1.44*
1.8600	53.30	1.52	52.03	1.44
1.8700	53.30	1.52	52.14	1.45
1.8800	53.30	1.52	52.10	1.45
1.8900	53.30	1.52	52.17	1.46
1.9000	53.30	1.52	52.07	1.47
1.9076	53.30	1.52	52.108	1.493*
1.9100	53.30	1.52	52.12	1.50
1.9200	53.30	1.52	52.00	1.50

\* value interpolated



\*\*\*\*\*

Test Result for UIM Dielectric Parameter

Wed 10/Oct/2018

Freq Frequency(GHz)

FCC\_eH Limits for Head Epsilon

FCC\_sH Limits for Head Sigma

FCC\_eB Limits for Body Epsilon

FCC\_sB Limits for Body Sigma

Test\_e Epsilon of UIM

Test\_s Sigma of UIM

\*\*\*\*\*

Freq	FCC_eB	FCC_sB	Test_e	Test_s
2.4100	52.75	1.91	52.71	1.92
2.4120	52.742	1.918	52.706	1.922*
2.4200	52.74	1.92	52.69	1.93
2.4300	52.73	1.93	52.68	1.94
2.4370	52.716	1.937	52.666	1.947*
2.4400	52.71	1.94	52.66	1.95
2.4500	52.70	1.95	52.64	1.96
2.4600	52.69	1.96	52.63	1.98
2.4620	52.687	1.963	52.626	1.982*
2.4700	52.67	1.98	52.61	1.99
2.4800	52.66	1.99	52.60	2.00

\* value interpolated

# RF Exposure Lab

## Plot 1

**DUT: Dipole 750 MHz D750V3; Type: D750V3; Serial: D750V3 - SN:1053**

Communication System: CW; Frequency: 750 MHz; Duty Cycle: 1:1  
Medium: MSL750; Medium parameters used:  $f = 750 \text{ MHz}$ ;  $\sigma = 0.99 \text{ S/m}$ ;  $\epsilon_r = 55.57$ ;  $\rho = 1000 \text{ kg/m}^3$   
Phantom section: Flat Section

Test Date: Date: 6/28/2018; Ambient Temp: 23 °C; Tissue Temp: 21 °C

Probe: EX3DV4 - SN3662; ConvF(9.62, 9.62, 9.62); Calibrated: 4/20/2018;  
Sensor-Surface: 2mm (Mechanical Surface Detection)  
Electronics: DAE4 Sn1416; Calibrated: 4/13/2018  
Phantom: ELI v4.0; Type: QDOVA001BB; Serial: 1065  
Measurement SW: DASY52, Version 52.10 (0); SEMCAD X Version 14.6.10 (7417)

### Procedure Notes:

**750 MHz/Verification/Area Scan (5x11x1):** Measurement grid: dx=15mm, dy=15mm  
Maximum value of SAR (measured) = 1.08 W/kg

**750 MHz/Verification/Zoom Scan (5x5x7)/Cube 0:** Measurement grid: dx=8mm, dy=8mm, dz=5mm  
Reference Value = 31.227 V/m; Power Drift = 0.02 dB  
Peak SAR (extrapolated) = 1.30 W/kg  
**SAR(1 g) = 0.865 W/kg; SAR(10 g) = 0.569 W/kg**  
Maximum value of SAR (measured) = 1.10 W/kg

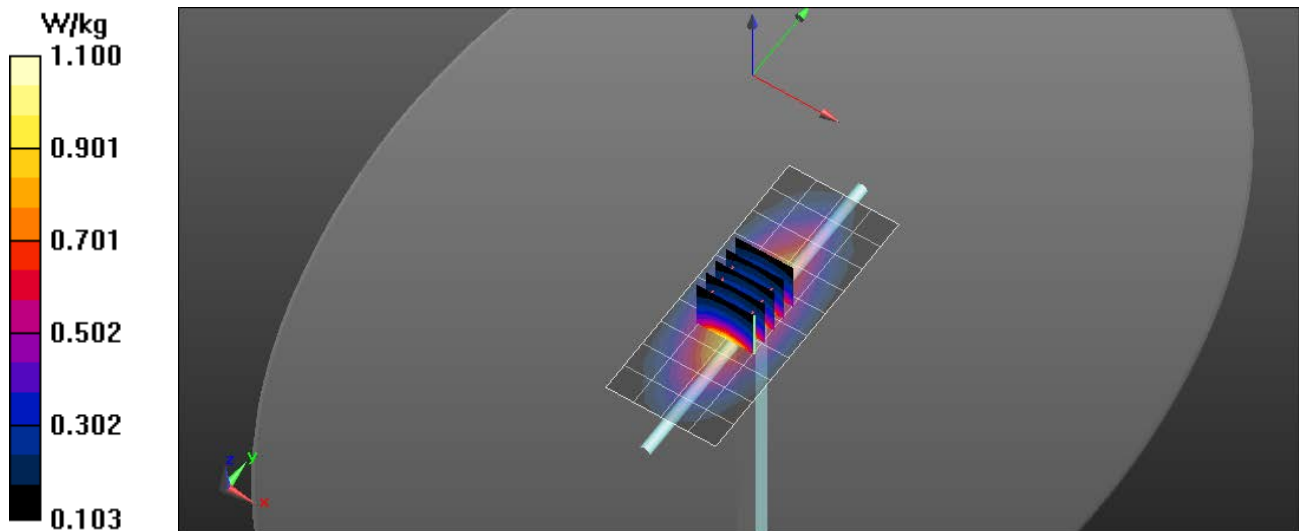

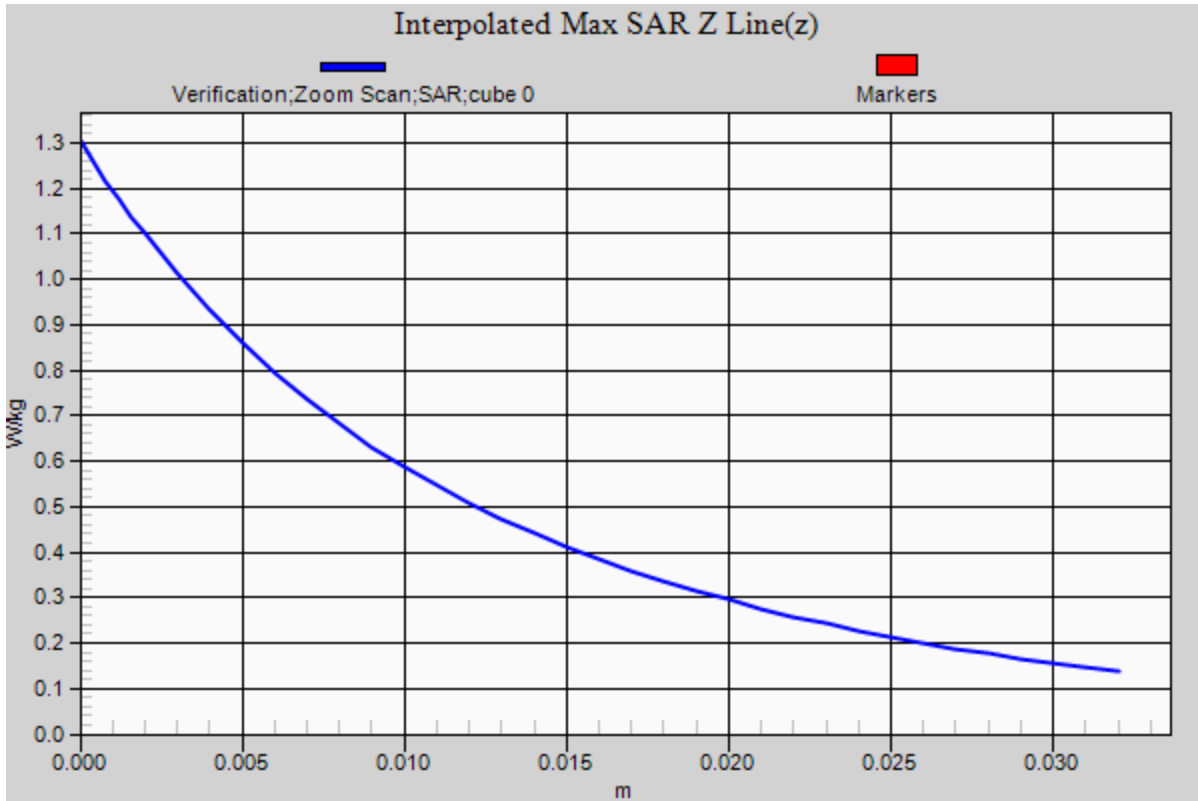

# RF Exposure Lab

## Plot 2

**DUT: Dipole 835 MHz D835V2; Type: D835V2; Serial: D835V2 - SN:4d131**

Communication System: CW; Frequency: 835 MHz; Duty Cycle: 1:1  
Medium: MSL835; Medium parameters used:  $f = 835 \text{ MHz}$ ;  $\sigma = 0.99 \text{ S/m}$ ;  $\epsilon_r = 55.91$ ;  $\rho = 1000 \text{ kg/m}^3$   
Phantom section: Flat Section

Test Date: Date: 6/28/2018; Ambient Temp: 23 °C; Tissue Temp: 21 °C  
Probe: EX3DV4 - SN3662; ConvF(9.21, 9.21, 9.21); Calibrated: 4/20/2018;  
Sensor-Surface: 2mm (Mechanical Surface Detection)  
Electronics: DAE4 Sn1416; Calibrated: 4/13/2018  
Phantom: ELI v4.0; Type: QDOVA001BB; Serial: 1065  
Measurement SW: DASY52, Version 52.10 (0); SEMCAD X Version 14.6.10 (7417)

### Procedure Notes:

**835 MHz Body/Verification/Area Scan (81x161x1):** Interpolated grid:  $dx=1.000 \text{ mm}$ ,  $dy=1.000 \text{ mm}$   
Maximum value of SAR (interpolated) = 1.29 W/kg

**835 MHz Body/Verification/Zoom Scan (5x5x7)/Cube 0:** Measurement grid:  $dx=8\text{mm}$ ,  $dy=8\text{mm}$ ,  $dz=5\text{mm}$   
Reference Value = 52.612 V/m; Power Drift = -0.02 dB  
Peak SAR (extrapolated) = 1.47 W/kg  
**SAR(1 g) = 0.953 W/kg; SAR(10 g) = 0.632 W/kg**  
Maximum value of SAR (measured) = 1.29 W/kg

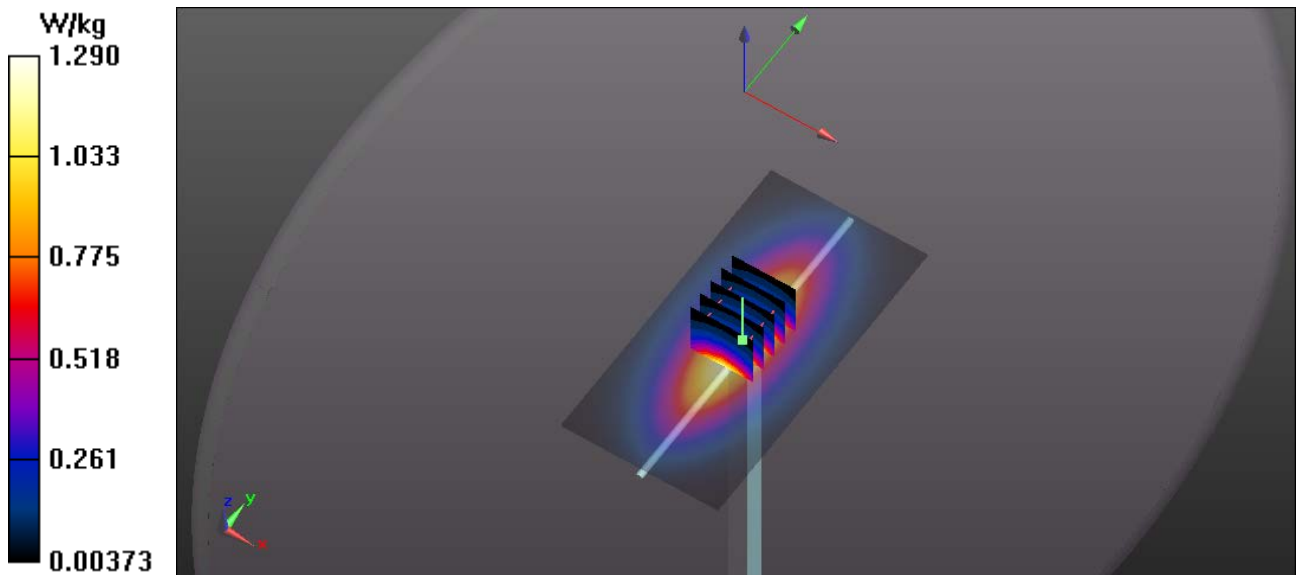

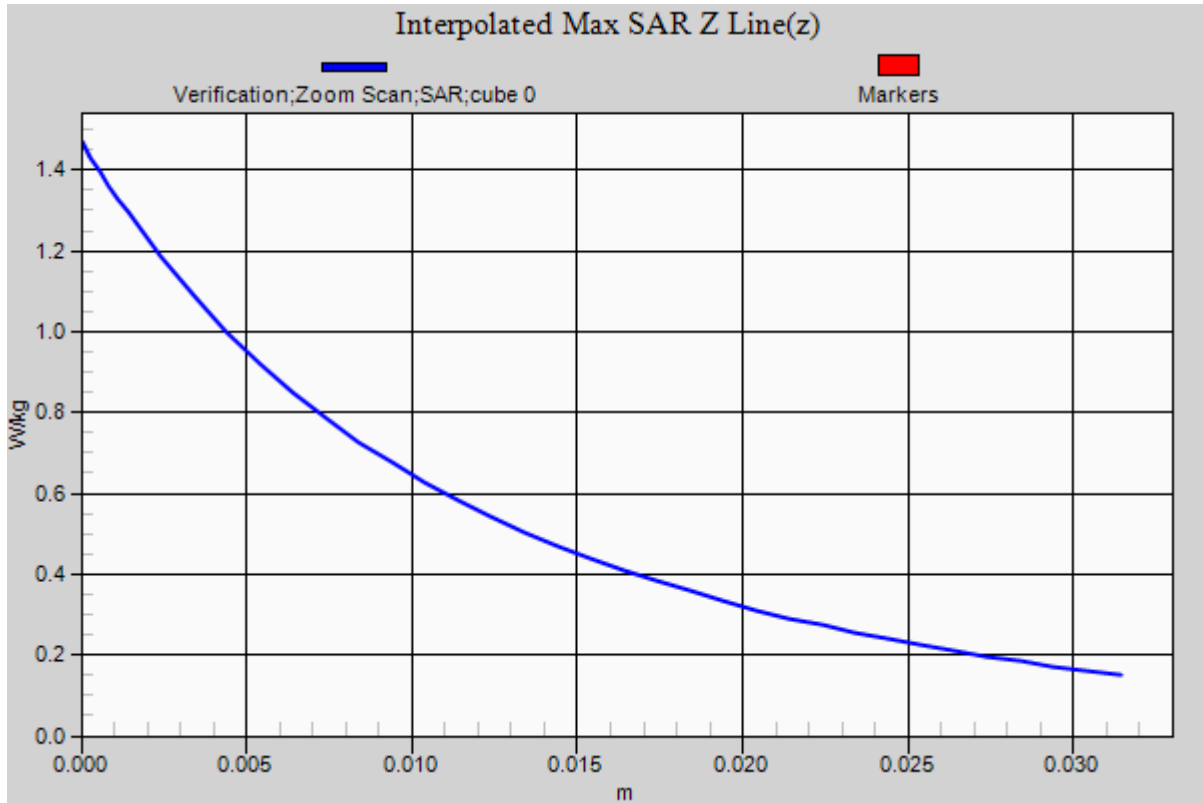

# RF Exposure Lab

## Plot 3

**DUT: Dipole 1750 MHz D1750V2; Type: D1750V2; Serial: D1750V2 - SN:1061**

Communication System: CW; Frequency: 1750 MHz; Duty Cycle: 1:1  
Medium: MSL1750; Medium parameters used:  $f = 1750$  MHz;  $\sigma = 1.52$  S/m;  $\epsilon_r = 53.32$ ;  $\rho = 1000$  kg/m<sup>3</sup>  
Phantom section: Flat Section

Test Date: Date: 6/26/2018; Ambient Temp: 23 °C; Tissue Temp: 21 °C

Probe: EX3DV4 - SN3662; ConvF(7.96, 7.96, 7.96); Calibrated: 4/20/2018;  
Sensor-Surface: 2mm (Mechanical Surface Detection)  
Electronics: DAE4 Sn1416; Calibrated: 4/13/2018  
Phantom: ELI v4.0; Type: QDOVA001BB; Serial: 1065  
Measurement SW: DASY52, Version 52.10 (0); SEMCAD X Version 14.6.10 (7417)

### Procedure Notes:

**1750 MHz/Verification/Area Scan (5x7x1):** Measurement grid: dx=15mm, dy=15mm  
Maximum value of SAR (measured) = 5.33 W/kg

**1750 MHz/Verification/Zoom Scan (5x5x7)/Cube 0:** Measurement grid: dx=8mm, dy=8mm, dz=5mm  
Reference Value = 31.227 V/m; Power Drift = -0.01 dB  
Peak SAR (extrapolated) = 6.89 W/kg  
**SAR(1 g) = 3.85 W/kg; SAR(10 g) = 2.03 W/kg**  
Maximum value of SAR (measured) = 5.49 W/kg

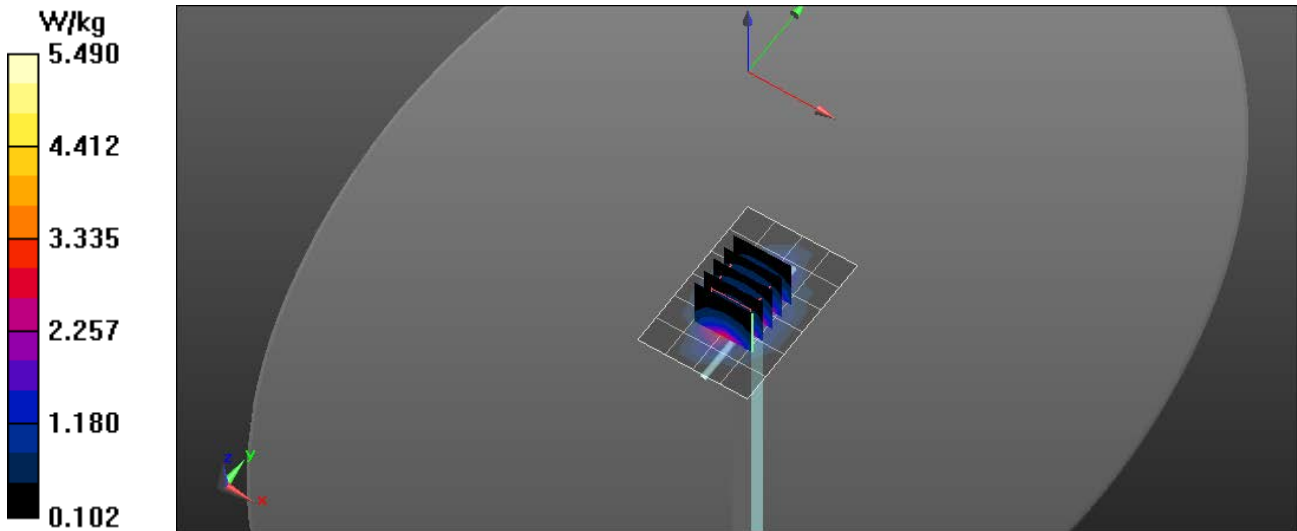

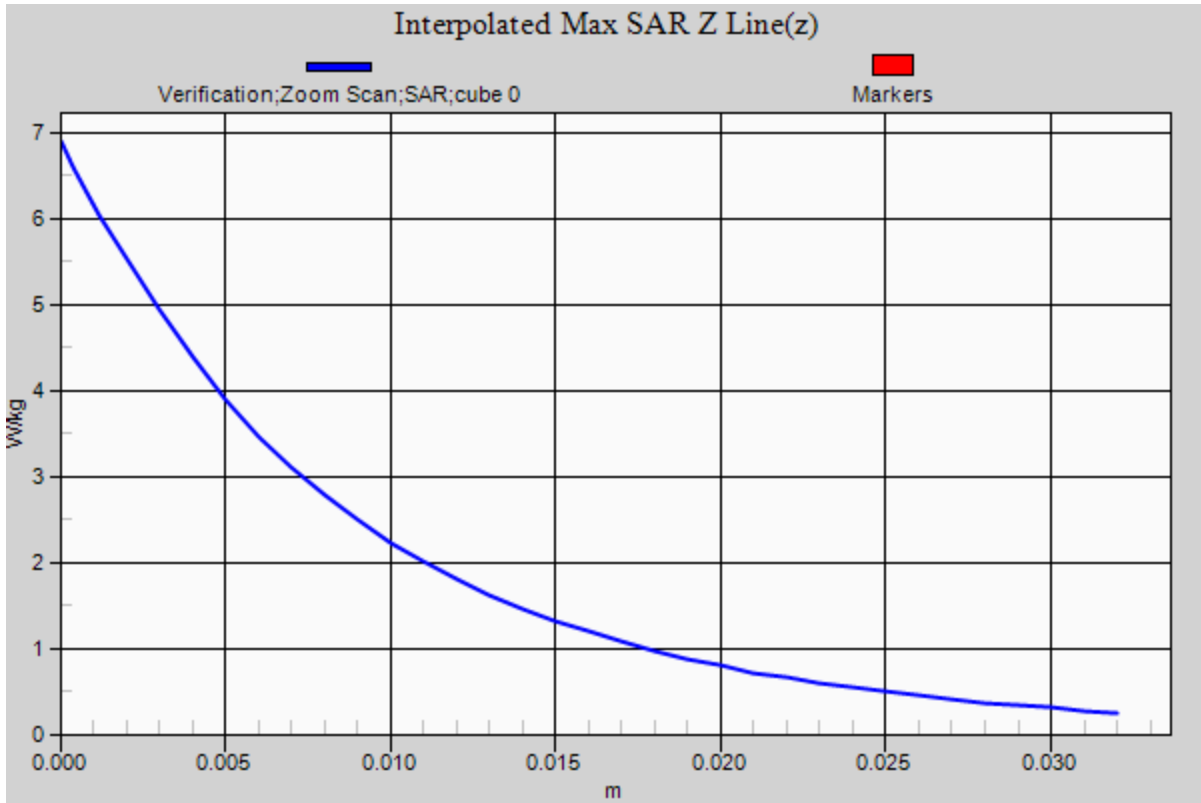

# RF Exposure Lab

## Plot 4

**DUT: Dipole 1900 MHz D1900V2; Type: D1900V2; Serial: D1900V2 - SN:5d147**

Communication System: CW; Frequency: 1900 MHz; Duty Cycle: 1:1  
Medium: MSL1900; Medium parameters used:  $f = 1900$  MHz;  $\sigma = 1.47$  S/m;  $\epsilon_r = 52.07$ ;  $\rho = 1000$  kg/m<sup>3</sup>  
Phantom section: Flat Section

Test Date: Date: 6/27/2018; Ambient Temp: 23 °C; Tissue Temp: 21 °C  
Probe: EX3DV4 - SN3662; ConvF(7.61, 7.61, 7.61); Calibrated: 4/20/2018;  
Sensor-Surface: 2mm (Mechanical Surface Detection)  
Electronics: DAE4 Sn1416; Calibrated: 4/13/2018  
Phantom: ELI v4.0; Type: QDOVA001BB; Serial: 1065  
Measurement SW: DASY52, Version 52.10 (0); SEMCAD X Version 14.6.10 (7417)

### Procedure Notes:

**1900 MHz Body/Verification/Area Scan (61x81x1):** Interpolated grid: dx=1.000 mm, dy=1.000 mm  
Maximum value of SAR (interpolated) = 5.63 W/kg

**1900 MHz Body/Verification/Zoom Scan (7x7x7)/Cube 0:** Measurement grid: dx=5mm, dy=5mm, dz=5mm  
Reference Value = 52.612 V/m; Power Drift = -0.02 dB  
Peak SAR (extrapolated) = 6.68 W/kg  
**SAR(1 g) = 3.98 W/kg; SAR(10 g) = 1.92 W/kg**  
Maximum value of SAR (measured) = 5.63 W/kg

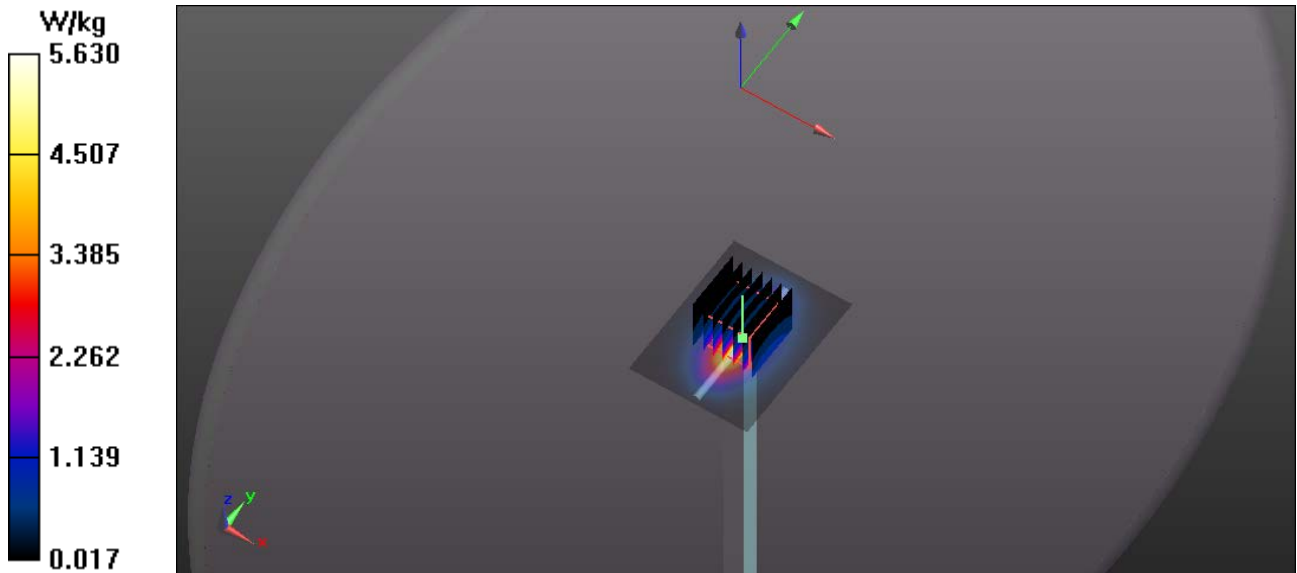



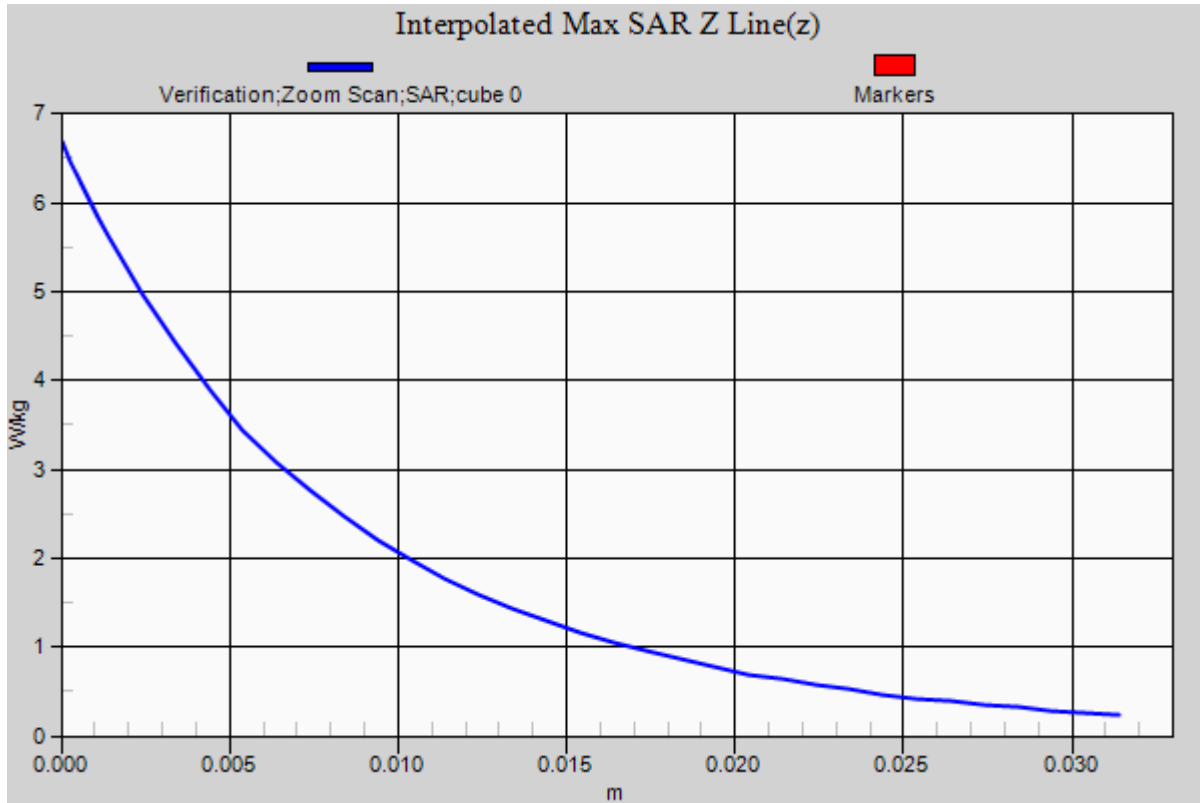

# RF Exposure Lab

## Plot 5

**DUT: Dipole 2450 MHz D2450V2; Type: D2450V2; Serial: D2450V2 - SN:881**

Communication System: CW; Frequency: 2450 MHz; Duty Cycle: 1:1  
 Medium: MSL2450; Medium parameters used:  $f = 2450$  MHz;  $\sigma = 1.96$  S/m;  $\epsilon_r = 52.64$ ;  $\rho = 1000$  kg/m<sup>3</sup>  
 Phantom section: Flat Section

Test Date: Date: 10/10/2018; Ambient Temp: 23 °C; Tissue Temp: 21 °C

Probe: EX3DV4 - SN3693; ConvF(7.29, 7.29, 7.29); Calibrated: 8/27/2018;  
 Sensor-Surface: 2mm (Mechanical Surface Detection)  
 Electronics: DAE4 Sn759; Calibrated: 8/10/2018  
 Phantom: ELI v5.0; Type: QDOVA002AA; Serial: 1251  
 Measurement SW: DASY52, Version 52.10 (0); SEMCAD X Version 14.6.10 (7417)

### Procedure Notes:

**2450 MHz Body/Verification/Area Scan (61x81x1):** Interpolated grid: dx=1.000 mm, dy=1.000 mm  
 Maximum value of SAR (interpolated) = 8.68 W/kg

**2450 MHz Body/Verification/Zoom Scan (7x7x7)/Cube 0:** Measurement grid: dx=5mm, dy=5mm, dz=5mm  
 Reference Value = 55.751 V/m; Power Drift = -0.01 dB  
 Peak SAR (extrapolated) = 10.7 W/kg  
**SAR(1 g) = 5.2 W/kg; SAR(10 g) = 2.4 W/kg**  
 Maximum value of SAR (measured) = 5.91 W/kg

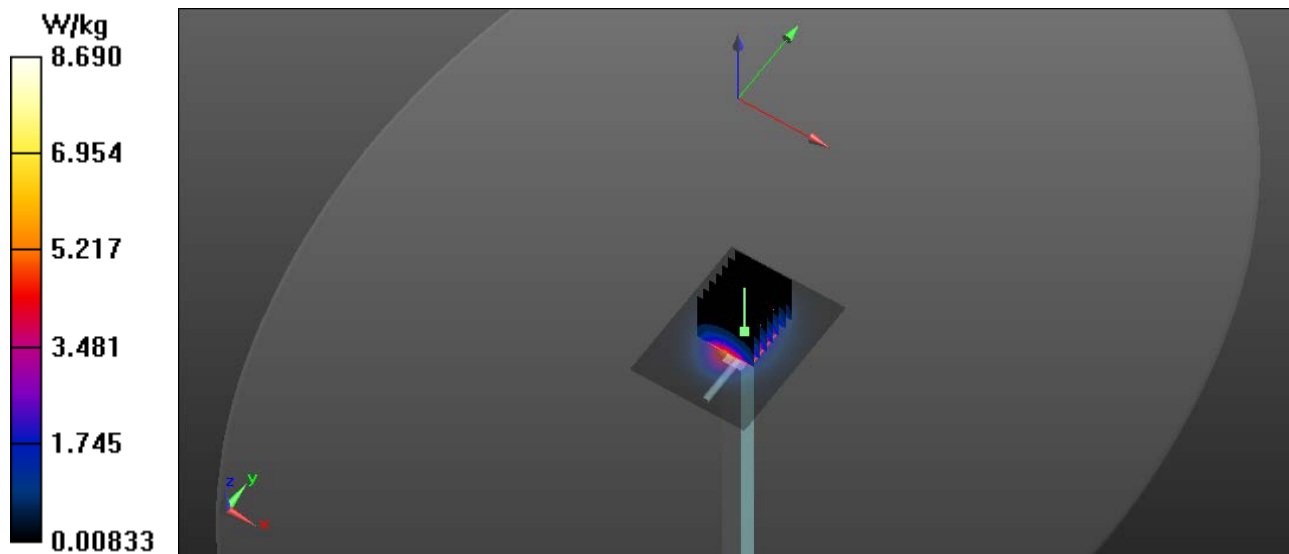

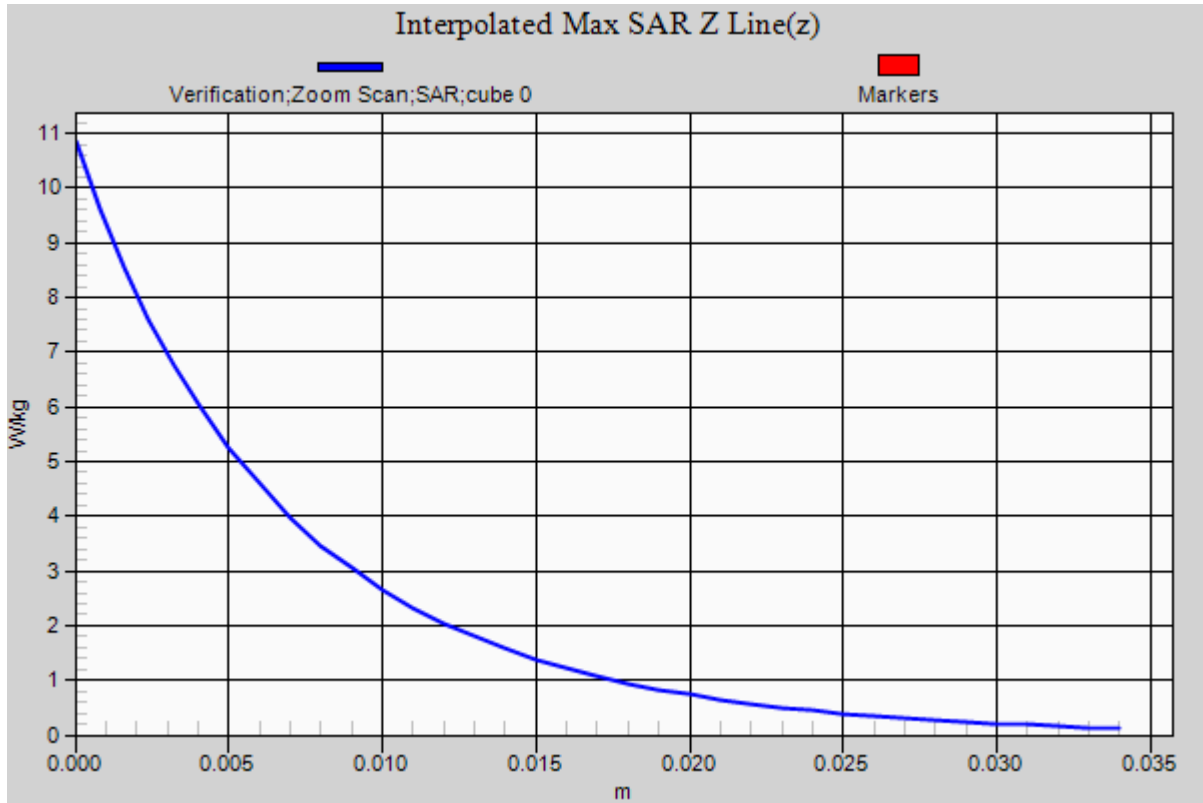

## **Appendix B – SAR Test Data Plots**

# RF Exposure Lab

## Plot 1

**DUT: AG3; Type: Handheld Computer; Serial: AG3102**

Communication System: LTE (SC-FDMA, 1 RB, 10 MHz, QPSK); Frequency: 707.5 MHz; Duty Cycle: 1:1  
 Medium: MSL750; Medium parameters used (interpolated):  $f = 707.5$  MHz;  $\sigma = 0.978$  S/m;  $\epsilon_r = 55.698$ ;  $\rho = 1000$  kg/m<sup>3</sup>  
 Phantom section: Flat Section

Test Date: Date: 6/28/2018; Ambient Temp: 23 °C; Tissue Temp: 21 °C

Probe: EX3DV4 - SN3662; ConvF(9.8, 9.8, 9.8); Calibrated: 4/20/2018;  
 Sensor-Surface: 2mm (Mechanical Surface Detection)  
 Electronics: DAE4 Sn1416; Calibrated: 4/13/2018  
 Phantom: ELI v4.0; Type: QDOVA001BB; Serial: 1065  
 Measurement SW: DASY52, Version 52.10 (0); SEMCAD X Version 14.6.10 (7417)

### Procedure Notes:

**Band 12 LTE/Left 1 RB Mid/Area Scan (7x11x1):** Measurement grid: dx=15mm, dy=15mm

[Info: Interpolated medium parameters used for SAR evaluation.](#)

Maximum value of SAR (measured) = 0.670 W/kg

**Band 12 LTE/Left 1 RB Mid/Zoom Scan (5x5x7)/Cube 0:** Measurement grid: dx=8mm, dy=8mm, dz=5mm

Reference Value = 10.32 V/m; Power Drift = 0.01 dB

Peak SAR (extrapolated) = 1.06 W/kg

**SAR(1 g) = 0.616 W/kg; SAR(10 g) = 0.353 W/kg**

[Info: Interpolated medium parameters used for SAR evaluation.](#)

Maximum value of SAR (measured) = 0.841 W/kg

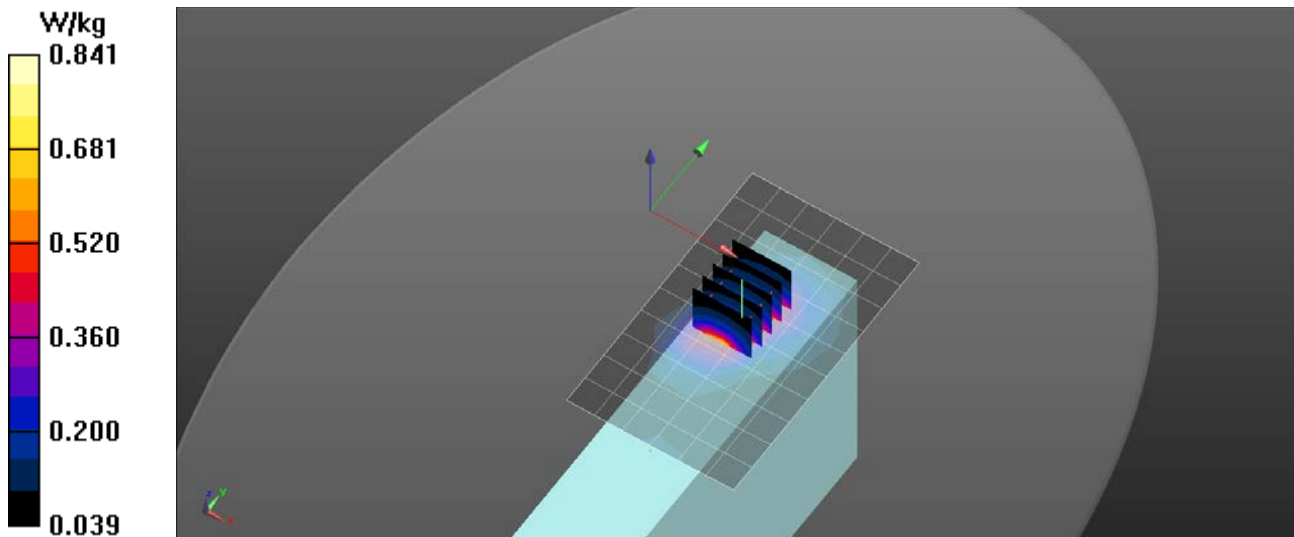

# RF Exposure Lab

## Plot 2

**DUT: AG3; Type: Handheld Computer; Serial: AG3102**

Communication System: UMTS (WCDMA); Frequency: 836.6 MHz; Duty Cycle: 1:1  
Medium: MSL835; Medium parameters used (interpolated):  $f = 836.6$  MHz;  $\sigma = 0.99$  S/m;  $\epsilon_r = 55.902$ ;  $\rho = 1000$  kg/m<sup>3</sup>  
Phantom section: Flat Section

Test Date: Date: 6/28/2018; Ambient Temp: 23 °C; Tissue Temp: 21 °C

Probe: EX3DV4 - SN3662; ConvF(9.21, 9.21, 9.21); Calibrated: 4/20/2018;  
Sensor-Surface: 2mm (Mechanical Surface Detection)  
Electronics: DAE4 Sn1416; Calibrated: 4/13/2018  
Phantom: ELI v4.0; Type: QDOVA001BB; Serial: 1065  
Measurement SW: DASY52, Version 52.10 (0); SEMCAD X Version 14.6.10 (7417)

### Procedure Notes:

**Band 5 UMTS/Left Mid/Area Scan (7x11x1):** Measurement grid: dx=15mm, dy=15mm

[Info: Interpolated medium parameters used for SAR evaluation.](#)

Maximum value of SAR (measured) = 0.741 W/kg

**Band 5 UMTS/Left Mid/Zoom Scan (5x5x7)/Cube 0:** Measurement grid: dx=8mm, dy=8mm, dz=5mm

Reference Value = 6.756 V/m; Power Drift = 0.00 dB

Peak SAR (extrapolated) = 1.05 W/kg

**SAR(1 g) = 0.572 W/kg; SAR(10 g) = 0.306 W/kg**

[Info: Interpolated medium parameters used for SAR evaluation.](#)

Maximum value of SAR (measured) = 0.832 W/kg

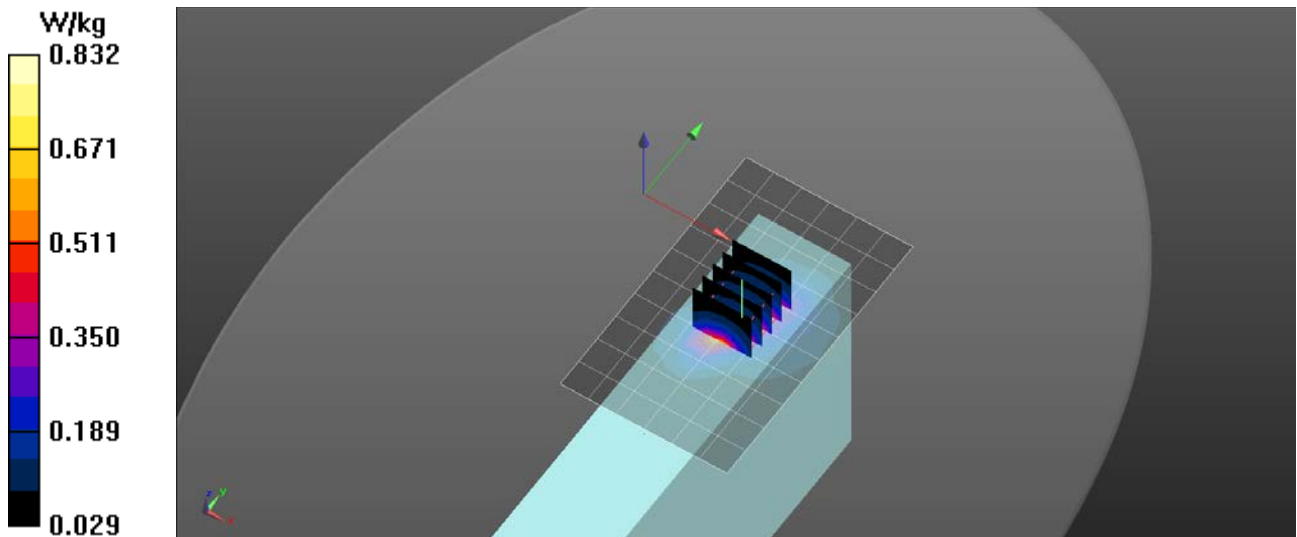

# RF Exposure Lab

## Plot 3

**DUT: AG3; Type: Handheld Computer; Serial: AG3102**

Communication System: LTE (SC-FDMA, 1 RB, 10 MHz, QPSK); Frequency: 836.5 MHz; Duty Cycle: 1:1  
Medium: MSL835; Medium parameters used (interpolated):  $f = 836.5$  MHz;  $\sigma = 0.991$  S/m;  $\epsilon_r = 55.905$ ;  $\rho = 1000$  kg/m<sup>3</sup>  
Phantom section: Flat Section

Test Date: Date: 6/28/2018; Ambient Temp: 23 °C; Tissue Temp: 21 °C

Probe: EX3DV4 - SN3662; ConvF(9.21, 9.21, 9.21); Calibrated: 4/20/2018;  
Sensor-Surface: 2mm (Mechanical Surface Detection)  
Electronics: DAE4 Sn1416; Calibrated: 4/13/2018  
Phantom: ELI v4.0; Type: QDOVA001BB; Serial: 1065  
Measurement SW: DASY52, Version 52.10 (0); SEMCAD X Version 14.6.10 (7417)

### Procedure Notes:

**Band 5 LTE/Left 1 RB Mid/Area Scan (7x11x1):** Measurement grid: dx=15mm, dy=15mm

[Info: Interpolated medium parameters used for SAR evaluation.](#)

Maximum value of SAR (measured) = 0.708 W/kg

**Band 5 LTE/Left 1 RB Mid/Zoom Scan (5x5x7)/Cube 0:** Measurement grid: dx=8mm, dy=8mm, dz=5mm

Reference Value = 7.001 V/m; Power Drift = 0.03 dB

Peak SAR (extrapolated) = 0.922 W/kg

**SAR(1 g) = 0.510 W/kg; SAR(10 g) = 0.275 W/kg**

[Info: Interpolated medium parameters used for SAR evaluation.](#)

Maximum value of SAR (measured) = 0.741 W/kg

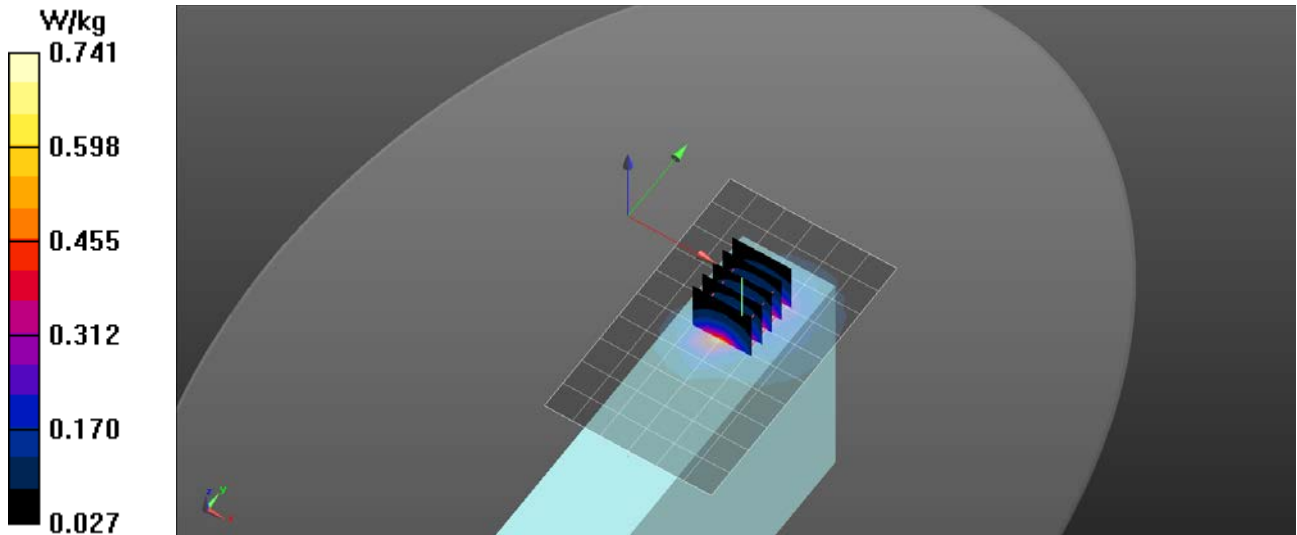

# RF Exposure Lab

## Plot 4

**DUT: AG3; Type: Handheld Computer; Serial: AG3102**

Communication System: UMTS (WCDMA); Frequency: 1712.4 MHz; Duty Cycle: 1:1  
Medium: MSL1750; Medium parameters used (interpolated):  $f = 1712.4$  MHz;  $\sigma = 1.482$  S/m;  $\epsilon_r = 53.543$ ;  $\rho = 1000$  kg/m<sup>3</sup>  
Phantom section: Flat Section

Test Date: Date: 6/27/2018; Ambient Temp: 23 °C; Tissue Temp: 21 °C

Probe: EX3DV4 - SN3662; ConvF(7.96, 7.96, 7.96); Calibrated: 4/20/2018;  
Sensor-Surface: 2mm (Mechanical Surface Detection)  
Electronics: DAE4 Sn1416; Calibrated: 4/13/2018  
Phantom: ELI v4.0; Type: QDOVA001BB; Serial: 1065  
Measurement SW: DASY52, Version 52.10 (0); SEMCAD X Version 14.6.10 (7417)

### Procedure Notes:

**Band 4 UMTS/Left Low/Area Scan (7x11x1):** Measurement grid: dx=15mm, dy=15mm

[Info: Interpolated medium parameters used for SAR evaluation.](#)

Maximum value of SAR (measured) = 1.62 W/kg

**Band 4 UMTS/Left Low/Zoom Scan (5x5x7)/Cube 0:** Measurement grid: dx=8mm, dy=8mm, dz=5mm

Reference Value = 5.227 V/m; Power Drift = -0.02 dB

Peak SAR (extrapolated) = 2.19 W/kg

**SAR(1 g) = 1.24 W/kg; SAR(10 g) = 0.680 W/kg**

[Info: Interpolated medium parameters used for SAR evaluation.](#)

Maximum value of SAR (measured) = 1.70 W/kg

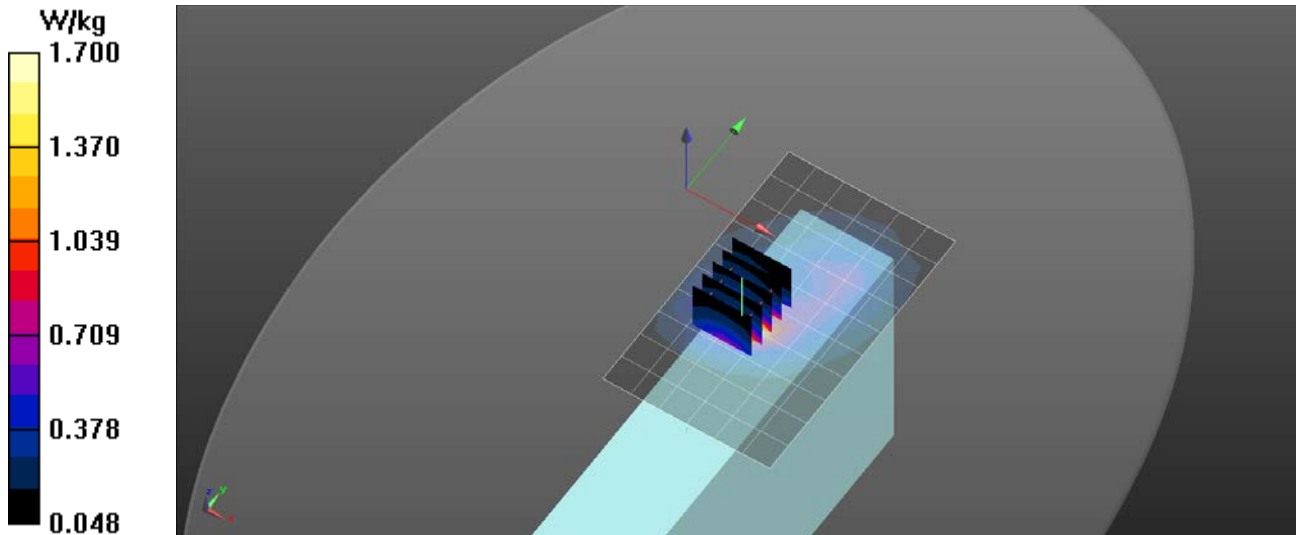



# RF Exposure Lab

## Plot 5

**DUT: AG3; Type: Handheld Computer; Serial: AG3102**

Communication System: LTE (SC-FDMA, 1 RB, 20 MHz, QPSK); Frequency: 1720 MHz; Duty Cycle: 1:1  
Medium: MSL1750; Medium parameters used:  $f = 1720$  MHz;  $\sigma = 1.49$  S/m;  $\epsilon_r = 53.52$ ;  $\rho = 1000$  kg/m<sup>3</sup>  
Phantom section: Flat Section

Test Date: Date: 6/26/2018; Ambient Temp: 23 °C; Tissue Temp: 21 °C

Probe: EX3DV4 - SN3662; ConvF(7.96, 7.96, 7.96); Calibrated: 4/20/2018;  
Sensor-Surface: 2mm (Mechanical Surface Detection)  
Electronics: DAE4 Sn1416; Calibrated: 4/13/2018  
Phantom: ELI v4.0; Type: QDOVA001BB; Serial: 1065  
Measurement SW: DASY52, Version 52.10 (0); SEMCAD X Version 14.6.10 (7417)

### Procedure Notes:

**Band 4 LTE/Left 1 RB Low/Area Scan (7x11x1):** Measurement grid: dx=15mm, dy=15mm  
Maximum value of SAR (measured) = 1.79 W/kg

**Band 4 LTE/Left 1 RB Low/Zoom Scan (5x5x7)/Cube 0:** Measurement grid: dx=8mm, dy=8mm, dz=5mm  
Reference Value = 4.343 V/m; Power Drift = -0.02 dB  
Peak SAR (extrapolated) = 2.31 W/kg  
**SAR(1 g) = 1.28 W/kg; SAR(10 g) = 0.687 W/kg**  
Maximum value of SAR (measured) = 1.84 W/kg

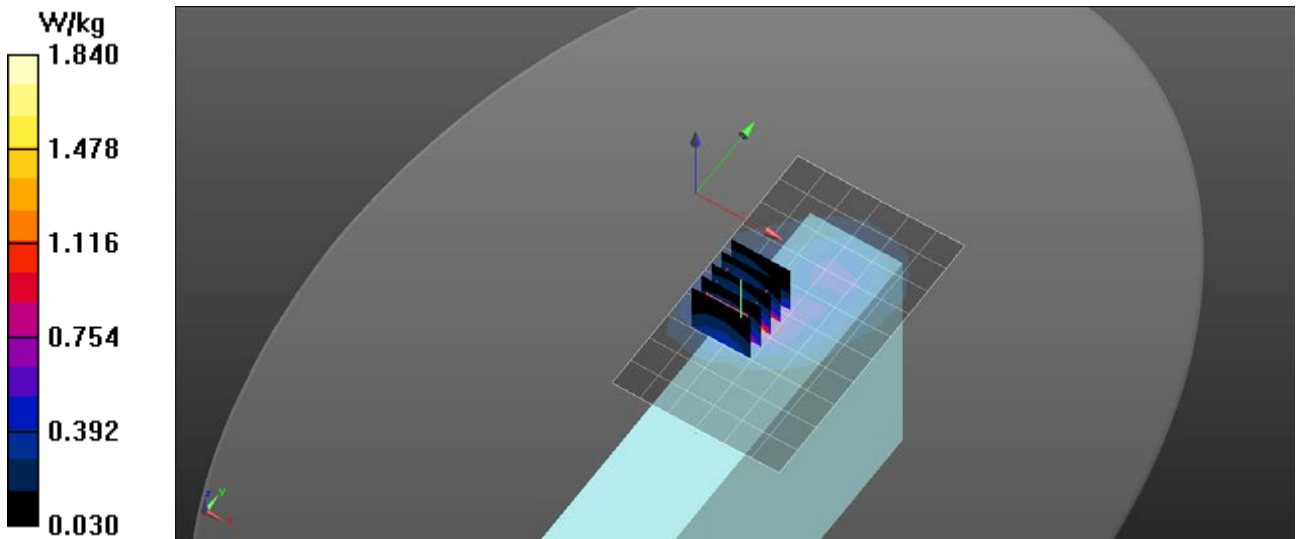

# RF Exposure Lab

## Plot 6

**DUT: AG3; Type: Handheld Computer; Serial: AG3102**

Communication System: UMTS (WCDMA); Frequency: 1852.4 MHz; Duty Cycle: 1:1  
 Medium: MSL1900; Medium parameters used (interpolated):  $f = 1852.4$  MHz;  $\sigma = 1.44$  S/m;  $\epsilon_r = 52.03$ ;  $\rho = 1000$  kg/m<sup>3</sup>  
 Phantom section: Flat Section

Test Date: Date: 6/27/2018; Ambient Temp: 23 °C; Tissue Temp: 21 °C

Probe: EX3DV4 - SN3662; ConvF(7.61, 7.61, 7.61); Calibrated: 4/20/2018;  
 Sensor-Surface: 2mm (Mechanical Surface Detection)  
 Electronics: DAE4 Sn1416; Calibrated: 4/13/2018  
 Phantom: ELI v4.0; Type: QDOVA001BB; Serial: 1065  
 Measurement SW: DASY52, Version 52.10 (0); SEMCAD X Version 14.6.10 (7417)

### Procedure Notes:

**Band 2 UMTS/Left Low/Area Scan (7x11x1):** Measurement grid: dx=15mm, dy=15mm

[Info: Interpolated medium parameters used for SAR evaluation.](#)

Maximum value of SAR (measured) = 1.34 W/kg

**Band 2 UMTS/Left Low/Zoom Scan (5x5x7)/Cube 0:** Measurement grid: dx=8mm, dy=8mm, dz=5mm

Reference Value = 4.805 V/m; Power Drift = 0.02 dB

Peak SAR (extrapolated) = 1.83 W/kg

**SAR(1 g) = 1.04 W/kg; SAR(10 g) = 0.576 W/kg**

[Info: Interpolated medium parameters used for SAR evaluation.](#)

Maximum value of SAR (measured) = 1.45 W/kg

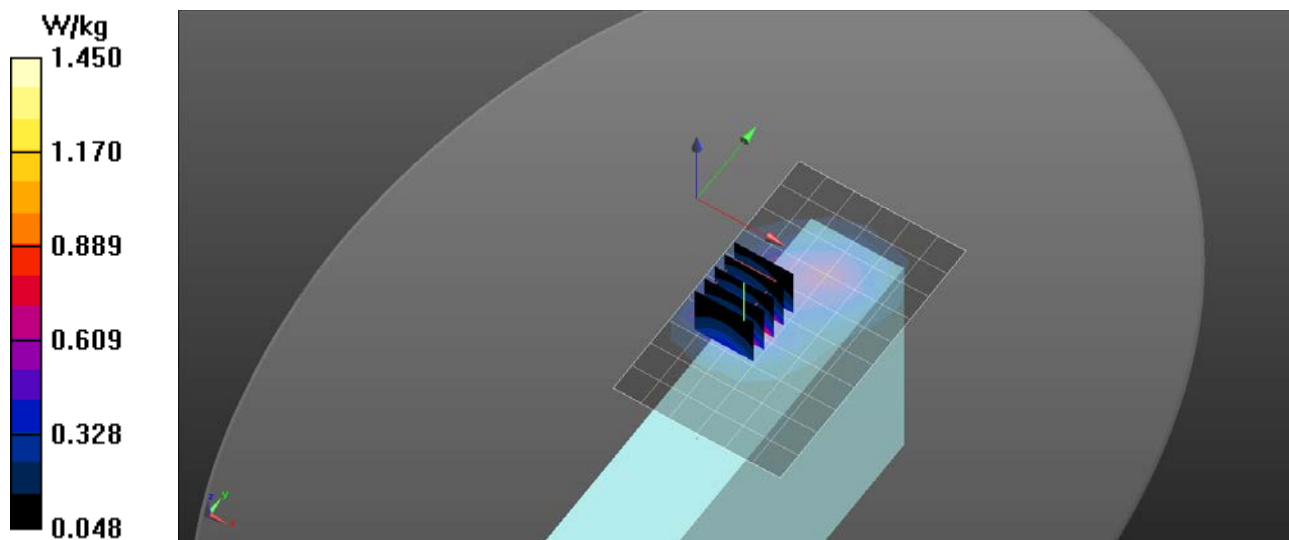

# RF Exposure Lab

## Plot 7

**DUT: AG3; Type: Handheld Computer; Serial: AG3102**

Communication System: LTE (SC-FDMA, 1 RB, 20 MHz, QPSK); Frequency: 1880 MHz; Duty Cycle: 1:1  
Medium: MSL1900; Medium parameters used:  $f = 1880$  MHz;  $\sigma = 1.45$  S/m;  $\epsilon_r = 52.1$ ;  $\rho = 1000$  kg/m<sup>3</sup>  
Phantom section: Flat Section

Test Date: Date: 6/27/2018; Ambient Temp: 23 °C; Tissue Temp: 21 °C

Probe: EX3DV4 - SN3662; ConvF(7.61, 7.61, 7.61); Calibrated: 4/20/2018;  
Sensor-Surface: 2mm (Mechanical Surface Detection)  
Electronics: DAE4 Sn1416; Calibrated: 4/13/2018  
Phantom: ELI v4.0; Type: QDOVA001BB; Serial: 1065  
Measurement SW: DASY52, Version 52.10 (0); SEMCAD X Version 14.6.10 (7417)

### Procedure Notes:

**Band 2 LTE/Left 1 RB Mid/Area Scan (7x11x1):** Measurement grid: dx=15mm, dy=15mm  
Maximum value of SAR (measured) = 1.04 W/kg

**Band 2 LTE/Left 1 RB Mid/Zoom Scan (5x5x7)/Cube 0:** Measurement grid: dx=8mm, dy=8mm, dz=5mm  
Reference Value = 5.058 V/m; Power Drift = -0.047 dB  
Peak SAR (extrapolated) = 1.34 W/kg  
**SAR(1 g) = 0.770 W/kg; SAR(10 g) = 0.433 W/kg**  
Maximum value of SAR (measured) = 1.01 W/kg

**Band 2 LTE/Left 1 RB Mid/Zoom Scan (5x5x7)/Cube 1:** Measurement grid: dx=8mm, dy=8mm, dz=5mm  
Reference Value = 5.058 V/m; Power Drift = -0.04 dB  
Peak SAR (extrapolated) = 1.00 W/kg  
**SAR(1 g) = 0.607 W/kg; SAR(10 g) = 0.365 W/kg**  
Maximum value of SAR (measured) = 0.806 W/kg

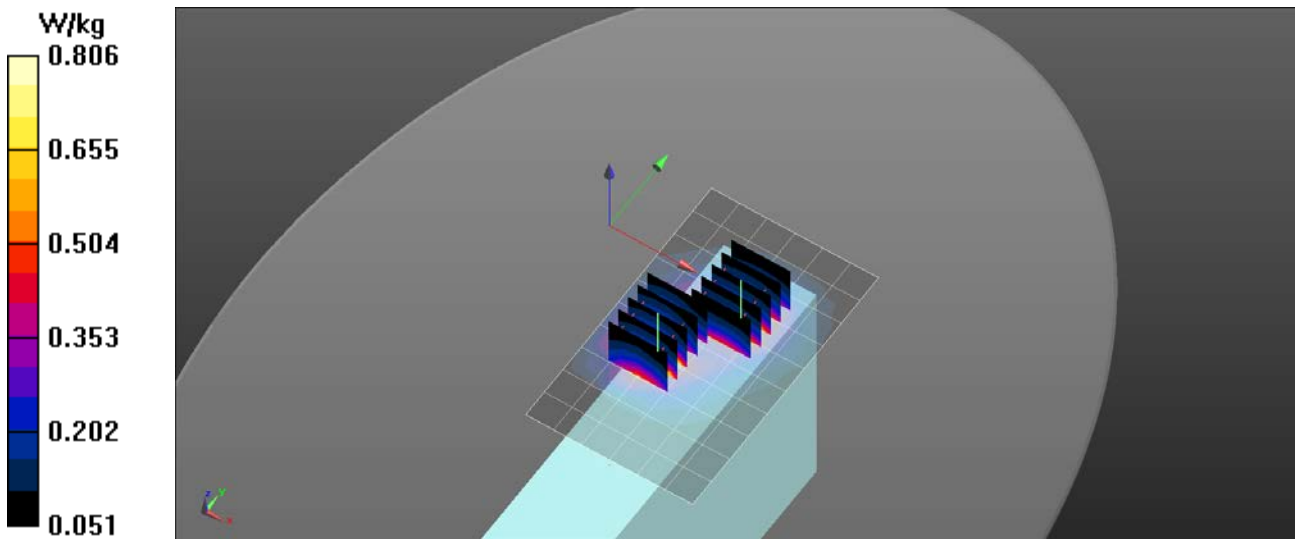

# RF Exposure Lab

## Plot 8

**DUT: AG3; Type: Handheld Computer; Serial: AG3102**

Communication System: WiFi 802.11b (DSSS, 1 Mbps); Frequency: 2437 MHz; Duty Cycle: 1:1  
Medium: MSL2450; Medium parameters used (interpolated):  $f = 2437$  MHz;  $\sigma = 1.947$  S/m;  $\epsilon_r = 52.666$ ;  $\rho = 1000$  kg/m<sup>3</sup>  
Phantom section: Flat Section

Test Date: Date: 10/10/2018; Ambient Temp: 23 °C; Tissue Temp: 21 °C

Probe: EX3DV4 - SN3693; ConvF(7.29, 7.29, 7.29); Calibrated: 8/27/2018;  
Sensor-Surface: 2mm (Mechanical Surface Detection)  
Electronics: DAE4 Sn759; Calibrated: 8/20/2018  
Phantom: ELI v5.0; Type: QDOVA002AA; Serial: 1251  
Measurement SW: DASY52, Version 52.10 (0); SEMCAD X Version 14.6.10 (7417)

### Procedure Notes:

**2450 MHz/Bottom End Mid/Area Scan (7x9x1):** Measurement grid: dx=10mm, dy=10mm

[Info: Interpolated medium parameters used for SAR evaluation.](#)

Maximum value of SAR (measured) = 0.534 W/kg

**2450 MHz/Bottom End Mid/Zoom Scan (7x7x7)/Cube 0:** Measurement grid: dx=5mm, dy=5mm, dz=5mm

Reference Value = 8.012 V/m; Power Drift = -0.04 dB

Peak SAR (extrapolated) = 0.742 W/kg

**SAR(1 g) = 0.395 W/kg; SAR(10 g) = 0.203 W/kg**

[Info: Interpolated medium parameters used for SAR evaluation.](#)

Maximum value of SAR (measured) = 0.566 W/kg

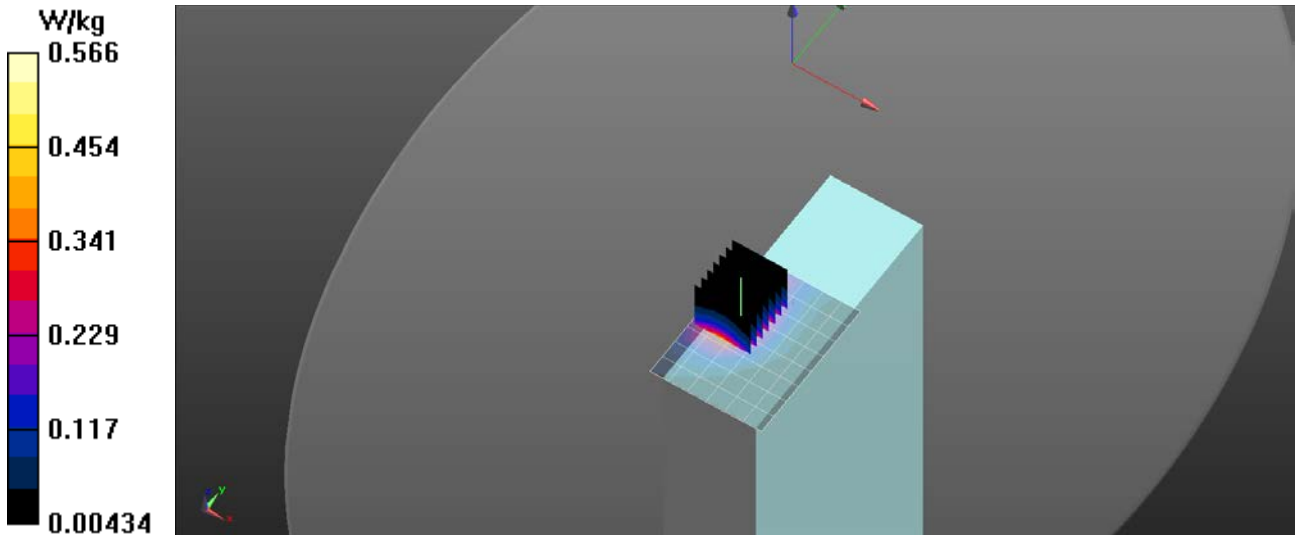

## Appendix C – SAR Test Setup Photos



**Test Position Back 0 mm Gap**



**Test Position Left 0 mm Gap**



**Test Position Right 0 mm Gap**



**Test Position Top 0 mm Gap**





**Test Position Bottom 0 mm Gap**



**Antenna Locations**



**Front of Device**



**Back of Device**



**Battery**

## Appendix D – Probe Calibration Data Sheets

gm

**Calibration Laboratory of  
Schmid & Partner  
Engineering AG**  
Zeughausstrasse 43, 8004 Zurich, Switzerland



**S** Schweizerischer Kalibrierdienst  
**S** Service suisse d'étalonnage  
**C** Servizio svizzero di taratura  
**S** Swiss Calibration Service

Accredited by the Swiss Accreditation Service (SAS)  
The Swiss Accreditation Service is one of the signatories to the EA  
Multilateral Agreement for the recognition of calibration certificates

Accreditation No.: **SCS 0108**

Client **RF Exposure Lab**

Certificate No: **EX3-3662\_Apr18**

## CALIBRATION CERTIFICATE

Object **EX3DV4 - SN:3662**

Calibration procedure(s) **QA CAL-01.v9, QA CAL-14.v4, QA CAL-23.v5, QA CAL-25.v6  
Calibration procedure for dosimetric E-field probes**

Calibration date: **April 20, 2018**

This calibration certificate documents the traceability to national standards, which realize the physical units of measurements (SI).  
The measurements and the uncertainties with confidence probability are given on the following pages and are part of the certificate.

All calibrations have been conducted in the closed laboratory facility: environment temperature (22 ± 3)°C and humidity < 70%.

Calibration Equipment used (M&TE critical for calibration)

Primary Standards	ID	Cal Date (Certificate No.)	Scheduled Calibration
Power meter NRP	SN: 104778	04-Apr-18 (No. 217-02672/02673)	Apr-19
Power sensor NRP-Z91	SN: 103244	04-Apr-18 (No. 217-02672)	Apr-19
Power sensor NRP-Z91	SN: 103245	04-Apr-18 (No. 217-02673)	Apr-19
Reference 20 dB Attenuator	SN: S5277 (20x)	04-Apr-18 (No. 217-02682)	Apr-19
Reference Probe ES3DV2	SN: 3013	30-Dec-17 (No. ES3-3013_Dec17)	Dec-18
DAE4	SN: 660	21-Dec-17 (No. DAE4-660_Dec17)	Dec-18
Secondary Standards	ID	Check Date (in house)	Scheduled Check
Power meter E4419B	SN: GB41293874	06-Apr-16 (in house check Jun-16)	In house check: Jun-18
Power sensor E4412A	SN: MY41498087	06-Apr-16 (in house check Jun-16)	In house check: Jun-18
Power sensor E4412A	SN: 000110210	06-Apr-16 (in house check Jun-16)	In house check: Jun-18
RF generator HP 8648C	SN: US3642U01700	04-Aug-99 (in house check Jun-16)	In house check: Jun-18
Network Analyzer HP 8753E	SN: US37390585	18-Oct-01 (in house check Oct-17)	In house check: Oct-18

Calibrated by:	Name <b>Leif Klysner</b>	Function <b>Laboratory Technician</b>	Signature 
Approved by:	Name <b>Katja Pokovic</b>	Function <b>Technical Manager</b>	Signature 

Issued: April 20, 2018

This calibration certificate shall not be reproduced except in full without written approval of the laboratory.



Accredited by the Swiss Accreditation Service (SAS)

Accreditation No.: **SCS 0108**

The Swiss Accreditation Service is one of the signatories to the EA  
Multilateral Agreement for the recognition of calibration certificates

### Glossary:

TSL	tissue simulating liquid
NORM <sub>x,y,z</sub>	sensitivity in free space
ConvF	sensitivity in TSL / NORM <sub>x,y,z</sub>
DCP	diode compression point
CF	crest factor (1/duty_cycle) of the RF signal
A, B, C, D	modulation dependent linearization parameters
Polarization $\varphi$	$\varphi$ rotation around probe axis
Polarization $\vartheta$	$\vartheta$ rotation around an axis that is in the plane normal to probe axis (at measurement center), i.e., $\vartheta = 0$ is normal to probe axis
Connector Angle	information used in DASY system to align probe sensor X to the robot coordinate system

### Calibration is Performed According to the Following Standards:

- IEEE Std 1528-2013, "IEEE Recommended Practice for Determining the Peak Spatial-Averaged Specific Absorption Rate (SAR) in the Human Head from Wireless Communications Devices: Measurement Techniques", June 2013
- IEC 62209-1, "Measurement procedure for the assessment of Specific Absorption Rate (SAR) from hand-held and body-mounted devices used next to the ear (frequency range of 300 MHz to 6 GHz)", July 2016
- IEC 62209-2, "Procedure to determine the Specific Absorption Rate (SAR) for wireless communication devices used in close proximity to the human body (frequency range of 30 MHz to 6 GHz)", March 2010
- KDB 865664, "SAR Measurement Requirements for 100 MHz to 6 GHz"

### Methods Applied and Interpretation of Parameters:

- NORM<sub>x,y,z</sub>**: Assessed for E-field polarization  $\vartheta = 0$  ( $f \leq 900$  MHz in TEM-cell;  $f > 1800$  MHz: R22 waveguide). NORM<sub>x,y,z</sub> are only intermediate values, i.e., the uncertainties of NORM<sub>x,y,z</sub> does not affect the E<sup>2</sup>-field uncertainty inside TSL (see below ConvF).
- NORM(f)<sub>x,y,z</sub>** = NORM<sub>x,y,z</sub> \* frequency\_response (see Frequency Response Chart). This linearization is implemented in DASY4 software versions later than 4.2. The uncertainty of the frequency response is included in the stated uncertainty of ConvF.
- DCP<sub>x,y,z</sub>**: DCP are numerical linearization parameters assessed based on the data of power sweep with CW signal (no uncertainty required). DCP does not depend on frequency nor media.
- PAR**: PAR is the Peak to Average Ratio that is not calibrated but determined based on the signal characteristics
- A<sub>x,y,z</sub>; B<sub>x,y,z</sub>; C<sub>x,y,z</sub>; D<sub>x,y,z</sub>; VR<sub>x,y,z</sub>**: A, B, C, D are numerical linearization parameters assessed based on the data of power sweep for specific modulation signal. The parameters do not depend on frequency nor media. VR is the maximum calibration range expressed in RMS voltage across the diode.
- ConvF and Boundary Effect Parameters**: Assessed in flat phantom using E-field (or Temperature Transfer Standard for  $f \leq 800$  MHz) and inside waveguide using analytical field distributions based on power measurements for  $f > 800$  MHz. The same setups are used for assessment of the parameters applied for boundary compensation (alpha, depth) of which typical uncertainty values are given. These parameters are used in DASY4 software to improve probe accuracy close to the boundary. The sensitivity in TSL corresponds to NORM<sub>x,y,z</sub> \* ConvF whereby the uncertainty corresponds to that given for ConvF. A frequency dependent ConvF is used in DASY version 4.4 and higher which allows extending the validity from  $\pm 50$  MHz to  $\pm 100$  MHz.
- Spherical isotropy (3D deviation from isotropy)**: in a field of low gradients realized using a flat phantom exposed by a patch antenna.
- Sensor Offset**: The sensor offset corresponds to the offset of virtual measurement center from the probe tip (on probe axis). No tolerance required.
- Connector Angle**: The angle is assessed using the information gained by determining the NORM<sub>x</sub> (no uncertainty required).



# Probe EX3DV4

## SN:3662

Manufactured: October 20, 2008  
Calibrated: April 20, 2018

Calibrated for DASYS/EASY Systems  
(Note: non-compatible with DASYS2 system!)

## DASY/EASY - Parameters of Probe: EX3DV4 - SN:3662

### Basic Calibration Parameters

	Sensor X	Sensor Y	Sensor Z	Unc (k=2)
Norm ( $\mu\text{V}/(\text{V}/\text{m})^2$ ) <sup>A</sup>	0.44	0.45	0.48	$\pm 10.1 \%$
DCP (mV) <sup>B</sup>	102.6	97.6	96.4	

### Modulation Calibration Parameters

UID	Communication System Name		A dB	B dB $\sqrt{\mu\text{V}}$	C	D dB	VR mV	Unc <sup>E</sup> (k=2)
0	CW	X	0.0	0.0	1.0	0.00	136.8	$\pm 3.3 \%$
		Y	0.0	0.0	1.0		132.2	
		Z	0.0	0.0	1.0		148.8	

The reported uncertainty of measurement is stated as the standard uncertainty of measurement multiplied by the coverage factor k=2, which for a normal distribution corresponds to a coverage probability of approximately 95%.

<sup>A</sup> The uncertainties of Norm X,Y,Z do not affect the E<sup>2</sup>-field uncertainty inside TSL (see Pages 5 and 6).

<sup>B</sup> Numerical linearization parameter: uncertainty not required.

<sup>E</sup> Uncertainty is determined using the max. deviation from linear response applying rectangular distribution and is expressed for the square of the field value.

## DASY/EASY - Parameters of Probe: EX3DV4 - SN:3662

### Calibration Parameter Determined in Head Tissue Simulating Media

f (MHz) <sup>C</sup>	Relative Permittivity <sup>F</sup>	Conductivity (S/m) <sup>F</sup>	ConvF X	ConvF Y	ConvF Z	Alpha <sup>G</sup>	Depth <sup>G</sup> (mm)	Unc (k=2)
750	41.9	0.89	9.80	9.80	9.80	0.43	0.90	± 12.0 %
900	41.5	0.97	9.29	9.29	9.29	0.40	0.91	± 12.0 %
1750	40.1	1.37	8.29	8.29	8.29	0.29	0.84	± 12.0 %
1900	40.0	1.40	8.01	8.01	8.01	0.37	0.80	± 12.0 %
2300	39.5	1.67	7.71	7.71	7.71	0.35	0.80	± 12.0 %
2450	39.2	1.80	7.39	7.39	7.39	0.28	0.91	± 12.0 %
2600	39.0	1.96	7.14	7.14	7.14	0.36	0.85	± 12.0 %
3500	37.9	2.91	7.08	7.08	7.08	0.25	1.20	± 13.1 %
3700	37.7	3.12	6.99	6.99	6.99	0.25	1.20	± 13.1 %
5250	35.9	4.71	5.04	5.04	5.04	0.35	1.80	± 13.1 %
5600	35.5	5.07	4.81	4.81	4.81	0.40	1.80	± 13.1 %
5750	35.4	5.22	4.89	4.89	4.89	0.40	1.80	± 13.1 %

<sup>C</sup> Frequency validity above 300 MHz of ± 100 MHz only applies for DASY v4.4 and higher (see Page 2), else it is restricted to ± 50 MHz. The uncertainty is the RSS of the ConvF uncertainty at calibration frequency and the uncertainty for the indicated frequency band. Frequency validity below 300 MHz is ± 10, 25, 40, 50 and 70 MHz for ConvF assessments at 30, 64, 128, 150 and 220 MHz respectively. Above 5 GHz frequency validity can be extended to ± 110 MHz.

<sup>F</sup> At frequencies below 3 GHz, the validity of tissue parameters ( $\epsilon$  and  $\sigma$ ) can be relaxed to ± 10% if liquid compensation formula is applied to measured SAR values. At frequencies above 3 GHz, the validity of tissue parameters ( $\epsilon$  and  $\sigma$ ) is restricted to ± 5%. The uncertainty is the RSS of the ConvF uncertainty for indicated target tissue parameters.

<sup>G</sup> Alpha/Depth are determined during calibration. SPEAG warrants that the remaining deviation due to the boundary effect after compensation is always less than ± 1% for frequencies below 3 GHz and below ± 2% for frequencies between 3-6 GHz at any distance larger than half the probe tip diameter from the boundary.

## DASY/EASY - Parameters of Probe: EX3DV4 - SN:3662

### Calibration Parameter Determined in Body Tissue Simulating Media

f (MHz) <sup>C</sup>	Relative Permittivity <sup>F</sup>	Conductivity (S/m) <sup>F</sup>	ConvF X	ConvF Y	ConvF Z	Alpha <sup>G</sup>	Depth <sup>G</sup> (mm)	Unc (k=2)
750	55.5	0.96	9.62	9.62	9.62	0.37	0.98	± 12.0 %
900	55.0	1.05	9.21	9.21	9.21	0.44	0.84	± 12.0 %
1750	53.4	1.49	7.96	7.96	7.96	0.45	0.80	± 12.0 %
1900	53.3	1.52	7.61	7.61	7.61	0.44	0.80	± 12.0 %
2300	52.9	1.81	7.33	7.33	7.33	0.41	0.80	± 12.0 %
2450	52.7	1.95	7.29	7.29	7.29	0.36	0.87	± 12.0 %
2600	52.5	2.16	7.15	7.15	7.15	0.26	0.99	± 12.0 %
3500	51.3	3.31	7.00	7.00	7.00	0.25	1.20	± 13.1 %
3700	51.0	3.55	6.71	6.71	6.71	0.23	1.20	± 13.1 %
5250	48.9	5.36	4.46	4.46	4.46	0.45	1.90	± 13.1 %
5600	48.5	5.77	3.91	3.91	3.91	0.50	1.90	± 13.1 %
5750	48.3	5.94	4.08	4.08	4.08	0.50	1.90	± 13.1 %

<sup>C</sup> Frequency validity above 300 MHz of ± 100 MHz only applies for DASY v4.4 and higher (see Page 2), else it is restricted to ± 50 MHz. The uncertainty is the RSS of the ConvF uncertainty at calibration frequency and the uncertainty for the indicated frequency band. Frequency validity below 300 MHz is ± 10, 25, 40, 50 and 70 MHz for ConvF assessments at 30, 64, 128, 150 and 220 MHz respectively. Above 5 GHz frequency validity can be extended to ± 110 MHz.

<sup>F</sup> At frequencies below 3 GHz, the validity of tissue parameters ( $\epsilon$  and  $\sigma$ ) can be relaxed to ± 10% if liquid compensation formula is applied to measured SAR values. At frequencies above 3 GHz, the validity of tissue parameters ( $\epsilon$  and  $\sigma$ ) is restricted to ± 5%. The uncertainty is the RSS of the ConvF uncertainty for indicated target tissue parameters.

<sup>G</sup> Alpha/Depth are determined during calibration. SPEAG warrants that the remaining deviation due to the boundary effect after compensation is always less than ± 1% for frequencies below 3 GHz and below ± 2% for frequencies between 3-6 GHz at any distance larger than half the probe tip diameter from the boundary.

### Frequency Response of E-Field (TEM-Cell:ifi110 EXX, Waveguide: R22)

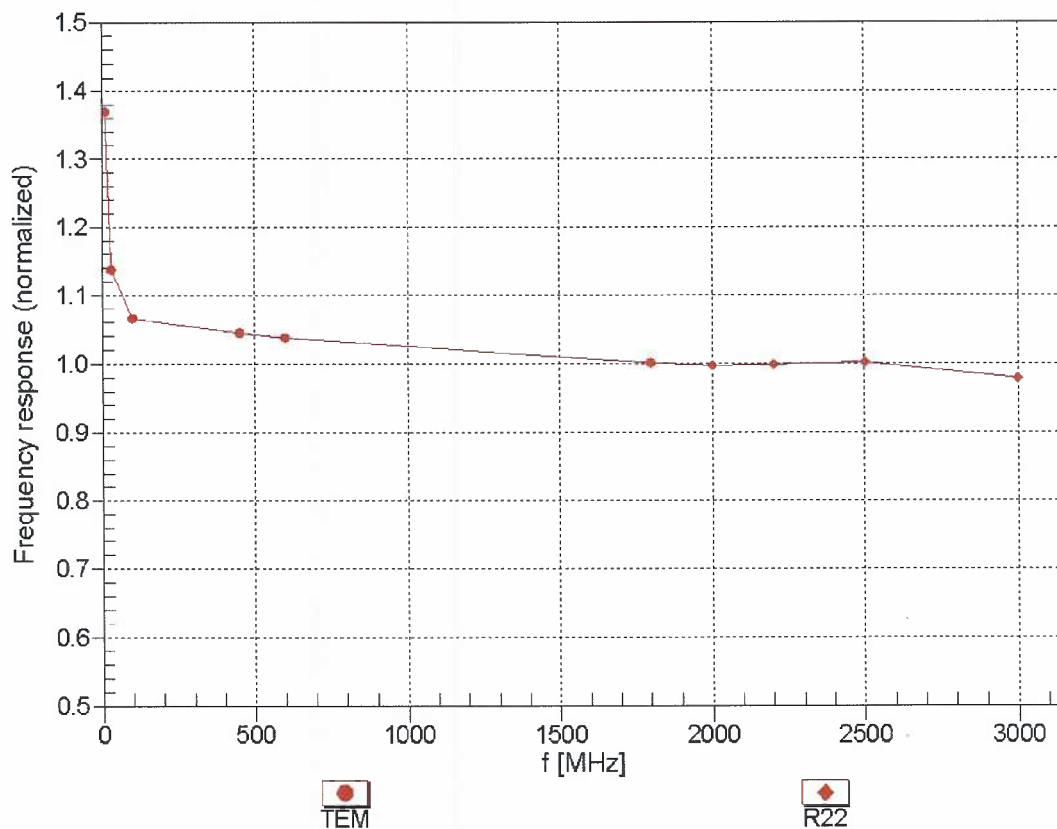

Uncertainty of Frequency Response of E-field:  $\pm 6.3\%$  (k=2)

### Receiving Pattern ( $\phi$ ), $\vartheta = 0^\circ$

f=600 MHz,TEM

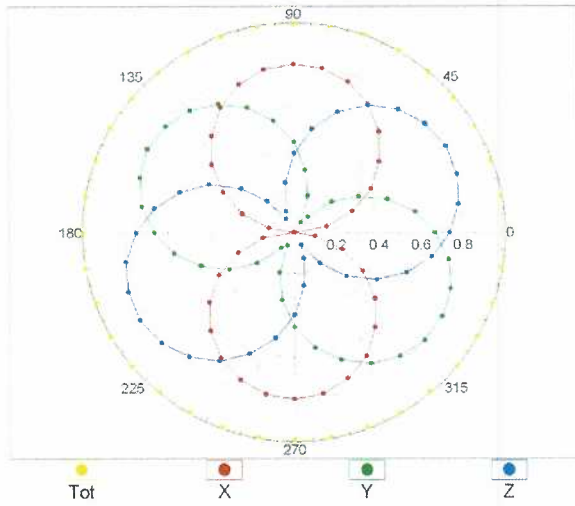

f=1800 MHz,R22

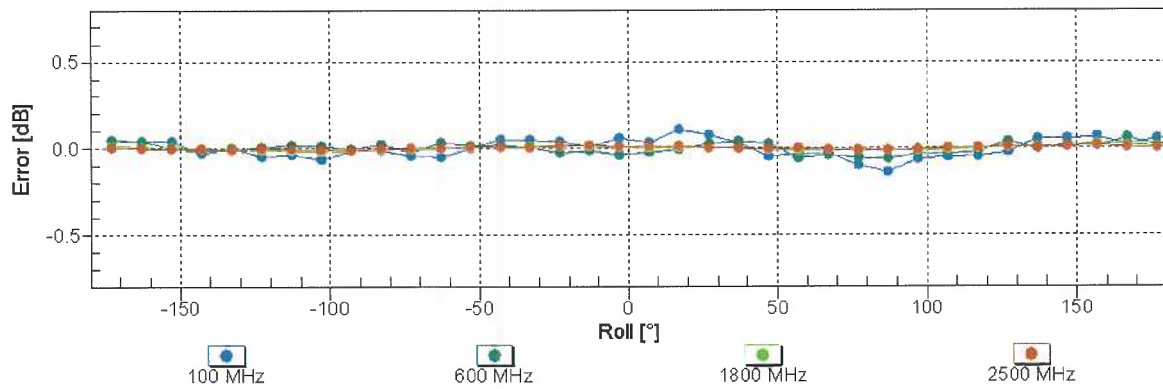
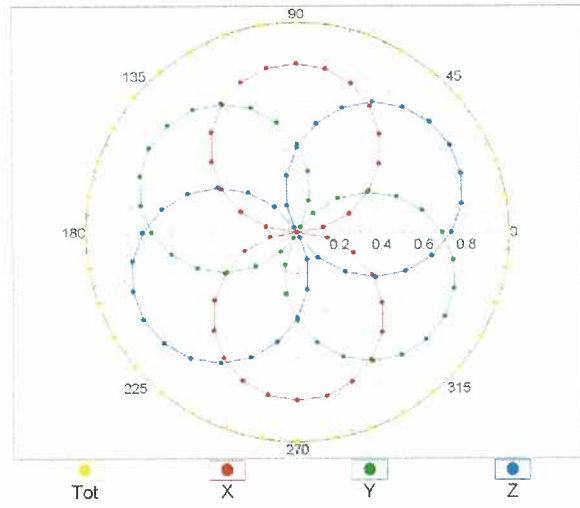

Uncertainty of Axial Isotropy Assessment:  $\pm 0.5\%$  (k=2)

### Dynamic Range f(SAR<sub>head</sub>) (TEM cell , f<sub>eval</sub>= 1900 MHz)

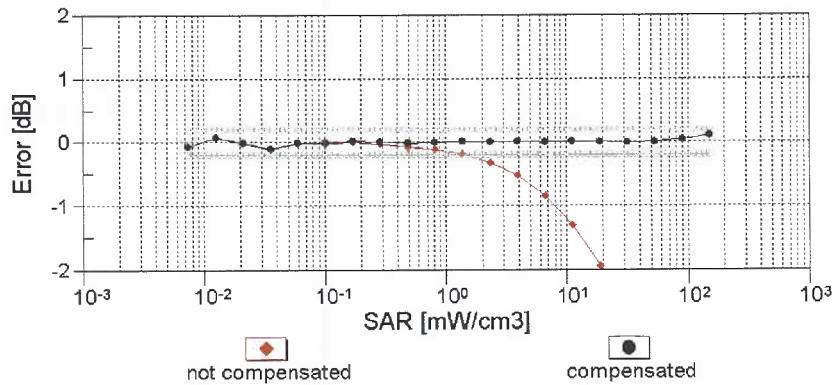
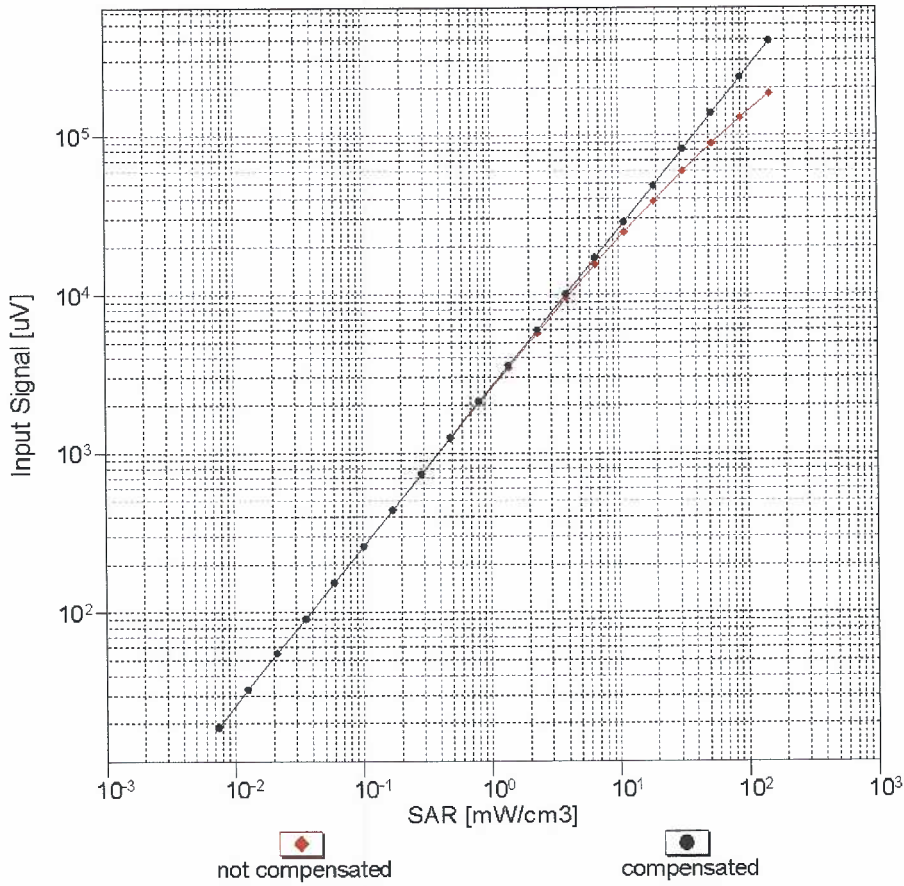

Uncertainty of Linearity Assessment: ± 0.6% (k=2)

# Conversion Factor Assessment

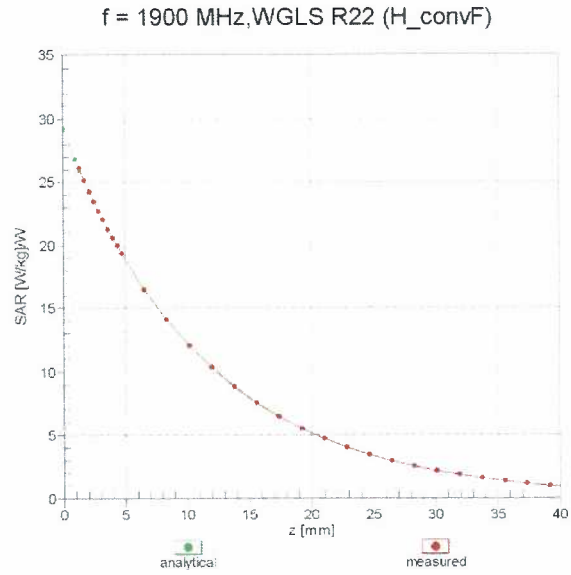
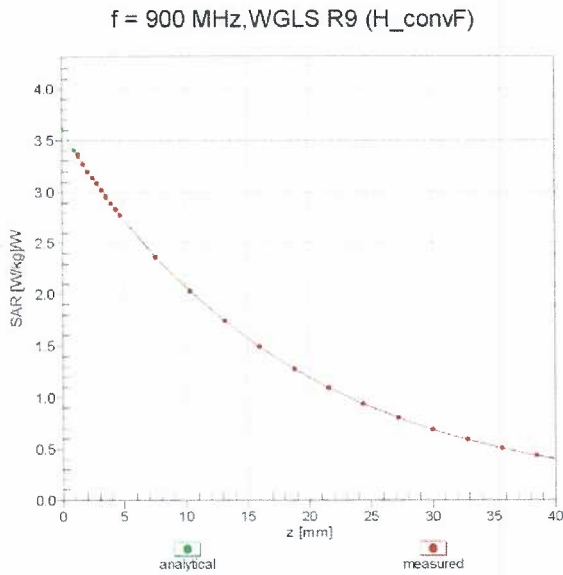

## Deviation from Isotropy in Liquid Error ( $\phi, \vartheta$ ), f = 900 MHz

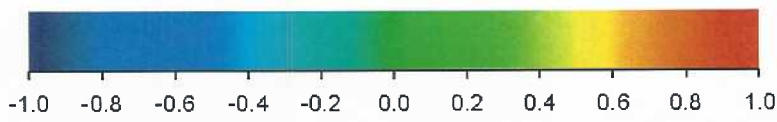
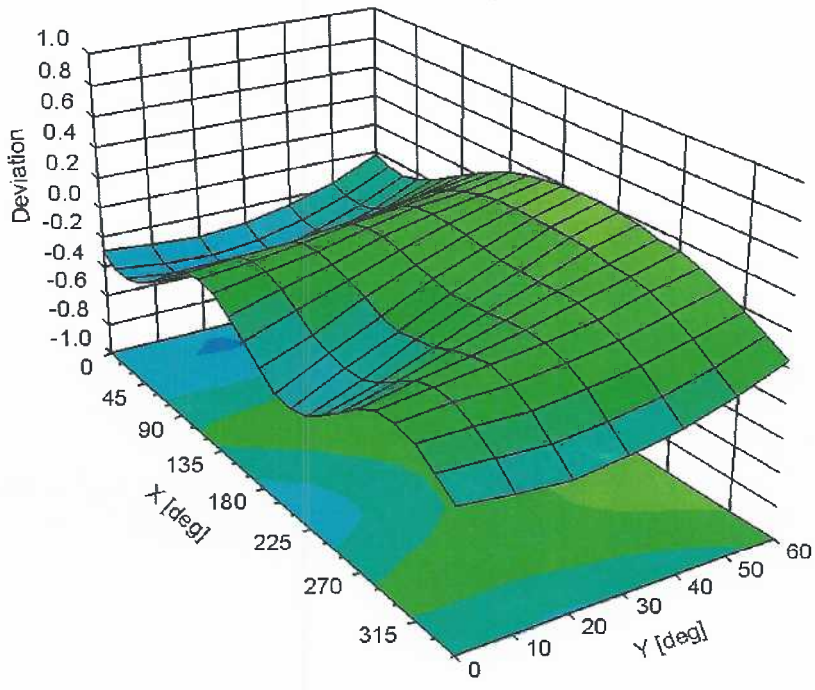

Uncertainty of Spherical Isotropy Assessment:  $\pm 2.6\%$  (k=2)



**DASY/EASY - Parameters of Probe: EX3DV4 - SN:3662****Other Probe Parameters**

Sensor Arrangement	Triangular
Connector Angle (°)	-22.9
Mechanical Surface Detection Mode	enabled
Optical Surface Detection Mode	disabled
Probe Overall Length	337 mm
Probe Body Diameter	10 mm
Tip Length	9 mm
Tip Diameter	2.5 mm
Probe Tip to Sensor X Calibration Point	1 mm
Probe Tip to Sensor Y Calibration Point	1 mm
Probe Tip to Sensor Z Calibration Point	1 mm
Recommended Measurement Distance from Surface	1.4 mm



Accredited by the Swiss Accreditation Service (SAS)  
The Swiss Accreditation Service is one of the signatories to the EA  
Multilateral Agreement for the recognition of calibration certificates

Accreditation No.: **SCS 0108**

Client **RF Exposure Lab**

Certificate No: **EX3-3693\_Aug18**

**CALIBRATION CERTIFICATE**

Object **EX3DV4 - SN:3693**

Calibration procedure(s) **QA CAL-01.v9, QA CAL-14.v4, QA CAL-23.v5, QA CAL-25.v6  
Calibration procedure for dosimetric E-field probes**

Calibration date: **August 27, 2018**

This calibration certificate documents the traceability to national standards, which realize the physical units of measurements (SI).  
The measurements and the uncertainties with confidence probability are given on the following pages and are part of the certificate.

All calibrations have been conducted in the closed laboratory facility: environment temperature (22 ± 3)°C and humidity < 70%.

Calibration Equipment used (M&TE critical for calibration)

Primary Standards	ID	Cal Date (Certificate No.)	Scheduled Calibration
Power meter NRP	SN: 104778	04-Apr-18 (No. 217-02672/02673)	Apr-19
Power sensor NRP-Z91	SN: 103244	04-Apr-18 (No. 217-02672)	Apr-19
Power sensor NRP-Z91	SN: 103245	04-Apr-18 (No. 217-02673)	Apr-19
Reference 20 dB Attenuator	SN: S5277 (20x)	04-Apr-18 (No. 217-02682)	Apr-19
Reference Probe ES3DV2	SN: 3013	30-Dec-17 (No. ES3-3013_Dec17)	Dec-18
DAE4	SN: 660	21-Dec-17 (No. DAE4-660_Dec17)	Dec-18
Secondary Standards	ID	Check Date (in house)	Scheduled Check
Power meter E4419B	SN: GB41293874	06-Apr-16 (in house check Jun-18)	In house check: Jun-20
Power sensor E4412A	SN: MY41498087	06-Apr-16 (in house check Jun-18)	In house check: Jun-20
Power sensor E4412A	SN: 000110210	06-Apr-16 (in house check Jun-18)	In house check: Jun-20
RF generator HP 8648C	SN: US3642U01700	04-Aug-99 (in house check Jun-18)	In house check: Jun-20
Network Analyzer E8358A	SN: US41080477	31-Mar-14 (in house check Oct-17)	In house check: Oct-18

Calibrated by:	Name <b>Jeton Kastrati</b>	Function <b>Laboratory Technician</b>	Signature 
Approved by:	Name <b>Katja Pokovic</b>	Function <b>Technical Manager</b>	

Issued: August 30, 2018

This calibration certificate shall not be reproduced except in full without written approval of the laboratory.



Accredited by the Swiss Accreditation Service (SAS)

Accreditation No.: **SCS 0108**

The Swiss Accreditation Service is one of the signatories to the EA Multilateral Agreement for the recognition of calibration certificates

**Glossary:**

TSL	tissue simulating liquid
NORM <sub>x,y,z</sub>	sensitivity in free space
ConvF	sensitivity in TSL / NORM <sub>x,y,z</sub>
DCP	diode compression point
CF	crest factor (1/duty_cycle) of the RF signal
A, B, C, D	modulation dependent linearization parameters
Polarization φ	φ rotation around probe axis
Polarization ϑ	ϑ rotation around an axis that is in the plane normal to probe axis (at measurement center), i.e., ϑ = 0 is normal to probe axis
Connector Angle	information used in DASY system to align probe sensor X to the robot coordinate system

**Calibration is Performed According to the Following Standards:**

- a) IEEE Std 1528-2013, "IEEE Recommended Practice for Determining the Peak Spatial-Averaged Specific Absorption Rate (SAR) in the Human Head from Wireless Communications Devices: Measurement Techniques", June 2013
- b) IEC 62209-1, "Measurement procedure for the assessment of Specific Absorption Rate (SAR) from hand-held and body-mounted devices used next to the ear (frequency range of 300 MHz to 6 GHz)", July 2016
- c) IEC 62209-2, "Procedure to determine the Specific Absorption Rate (SAR) for wireless communication devices used in close proximity to the human body (frequency range of 30 MHz to 6 GHz)", March 2010
- d) KDB 865664, "SAR Measurement Requirements for 100 MHz to 6 GHz"

**Methods Applied and Interpretation of Parameters:**

- *NORM<sub>x,y,z</sub>*: Assessed for E-field polarization ϑ = 0 (f ≤ 900 MHz in TEM-cell; f > 1800 MHz: R22 waveguide). *NORM<sub>x,y,z</sub>* are only intermediate values, i.e., the uncertainties of *NORM<sub>x,y,z</sub>* does not affect the E<sup>2</sup>-field uncertainty inside TSL (see below *ConvF*).
- *NORM(f)<sub>x,y,z</sub>* = *NORM<sub>x,y,z</sub>* \* *frequency\_response* (see Frequency Response Chart). This linearization is implemented in DASY4 software versions later than 4.2. The uncertainty of the frequency response is included in the stated uncertainty of *ConvF*.
- *DCP<sub>x,y,z</sub>*: DCP are numerical linearization parameters assessed based on the data of power sweep with CW signal (no uncertainty required). DCP does not depend on frequency nor media.
- *PAR*: PAR is the Peak to Average Ratio that is not calibrated but determined based on the signal characteristics
- *A<sub>x,y,z</sub>*; *B<sub>x,y,z</sub>*; *C<sub>x,y,z</sub>*; *D<sub>x,y,z</sub>*; *VR<sub>x,y,z</sub>*: *A, B, C, D* are numerical linearization parameters assessed based on the data of power sweep for specific modulation signal. The parameters do not depend on frequency nor media. *VR* is the maximum calibration range expressed in RMS voltage across the diode.
- *ConvF* and *Boundary Effect Parameters*: Assessed in flat phantom using E-field (or Temperature Transfer Standard for f ≤ 800 MHz) and inside waveguide using analytical field distributions based on power measurements for f > 800 MHz. The same setups are used for assessment of the parameters applied for boundary compensation (alpha, depth) of which typical uncertainty values are given. These parameters are used in DASY4 software to improve probe accuracy close to the boundary. The sensitivity in TSL corresponds to *NORM<sub>x,y,z</sub>* \* *ConvF* whereby the uncertainty corresponds to that given for *ConvF*. A frequency dependent *ConvF* is used in DASY version 4.4 and higher which allows extending the validity from ± 50 MHz to ± 100 MHz.
- *Spherical isotropy (3D deviation from isotropy)*: in a field of low gradients realized using a flat phantom exposed by a patch antenna.
- *Sensor Offset*: The sensor offset corresponds to the offset of virtual measurement center from the probe tip (on probe axis). No tolerance required.
- *Connector Angle*: The angle is assessed using the information gained by determining the *NORM<sub>x</sub>* (no uncertainty required).

# Probe EX3DV4

## SN:3693

Manufactured: April 22, 2009  
Calibrated: August 27, 2018

Calibrated for DASY/EASY Systems  
(Note: non-compatible with DASY2 system!)

## DASY/EASY - Parameters of Probe: EX3DV4 - SN:3693

### Basic Calibration Parameters

	Sensor X	Sensor Y	Sensor Z	Unc (k=2)
Norm ( $\mu\text{V}/(\text{V}/\text{m})^2$ ) <sup>A</sup>	0.39	0.30	0.35	$\pm 10.1 \%$
DCP (mV) <sup>B</sup>	96.9	97.3	107.3	

### Modulation Calibration Parameters

UID	Communication System Name		A dB	B dB $\sqrt{\mu\text{V}}$	C	D dB	VR mV	Unc <sup>E</sup> (k=2)
0	CW	X	0.0	0.0	1.0	0.00	133.1	$\pm 1.7 \%$
		Y	0.0	0.0	1.0		130.6	
		Z	0.0	0.0	1.0		133.5	

Note: For details on UID parameters see Appendix.

### Sensor Model Parameters

	C1 fF	C2 fF	$\alpha$ $\text{V}^{-1}$	T1 $\text{ms}\cdot\text{V}^{-2}$	T2 $\text{ms}\cdot\text{V}^{-1}$	T3 ms	T4 $\text{V}^{-2}$	T5 $\text{V}^{-1}$	T6
X	32.78	256.2	38.66	10.42	1.187	5.061	0.000	0.479	1.010
Y	38.15	291.7	37.34	12.40	1.152	4.996	0.986	0.358	1.004
Z	26.99	197.7	34.43	5.333	0.521	5.037	0.437	0.333	1.004

The reported uncertainty of measurement is stated as the standard uncertainty of measurement multiplied by the coverage factor  $k=2$ , which for a normal distribution corresponds to a coverage probability of approximately 95%.

<sup>A</sup> The uncertainties of Norm X,Y,Z do not affect the  $E^2$ -field uncertainty inside TSL (see Pages 5 and 6).

<sup>B</sup> Numerical linearization parameter: uncertainty not required.

<sup>E</sup> Uncertainty is determined using the max. deviation from linear response applying rectangular distribution and is expressed for the square of the field value.

## DASY/EASY - Parameters of Probe: EX3DV4 - SN:3693

### Calibration Parameter Determined in Head Tissue Simulating Media

f (MHz) <sup>C</sup>	Relative Permittivity <sup>F</sup>	Conductivity (S/m) <sup>F</sup>	ConvF X	ConvF Y	ConvF Z	Alpha <sup>G</sup>	Depth <sup>G</sup> (mm)	Unc (k=2)
750	41.9	0.89	9.64	9.64	9.64	0.55	0.84	± 12.0 %
835	41.5	0.90	9.37	9.37	9.37	0.37	0.97	± 12.0 %
900	41.5	0.97	9.16	9.16	9.16	0.53	0.80	± 12.0 %
1750	40.1	1.37	8.10	8.10	8.10	0.31	0.86	± 12.0 %
1900	40.0	1.40	7.78	7.78	7.78	0.28	0.90	± 12.0 %
2300	39.5	1.67	7.42	7.42	7.42	0.32	0.92	± 12.0 %
2450	39.2	1.80	6.95	6.95	6.95	0.35	0.92	± 12.0 %
2600	39.0	1.96	6.90	6.90	6.90	0.30	0.99	± 12.0 %
5250	35.9	4.71	4.96	4.96	4.96	0.40	1.80	± 13.1 %
5600	35.5	5.07	4.77	4.77	4.77	0.40	1.80	± 13.1 %
5750	35.4	5.22	4.67	4.67	4.67	0.40	1.80	± 13.1 %

<sup>C</sup> Frequency validity above 300 MHz of ± 100 MHz only applies for DASY v4.4 and higher (see Page 2), else it is restricted to ± 50 MHz. The uncertainty is the RSS of the ConvF uncertainty at calibration frequency and the uncertainty for the indicated frequency band. Frequency validity below 300 MHz is ± 10, 25, 40, 50 and 70 MHz for ConvF assessments at 30, 64, 128, 150 and 220 MHz respectively. Above 5 GHz frequency validity can be extended to ± 110 MHz.

<sup>F</sup> At frequencies below 3 GHz, the validity of tissue parameters ( $\epsilon$  and  $\sigma$ ) can be relaxed to ± 10% if liquid compensation formula is applied to measured SAR values. At frequencies above 3 GHz, the validity of tissue parameters ( $\epsilon$  and  $\sigma$ ) is restricted to ± 5%. The uncertainty is the RSS of the ConvF uncertainty for indicated target tissue parameters.

<sup>G</sup> Alpha/Depth are determined during calibration. SPEAG warrants that the remaining deviation due to the boundary effect after compensation is always less than ± 1% for frequencies below 3 GHz and below ± 2% for frequencies between 3-6 GHz at any distance larger than half the probe tip diameter from the boundary.

## DASY/EASY - Parameters of Probe: EX3DV4 - SN:3693

### Calibration Parameter Determined in Body Tissue Simulating Media

f (MHz) <sup>C</sup>	Relative Permittivity <sup>F</sup>	Conductivity (S/m) <sup>F</sup>	ConvF X	ConvF Y	ConvF Z	Alpha <sup>G</sup>	Depth <sup>G</sup> (mm)	Unc (k=2)
750	55.5	0.96	9.77	9.77	9.77	0.46	0.85	± 12.0 %
835	55.2	0.97	9.40	9.40	9.40	0.43	0.89	± 12.0 %
900	55.0	1.05	9.25	9.25	9.25	0.39	0.93	± 12.0 %
1750	53.4	1.49	7.77	7.77	7.77	0.32	0.89	± 12.0 %
1900	53.3	1.52	7.44	7.44	7.44	0.40	0.93	± 12.0 %
2300	52.9	1.81	7.43	7.43	7.43	0.40	0.90	± 12.0 %
2450	52.7	1.95	7.29	7.29	7.29	0.31	0.95	± 12.0 %
2600	52.5	2.16	7.13	7.13	7.13	0.29	1.05	± 12.0 %
5250	48.9	5.36	4.46	4.46	4.46	0.50	1.90	± 13.1 %
5600	48.5	5.77	3.91	3.91	3.91	0.50	1.90	± 13.1 %
5750	48.3	5.94	4.05	4.05	4.05	0.50	1.90	± 13.1 %

<sup>C</sup> Frequency validity above 300 MHz of ± 100 MHz only applies for DASY v4.4 and higher (see Page 2), else it is restricted to ± 50 MHz. The uncertainty is the RSS of the ConvF uncertainty at calibration frequency and the uncertainty for the indicated frequency band. Frequency validity below 300 MHz is ± 10, 25, 40, 50 and 70 MHz for ConvF assessments at 30, 64, 128, 150 and 220 MHz respectively. Above 5 GHz frequency validity can be extended to ± 110 MHz.

<sup>F</sup> At frequencies below 3 GHz, the validity of tissue parameters ( $\epsilon$  and  $\sigma$ ) can be relaxed to ± 10% if liquid compensation formula is applied to measured SAR values. At frequencies above 3 GHz, the validity of tissue parameters ( $\epsilon$  and  $\sigma$ ) is restricted to ± 5%. The uncertainty is the RSS of the ConvF uncertainty for indicated target tissue parameters.

<sup>G</sup> Alpha/Depth are determined during calibration. SPEAG warrants that the remaining deviation due to the boundary effect after compensation is always less than ± 1% for frequencies below 3 GHz and below ± 2% for frequencies between 3-6 GHz at any distance larger than half the probe tip diameter from the boundary.

### Frequency Response of E-Field (TEM-Cell:ifi110 EXX, Waveguide: R22)

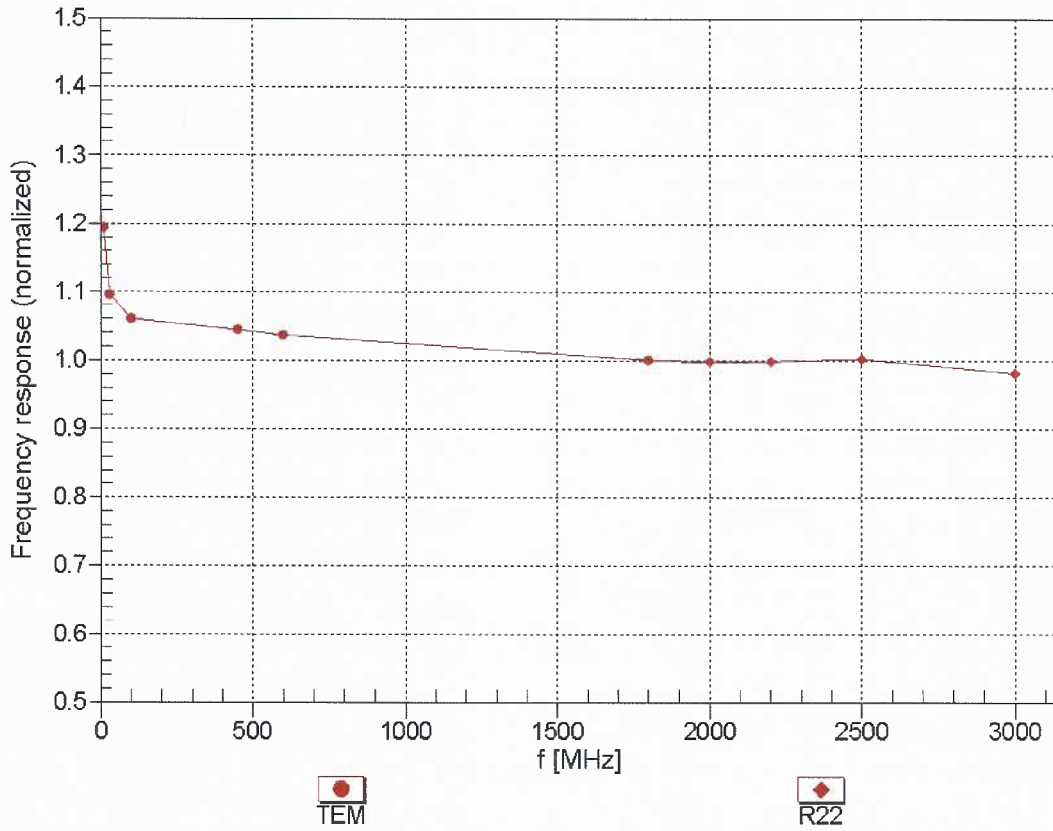

Uncertainty of Frequency Response of E-field:  $\pm 6.3\%$  (k=2)



### Receiving Pattern ( $\phi$ ), $\vartheta = 0^\circ$

f=600 MHz,TEM

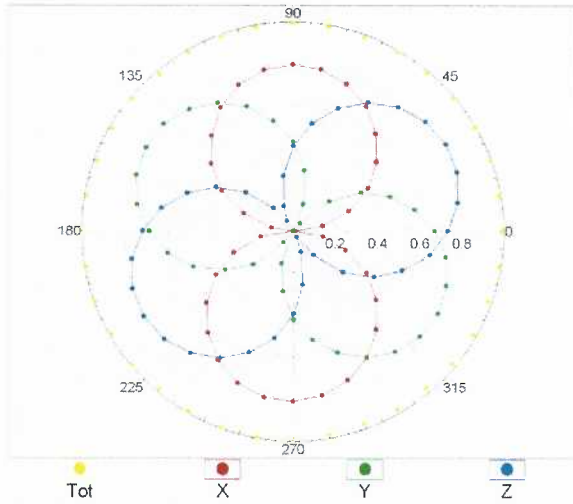

f=1800 MHz,R22

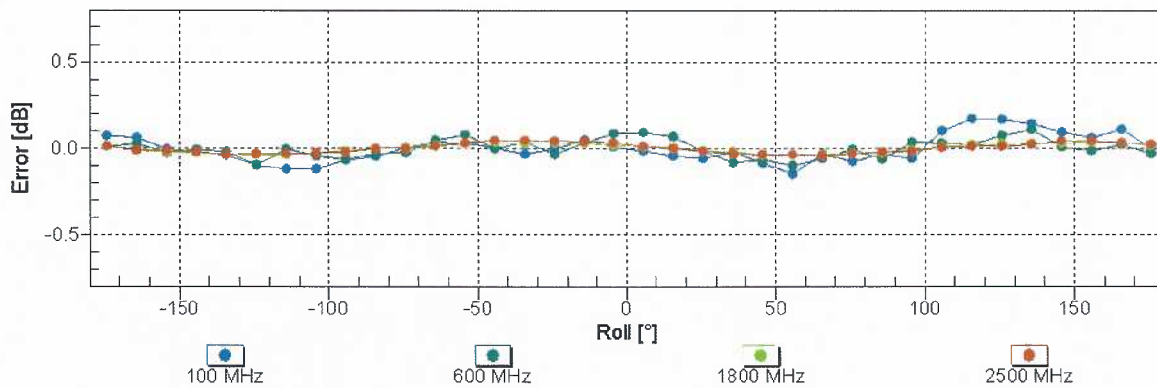
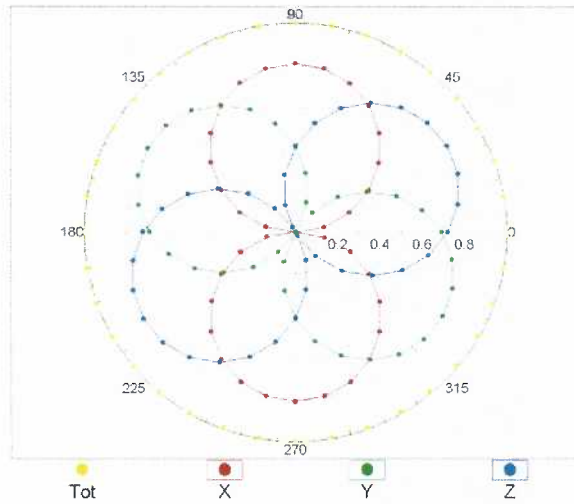

Uncertainty of Axial Isotropy Assessment:  $\pm 0.5\%$  (k=2)

### Dynamic Range $f(\text{SAR}_{\text{head}})$ (TEM cell , $f_{\text{eval}} = 1900 \text{ MHz}$ )

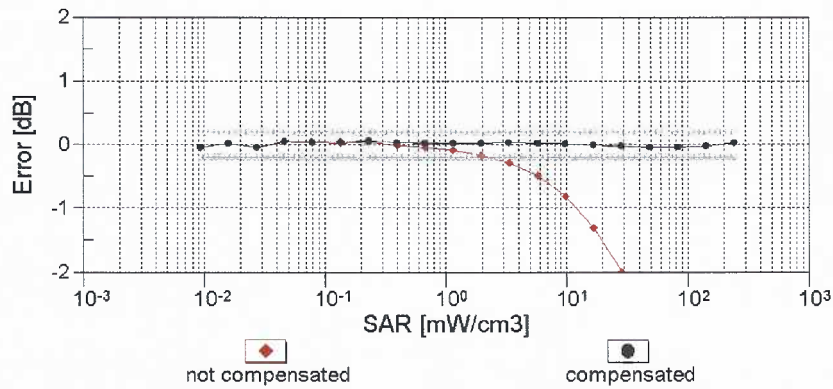
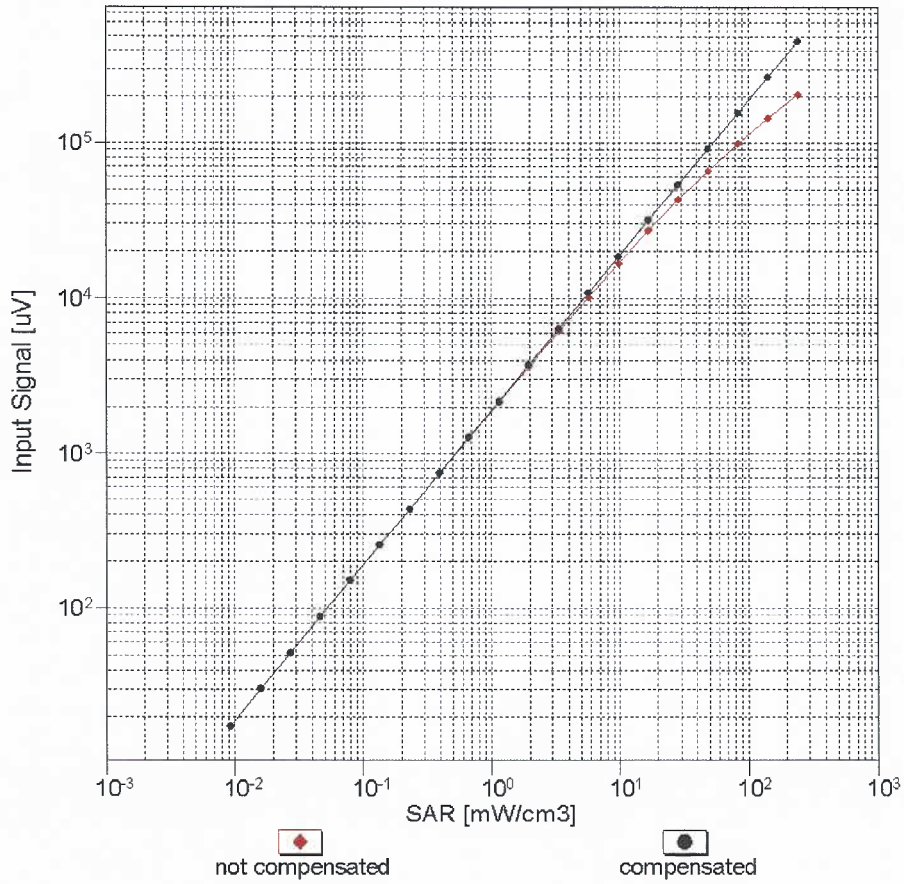

Uncertainty of Linearity Assessment:  $\pm 0.6\%$  ( $k=2$ )

# Conversion Factor Assessment

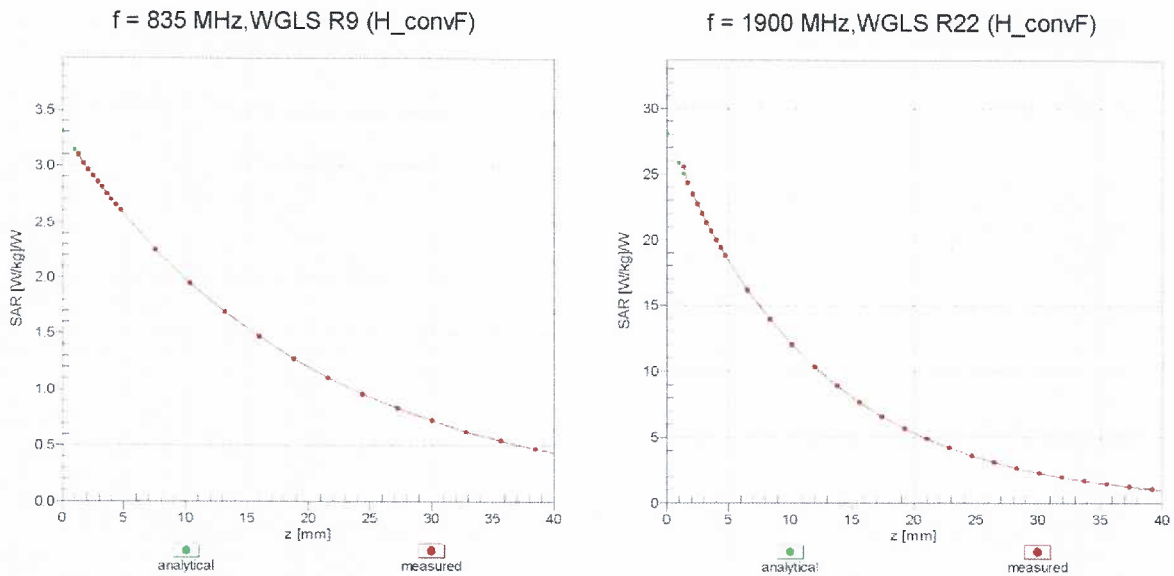

## Deviation from Isotropy in Liquid Error ( $\phi, \theta$ ), f = 900 MHz

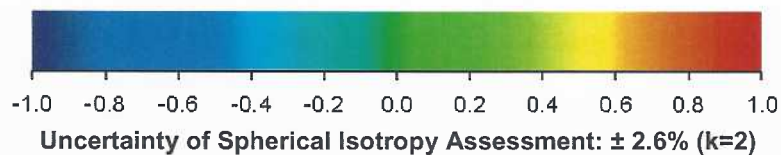
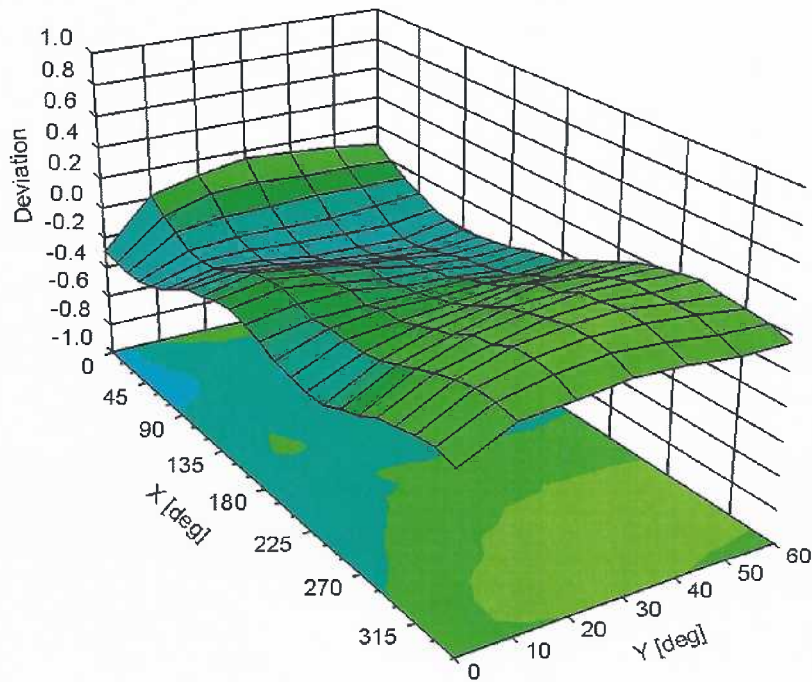

## DASY/EASY - Parameters of Probe: EX3DV4 - SN:3693

### Other Probe Parameters

Sensor Arrangement	Triangular
Connector Angle (°)	105.7
Mechanical Surface Detection Mode	enabled
Optical Surface Detection Mode	disabled
Probe Overall Length	337 mm
Probe Body Diameter	10 mm
Tip Length	9 mm
Tip Diameter	2.5 mm
Probe Tip to Sensor X Calibration Point	1 mm
Probe Tip to Sensor Y Calibration Point	1 mm
Probe Tip to Sensor Z Calibration Point	1 mm
Recommended Measurement Distance from Surface	1.4 mm

**Appendix: Modulation Calibration Parameters**

UID	Communication System Name		A dB	B dB $\sqrt{\mu V}$	C	D dB	VR mV	Max Unc <sup>E</sup> (k=2)
0	CW	X	0.00	0.00	1.00	0.00	133.1	$\pm 1.7\%$
		Y	0.00	0.00	1.00		130.6	
		Z	0.00	0.00	1.00		133.5	
10010- CAA	SAR Validation (Square, 100ms, 10ms)	X	2.51	65.57	10.47	10.00	20.0	$\pm 9.6\%$
		Y	2.40	65.09	10.16		20.0	
		Z	1.89	63.20	8.39		20.0	
10011- CAB	UMTS-FDD (WCDMA)	X	0.91	68.37	14.94	0.00	150.0	$\pm 9.6\%$
		Y	1.35	74.07	18.63		150.0	
		Z	0.82	66.98	14.05		150.0	
10012- CAB	IEEE 802.11b WiFi 2.4 GHz (DSSS, 1 Mbps)	X	1.06	64.24	15.41	0.41	150.0	$\pm 9.6\%$
		Y	1.17	65.38	16.46		150.0	
		Z	1.03	63.69	14.73		150.0	
10013- CAB	IEEE 802.11g WiFi 2.4 GHz (DSSS-OFDM, 6 Mbps)	X	4.62	66.97	17.24	1.46	150.0	$\pm 9.6\%$
		Y	4.73	66.91	17.24		150.0	
		Z	4.44	66.96	16.86		150.0	
10021- DAC	GSM-FDD (TDMA, GMSK)	X	100.00	113.69	27.59	9.39	50.0	$\pm 9.6\%$
		Y	15.92	88.65	20.46		50.0	
		Z	100.00	107.55	24.08		50.0	
10023- DAC	GPRS-FDD (TDMA, GMSK, TN 0)	X	100.00	113.26	27.45	9.57	50.0	$\pm 9.6\%$
		Y	10.59	83.36	18.82		50.0	
		Z	35.50	95.64	21.13		50.0	
10024- DAC	GPRS-FDD (TDMA, GMSK, TN 0-1)	X	100.00	110.83	25.00	6.56	60.0	$\pm 9.6\%$
		Y	100.00	107.89	23.67		60.0	
		Z	100.00	105.51	21.87		60.0	
10025- DAC	EDGE-FDD (TDMA, 8PSK, TN 0)	X	3.94	66.80	23.64	12.57	50.0	$\pm 9.6\%$
		Y	4.42	70.18	25.25		50.0	
		Z	3.29	63.55	21.61		50.0	
10026- DAC	EDGE-FDD (TDMA, 8PSK, TN 0-1)	X	8.10	88.70	31.28	9.56	60.0	$\pm 9.6\%$
		Y	8.90	90.14	31.40		60.0	
		Z	5.79	82.38	28.74		60.0	
10027- DAC	GPRS-FDD (TDMA, GMSK, TN 0-1-2)	X	100.00	109.25	23.40	4.80	80.0	$\pm 9.6\%$
		Y	100.00	106.54	22.28		80.0	
		Z	100.00	104.71	20.66		80.0	
10028- DAC	GPRS-FDD (TDMA, GMSK, TN 0-1-2-3)	X	100.00	107.37	21.81	3.55	100.0	$\pm 9.6\%$
		Y	100.00	106.10	21.41		100.0	
		Z	100.00	103.48	19.41		100.0	
10029- DAC	EDGE-FDD (TDMA, 8PSK, TN 0-1-2)	X	5.40	80.16	26.89	7.80	80.0	$\pm 9.6\%$
		Y	5.81	81.12	26.89		80.0	
		Z	3.99	74.82	24.51		80.0	
10030- CAA	IEEE 802.15.1 Bluetooth (GFSK, DH1)	X	100.00	107.75	23.04	5.30	70.0	$\pm 9.6\%$
		Y	100.00	105.38	22.04		70.0	
		Z	100.00	102.15	19.84		70.0	
10031- CAA	IEEE 802.15.1 Bluetooth (GFSK, DH3)	X	0.32	60.24	5.01	1.88	100.0	$\pm 9.6\%$
		Y	100.00	98.91	17.16		100.0	
		Z	0.21	60.00	4.08		100.0	

10032-CAA	IEEE 802.15.1 Bluetooth (GFSK, DH5)	X	49.70	283.71	16.38	1.17	100.0	± 9.6 %
		Y	100.00	94.28	14.55		100.0	
		Z	21.39	60.54	1.42		100.0	
10033-CAA	IEEE 802.15.1 Bluetooth (PI/4-DQPSK, DH1)	X	10.55	88.91	21.86	5.30	70.0	± 9.6 %
		Y	7.04	83.33	20.28		70.0	
		Z	5.31	79.96	17.86		70.0	
10034-CAA	IEEE 802.15.1 Bluetooth (PI/4-DQPSK, DH3)	X	1.97	70.15	12.93	1.88	100.0	± 9.6 %
		Y	3.62	77.97	16.97		100.0	
		Z	1.05	64.71	9.63		100.0	
10035-CAA	IEEE 802.15.1 Bluetooth (PI/4-DQPSK, DH5)	X	1.21	66.21	10.77	1.17	100.0	± 9.6 %
		Y	2.71	75.92	16.05		100.0	
		Z	0.74	62.66	8.21		100.0	
10036-CAA	IEEE 802.15.1 Bluetooth (8-DPSK, DH1)	X	16.37	95.16	23.78	5.30	70.0	± 9.6 %
		Y	9.05	87.03	21.55		70.0	
		Z	7.29	84.15	19.32		70.0	
10037-CAA	IEEE 802.15.1 Bluetooth (8-DPSK, DH3)	X	1.77	69.16	12.52	1.88	100.0	± 9.6 %
		Y	3.14	76.38	16.39		100.0	
		Z	0.98	64.10	9.34		100.0	
10038-CAA	IEEE 802.15.1 Bluetooth (8-DPSK, DH5)	X	1.24	66.70	11.11	1.17	100.0	± 9.6 %
		Y	2.88	76.97	16.58		100.0	
		Z	0.76	62.89	8.45		100.0	
10039-CAB	CDMA2000 (1xRTT, RC1)	X	0.64	62.07	7.96	0.00	150.0	± 9.6 %
		Y	4.76	84.60	18.89		150.0	
		Z	0.45	60.19	6.19		150.0	
10042-CAB	IS-54 / IS-136 FDD (TDMA/FDM, PI/4-DQPSK, Halfrate)	X	100.00	108.14	24.10	7.78	50.0	± 9.6 %
		Y	8.20	80.05	16.33		50.0	
		Z	9.72	81.12	15.57		50.0	
10044-CAA	IS-91/EIA/TIA-553 FDD (FDMA, FM)	X	0.00	65.80	22.18	0.00	150.0	± 9.6 %
		Y	0.05	126.22	5.06		150.0	
		Z	0.16	126.88	0.43		150.0	
10048-CAA	DECT (TDD, TDMA/FDM, GFSK, Full Slot, 24)	X	10.50	80.73	19.78	13.80	25.0	± 9.6 %
		Y	6.27	73.47	16.77		25.0	
		Z	6.57	72.48	15.23		25.0	
10049-CAA	DECT (TDD, TDMA/FDM, GFSK, Double Slot, 12)	X	13.23	86.11	20.42	10.79	40.0	± 9.6 %
		Y	6.76	76.65	16.75		40.0	
		Z	6.92	76.03	15.42		40.0	
10056-CAA	UMTS-TDD (TD-SCDMA, 1.28 Mcps)	X	12.01	87.16	22.22	9.03	50.0	± 9.6 %
		Y	8.86	82.28	20.46		50.0	
		Z	10.91	84.91	20.22		50.0	
10058-DAC	EDGE-FDD (TDMA, 8PSK, TN 0-1-2-3)	X	4.26	75.92	24.41	6.55	100.0	± 9.6 %
		Y	4.53	76.62	24.38		100.0	
		Z	3.28	71.52	22.33		100.0	
10059-CAB	IEEE 802.11b WiFi 2.4 GHz (DSSS, 2 Mbps)	X	1.12	65.70	16.18	0.61	110.0	± 9.6 %
		Y	1.24	66.83	17.14		110.0	
		Z	1.04	64.56	15.22		110.0	
10060-CAB	IEEE 802.11b WiFi 2.4 GHz (DSSS, 5.5 Mbps)	X	100.00	134.39	33.58	1.30	110.0	± 9.6 %
		Y	100.00	136.71	34.87		110.0	
		Z	12.40	108.39	28.07		110.0	

10061-CAB	IEEE 802.11b WiFi 2.4 GHz (DSSS, 11 Mbps)	X	4.70	89.70	25.19	2.04	110.0	± 9.6 %
		Y	4.44	87.85	24.54		110.0	
		Z	2.03	77.34	20.69		110.0	
10062-CAC	IEEE 802.11a/h WiFi 5 GHz (OFDM, 6 Mbps)	X	4.38	66.79	16.57	0.49	100.0	± 9.6 %
		Y	4.54	66.95	16.76		100.0	
		Z	4.22	66.86	16.25		100.0	
10063-CAC	IEEE 802.11a/h WiFi 5 GHz (OFDM, 9 Mbps)	X	4.41	66.93	16.69	0.72	100.0	± 9.6 %
		Y	4.56	67.04	16.83		100.0	
		Z	4.24	66.98	16.36		100.0	
10064-CAC	IEEE 802.11a/h WiFi 5 GHz (OFDM, 12 Mbps)	X	4.64	67.13	16.89	0.86	100.0	± 9.6 %
		Y	4.80	67.21	17.01		100.0	
		Z	4.45	67.14	16.54		100.0	
10065-CAC	IEEE 802.11a/h WiFi 5 GHz (OFDM, 18 Mbps)	X	4.53	67.01	16.99	1.21	100.0	± 9.6 %
		Y	4.68	67.08	17.07		100.0	
		Z	4.33	66.96	16.60		100.0	
10066-CAC	IEEE 802.11a/h WiFi 5 GHz (OFDM, 24 Mbps)	X	4.55	67.05	17.17	1.46	100.0	± 9.6 %
		Y	4.69	67.08	17.21		100.0	
		Z	4.34	66.93	16.73		100.0	
10067-CAC	IEEE 802.11a/h WiFi 5 GHz (OFDM, 36 Mbps)	X	4.86	67.41	17.69	2.04	100.0	± 9.6 %
		Y	4.98	67.30	17.64		100.0	
		Z	4.60	67.16	17.18		100.0	
10068-CAC	IEEE 802.11a/h WiFi 5 GHz (OFDM, 48 Mbps)	X	4.91	67.37	17.88	2.55	100.0	± 9.6 %
		Y	5.01	67.22	17.78		100.0	
		Z	4.67	67.20	17.41		100.0	
10069-CAC	IEEE 802.11a/h WiFi 5 GHz (OFDM, 54 Mbps)	X	4.98	67.41	18.07	2.67	100.0	± 9.6 %
		Y	5.09	67.26	17.97		100.0	
		Z	4.70	67.15	17.55		100.0	
10071-CAB	IEEE 802.11g WiFi 2.4 GHz (DSSS/OFDM, 9 Mbps)	X	4.74	67.09	17.56	1.99	100.0	± 9.6 %
		Y	4.83	66.96	17.50		100.0	
		Z	4.54	67.04	17.16		100.0	
10072-CAB	IEEE 802.11g WiFi 2.4 GHz (DSSS/OFDM, 12 Mbps)	X	4.71	67.40	17.79	2.30	100.0	± 9.6 %
		Y	4.80	67.26	17.69		100.0	
		Z	4.48	67.21	17.32		100.0	
10073-CAB	IEEE 802.11g WiFi 2.4 GHz (DSSS/OFDM, 18 Mbps)	X	4.81	67.70	18.18	2.83	100.0	± 9.6 %
		Y	4.87	67.45	18.00		100.0	
		Z	4.56	67.46	17.69		100.0	
10074-CAB	IEEE 802.11g WiFi 2.4 GHz (DSSS/OFDM, 24 Mbps)	X	4.84	67.73	18.37	3.30	100.0	± 9.6 %
		Y	4.88	67.39	18.13		100.0	
		Z	4.59	67.52	17.89		100.0	
10075-CAB	IEEE 802.11g WiFi 2.4 GHz (DSSS/OFDM, 36 Mbps)	X	4.89	67.79	18.64	3.82	90.0	± 9.6 %
		Y	4.92	67.45	18.38		90.0	
		Z	4.63	67.54	18.14		90.0	
10076-CAB	IEEE 802.11g WiFi 2.4 GHz (DSSS/OFDM, 48 Mbps)	X	4.95	67.71	18.84	4.15	90.0	± 9.6 %
		Y	4.96	67.32	18.54		90.0	
		Z	4.68	67.42	18.31		90.0	
10077-CAB	IEEE 802.11g WiFi 2.4 GHz (DSSS/OFDM, 54 Mbps)	X	4.99	67.84	18.96	4.30	90.0	± 9.6 %
		Y	5.00	67.42	18.65		90.0	
		Z	4.72	67.54	18.44		90.0	

10081-CAB	CDMA2000 (1xRTT, RC3)	X	0.35	60.00	5.91	0.00	150.0	± 9.6 %
		Y	0.93	68.99	12.63		150.0	
		Z	0.31	60.00	5.31		150.0	
10082-CAB	IS-54 / IS-136 FDD (TDMA/FDM, PI/4-DQPSK, Fullrate)	X	0.74	60.00	4.42	4.77	80.0	± 9.6 %
		Y	0.78	60.00	4.54		80.0	
		Z	0.63	60.00	3.21		80.0	
10090-DAC	GPRS-FDD (TDMA, GMSK, TN 0-4)	X	100.00	110.96	25.08	6.56	60.0	± 9.6 %
		Y	100.00	107.95	23.71		60.0	
		Z	100.00	105.61	21.93		60.0	
10097-CAB	UMTS-FDD (HSDPA)	X	1.73	68.88	15.45	0.00	150.0	± 9.6 %
		Y	2.11	71.60	17.53		150.0	
		Z	1.64	68.63	14.86		150.0	
10098-CAB	UMTS-FDD (HSUPA, Subtest 2)	X	1.69	68.83	15.43	0.00	150.0	± 9.6 %
		Y	2.06	71.60	17.53		150.0	
		Z	1.60	68.55	14.84		150.0	
10099-DAC	EDGE-FDD (TDMA, 8PSK, TN 0-4)	X	8.15	88.80	31.31	9.56	60.0	± 9.6 %
		Y	8.95	90.21	31.41		60.0	
		Z	5.83	82.50	28.78		60.0	
10100-CAE	LTE-FDD (SC-FDMA, 100% RB, 20 MHz, QPSK)	X	2.86	70.20	16.73	0.00	150.0	± 9.6 %
		Y	3.31	72.31	17.94		150.0	
		Z	2.70	69.79	16.38		150.0	
10101-CAE	LTE-FDD (SC-FDMA, 100% RB, 20 MHz, 16-QAM)	X	2.97	67.29	15.87	0.00	150.0	± 9.6 %
		Y	3.22	68.29	16.58		150.0	
		Z	2.86	67.20	15.57		150.0	
10102-CAE	LTE-FDD (SC-FDMA, 100% RB, 20 MHz, 64-QAM)	X	3.08	67.33	16.00	0.00	150.0	± 9.6 %
		Y	3.32	68.25	16.66		150.0	
		Z	2.97	67.28	15.71		150.0	
10103-CAF	LTE-TDD (SC-FDMA, 100% RB, 20 MHz, QPSK)	X	5.99	75.93	20.73	3.98	65.0	± 9.6 %
		Y	6.07	75.29	20.20		65.0	
		Z	4.92	73.90	19.72		65.0	
10104-CAF	LTE-TDD (SC-FDMA, 100% RB, 20 MHz, 16-QAM)	X	5.78	73.18	20.28	3.98	65.0	± 9.6 %
		Y	6.05	73.33	20.14		65.0	
		Z	4.95	71.50	19.26		65.0	
10105-CAF	LTE-TDD (SC-FDMA, 100% RB, 20 MHz, 64-QAM)	X	5.44	71.81	19.96	3.98	65.0	± 9.6 %
		Y	5.66	71.91	19.81		65.0	
		Z	4.62	69.93	18.84		65.0	
10108-CAF	LTE-FDD (SC-FDMA, 100% RB, 10 MHz, QPSK)	X	2.46	69.75	16.61	0.00	150.0	± 9.6 %
		Y	2.87	71.83	17.90		150.0	
		Z	2.29	69.26	16.18		150.0	
10109-CAF	LTE-FDD (SC-FDMA, 100% RB, 10 MHz, 16-QAM)	X	2.61	67.38	15.71	0.00	150.0	± 9.6 %
		Y	2.88	68.51	16.60		150.0	
		Z	2.50	67.30	15.35		150.0	
10110-CAF	LTE-FDD (SC-FDMA, 100% RB, 5 MHz, QPSK)	X	1.94	69.06	15.97	0.00	150.0	± 9.6 %
		Y	2.36	71.54	17.68		150.0	
		Z	1.77	68.41	15.33		150.0	
10111-CAF	LTE-FDD (SC-FDMA, 100% RB, 5 MHz, 16-QAM)	X	2.37	68.86	15.85	0.00	150.0	± 9.6 %
		Y	2.75	70.67	17.33		150.0	
		Z	2.26	68.83	15.37		150.0	