



allegro³

owner's manual

Copyright © January 2018 Juniper Systems, Inc. All rights reserved. Information is subject to change without notice.

Juniper Systems® is a registered trademark of Juniper Systems, Inc. Allegro™, Allegro Field PC™, Geode Connect™, Barcode Connector™, and RFID Connector™ are recognized trademarks of Juniper Systems, Inc.

Android™ is a trademark of Google Inc.

The *Bluetooth*® word mark is owned by the Bluetooth SIG, Inc. and any use of such marks by Juniper Systems, Inc. is under license.

Google Earth™ mapping service is a trademark of Google, Inc.

The names of other companies and products mentioned herein may be the trademarks of their respective owners.



WARNING! This symbol indicates that failure to follow directions could result in serious injury.



CAUTION: This symbol indicates that failure to follow directions could result in damage to equipment or loss of information.

Part Number 28124-00-C



tel: 435.753.1881 | web: www.junipersys.com
1132 W. 1700 N. Logan, UT 84321

Contents

1 Getting Started

The Anatomy of the Allegro 3	2
Perform Initial Tasks	3
Turn the Allegro 3 on and Off	6

2 Standard Features

Operating System	8
Display and Touchscreen	9
Keyboard Features	10
Power Management	11
LED Activity Indicators	12
Data Storage Options	13
Connector I/O Module	14
Audio Features	14
Sleep, Power Off, Lock up, and Recovery	15
Bluetooth ® Wireless Communication	17
Wi-Fi Wireless Networking	18

3 3G Data Modem

GSM Modem	20
Connection Problems	22
Wireless Safety	22
Maintenance of Your Modem	22

A Storage, Maintenance and Recycling

Storing the Allegro 3 and Battery Pack	24
Protecting the Touchscreen	25
Cleaning the Allegro 3	25
Recycling the Allegro 3 and Batteries	26

B Warranty and Repair Information

Limited Product Warranty	28
Extended Warranties	30
Repairing the Allegro 3	31

C Warnings and Regulatory Information
Product Warnings.....34
Certifications and Standards.....35

D Specifications
Allegro 3 Rugged Handheld Specifications.....40

Index



1 Getting Started

Getting Started

The Allegro 3 Rugged Handheld™ powered by Android features *Bluetooth*, Wi-Fi and an alphanumeric keyboard. Standard accessories include a lithium-ion battery pack, AC wall charger, USB micro client sync cable, hand strap, and a capacitive blunt tip stylus and tether. A camera, GPS/GNSS, and cellular data modem are options.

The Anatomy of the Allegro 3 Front and Back Features



- 1 Bumper, Top
- 2 Touchscreen
- 3 Function Keys
- 4 Numeric Keyboard
- 5 LED Indicators
 - red charging indicator
 - green notifications/
programmable indicator, blue
programmable indicator
- 6 QWERTY Keyboard
- 7 Microphone
- 8 Power Key
- 9 Attachment Point for Stylus
Tether and other items (1 of 2)
- 10 Expansion Door
- 11 Camera Lens (option)
- 12 Camera Flash and Flashlight
Window (option)
- 13 Speaker
- 14 Door to Battery Compartment
and Card Slots
- 15 Screw Holding Battery Door in
Place (1 of 4 captive screws)
- 16 Hand Strap Attachment Point (1
of 2 on the back)

Battery Compartment and Card Slots

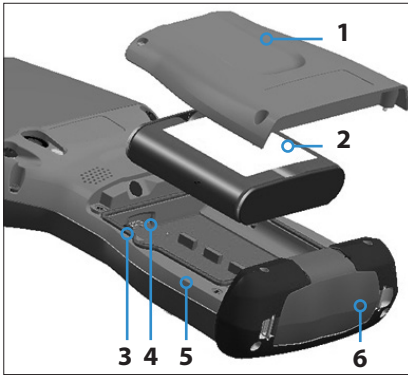

- 1 Battery Door, Screws
- 2 Battery Pack
- 3 Mini SIM Card Slot
- 4 Micro SD/SDXC Card Slot
- 5 Battery Compartment
- 6 Connector Module Protector

Connector I/O Module

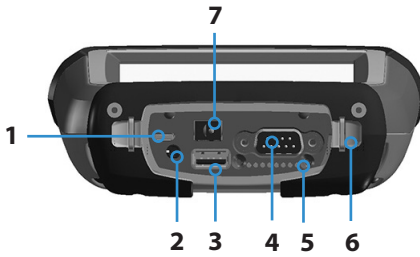

- 1 USB Client, Micro B
- 2 Audio Jack, for Microphone, Speaker, or Stereo Output, 3.5mm
- 3 USB Host, Full Size A
- 4 9-pin Serial Port, 5VDC @ 500 mA
- 5 Docking Pin Contacts
- 6 Hand strap Attachment Point
- 7 Power Input Jack, 12-24VDC, for Power and Battery Charging

Perform Initial Tasks

When you receive your Allegro 3, perform the tasks outlined in this section before first use.

Review Documentation

A direct link to this manual posted on our website is located in *Settings > Device status > User's Manual*. The manual will be updated during the life of the Allegro 3. Compare version numbers to see if a document has changed.

Other documents including a quick start guide, release notes, and product literature are available on our website in PDF format. A wealth of other user information is also posted there. Go to: <http://www.junipersys.com/Juniper-Systems-Rugged-Handheld-Computers/products/Allegro-3>.

Apply a Screen Protector (Optional)

The touchscreen is extremely scratch-resistant, so a screen protector is not included with the Allegro 3. If you decide to apply one, refer to the installation instructions included with the screen protector for specific details.

Install the Battery Pack, SD Card, and Mini SIM Card

The Allegro 3 uses a rechargeable Li-Ion battery pack. Install and charge the battery pack using the instructions that follow.

! **CAUTION:** Always power off the handheld before removing the battery. Failure to do so may cause loss of data or damage to the handheld.

1. The battery compartment is accessed from the back of the handheld. Loosen the four captive screws holding the battery compartment door in place using a #1 Phillips screwdriver. Remove the door.

! **CAUTION:** The Allegro 3 is not sealed against water and dust when the battery door is not installed.

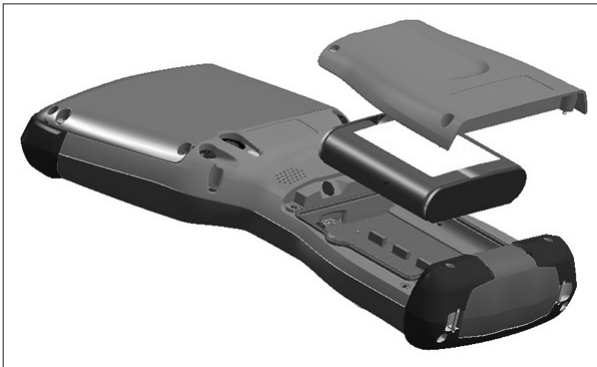

2. If you are using a micro SD card for additional memory or a mini SIM card with the 3G Data Modem (optional), you can install them now before you install the battery pack, or at another time. See more details about these cards later in this manual.

3. Place the Li-Ion battery pack in the compartment. Make sure the + and - symbols on the battery pack label align with the symbols inside the compartment.

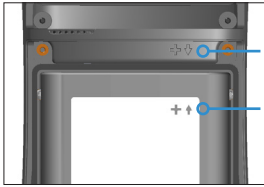

Line up the symbols on the case and the battery pack as shown

4. Replace the door and tighten the screws.
5. Plug the AC wall power charger that came with the Allegro 3 into a wall socket. Plug the other end into the DC power jack on the Allegro 3. The red LED on the keyboard blinks when the battery pack is charging. Charge the battery pack for 4-6 hours at room temperature.

Attach the Hand Strap and Stylus Tether

A hand strap, capacitive blunt tip stylus, and tether are included with the handheld.

Note: A stylus is not required to use the touchscreen. The optimal way to make selections is by finger touch.

If the hand strap and stylus are not attached at the factory or you want to move it to the other side, view the following image to see how to attach them.



Turn the Allegro 3 on and Off

To turn the Allegro 3 on, press and release the power key. The handheld powers on and begins the startup process. This takes several seconds. When it is complete, the Lock screen is shown. Swipe up on this screen to unlock it. The primary Home screen is shown.



2 Standard Features

Standard Features

This chapter discusses the standard features included on all Allegro 3 models.

Operating System

This Allegro 3 is powered by the Android operating system. If you need additional information about Android, there is a wealth of information on the internet.

Home Screen

The Home screen consists of the following elements:

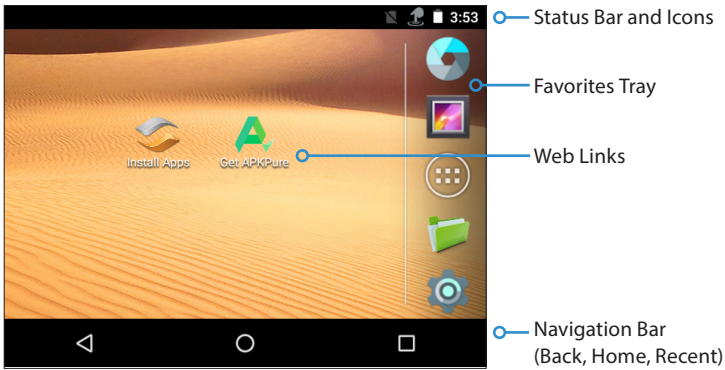

Power Off or Restart

Press and briefly hold the power button. You are asked if you want to *Power Off* or *Restart*.

Note: The display automatically goes to sleep after a set amount of time passes (you can adjust this in Settings). Press the power key and the lock screen appears. After you swipe up, the last screen that was opened is shown.

Quick Settings and Notifications

Touch and hold the status bar from any screen to see the Notification drawer. Any notifications you should see are shown underneath the drawer. Swipe down twice from the drawer and the Quick Settings tray is shown which lets you to adjust some settings (screen brightness) and toggle

certain apps on and off (*Bluetooth*). Swipe left to see more options. To close it, swipe the tray up.

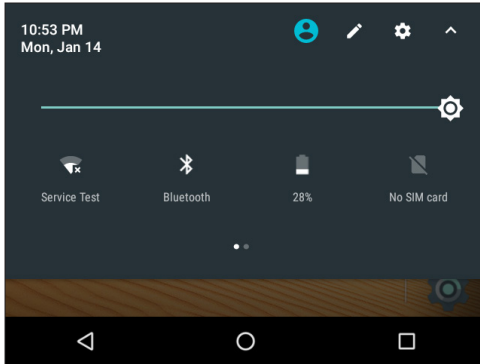

Operating System Languages

The Android operating system is available in multiple languages. Select *Settings > Languages & input > Language* to view the options and make a selection. Some unique Mesa 2 settings and apps like Touch Control and the Barcode Connector are only available in English.

Display and Touchscreen

The Allegro 3 has a bright color display and capacitive touchscreen. It is easy to view outdoors and is sealed against water and dust. The Allegro 3 recognizes touch gestures, making it easy to use a finger to make selections and navigate. You can also use the fine tip capacitive stylus included with the Allegro 3 or optimize it for wet conditions.

To adjust display settings including the font size, brightness, sleep interval, orientation, go to *Settings > Display*.

Touchscreen Touch Control Setting

To adjust the Touchscreen Control setting, go to *Settings > Touch Control*. Select the profile you want the screen optimized for: Finger, Stylus, or Wet. As the new profile loads, a progress bar is shown. You can try different profiles to see which one works best for the conditions the Allegro 3 is being used in.













Note: When using the Allegro 3 in wet conditions, you must use your finger or the blunt tipped stylus that is included.



A hard-tipped stylus will not work. Other third party styli might work with the Mesa 2 touch profiles, but we cannot guarantee it.

Keyboard Features

The Allegro 3 has a numeric keypad, function keys, and a QWERTY keyboard. The keys are sealed and have backlight illumination. Some keys are programmable.

Special Keys

	Back
	Back-space (Delete) Blue function: Enable or disable touchscreen
	Enter (return) Blue function: Select OK or X on the screen
	Move left Blue function: volume down
	Move right Blue function: volume up
	Move up Blue function: brightness up
	Move down Blue function: brightness down
	Action
	Home screen
	Blue command (sticky on second press)
	Left tab (back)
	Right tab (forward)
	Overview

	<p>Shift command</p> <ul style="list-style-type: none"> ■ Shift, one key press ■ CAPS lock, two key presses ■ Release CAPS lock, three key presses ■ Shift + numeric key press to get special characters: 1=!, 2=@, 3=#, 4=\$, 5=%, 6=^, 7=&, 8=*,9=(, 0=)
	<p>Power</p> <ul style="list-style-type: none"> ■ Suspend or resume, one key press ■ Open Power Menu, press and hold

Power Management

The Allegro 3 uses a Li-Ion rechargeable battery pack.

! **CAUTION:** Only use batteries designed for the Allegro 3 from an approved vendor. Use of non-approved batteries may void your product warranty.

Charging the Battery Pack

To charge the battery pack, suspend the handheld, then refer to the instructions in *Chapter 1, Getting Started*. It typically takes 4 to 6 hours to fully charge a battery pack.

We recommend that you keep the handheld battery pack charging when it is not in use for up to two weeks. When you plug the handheld into the wall charger that comes with it, the batteries are prevented from being overcharged.

The Li-Ion battery pack is charged most efficiently at room temperature (68°F or 20°C). The battery pack will not charge if it is too hot or too cold.

! **CAUTION:** The Allegro 3 is not sealed against water and dust when the battery door is not installed properly.

Battery Life

Battery life on a full charge can be 20 hours or more. This varies depending on the applications used, backlight usage, and radio usage.

Battery packs last approximately 1,000 to 3,000 charging cycles before they need to be replaced. This is impacted by applications and environmental factors.

The Allegro 3 is designed to run in either of two power states, battery power, or external power with battery installed. The unit is not designed to run on external power without a battery. Doing so can damage internal components of your unit and void the warranty.

Summary of Options to Reduce Power Usage

You can adjust some settings to preserve power:

- Turn off the display (suspend) after a set interval.
- Dim the backlight after a set interval.
- Disable radios when not in use.

LED Activity Indicators

LED activity indicators are located on the keyboard on the left side shown in the following image:



- Red LED on the bottom (associated with power adapter):
Blinking - AC adapter is plugged in, and the battery is charging
Solid - AC adapter is plugged in, and the battery is full (not charging)
- Green LED on the top (associated with notifications):
When the operating system has something to notify you of, this LED behaves accordingly. For example, if you turn on GPS/GNSS the green LED blinks periodically. Blue LED in the same location as the green LED (the blue and green LEDs can not be shown simultaneously): The Blue LED is not tied to a key or a notification by default.

Data Storage Options

Flash Data Storage

The Allegro 3 has 16 GB of internal flash data storage. Go to *Settings > Storage* to see how much storage is available, and how it is being used (storing Apps or Images, for example).

SD Card Slot

Additional storage can be added with an SD/SDXC card. The SD card slot is located in the battery compartment. To insert or remove a card, follow these steps:

! **CAUTION:** Always power off the handheld before removing the battery. Failure to do so may cause loss of data or damage to the handheld.

1. Power off the handheld by holding the power button until the Power Button menu appears and selecting Power Off. Ensure that your unit is not plugged in to external power.
2. Loosen the screws to the battery compartment, and remove the door. The hand strap remains attached.

! **CAUTION:** The Allegro 3 is not sealed against water and dust when the battery door is not installed properly.

3. Remove the battery pack.
4. An image on the battery compartment label shows the correct location and orientation for the SD card (slot on the right). Push the card into the slot to insert it.

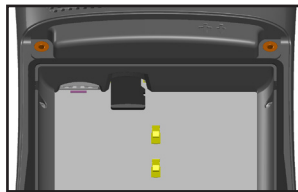

5. Replace the battery pack, and attach the battery door.
6. Power up the handheld.

Connector I/O Module

The Allegro 3 connector I/O module has the following jacks and connectors:

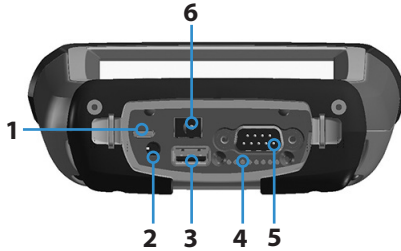

1. USB client, micro B
2. Audio jack: 3.5mm; supports speaker, microphone or stereo output (pin detect)
3. USB host, full size A
4. Docking pin contacts
5. 9-pin serial port, D-sub connector, 5VDC @500 mA
6. Power input jack: 12 to 24VDC for power input and battery charging

The connector I/O module is user-replaceable. Contact our sales department or your supplier for details.

Note: The connectors are sealed. A connector protector is not required to prevent water ingress. It protects the connectors from exposure to excessive dust and dirt.

Audio Features

The Allegro 3 has the following audio features:

- Speaker - The speaker sound is loud and clear. Listen to audio notes, video sound, and music files.
- Microphone - Use the microphone to record audio notes or add sound to a video when using the camera (option).
- Audio Jack - The audio jack supports a stereo headset or headset/microphone combination with 3.5 mm connections.

Sleep, Power Off, Lock up, and Recovery

Putting the Allegro 3 to Sleep

The Allegro 3 goes to sleep after a minute by default. When the tablet is in a sleep state, it is still powered, but in a minimum run state.

1. To put the Allegro 3 to sleep, press and release the power key. While the screen immediately darkens, may take a minute or more to reduce power consumption to its lowest level.
2. To wake the Allegro 3 from a sleep state, press and release the power key again. When it is awakened, the tablet shows the Lock screen.
3. You can change the sleep default setting by going to *Settings > Display > Sleep* and selecting a value from 15 seconds up to 30 minutes.

Powering Off and Restarting the Mesa 2

To preserve battery power, we recommend you power off the Allegro 3 if it will not be used over a long weekend or for several days.

1. Press and hold the power button for 2-3 seconds.
2. A menu appears with *Power off* and *Restart* options. Tap *Power off*.
3. Powering off the handheld can take from a few seconds up to a minute or more to complete. When the Allegro 3 is powered off, no lights are evident and the display is dark.
4. To restart the Allegro 3, hold down the power button for 2-3 seconds. While it is restarting, some graphics are shown, and then you see the Lock screen. Swipe up and the Home screen appears.

 **CAUTION:** Be aware that when the Allegro 3 is powered off, it closes all programs and powers down all system components.

Powering Off for Long-Term Storage

To power off the Allegro 3 for long-term storage (two weeks or more), follow these steps:

1. Power off the Allegro 3 as described in the previous section.
2. Press and hold the power button for 20 seconds. This disconnects the batteries from the system.
3. Take out the battery pack and store it in a cool, dry location.
4. When you are ready to power on the Allegro 3, replace the battery pack. Plug in the AC wall charger and connect it to the Allegro 3 BEFORE you power it on. Hold down the power button for 2-3 seconds until the Lock screen is shown.

How to Handle a Locked Up Unit

If the Allegro 3 is completely stuck and won't respond, hold the power key down for 2 to 3 seconds to see if the menu with the "Power off" option appears, and select that operation. If that doesn't work, hold the power key down for 10 seconds. This causes a hardware shut off. Press the power key again to power it on.

If 10 seconds doesn't work, hold the power button down for 20 seconds. The battery pack is forced to electrically disconnect from the Allegro 3, causing a complete shut down. The handheld cannot be powered on again until it is plugged in with the AC wall charger. Keep this in mind if you are in the field.



CAUTION: Forcing a shut-down while the unit is running can cause damage to the device. NEVER do this to power off an Allegro 3 in normal circumstances.

Recovery or Factory Reset

The Allegro 3 can be restored to the factory state with all user data removed from the unit.

In order to perform the Factory Reset, go to *Settings > Backup & Reset > Factory Data Reset*. You are presented with a screen describing all of the data that will be removed

from the device. Tap *RESET TABLET* at the bottom of the screen to begin the process. This operation can take up to an hour for some models. When the process is complete, all changes that have been made by the user are removed.

Bluetooth® Wireless Communication

The Allegro 3 has built-in *Bluetooth*® wireless technology, allowing you to connect it to other wireless devices with *Bluetooth* technology. Minimum performance between similar objects in an unobstructed environment is approximately 100 feet (30 meters).

Creating a Partnership/Pairing a Bluetooth Device

To create a partnership between the Allegro 3 and another device with *Bluetooth* technology, follow these steps:

1. Turn both devices on.
2. Place them within at least 100 feet (30 meters) of each other.
3. Make *Bluetooth* discoverable on both devices. *Bluetooth* on the Allegro 3 is off by default. To activate it, go to *Settings > Bluetooth*. You can also pull down the Quick Settings Tray and tap the *Bluetooth* symbol to turn it on. Tap the word *Bluetooth* underneath the symbol. A list of discoverable devices is shown. Tap *MORE SETTINGS* to go to the settings screen.
4. In the *Bluetooth* settings screen, a list of all *Bluetooth* devices within range is shown. Tap on the name of the device in the list you would like to pair with. A *Bluetooth* pairing request box is shown. If prompted, enter the PIN or pass code of the device you want to pair with. You should now be paired with the device.

Note: If Bluetooth is on and the Allegro 3 enters sleep mode, Bluetooth turns off to save battery power. The connection is resumed once it powers back on.

Wi-Fi Wireless Networking

The Allegro 3 has built-in Wi-Fi wireless networking to connect to the internet or an office network.

Connecting to a Wi-Fi Network

To use Wi-Fi, you need to be in range of a Wi-Fi access point to make a connection. To set up Wi-Fi, follow these steps:

1. Go to *Settings > Wi-Fi* and tap *Off* in the upper left hand corner to toggle it on. You can also pull down the Quick Settings Tray and tap the *Wi-Fi* symbol to turn it on. Tap the word *Wi-Fi* underneath the symbol. A list of discoverable devices is shown. Tap *MORE SETTINGS* to go to the settings screen.
2. The Mesa 2 automatically starts scanning the area for available Wi-Fi networks. A list is shown. Select the network you want to use and enter the network password (for locked networks). The Allegro 3 remembers the Wi-Fi network connections created.
3. Wi-Fi can be turned off and on and settings can be managed from *Settings > Wi-Fi* screen. Tap the network you selected to view information like *Link speed*. Tap and hold to view other options like *Modify network*.

Note: Android does not support shared key WEP.



3 4G Data Modem

4G Data Modem

The 4G data modem is an option for Allegro 3 Geo models, adding Wide Area Network data modem capability. The modem is installed at the factory.

The modem is a cellular data modem, 4G LTE with 3G HSPA+ fallback, type GSM/UMTS. It is five band modem compatible. The modem operates in different modes, depending on the wireless provider and the signal strength. Data speeds vary anywhere from 10 or 20 Kbps when using GPRS to over 1 Mbps when using HSDPA.

GSM Modem

The GSM modem is a cellular data modem, type GSM/UMTS. It provides data transmission in the United States, as well as internationally.

Set up a Data Account with a Wireless Provider

Contact a wireless provider to set up data service for the cellular data modem and obtain an account and mini SIM card (purchased separately). You need to provide the following information when setting up an account:

1. Billing Information and business ID, such as your Federal Tax I.D. or VAT number.
2. The wireless services required. Specify that you need data service only. You do not need voice or messaging services.
3. You may be asked for the modem's IMEI number, which can be found here: Settings > About this device > Network and Radio Information > IMEI information. The modem should be powered on.
4. You may be asked to provide the modem's model number. This number allows the carrier to verify this modem as one of its approved models. If asked for this by the carrier, it is a Juniper Systems Allegro 3.

Install the SIM Card

To insert or remove a card, follow these steps:

! **CAUTION:** Always power off the handheld before removing the battery. Failure to do so may cause loss of data or damage to the handheld.

1. Power off the handheld by holding the power button until the Power Button menu appears and selecting Power Off. Ensure that your unit is not plugged in to external power.
2. The mini SIM card slot is located in the battery compartment. Loosen the screws to the door and remove it.

! **CAUTION:** Do not use a micro SIM adapter. The adapter can get stuck and damage the slot.

3. Remove the battery pack.

! **CAUTION:** The Allegro 3 is not sealed against water and dust when the battery door is not installed.

4. An image on the battery compartment label shows the correct location and orientation for the mini SIM card. Pull out the SIM card tray. Place the card onto the tray and push the tray in until it catches.

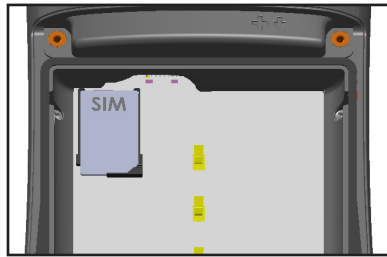

To remove the SIM card, pull the tray open and remove the card. Push the empty tray in until it catches.

5. Replace the battery pack, and attach the battery door.
6. Power on the Allegro 3.
7. You can now access the Internet. Open Internet Explorer to test your setup.

To remove the SIM card, gently pull it out with tweezers or a piece of tape.

Connection Problems

If the connection fails to automatically configure, there might not be a signal where you are located. You can try repeating the set up process.

Wireless Safety

RF Interference Issues

It is important to follow any special regulations regarding the use of radio equipment due in particular to the possibility of radio frequency (RF), interference. Follow the safety advice given below carefully.

- Switch OFF your cell modem when in an aircraft. The use of cellular telephones in an aircraft may endanger the operation of the aircraft, disrupt the cellular network and is illegal.
- Switch OFF your cell modem in hospitals and any other place where medical equipment may be in use.
- Respect restrictions on the use of radio equipment in fuel depots, chemical plants or where blasting operations are in progress.
- Operating your cell modem close to inadequately protected personal medical devices, such as hearing aids and pacemakers, could be hazardous. Consult the manufacturers of the medical device to determine if it is adequately protected.
- Operation of your cell modem close to other electronic equipment may also cause interference if the equipment is inadequately protected. Observe any warning signs and manufacturers' recommendations.
- Do not place the cell modem alongside computer discs, credit or travel cards, or other magnetic media. The modem may affect the information contained on discs or cards.

Maintenance of the Modem

Do not attempt to disassemble the cell modem. No user serviceable parts exist inside the cell modem.



A

Storage, Maintenance and Recycling

Storage, Maintenance, and Recycling

Follow the instructions in this chapter to properly maintain and recycle the Allegro 3.

Storing the Allegro 3 and Battery Pack

When the handheld is not being charged and is suspended, it draws a small amount of power. This power draw is used to maintain the memory (RAM) of the handheld in the same state it was when it was suspended. We recommend charging the handheld each night or weekend when it is in suspend mode.

If the Allegro 3 is not charged while in suspend mode and the battery reaches a low charge, it automatically powers off to prevent further drain on the battery.

Note: Data and programs are secure as long as they have been saved, even if the battery pack becomes discharged. The handheld does not depend on the battery to store the data for extended periods.

Storing the Allegro 3 for Less Than Two Weeks

To store the handheld for less than two weeks, complete the following steps:

1. Close all applications.
2. Plug the handheld into the AC wall adapter that was shipped with your unit.

Storing the Allegro 3 for More than Two Weeks

To store the handheld for two weeks or more, complete the following steps:

1. Charge the battery pack 30 to 50 percent.
2. Close all running programs, and turn off the handheld.



CAUTION: Always perform Power Off before removing battery. Failure to do so may cause loss of data or damage to handheld.

3. Remove the battery pack.
4. Place the battery pack in a dry location.

Protecting the Touchscreen

Protect the touchscreen from impact, pressure, or abrasive substances that could damage it. To further protect the touchscreen, apply a screen protector (optional accessory). To apply a screen protector, follow the directions that come with it in the package.



- ⚠ **CAUTION:** Be sure to replace the screen protector as often as the screen protector instructions recommend.

Cleaning the Allegro 3

Touchscreen

1. Disable the touchscreen by pressing the power key  until the Power Key menu appears. Tap on *Disable TS*.
2. Remove the screen protector if you want to clean underneath it.
3. Apply warm water or a mild cleaning solution to a microfiber cloth and gently wipe off the touchscreen.

- ⚠ **CAUTION:** Do not use tissues, paper towels, soft bristle brushes, or harsh cleaning solutions on the touchscreen.

4. Rinse the touchscreen with water and dry it with a microfiber cloth.
5. Apply a screen protector if you want to (not included). To clean a screen protector, follow the instructions provided with the package.
6. To enable the touchscreen, press and hold the power key  to display the Power Key menu. Use the down arrow key  to highlight *Enable TS*, and press enter .

Case, Bumpers, and Connector Module

Make sure the battery door is securely installed. Use warm water, a mild cleaning solution, and a soft bristle brush to clean the case, bumpers, and connector module.

- ⚠ **CAUTION:** Do not direct a high-pressure stream of water at the device to clean it. This action could break the seal, causing water to get inside the device and voiding the warranty.

Safe Cleaners to Use

You can clean the Allegro 3 safely with the following cleaners:

- Windex® (S.C. Johnson & Son, Inc.)
- Formula 409® (Clorox)
- Citrus Wonder, Organic Cleaner (Mer-Maids)
- Citrus All Purpose Cleaner (Wonder Tablitz)
- Greased Lightening® Multi-Purpose Cleaner and Degreaser
- Orange Clean® (Orange Glo International)
- Fantastik® OxyPower® (S.C. Johnson @ Son, Inc.)
- Oil Eater Orange Cleaner Citrus Degreaser (Kafko Intl., Ltd.)



CAUTION: Exposure to some cleaning solutions may damage your device, including automotive brake cleaner, isopropyl alcohol, carburetor cleaner, and similar solutions. If you are uncertain about the strength or effect of a cleaner, apply a small amount to a less visible location as a test. If any visual change becomes apparent, promptly rinse and wash with a known mild cleaning solution.

Recycling the Allegro 3 and Batteries

When the Allegro 3 reaches the end of its life, it must not be disposed of with municipal waste. It is your responsibility to dispose of your waste equipment by handing it over to a designated collection point for the recycling of waste electrical and electronic equipment. If you cannot find a location, contact Juniper Systems for information about disposal.

The Li-Ion battery packs for your Allegro 3 are recyclable. Avoid placing them in the trash or municipal waste system. To find the nearest battery recycling center in the USA, one option is to contact the Rechargeable Battery Recycling Corporation, www.call2recycle.org.



B

Warranty and Repair Information

Limited Product Warranty

Juniper Systems, Inc. ("JS") warrants that the Allegro 3 Rugged Handheld shall be free from defects in materials and workmanship, under normal intended use, for a period of 24 months from the date of shipment.

JS warrants that the following items shall be free from defects in materials and workmanship, under normal intended use, for a period of ninety (90) days from the date of shipment:

- battery packs,
- media containing the Allegro 3 programs,
- desktop computer programs,
- user documentation, and
- accessories.

Warranty Exclusions

This warranty shall not apply if:

- (i) the product has been set up improperly or has been improperly installed or calibrated,
- (ii) the product is operated in a manner that is not in accordance with the user documentation,
- (iii) the product is used for a purpose other than for which it was designed,
- (iv) the product has been used in environmental conditions outside of those specified for the product,
- (v) the product has been subject to any modification, alteration, or change by or on behalf of customer (except and unless modified, changed or altered by JS or under direct supervision of JS),
- (vi) the defect or malfunction results from misuse or accident,
- (vii) the serial number on the product has been tampered with or removed, or
- (viii) the product has been opened or tampered with in any way.

This warranty is exclusive and JS will not assume and hereby expressly disclaims any further warranties, whether express or implied, including, without limitation, any warranty as to merchantability, fitness for a particular purpose, non-infringement or any warranties arising from the course of performance, dealing, or usage of trade. JS specifically makes no warranties as to the suitability of its products for any particular application. JS makes no warranties that

- its products will meet your requirements or will work in combination with any hardware or applications software products provided by third parties,
- the operation of its products will be uninterrupted or error free, or
- all defects in the product will be corrected.

JS shall not be responsible for software, firmware, information, or memory data contained in, stored on, or integrated with any products returned to JS for repair, whether under warranty or not.

Remedy

In the event a defect in materials or workmanship is discovered and reported to JS within the specified warranty period, JS will, at its option, repair the defect or replace the defective part or product. Replacement products may be new or reconditioned. JS warrants any replaced or repaired product for a period of ninety (90) days from the date of return shipment, or through the end of the original warranty period, whichever is longer.

Limitation of Liability

To the fullest extent allowed by law, the obligation of JS shall be limited to the repair or replacement of the product. JS shall in no event be liable for special, incidental, or consequential, indirect, special or punitive damages of any kind, or for loss of revenue or profits, loss of business, loss of information or data, or other financial loss arising out of or in connection with the sale, installation, maintenance, use, performance, failure, or interruption of any product. Any

responsibility and/or liability of JS shall, in connection with a warranted product, be limited in the maximum amount to the original purchase price.

Warranty Repairs

To obtain warranty repair or service on the Allegro 3, submit a repair order on our website at <http://www.junipersys.com/Juniper-Systems/support/Repairs> or contact an authorized repair center within the applicable warranty period.

Products returned for repair or service without proper authorization may acquire an additional handling fee and/or delay in the repair. The customer is responsible to prepay all shipping costs when sending equipment to a repair center. The repair center will return the repaired equipment by the same method it was received with costs of shipping prepaid.

Governing Law

This warranty is governed by the laws of Utah, U.S.A. and excludes the United Nations Convention on Contracts for the International Sale of Goods. The courts of Utah shall have exclusive personal jurisdiction in case of any disputes arising out of or in connection with this warranty.

Services and Materials Provided Under Warranty

- Analysis of problem by service technician
- Labor and materials required to fix defective parts
- Functional analysis performed after repair
- Repair turnaround within 10 working days of receipt unless special circumstances exist
- Shipping costs to return device to customer

Extended Warranties

The Allegro 3 can be warranted up to 5 years (including the standard warranty period) through the purchase of an extended warranty.

Extended warranties apply only to the Allegro 3, not battery packs, media containing the Allegro 3 programs, desktop computer programs, user documentation, and accessories.

Parts that are excessively worn are not covered under all warranty plans. These may include, but are not limited to, the keyboard elastomer and switch matrix, hand straps, touchscreens, and connector modules.

Warranty Information

Warranty information for the Allegro 3 Rugged Handheld is located on our website at <http://www.junipersys.com/Juniper-Systems/support/Warranty>. You can evaluate and order warranty extensions, check warranty status, and view warranty terms and conditions.

Repairing the Allegro 3



CAUTION: Do not attempt to repair the Allegro 3 yourself. This action voids the warranty.

Information about repairs, upgrades, and evaluations is located on our website at <http://www.junipersys.com/Juniper-Systems/support/Repairs>. You can locate a repair center, submit a repair order, check repair status, view terms and conditions, get shipping instructions, and view lead times.

Before returning a unit, please get permission by submitting a repair order from our website and waiting for confirmation or by contacting a repair center directly. Be prepared to provide the following information:

- Product serial number (inside the battery compartment; also found in System Information screen as described on the following page)
- Your name
- Name and shipping address of company/university/agency
- Best contact method (phone, fax, email, cell/mobile)
- Clear, highly-detailed description of the repair or upgrade
- Credit card/ purchase order number and billing address (for a repair or upgrade that is not covered by the standard warranty or an extended warranty policy)

System Information for your Allegro 3

When you contact a repair center, you need some unique system ID information for your Allegro 3 (serial number, model number, etc.). Go to *Settings > About this device*. Information about software, hardware, the battery, the network and radio, regulatory information, and legal information can be viewed.



C Warnings and Regulatory Information

Product Warnings

Follow the warnings listed below to use the AG3 (Allegro 3) and accessories safely.



Battery Warnings

WARNING! This device comes with a lithium ion rechargeable battery pack. To reduce the risk of fire or burns, do not disassemble, crush, puncture, short external contacts, or expose the battery pack to fire.

Do not disassemble or open, crush, bend or deform, puncture or shred.

Do not modify or remanufacture, attempt to insert foreign objects into the battery, immerse or expose to water or other liquids, expose to fire, explosion or other hazard.

Only use the battery for the system for which it is specified.

Only use the battery with a charging system that has been qualified with the system per this standard. Use of an unqualified battery or charger may present a risk of fire, explosion, leakage, or other hazard.

Do not short circuit a battery or allow metallic conductive objects to contact battery terminals.

Replace the battery only with another battery that has been qualified with the system.

Use of an unqualified battery may present a risk of fire, explosion, leakage or other hazard.

Promptly dispose of used batteries in accordance with local regulations.

Battery usage by children should be supervised.

Avoid dropping the battery. If the battery is dropped, especially on a hard surface, and the user suspects damage, take it to a service center for inspection.

Improper battery use may result in a fire, explosion or other hazard.



Wall Charger Warnings

WARNING! To reduce the risk of personal injury, electrical shock, fire or damage to the equipment:

Plug the wall charger into an electrical outlet that is easily accessible at all times.

Do not place anything on the wall charger cord or any of the other cables. Arrange them so that no one may accidentally step on or trip over them.

Do not pull on a cord or cable. When unplugging the wall charger from the electrical outlet, pull on the plug, not the cord.

Use only wall chargers intended for the Allegro 3. Using any other external power source can damage your product and void your warranty.

Certifications and Standards

FCC - United States

In compliance with the FCC rules 47 CFR 15.19(a)(3), the statements that follow must appear on the device or in the user documentation.

This device complies with Part 15 of the FCC Rules. Operation is subject to the following two conditions:

1. The device may not cause harmful interference.
2. This device must accept any interference received, including interference that may cause undesired operation.

In compliance with the FCC rules, 47 CFR 15.105(b), the user must be notified that this equipment has been tested and found to comply with the limits for a Class B digital device, pursuant to part 15 of the FCC Rules. These limits are designed to provide reasonable protection against harmful interference in a residential installation. This equipment generates, uses and can radiate radio frequency energy and, if not installed and used in accordance with the instructions, may cause harmful interference to radio communications. However, there is no guarantee that interference will not occur in a particular installation. If this

equipment does cause harmful interference to radio or television reception, which can be determined by turning the equipment off and on, the user is encouraged to try to correct the interference by one or more of the following measures:

- Reorient or relocate the receiving antenna.
- Increase the separation between the equipment and receiver.
- Connect the equipment into an outlet on a circuit different from that to which the receiver is connected.
- Consult the dealer or an experienced radio/TV technician for help.

In compliance with the FCC rules, 47 CFR 15.21, the user must be notified that changes or modifications to the Rugged Handheld that are not expressly approved by the manufacturer could void the user's authority to operate the equipment.

Only approved accessories may be used with this equipment. In general, all cables must be high quality, shielded, correctly terminated, and normally restricted to two meters in length. Wall chargers approved for this product employ special provisions to avoid radio interference and should not be altered or substituted.

This device must not be co-located or operating in conjunction with any other antenna or transmitter.

This cell modem is compliant with FCC regulations when operated within the temperature range of -30°C to +50°C. Do not operate the cell modem outside of this temperature range.

Industry Canada

In compliance with Industry Canada rules, the following statement must appear on the device or in the user documentation:

This Class B digital apparatus complies with Canadian ICES-003.

Radio Frequency Safety

This device has been evaluated for use in close proximity to the body. Use only accessories approved by Juniper Systems. The use of third party accessories may not comply with FCC and international RF exposure requirements. To comply with FCC and other national RF exposure requirements do not co-locate this device with other transmitters.

This device operates in compliance with the FCC radio frequency exposure limits for an uncontrolled environment. Users must follow instructions provided in the user documentation to satisfy compliance with FCC radio frequency exposure requirements.

There cannot be any alteration to the authorized antenna system.

CE Marking (European Union)

CE compliance of this device is valid only if powered with/by a CE-marked wall charger provided by the manufacturer. Cables connecting to the USB host port must use a ferrite core/bead on the cable. The ferrite core must be placed on the cable near the end that connects to the Allegro 3.

Declaration of Conformity

The Declaration of Conformity for CE Marking is available at: <http://www.junipersys.com/doc>.



D Specifications

Allegro 3 Rugged Handheld Specifications

FEATURE	SPECIFICATION
Operating System	<ul style="list-style-type: none"> ■ Android™ 7 AOSP by Google ■ English, French, German, Spanish, Brazilian Portuguese, (see complete list)
Processor	<ul style="list-style-type: none"> ■ 1.2GHz ARM Cortex A9 i.MX6
Memory	<ul style="list-style-type: none"> ■ 2 GB RAM
Primary Data Storage	<ul style="list-style-type: none"> ■ 16 GB flash storage
Micro SD/SDHC Card Slot	<ul style="list-style-type: none"> ■ Micro SD/SDXC card slot, user accessible
Physical Features	<ul style="list-style-type: none"> ■ Dimensions, standard: 5.4" wide x 10.2" long x 1.6" thick (138 mm x 255 mm x 40 mm) ■ Weight: <ul style="list-style-type: none"> Standard - 2.01 lb. (910 g) with battery Geo - 2.09 lb. (946 g) Geo Barcode- 2.22 lb. (1006 g) Geo Cell - 2.15 lb. (972 g) Geo Cell Barcode- 2.28 lb. (1034 g) ■ Durable hardened plastic in a shear-proof, shock-resistant design ■ Strong chemical resistance ■ Easy to grip ergonomic form factor ■ Impact-absorbing bumpers ■ Comfortable, wide hand strap ■ OEM customizable expansion area
Display	<ul style="list-style-type: none"> ■ Active viewing area: 4.2" (107 mm) color WVGA LCD TFT ■ 640 x 480 pixel resolution ■ LCD backlight ■ Outdoor viewable ■ Landscape orientation

FEATURE	SPECIFICATION
Touchscreen	<ul style="list-style-type: none"> ■ Capacitive touch interface ■ Chemically-strengthened glass ■ Scratch-resistant ■ Touch control options (finger, stylus, wet)
Keyboard	<ul style="list-style-type: none"> ■ Alphanumeric QWERTY keyboard ■ Modifier keys ■ Programmable keys and LEDs ■ Backlight ■ On-screen keyboard option
Batteries	<ul style="list-style-type: none"> ■ Rechargeable Li-Ion battery pack, 3.6VDC 12000mAh, 43.2Whr ■ Run time of up to 20 hours ■ Full charge takes about 5 hours ■ Quick charge ■ Built-in battery intelligence ■ User-replaceable, field rechargeable
Connector I/O Module	<ul style="list-style-type: none"> ■ RS-232C 9-pin D-sub connector, +5VDC @ 500 mA available on ring in pin 9 via software configuration ■ USB Host (Full A) ■ USB Client (Micro B) ■ 12-24VDC jack for power input and battery charging, +12VDC 1.67A ■ 3.5mm audio jack, supports speaker/microphone or stereo output (pin detect) ■ Docking contacts for charging ■ Connector protector ■ OEM configurable/customizable
Wireless Connectivity	<ul style="list-style-type: none"> ■ <i>Bluetooth</i>[®] wireless technology 4.2 BR/BDR/BLE "Smart Ready," Class 1.5, range greater than 100 feet (30 m) ■ Wi-Fi 802.11b/g/n with extended range. U.S. and international ■ 4G LTE CAT-4/3G-fallback ■ LTE frequency bands: NA 2, 4, 5, 12, EU 1, 3, 7, 8, 20, 28, and AU 1, 3, 5, 7, 8, 28

FEATURE	SPECIFICATION
Audio	<ul style="list-style-type: none"> ■ Speaker, loud and clear ■ Microphone, low noise ■ 3.5mm audio jack, supports stereo headset and microphone at the same time (speaker disable)
LED Activity Indicators	<ul style="list-style-type: none"> ■ Red: power applied/charging status ■ Green: notification, application programmable ■ Blue: application programmable
Temperature Specifications	<ul style="list-style-type: none"> ■ Operating Temperature: -22° to 140° F (-30° to 60° C). <i>Note: Bluetooth[®] wireless technology is rated to -4° to 122° F (-20° to 50° C).</i> ■ Storage Temperature: -22° to 158° F (-30° to 70° C) ■ Battery Charging Temperature: 32° to 122° F (0° to 50° C)
Shock Resistance	<ul style="list-style-type: none"> ■ Withstands multiple 4 foot drops to concrete
Environmental Ratings and Standards	<ul style="list-style-type: none"> ■ IP68 rating, waterproof and dustproof (1.4m for 30 minutes) ■ MIL-STD810G test procedures: Method 500.5 Low Pressure (Altitude); Method 501.5 High Temperature; Method 502.5 Low Temperature; Method 503.5 Temperature Shock; Method 506.5 Rain; Method 507.5 Humidity; Method 510.5 Sand and Dust; Method 512.5 Immersion; Method 514.6 Vibration; Method 516.6 Shock
Warranties	<ul style="list-style-type: none"> ■ 24 months for Allegro 3 ■ 90 days for accessories ■ Extended service and maintenance plans

FEATURE	SPECIFICATION
Software Included	<ul style="list-style-type: none"> ■ Barcode Connector ■ Calculator ■ Calendar ■ Camera ■ Clock ■ Contacts ■ Downloads ■ Email ■ Files ■ Gallery ■ Geode Connect ■ Music ■ Opera ■ RFID Connector ■ Search ■ Settings ■ Sound Recorder <p style="text-align: center;"><i>Note: Software on individual units may vary from this list.</i></p>
Configurations	<ul style="list-style-type: none"> ■ Standard with Wi-Fi, Bluetooth, 2GB RAM, 16GB Storage ■ Geo with Standard features plus Camera and GPS ■ Geo Barcode with Geo features plus Barcode Scanner ■ Geo Cell with Geo features plus Cell ■ Geo Barcode Cell with Geo Barcode features plus Cell <p style="text-align: center;"><i>US/North America and CE/EU Models</i></p>
Camera (Geo models)	<ul style="list-style-type: none"> ■ 5MP resolution ■ Autofocus ■ Video capture ■ JPEG image format ■ Juniper Geotagging; embed and/or emboss photo with date, time and GPS position ■ Flash and flashlight

FEATURE	SPECIFICATION
4G Data Modem (Geo model option)	<ul style="list-style-type: none"> ■ 4G LTE with 3G HSPA+ fallback ■ Integrated Cinterion PH8P module (Pentaband Worldwide), 800/850/900/1800/1900/2100 MHz data speeds, UMTS/HSPA+3GPP ■ Does not support voice calls or SMS ■ Communicates on GSM-based networks ■ Supports mini-SIM card only
GPS/GNSS (Geo models)	<ul style="list-style-type: none"> ■ High-sensitivity GPS, GLONASS, Galileo, BeiDou, QZSS, SBAS receiver ■ Accuracy: SBAS 2 meters, autonomous 5 meters ■ Post-processing capability for enhanced accuracy beyond 2 to 5 meters, proprietary protocol ■ User settings for enhanced performance under canopy ■ Integrated real-time SBAS capability, support for WAAS, MSAS, EGNOS ■ File format NMEA-0183 version 4.0 out; default strings: RMC, GSA, GNS, GBS, VTG, GSV, ZDA, DTM, GGA, GLL ■ 72 GNSS tracking channels ■ Concurrent GNSS constellation resolution ■ NMEA-0183 version 4.0 out ■ GPS signal quality indicator on Juniper Home screen ■ Geode Connect application ■ GNSS Stream Application
Certifications and Standards	<ul style="list-style-type: none"> ■ FCC Class B ■ CE Marking (applicable EMC, R&TTE, and LVD directives) ■ Industry Canada ■ EN60950/EN62368 Safety ■ <i>Bluetooth</i> SIG qualification ■ USB client ■ IP68 waterproof and dustproof ■ Designed to MIL-STD 810G

FEATURE	SPECIFICATION
Barcode Scanner (Geo Barcode model option)	<ul style="list-style-type: none"> ■ Imager and Decoder: Motorola/Symbol SE4500 imager and PL3307C 400MHz decoder ■ Sensor Resolution: 752 X 480 ■ Field of View: Horizontal 40°, vertical 25° ■ Reading Angles: Skew & pitch ±60°, roll 360° ■ Read Range: 1" to 24" depending on code type, size, and density ■ Aiming Crosshair Pattern: Visible with low light illumination ■ Symbologies: All common 1D, 2D (PDF417, MicroPDF417, Composite, RSS, TLC-39, Data matrix, QR code, Micro QR code, Aztec, MaxiCode, Postal codes, etc.) ■ Trigger Buttons: Programmable ■ Barcode Connector™ Utility: Wedge and configuration ■ Certification: Class 1 Laser and LED Product ■ Power: 1.49W active, 0.54W standby, 8mW sleep; by default device returns to sleep after 1 second of inactivity
Standard Accessories	<ul style="list-style-type: none"> ■ Li-Ion battery ■ Hand strap (pre-installed) ■ USB micro client sync cable ■ AC wall charger with international plug kit <ul style="list-style-type: none"> - Input: 100-240VAC, 50/60Hz, 0.5A - Output: 12VDC, 1.67A ■ Capacitive stylus and tether ■ Screwdriver ■ Quick Start Guide ■ Owner's Manual available on our website ■ Two year warranty

FEATURE	SPECIFICATION
Optional Accessories	<ul style="list-style-type: none">■ Shoulder strap■ Serial cable■ Vehicle charging adaptor■ Holster case■ Flip cover fitted case■ 8GB micro SDHC memory card■ Premium screen protectors <p><i>See your sales associate for more details on optional accessories.</i></p>

Note: Specifications are subject to change without notice.



Index

Index

Symbols

4G Data Modem 20

A

Anatomy of the Rugged Handheld 2

Android 2–53, 8–53, 9–53, 18–53

B

Battery Pack

 Battery Life 11

 Specifications 41

 Storage 24

 Warnings 34

C

Camera

 Specifications 43

Care and Maintenance

 Cleaning 25

 Storage 24

Cautions 11, 13, 21, 25, 26, 31

Certifications and Standards 35

Cleaning 25

Connector Module 14

 Cleaning 25

D

Data Modem 20

Declaration of Conformity 37

Display

 Backlight 9

 Settings 9

E

Equipment Warnings 35

F

Features

 Standard 8

G

Geode Connect 43-44
GPS/GNSS 44
GSM Modem 20

H

Hold to Zoom. *See* Zoom in on Display
Home Screen 8

L

Limitation of Liability 29

M

Microphone 14, 42
Microsoft® Windows® Embedded Handheld 6.5.3 40
Modem 20

N

Notifications 8

O

Operating System 40

P

Powering Off and On 15
Power Management
 Battery Pack 11
 Charging Battery Packs 12
Power Off 15
Product Warnings 34
Program Buttons. *See* Programmable Keys

Q

Quick Settings 8

R

Recycling the Rugged Handheld and Batteries 26
Repairing 31
 System Information 32
RS-232C Port 14, 41

S

- Screen Protector 4
- SD Cards 13
- SIM Card 3, 4
- Sleep 15
- Speaker 42
- Specifications 40–47
- Status Bar 8
- Storing the Mesa 2 16
- Storing the Rugged Handheld and Battery Pack 24
- System Information 20, 31, 32

T

- Temperature Specifications 42
- Touchscreen 9–11
 - Protecting the Touchscreen 25
 - Settings 9
 - Specifications 41
 - Touch Control Setting 9

U

- Updates, Operating System and Documentation 9
- USB Client 14, 44
- USB Host 14

W

- Warnings 34, 35
- Warranty 28–31
 - Exclusions 28
 - Extended Warranties 30
 - Limitation of Liability 29
 - Remedy 29
 - Repairs 30
 - Services 30
 - Warranty Exclusions 28
 - Warranty Repairs 30
- Wi-Fi Wireless Communication 18
 - Connecting to a Wi-Fi Network