

UH100

Diagnostic Ultrasound System

User Manual

Copyright

Copyright 2015 Qisda Corporation. All rights reserved. No part of this publication may be reproduced, transmitted, transcribed, stored in a retrieval system or translated into any language or computer language, in any form or by any means, electronic, mechanical, magnetic, optical, chemical, manual or otherwise, without the prior written permission of Qisda Corporation.

All other logos, products, or company names mentioned in this manual are the registered trademarks or copyrights of their respective companies, and are used for informational purposes only.

Disclaimer

Qisda Corporation makes no representations or warranties, either expressed or implied, with respect to the contents hereof and specifically disclaims any warranties, merchantability or fitness for any particular purpose. Further, Qisda Corporation reserves the right to revise this publication and to make changes from time to time in the contents hereof without obligation of Qisda Corporation to notify any person of such revision or changes.

This User Manual aims to provide the most updated and accurate information to customers, and thus all contents may be modified from time to time without prior notice.

Limit of liability

All contents and services accessible through this device belong to third parties and are protected by the laws on copyright, patents, trademarks and/or other intellectual property laws. These contents and services are provided solely for your personal use and not for commercial use. You cannot use them without the explicit permission from the content owner or service provider. Without limiting the foregoing, except with the express authorization of the content owner or of the supplier of the services concerned, you are forbidden to modify, copy, republish, transfer, distribute, transmit, translate, sell, exploit or create derivatives, in any manner and on any medium, regardless of the content or services displayed by the intermediary of this device.

Qisda is not responsible for the content of the websites or of similar resources, which are maintained and controlled by third parties, that may be linked from this product. Providing links to those websites or to similar resources does not mean that Qisda makes any warranty or representation to their content by expression or by implication.

Any third party content or service preinstalled in this product is provided “as is”. Qisda does not, by expression or by implication, make any warrant to the content or to the services provided by third parties. Qisda does not warrant or guarantee that the content or services provided by third parties are accurate, effective, most up-to-date, legal, or complete. Under no circumstances shall Qisda be liable for the content or services provided by third parties including their negligence.

Services provided by third parties may be terminated temporarily or permanently. Qisda does not warrant or guarantee that any content or services provided by third parties are in good condition at any time, and is not liable for the termination of the said content and services.

In addition, Qisda is not involved in any transactions you conduct in the websites or similar resources maintained by third parties.

You should contact the content or service providers for any questions, concerns, or disputes.

Contact information

Manufacturer

Name: Qisda Corporation

Address: 1st, 5th, 7th Floors, No. 159, Shan-Ying Road, Shan-Ting Li, Gueishan Dist., Taoyuan City, Taiwan, R.O.C.

EU Authorised Representative

Name: Mednet Gmbh

Address: Borkstrasse 10, 48163 Muenster, Germany

Table of contents

Copyright.....	2
Disclaimer	2
Limit of liability.....	2
Contact information	3
Chapter 1 Introduction	8
About ultrasound	8
Medical purpose.....	8
Equipment list.....	9
About the User Manual	9
Specifications	10
System	10
Battery.....	11
Transducer.....	12
Power adapter.....	13
System warranty	13
Chapter 2 Safety information.....	14
Warning symbols.....	16
System label icons	16
System button	17
Transducer label icons.....	17
Shipping label icons	17
Electrical safety	18
Battery usage/disposal.....	20
Electrical Fast Transients (EFT).....	20
Electromagnetic Interference (EMI)	20
Surges to mains power supply	24
Electromagnetic Interference (EMI)	24
RF safety.....	25
Biological safety	25
Heating.....	26
Cavitation	26
Safe scanning guideline.....	26
Temperature display for transducers intended for internal use.....	28

Waterproof and dustproof ratings.....	28
Understand the MI/TI display	29
Tissue model.....	32
TI.....	33
MI	33
Display and report in different modes	34
Operator control features	34
Transducer surface temperature rise	34
Intended use	35
Indications for use	37
Chapter 3 Get Started.....	41
System overview	41
Front and side views	41
Rear and top/bottom views	42
Insert a microSD card (optional)	43
Use the stand	44
Charge the system	45
Connect the transducer.....	46
Remove the transducer.....	46
Use the system on the go	47
Wall-mount the system.....	48
Output the system display to an HDMI-enabled TV or monitor.....	48
Chapter 4 Basic operations	49
Turn on the system	49
Identify the main screen layout	51
System menu screen	51
Imaging screen (Real-time).....	52
Imaging screen (Frozen).....	54
Switch the control panel pages	56
Add a new patient	57
To update patient information	57
Load a work list	58
Select a preset	59
To modify current presets	59

Set the transducer orientation	60
Adjust the displayed image	60
Enlarge an area of the image.....	61
Split the imaging screen.....	62
Freeze an image	62
Add annotations and measurements	63
Annotations	63
Arrow.....	63
Label	64
BDMK.....	64
Measurements	65
Save and print the image	66
Save an image	66
Save a cine clip.....	66
Print an image.....	66
Review the image.....	67
Perform multiple selections.....	67
Compare images.....	68
Generate a report.....	68
Export the exam	69
End the exam	69
Chapter 5 Scan modes overview.....	70
B mode overview.....	70
B mode image controls	71
Color/Power Doppler mode overview.....	72
Color/Power Doppler mode image controls	73
M mode overview	74
M mode image controls.....	74
Pulsed-Wave (PW) Doppler mode overview.....	75
PW Doppler mode image controls	75
Chapter 6 IT Network.....	77
Introduction	77
Specifications	77
Security	77
Information flow.....	78

IT network failure recovery measures	78
Chapter 7 Maintenance	81
System maintenance.....	81
Clean the ventilation slots and connection ports/sockets.....	81
Clean the touchscreen	81
Transducer precautions and maintenance.....	81
Inspect the transducer.....	82
Cleaning and disinfection	82
Transducer immersion level.....	83
Cleaning instructions.....	83
Disinfection instructions	83
Chapter 8 Appendix.....	88

1

Introduction

The Qisda UH100 Diagnostic Ultrasound System (hereinafter called “system”) is an easy-to-use, portable ultrasound imaging instrument intended for use by a qualified operator for ultrasound evaluation and clinical analysis. The miniaturized ultrasound system runs on the tablet computer using multi-touch operation. Commonly used applications include: abdomen, cardiac, small organ (e.g., breast, testes, thyroid), heart soft tissue, vascular, musculoskeletal (e.g., conventional and superficial), pediatric, fetal, cephalic and Ob/Gyn.

About ultrasound

Ultrasound is a diagnostic imaging technology done by sending sound waves into the body tissue using a transducer. Based on the various degrees of sound echoing off different tissues, the ultrasound image is formed and displayed. To make a correct diagnosis based on scans, the ability of the operator and the quality of images are equally important. The system is equipped with an ultrasound software that helps a trained operator perform precise image adjustments and adequate control settings applied during the exam.

The ultrasound software supports various scan modes to work with various applications and purposes. For detailed instructions on the functions each mode provides, please refer to the subsequent chapters.

Medical purpose

The system is a general purpose ultrasound system which transmits and receives ultrasound signal from the transducer, then composites and displays real-time echo images on the monitor. By moving the transducer, the system displays the real-time anatomy structure of the patient’s body on the screen. This valuable information helps operators to diagnose and treat a variety of diseases and conditions.

The system in no way interprets these images or provides a medical diagnosis of the patient being examined. It is intended for use by a qualified physician for evaluation by ultrasound imaging or fluid flow analysis of the human body.

Equipment list

Check the sales package for the following items. If any item is missing or damaged, contact your place of purchase immediately.

- Qisda Diagnostic Ultrasound System
- Medical grade AC/DC power adapter
- Ultrasound Operating Instructions CD containing the PDF file of the User Manual (this document)
- Power cord
- One or more transducers



- Using accessories, transducers, or power supply units other than those specified may cause the warranty to void and result in increased electromagnetic emissions, decreased EMI immunity of the system, or even damages to the system and personal injuries.
 - Adapter types may vary by country/region.
-

About the User Manual

The User Manual provides important procedures and information on how to operate the system correctly and safely. Please read the manual carefully before using the system.

- To access the User Manual in the interactive PDF file format:
 - » On the system's imaging screen, touch **Menu > Setting > About > Help**.
 - » Insert the supplied Ultrasound Operating Instructions CD, and then read the PDF file (file name: UH100_Operators_Manual_EN.pdf).
- Information contained in the User Manual is correct at the time of release and subject to change without notice.
- Screen images and icons in this manual are simulated for illustrative purposes only. Actual displays may vary.
- In this manual, the following graphic symbols and texts are used to alert you to important information. Make sure you have read all the notes and warnings mentioned in this User Manual.



Note: Useful tips or additional information that help you get better use of the equipment.



Caution: Notices describing actions or conditions that may damage the equipment or cause injury.



Warning: Instructions that must be followed. Failure to observe can cause damages to the equipment, or result in personal injuries, or even death.

Specifications



Specifications are subject to change without prior notice.

System

Item	Specifications
Form factor	Tablet
Weight	< 1.9kg
Dimension	12.58" (W) x 8.79" (H) x 1.25" (D) 319.6 mm (W) x 223.2 mm (H) x 31.8 mm (D)
Materials	Plastic, metal, rubber
Color	White
Loudspeaker	Built-in loudspeakers x 2
Console	Touchscreen
Primary monitor	11.6" 1366x768 mm
Number of transducer connectors	1 transducer
Stand	1 stand
Wall mount	Standard VESA screw Holes: 75mm x 75mm/100mm x 100mm
Water resistant level	IP22
CPU	Qualcomm APQ8074
Languages	English, T/S Chinese, French, German, Spanish, Russian
Memory	16GB eMMC
Storage	mSATA 128GB SSD ; support up to 512GB
Connectivity	<ul style="list-style-type: none">• HDMI x 1• Audio output x 1• Ethernet RJ45 x1• MIC x1• USB 2.0 x1• USB 3.0 x1• MicroSD slot x1• Transducer x1
Power	Battery power/chargeable with up to 19V AC adapter
Battery	Non-removable battery with 1.5 hour run-time

Item	Specifications
Accessories	<ul style="list-style-type: none"> Power adapter Input: AC 100 ~ 240V, 50 ~ 60Hz, 1.6 ~ 0.7A Output: +19Vdc, 3.43A Transducer P42A, L115A, C52A, E94A
Storage	Temperature: -25 ~ 60°C Humidity 20% ~ 95% RH Air Pressure 700 ~ 1060hPa
Environmental operating conditions	Temperature: 10 ~ 40°C Humidity: 20% ~ 85% RH, no condensation Air Pressure: 700 ~ 1060 hPa
Product life	5 years

Battery

Model: QIC3000

Battery type (non-removable): 3S2P Panasonic-3070mAh BQ20Z70, compliant with IEC62133 standard.

Item	Rate performance	Remark
Battery	3070 mAh	Panasonic
Typical capacity	Above 6140 mAh	Rate discharge capacity after rate charge
Nominal capacity	Above 5833 mAh	Rate discharge capacity after rate charge
Nominal voltage	10.8 V	Mean operation voltage during rate discharge after rate charge
Maximum charge voltage	12.6 V	CV mode charging voltage
Voltage at end discharge	9.0 V	Stop discharge when any cell reaches to 2.7 ± 0.02 V
Suggested charge current (Standard)	1.2 A	
Suggested charge current (maximum)	3.0 A	
Suggested continuous discharge current	3.0 A	≤ 33 W
Suggested maximum discharge current	7.0 A	≤ 78 W
END of charge condition	150 mA	1 min

Item	Rate performance	Remark
Operating temperature	0 ~ 45°C	Standard charging
	10 ~ 45°C	In max. charging
	-0 ~ 60°C	Standard discharging
Storage temperature and humidity range	-20 ~ 35°C	Within 1 year, 45% to 85% RH
	-20 ~ 40°C	Within 6 months, 45% to 85% RH
	-20 ~ 45°C	Within 1 month, 45% to 85% RH
	-20 ~ 50°C	Within 1 week, 45% to 85% RH
Power consumption		
Normal mode	≦ 620 μA	
Sleep mode	≦ 120 μA	
Shutdown mode	≦ 5.42 μA	

Transducer

Transducer	Elements	Descriptions	Applications
P42A	64	Phased-linear array transducer with a maximum depth of 200 mm and a user-controllable field-of-view	<ul style="list-style-type: none"> » Adult abdominal » OB/GYN » Cardiac » Abdominal vascular » Fetal heart » Renal
C52A	128	Curved linear array transducer with a maximum depth of 200 mm and a user-controllable field-of-view	<ul style="list-style-type: none"> » Adult abdominal » OB/GYN » Fetal heart » Abdominal vascular » Renal
L115A	128	Linear wideband array transducer with a maximum depth of 150 mm and a user-controllable field-of-view	<ul style="list-style-type: none"> » Dialysis access » Small parts » Musculoskeletal » Peripheral vascular » Medium depth arterial and venous studies » Breast
E94A	128	Linear wideband array transducer with a maximum depth of 200 mm and a user-controllable field-of-view	<ul style="list-style-type: none"> » OB/GYN » Fetal birth defects » Placenta previa » Cysts and fibroids » Ectopic pregnancy » Pelvic pain » Infertility

Power adapter

Item	Specifications
Brand	Adapter Technology Co., Ltd.
Model	ATM065-P190
Input	Universal AC 100 ~ 240V, 50 ~ 60Hz, 1.6 ~ 0.7A, without any slide switch
Output	+19Vdc, 3.43A
Case Dimension	119 (L) * 60 (W) * 36 (H) mm
Efficiency	Eff (av) ≥ 87%
Safety	I.T.E. - PSE / BSMI (IEC 60601-1: 2005 + CORR. 1 (2006) + CORR. 2 (2007)) Medical - UL / cUL / T-mark
EMI	CE / FCC Class B, Conduction and Radiation Met.
Protection	OVP (Over Voltage Protection), SCP (Short Circuit Protection), OCP (Over Current Protection)
Features	High frequency design, less power consumption. Suitable for usage at Medical Equipment. Meet DoE / ErP (Stage 2) / NRCan

System warranty

The system is warranted under normal usage for twelve months from the date specified on your purchase invoice. The warranty is void if unauthorized personnel perform service or maintenance on the system. To ensure correct system performance and to obtain warranty service, please contact Qisda Corporation for technical support.

2

Safety information



Follow the procedures carefully and ensure that the power/electrical/environmental requirements are satisfied. Failure to observe the instructions or disregarding the warnings may result in damages to the system, personal injury, or even death of the operator or the patient.

Please observe the following precautions carefully.

- This system complies with Type BF general equipment and the EN60601-1 standard, suitable for continuous operation when connected as a system to a medical grade AC/DC power adapter or operated from the tablet battery.



- Use only medical-grade peripherals in the patient environment. Refer to “[Intended use](#)” for a diagram of the patient environment.
 - Do not block or otherwise obstruct access to the power plug at the wall. Operators must be able to quickly unplug the power cord at the wall in case of emergency.
-

- The system should only be used in a medical facility under the supervision of a trained physician.



Do not use the system during an MRI exam or when using a defibrillator.

- Only an authorized service technician should perform maintenance.
- Be extremely cautious when placing or moving the system.



- Always position the system on a stable surface where it cannot fall on the patient.
 - Do not lift the system by the power cable or the transducer. If either disconnects, the system could fall on the patient.
-

- Do not attempt to disassemble or modify the system. There are no user serviceable parts inside this system. Necessary modifications must be made only by the manufacturer or its designated agents.
 - This system has been fully adjusted and tested prior to shipment from the factory. Unauthorized modifications will void your warranty.
 - If this system displays any signs of malfunction, turn off the system immediately, disconnect it from the wall outlet, and then inform the manufacturer or its designated agents for inspection or service.
 - Do not cut, bend, modify, place heavy objects, or step on the cable of the power adapter. Otherwise the external insulation may be damaged and result in short-circuit or fire.
-



Do not use an unknown power adapter other than the one supplied with the system. Connecting the system to an unknown power adapter is very dangerous and may lead to fire or explosion.

- The power cable of the system should only be connected to a grounded power socket. Do not remove the ground cable for any reason.
- Do not connect USB peripherals with an extended USB cable. Extended connection may cause unexpected usage fault.
- Only devices that comply with the EN60601-1 standard, either electronically or mechanically, can be connected to this system. Recheck the leakage current and other safety performance indices of the entire system to avoid potential system damage caused by leakage from a current superposition.
- This system does not incorporate any specialized protective measures in the event it is configured with high-frequency operation devices. The operator should use with caution in these types of applications.
- The system is in compliance with the Ingress Protection Marking ratings IP22.



Do not use this system under direct sunlight, near heat sources or in the presence of flammable substances, otherwise an explosion may occur.

- Do not use this system near strong electromagnetic sources, such as a microwave oven. The electromagnetic interference may cause this system to malfunction.
- Do not allow any liquid to get inside this system. Water and moisture may cause short-circuit to the electronic components and lead to malfunctions.
- Do not drop or apply shock/vibration to this system. Strong impacts may damage the components inside.
- When using this system for ultrasound examinations, use only the qualified ultrasound gel that complies with system standards.



- Do not continuously scan the same part of a patient or expose the patient to prolonged scanning, otherwise it may harm the patient.
 - Do not stay at the same position for too long without taking a break while scanning patients to prevent from harm or neck injury.
-

- For proper disposal of this system, please contact your local service department.

Warning symbols

The following symbols provide information about the system's labels and regulatory compliance.

System label icons

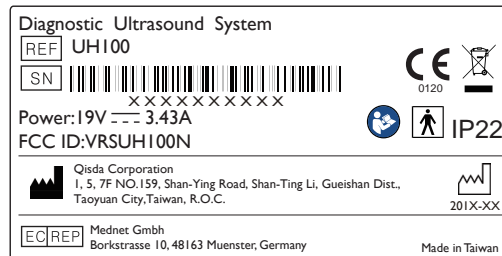



Figure 1 System SPEC label for CE MDD Ver.20150925.01

Symbols	Descriptions
	Product model
	Serial number
	Manufacturer Qisda Corporation manufactures the diagnostic ultrasound system.
	EU/EC European Authorised Representative
	CE marking certification with Notified Body number 0120
	Dispose of Properly Do not dispose of by dumping in garbage. Use a separate collection for electrical and electronic equipment. Products bearing this symbol are subject to the European Community directive 2002/96/EC on waste electrical and electronic equipment (WEEE), amended by directive 2003/108/EC. For collection and disposal of the product, its components, or its accessories, contact your local Qisda Corporation representative.
	Refer to the User Manual This label indicates that the user should refer to the User Manual for information on using this equipment.
	Type BF Equipment Applied Part The Qisda Diagnostic Ultrasound System provides protection against electric shock.
IP22	IP Code, International Protection Marking

Symbols	Descriptions
	Manufacturer date

System button

Symbols	Descriptions
	Power button Press and hold the Power button to turn on/off the system.

Transducer label icons

























<p>Ultrasound Transducer_Linear Array</p> <p>REF L115A / 5~11MHz</p> <p>SN  XXXXXXXXXXXXX</p> <p> </p> <p></p> <p> Qisda Corporation I, 5, 7F NO.159, Shan-Ying Road, Shan-Ting Li, Gueishan Dist.,Taoyuan City,Taiwan, R.O.C.</p>	<p>Ultrasound Transducer_Phased Array</p> <p>REF P42A / 2~4MHz</p> <p>SN  XXXXXXXXXXXXX</p> <p> </p> <p></p> <p> Qisda Corporation I, 5, 7F NO.159, Shan-Ying Road, Shan-Ting Li, Gueishan Dist.,Taoyuan City,Taiwan, R.O.C.</p>
<p>Ultrasound Transducer_Curved Linear Array</p> <p>REF C52A / 2~5MHz</p> <p>SN  XXXXXXXXXXXXX</p> <p> </p> <p></p> <p> Qisda Corporation I, 5, 7F NO.159, Shan-Ying Road, Shan-Ting Li, Gueishan Dist.,Taoyuan City,Taiwan, R.O.C.</p>	<p>Ultrasound Transducer_Endocavity Array</p> <p>REF E94A / 4~9MHz</p> <p>SN  XXXXXXXXXXXXX</p> <p>Caution: The surface heating limit of this transducer shall be no more than 43°C</p> <p> </p> <p></p> <p> Qisda Corporation I, 5, 7F NO.159, Shan-Ying Road, Shan-Ting Li, Gueishan Dist.,Taoyuan City,Taiwan, R.O.C.</p>

Figure 2 Transducer SPEC labels for CE MDD Ver.20150922.01

Symbols	Descriptions
IP67	IP Code, International Protection Marking

Shipping label icons

Symbols	Descriptions
	This Side Up

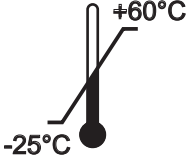
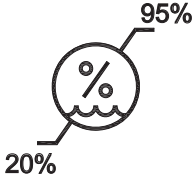
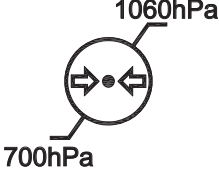
Symbols	Descriptions
	Fragile
	Maximum Stacking Height
	Maximum Rated Load
	Sun and Rain
	Temperature The Qisda Diagnostic Ultrasound System must be stored in the original shipping container in environments between -25°C and 60°C (-13°F and 140°F). The temperature while operating the system should be kept between 10°C and 40°C (32°F and 104°F).
	Humidity The Qisda Diagnostic Ultrasound System must be stored in the original shipping container in environments with 20% to 95% relative humidity and non-condensing. The humidity while operating the system should be kept between 20% to 85% relative humidity and non-condensing.
	Air Pressure The Qisda Diagnostic Ultrasound System must be stored in the original shipping container in environments between 700 hPa (525 mmHg) and 1060 hPa (795 mmHg) air pressure.

Electrical safety

Only trained medical personnel should operate this system. This system complies with the following standards:

- Electrical:
 - » IEC 60601-1:2005+AMD1:2012; EN 60601-1:2006+A11:2011+A12:2014, Medical Electrical Equipment Part 1: General Requirements For Safety, Class I, BF, continuous operation
 - » IEC 60601-2-37: 2007, Medical Electrical Equipment Part 2-37: Particular Requirements For The Safety of Ultrasonic Medical Diagnostic And Monitoring Equipment
- EMC/EMI:
 - » IEC 60601-1-2:2007/AC:2010, CISPR 11 Group I Class B
- Harmful liquid protection:
 - » For the main system: IP22
 - » For the transducer: IP67
 - » For maximum safety, observe the following guidelines strictly:
- Shock hazards exist if the power adapter is damaged or is not properly grounded. Use only the supplied medical grade power cord and power adapter.



Do not remove or try to circumvent the grounding wire. If the protective grounding of the system is questionable, disconnect the system from the power source and run it on its internal battery.

- Please plug the system into a hospital-grade, three-hole outlet, and do not circumvent the power cord.



To avoid the risk of electric shock, the system must only be connected to the mains power supply that incorporate protective earth.

- Only authorized service technicians can make internal replacements of the system.



Do not operate the system in the presence of flammable gases.

- Do not use a transducer if the transducer or cable is damaged. Return damaged equipment to the Qisda dealer for replacement.
- All peripheral devices connected to the system must comply with IEC 60601 or IEC 60950-1.



- Transducer cables have strain relief at terminations. Inspect cables regularly to detect damaged, frayed, or broken cables that might contact a patient.
 - E94A are invasive transducers. The operator should immediately stop using the E94A transducer when its surface temperature reaches 43°C.
-

Battery usage/disposal



- Do not disassemble the system.
 - Use only the supplied battery. Using an unapproved battery may cause the system to explode and result in serious damage to your health or property.
 - Do not replace, heat, crush, puncture, short external contacts, or incinerate the battery.
-

- Use only the supplied power adapter to charge the battery.
 - The system can contain environmentally hazardous materials such as, but not limited to: heavy metals, general recyclable metals, and plastics. This product should be recycled according to local and national guidelines for recycling electronic equipment.
-



Incorrect use of the battery may cause a leak of chemicals or explosion. The leak of chemicals may harm the skin. If any chemicals leak from the device, use a dry cloth to wipe it clean and contact the Qisda dealer for help.



Dispose of used batteries according to the instructions.

Electrical Fast Transients (EFT)

The system complies with the IEC 60601-1-2 3rd edition standard for susceptibility to electrical fast transients (EFT) on the power line. However, if the system experiences EFT on the power line, artifacts (vertical lines, excessive noise in image, etc.) may appear on the ultrasound image. To eliminate these artifacts caused by an EFT condition, the operator should either:

- Disconnect the system from the power source by unplugging the power cord from the tablet, and run the system on its internal battery.
- Or
- Unplug the power cord from the wall and move to a different power source that is not experiencing this condition.

Electromagnetic Interference (EMI)

Medical electrical equipment such as the system requires special precautions regarding electromagnetic compatibility, and must be installed and put into service according to the following electromagnetic tables.

All equipment

The UH100 is intended for use in the electromagnetic environment specified below. The customer or operator of the UH100 should ensure that it is used in such an environment.

Guidance and manufacturer's declaration - Electromagnetic emissions - All equipment

Emissions test	Compliance	Electromagnetic environment - Guidance
RF Emissions CISPR 11	Group 1	The Qisda Diagnostic Ultrasound System uses RF energy only for its internal function. Therefore, its RF emissions are very low and are not likely to cause any interference in nearby electronic equipment.
RF Emissions CISPR 11	Class B	The Qisda Diagnostic Ultrasound System is suitable for use in all establishments, including domestic, and those directly connected to the public low-voltage power supply network that supplies buildings used for domestic purposes.
Harmonics IEC 61000-3-2	Class A or B	
Flicker IEC 61000-3-3	Complies	
RF Emissions CISPR 14-1	Complies	The UH100 is not suitable for interconnection with other equipment.
RF Emissions CISPR 15	Complies	The UH100 is not suitable for interconnection with other equipment.

Guidance and manufacturer's declaration - Electromagnetic immunity - All equipment

Immunity test	IEC 60601 test level	Compliance level	Electromagnetic environment - Guidance
ESD IEC 61000-4-2	±6 kV Contact ±8 kV Air	As specified	Floors should be wood, concrete or ceramic tile. If floors are synthetic, the relative humidity should be at least 30%
EFT IEC 61000-4-4	±2 kV Mains ± 1kV I/Os	As specified	Mains power quality should be that of a typical commercial or hospital environment.
Surge IEC 61000-4-5	±1 kV Differential ±2 kV Common	As specified	

Immunity test	IEC 60601 test level	Compliance level	Electromagnetic environment - Guidance
Voltage dips/ Dropout IEC 61000-4-11	>95% dip for 0.5 cycle 60% dip for 5 cycles 30% dip for 25 cycles >95% dip for 5 seconds	As specified	Mains power quality should be that of a typical commercial or hospital environment. If the user of the UH100 requires continued operation during power mains interruptions, it is recommended that the UH100 be powered from an uninterruptible power supply or battery.
Power frequency 50/60 Hz Magnetic field IEC 61000-4-8	3 A/m	As specified	Power frequency magnetic fields should be that of a typical commercial or hospital environment.

Guidance and manufacturer's declaration - Electromagnetic immunity - Non-life-supporting equipment

Immunity test	IEC 60601 test level	Compliance level	Electromagnetic environment - Guidance
			Portable and mobile RF communications equipment should be used no closer to any part of UH100, including cables, than the recommended separation distance calculated from the equation applicable to the frequency of the transmitter. Recommended separation distance
Conducted RF IEC 61000-4-6	3 Vrms 150 KHz to 80 MHz	[V1] = 3 Vrms	$d = \left[\frac{3.5}{V_1} \right] \sqrt{P}$
Radiated RF IEC 61000-4-3	3 V/m 80 MHz to 2.5 GHz	[E1] = 3 V/m	$d = \left[\frac{3.5}{E_1} \right] \sqrt{P}$ 80 MHz to 800 MHz $d = \left[\frac{7}{E_1} \right] \sqrt{P}$ 800 MHz to 2.5 GHz

Immunity test	IEC 60601 test level	Compliance level	Electromagnetic environment - Guidance
			<p>Where P is the maximum output power rating of the transmitter in watts (W) according to the transmitter manufacturer, and d is the recommended separation distance in meters (m).</p> <p>Field strengths from fixed RF transmitters, as determined by an electromagnetic site survey^a, should be less than the compliance level in each frequency range^b.</p> <p>Interference may occur in the vicinity of equipment marked with the following symbol:</p> 
<p>^aField strengths from fixed transmitters, such as base stations for radio (cellular/cordless) telephones and land mobile radios, amateur radio, AM and FM radio broadcast and TV broadcast cannot be predicted theoretically with accuracy.</p> <p>To assess the electromagnetic environment due to fixed RF transmitters, an electromagnetic site survey should be considered. If the measured field strength in the location in which UH100 is used exceeds the applicable RF compliance level above, UH100 should be observed to verify normal operation. If abnormal performance is observed, additional measures may be necessary, such as reorienting or relocating UH100.</p> <p>^bOver the frequency range 150 kHz to 80 MHz, field strengths should be less than 3 V/m.</p>			

Separation Distances

The UH100 is intended for use in the electromagnetic environment in which radiated disturbances are controlled. The customer or operator of the UH100 can help prevent electromagnetic interference by maintaining a minimum distance between portable and mobile RF Communications Equipment and the UH100 as recommended below, according to the maximum output power of the communications equipment.

Maximum Output Power of Transmitter Watts (W)	Separation Distance According to Frequency of Transmitter Meters (m)		
	150 kHz to 80 MHz $\frac{3.5\sqrt{P}}{V_1} = D$	80 MHz to 800 MHz $\frac{3.5\sqrt{P}}{E_1} = D$	800 MHz to 2.5 GHz $\frac{7\sqrt{P}}{E_1} = D$
0.01	0.12 m	0.12 m	0.24 m
0.1	0.37 m	0.37 m	0.74 m
1	1.17 m	1.17 m	2.34 m
10	3.69 m	3.69 m	7.38 m
100	11.67 m	11.67 m	23.34 m

Table 1 Separation distances

For transmitters rated at a maximum output power not listed above, the recommended separation distance d in meters (m) can be estimated using the equation applicable to the frequency of the transmitter, where P is the maximum output power rate of the transmitter in watts (W) according to the transmitter manufacturer.



- At 80 MHz and 800 MHz, the separation distance for the higher frequency range applies.
- These guidelines may not apply in all situations. Electromagnetic propagation is affected by absorption and reflection from structures, objects and people.

Surges to mains power supply

If the system is powered from the mains power supply that could experience surges above 1 kV (for example, from extreme lightning conditions), additional surge suppression is recommended.

Electromagnetic Interference (EMI)

Medical electrical equipment such as the system requires special precautions regarding electromagnetic compatibility, and must be installed and put into service according to the electromagnetic tables.

To limit exposure to electromagnetic interference from nearby equipment that can degrade image quality, you should operate the Qisda Diagnostic Ultrasound System under EMI conditions that minimize power supply transients, mechanical interactions, vibration, and thermal, optical, and ionizing radiation.

RF safety

The system should be operated in a location that is no closer than listed in “Non-Life-Supporting Equipment” to any part of RF communications equipment that may disturb its functions. If abnormal performance is observed, additional measures may be necessary, such as re-orienting or relocating the equipment. The system should be separated by at least the distances specified in the table referenced above.

The system is intended for use in an electromagnetic environment where radiated RF disturbances are controlled. The customer or the user of the system can help prevent electromagnetic interference by maintaining a minimum distance between portable and mobile RF communications equipment (transmitters) and the system according to the maximum output power of the communications equipment.

Biological safety

This product, as with all diagnostic ultrasound equipment, should be used only for valid reasons and should be used both for the shortest period of time and at the lowest power settings necessary (ALARA - As Low As Reasonably Achievable) to produce diagnostically acceptable images. The AIUM offers the following guidelines:

Clinical Safety Quoted from AIUM

Approved March 26, 1997

Diagnostic ultrasound has been in use since the late 1950s. Given its known benefits and recognized efficacy for medical diagnosis, including use during human pregnancy, the American Institute of Ultrasound in Medicine herein addresses the clinical safety of such use.

There are no confirmed biological effects on patients or instrument operators caused by exposures from present diagnostic ultrasound instruments. Although the possibility exists that such biological effects may be identified in the future, current data indicate that the benefits to patients of the prudent use of diagnostic ultrasound outweigh the risks, if any that may be present.

Heating

Elevating tissue temperature during obstetrical examinations creates medical concerns. At the embryo development stage, the rise in temperature and the length of time exposed to heat combine to determine potential detrimental effects. Exercise caution, particularly during Color Doppler imaging exams. The Thermal Index (TI) provides a statistical estimate of the potential temperature elevation (in centigrade) of tissue temperature. Three forms of TI are available: TIS, for soft tissue exposures; TIB, for instances when bone lies near the beam focus; and TIC, for the heating of bone situated close to the transducer.

Cavitation

Cavitation may occur when sound passes through an area that contains a cavity, such as a gas bubble or air pocket (in the lung or intestine, for example). During the process of cavitation, the sound wave may cause the bubble to contract or resonate. This oscillation may cause the bubbles to explode and damage the tissue. The Mechanical Index (MI) has been created to help operators accurately evaluate the likelihood of cavitation and the related adverse effects.

Safe scanning guideline

- Ultrasound should only be used for medical diagnosis and only by trained medical personnel.



- Diagnostic ultrasound procedures should be done only by personnel fully trained in the use of the system, in the interpretation of the results and images, and in the safe use of ultrasound (including education as to potential hazards).
 - Operators should understand the likely influence of the machine controls, the operating mode (e.g. B mode, Color Doppler or Spectral Doppler) and the transducer frequency on thermal and cavitation hazards.
-
- Use a low output power default setting for each new patient. Output should only be increased during the examination if penetration is still required to achieve a satisfactory result, and after the Gain control has been adjusted to its maximum value.
 - Maintain the shortest examination time necessary to produce a useful diagnostic result.

-
- Take particular care to reduce output and minimize exposure time of an embryo or fetus when the temperature of the mother is already elevated.
 - Take particular care to reduce the risk of thermal hazard during diagnostic ultrasound when exposing an embryo less than eight weeks after gestation, or the head, brain or spine of any fetus or neonate.
 - Do not use endocavity transducers if there is noticeable self-heating of the transducer before insertion. If the following system message displays during a real-time scan, cease the current scan.

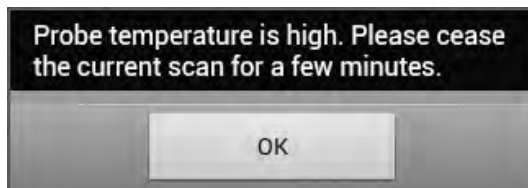

- Although applicable to any transducer, take particular care during trans-vaginal exams during the first eight weeks of gestation.
-
- During continuous operation, the system temperature may become too high. If the following system message displays during a real-time scan, touch **OK** and the system enters frozen imaging screen. To resume scanning, wait until the system engine cools down.

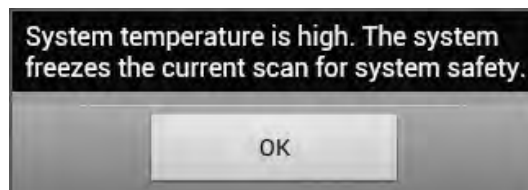

- Operators should continually monitor the on-screen thermal index (TI) and mechanical index (MI) values and use control settings that keep these settings as low as possible while still achieving diagnostically useful results. In obstetric examinations, TIS (soft tissue thermal index) should be monitored during scans carried out in the first eight weeks after gestation, and TIB (bone thermal index) thereafter. In applications where the transducer is very close to bone (e.g. transcranial applications), TIC (cranial thermal index) should be monitored.
- MI > 0.3 Minor damage is likely to happen to neonatal lung or intestine. If such exposure is necessary, reduce the exposure time as much as possible.
- MI > 0.7 Risk of cavitation exists if an ultrasound contrast agent containing gas microspheres is being used. There is a theoretical risk of cavitation without the presence of ultrasound contrast agents. The risk increases with MI values above this threshold.
- TI > 0.7 The overall exposure time of an embryo or fetus should be restricted in accordance with the following table as a reference.

TI	Maximum exposure time (minutes)
0.7	60
1.0	30
1.5	15
2.0	4
2.5	1

Table 2 Maximum exposure time recommended for an embryo or fetus

- Diagnostic ultrasound has the potential for both false positive and false negative results. Misdiagnosis is far more dangerous than any effect that might result from the ultrasound exposure. Therefore, diagnostic ultrasound should be performed only by those with sufficient training and education.
- Non-diagnostic use of ultrasound equipment is not generally recommended. Examples of non-diagnostic uses of ultrasound equipment include repeated scans for operator training, equipment demonstration using normal subjects, and the production of souvenir pictures or videos of a fetus. For equipment of which the safety indices are displayed over their full range of values, the TI should always be less than 0.5 and the MI should always be less than 0.3. Avoid frequent repeated exposure of any subject. Scans in the first trimester of pregnancy should not be carried out for the sole purpose of producing souvenir videos or photographs, nor should their production involve increasing the exposure levels or extending the scan times beyond those needed for clinical purposes.

Temperature display for transducers intended for internal use

For E94A transducers used for internal applications, e.g. the endocavity transducers, the transducer tip temperature is displayed on the screen. To protect the patient against the harm of excessive temperature, the system automatically turns off the transducer when the transducer temperature reaches a threshold temperature.

Waterproof and dustproof ratings

The system has a degree of protection from ingress of water and particulate matter, but the tablet is not approved for use where it would be exposed to liquids. If it is used in environments where it might be exposed to liquids, the tablet must be covered by ad drape, such as a Civco #610-1037. These environments include, but are not limited to outpatient and private office procedures such as biopsies, office visits, and other traditional, non-invasive scanning.

The following table lists the applied parts and their levels of protection.

Component	Manufacturer	Use	IP level
Diagnostic Ultrasound System	Qisda Corporation	Ultrasound system	IP22
C52A transducer	Qisda Corporation	Ultrasound transducer	IP67 (at transducer head)
L115A transducer	Qisda Corporation	Ultrasound transducer	IP67 (at transducer head)
P42A transducer	Qisda Corporation	Ultrasound transducer	IP67 (at transducer head)
E94A transducer	Qisda Corporation	Ultrasound transducer	IP67 (at transducer head)
Power adapter	Adapter Technology Co., Ltd.	Power source and battery charger for ultrasound system	
Power cord	I-SHENG ELECTRIC WIRE & CABLE CO. LTD.	AC line cord	

Table 3 Waterproof and dustproof ratings

Understand the MI/TI display

The system allows full software control of acoustic output. When powering on the system or create a new exam, scan parameters should be set to default preset. All of the default presets are compliant with IEC 60601-2-37 track 3. Both scan parameters and TI/MI information are real-time display in the scan properties area.



Figure 3 MI/TI on-screen display format

For transducer/mode combinations marked “V”, the MI or TI index is equal or greater than 1.0.

Mode / Transducer	C52A Curved Linear Array 2-5 MHz	L115A Linear Array 5-11 MHz	P42A Phased Array 80 elements 2-4 MHz	E94A Micro Curved Linear Array 4-9MHz
B	–	–	–	–
B/M	–	–	–	–
THI, B	(TBD)	(TBD)	(TBD)	(TBD)
THI, B/M	(TBD)	(TBD)	(TBD)	(TBD)
PW	–	–	–	–
CFM-B	–	–	V	–
CFM-THI, B	(TBD)	(TBD)	(TBD)	(TBD)

Table 4 MI/TI generating from applicable transducer/mode combinations

Track-3 follows the Output Display Standard for systems which include fetal Doppler applications. The acoustic output will not be evaluated on an application-specific basis, but the global maximum de-rated I_{spta} must be $\leq 720 \text{ mW/cm}^2$ and either the global maximum MI must be ≤ 1.9 , or the global maximum de-rated I_{sppa} must be $\leq 190 \text{ W/cm}^2$. An exception is for ophthalmic use, in which case the $TI = \max(TIS, TIC)$ is not to exceed 1.0; $I_{spta.3} \leq 50 \text{ mW/CM}^2$, and $MI \leq 0.23$. Track-3 gives the operator the freedom to increase the output acoustic power for a specific exam, and still limit output acoustic power within the global maximum de-rated $I_{spta} \leq 720 \text{ mW/cm}^2$ under an Output Display Standard.

The increments are for the display of thermal indices, if displayed is no more than 0.2 for values of indices up to 2.0 and 0.5 for values of indices above 2.0. The system design allows full software control of the acoustic output, entry of new patient identification data or change from a non-foetal to a foetal application, and the system may switch to an appropriate default setting upon powering on. These default setting levels are established before shipping and may be reconfigured by the operator.

For any diagnostic ultrasound systems, Track-3 provides an Output Indices Display Standard. The diagnostic ultrasound systems and its User Manual contain the information regarding an ALARA (As Low As Reasonably Achievable) education program from the clinical end-user and the acoustic output indices, MI and TI. The MI describes the likelihood of cavitation, and the TI offers the predicted maximum temperature rise in tissue as a result of the diagnostic examination. In general, a temperature increase of 2.5°C must be present consistently at one spot for 2 hours to cause possible fetal abnormalities. Avoiding a local temperature rise above 1°C should ensure that no thermally induced biologic effect occurs. When referring to the TI for potential thermal effect, a TI equal to 1 does not mean the temperature will rise 1°C. It only means an increased potential for thermal effects can be expected as the TI increases. A high index does not mean that bioeffects are occurring, but only that the potential exists and there is no consideration in the TI for the scan duration, so minimizing the overall scan time will reduce the potential for effects. These operator control and display features move the safety responsibility from the manufacturer to the operator. So it is very important to have the diagnostic ultrasound systems display the acoustic output indices correctly and the well-educated operator to interpret the value appropriately.

R_F: De-rating factor

In Situ intensity and pressure cannot currently be measured. Therefore, the acoustic power measurement is normally done in the water tank, and when soft tissue replaces water along the ultrasound path, a decrease in intensity is expected. The fractional reduction in intensity caused by attenuation is denoted by the de-rating factor (R_F),

$$R_F = 10^{(-0.1 a \cdot f \cdot z)}$$

Where a is the attenuation coefficient in dB cm⁻¹ MHz⁻¹, f is the transducer center frequency, and z is the distance along the beam axis between the source and the point of interest.

De-rating factor R_F for the various distances and frequencies with attenuation coefficient 0.3 dB cm⁻¹ MHz⁻¹ in homogeneous soft tissue is listed in the following table. An example is if the operator uses 7.5 MHz frequency, the power will be attenuated by .0750 at 5 cm, or 0.3 x 7.5 x 5 = -11.25 dB. The De-rated Intensity is also referred to as ‘.3’ at the end (e.g. Ispta.3).

Distance (cm)	Frequency (MHz)			
	1	3	5	7.5
1	0.9332	0.8128	0.7080	0.5957
2	0.8710	0.6607	0.5012	0.3548
3	0.8128	0.5370	0.3548	0.2113

Distance (cm)	Frequency (MHz)			
	1	3	5	7.5
4	0.7586	0.4365	0.2512	0.1259
5	0.7080	0.3548	0.1778	0.0750
6	0.6607	0.2884	0.1259	0.0447
7	0.6166	0.2344	0.0891	0.0266
8	0.5754	0.1903	0.0631	0.0158

Table 5

$I' = I * R_F$ Where I' is the intensity in soft tissue, I is the time-averaged intensity measured in water.

Tissue model

Tissue temperature elevation depends on power, tissue type, beam width, and scanning mode. Six models are developed to mimic possible clinical situations.

Thermal models	Composition	Mode	Specification	Application type
1 TIS	Soft tissue	Unscanned	Large aperture (> 1 cm ²)	Liver PW
2 TIS	Soft tissue	Unscanned	Small aperture (< 1 cm ²)	Pencil transducer
3 TIS	Soft tissue	Scanned	Evaluated at surface	Breast color
4 TIB	Soft tissue and bone	Scanned	Soft tissue at surface	Muscle color
5 TIB	Soft tissue and bone	Unscanned	Bone at focus	Fetus head PW
6 TIC	Soft tissue and bone	Unscanned / Scanned	Bone at surface	Trans-cranial

Table 6

Soft tissue

Describes low fat content tissue that does not contain calcifications or large gas-filled spaces.

Scanned (auto-scan)

Refers to the steering of successive burst through the field of view, e.g. B and Color mode.

Unscanned

Emission of ultrasonic pulses occurs along a single line of sight and is unchanged until the transducer is moved to a new position. For instance, the PW and M mode.

TI

TI is defined as the ratio of the In Situ acoustic power (W_3) to the acoustic power required to raise tissue temperature by 1°C (W_{deg}),

$$TI = W_3 / W_{deg}$$

Three TIs corresponding to soft tissue (TIS) for abdominal; bone (TIB) for fetal and neonatal cephalic; and cranial bone (TIC) for pediatric and adult cephalic, have been developed for applications in different exams.

An estimate of the acoustic power in milliwatts necessary to produce a 1°C temperature elevation in soft tissue is:

$$W_{deg} = 210 / fc$$

For model 1 to 4, where fc is the center frequency in MHz.

$$W_{deg} = 40 \cdot K \cdot D$$

For model 5 and 6, where K (beam shape factor) is 1.0, D is the aperture diameter in cm at the depth of interest.

MI

Cavitation is more likely to occur at high pressures and low frequencies in pulse ultrasound wave in the tissue, which contains a bubble or air pocket (for instance, the lung, intestine, or scan with gas contrast agents). The threshold under optimum conditions of pulsed ultrasound is predicted by the ratio of the peak pressure to the square root of the frequency.

$$MI = Pr' / \text{sqrt}(fc)$$

Pr' is the de-rated (0.3) peak rare-fractional pressure in Mpa at the point where PII is the maximum, and fc is the center frequency in MHz. PII is the Pulse Intensity Integral that the total energy per unit area carried by the wave during the time duration of the pulse. The peak rare-fractional pressure is measured in hydrophone maximum negative voltage normalized by the hydrophone calibration parameter.

Display guideline

For different operation modes, different indices must be displayed. However, only one index needs to be shown at a time. Display is not required if maximum MI is less than 1.0 for any setting of the operating mode, or if maximum TI is less than 1.0 for any setting of the operating mode. For TI, if the TIS and TIC are both greater than 1.0, the scanners need not be capable of displaying both indices simultaneously. If the index falls below 0.4, no display is needed. The display increments are no greater than 0.2 for index value less than one and no greater than 1.0 for index values greater than one (e.g. 0.4, 0.6, 0.8, 1.2, 3).

Display and report in different modes

For B mode

Display and report only MI, and start from 0.4 if maximum MI > 1.0

For Color mode

Display and report only TIS or TIB, and start from 0.4 if maximum TI > 1.0

For Doppler mode

Display and report only TIS or TIB, and start from 0.4 if maximum TI > 1.0

Below is a simple guideline for the operator when TI exceeds one limit exposure time to $4^{(6-TI)}$ minutes based on the '*National Council on Radiation Protection. Exposure Criteria for Medical Diagnostic Ultrasound: I. Criteria Based on Thermal Mechanisms. Report No.113 1992*'.

Operator control features

The operator should be aware that certain operator controls may affect the acoustic output. It is recommended to use the default (or lowest) output power setting and compensate using Gain control to acquire an image. Other than the output power setting in the Soft Menu, which has the most direct impact on the power; the PRF (Pulse Repetition Frequency), image sector size, frame rate, depth, and focal position also slightly affect the output power. The default setting is normally around 70% of the allowable power, depending on the exam type.

Transducer surface temperature rise

The table below lists the measured surface temperature rise from ambient ($23^{\circ}\text{C} \pm 3^{\circ}\text{C}$) of transducers used on the system. The temperatures were measured in accordance with EN 60601-2-37 cl.201.11 and cl.201.13 with controls and settings positioned to give maximum temperatures.

Test	External use (°C)			Non-external Use (°C)
	C52A	P42A	L115A	E94A
Simulated use	1.5	1.4	3.0	1.9
Still air	7.3	3.6	6.5	3.3

Table 7 Transducer surface temperature rise

Intended use

The system is designed for use as a diagnostic tool and should only be operated by someone who has received proper training in the use and operation of a diagnostic ultrasound system. This system produces images derived from sound echoes; those images must be interpreted by a qualified medical professional. This system in no way interprets these images or provides a medical diagnosis of the patient being examined.

The system has successfully completed compliance tests for IEC 60601-1:2005 3rd ed., IEC 60601-1-2:2007 3rd ed., IEC 60601-2-37:2007 2nd ed. medical standards for the configuration as originally installed. To maintain compliance with the stated safety and EMI standards, we recommend use of medical grade peripherals only. Use of non-medical grade peripherals will result in non-compliance of safety and EMI standards. Non-conformance to these standards can produce risks to the patient and operator of this equipment. We cannot be held liable for changes to the system topology that no longer conform to the stated safety and EMI standards. Changes to the system topology may make it necessary to retest the complete system for compliance to these standards. The User Manual refers to the potential for connecting the system to peripherals such as VCRs, TVs, and printers. Note that we have not performed compliance tests to the stated standards with these types of devices connected to the system. Any peripheral device, such as a network connection, etc. connected to the system must conform to the IEC standards outlined above (i.e., IEC 60601-1:2005 3rd ed., IEC 60601-1-2:2007 3rd ed., and IEC 60601-2-37:2007 2nd ed.)

The system (without peripherals) is suitable for use within the patient environment, as defined by the following:



- The user should never simultaneously make contact with the patient and the inside of any equipment where a protective cover of any kind is removed. This includes the protective covers for the transducer holders containing the ultrasound transducer and power modules located at the patient table.
- When using E94A endocavity transducers, the transducers must be protected with a transducer sheath.

The patient environment is defined as shown in the following figure.

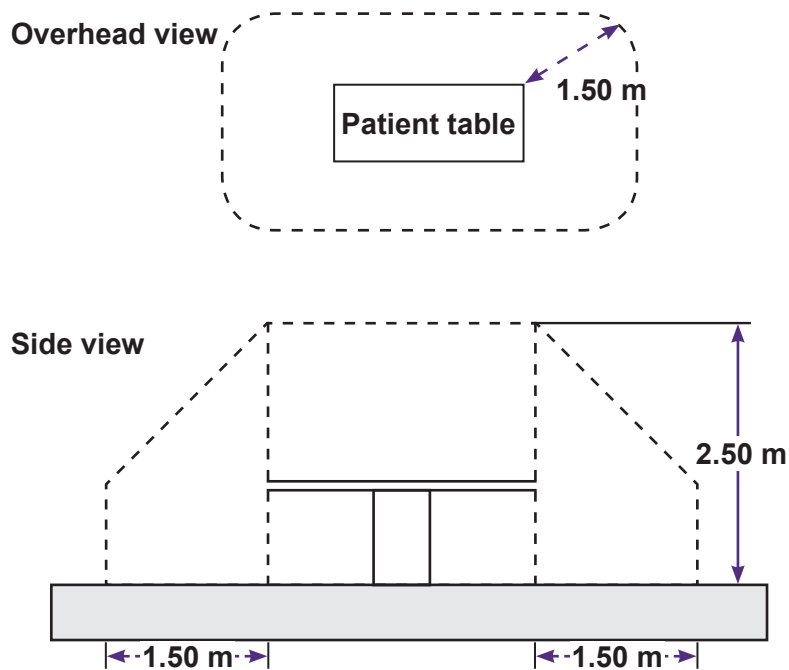

Figure 4 Patient environment

Portable and mobile RF communications equipment can affect medical electrical equipment such as the system and should not be used in the patient environment.



The system should not be used adjacent to or stacked with other equipment. If adjacent or stacked use is necessary, the system should be observed to verify normal operation in the configuration in which it will be used.



If there is a certain frequency of image interference, there is a need of isolation or filtering of the RF signal.



If the system is interfered by power or signal cable, the image quality may be reduced or abnormally displayed. Such kind of interfered images could easily be identified and differentiated from the physiological characteristics of patient and longer clinical time consumed but wouldn't have any diagnostic accuracy issue.

Indications for use

The following tables provide Diagnostic Ultrasound Indications for Use forms for the transducers offered with the Qisda Diagnostic Ultrasound System.

DIAGNOSTIC ULTRASOUND INDICATIONS FOR USE FORM								
System: UH100 Diagnostic Ultrasound System								
Transducer: C52A (2-5 MHz Curved Linear Array R=50 mm)								
Intended Use: Diagnostic ultrasound imaging or fluid flow analysis of the human body as follows:								
Clinical application		Mode of operation						
General (Track 1 only)	Specific (Track 1 and 3)	B	M	PWD	Color Doppler	Power Doppler	Comb Modes*	Tissue Harmonic Imaging
Fetal imaging and others	Fetal	X	X	X	X	X	Note 1	X
	Abdominal	X	X	X	X	X	Note 1	X
	Small organ (thyroid, breast, etc.)							
	Pediatric							
	Neonatal cephalic							
	Adult cephalica							
	Musculo-skeletal (Conven.)							
	Musculo-skeletal (Superficial)							
	Other (Ob/Gyn)	X	X	X	X	X	Note 1	X
Cardiac	Cardiac adult							
	Cardiac pediatric							
	Other (specify)							
Peripheral vessel	Peripheral vessel							
	Other (specify)							

*Combined modes include: B/M; B/PW; B/Color Doppler; B/Power Doppler; B/Color Doppler/PWD and B/Power Doppler/PWD

DIAGNOSTIC ULTRASOUND INDICATIONS FOR USE FORM								
System: UH100 Diagnostic Ultrasound System								
Transducer: L115A (5-11 MHz Linear Array)								
Intended Use: Diagnostic ultrasound imaging or fluid flow analysis of the human body as follows:								
Clinical application		Mode of operation						
General (Track 1 only)	Specific (Track 1 and 3)	B	M	PWD	Color Doppler	Power Doppler	Comb Modes*	Tissue Harmonic Imaging
Fetal imaging and others	Fetal							
	Abdominal							
	Small organ (thyroid, breast, etc.)	X	X	X	X	X	Note 1	X
	Pediatric							
	Neonatal cephalic							
	Adult cephalica							
	Musculo-skeletal (Conven.)	X	X	X	X	X	Note 1	X
	Musculo-skeletal (Superficial)	X	X	X	X	X	Note 1	X
	Other (Ob/Gyn)							
Cardiac	Cardiac adult							
	Cardiac pediatric							
	Other (specify)							
Peripheral vessel	Peripheral vessel	X	X	X	X	X	Note 1	X
	Other (specify)							

*Combined modes include: B/M; B/PW; B/Color Doppler; B/Power Doppler; B/Color Doppler/PWD and B/Power Doppler/PWD

DIAGNOSTIC ULTRASOUND INDICATIONS FOR USE FORM								
System: UH100 Diagnostic Ultrasound System								
Transducer: P42A (2-4 MHz Phased Array)								
Intended Use: Diagnostic ultrasound imaging or fluid flow analysis of the human body as follows:								
Clinical application		Mode of operation						
General (Track 1 only)	Specific (Track 1 and 3)	B	M	PWD	Color Doppler	Power Doppler	Comb Modes*	Tissue Harmonic Imaging
Fetal imaging and others	Fetal							
	Abdominal	X	X	X	X	X	Note 1	X
	Small organ (thyroid, breast, etc.)							
	Pediatric							
	Neonatal cephalic							
	Adult cephalica							
	Musculo-skeletal (Conven.)							
	Musculo-skeletal (Superficial)							
	Other (Ob/Gyn)							
Cardiac	Cardiac adult	X	X	X	X	X	Note 1	X
	Cardiac pediatric	X	X	X	X	X	Note 1	X
	Other (specify)							
Peripheral vessel	Peripheral vessel							
	Other (specify)							

*Combined modes include: B/M; B/PW; B/Color Doppler; B/Power Doppler; B/Color Doppler/PWD and B/Power Doppler/PWD

DIAGNOSTIC ULTRASOUND INDICATIONS FOR USE FORM								
System: UH100 Diagnostic Ultrasound System								
Transducer: E94A (4-9 MHz Micro-curved Linear Array)								
Intended Use: Diagnostic ultrasound imaging or fluid flow analysis of the human body as follows:								
Clinical application		Mode of operation						
General (Track 1 only)	Specific (Track 1 and 3)	B	M	PWD	Color Doppler	Power Doppler	Comb Modes*	Tissue Harmonic Imaging
Fetal imaging and others	Fetal	X	X	X	X	X	Note 1	X
	Abdominal							
	Small organ (thyroid, breast, etc.)							
	Pediatric							
	Neonatal cephalic							
	Adult cephalica							
	Trans-rectal	X	X	X	X	X	Note 1	X
	Trans-vaginal	X	X	X	X	X	Note 1	X
	Trans-urethral							
	Trans-esophageal (non-Card)							
	Musculo-skeletal (Conven.)							
	Musculo-skeletal (Superficial)							
Other (Ob/Gyn)	X	X	X	X	X	Note 1	X	
Cardiac	Cardiac adult							
	Cardiac pediatric							
	Other (specify)							
Peripheral vessel	Peripheral vessel							
	Other (specify)							

*Combined modes include: B/M; B/PW; B/Color Doppler; B/Power Doppler; B/Color Doppler/PWD and B/Power Doppler/PWD

3

Get Started

System overview

Front and side views

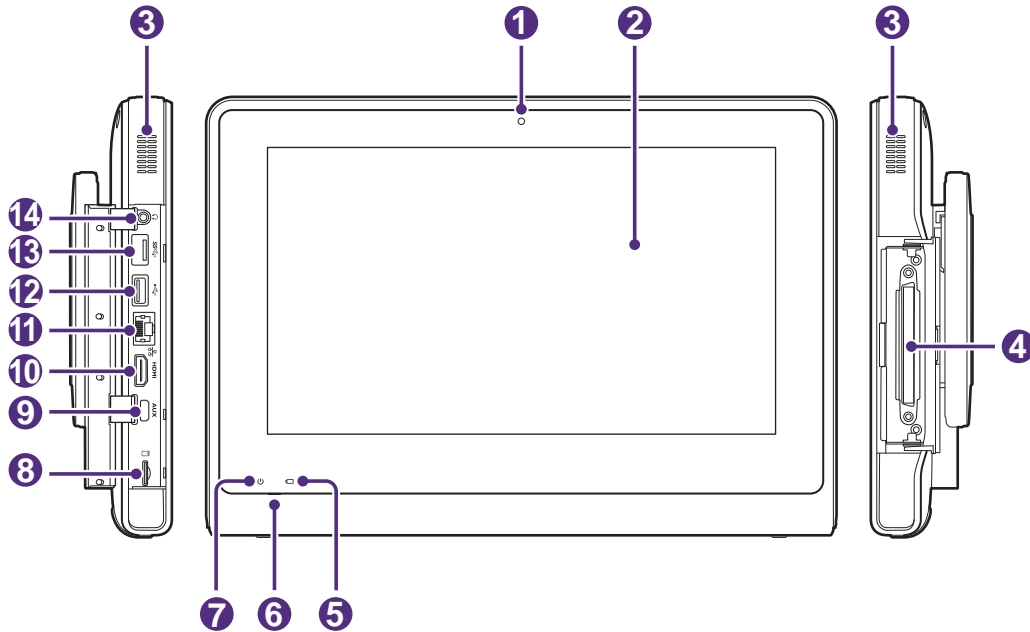

No.	Item	Function
1	Camera lens	Used to take pictures or record videos.
2	Touchscreen	Display system information and allows you to perform operations using different gestures.
3	Speakers	Built-in speakers for playing sounds, which are software-controlled.
4	Transducer connection socket	Connect a transducer to the system.
5	Battery indicator	When the system is connected to power: <ul style="list-style-type: none">• Steadily on orange when the battery is charging.• Steadily on green after the battery is charged. When the system is connected to power: <ul style="list-style-type: none">• Steadily on orange when the battery is charging.• Steadily on green after the battery is charged.
6	Microphone	Used for voice recording.
7	Power indicator	Blink blue after the system enters Sleep mode.
8	MicroSD card slot	Insert a microSD card into the microSD card slot to access files stored in the card.

No.	Item	Function
9	AUX port	Services only
10	HDMI port	Connect the system to an HDMI (High-Definition Multimedia Interface) device.
11	Ethernet socket	Connect the system to an Ethernet-based network.
12	USB 2.0 port	Connect the system to USB 2.0/3.0 devices, such as keyboards, pointing devices, cameras or portable storage devices.
13	USB 3.0 port	
14	Headphone jack	Connect the system to an audio device, such as headphones or speakers.

Rear and top/bottom views

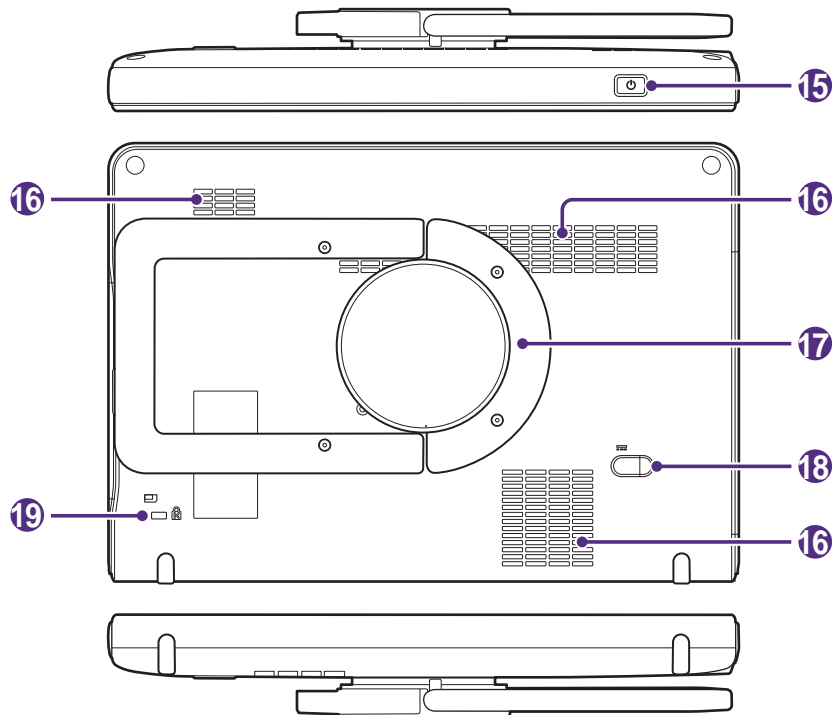

No.	Item	Function
15	Power button	Press and hold the Power button to turn on/off the system.
16	Ventilation slots	Release excessive heat during operation to keep the system in a safe operating temperature.
17	Rotating stand	<ul style="list-style-type: none"> • Pull the rotating stand out to sustain the system on a flat surface. • Can be used as a handle to carry the system around.
18	Power input socket	
19	Anti-theft lock slot	Used to lock the system securely to a solid surface to protect it from theft.

Insert a microSD card (optional)



- The system supports microSD cards (formatted in FAT32 only) up to 64 GB in size.
- The microSD card is available only by separate purchase.

1. Align the microSD card with the mark next to the microSD card slot.
2. Fully insert the microSD card into the card slot until it clicks into place.

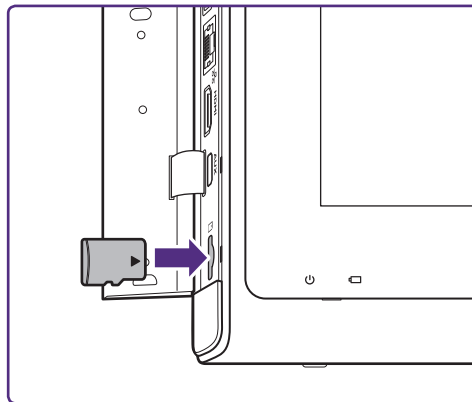

Use the stand

1. Rotate the rotating stand counterclockwise by 90 degree.

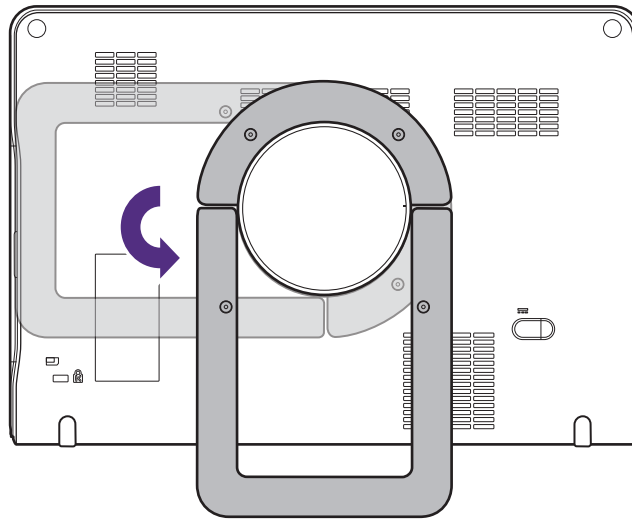

2. Gently pull out the rotating stand to the degree that suits your preferred viewing angle.

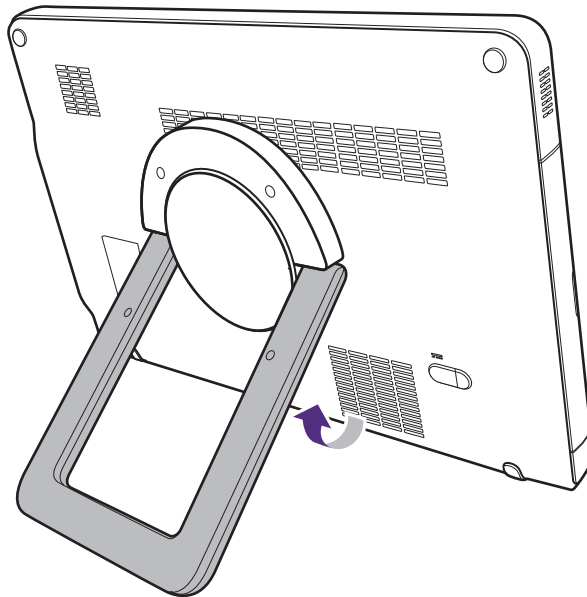

Charge the system

The system is only partially charged when first unpacked. Charge the battery fully for 3 hours before using the system for the first time.



- Use only the supplied power adapter and power cord for charging.
- Do not try to repair or replace the battery or the power adapter. Any attempt to disassemble the system and the supplied accessories may cause damage to the system or result in personal injury.

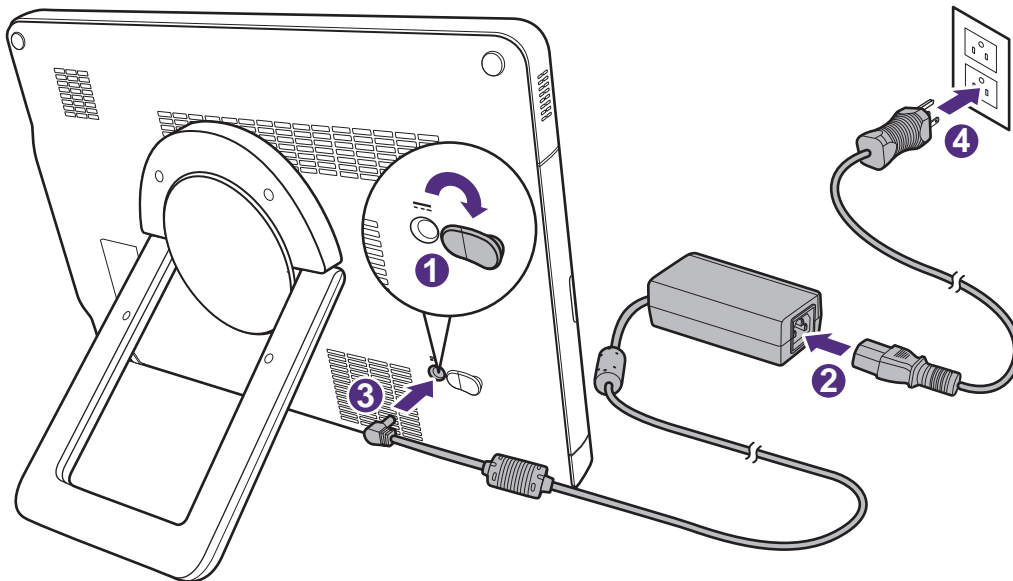

1. Lift the protective rubber cover open.
2. Insert the supplied power cord's connector into the power adapter.
3. Connect the power adapter's connector into the system's power input socket.
4. Plug the power cord's three-wire grounding plug into an electric outlet to start charging. The battery indicator lights up in solid orange.



- Keep good ventilation during charging. Do not cover the power adapter with paper or objects that will reduce cooling.
- Do not interrupt the connection during charging to avoid possible damage.

5. After the battery is fully charged, the battery indicator turns green. Remove the power adapter and the power cord from both the power outlet and the system.



If the system is not in use for a long time, the battery will completely run out and may not be powered on immediately even when it is connected to power. When this occurs, fully charge the system for 3 hours before use.

Connect the transducer

Flip the transducer cover open **a** and insert the transducer carefully into the transducer connection socket until it is locked in place.

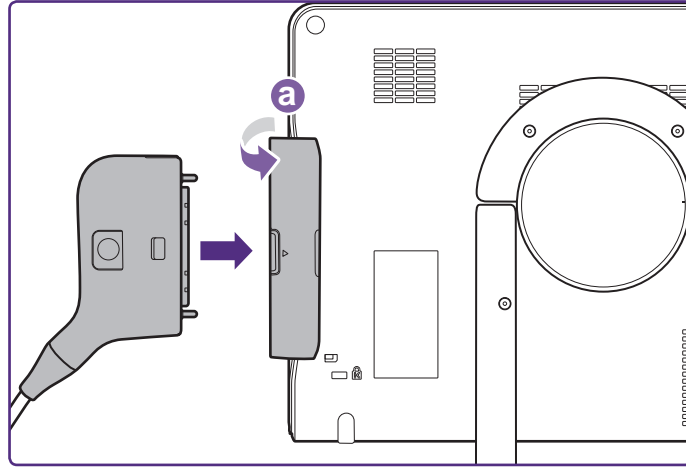

Remove the transducer

Press and hold the release latch, and carefully pull out the transducer.

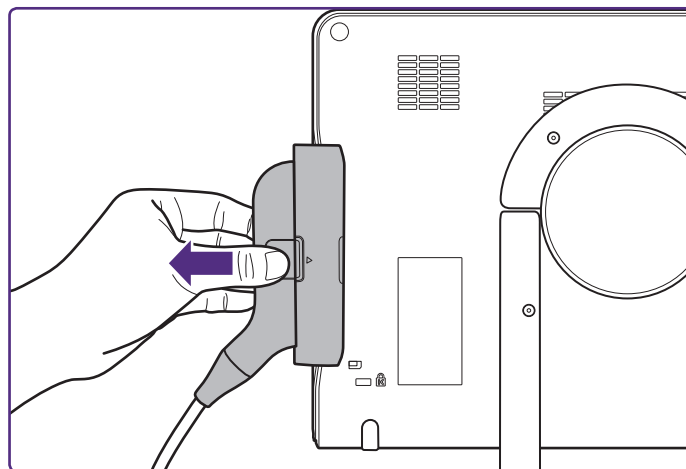

Use the system on the go

1. Rotate the rotating stand clockwise by 90 degree.

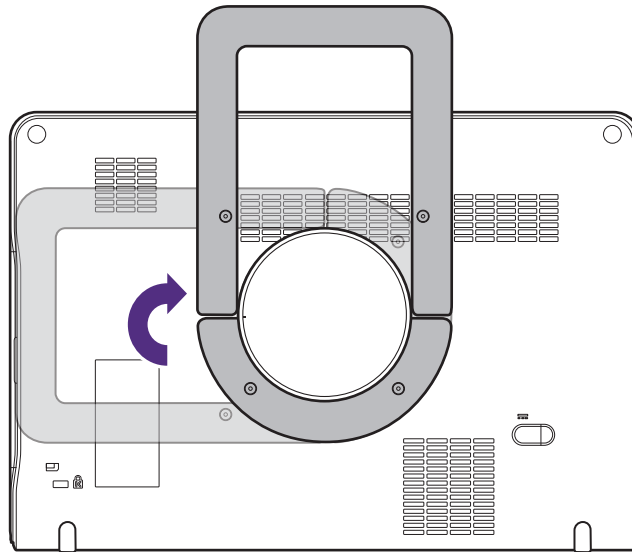

2. Use the rotating stand as a handle to carry the system around.

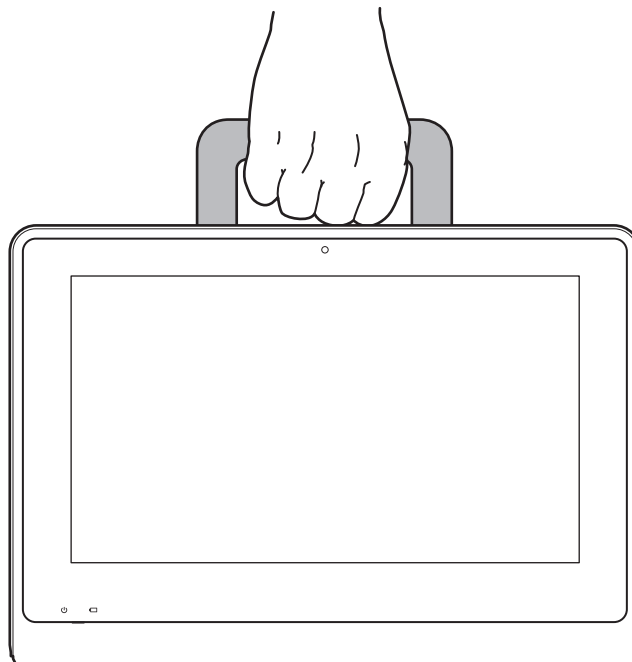

Wall-mount the system

The hole pattern on the rear side of the system is compliant with VESA standard. Therefore, the operator can install the system on any VESA wall mounts, desktop or ceiling mounts.

1. Hold the system firmly and position it precisely to the front of the mount plate where the hole patterns on both the back of the system and the plate meet.
2. Hold an appropriate screwdriver and carefully drive four screws to tighten the system with the mount plate.

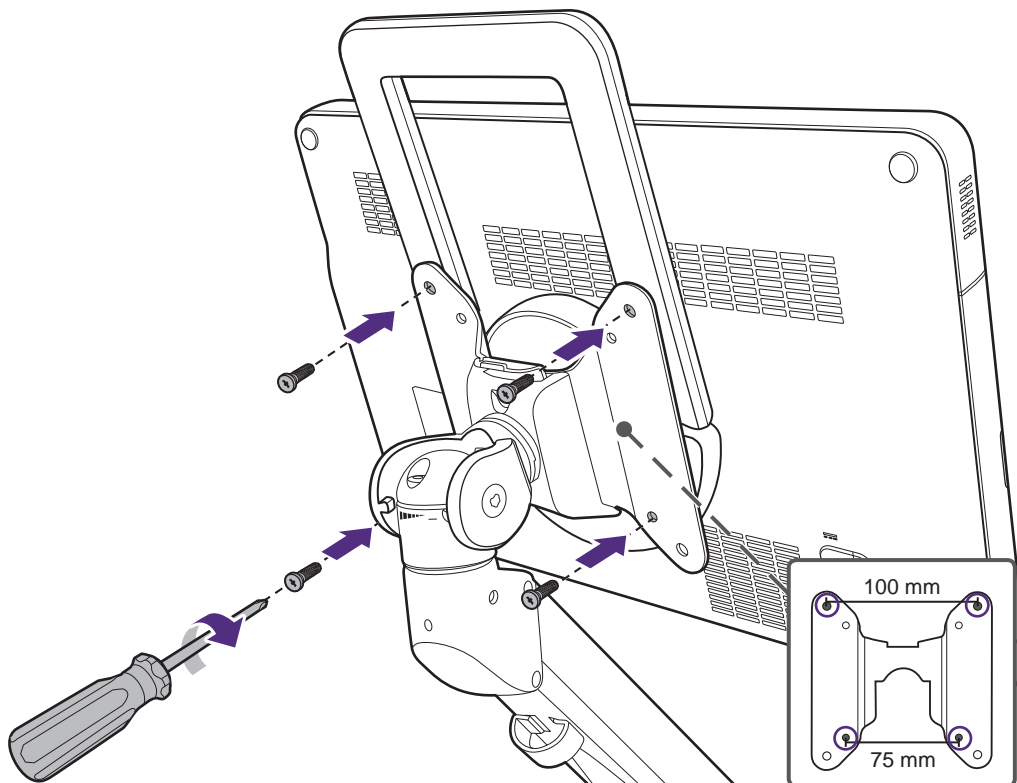

Output the system display to an HDMI-enabled TV or monitor

1. Insert one end of an HDMI cable to the system's HDMI port. Ensure that the arrow side faces up.
2. Insert the other end of the HDMI cable to your HDMI-enabled TV's or monitor's HDMI port.
3. On the TV or monitor, select the proper input source.



Refer to the documentation of your HDMI-enabled television or monitor for detailed connections and settings.

4

Basic operations

To conduct an ultrasound exam, complete the general procedure:

1. Connect the transducer ([See page 46](#)).
2. Turn on the system ([See page 49](#)).
3. Add a new patient ([Patient screen](#)), or load a work list ([Work list screen](#)).
4. Select an exam type and preset ([Preset screen](#)).
5. Start real-time imaging ([Imaging screen \(Real-time\)](#)).
6. Set the transducer orientation ([See page 60](#)).
7. Select a scan mode and adjust image controls ([See page 70](#)).
8. When the desired anatomy is shown, freeze the image ([See page 62](#)).
9. Add annotations or measurements ([Imaging screen \(Frozen\)](#)).
10. Save or print the image ([See page 66](#)).
11. (Optional) Review the images ([See page 67](#)), generate a report and export the exam ([See page 69](#)).
12. End the exam ([See page 69](#)).

Please refer to the following sections for detailed instructions.

Turn on the system

Press and hold the Power button.

- If a transducer is connected, the system enters the imaging screen in B-mode after system startup.

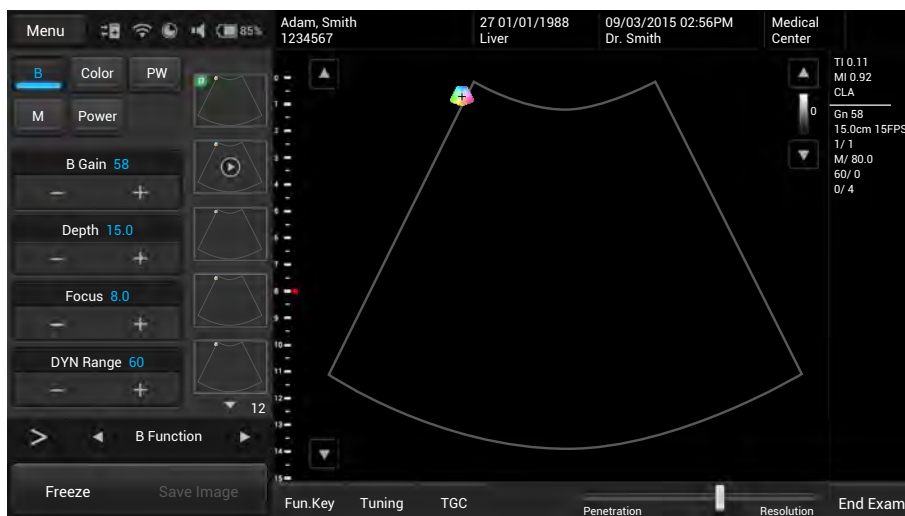

- If no transducer is connected, the system enters the system menu screen after system startup.



-
- If a transducer is connected and the system displays the message “No probe is connected”, remove and then re-connect the transducer. If the system still cannot detect the transducer, turn off the system. Wait for a few seconds and restart the system.
-

To turn off the system

Press and hold the Power button until the pop-up menu appears on the screen. Touch **Power off > OK**.

-
- If the system does not respond to any operations, press and hold the Power button to forcefully turn off the system.
 - If the system is turned off abnormally, powering on the system the next time will take longer than usual for a system hardware check.
-



- Do not connect the system to any external drives until the startup process completes to avoid damage or loss of data.
- If an error message occurs after system startup, turn off the system immediately and contact the service technician for help.

Identify the main screen layout

System menu screen

Touch **Menu** to display the following system menu screen. Touch an icon to perform its function.

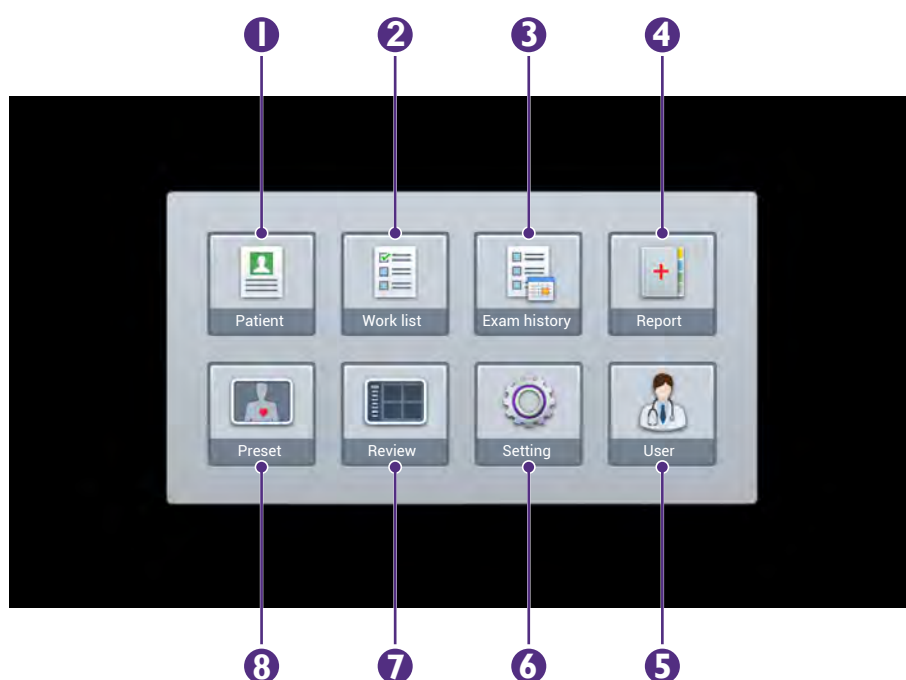

Figure 5 System menu screen

No.	Function	Description
1	Patient	Edit current or add new patient information.
2	Work list	Load the DICOM Modality Worklist (MWL) that contains patient information as well as the requested procedure electronically via the MWL query.
3	Exam history	View a list of patients with their exam results. The operator can proceed with unfinished exams/reviews, or export exams according to the selection criteria all at once.
4	Report	Display exam information including patient data, exam type, study specific data, comments and saved ultrasound images.
5	User	Edit current or add new users.
6	Setting	Set up and customize the system based on the operator's habitual needs.

No.	Function	Description
7	Review	View, add annotations and measurements to, and export a saved exam.
8	Preset	Select the predefined preset compatible with the connected transducer for optimized image control settings.

Imaging screen (Real-time)

With the transducer connected correctly, the system automatically enters the real-time imaging screen after starting the ultrasound software.

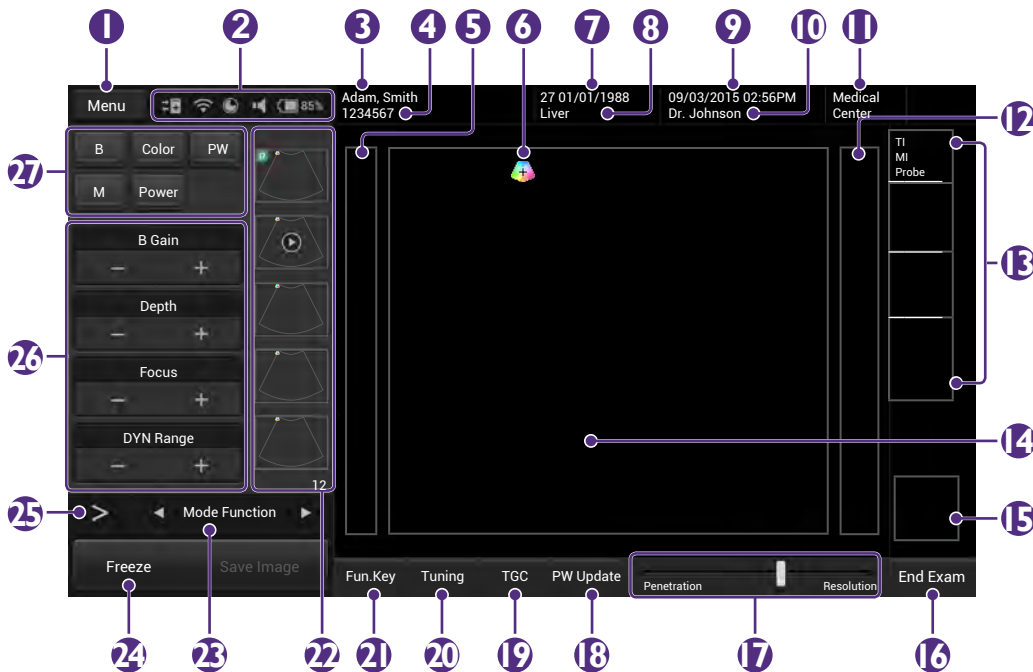

Figure 6 Real-time imaging screen (example)

No.	Function	No.	Function
1	System menu button Enter the system menu screen.	2	System toolbar Display current system settings.
3	Patient name	4	Patient ID
5	Depth scale	6	Transducer orientation icon
7	Patient DOB (date of birth)	8	Application name
9	Date and time	10	Operator name
11	Institution name	12	Grayscale/spectrum wedge
13	Scan properties display area Display information about the current scan.	14	Ultrasound imaging area Display the 2D imaging window in all scan modes. When scanning in M/PW/Triple modes, the Time Series window displays under the 2D imaging window.