

FCC Radio Partial Test Report

FCC ID: VRQ-GT-200

This report concerns (check one): Original Grant Class II Change

Project No. : 1601041
Equipment : 3G GPS Tracker
Model Name : GT-200, GT-200AP, GT-200BP, GT-200CP,
GT-200DP, GT-200HP, GT-200MP, GT-200UP,
GT-200VP
Applicant : Navisys Technology Corp.
Address : 2F, No.56, Park Ave.II, Science-Based Industrial
Park, Hsinchu 30844, Taiwan

Date of Receipt : Mar. 29, 2016
Date of Test : Mar. 29, 2016 ~ May 10, 2016
Issued Date : May 11, 2016
Tested by : BTL Inc.

Technical Manager :

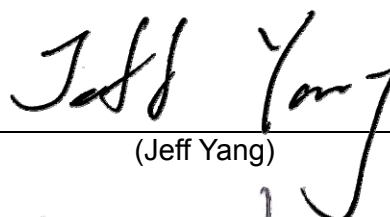

(Jeff Yang)

Authorized Signatory :



(Sean Chen)

B T L I N C .

B1, No.37, Lane 365, Yang Guang St.,
Nei-Hu District, Taipei City 114, Taiwan.
TEL:+886-2-2657-3299 FAX: +886-2- 2657-3331

Declaration

BTL represents to the client that testing is done in accordance with standard procedures as applicable and that test instruments used has been calibrated with standards traceable to international standard(s) and/or national standard(s).

BTL's reports apply only to the specific samples tested under conditions. It is manufacture's responsibility to ensure that additional production units of this model are manufactured with the identical electrical and mechanical components. **BTL** shall have no liability for any declarations, inferences or generalizations drawn by the client or others from **BTL** issued reports.

BTL's report must not be used by the client to claim product certification, approval, or endorsement by NVLAP, NIST, or any agency of the Federal Government.

This report is the confidential property of the client. As a mutual protection to the clients, the public and **BTL-self**, extracts from the test report shall not be reproduced except in full with **BTL's** authorized written approval.

BTL's laboratory quality assurance procedures are in compliance with the **ISO Guide17025** requirements, and accredited by the conformity assessment authorities listed in this test report.

Limitation

For the use of the authority's logo is limited unless the Test Standard(s)/Scope(s)/Item(s) mentioned in this test report is (are) included in the conformity assessment authorities acceptance respective.

Table of Contents	Page
REPORT ISSUED HISTORY	5
1 . CERTIFICATION	6
2 . SUMMARY OF TEST RESULTS	7
2.1 TEST FACILITY	8
2.2 MEASUREMENT UNCERTAINTY	8
3 . GENERAL INFORMATION	9
3.1 GENERAL DESCRIPTION OF EUT	9
3.2 DESCRIPTION OF TEST MODES AND TEST CONDITION	10
3.3 BLOCKDIAGRAMSHOWINGTHECONFIGURATIONOFSYSTEMTESTED	11
3.4 DESCRIPTION OF SUPPORT UNITS	11
4 . TEST RESULT	12
4.1 OUTPUT POWER MEASUREMENT	12
4.1.1 LIMIT	12
4.1.2 TEST PROCEDURE	12
4.1.3 TESTSETUP LAYOUT	13
4.1.4 TEST DEVIATION	13
4.1.5 TEST RESULTS	13
4.2 RADIATED EMISSIONS MEASUREMENT	14
4.2.1 LIMIT	14
4.2.2 TEST PROCEDURES	14
4.2.3 TESTSETUP LAYOUT	14
4.2.4 TESTDEVIATION	14
4.2.5 TEST RESULTS	14
4.3 PEAK TO AVERAGE RATIO MEASUREMENT	15
4.3.1 LIMIT	15
4.3.2 TEST PROCEDURES	15
4.3.3 TESTSETUP LAYOUT	15
4.3.4 TESTDEVIATION	15
4.3.5 TEST RESULTS	15
4.4 FREQUENCY STABILITY MEASUREMENT	16
4.4.1 LIMIT	16
4.4.2 TEST PROCEDURES	16
4.4.3 TESTSETUP LAYOUT	16
4.4.4 TESTDEVIATION	16
4.4.5 TEST RESULTS	16
5. LIST OF MEASUREMENT EQUIPMENTS	17

Table of Contents	Page
6. EUT TEST PHOTO	18
ATTACHMENT A - OUTPUT POWER	21
ATTACHMENT B - RADIATED EMISSION	23
ATTACHMENT C – PEAK TO AVERAGE RATIO	48
ATTACHMENT D - FREQUENCY STABILITY	50

REPORT ISSUED HISTORY

Issued No.	Description	Issued Date
BTL-FCCP-1-1601041	Original Issue.	May 11, 2016

1. CERTIFICATION

Equipment : 3G GPS Tracker
Brand Name : Navisys
Model Name : GT-200, GT-200AP, GT-200BP, GT-200CP, GT-200DP, GT-200HP, GT-200MP, GT-200UP, GT-200VP
Applicant : Navisys Technology Corp.
Manufacturer : Uong Xing Technology Co., LTD
Address : No.416, Sec.1, Beising Rd., Jhudong Township, Hsinchu Country 310, Taiwan
Date of Test : Mar. 29, 2016 ~ May 10, 2016
Test Sample : Engineering Sample
Standard(s) : 47 CFR FCC Part 22 Subpart H
47 CFR FCC Part 2
ANSI/TIA-603-D-2010
KDB 971168 D01 Power Meas License Digital Systems v02r02

The above equipment has been tested and found compliance with the requirement of the relative standards by BTL Inc.

The test data, data evaluation, and equipment configuration contained in our test report (Ref No. BTL-FCCP-1-1601041) were obtained utilizing the test procedures, test instruments, test sites that has been accredited by the Authority of TAF according to the ISO-17025 quality assessment standard and technical standard(s).

Test result included in this report is only for the WCDMA Band V part.

2. SUMMARY OF TEST RESULTS

Test procedures according to the technical standard(s):

FCC Part 22 Subpart H & Part 2			
Standard(s) Section	Test Item	Judgment	Tested By
2.1046 22.913(a)	Radiated power	PASS	Kay Wu
2.1046 24.232(c)	Conducted Output Power	PASS	Kay Wu
2.1053 22.917(a)	Radiated Spurious Emissions	PASS	Kay Wu
-	Peak To Average Ratio	PASS	Kay Wu
2.1055 22.355	Frequency Stability	PASS	Kay Wu

NOTE:

- (1) "N/A" denotes test is not applicable to this device.
- (2) Due to the Cinterion Wireless Module PHS8-P (Report Number: MDE_CINTE_1108_FCCa, MDE_CINTE_1108_FCCd and MDE_CINTE_1108_FCCe and model: PHS8-P) of this 3G GPS Tracker has been certified (FCC ID: QIPPHS8-P), above test items were criticized and reconfirmed in this report.

2.1 TEST FACILITY

Conducted Test:

TR03: (FCC RN:949005; FCC DN:TW1082)

No. 68-1, Ln. 169, Sec.2, Datong Rd., Xizhi Dist., New Taipei City 221, Taiwan

Radiated emission Test (Below 1 GHz):

CB11: (FCC RN:949005; FCC DN:TW1082; IC Assigned Code:20088)

No. 68-1, Ln. 169, Sec.2, Datong Rd., Xizhi Dist., New Taipei City 221, Taiwan

Radiated emission Test (Above 1 GHz):

CB11: (FCC RN:949005; FCC DN:TW1082; IC Assigned Code:20088)

No. 68-1, Ln. 169, Sec.2, Datong Rd., Xizhi Dist., New Taipei City 221, Taiwan

2.2 MEASUREMENT UNCERTAINTY

Where relevant, the following measurement uncertainty levels have been estimated for tests performed on the EUT as specified in CISPR 16-4-2. The BTL measurement uncertainty is less than the CISPR 16-4-2 U_{CISPR} requirement.

The reported uncertainty of measurement $y \pm U$, where expanded uncertainty U is based on a standard uncertainty multiplied by a coverage factor of $k=2$, providing a level of confidence of approximately 95%.

A. Radiated emission test:

Test Site	Method	Measurement Frequency Range	Ant. H / V	U, (dB)
CB11 (3m)	CISPR	30 MHz ~ 200 MHz	V	3.06
		30 MHz ~ 200 MHz	H	2.58
		200 MHz ~ 1,000 MHz	V	3.50
		200 MHz ~ 1,000 MHz	H	3.10

Test Site	Method	Measurement Frequency Range	Ant. H / V	U, (dB)
CB11 (3m)	CISPR	1GHz ~ 6GHz	V	4.14
		1GHz ~ 6GHz	H	4.14

Test Site	Method	Measurement Frequency Range	Ant. H / V	U, (dB)
CB11	CISPR	6GHz ~ 18GHz	V	5.34
		6GHz ~ 18GHz	H	5.34

Note: Unless specifically mentioned, the uncertainty of measurement has not been taken into account to declare the compliance or non-compliance to the specification.

3. GENERAL INFORMATION

3.1 GENERAL DESCRIPTION OF EUT

Equipment	3G GPS Tracker	
Brand Name	Navisys	
Model Name	GT-200, GT-200AP, GT-200BP, GT-200CP, GT-200DP, GT-200HP, GT-200MP, GT-200UP, GT-200VP	
Model Difference	All models are identical to each other except model designation.	
Modulation Type	WCDMA	Uplink: BPSK Downlink: QPSK
	WCDMA(HSDPA/HSUPA)	16QAM/64QAM
Operation Frequency	WCDMA	826.4 ~ 846.6 MHz
Max. ERP Power	WCDMA	21.07 dBm
Antenna Type	Fixed Internal Antenna	
Antenna Gain	-1 dBi	
Hardware Version	V05	
Software Version	V20	
Power Source	#1 Supplied from USB port. #2 Supplied from rechargeable Li-Polymer battery.	
Power Rating	#1 I/P: DC 4.5 - 5.5V, 1.0 - 1.5A #2 I/P: DC 3.15 - 4.3V, 1430mAh	
HSPA features	3GPP Release 6	

Note:

1. For a more detailed features description, please refer to the manufacturer's specifications or the user's manual.

3.2 DESCRIPTION OF TEST MODES AND TEST CONDITION

Pre-Scan has been conducted to determine the worst-case mode from all possible combinations between available modulations, data rates, XYZ axis and antenna ports

The worst case was found when positioned on Y-plane for ERP and Y-axis for radiated emission.

Following channel(s) was (were) selected for the final test as listed below:

WCDMA MODE			
Test Item	Available Channel	Tested Channel	Mode
ERP	4132 to 4233	4132, 4182, 4233	WCDMA
Conducted Output Power	4132 to 4233	4132, 4182, 4233	WCDMA
Radiated Emission	4132 to 4233	4132, 4182, 4233	WCDMA
Peak to Average Ratio	4132 to 4233	4132, 4182, 4233	WCDMA
Frequency Stability	4132 to 4233	4132, 4182, 4233	WCDMA

Note: This device was tested under all bandwidths, RB configurations and modulations. The worst case was found in **BPSK** modulation.

EUT TEST CONDITIONS:

Test Item	Environmental Conditions	Test Voltage
ERP	25°C, 45%RH	DC 3.7V
Conducted Output Power	25°C, 45%RH	DC 3.7V
Radiated Emission	25°C, 45%RH	DC 3.7V
Peak to Average Ratio	25°C, 45%RH	DC 3.7V
Frequency Stability	25°C, 45%RH	DC 3.15 - 4.3V

3.3 BLOCKDIGRAMSHOWINGTHECONFIGURATIONOFSYSTEMTESTED

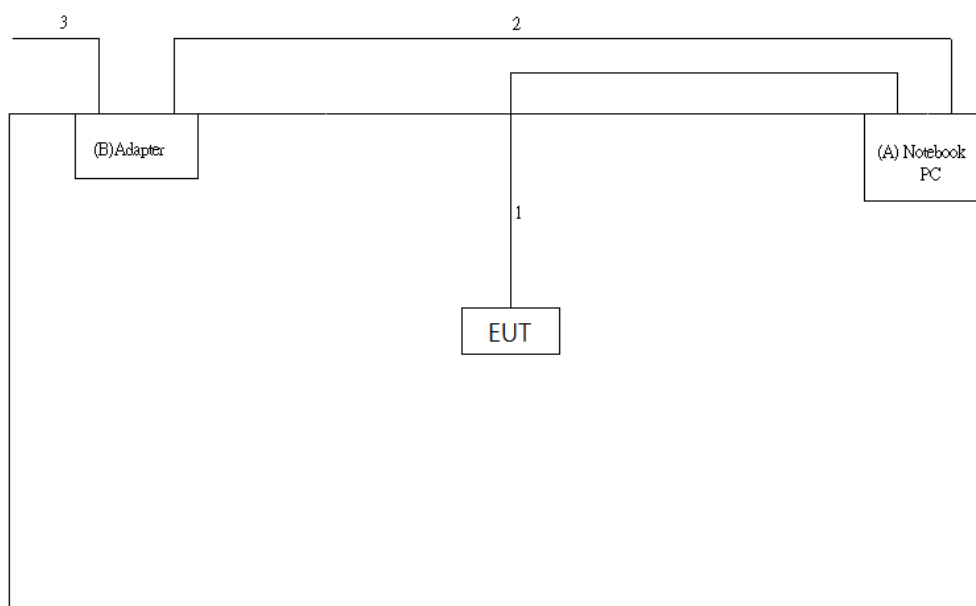

3.4 DESCRIPTION OF SUPPORT UNITS

The EUT has been tested as an independent unit together with other necessary accessories or support units. The following support units or accessories were used to form a representative test configuration during the tests.

Item	Equipment	Mfr/Brand	Model/Type No.	FCC ID	Series No.
A	Notebook PC	ACER	MS2392	DOC	NXMPFTA0014380598B6600
B	Adapter	ACER	PA-1450-26	DOC	KP0450300143102875PE01

Item	Shielded Type	Ferrite Core	Length	Note
1	NO	NO	0.45m	USB Cable
2	NO	NO	1m	Power Cable
3	NO	NO	1.8m	Power Cable

Note: EUT is battery supplied, so after set up, the Notebook PC is removed.

4. TEST RESULT

4.1 OUTPUT POWER MEASUREMENT

4.1.1 LIMIT

Mobile / Portable station are limited to 7 watts e.r.p.

4.1.2 TEST PROCEDURE

EIRP/ERP:

1. All measurements were done at low, middle and high operational frequency range. RBW and VBW setting:
Set the RBW \geq OBW.
Set VBW $\geq 3 \times$ RBW.
Set span $\geq 2 \times$ RBW
Sweep time=auto couple
Detector=peak
Ensure that the number of measurement points \geq span/RBW
Trace mode=max hold
Allow trace to fully stabilize
Use the peak marker function to determine the peak amplitude level
2. Substitution method is used for E.I.R.P measurement. In the semi-anechoic chamber, EUT placed on the 0.8m height of Turn Table, rotated the table around 360 degrees to search the maximum radiation power and receiver antenna shall be rotated vertical and horizontal polarization and moved height from 1m to 4m to find the maximum polar radiated power. The "Read Value" is the spectrum reading the maximum power value.
3. The substitution horn antenna is substituted for EUT at the same position and signals generator export the CW signal to the substitution antenna via a tx cable. Rotated the Turn Table and moved receiving antenna to find the maximum radiation power. Adjust output power level of S.G to get a Value of spectrum reading equal to "Read Value" of step b. Record the power level of S.G
5. E.R.P power can be calculated form E.I.R.P power by subtracting the gain of Integral, E.R.P power=E.I.P.R power-2.15dBi.

Conducted Power:

The EUT was set up for the maximum power with WCDMA link data modulation and link up with simulator. Set the EUT to transmit under low, middle and high channel and record the power level shown on simulator.

4.1.3 TESTSETUP LAYOUT

ERP Power Measurement

Below 1G

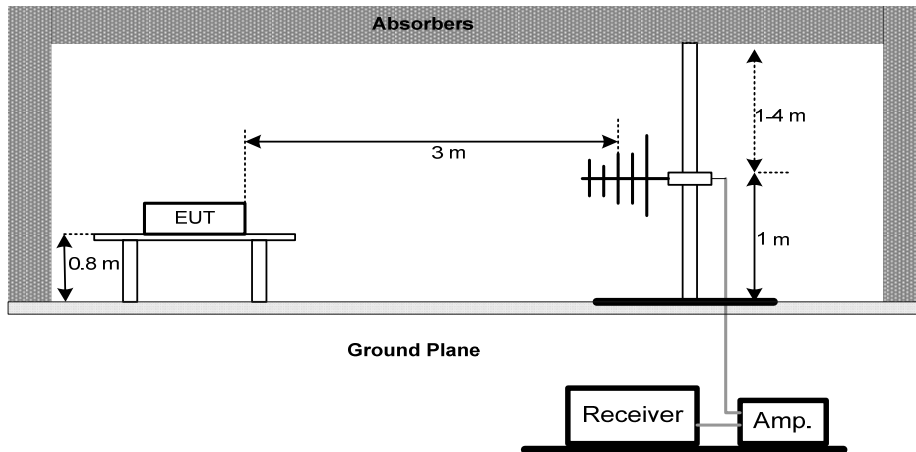

Above 1G

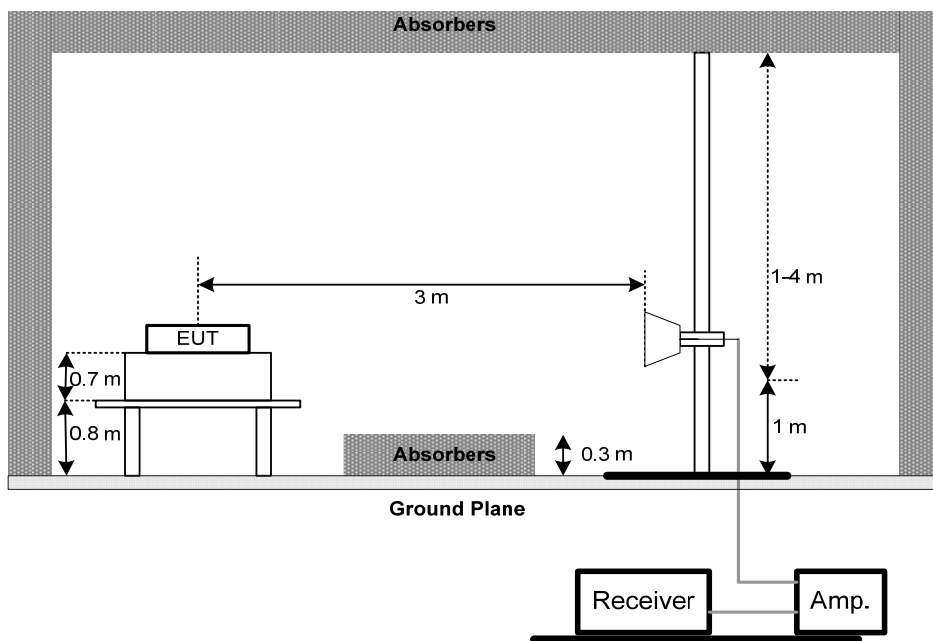

Conducted Power Measurement

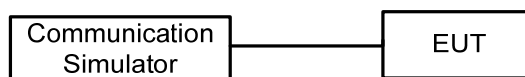

4.1.4 TEST DEVIATION

No deviation

4.1.5 TEST RESULTS

Please refer to the Attachment A.

4.2 RADIATED EMISSIONS MEASUREMENT

4.2.1 LIMIT

The power of any emission outside of the authorized operating frequency ranges must be attenuated below the transmitting power (P) by a factor of at least $43 + 10 \log(P)$ dB. The emission limit equal to -13dBm.

4.2.2 TEST PROCEDURES

1. Substitution method is used for E.I.R.P measurement. In the semi-anechoic chamber, EUT placed on the 0.8m height of Turn Table, rotated the table around 360 degrees to search the maximum radiation power and receiver antenna shall be rotated vertical and horizontal polarization and moved height from 1m to 4m to find the maximum polar radiated power. The "Read Value" is the spectrum reading the maximum power value.
2. The substitution horn antenna is substituted for EUT at the same position and signals generator export the CW signal to the substitution antenna via a TX cable. Rotated the Turn Table and moved receiving antenna to find the maximum radiation power. Adjust output power level of S.G to get a Value of spectrum reading equal to "Read Value " of step a. Record the power level of S.G
3. EIRP = Output power level of S.G – TX cable loss + Antenna gain of substitution horn.
4. E.R.P power can be calculated form E.I.R.P power by subtracting the gain of dipole, E.R.P power = E.I.P.R power - 2.15dBi.
5. The resolution bandwidth and video bandwidth of test receiver/spectrum analyzer is 1MHz/3MHz.

4.2.3 TESTSETUP LAYOUT

This test setup layout is the same as that shown in **section 4.1.3**.

4.2.4 TESTDEVIATION

No deviation

4.2.5 TEST RESULTS

Please refer to the Attachment B.

4.3 PEAK TO AVERAGE RATIO MEASUREMENT

4.3.1 LIMIT

In measuring transmissions in this band using an average power technique, the peak to-average ratio (PAR) of the transmission may not exceed 13 dB.

4.3.2 TEST PROCEDURES

1. Set resolution/measurement bandwidth \geq signal's occupied bandwidth;
2. Set the number of counts to a value that stabilizes the measured CCDF curve;
3. Record the maximum PAPR level associated with a probability of 0.1%.

4.3.3 TESTSETUP LAYOUT

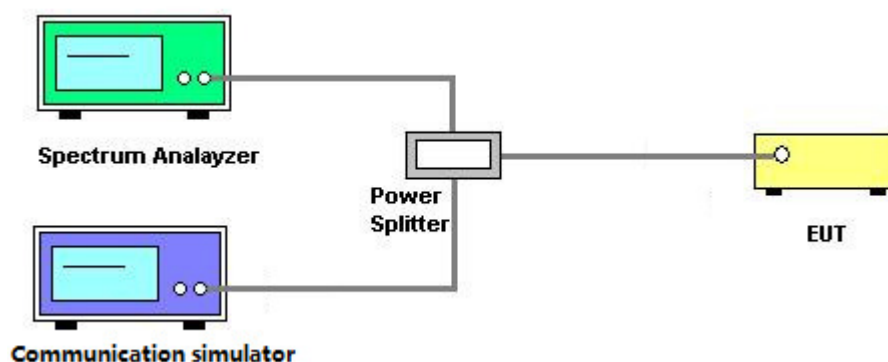

4.3.4 TESTDEVIATION

No deviation

4.3.5 TEST RESULTS

Please refer to the Attachment C.

4.4 FREQUENCY STABILITY MEASUREMENT

4.4.1 LIMIT

1.5 ppm is for base and fixed station. 2.5 ppm is for mobile station.

4.4.2 TEST PROCEDURES

1. Device is placed at the oven room. The oven room could control the temperatures and humidity. Power warm up is at least 15 min and power applied should perform before recording frequency error.
2. EUT is connected the external power supply to control the DC input power. The test voltage range is from minimum to maximum working voltage. Each step shall be record the frequency error rate.
3. The temperature range step is 10 degrees in this test items. All temperature levels shall be hold the $\pm 0.5^{\circ}\text{C}$ during the measurement testing. The each temperature step shall be at least 0.5 hours, consider the EUT could be test under the stability condition.
4. The frequency error was recorded frequency error from the communication simulator.

4.4.3 TESTSETUP LAYOUT

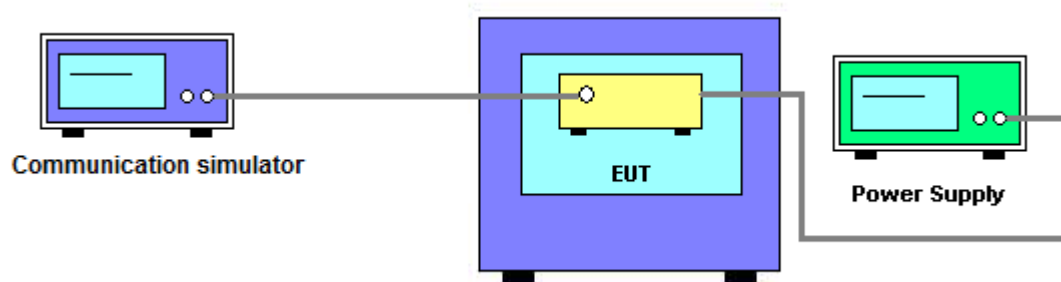

4.4.4 TESTDEVIATION

No deviation

4.4.5 TEST RESULTS

Please refer to the Attachment D.

5. LIST OF MEASUREMENT EQUIPMENTS

Radiated Emission & ERP or EIRP Measurement					
Item	Kind of Equipment	Manufacturer	Type No.	Serial No.	Calibrated until
1	Spectrum Analyzer	Agilent	N9038A	MY51210215	Jun. 07, 2016
2	Horn Antenna	Schwarzbeck	BBHA 9120	D 546	Nov. 04, 2016
3	Microwave Pre amplifier	HP	8447D	2944A08891	Mar. 08, 2017
4	Test Cable	EMCI	EMC104-SM-S M-5000	150302	Mar. 08, 2017
5	Test Cable	EMCI	EMC104-SM-S M-800	150305	Mar. 08, 2017
6	Test Cable	EMCI	EMC104-SM-S M-2500	150306	Mar. 08, 2017
7	Test Cable	EMCI	EMC8D-NM-NM -8000	150301	Mar. 08, 2017
8	Test Cable	EMCI	EMC8D-NM-NM -2500	150303	Mar. 08, 2017
9	Test Cable	EMCI	EMC8D-NM-NM -1000	150304	Mar. 08, 2017
10	Pre-Amplifier	Agilent	8449B	3008A02331	Jan. 23, 2017
11	Trilog-Broadband Antenna	Schwarzbeck	VULB9168	9168-364	Feb. 03, 2017
12	Preamplifier With Adaptor	EMC	EMC2654045	980030	Feb. 15, 2017
13	Loop Antenna	EMCO	6502	00042960	Nov. 15. 2016
14	Broad-Band Horn Antenna	SCHWARZBECK	BBHA 9120D	9120D-1333	May 31, 2017
15	Trilog-Broadband Antenna	Schwarzbeck	VULB9168-352	9168-352	Jul. 30, 2016

Frequency Stability Measurement					
Item	Kind of Equipment	Manufacturer	Type No.	Serial No.	Calibrated until
1	Spectrum Analyzer	R&S	FSP-40	100129	Jan. 17, 2017
2	Thermal Chamber	HOLINK	CHOLINK/H-T-1 F-D	BA03101701	Jun. 08, 2016

Remark: "N/A" denotes no model name, serial no. or calibration specified.
All calibration period of equipment list is one year.

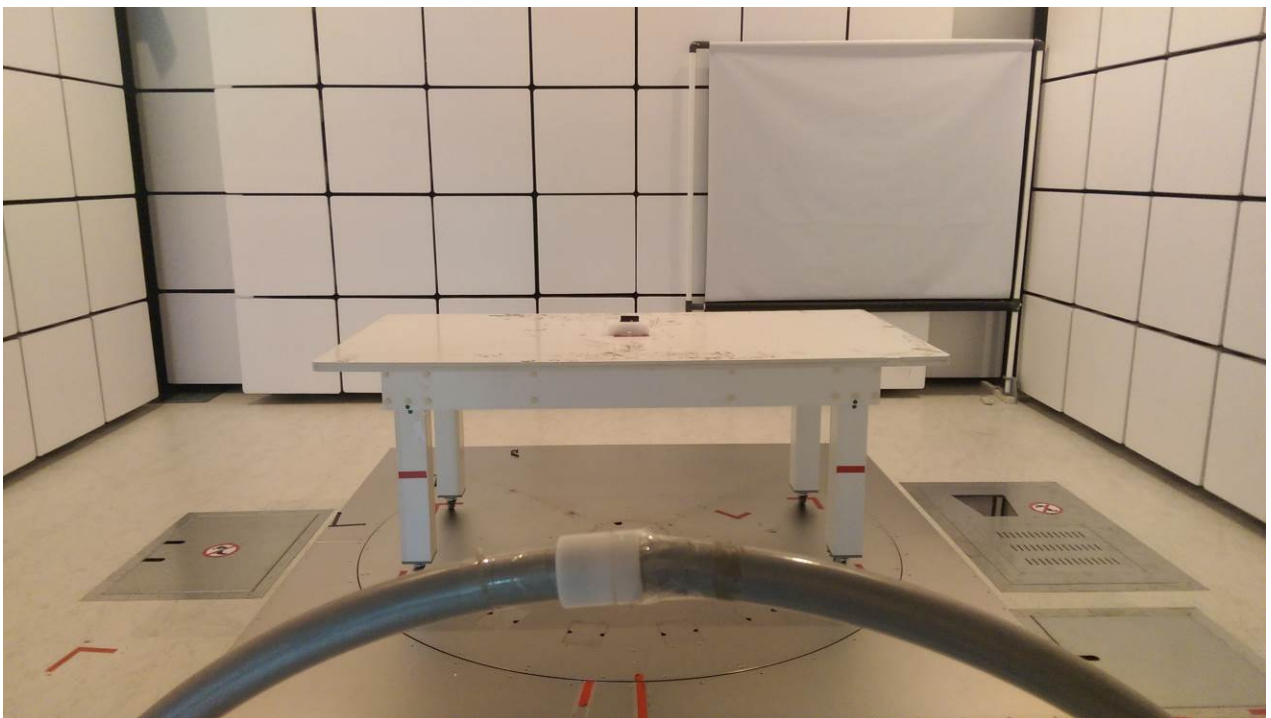
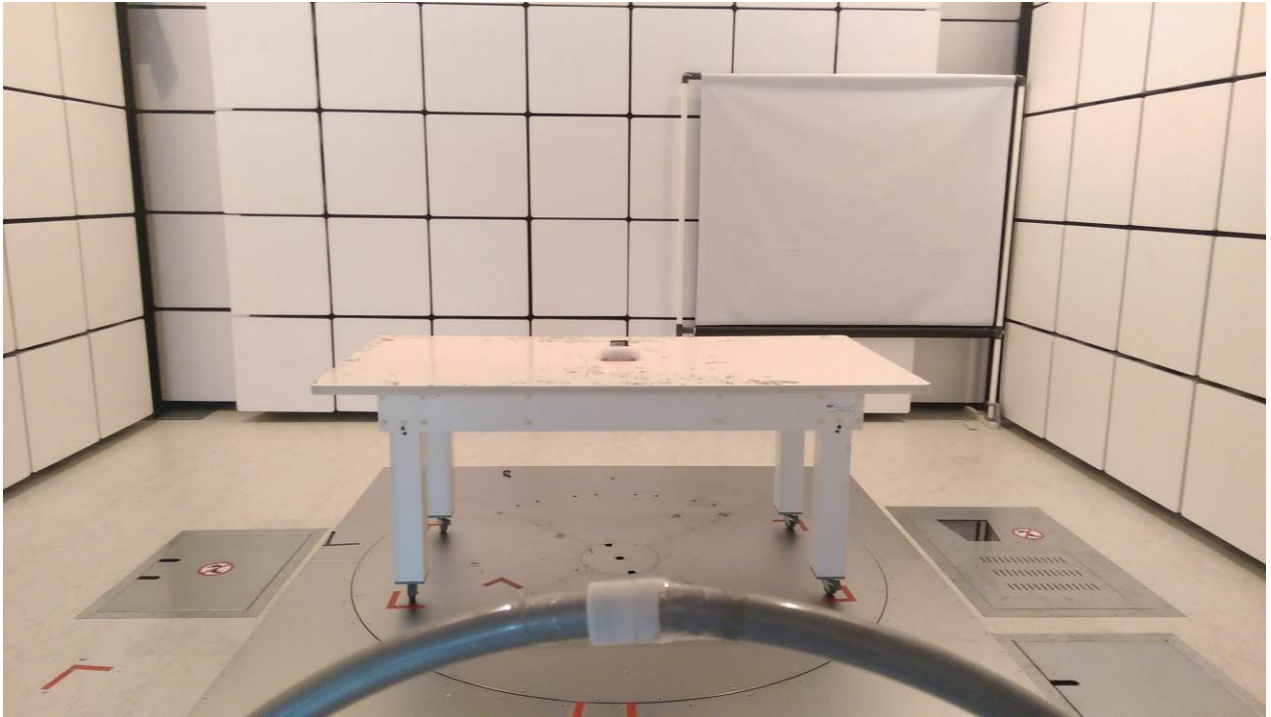
6. EUT TEST PHOTO**Radiated Measurement Photos
9KHz to 30MHz**

**Radiated Measurement Photos
Below 1G**

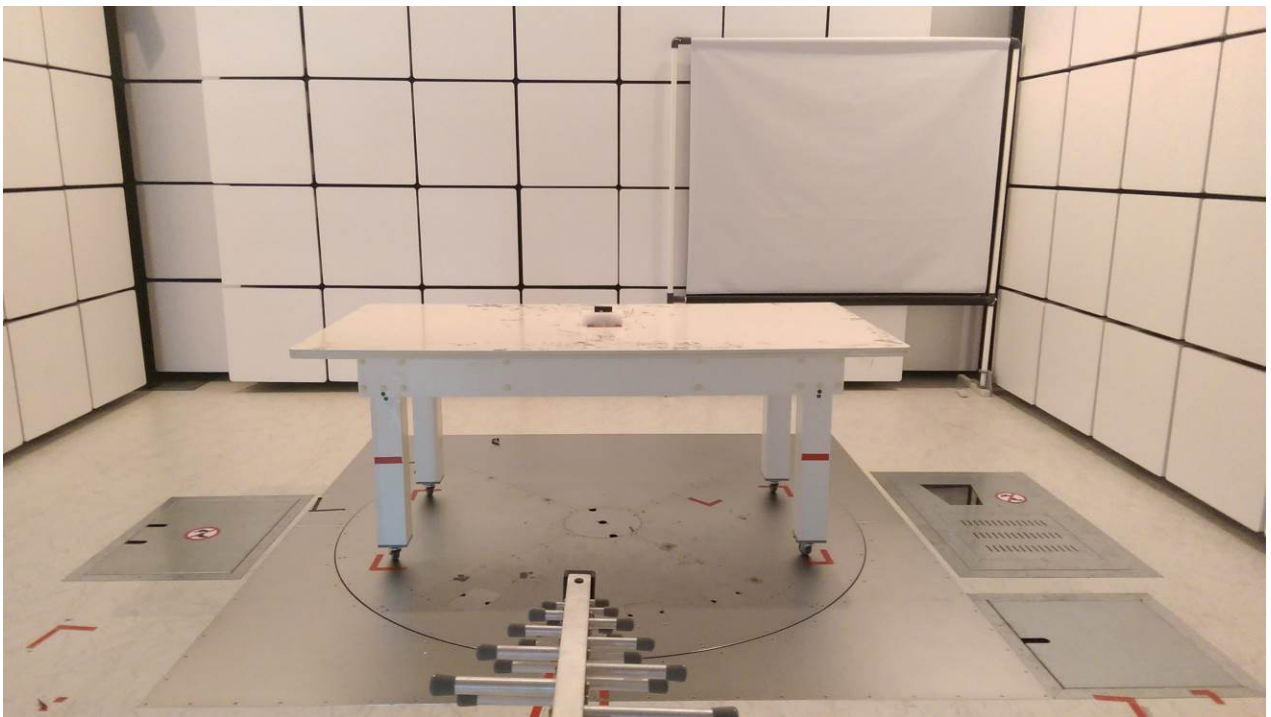
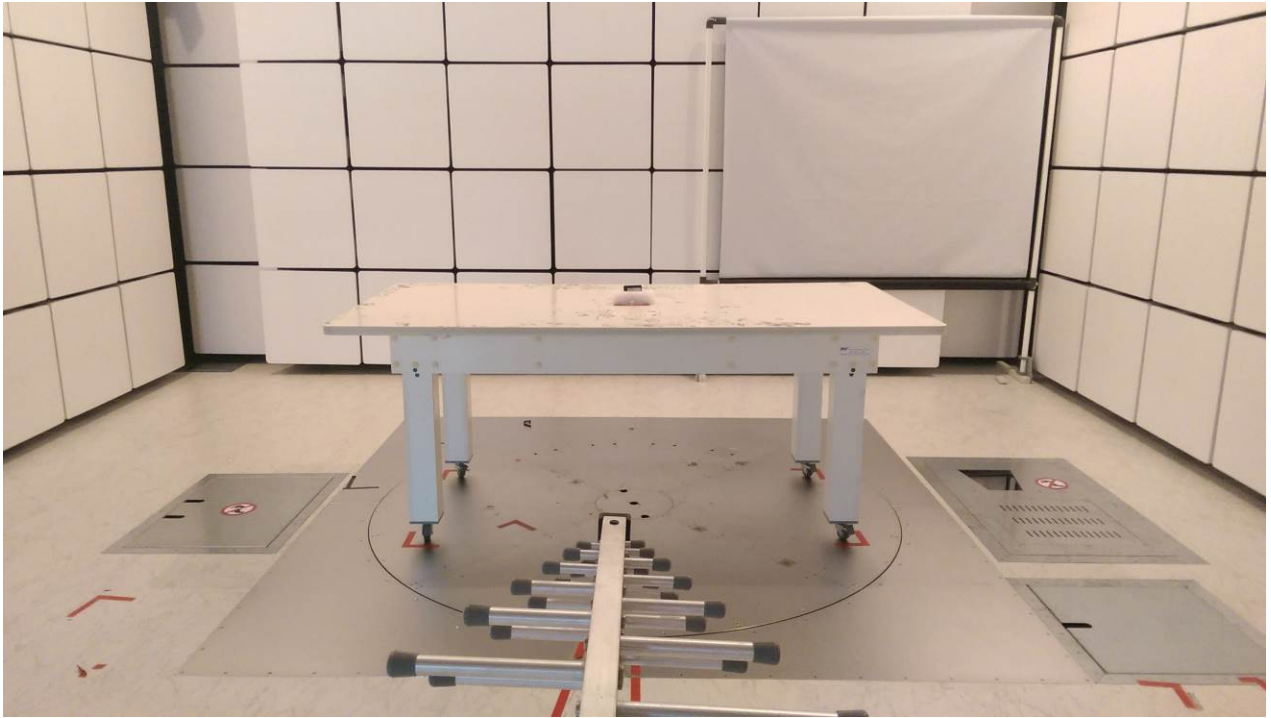

**Radiated Measurement Photos
Above 1G**

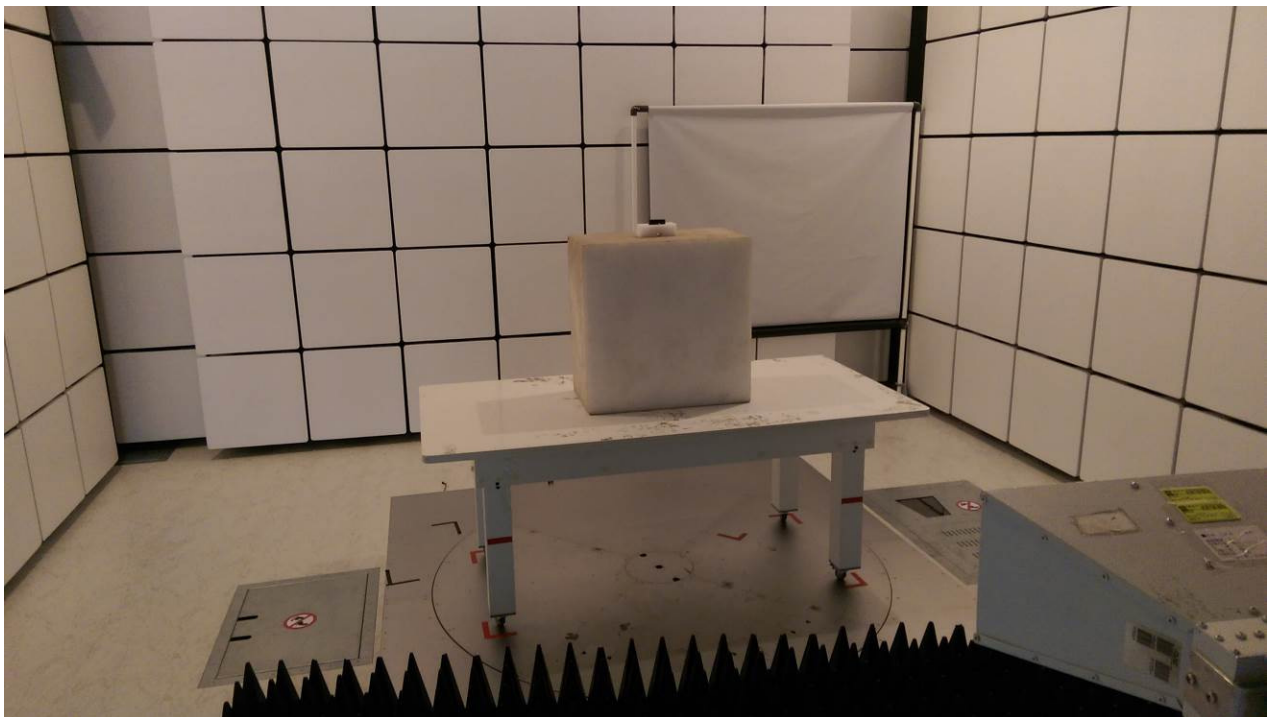
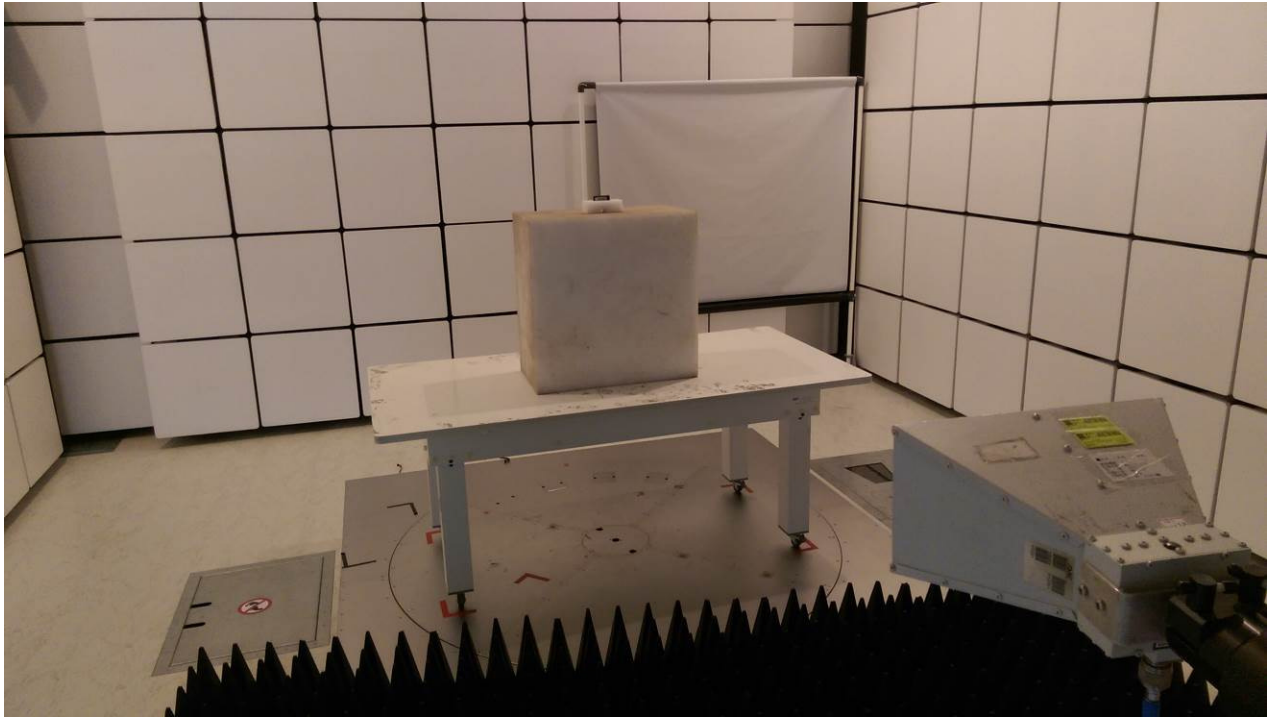

ATTACHMENT A - OUTPUT POWER

Conducted Power:

Band	WCDMA V(Capsensor Off)			
Tx Channel	Max. Tune-up Peak Power	4132CH	4182CH	4233CH
Rx Channel		4357CH	4407CH	4458CH
Frequency		826.4MHz	836.4MHz	846.6MHz
AMR	24.00	23.49	23.35	23.52
RMC 12.2K	24.00	23.56	23.41	23.60
HSDPA Subtest-1	23.50	23.24	23.12	23.27
HSDPA Subtest-2	22.50	22.33	22.21	22.36
HSDPA Subtest-3	23.00	22.88	22.76	22.91
HSDPA Subtest-4	23.00	22.91	22.79	22.94
HSUPA Subtest-1	22.50	22.42	22.30	22.45
HSUPA Subtest-2	22.00	21.95	21.83	21.98
HSUPA Subtest-3	22.00	21.97	21.85	22.00
HSUPA Subtest-4	22.00	21.79	21.67	21.82
HSUPA Subtest-5	23.50	23.39	23.27	23.42

E. R.P Power

WCDMA Band V					
Plane	Channel	Frequency (MHz)	Correction Factor(dB)	ERP(dBm)	Polarization (H/V)
Y	4132	826.4	36.96	20.98	H
	4182	836.4	37.07	21.07	H
	4233	846.6	37.16	20.71	H
	4132	826.4	36.98	19.44	V
	4182	836.4	37.17	19.17	V
	4233	846.6	37.34	19.29	V

ATTACHMENT B - RADIATED EMISSION

Test Mode: WCDMA Band V_TX CH4132

Open

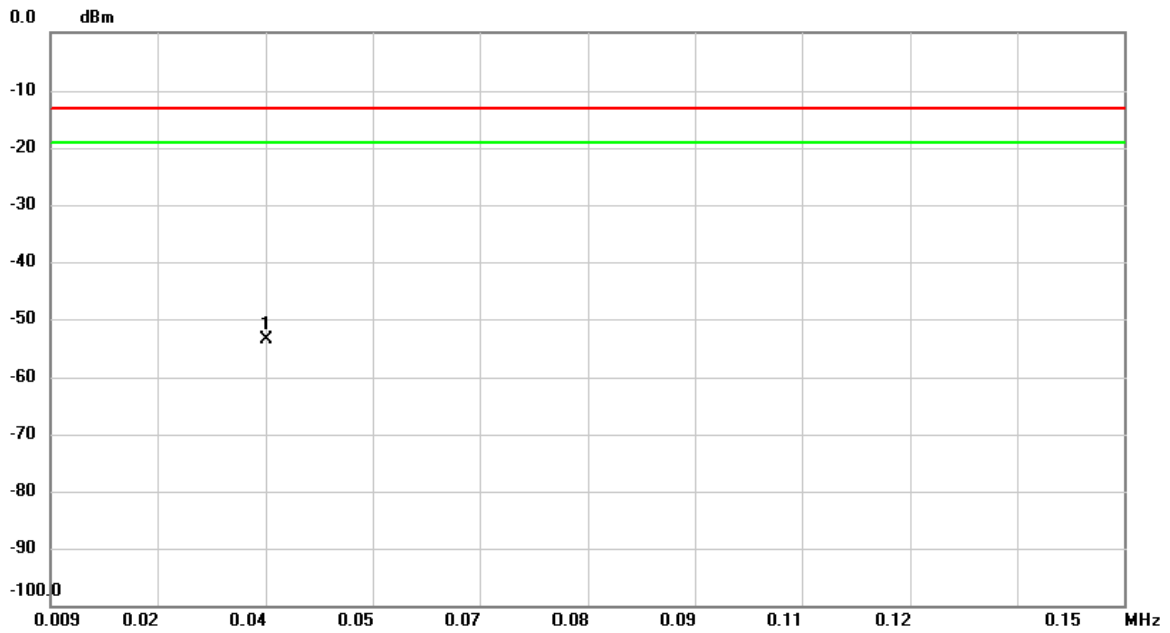

No.	Mk.	Freq. MHz	Reading Level dBm	Correct Factor dB	Measure- ment dBm	Limit dBm	Over dB	Detector	Comment
1	*	0.0372	-68.00	14.28	-53.72	-13.00	-40.72	peak	

Test Mode: WCDMA Band V_TX CH4132

Open

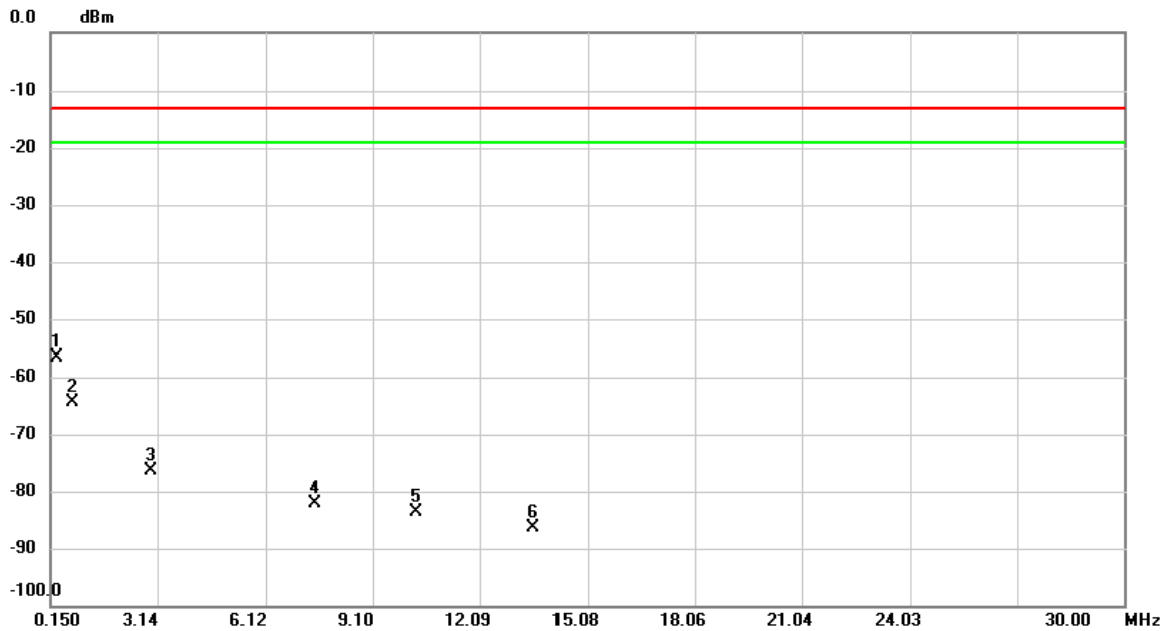

No.	Mk.	Freq. MHz	Reading Level dBm	Correct Factor dB	Measure- ment dBm	Limit dBm	Over dB	Detector	Comment
1	*	0.3092	-68.38	11.80	-56.58	-13.00	-43.58	peak	
2		0.7867	-76.21	11.91	-64.30	-13.00	-51.30	peak	
3		2.9360	-87.52	11.13	-76.39	-13.00	-63.39	peak	
4		7.4732	-93.40	11.35	-82.05	-13.00	-69.05	peak	
5		10.2990	-94.98	11.29	-83.69	-13.00	-70.69	peak	
6		13.5626	-97.49	11.19	-86.30	-13.00	-73.30	peak	

Test Mode: WCDMA Band V_TX CH4132

Close

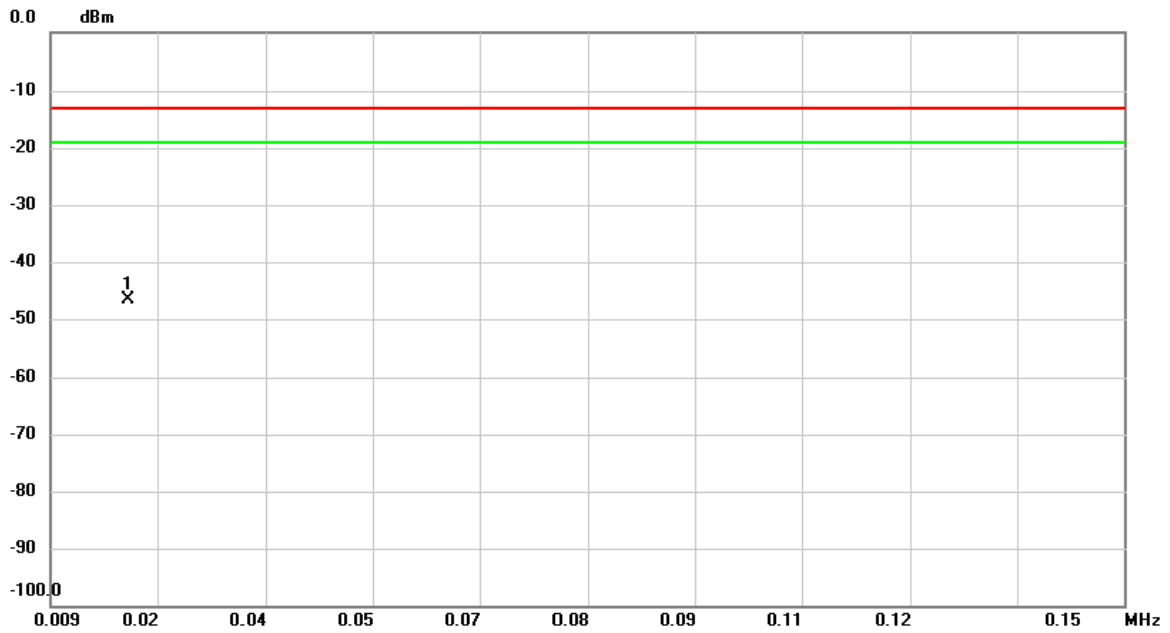

No.	Mk.	Freq. MHz	Reading Level dBm	Correct Factor dB	Measure- ment dBm	Limit dBm	Over dB	Detector	Comment
1	*	0.0192	-64.56	17.97	-46.59	-13.00	-33.59	peak	

Test Mode: WCDMA Band V_TX CH4132

Close

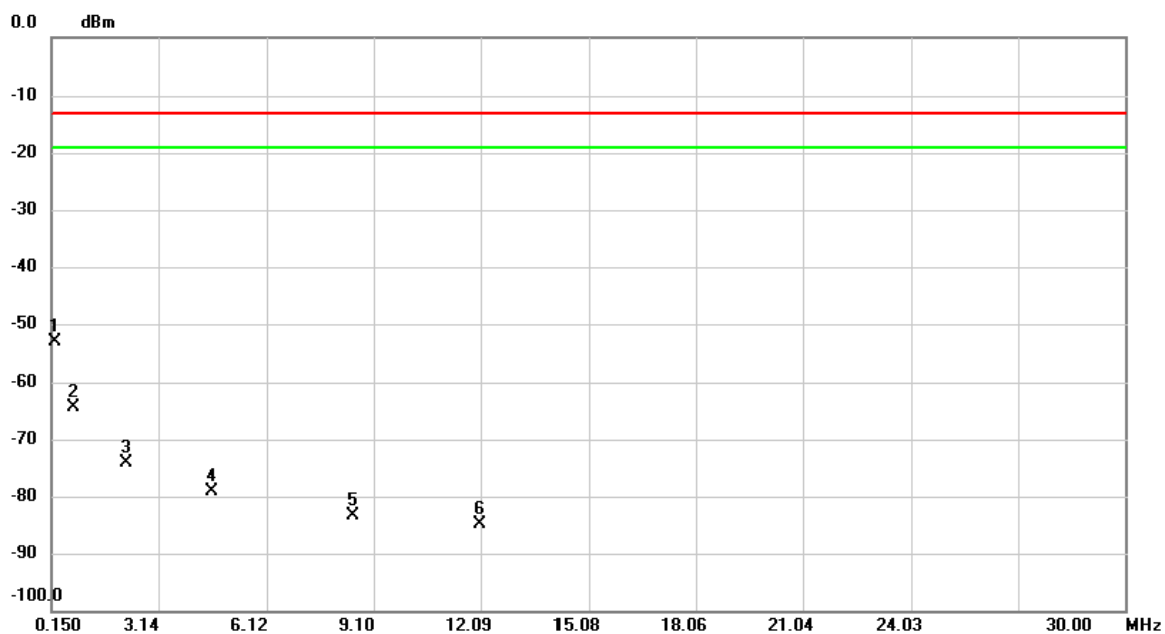

No.	Mk.	Freq. MHz	Reading Level dBm	Correct Factor dB	Measure- ment dBm	Limit dBm	Over dB	Detector	Comment
1	*	0.2296	-64.96	11.91	-53.05	-13.00	-40.05	peak	
2		0.7867	-76.25	11.91	-64.34	-13.00	-51.34	peak	
3		2.2196	-85.45	11.45	-74.00	-13.00	-61.00	peak	
4		4.6076	-90.35	11.34	-79.01	-13.00	-66.01	peak	
5		8.5477	-94.79	11.33	-83.46	-13.00	-70.46	peak	
6		12.0502	-96.22	11.24	-84.98	-13.00	-71.98	peak	

Test Mode: WCDMA Band V_TX CH4132

Vertical

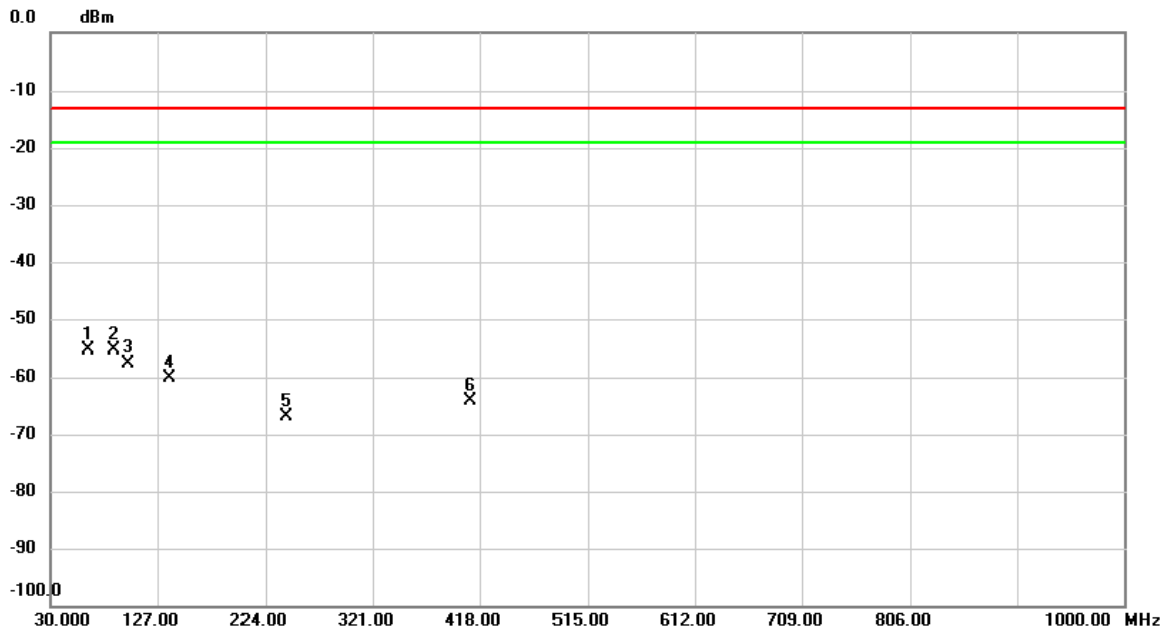

No.	Mk.	Freq. MHz	Reading Level dBm	Correct Factor dB	Measure- ment dBm	Limit dBm	Over dB	Detector	Comment
1	*	63.6267	-51.35	-4.00	-55.35	-13.00	-42.35	peak	
2		86.9067	-51.32	-4.10	-55.42	-13.00	-42.42	peak	
3		99.8400	-55.00	-2.61	-57.61	-13.00	-44.61	peak	
4		138.6400	-58.76	-1.33	-60.09	-13.00	-47.09	peak	
5		242.1067	-62.93	-3.91	-66.84	-13.00	-53.84	peak	
6		408.9467	-66.53	2.44	-64.09	-13.00	-51.09	peak	

Test Mode: WCDMA Band V_TX CH4132

Horizontal

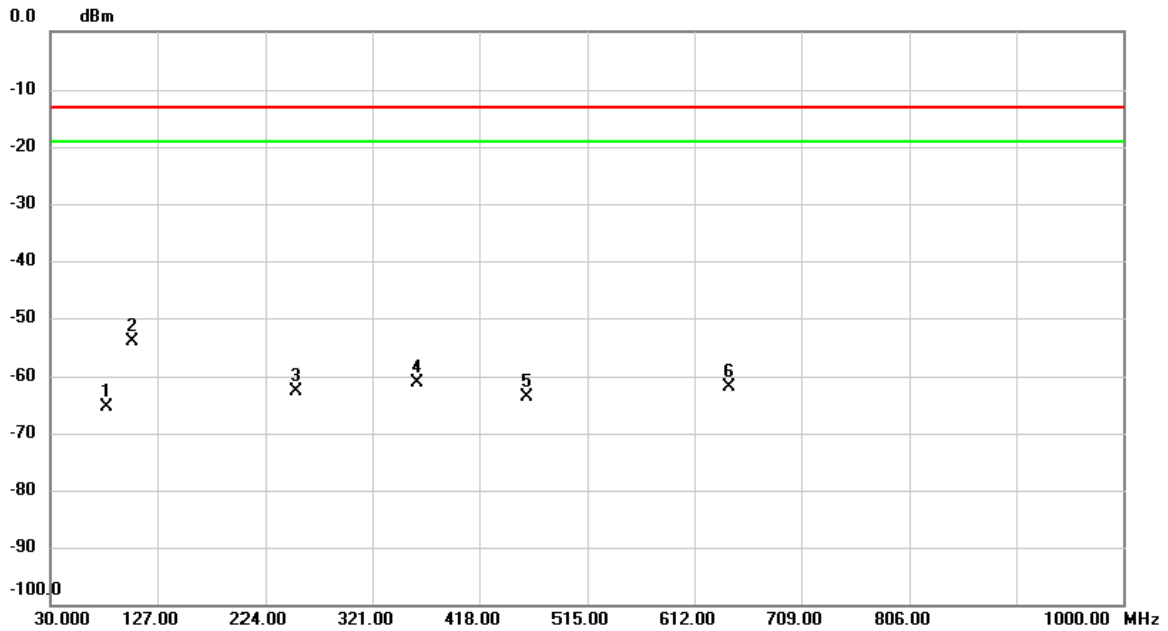

No.	Mk.	Freq. MHz	Reading Level dBm	Correct Factor dB	Measure- ment dBm	Limit dBm	Over dB	Detector	Comment
1		81.7333	-60.16	-5.21	-65.37	-13.00	-52.37	peak	
2	*	103.7200	-51.07	-3.06	-54.13	-13.00	-41.13	peak	
3		252.4533	-58.87	-3.68	-62.55	-13.00	-49.55	peak	
4		362.3866	-62.18	1.15	-61.03	-13.00	-48.03	peak	
5		461.9733	-67.09	3.46	-63.63	-13.00	-50.63	peak	
6		643.0400	-67.66	5.81	-61.85	-13.00	-48.85	peak	

Test Mode: WCDMA Band V_TX CH4132

Vertical

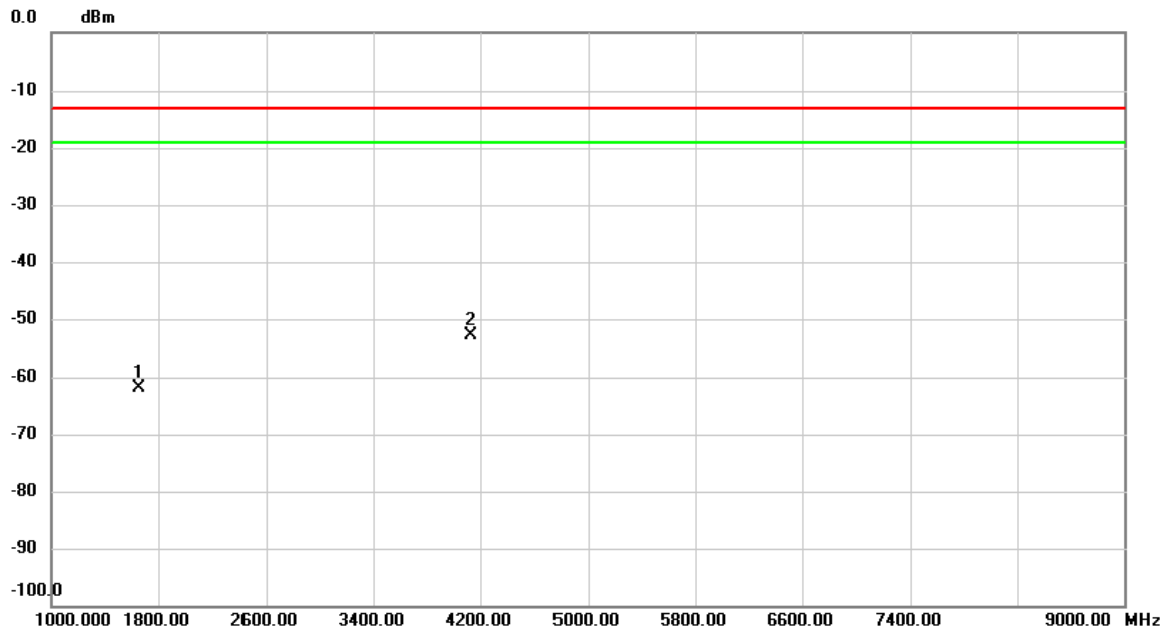

No.	Mk.	Freq. MHz	Reading Level dBm	Correct Factor dB	Measure- ment dBm	Limit dBm	Over dB	Detector	Comment
1		1652.800	-51.43	-10.54	-61.97	-13.00	-48.97	peak	
2	*	4132.000	-52.06	-0.92	-52.98	-13.00	-39.98	peak	

Test Mode: WCDMA Band V_TX CH4132

Horizontal

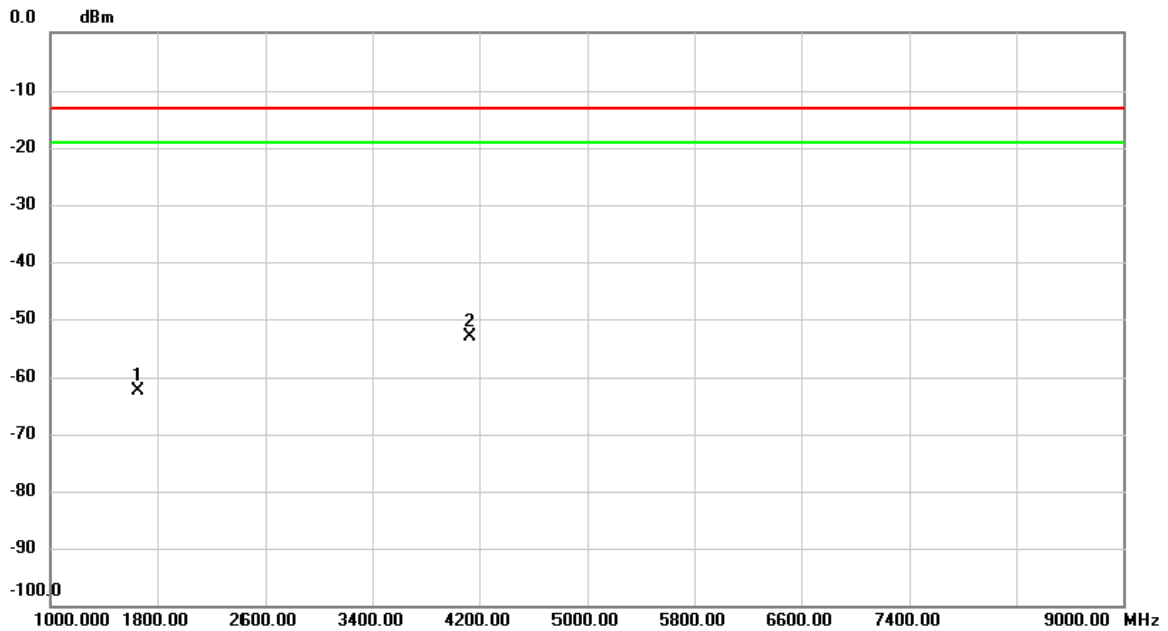

No.	Mk.	Freq. MHz	Reading Level dBm	Correct Factor dB	Measure- ment dBm	Limit dBm	Over dB	Detector	Comment
1		1652.800	-51.74	-10.54	-62.28	-13.00	-49.28	peak	
2	*	4132.000	-52.21	-0.92	-53.13	-13.00	-40.13	peak	

Test Mode: WCDMA Band V_TX CH4182

Open

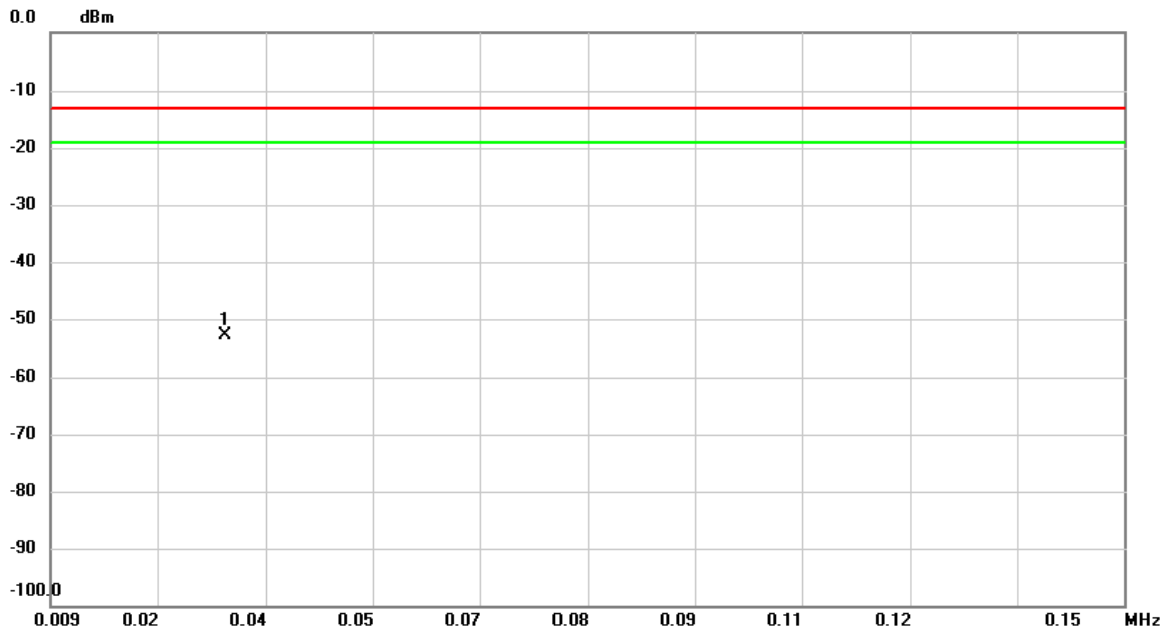

No.	Mk.	Freq. MHz	Reading Level dBm	Correct Factor dB	Measure- ment dBm	Limit dBm	Over dB	Detector	Comment
1	*	0.0321	-67.71	14.79	-52.92	-13.00	-39.92	peak	

Test Mode: WCDMA Band V_TX CH4182

Open

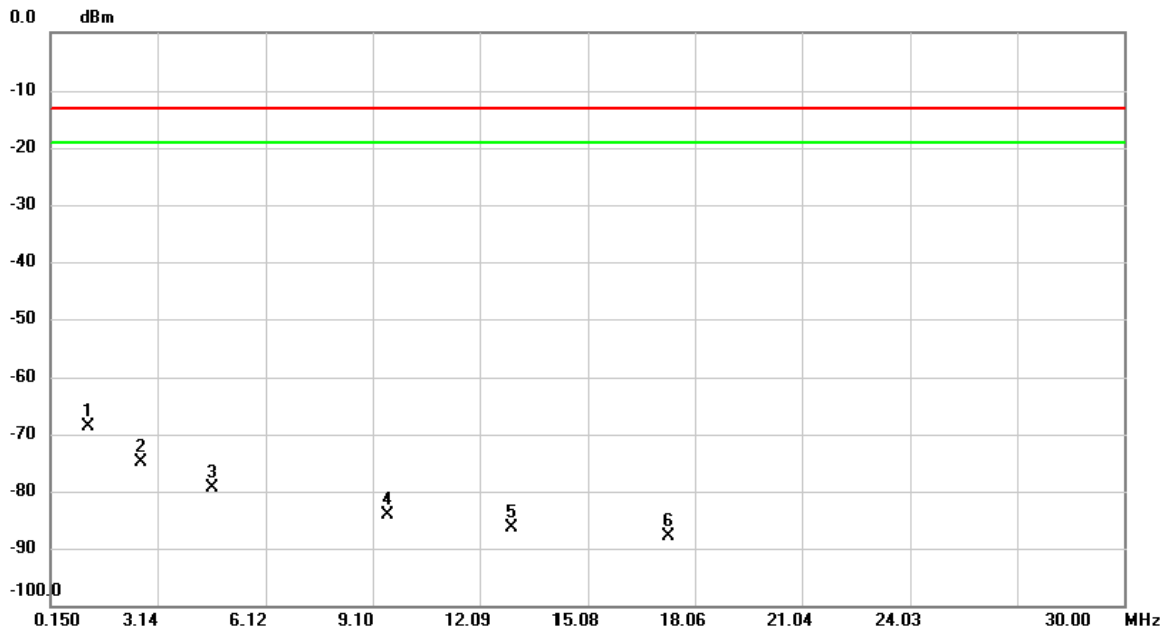

No.	Mk.	Freq. MHz	Reading Level dBm	Correct Factor dB	Measure- ment dBm	Limit dBm	Over dB	Detector	Comment
1	*	1.1848	-80.53	11.92	-68.61	-13.00	-55.61	peak	
2		2.6574	-86.06	11.25	-74.81	-13.00	-61.81	peak	
3		4.6474	-90.66	11.35	-79.31	-13.00	-66.31	peak	
4		9.5030	-95.54	11.31	-84.23	-13.00	-71.23	peak	
5		12.9656	-97.57	11.21	-86.36	-13.00	-73.36	peak	
6		17.3038	-98.84	11.08	-87.76	-13.00	-74.76	peak	

Test Mode: WCDMA Band V_TX CH4182

Close

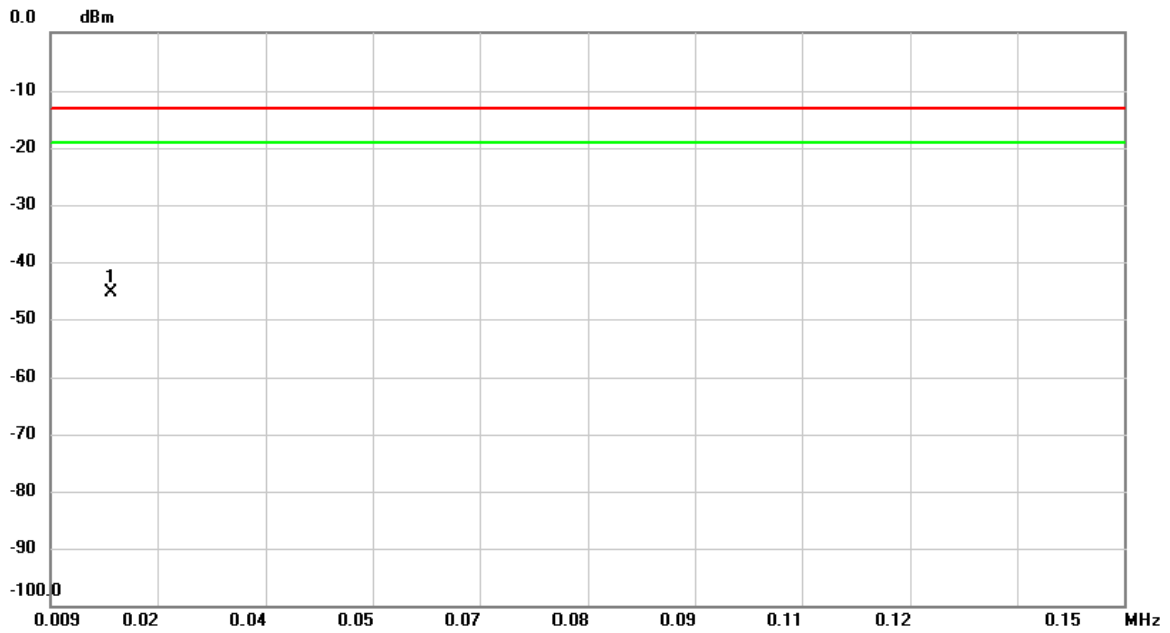

No.	Mk.	Freq. MHz	Reading Level dBm	Correct Factor dB	Measure- ment dBm	Limit dBm	Over dB	Detector	Comment
1	*	0.0170	-63.89	18.57	-45.32	-13.00	-32.32	peak	

Test Mode: WCDMA Band V_TX CH4182

Close

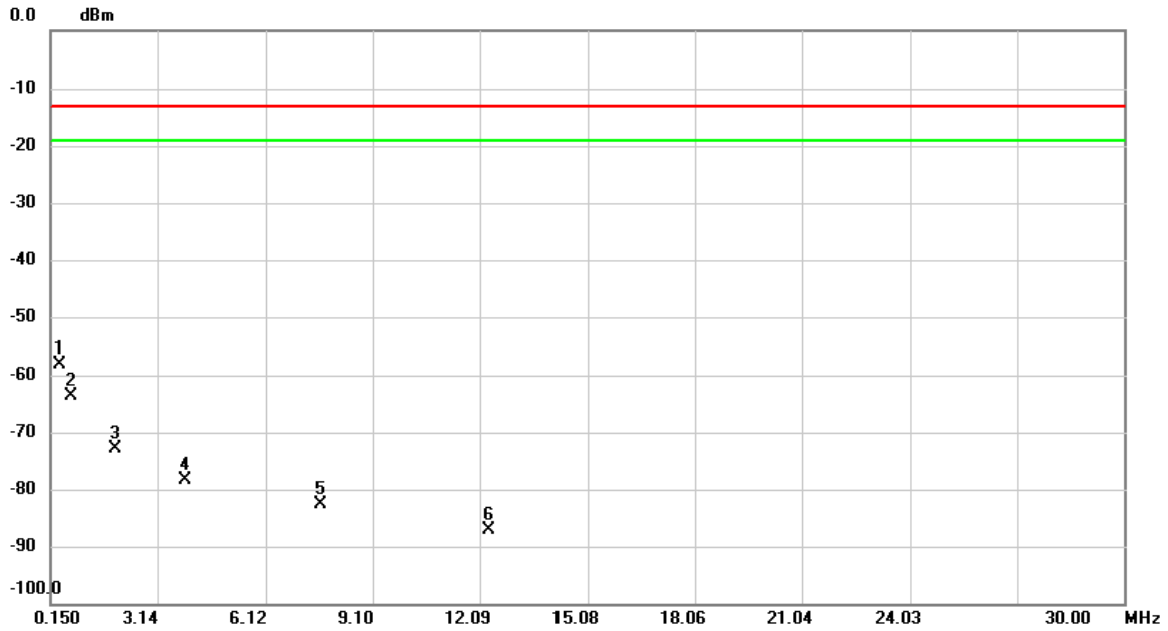

No.	Mk.	Freq. MHz	Reading Level dBm	Correct Factor dB	Measure- ment dBm	Limit dBm	Over dB	Detector	Comment
1	*	0.3888	-70.01	11.80	-58.21	-13.00	-45.21	peak	
2		0.7072	-75.60	11.88	-63.72	-13.00	-50.72	peak	
3		1.9410	-84.45	11.58	-72.87	-13.00	-59.87	peak	
4		3.8912	-89.50	11.23	-78.27	-13.00	-65.27	peak	
5		7.6324	-94.02	11.35	-82.67	-13.00	-69.67	peak	
6		12.3288	-98.36	11.23	-87.13	-13.00	-74.13	peak	

Test Mode: WCDMA Band V_TX CH4182

Vertical

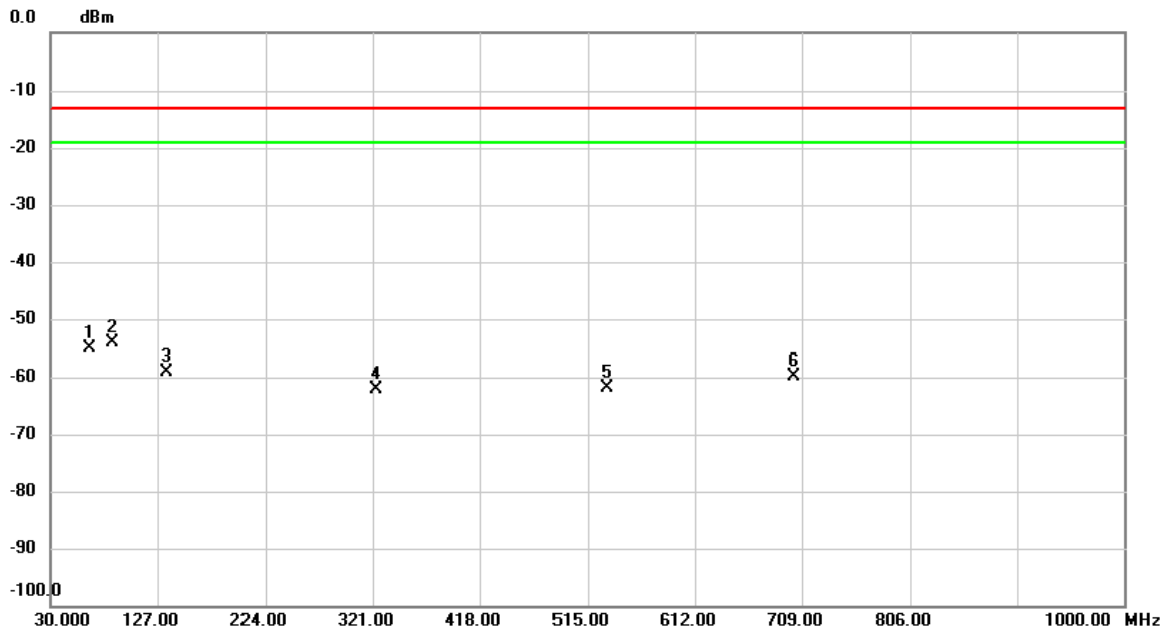

No.	Mk.	Freq. MHz	Reading Level dBm	Correct Factor dB	Measure- ment dBm	Limit dBm	Over dB	Detector	Comment
1		64.9200	-50.78	-4.36	-55.14	-13.00	-42.14	peak	
2	*	86.2600	-49.98	-4.23	-54.21	-13.00	-41.21	peak	
3		135.7300	-57.35	-1.86	-59.21	-13.00	-46.21	peak	
4		323.9100	-61.80	-0.41	-62.21	-13.00	-49.21	peak	
5		532.4600	-66.16	4.18	-61.98	-13.00	-48.98	peak	
6		701.2400	-66.92	6.94	-59.98	-13.00	-46.98	peak	

Test Mode: WCDMA Band V_TX CH4182

Horizontal

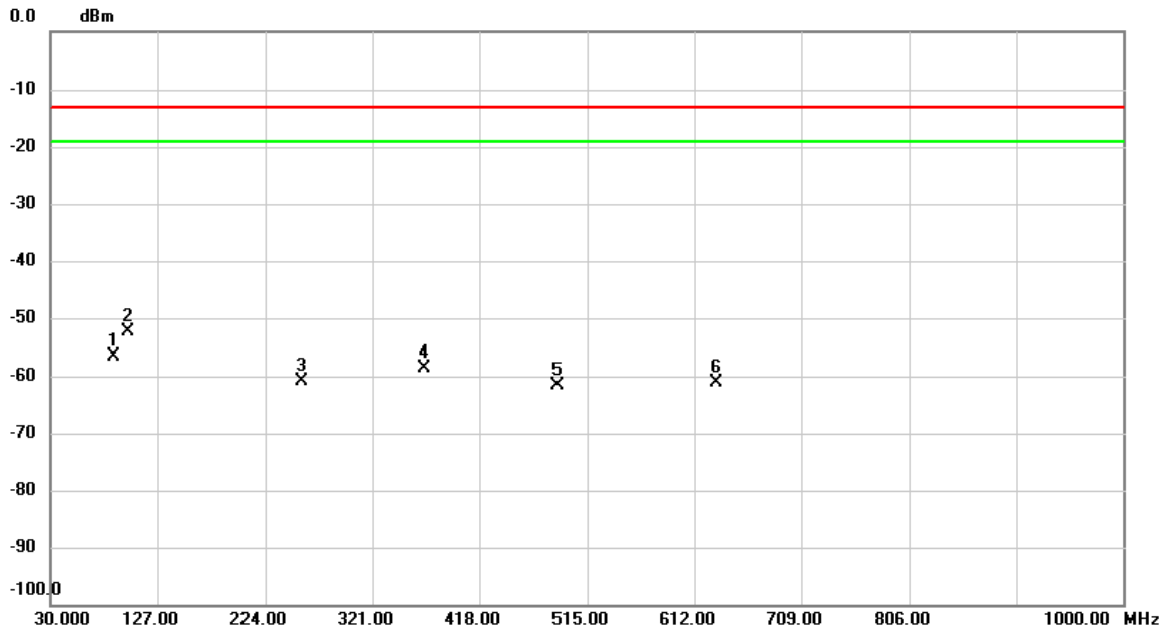

No.	Mk.	Freq.	Reading Level	Correct Factor	Measurement	Limit	Over	Detector	Comment
		MHz	dBm	dB	dBm	dBm	dB		
1		87.2300	-52.69	-4.03	-56.72	-13.00	-43.72	peak	
2	*	100.8100	-49.65	-2.70	-52.35	-13.00	-39.35	peak	
3		256.9800	-57.15	-3.70	-60.85	-13.00	-47.85	peak	
4		367.5600	-59.86	1.30	-58.56	-13.00	-45.56	peak	
5		488.8100	-65.33	3.76	-61.57	-13.00	-48.57	peak	
6		631.4000	-66.81	5.77	-61.04	-13.00	-48.04	peak	

Test Mode: WCDMA Band V_TX CH4182

Vertical

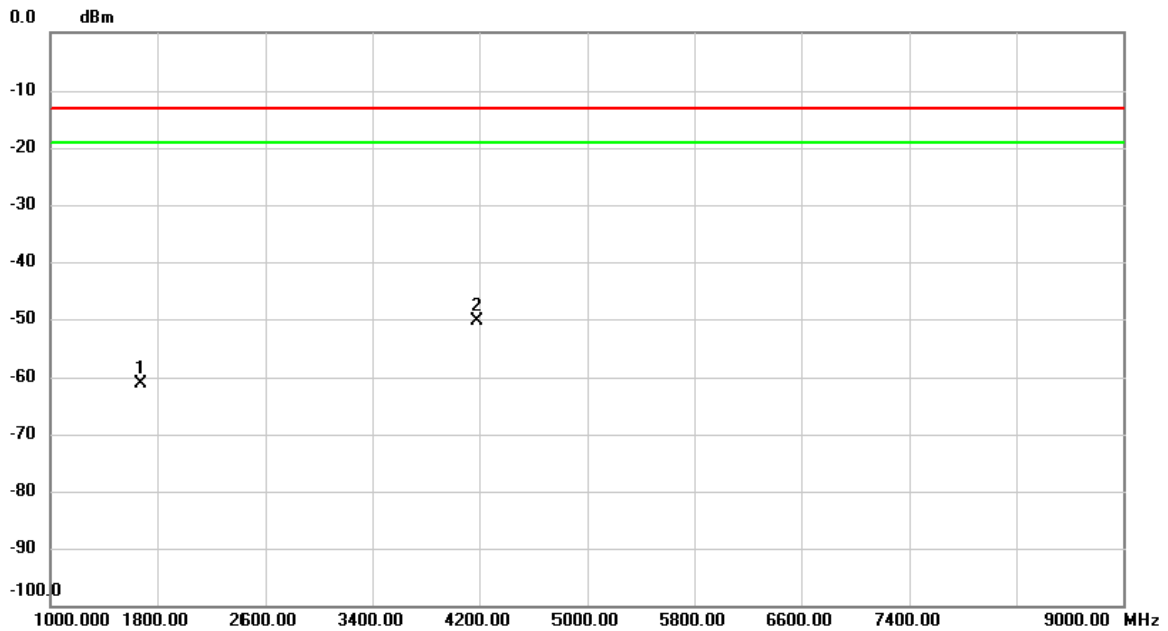

No.	Mk.	Freq. MHz	Reading Level dBm	Correct Factor dB	Measure- ment dBm	Limit dBm	Over dB	Detector	Comment
1		1672.800	-50.65	-10.46	-61.11	-13.00	-48.11	peak	
2	*	4182.000	-49.47	-0.94	-50.41	-13.00	-37.41	peak	

Test Mode: WCDMA Band V_TX CH4182

Horizontal

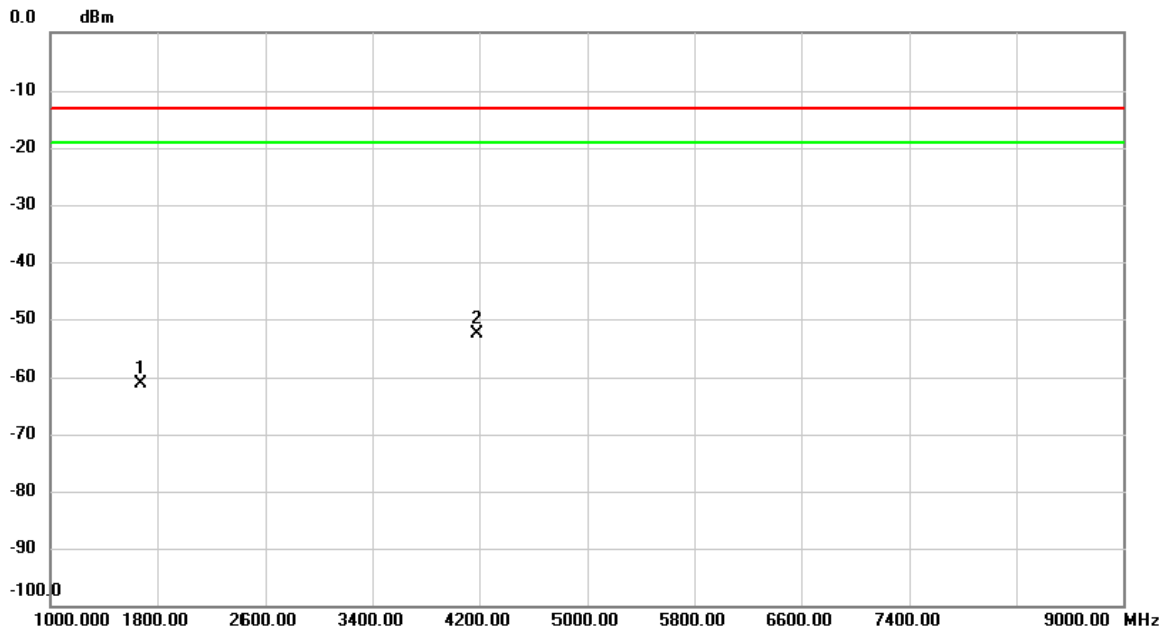

No.	Mk.	Freq. MHz	Reading Level dBm	Correct Factor dB	Measure- ment dBm	Limit dBm	Over dB	Detector	Comment
1		1672.800	-50.70	-10.46	-61.16	-13.00	-48.16	peak	
2	*	4182.000	-51.62	-0.94	-52.56	-13.00	-39.56	peak	

Test Mode: WCDMA Band V_TX CH4233

Open

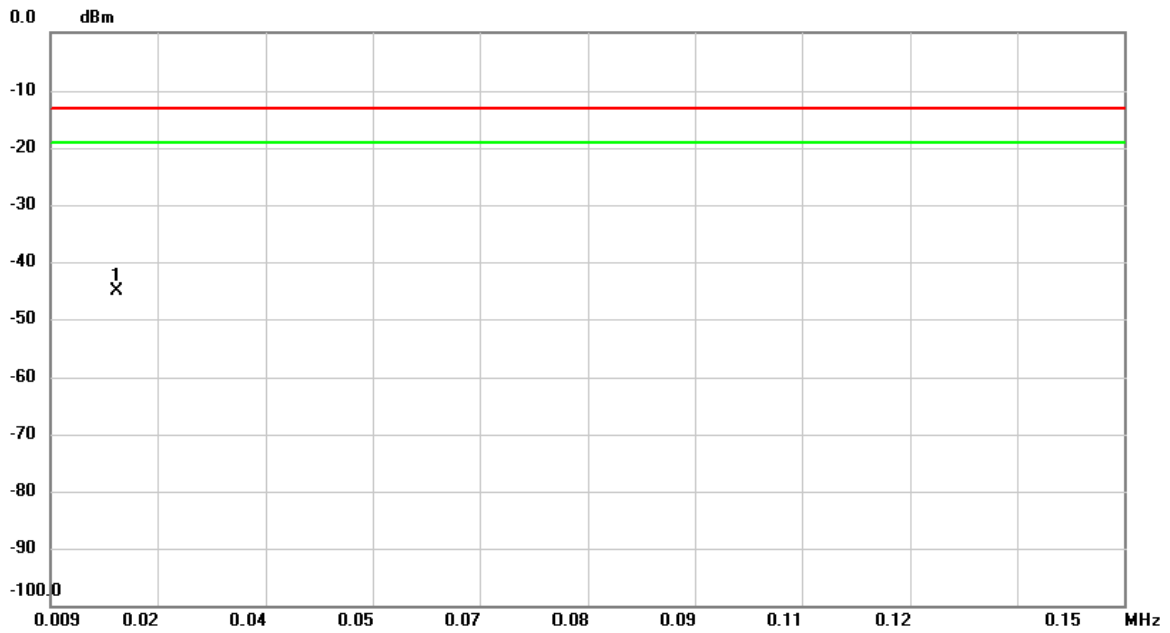

No.	Mk.	Freq. MHz	Reading Level dBm	Correct Factor dB	Measure- ment dBm	Limit dBm	Over dB	Detector	Comment
1	*	0.0177	-63.52	18.38	-45.14	-13.00	-32.14	peak	

Test Mode: WCDMA Band V_TX CH4233

Open

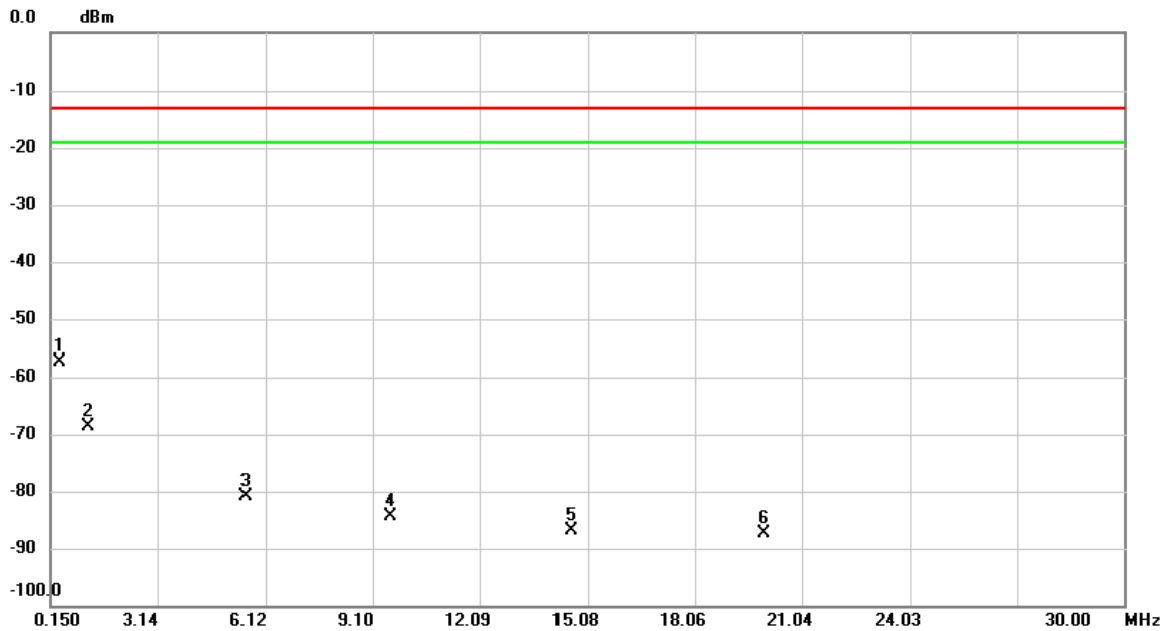

No.	Mk.	Freq. MHz	Reading Level dBm	Correct Factor dB	Measure- ment dBm	Limit dBm	Over dB	Detector	Comment
1	*	0.3888	-69.20	11.80	-57.40	-13.00	-44.40	peak	
2		1.1848	-80.53	11.92	-68.61	-13.00	-55.61	peak	
3		5.5628	-92.38	11.39	-80.99	-13.00	-67.99	peak	
4		9.5826	-95.65	11.31	-84.34	-13.00	-71.34	peak	
5		14.5974	-98.08	11.16	-86.92	-13.00	-73.92	peak	
6		19.9704	-98.35	11.00	-87.35	-13.00	-74.35	peak	

Test Mode: WCDMA Band V_TX CH4233

Close

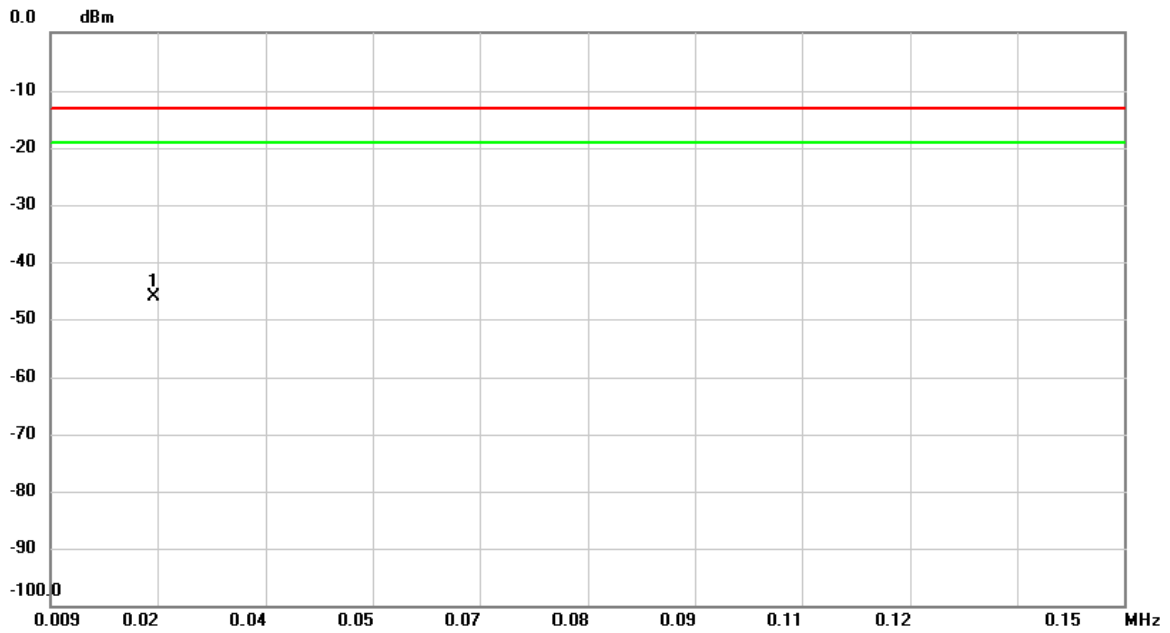

No.	Mk.	Freq. MHz	Reading Level dBm	Correct Factor dB	Measure- ment dBm	Limit dBm	Over dB	Detector	Comment
1	*	0.0227	-63.06	17.01	-46.05	-13.00	-33.05	peak	

Test Mode: WCDMA Band V_TX CH4233

Close

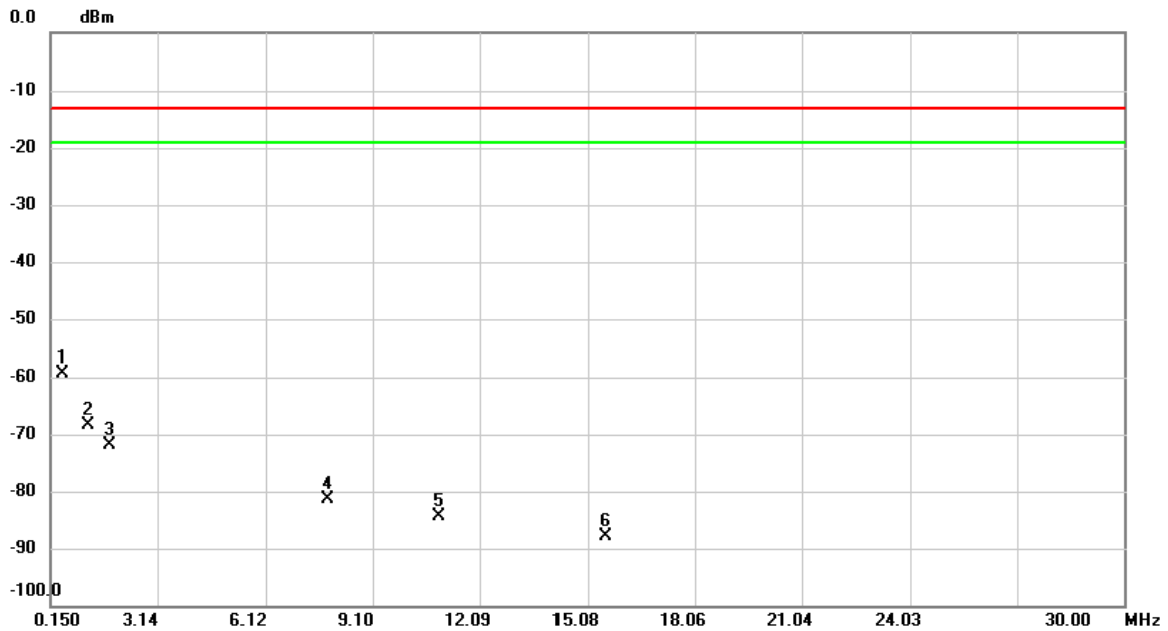

No.	Mk.	Freq. MHz	Reading Level dBm	Correct Factor dB	Measure- ment dBm	Limit dBm	Over dB	Detector	Comment
1	*	0.4684	-71.13	11.80	-59.33	-13.00	-46.33	peak	
2		1.1848	-80.18	11.92	-68.26	-13.00	-55.26	peak	
3		1.7818	-83.55	11.65	-71.90	-13.00	-58.90	peak	
4		7.8513	-92.66	11.34	-81.32	-13.00	-68.32	peak	
5		10.9358	-95.57	11.27	-84.30	-13.00	-71.30	peak	
6		15.5526	-99.10	11.13	-87.97	-13.00	-74.97	peak	

Test Mode: WCDMA Band V_TX CH4233

Vertical

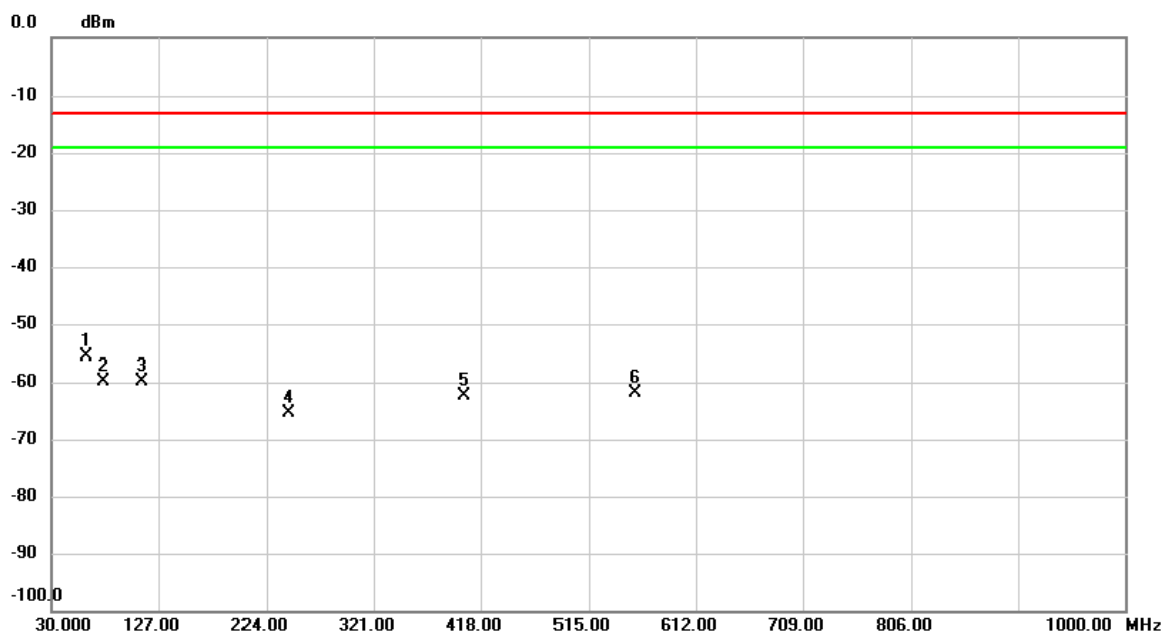

No.	Mk.	Freq. MHz	Reading Level dBm	Correct Factor dB	Measure- ment dBm	Limit dBm	Over dB	Detector	Comment
1	*	62.3333	-52.06	-3.64	-55.70	-13.00	-42.70	peak	
2		77.8533	-54.31	-5.62	-59.93	-13.00	-46.93	peak	
3		111.4800	-56.23	-3.66	-59.89	-13.00	-46.89	peak	
4		243.4000	-61.61	-3.87	-65.48	-13.00	-52.48	peak	
5		403.7732	-64.62	2.32	-62.30	-13.00	-49.30	peak	
6		557.6800	-66.30	4.54	-61.76	-13.00	-48.76	peak	

Test Mode: WCDMA Band V_TX CH4233

Horizontal

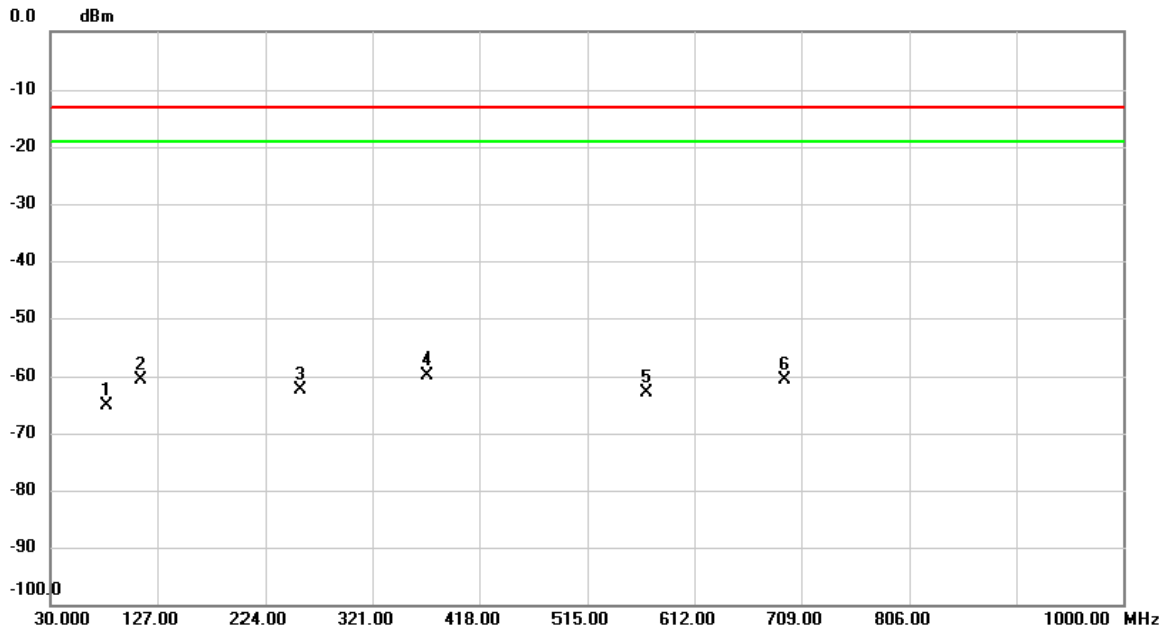

No.	Mk.	Freq. MHz	Reading Level dBm	Correct Factor dB	Measure- ment dBm	Limit dBm	Over dB	Detector	Comment
1		80.4400	-59.64	-5.49	-65.13	-13.00	-52.13	peak	
2		112.7733	-57.18	-3.50	-60.68	-13.00	-47.68	peak	
3		255.0400	-58.61	-3.69	-62.30	-13.00	-49.30	peak	
4	*	370.1467	-61.23	1.37	-59.86	-13.00	-46.86	peak	
5		568.0267	-67.77	4.81	-62.96	-13.00	-49.96	peak	
6		693.4800	-67.45	6.77	-60.68	-13.00	-47.68	peak	

Test Mode: WCDMA Band V_TX CH4233

Vertical

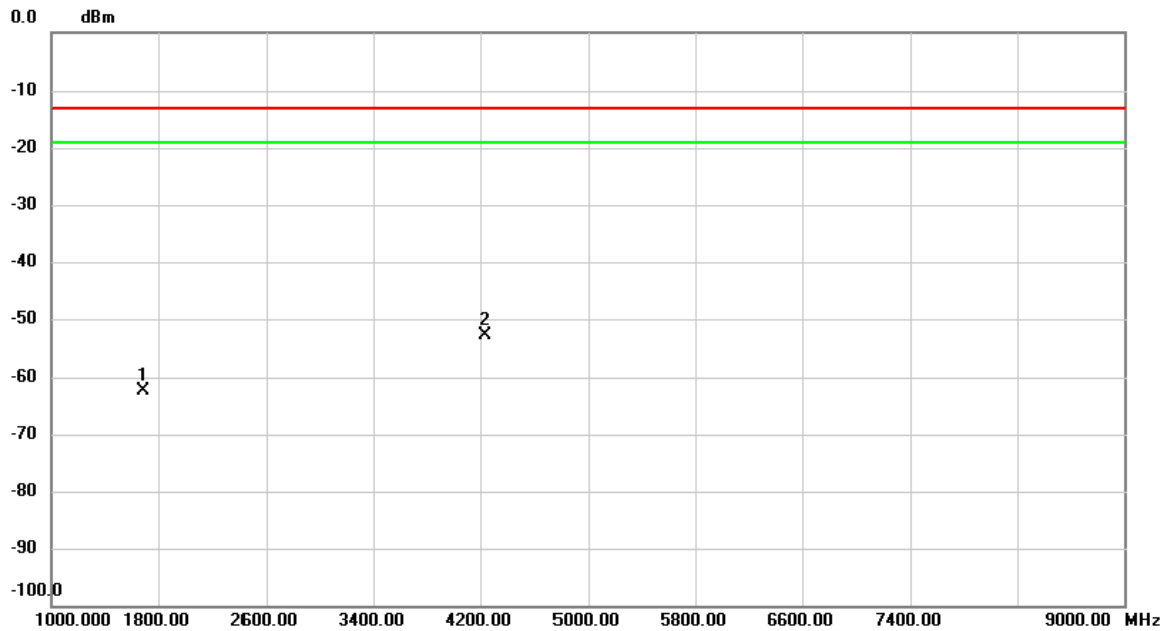

No.	Mk.	Freq. MHz	Reading Level dBm	Correct Factor dB	Measure- ment dBm	Limit dBm	Over dB	Detector	Comment
1		1693.200	-52.03	-10.38	-62.41	-13.00	-49.41	peak	
2	*	4233.000	-51.99	-0.96	-52.95	-13.00	-39.95	peak	

Test Mode: WCDMA Band V_TX CH4233

Horizontal

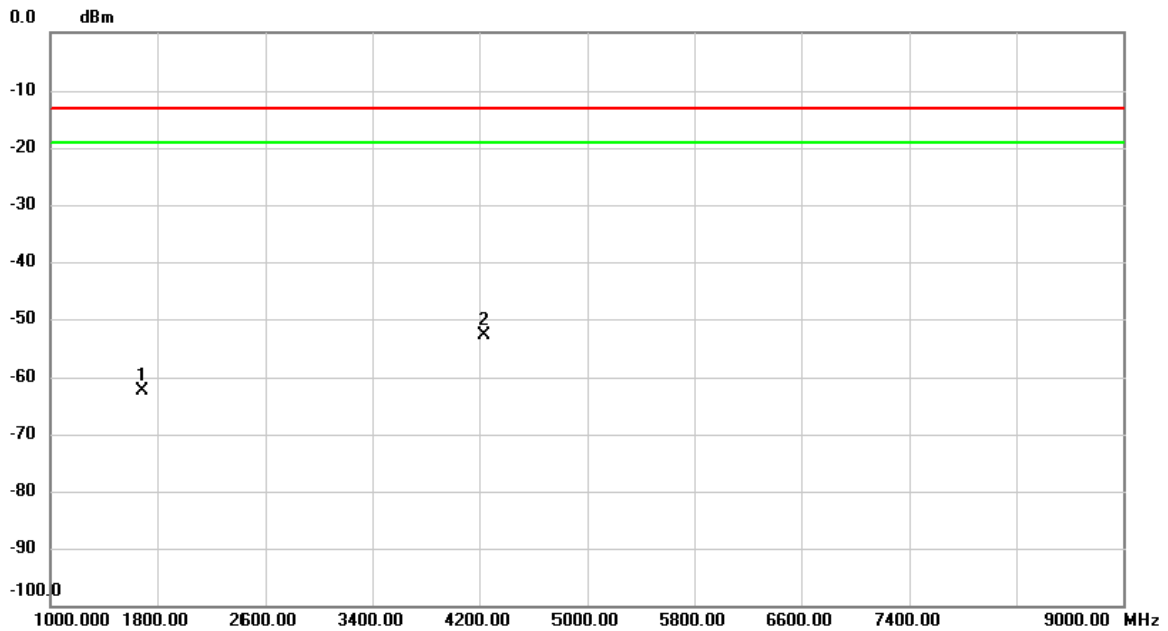

No.	Mk.	Freq. MHz	Reading Level dBm	Correct Factor dB	Measure- ment dBm	Limit dBm	Over dB	Detector	Comment
1		1693.200	-52.03	-10.38	-62.41	-13.00	-49.41	peak	
2	*	4233.000	-52.01	-0.96	-52.97	-13.00	-39.97	peak	

ATTACHMENT C – PEAK TO AVERAGE RATIO

WCDMA Band V Spectrum Plot

4132



4182

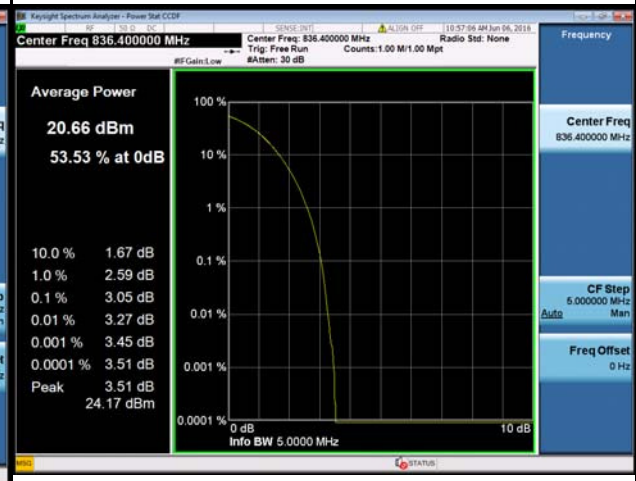

4233

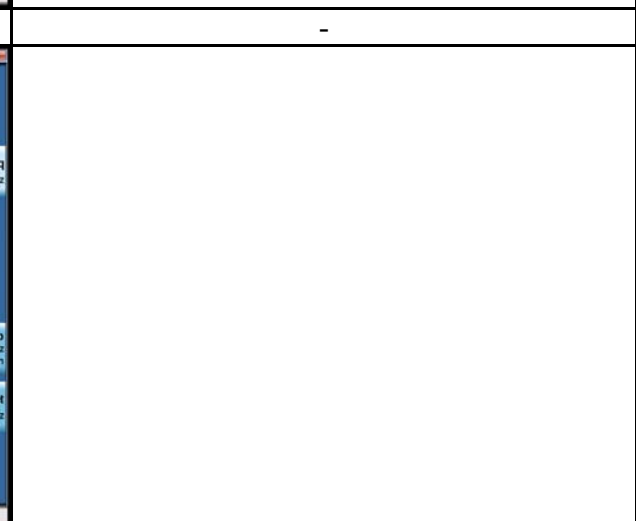

ATTACHMENT D - FREQUENCY STABILITY

Test Mode:	WCDMA Band V_CH4132
------------	---------------------

Operation temperature: -20~60°C

Operation voltage: DC 3.15 - 4.3V

Temperature vs. Frequency Stability

Temperature(°C)	Frequency Error (Hz)	Frequency Error (ppm)	Limit(ppm)
-20	1.22	0.001	2.5
-10	4.3	0.005	2.5
0	-0.09	0.000	2.5
10	-2.22	-0.003	2.5
20	-1.93	-0.002	2.5
30	-2.44	-0.003	2.5
40	-4.85	-0.006	2.5
50	3.16	0.004	2.5
55	4.72	0.006	2.5
60	0.89	0.001	2.5
Max. Deviation (ppm)	-4.85	-0.006	2.5

Voltage vs. Frequency Stability

Voltage(Volts)	Frequency Error (Hz)	Frequency Error (ppm)	Limit(ppm)
3.15	-0.88	-0.001	2.5
3.7	3.7	0.004	2.5
4.3	3.47	0.004	2.5
Max. Deviation (ppm)	3.7	0.004	2.5

Note: The USB power is for battery charging, so only the battery supplied voltage range is used for testing.

Test Mode:	WCDMA Band V_CH4182
------------	---------------------

Operation temperature: -20~60°C

Operation voltage: DC 3.15 - 4.3V

Temperature vs. Frequency Stability

Temperature(°C)	Frequency Error (Hz)	Frequency Error (ppm)	Limit(ppm)
-20	1.32	0.002	2.5
-10	2.26	0.003	2.5
0	-1.47	-0.002	2.5
10	-2.47	-0.003	2.5
20	-1.43	-0.002	2.5
30	-2.30	-0.003	2.5
40	-2.80	-0.003	2.5
50	2.10	0.003	2.5
55	2.33	0.003	2.5
60	2.53	0.003	2.5
Max. Deviation (ppm)	-2.80	-0.003	2.5

Voltage vs. Frequency Stability

Voltage(Volts)	Frequency Error (Hz)	Frequency Error (ppm)	Limit(ppm)
3.15	-1.43	-0.002	2.5
3.7	2.22	0.003	2.5
4.3	3.49	0.004	2.5
Max. Deviation (ppm)	3.49	0.004	2.5

Note: The USB power is for battery charging, so only the battery supplied voltage range is used for testing.

Test Mode:	WCDMA Band V_CH4233
------------	---------------------

Operation temperature: -20~60°C

Operation voltage: DC 3.15 - 4.3V

Temperature vs. Frequency Stability

Temperature(°C)	Frequency Error (Hz)	Frequency Error (ppm)	Limit(ppm)
-20	2.15	0.003	2.5
-10	2.27	0.003	2.5
0	0.85	0.001	2.5
10	-1.56	-0.002	2.5
20	-4.30	-0.005	2.5
30	2.77	0.003	2.5
40	0.68	0.001	2.5
50	-3.00	-0.004	2.5
55	2.10	0.002	2.5
60	-0.93	-0.001	2.5
Max. Deviation (ppm)	-4.30	-0.005	2.5

Voltage vs. Frequency Stability

Voltage(Volts)	Frequency Error (Hz)	Frequency Error (ppm)	Limit(ppm)
3.15	1.00	0.001	2.5
3.7	1.25	0.001	2.5
4.3	1.79	0.002	2.5
Max. Deviation (ppm)	1.79	0.002	2.5

Note: The USB power is for battery charging, so only the battery supplied voltage range is used for testing.