



REPORT No. : SZ15030028E02

FCC TEST REPORT

APPLICANT : Group Sense Mobile-Tech Limited
PRODUCT NAME : WiFi PDA
MODEL NAME : DT4100
TRADE NAME : Group Sense Mobile-Tech Limited
BRAND NAME : Xplore
FCC ID : VRI-B217
STANDARD(S) : 47 CFR Part 15 Subpart B
TEST DATE : 2015-03-25 to 2015-04-08
ISSUE DATE : 2015-04-13



SHENZHEN MORLAB COMMUNICATIONS TECHNOLOGY Co., Ltd.

NOTE: This document is issued by MORLAB, the test report shall not be reproduced except in full without prior written permission of the company. The test results apply only to the particular sample(s) tested and to the specific tests carried out which is available on request for validation and information confirmed at our website.

MORLAB GROUP

FL1-3, Building A, FeiYang Science Park, No.8 LongChang Road,
Block67, BaoAn District, ShenZhen , Guangdong Province, P. R. China

Tel: 86-755-36698555 Fax: 86-755-36698525
Http://www.morlab.cn E-mail: service@morlab.cn



DIRECTORY

<u>1. TECHNICAL INFORMATION</u>	5
1.1. APPLICANT INFORMATION.....	5
1.2. EQUIPMENT UNDER TEST (EUT) DESCRIPTION.....	5
<u>2. TEST RESULTS</u>	6
2.1. APPLIED REFERENCE DOCUMENTS	6
<u>3. TEST CONDITIONS SETTING</u>	7
3.1. TEST MODE	7
3.2. TEST SETUP AND EQUIPMENTS LIST.....	8
3.2.1. CONDUCTED EMISSION	8
3.2.2. RADIATED EMISSION.....	9
<u>4. 47 CFR PART 15B REQUIREMENTS</u>	11
4.1. CONDUCTED EMISSION.....	11
4.1.1. REQUIREMENT	11
4.1.2. TEST DESCRIPTION	11
4.1.3. TEST RESULT	11
4.2. RADIATED EMISSION.....	14
4.2.1. REQUIREMENT	14
4.2.2. TEST DESCRIPTION	14
4.2.3. FREQUENCY RANGE OF MEASUREMENT	15
4.2.4. TEST RESULT	15
<u>ANNEX A TEST UNCERTAINTY</u>	18
<u>ANNEX B TESTING LABORATORY INFORMATION</u>	19
1. IDENTIFICATION OF THE RESPONSIBLE TESTING LABORATORY	19
2. IDENTIFICATION OF THE RESPONSIBLE TESTING LOCATION.....	19



3. TEST ENVIRONMENT CONDITIONS19

Change History		
Issue	Date	Reason for change
1.0	2015-04-13	First edition



Test Report Declaration

Applicant	Group Sense Mobile-Tech Limited
Applicant Address	Room 13-24, 2/F, Sino Industrial Plaza, 9 Kai Cheung Road, Kowloon Bay, Kowloon, Hong Kong
Manufacturer	Group Sense Mobile-Tech Limited
Manufacturer Address	Room 13-24, 2/F, Sino Industrial Plaza, 9 Kai Cheung Road, Kowloon Bay, Kowloon, Hong Kong
Product Name	WiFi PDA
Model Name	DT4100
Brand Name	Xplore
HW Version	PP1
SW Version	B217-V1.00.0009-20150302
Test Standards	47 CFR Part 15 Subpart B
Test Result	PASS

Tested by : Cai Junlong
Cai Junlong (Test Engineer)

Reviewed by : Xiao Xiong
Xiao Xiong (EMC Manager)

Approved by : Zeng Dexin
Zeng Dexin (Chief Engineer)



1. Technical Information

Note: Provide by applicant.

1.1. Applicant Information

Company: Group Sense Mobile-Tech Limited
Address: Room 13-24, 2/F, Sino Industrial Plaza, 9 Kai Cheung Road, Kowloon Bay, Kowloon, Hong Kong

1.2. Equipment under Test (EUT) Description

EUT Type:	WiFi PDA	
Serial No:	(n.a., marked #1 by test site)	
Hardware Version:	PP1	
Software Version:	B217-V1.00.0009-20150302	
Power supply:	Battery	
	Brand Name:	NIL
	Model No.:	BT-DT4000
	Serial No.:	(n.a. marked #1 by test site)
	Capacity:	2700mAh
	Rated Voltage:	3.7V
	Charge Limit:	5V
Ancillary Equipment:	AC Adapter (Charger for Battery)	
	Brand Name:	NIL
	Model No.:	S040EM1500230
	Serial No.:	(n.a. marked #1 by test site)
	Rated Input:	~ 100-240V, 50/60Hz, 1200mA
	Rated Output:	≡ 15V, 2300mA

NOTE:

1. The EUT is a WiFi PDA, It supports NFC, 5.8GHz, 2.4GHz Bluetooth band, WIFI(802.11a/b/g/n) band. It has a T-Flash card slot, and a USB port which can be connected to the ancillary equipments.
2. For a more detailed description, please refer to Specification or User's Manual supplied by the applicant and/or manufacturer.



2. Test Results

2.1. Applied Reference Documents

The objective of the report is to perform testing according to 47 CFR Part 15 Subpart B:

No.	Identity	Document Title
1	47 CFR Part 15(10-1-13 Edition)	Radio Frequency Devices

Test detailed items/section required by FCC rules and results are as below:

No.	Section	Description	Result
1	15.107	Conducted Emission	PASS
2	15.109	Radiated Emission	PASS

NOTE: The tests were performed according to the method of measurements prescribed in ANSI C63.4-2009.



3. Test Conditions Setting

3.1. Test Mode

1	The first test mode (Data Transmission) The EUT configuration of the emission tests is EUT + Battery +T-Flash Card+PC. During the test, the EUT with a T-Flash card embedded is connected with a PC via a USB cable, the data is transmitting between the PC and the TransFlash Card of the EUT.
2	The second test mode (Standby) The EUT configuration of the emission tests is EUT + Battery + Charging Cradle +Charger. During the test, The EUT was embedded in the Charging Cradle and keep charging.
Note: All test modes are performed, only the worse case(Data Transmission) is recorded in this report.	

3.2. Test Setup and Equipments List

3.2.1. Conducted Emission

A. Test Setup:

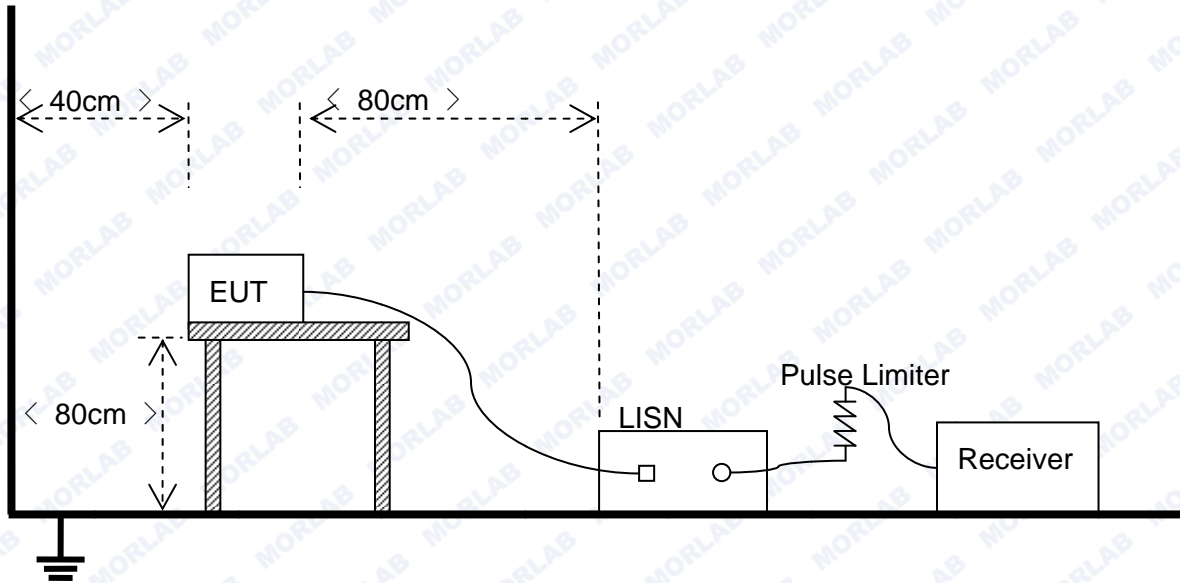

The EUT is placed on a 0.8m high insulating table, which stands on the grounded conducting floor, and keeps 0.4m away from the grounded conducting wall. The EUT is connected to the power mains through a LISN which provides $50\Omega/50\mu\text{H}$ of coupling impedance for the measuring instrument. A Pulse Limiter is used to protect the measuring instrument. The factors of the whole test system are calibrated to correct the reading.

B. Equipments List:

Description	Manufacturer	Model	Serial No.	Cal. Date	Due. Date
Receiver	Narda	PMM 9010	595WX11007	2015.2.21	2016.2.20
EMC Analyzer	Agilent	E7405A	US44210471	2015.2.21	2016.2.20
LISN	Schwarzbeck	NSLK 8127	812744	2015.2.24	2016.2.23
Pulse Limiter (20dB)	Schwarzbeck	VTSD 9561-D	9391	(n.a.)	(n.a.)
System Simulator	Agilent	E5515C	GB43130131	2015.2.21	2016.2.20
PC	Apple	A1370	C02FQ2PYD DQW	(n.a.)	(n.a.)

3.2.2. Radiated Emission

A. Test Setup:

1. For radiated emissions from 30MHz to1GHz

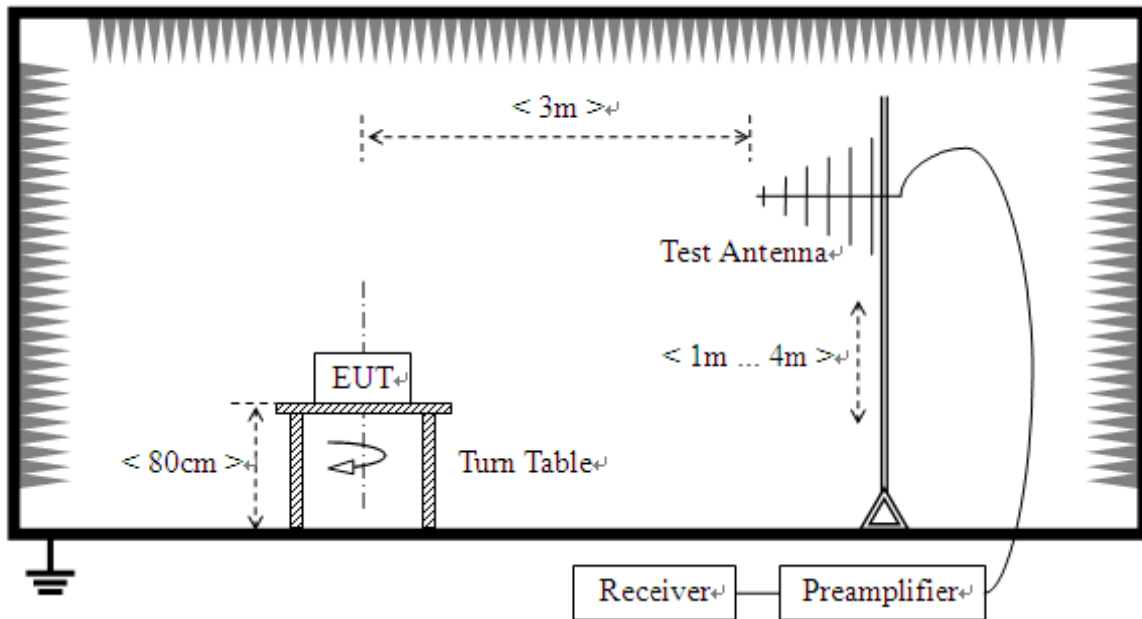

2. For radiated emissions above 1GHz

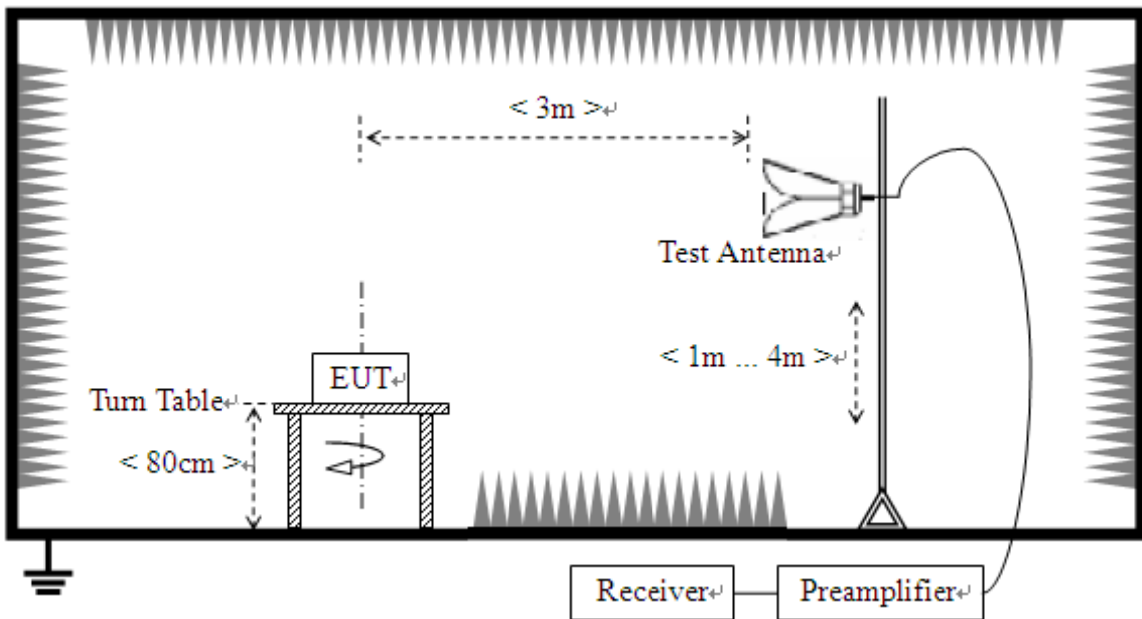



The test is performed in a 3m Semi-Anechoic Chamber; the antenna factor, cable loss and so on of the site (factors) is calculated to correct the reading. The EUT is placed on a 0.8m high insulating Turn Table, and keeps 3m away from the Test Antenna, which is mounted on a variable-height antenna master tower.

For the test Antenna:

In the frequency range above 30MHz, Bi-Log Test Antenna (30MHz to 1GHz) and Horn Test Antenna (above 1GHz) are used. Test Antenna is 3m away from the EUT. Test Antenna height is varied from 1m to 4m above the ground to determine the maximum value of the field strength. The emission levels at both horizontal and vertical polarizations should be tested.

B. Equipments List:

Description	Manufacturer	Model	Serial No.	Cal. Date	Due. Date
EMC Analyzer	Agilent	E7405A	US44210471	2015.2.21	2016.2.20
Receiver	Narda	PMM 9060	001WX11001	2015.2.21	2016.2.20
Receiver	Narda	PMM 9010	595WX11007	2015.2.21	2016.2.20
Semi-Anechoic Chamber	Albatross	9m*6m*6m	(n.a.)	2015.2.21	2016.2.20
Test Antenna - Bi-Log	Schwarzbeck	VULB 9163	9163-274	2015.2.25	2016.2.24
Test Antenna - Horn	Schwarzbeck	BBHA 9120D	9120D-963	2015.2.25	2016.2.24
PC	Apple	A1370	C02FQ2PYD DQW	(n.a.)	(n.a.)



4. 47 CFR Part 15B Requirements

4.1. Conducted Emission

4.1.1. Requirement

According to FCC section 15.107, the radio frequency voltage that is conducted back onto the AC power line on any frequency within the band 150kHz to 30MHz shall not exceed the limits in the following table, as measured using a 50 μ H/50 Ω line impedance stabilization network (LISN).

Frequency range (MHz)	Conducted Limit (dB μ V)	
	Quasi-peak	Average
0.15 - 0.50	66 to 56	56 to 46
0.50 - 5	56	46
5 - 30	60	50

NOTE:

- The limit subjects to the Class B digital device.
- The lower limit shall apply at the band edges.
- The limit decreases linearly with the logarithm of the frequency in the range 0.15 - 0.50MHz.

4.1.2. Test Description

See section 3.2.1 of this report.

4.1.3. Test Result

The maximum conducted interference is searched using Peak (PK), Quasi-peak (QP) and Average (AV) detectors; the emission levels more than the AV and QP limits, and that have narrow margins from the AV and QP limits will be re-measured with AV and QP detectors. Tests for both L phase and N phase lines of the power mains connected to the EUT are performed. All test modes are considered, refer to recorded points and plots below.

A. Test Plot and Suspicious Points:

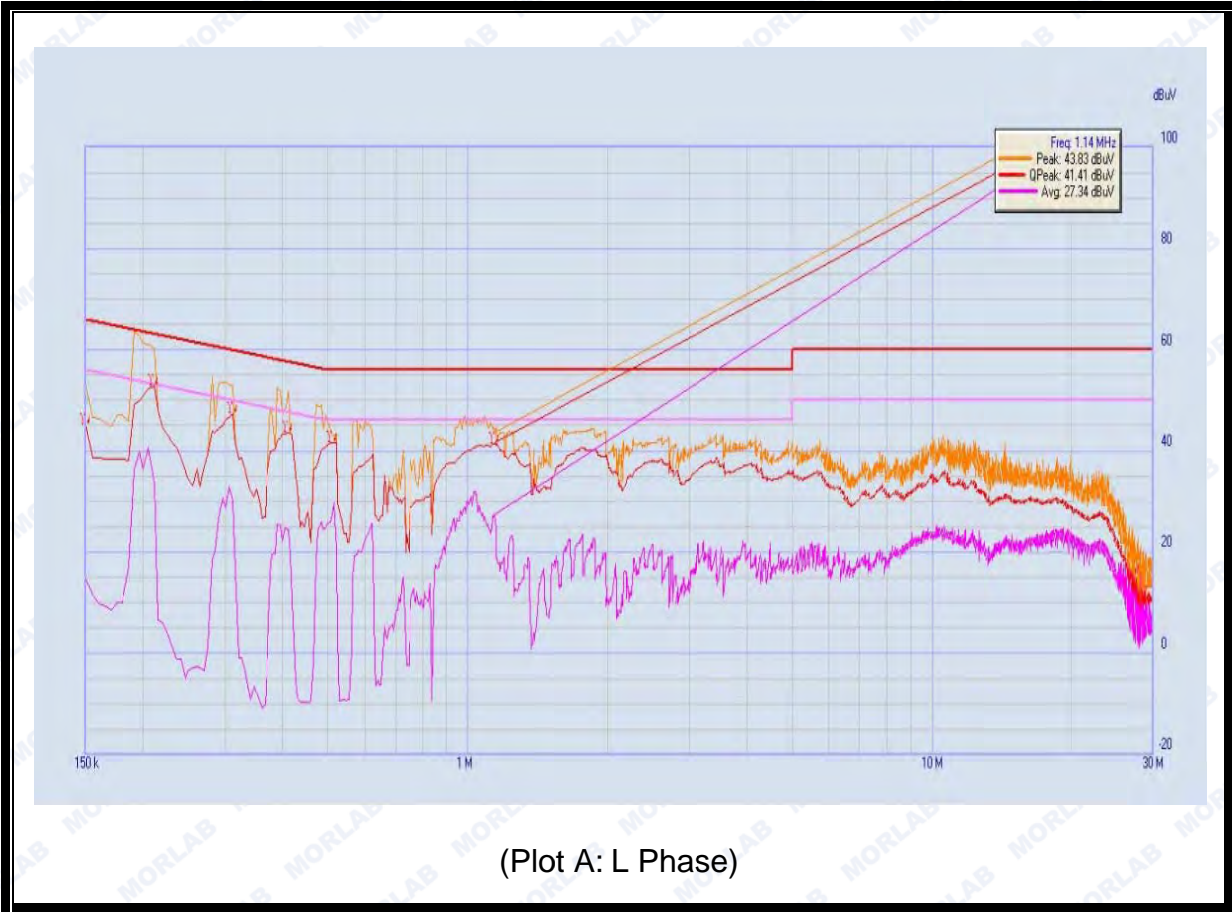

NO.	Fre. (MHz)	Emission Level (dBμV)		Limit (dBμV)		Power-line	Verdict
		Quai-peak	Average	Quai-peak	Average		
1	0.15	45.06	14.80	66.00	56.00	Line	PASS
2	0.21	52.79	33.71	64.29	54.29		PASS
3	0.31	47.33	30.08	61.43	51.43		PASS
4	0.41	43.55	24.52	58.57	48.57		PASS
5	0.51	41.76	27.48	56.00	46.00		PASS
6	1.14	41.41	27.34	56.00	46.00		PASS

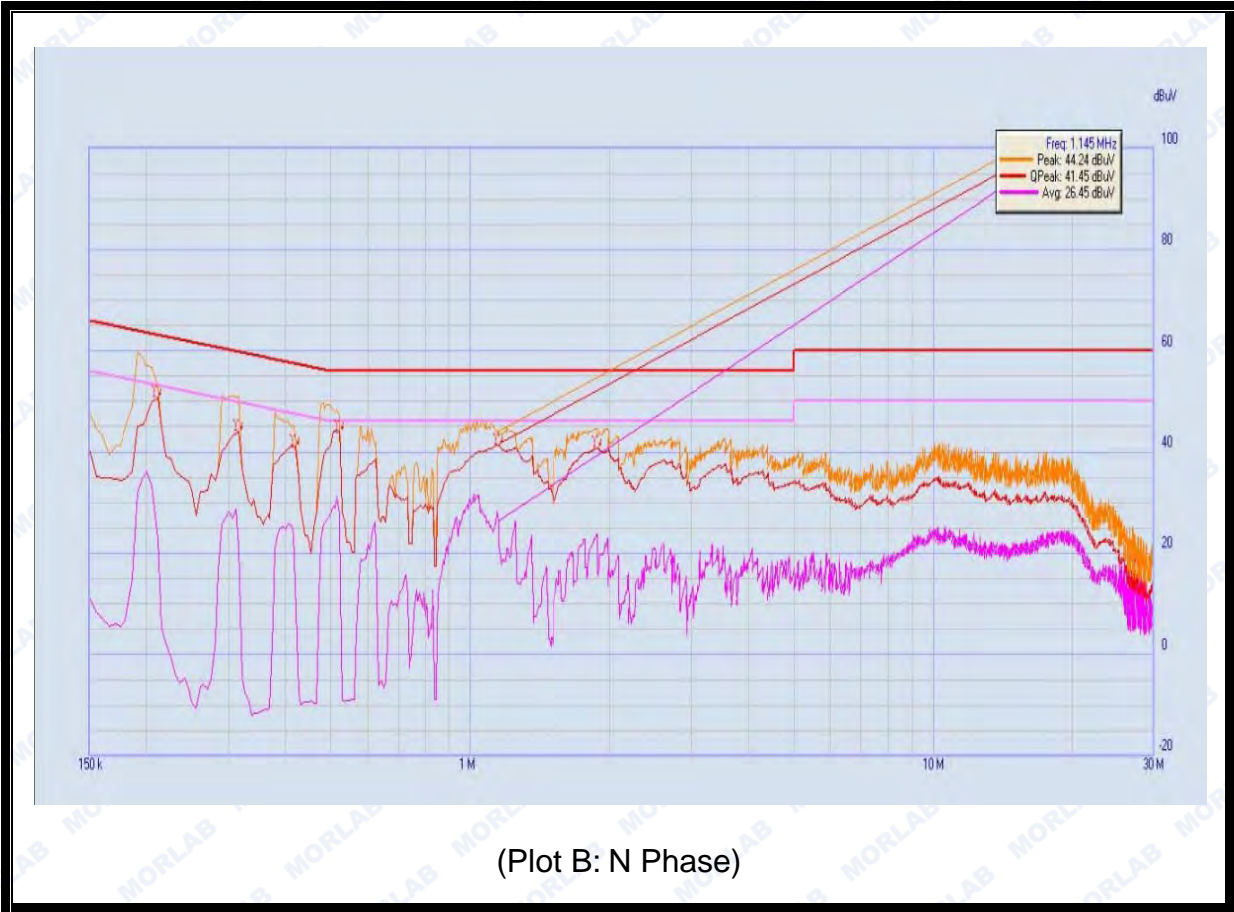

NO.	Fre. (MHz)	Emission Level (dBμV)		Limit (dBμV)		Power-line	Verdict
		Quai-peak	Average	Quai-peak	Average		
1	0.21	50.83	18.65	64.29	54.29	Neutral	PASS
2	0.315	44.06	13.49	61.29	51.29		PASS
3	0.42	41.20	7.07	58.29	48.29		PASS
4	0.52	44.16	12.21	56.00	46.00		PASS
5	1.145	41.43	24.91	56.00	46.00		PASS
6	1.875	40.93	33.18	56.00	46.00		PASS

Test Result: PASS



4.2. Radiated Emission

4.2.1. Requirement

According to FCC section 15.109(a), the field strength of radiated emissions from unintentional radiators at a distance of 3 meters shall not exceed the following values:

Frequency range (MHz)	Field Strength		Field Strength Limitation at 3m Measurement Dist	
	$\mu\text{V/m}$	Dist	$(\mu\text{V/m})$	$(\text{dB}\mu\text{V/m})$
30.0 - 88.0	100	3m	100	20log 100
88.0 - 216.0	150	3m	150	20log 150
216.0 - 960.0	200	3m	200	20log 200
Above 960.0	500	3m	500	20log 500

As shown in FCC section 15.35(b), for frequencies above 1000MHz, the field strength limits are based on average detector. When average radiated emission measurements are specified in this part, including emission measurements below 1000MHz, there also is a limit on the radio frequency emissions, as measured using instrumentation with a peak detector function, corresponding to 20dB above the maximum permitted average limit for the frequency being investigated unless a different peak emission limit is otherwise specified in the rules.

Note:

- 1) The tighter limit shall apply at the boundary between two frequency range.
- 2) Limitation expressed in $\text{dB}\mu\text{V/m}$ is calculated by $20\log \text{Emission Level}(\mu\text{V/m})$.
- 3) If measurement is made at 3m distance, then F.S Limitation at 3m distance is adjusted by using the formula of $Ld1 = Ld2 * (d2/d1)^2$.

Example:

F.S Limit at 30m distance is $30\mu\text{V/m}$, then F.S Limitation at 3m distance is adjusted as

$$Ld1 = L1 = 30\mu\text{V/m} * (10)^2 = 100 * 30\mu\text{V/m}$$

4.2.2. Test Description

See section 3.2.2 of this report.



4.2.3. Frequency range of measurement

Highest frequency generated or used in the device is the highest speed of the processor, lowest frequency generated or used in the device is the lowest frequency of the oscillator. According to 15.33(b)(1), the frequency range of radiated measurement for the EUT is listed in the following table:

Frequency	Frequency generated or used in the device	Frequency range of radiated measurement in the report
Highest	800MHz	5GHz

4.2.4. Test Result

The maximum radiated emission is searched using PK, QP and AV detectors; the emission levels more than the limits, and that have narrow margins from the limits will be re-measured with AV and QP detectors. Both the vertical and the horizontal polarizations of the Test Antenna are considered to perform the tests. All test modes are considered, refer to recorded points and plots below.

The amplitude of spurious emissions which are attenuated more than 20 dB below the permissible value need not be reported.

Note: All radiated emission tests were performed in X, Y, Z axis direction, and only the worst axis test condition was recorded in this test report.

A. Test Plots and Suspicious Points:

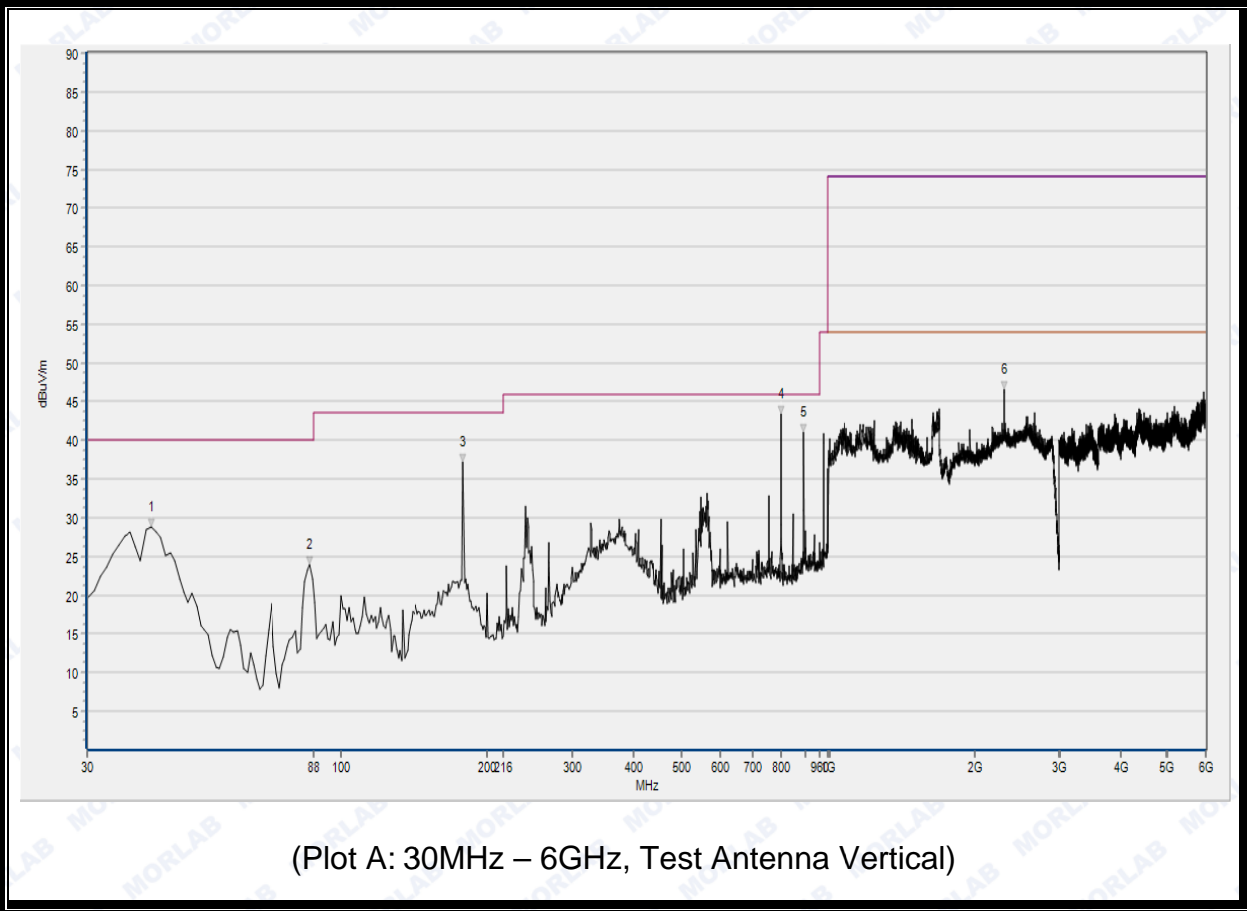

NO.	Fre. (MHz)	Pk	QP	AV	Limit- PK	Limit- QP	Limit- AV	Antenna	Verdict
1	40.670	N.A	28.88	N.A	N.A	40.00	N.A	Vertical	Pass
2	86.260	N.A	23.93	N.A	N.A	40.00	N.A	Vertical	Pass
3	178.410	N.A	37.24	N.A	N.A	43.50	N.A	Vertical	Pass
4	802.120	N.A	43.40	N.A	N.A	46.00	N.A	Vertical	Pass
5	891.360	N.A	41.08	N.A	N.A	46.00	N.A	Vertical	Pass
6	2316.000	46.60	N.A	40.01	74.00	N.A	54.00	Vertical	Pass

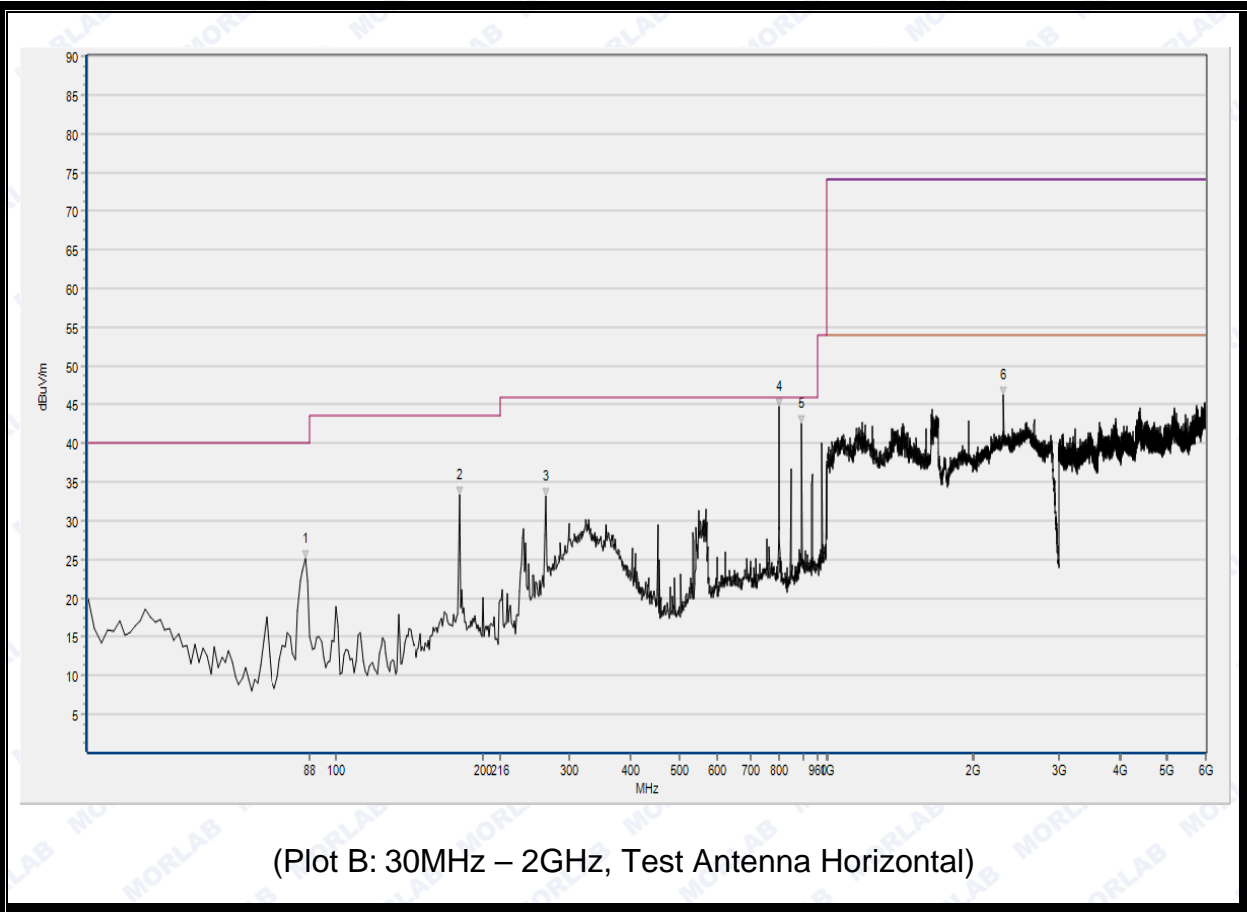

NO.	Fre. (MHz)	Pk	QP	AV	Limit-PK	Limit-QP	Limit-AV	Antenna	Verdict
1	86.260	N.A	25.19	N.A	N.A	40.00	N.A	Horizontal	Pass
2	178.410	N.A	33.37	N.A	N.A	43.50	N.A	Horizontal	Pass
3	267.650	N.A	33.17	N.A	N.A	46.00	N.A	Horizontal	Pass
4	802.120	N.A	42.13	N.A	N.A	46.00	N.A	Horizontal	Pass
5	891.360	N.A	42.54	N.A	N.A	46.00	N.A	Horizontal	Pass
6	2316.000	46.19	N.A	39.86	74.00	N.A	54.00	Horizontal	Pass

Test Result: PASS



Annex A Test Uncertainty

The uncertainty is calculated using the methods suggested in the "Guide to the Expression of Uncertainty in Measurement" (GUM) published by ISO.

Uncertainty of Conducted Emission:	$\pm 1.8\text{dB}$
Uncertainty of Radiated Emission:	$\pm 3.1\text{dB}$



Annex B Testing Laboratory Information

1. Identification of the Responsible Testing Laboratory

Company Name:	Shenzhen Morlab Communications Technology Co., Ltd.
Department:	Morlab Laboratory
Address:	FL.3, Building A, FeiYang Science Park, No.8 LongChang Road, Block 67, BaoAn District, ShenZhen, GuangDong Province, P. R. China
Responsible Test Lab Manager:	Mr. Su Feng
Telephone:	+86 755 36698555
Facsimile:	+86 755 36698525

2. Identification of the Responsible Testing Location

Name:	Shenzhen Morlab Communications Technology Co., Ltd. Morlab Laboratory
Address:	FL.3, Building A, FeiYang Science Park, No.8 LongChang Road, Block 67, BaoAn District, ShenZhen, GuangDong Province, P. R. China

3. Test Environment Conditions

During the measurement, the environmental conditions were within the listed ranges:

Temperature (°C):	15 - 35
Relative Humidity (%):	30 - 60
Atmospheric Pressure (kPa):	86 - 106

***** END OF REPORT *****