

FCC RADIO TEST REPORT

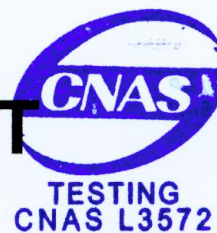

Issued to

Group Sense Mobile-Tech Limited

For

Wireless POS Handheld Terminal

Model Name: DT-07
Trade Name: Xplore / Touch Dynamic
Brand Name: Xplore / Touch Dynamic
FCC ID: VRI-B195
Standard: 47 CFR Part 15 Subpart C
Test date: 2014-01-04 to 2014-01-20
Issue date: 2014-03-31

by

Shenzhen Morlab Communications Technology Co., Ltd.

FL.3, Building A, FeiYang Science Park, No.8 LongChang Road,Block 67, BaoAn District,
ShenZhen, GuangDong Province, P. R. China 518101

Tested by

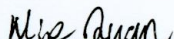

Nie Quan
(Test Engineer)

Date

2014.3.31

Approved by

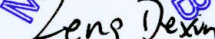

Zeng Dexin
(Chief Engineer)

Date

2014.3.31

Reviewed by

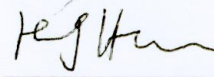

Peng Huarui
(Dept. Manager)

Date

2014.3.31



The report refers only to the sample tested and does not apply to the bulk. This report is issued in confidence to the client and it will be strictly treated as such by the Shenzhen MORLAB Communication Technology Co., Ltd. It may not be reproduced rather in its entirety or in part and it may not be used for advertising. The client to whom the report is issued may, however, show or send it, or a certified copy thereof prepared by the Shenzhen MORLAB Telecommunication Co., Ltd to his customer. Supplier or others persons directly concerned. Shenzhen MORLAB Telecommunication Co., Ltd will not, without the consent of the client enter into any discussion of correspondence with any third party concerning the contents of the report. In the event of the improper use of the report, Shenzhen MORLAB Telecommunication Co., Ltd reserves the rights to withdraw it and to adopt any other remedies which may be appropriate



TABLE OF CONTENTS

- 1. GENERAL INFORMATION..... 4**
- 1.1. EUT DESCRIPTION 4
- 2. TEST STANDARDS AND RESULTS 5**
- 2.1. FACILITIES AND ACCREDITATIONS..... 6
- 2.1.1. FACILITIES.....6
- 2.1.2. TEST ENVIRONMENT CONDITIONS6
- 3. 47 CFR PART 15C REQUIREMENTS 7**
- 3.1. ANTENNA REQUIREMENT 7
- 3.1.1. APPLICABLE STANDARD.....7
- 3.1.2. RESULT: COMPLIANT7
- 3.2. PEAK OUTPUT POWER 7
- 3.2.1. REQUIREMENT.....7
- 3.2.2. TEST DESCRIPTION.....7
- 3.2.3. TEST RESULT.....8
- 3.2.3.1. 802.11B TEST MODE.....8
- 3.2.3.2. 802.11G TEST MODE8
- 3.2.3.3. 802.11N-20MHZ TEST MODE.....8
- 3.3. BANDWIDTH..... 9
- 3.3.1. REQUIREMENT.....9
- 3.3.2. TEST DESCRIPTION.....9
- 3.3.3. TEST RESULT.....9
- 3.3.3.1. 802.11B TEST MODE.....9
- 3.3.3.2. 802.11G TEST MODE13
- 3.3.3.3. 802.11N-20 TEST MODE.....16
- 3.4. CONDUCTED SPURIOUS EMISSIONS AND BAND EDGE20
- 3.4.1. REQUIREMENT.....20
- 3.4.2. TEST DESCRIPTION.....20
- 3.4.3. TEST RESULT.....20
- 3.4.3.1. 802.11B TEST MODE.....21
- 3.4.3.2. 802.11G TEST MODE24
- 3.4.3.3. 802.11N -20MHZ TEST MODE.....27
- 3.5. POWER SPECTRAL DENSITY (PSD).....30



3.5.1. REQUIREMENT.....30

3.5.2. TEST DESCRIPTION.....30

3.5.3. TEST RESULT.....30

3.5.3.1. 802.11B TEST MODE.....30

3.5.3.2. 802.11G TEST MODE32

3.5.3.3. 802.11N-20MHZ TEST MODE.....34

3.6. RESTRICTED FREQUENCY BANDS.....37

3.6.1. REQUIREMENT.....37

3.6.2. TEST DESCRIPTION.....37

3.6.3. TEST RESULT.....38

3.6.3.1. 802.11B TEST MODE.....38

3.6.3.2. 802.11G TEST MODE41

3.6.3.3. 802.11N-20MHZ TEST MODE.....43

3.7. CONDUCTED EMISSION.....46

3.7.1. REQUIREMENT.....46

3.7.2. TEST DESCRIPTION.....46

3.7.3. TEST RESULT.....47

3.8. RADIATED EMISSION.....50

3.8.1. REQUIREMENT.....50

3.8.2. TEST DESCRIPTION.....50

3.8.3. TEST RESULT.....53

3.8.3.1. 802.11B TEST MODE.....53

3.8.3.2. 802.11G TEST MODE57

3.8.3.3. 802.11N-20MHZ TEST MODE.....60

3.9. RF EXPOSURE EVALUATION64

3.9.1. REQUIREMENT.....64

3.9.2. RESULT64

Change History		
Issue	Date	Reason for change
1.0	March 31, 2014	First Edition

1. General Information

1.1. EUT Description

EUT Type :	DT-07 QA1/PP1
Serial No.	(n.a, marked #1 by test site)
Hardware Version :	QA1/PP1
Software Version :	D13
Applicant :	Group Sense Mobile-Tech Limited 6th Floor, Enterprise Building, No.5 Science Park West Avenue, Hong Kong Science Park, Shatin, New Territories, Hong Kong
Manufacturer	Group Sense Mobile-Tech Limited 6th Floor, Enterprise Building, No.5 Science Park West Avenue, Hong Kong Science Park, Shatin, New Territories, Hong Kong
Frequency Range :	802.11b/g/n-20MHz: 2.412GHz - 2.462GHz
Channel Number	802.11b/g/n-20MHz: 11
Modulation Type :	DSSS (802.11b), OFDM (802.11g/n)
Antenna Type	PIFA Antenna
Antenna Gain :	0.6dBi

Note :

- The EUT is DT-07 QA1/PP1, it contains WIFI Module operating at 2.4GHz ISM band; it supports 802.11b, 802.11g, 802.11n and they are all tested in this report.
- For 802.11b/g/n-20MHz, the frequencies allocated is $F \text{ (MHz)} = 2412 + 5 * (n - 1)$ ($1 \leq n \leq 11$). The lowest, middle, highest channel numbers of the EUT used and tested in this report are separately 1 (2412MHz), 6 (2437MHz) and 11 (2462MHz).
For 802.11n-40MHz, the frequencies allocated is $F \text{ (MHz)} = 2412 + 5 * (n - 1)$ ($3 \leq n \leq 9$). The lowest, middle, highest channel numbers of the EUT used and tested in this report are separately 3 (2422MHz), 6 (2437MHz) and 9 (2452MHz).
- For a more detailed description, please refer to Specification or User's Manual supplied by the applicant and/or manufacturer.
- The antenna connector of EUT is designed with permanent attachment and no consideration of replacement.

2. Test Standards and Results

The objective of the report is to perform testing according to 47 CFR Part 15 Subpart C for the EUT FCC Certification:

No.	Identity	Document Title
1	47 CFR Part 15 (10-1-13 Edition)	Radio Frequency Devices

Test detailed items/section required by FCC rules and results are as below:

No.	Section in CFR 47	Section in RSS-GEN, RSS-210	Description	Result
1	15.203	7.1.2	Antenna Requirement	<u>PASS</u>
2	15.247(b)	A8.4 (4)	Peak Output Power	<u>PASS</u>
3	15.247(a)	A8.2 (a)	Bandwidth	<u>PASS</u>
4	15.247(d)	A8.5	Conducted Spurious Emission and Band Edge	<u>PASS</u>
5	15.247(d)	A8.5	Restricted Frequency Bands	<u>PASS</u>
6	15.207	7.2.4	Conducted Emission	<u>PASS</u>
7	15.209 ,15.247(d)	A8.5	Radiated Emission	<u>PASS</u>
8	15.247(e)	A8.2(b)	Power spectral density (PSD)	<u>PASS</u>
9	15.247(i), 1.1307&2.1093	RSS-102	RF exposure evaluation	<u>PASS</u>

The tests of Conducted Emission and Radiated Emission were performed according to the method of measurements prescribed in ANSI C63.4 2009.

These RF tests were performed according to the method of measurements prescribed in KDB558074 D01 v03r01 (04/09/2013).

2.1. Facilities and Accreditations

2.1.1. Facilities

Shenzhen Morlab Communications Technology Co., Ltd. Morlab Laboratory is a testing organization accredited by China National Accreditation Service for Conformity Assessment (CNAS) according to ISO/IEC 17025. The accreditation certificate number is L3572.

All measurement facilities used to collect the measurement data are located at FL.1, Building A, FeiYang Science Park, Block 67, BaoAn District, Shenzhen, 518101 P. R. China. The test site is constructed in conformance with the requirements of ANSI C63.10 2009, ANSI C63.4 2009 and CISPR Publication 22; the FCC registration number is 695796.

2.1.2. Test Environment Conditions

During the measurement, the environmental conditions were within the listed ranges:

Temperature (°C):	15 - 35
Relative Humidity (%):	30 -60
Atmospheric Pressure (kPa):	86-106

3. 47 CFR Part 15C Requirements

3.1. Antenna requirement

3.1.1. Applicable Standard

According to FCC 15.203, an intentional radiator shall be designed to ensure that no antenna other than that furnished by the responsible party shall be used with the device. The use of a permanently attached antenna or of an antenna that uses a unique coupling to the intentional radiator shall be considered sufficient to comply with the provisions of this section.

3.1.2. Result: Compliant

The EUT has a permanently and irreplaceable attached antenna. Please refer to the EUT internal photos.

3.2. Peak Output Power

3.2.1. Requirement

For systems using digital modulation in the 902-928 MHz, 2400-2483.5 MHz, and 5725-5850 MHz bands: The maximum peak conducted output power of the intentional radiator shall not exceed 1 Watt.

3.2.2. Test Description

The measured output power was calculated by the reading of the Power Meter and calibration.

A. Test Setup:

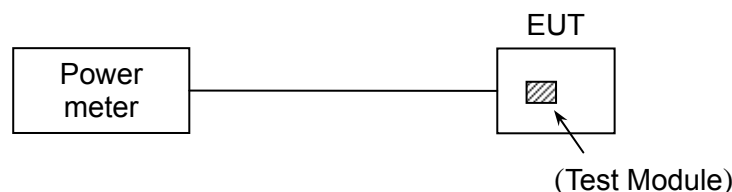

The EUT (Equipment under the test) which is powered by the Battery is coupled to the Power Meter; the RF load attached to the EUT antenna terminal is 50Ohm; the path loss as the factor is calibrated to correct the reading, all test result in power meter.

B. Equipments List:

Description	Manufacturer	Model	Serial No.	Cal. Date	Cal. Due
EPM Series Power Meter	Agilent	E4418B	GB43318055	2013.05.13	2014.05.12
Power Sensor	Agilent	8482A	MY41091706	2013.05.13	2014.05.12

3.2.3. Test Result

The lowest, middle and highest channels are selected to perform testing to verify the conducted RF output peak power of the Module.

3.2.3.1. 802.11b Test mode

Channel	Frequency (MHz)	Measured Output Peak Power		Limit		Verdict
		dBm	W	dBm	W	
1	2412	13.93	0.024717	30	1	PASS
6	2437	14.25	0.026607			PASS
11	2462	14.19	0.026242			PASS

3.2.3.2. 802.11g Test mode

Channel	Frequency (MHz)	Measured Output Peak Power		Limit		Verdict
		dBm	W	dBm	W	
1	2412	12.25	0.016788	30	1	PASS
6	2437	12.65	0.018408			PASS
11	2462	12.60	0.018197			PASS

3.2.3.3. 802.11n-20MHz Test mode

Channel	Frequency (MHz)	Measured Output Peak Power		Limit		Verdict
		dBm	W	dBm	W	
1	2412	12.19	0.016558	30	1	PASS
6	2437	12.57	0.018072			PASS
11	2462	12.51	0.017824			PASS

3.3. Bandwidth

3.3.1. Requirement

Systems using digital modulation techniques may operate in the 902 - 928 MHz, 2400 - 2483.5 MHz, and 5725 - 5850 MHz bands. The minimum 6 dB bandwidth shall be at least 500 kHz.

3.3.2. Test Description

A. Test Set:

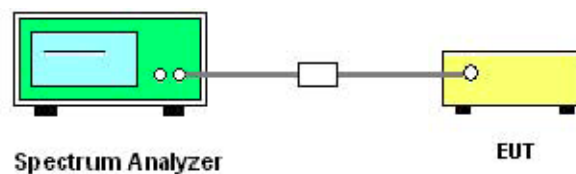

The EUT which is powered by the Battery, is coupled to the Spectrum Analyzer; the RF load attached to the EUT antenna terminal is 50Ohm; the path loss as the factor is calibrated to correct the reading.

Make the measurement with the spectrum analyzer's resolution bandwidth (RBW) = 100 kHz. In order to make an accurate measurement, set the span greater than RBW.

B. Equipments List:

Description	Manufacturer	Model	Serial No.	Cal. Date	Cal. Due
Receiver	Agilent	E7405A	US44210471	2013.05.13	2014.05.12

3.3.3. Test Result

The lowest, middle and highest channels are selected to perform testing to record the 6 dB bandwidth of the Module.

3.3.3.1. 802.11b Test mode

A. Test Verdict:

Channel	Frequency (MHz)	6 dB Bandwidth (MHz)	99% Bandwidth (MHz)	Refer to Plot	Limits(kHz)	Result
1	2412	10.088	13.953	Plot A	≥500	PASS
6	2437	10.109	14.364	Plot B	≥500	PASS
11	2462	10.115	13.768	Plot C	≥500	PASS

B. Test Plots

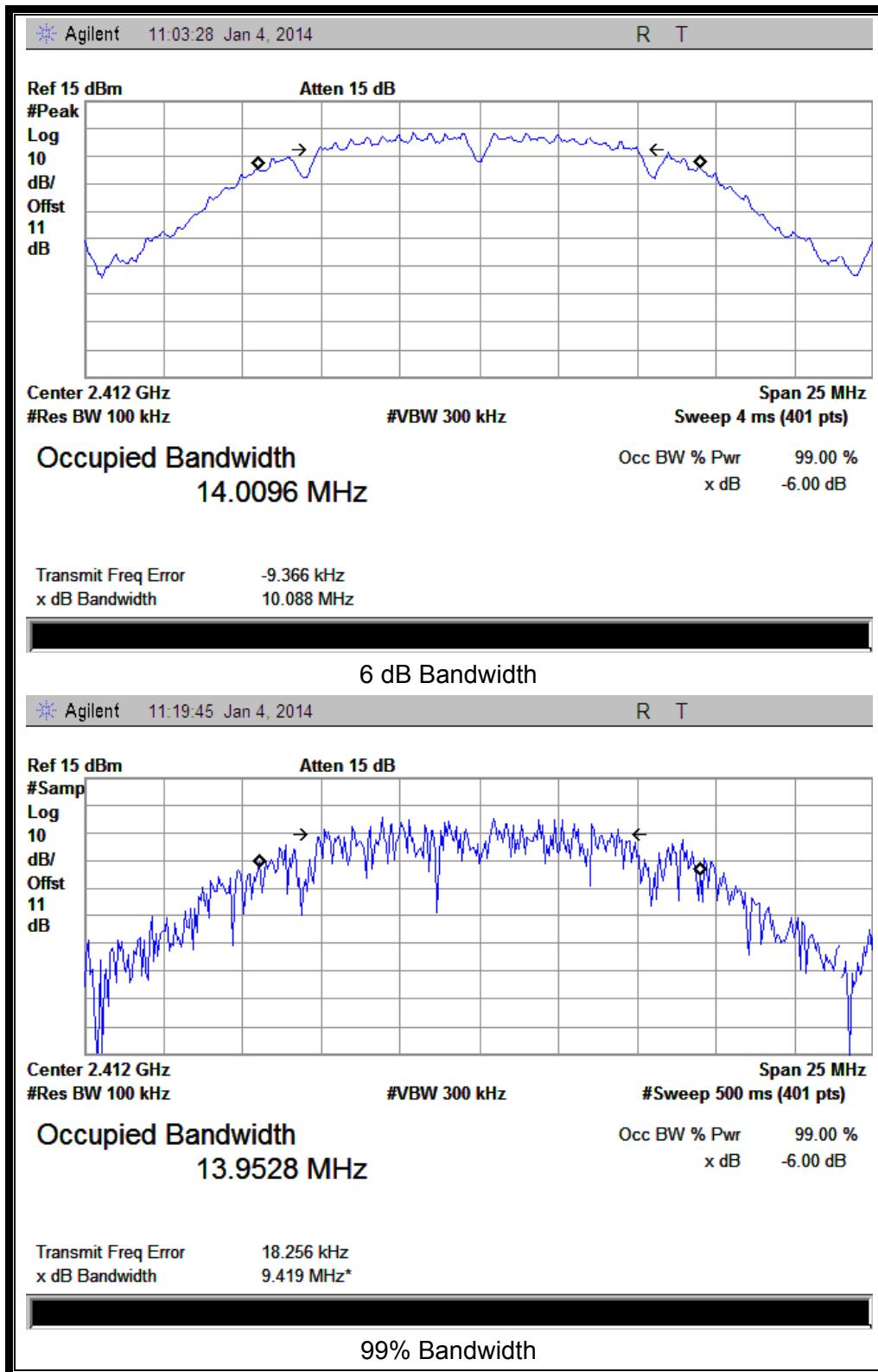

(Plot A: Channel 1: 2412MHz @ 802.11b)

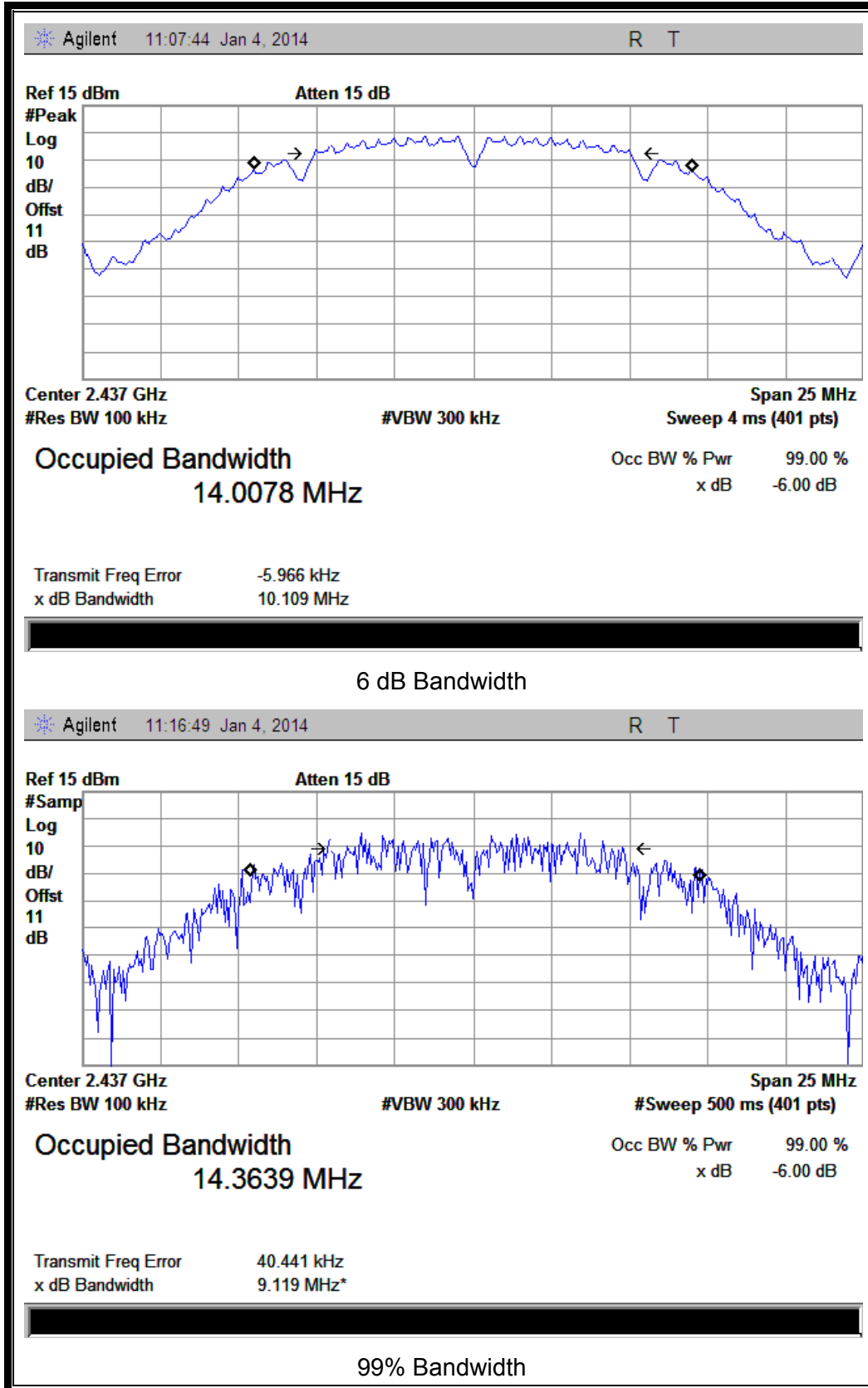

(Plot B: Channel 6: 2437 MHz @ 802.11b)

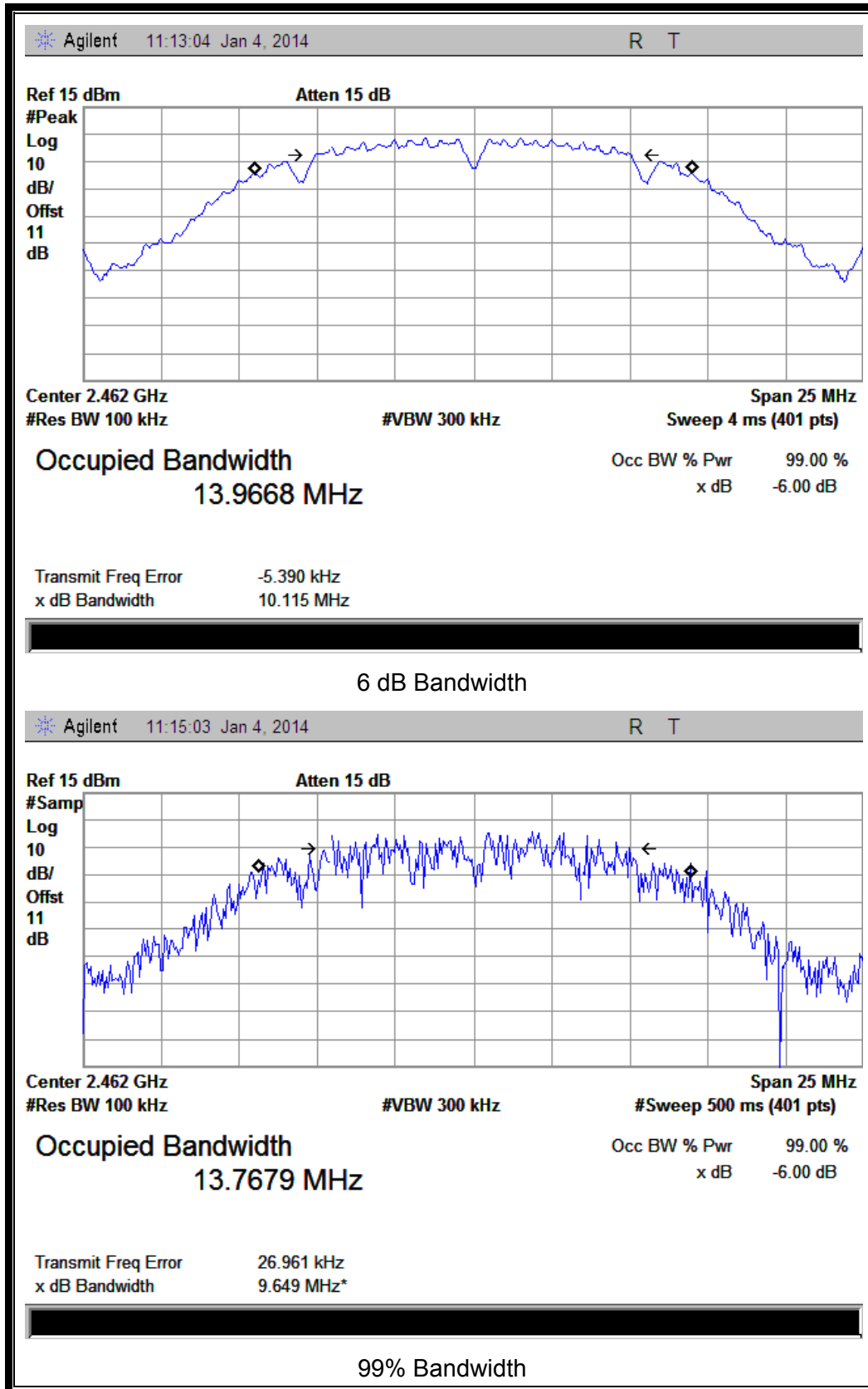

(Plot C: Channel 11: 2462MHz @ 802.11b)

3.3.3.2. 802.11g Test mode

A. Test Verdict:

Channel	Frequency (MHz)	6 dB Bandwidth (MHz)	99% Bandwidth (MHz)	Refer to Plot	Limits(kHz)	Result
1	2412	16.367	16.395	Plot D	≥500	PASS
6	2437	16.367	16.404	Plot E	≥500	PASS
11	2462	16.359	16.414	Plot F	≥500	PASS

B. Test Plots:

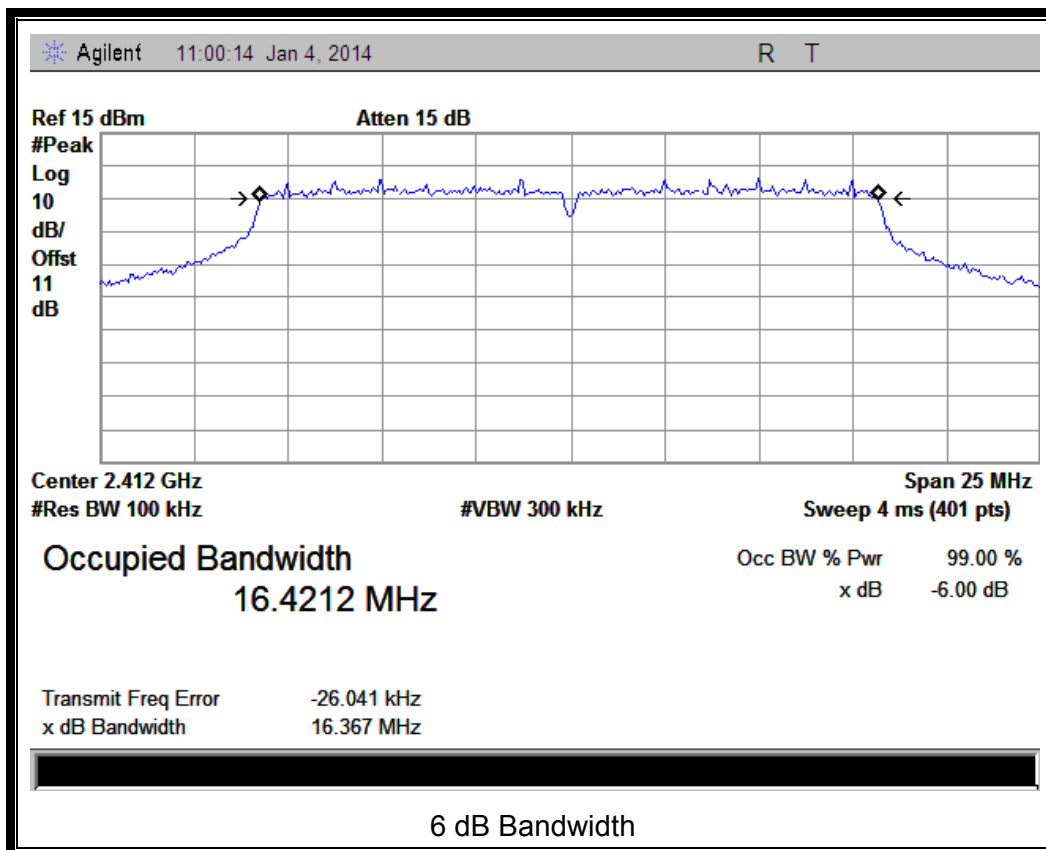

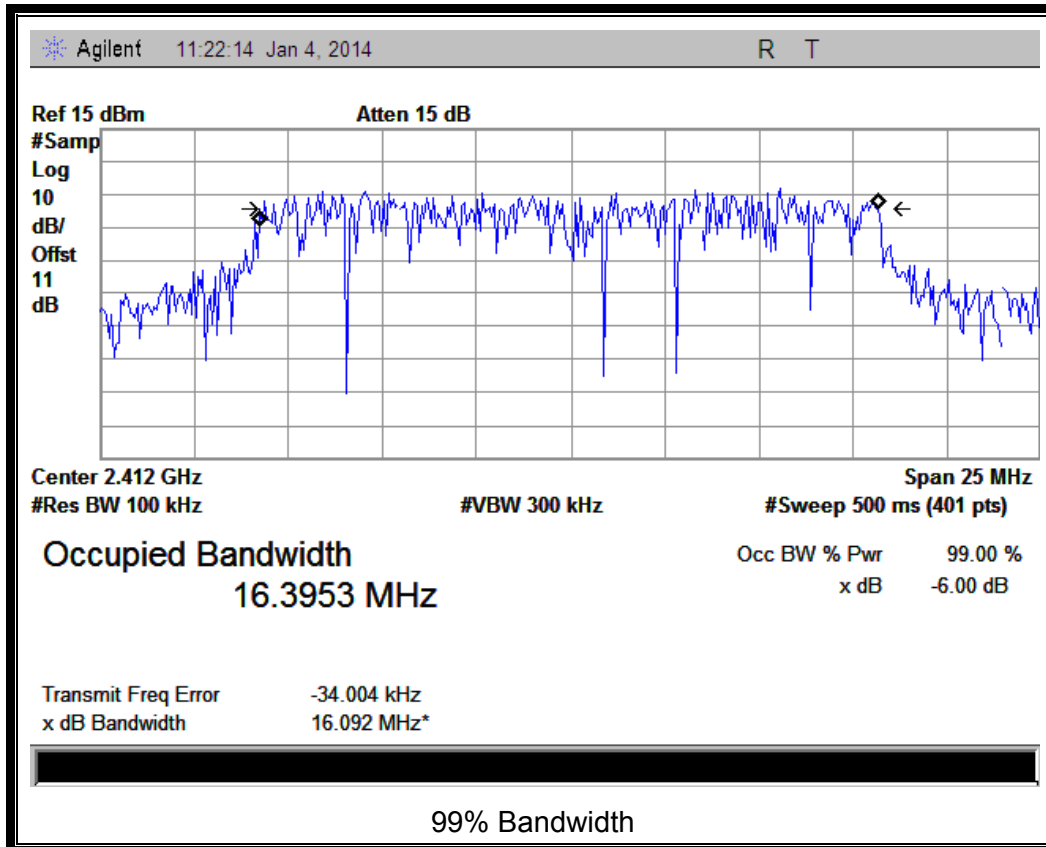

(Plot D: Channel 1: 2412MHz @ 802.11g)

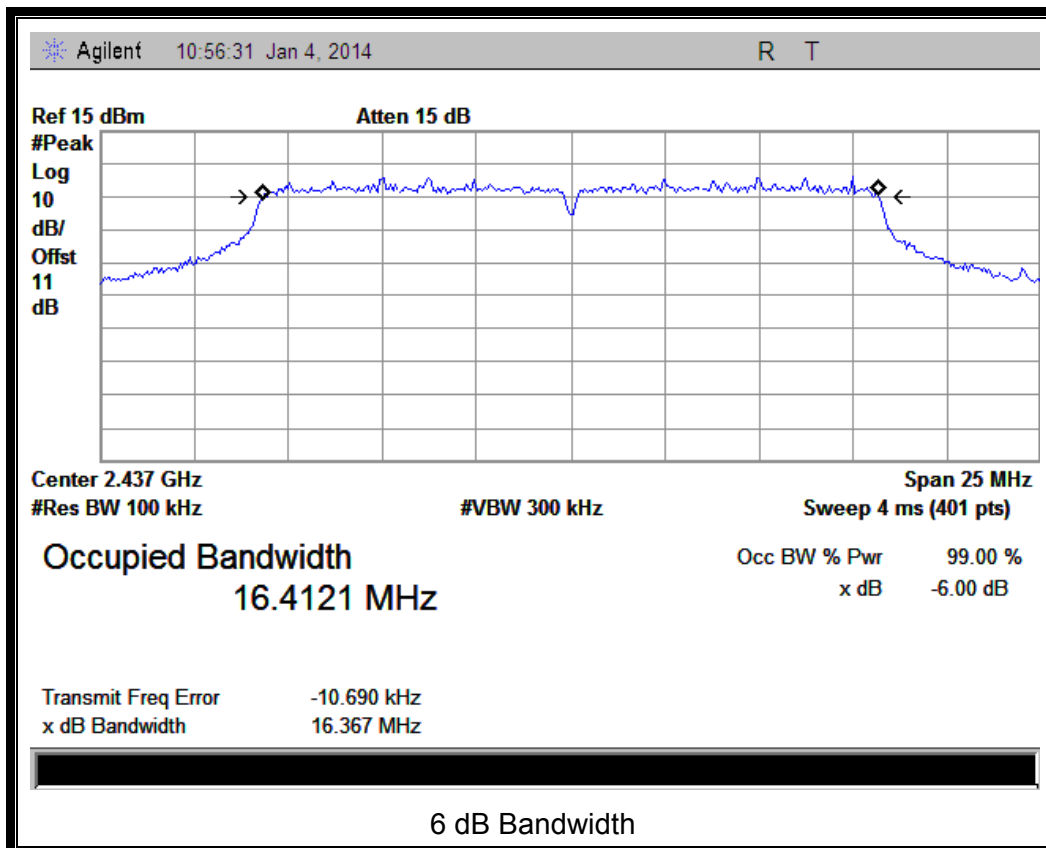

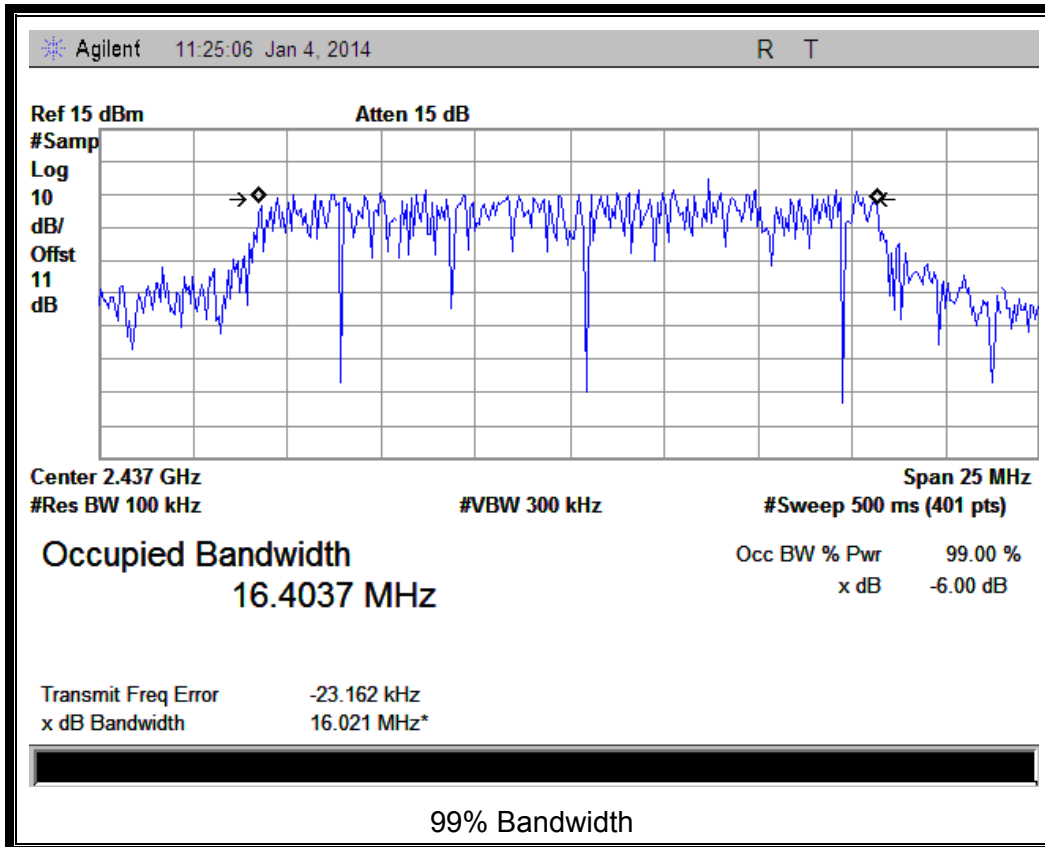

(Plot E: Channel 6: 2437MHz @ 802.11g)

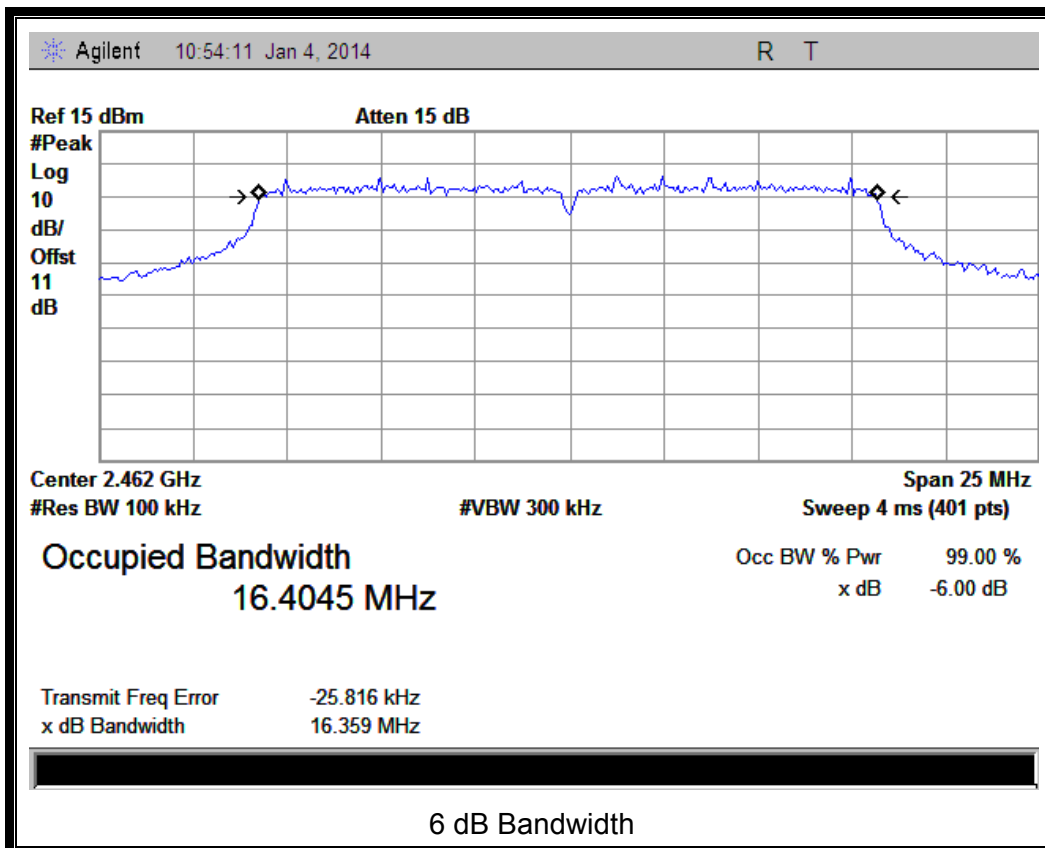

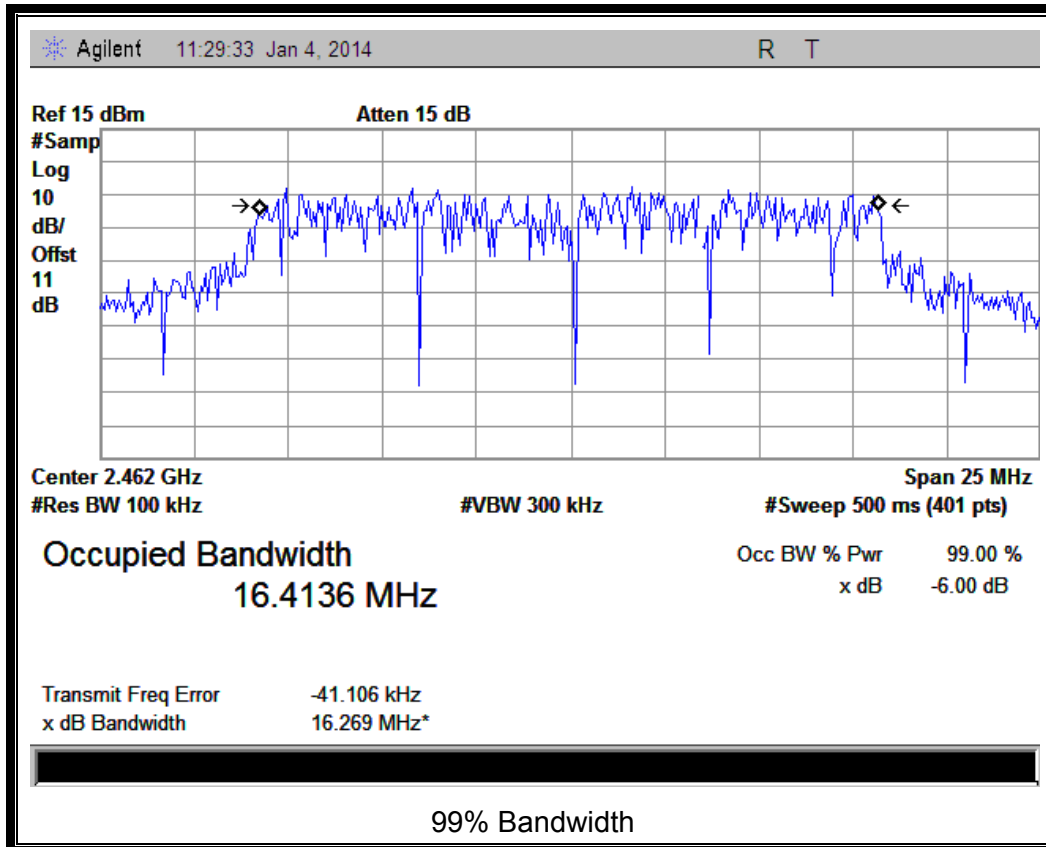

(Plot F: Channel 11: 2462MHz @ 802.11g)

3.3.3.3. 802.11n-20 Test mode

A. Test Verdict:

Channel	Frequency (MHz)	6 dB Bandwidth (MHz)	99% Bandwidth (MHz)	Refer to Plot	Limits(kHz)	Result
1	2412	17.533	17.500	Plot G	≥500	PASS
6	2437	17.548	17.622	Plot H	≥500	PASS
11	2462	17.543	17.637	Plot I	≥500	PASS

B. Test Plots:

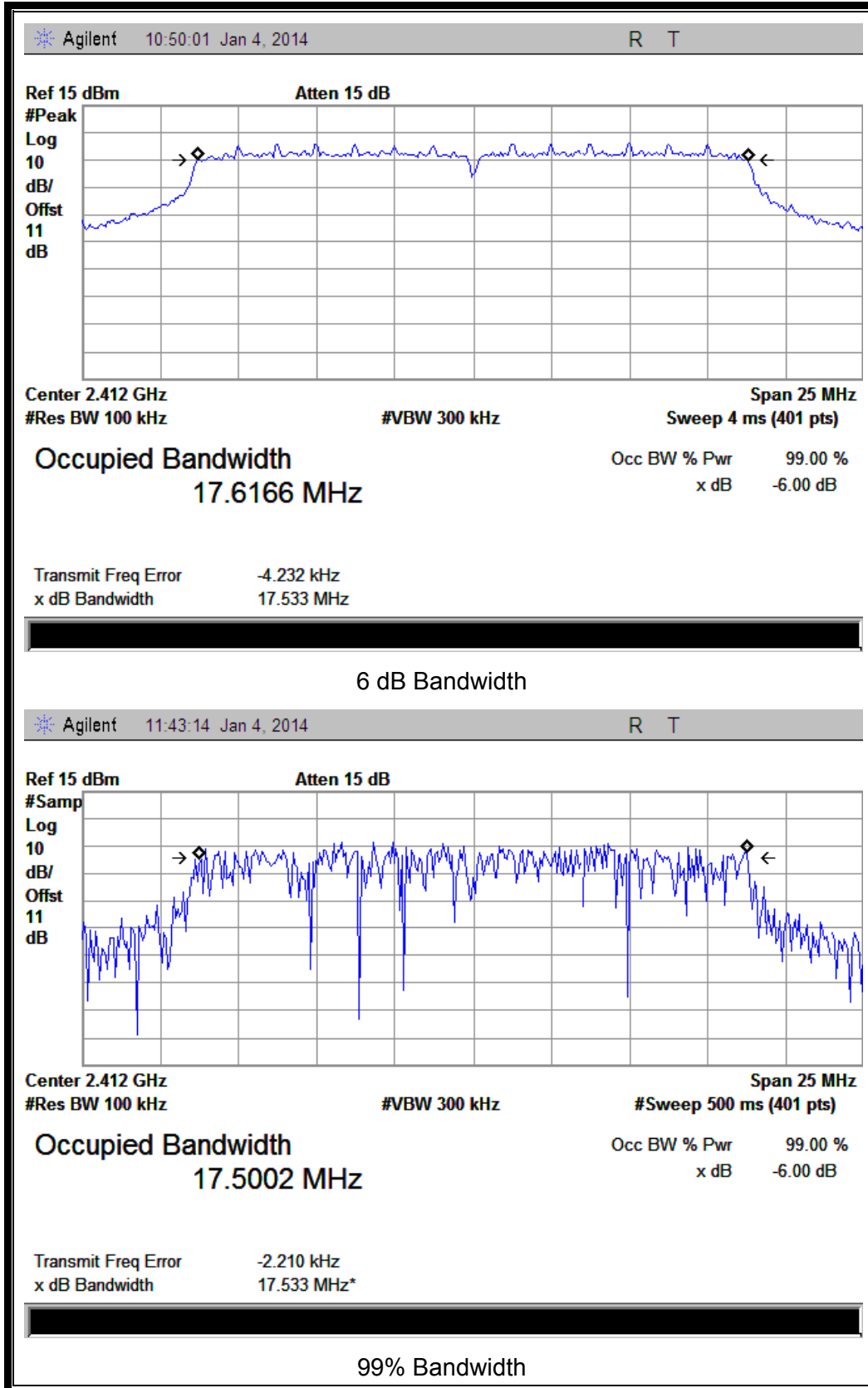

(Plot G: Channel 1: 2412MHz @ 802.11n-20)

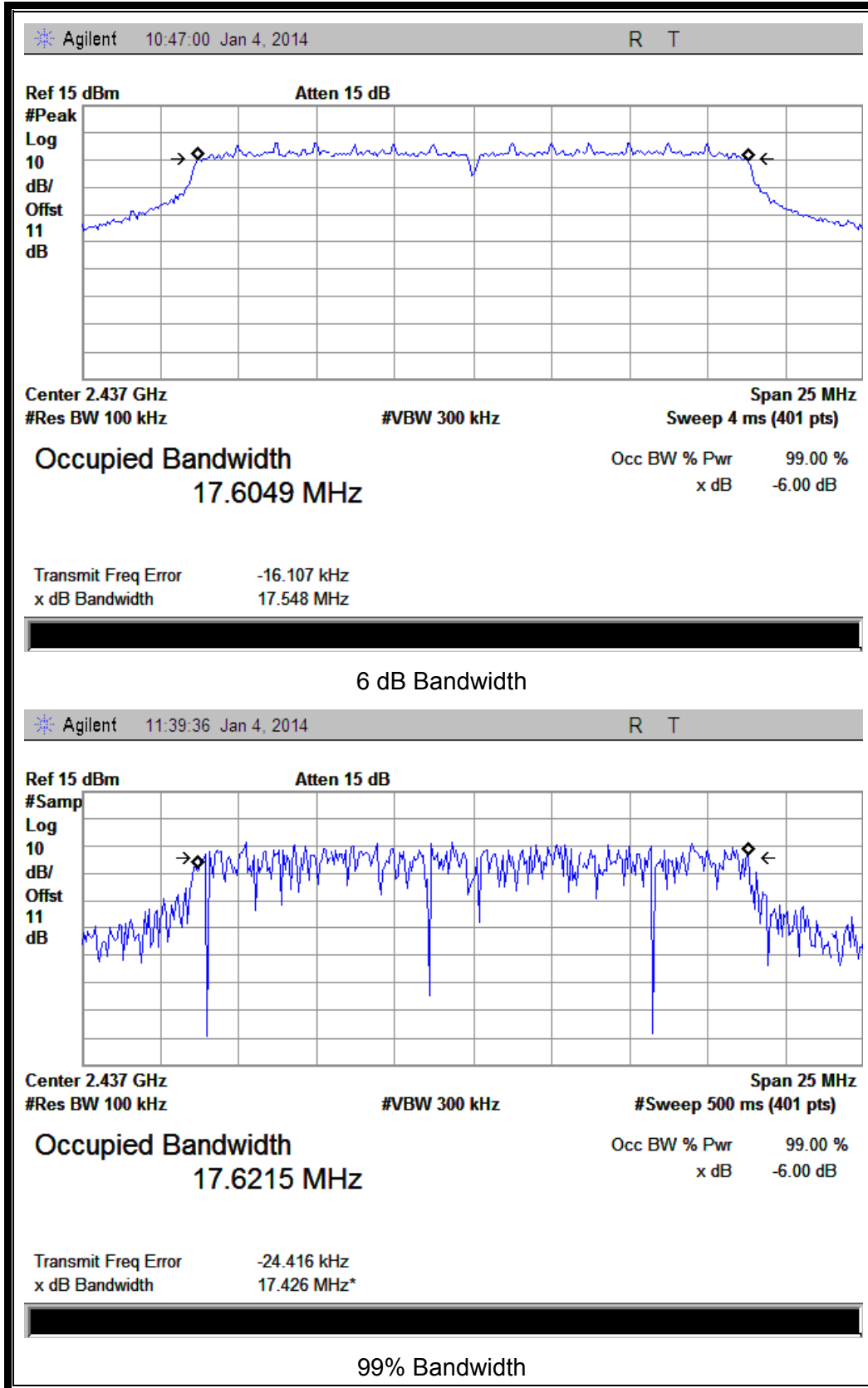

(Plot H: Channel 6: 2437MHz @ 802.11n-20)

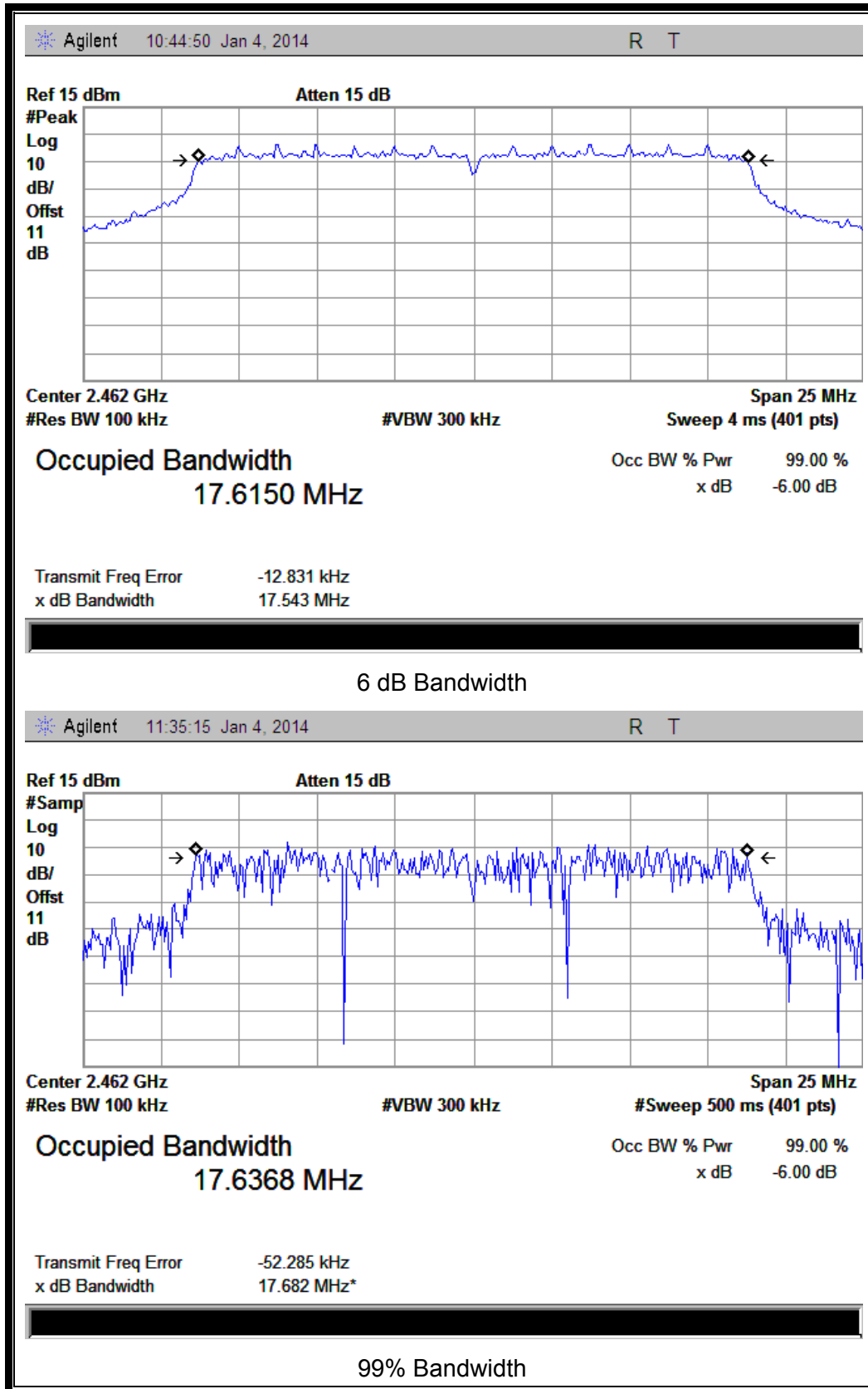

(Plot I: Channel 11: 2462MHz @ 802.11n-20)

3.4. Conducted Spurious Emissions and Band Edge

3.4.1. Requirement

In any 100kHz bandwidth outside the frequency band in which the spread spectrum or digitally modulated intentional radiator is operating, the radio frequency power that is produced by the intentional radiator shall be at least 20dB below that in the 100kHz bandwidth within the band that contains the highest level of the desired power, based on either an RF conducted or a radiated measurement.

3.4.2. Test Description

A. Test Set:

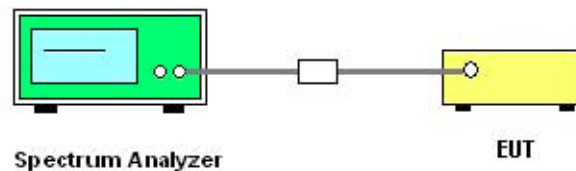

The EUT which is powered by the Battery, is coupled to the Spectrum Analyzer; the RF load attached to the EUT antenna terminal is 50Ohm; the path loss as the factor is calibrated to correct the reading.

Make the measurement with the spectrum analyzer's resolution bandwidth (RBW) = 100 kHz. In order to make an accurate measurement, set the span greater than RBW.

B. Equipments List:

Description	Manufacturer	Model	Serial No.	Cal. Date	Cal. Due
Receiver	Agilent	E7405A	US44210471	2013.05.13	2014.05.12

3.4.3. Test Result

The measurement frequency range is from 30MHz to the 10th harmonic of the fundamental frequency. The lowest, middle and highest channels are tested to verify the spurious emissions.

3.4.3.1. 802.11b Test mode

A. Test Verdict:

Channel	Frequency (MHz)	Measured Max. Out of Band Emission (dBm)	Refer to Plot	Limit (dBm)		Verdict
				Carrier Level	Calculated -20dBc Limit	
1	2412	-41.02	Plot A.1	3.255	-16.7	PASS
6	2437	-41.59	Plot B.1	3.298	-16.7	PASS
11	2462	-43.08	Plot C.1	3.339	-16.7	PASS

B. Test Plots:

Note: the power of the Module transmitting frequency should be ignored.

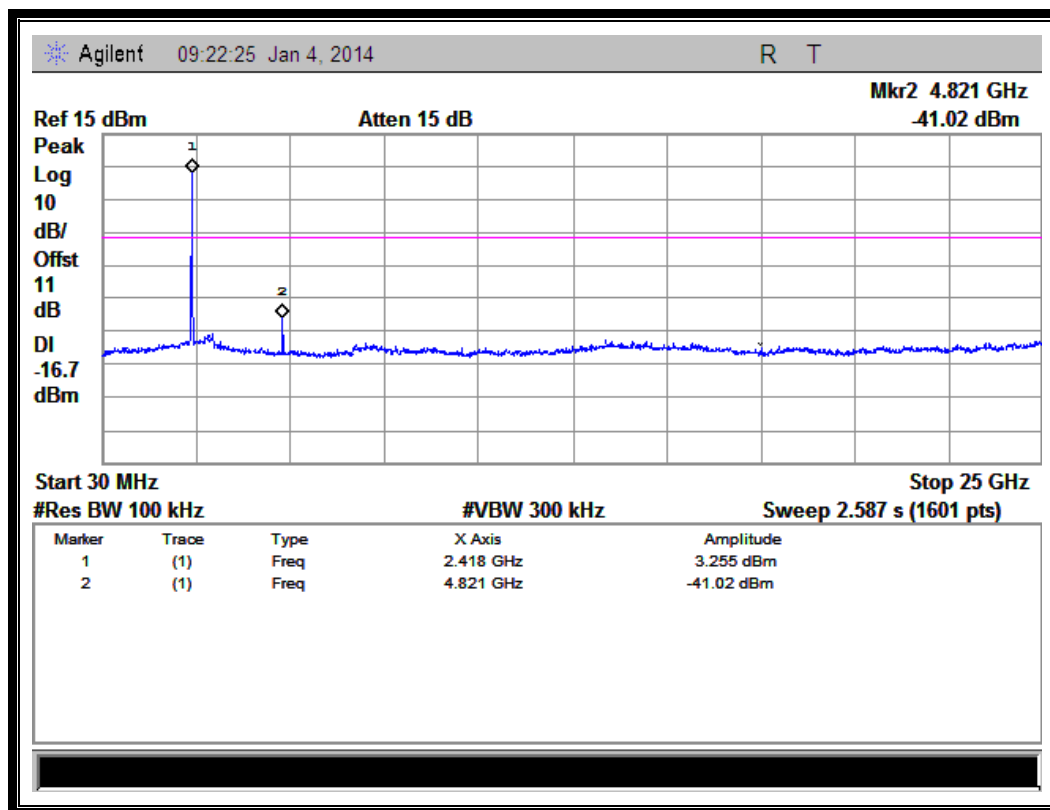

(Plot A.1: Channel = 1, 30MHz to 25GHz)

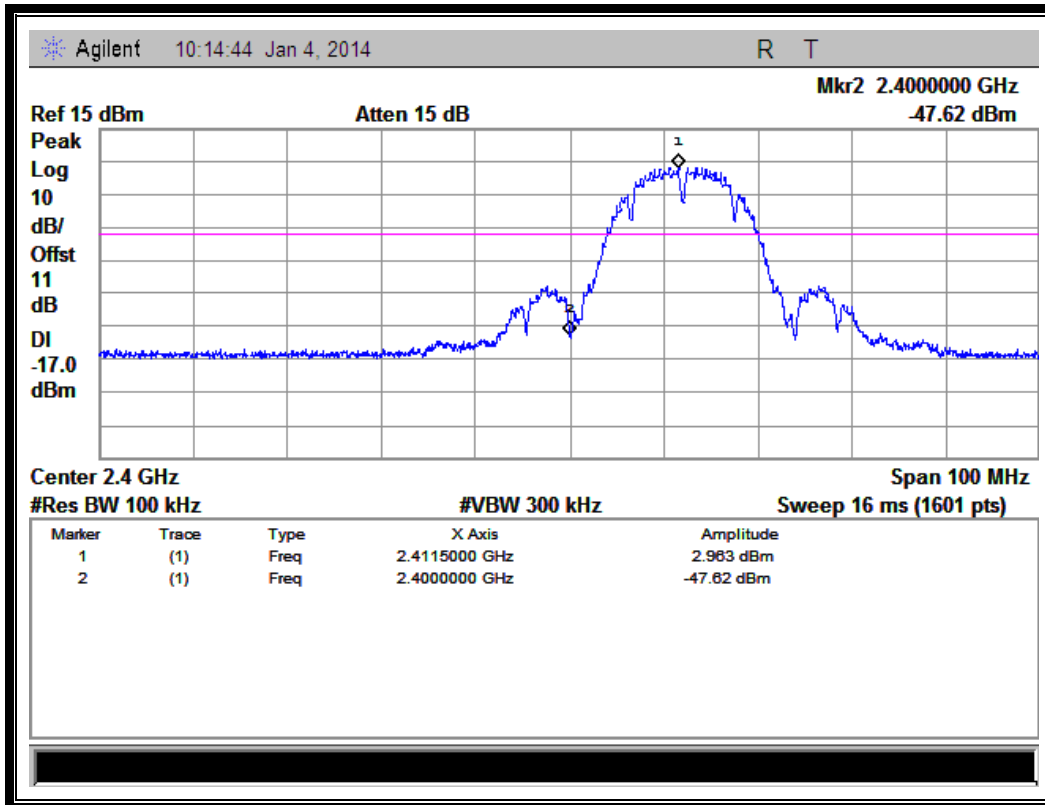

(Band Edge @ Channel = 1)

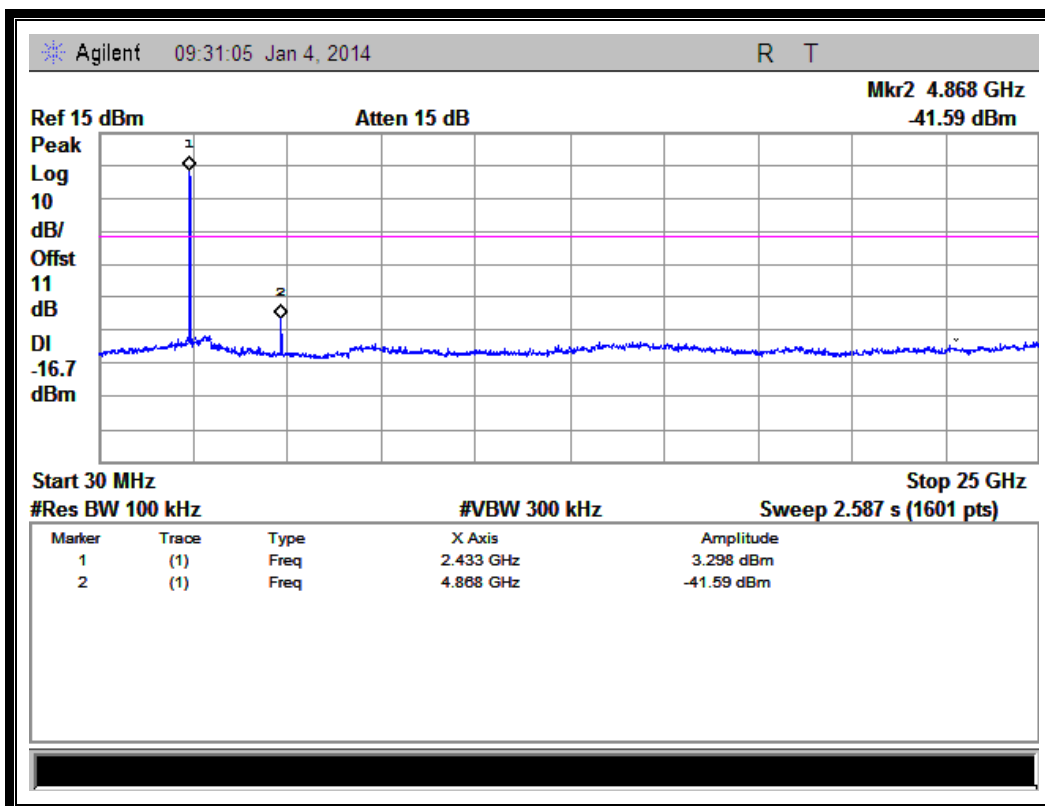

(Plot B.1: Channel = 6, 30MHz to 25GHz)

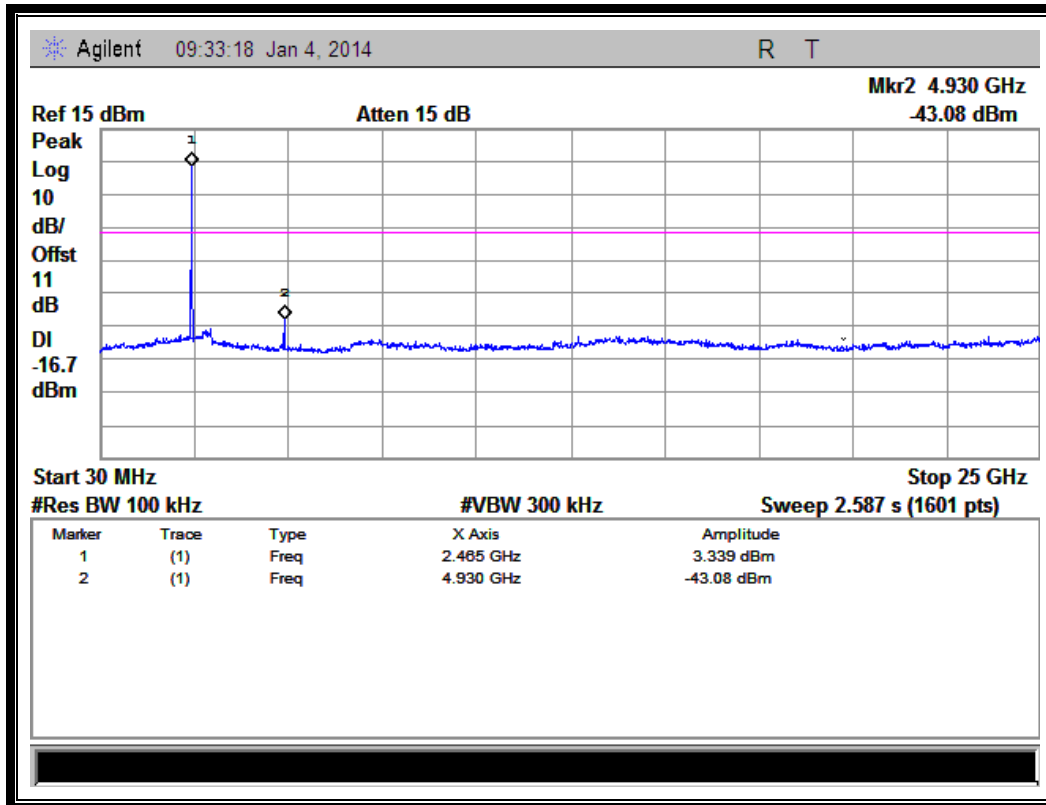

(Plot C.1: Channel = 11, 30MHz to 25GHz)

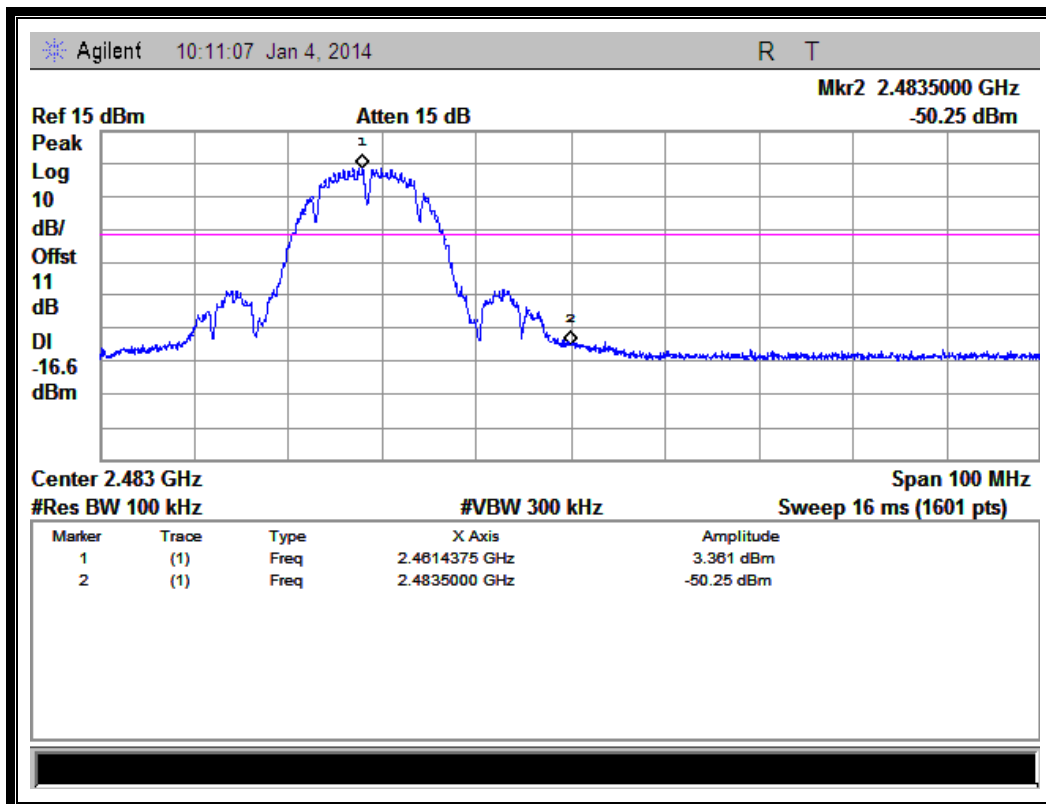

(Band Edge @ Channel = 11)

3.4.3.2. 802.11g Test mode

A. Test Verdict:

Channel	Frequency (MHz)	Measured Max. Out of Band Emission (dBm)	Refer to Plot	Limit (dBm)		Verdict
				Carrier Level	Calculated -20dBc Limit	
1	2412	-45.83	Plot D.1	-0.038	-20.0	PASS
6	2437	-45.22	Plot E.1	0.683	-19.3	PASS
11	2462	-45.00	Plot F.1	1.557	-18.4	PASS

B. Test Plots:

Note: the power of the Module transmitting frequency should be ignored.

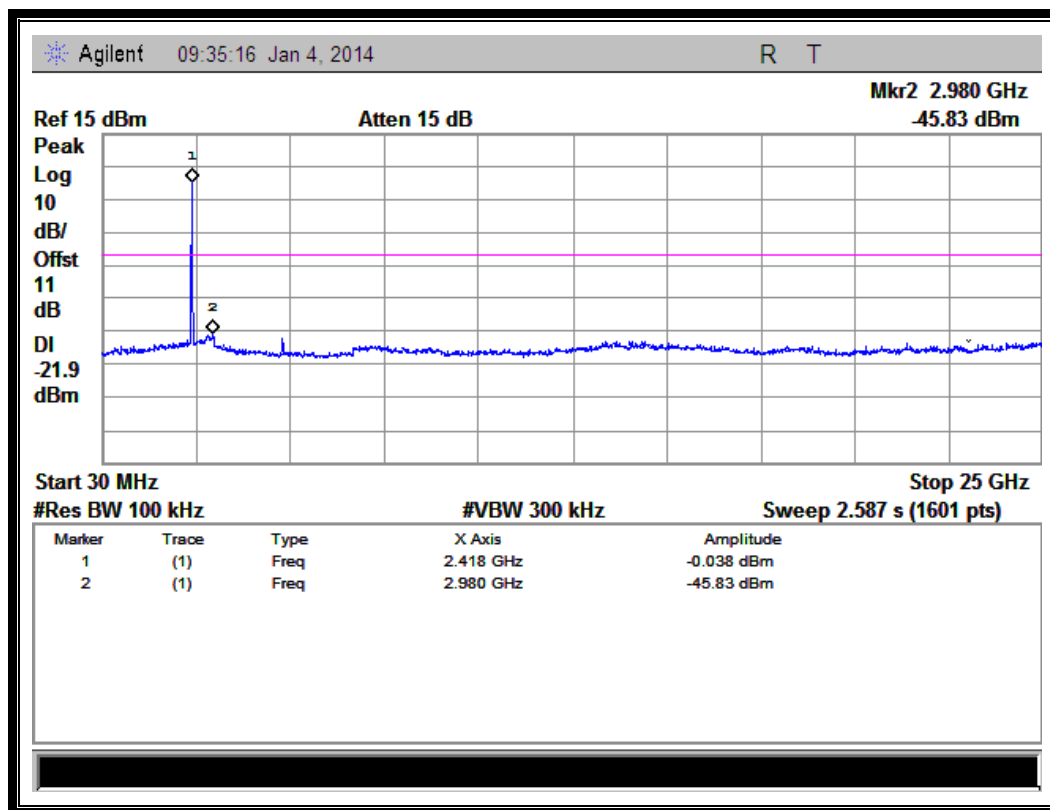

(Plot D.1: Channel = 1, 30MHz to 25GHz)

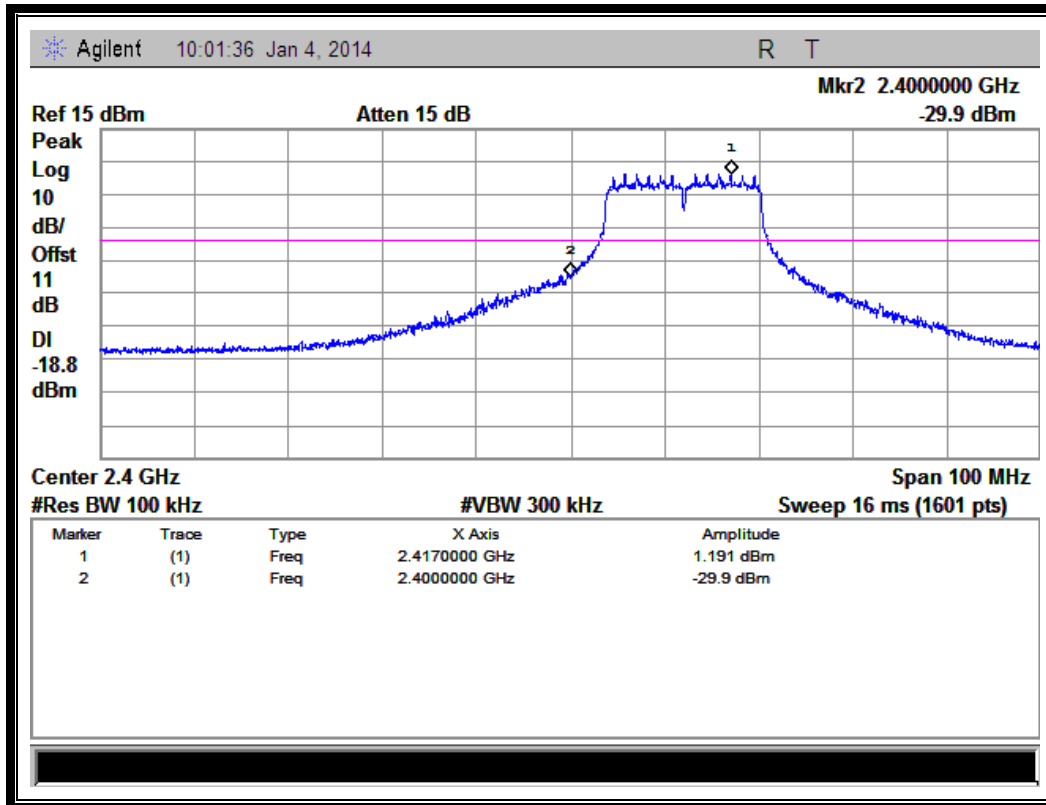

(Band Edge @ Channel = 1)

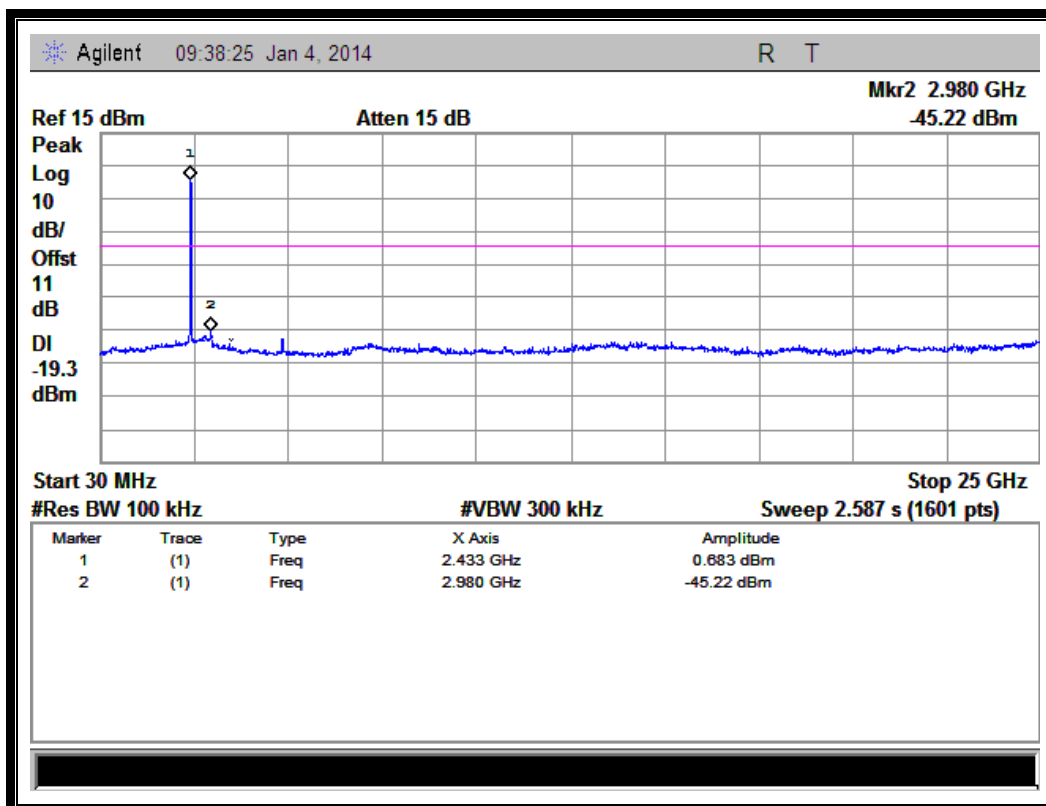

(Plot E.1: Channel = 6, 30MHz to 25GHz)

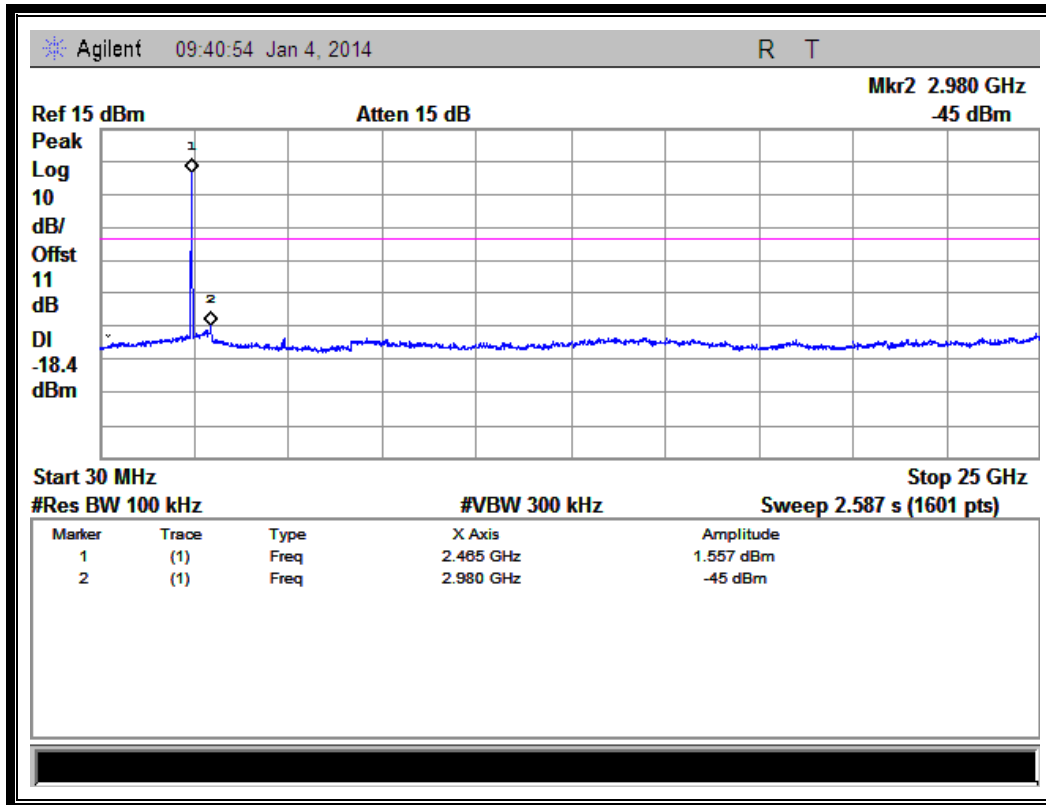

(Plot F.1: Channel = 11, 30MHz to 25GHz)

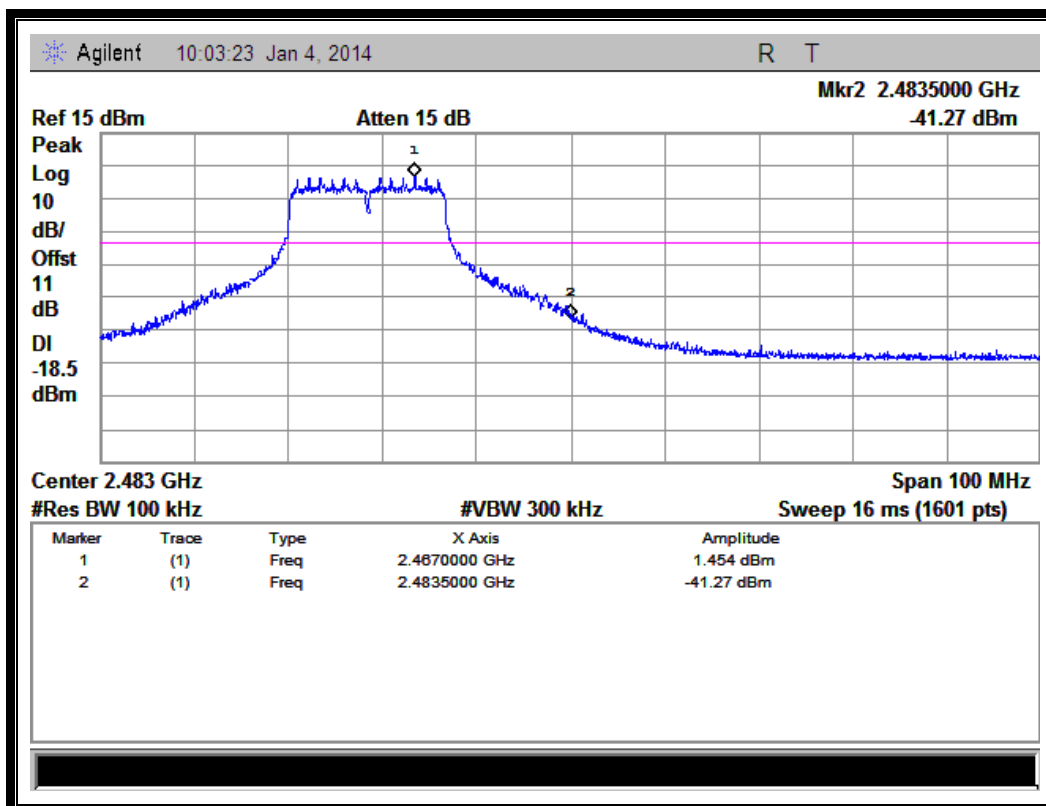

(Band Edge @ Channel = 11)

3.4.3.3. 802.11n -20MHz Test mode

A. Test Verdict:

Channel	Frequency (MHz)	Measured Max. Out of Band Emission (dBm)	Refer to Plot	Limit (dBm)		Verdict
				Carrier Level	Calculated -20dBc Limit	
1	2412	-45.79	Plot G.1	-0.278	-20.3	PASS
6	2437	-44.90	Plot H.1	1.241	-18.8	PASS
11	2462	-45.38	Plot I.1	1.676	-18.3	PASS

B. Test Plots:

Note: the power of the Module transmitting frequency should be ignored.

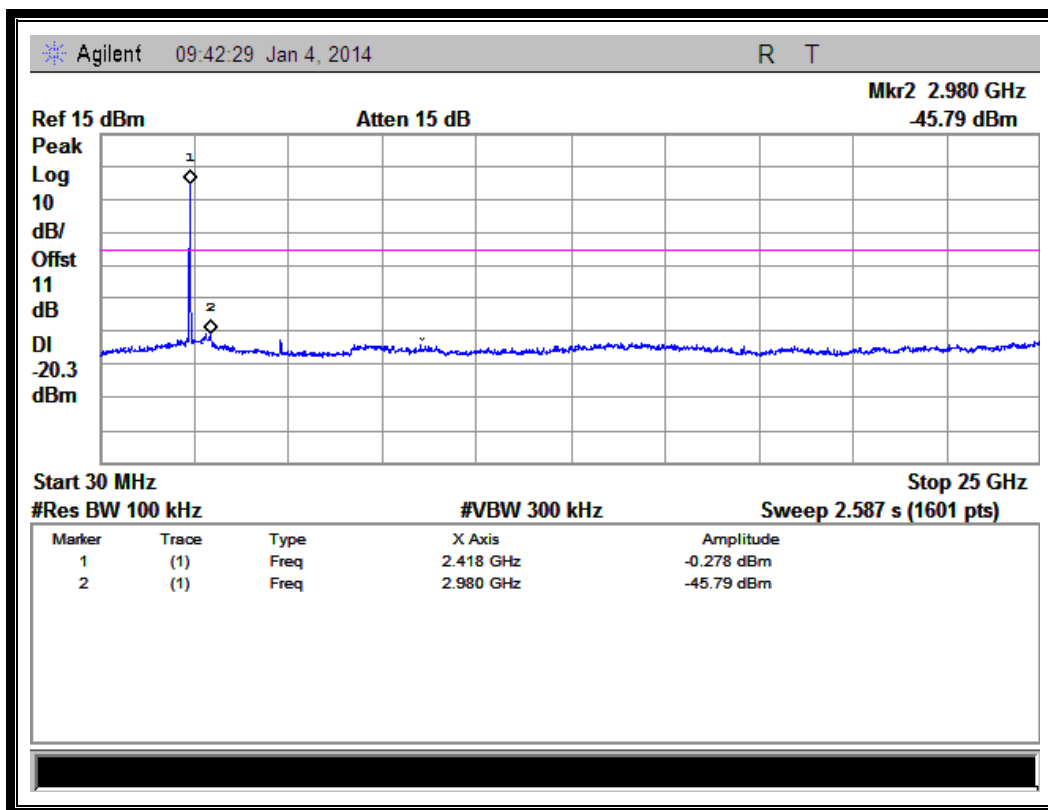

(Plot G.1: Channel = 1, 30MHz to 25GHz)

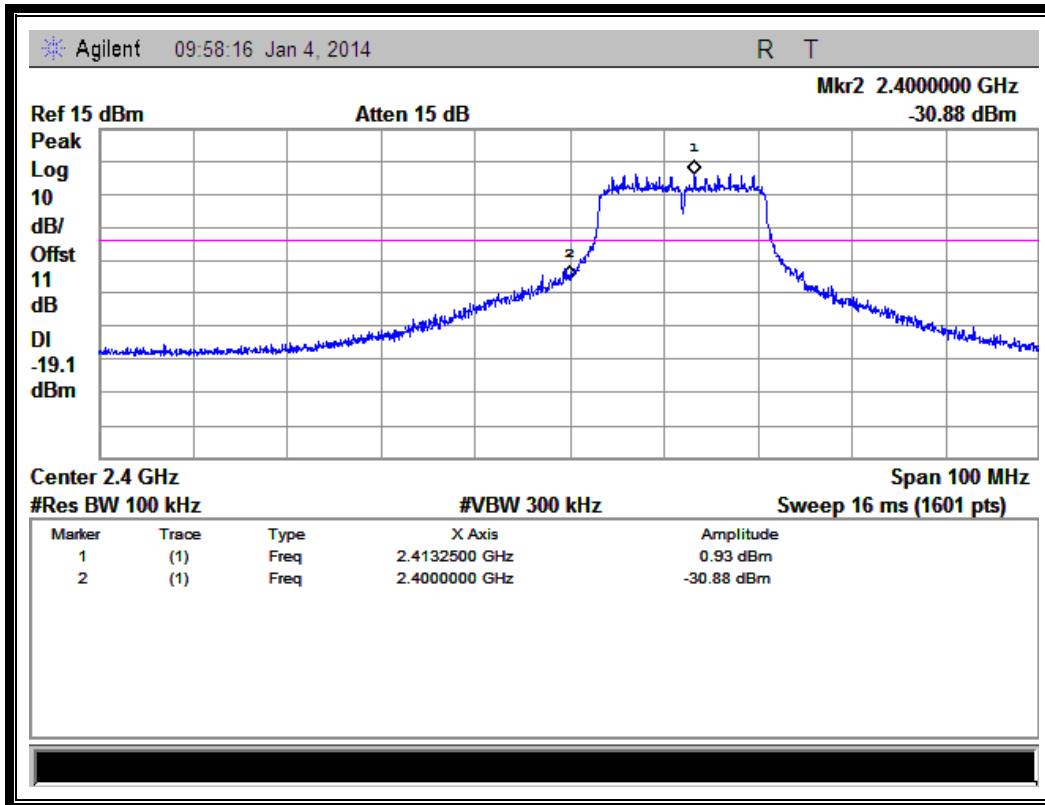

(Band Edge @ Channel = 1)

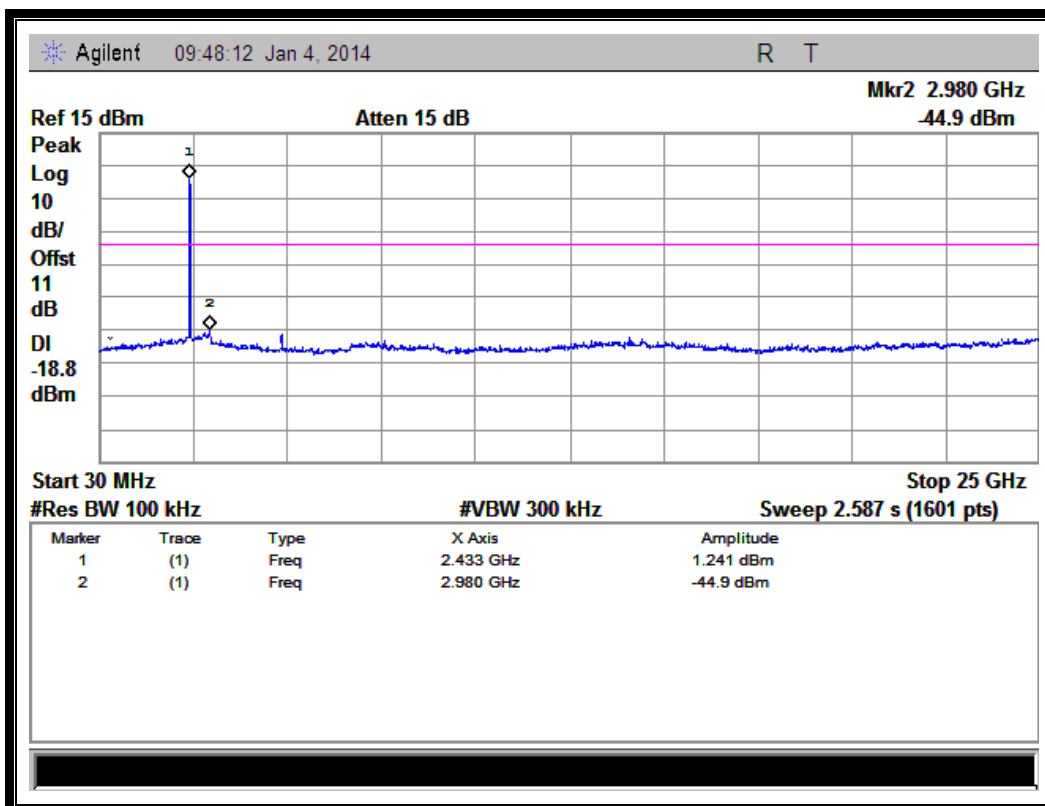

(Plot H.1: Channel = 6, 30MHz to 25GHz)

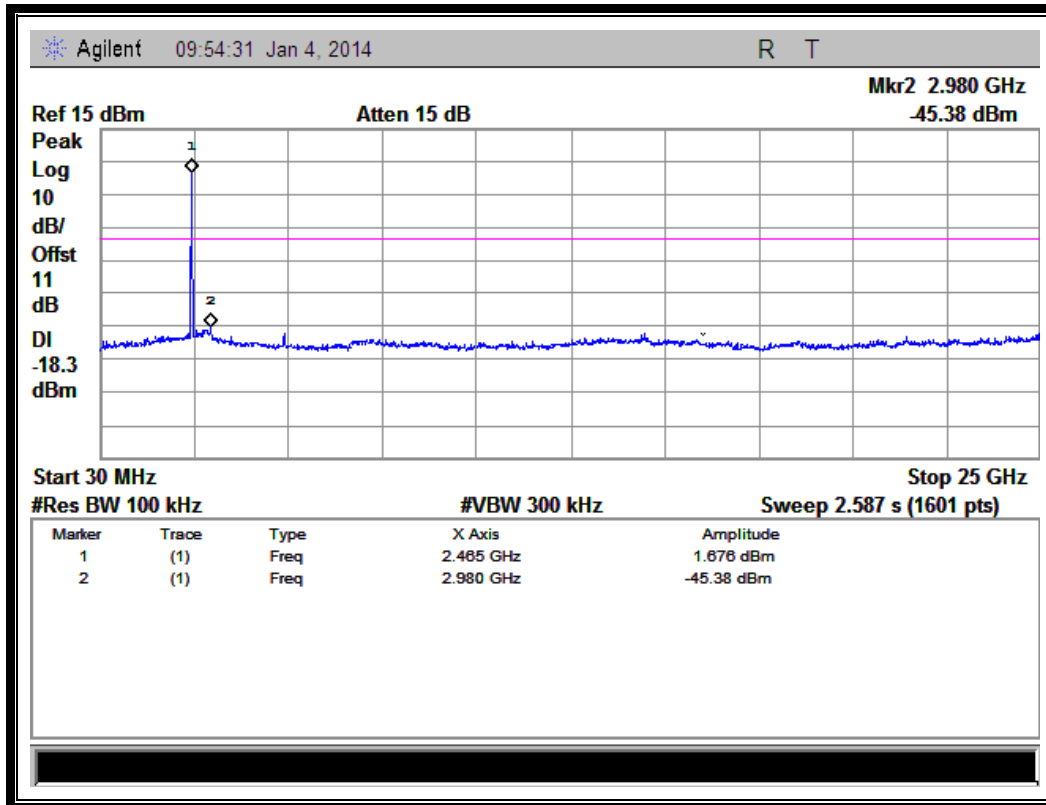

(Plot I.1: Channel = 11, 30MHz to 25GHz)

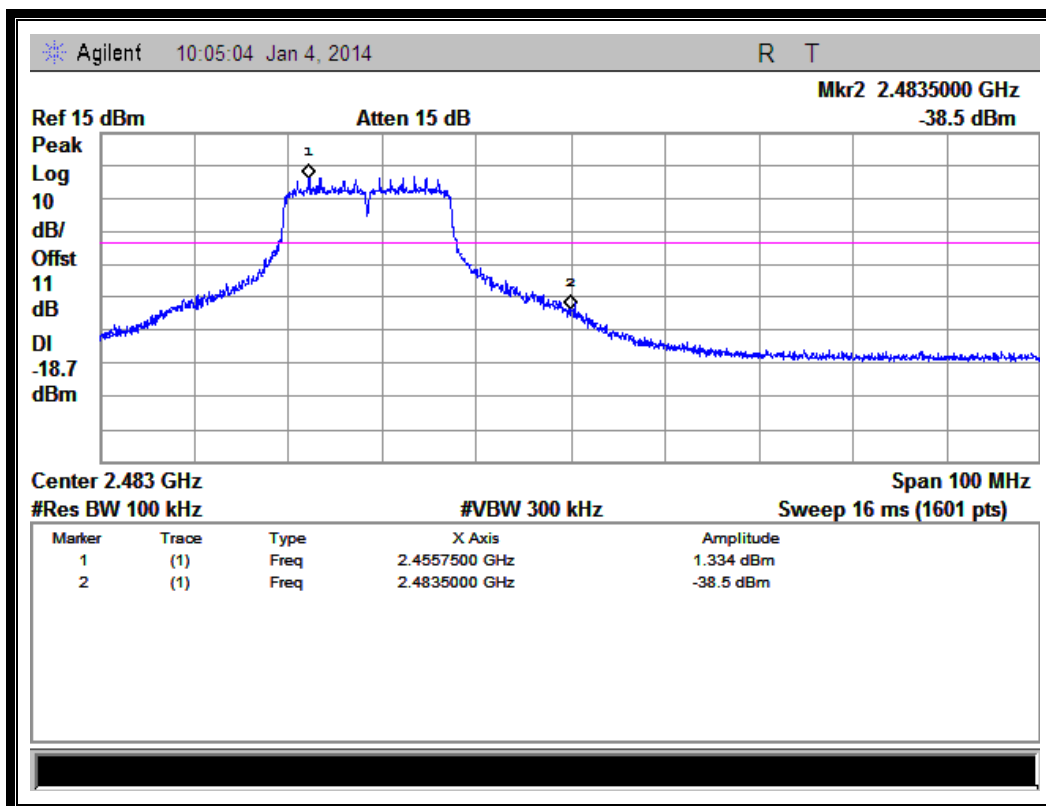

(Band Edge @ Channel = 11)

3.5. Power spectral density (PSD)

3.5.1. Requirement

For digitally modulated systems, the power spectral density conducted from the intentional radiator to the antenna shall not be greater than 8dBm in any 3 kHz band during any time interval of continuous transmission. This power spectral density shall be determined in accordance with the provisions of paragraph (b) of this section. The same method of determining the conducted output power shall be used to determine the power spectral density

3.5.2. Test Description

A. Test Set:

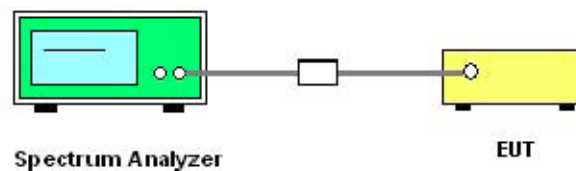

The EUT which is powered by the Battery, is coupled to the Spectrum Analyzer; the RF load attached to the EUT antenna terminal is 50Ohm; the path loss as the factor is calibrated to correct the reading.

B. Equipments List:

Description	Manufacturer	Model	Serial No.	Cal. Date	Cal. Due
Receiver	Agilent	E7405A	US44210471	2013.05.13	2014.05.12

3.5.3. Test Result

3.5.3.1. 802.11b Test mode

A. Test Verdict:

Spectral power density (dBm/3kHz)					
Channel	Frequency (MHz)	Measured PSD (dBm/3kHz)	Refer to Plot	Limit (dBm/3kHz)	Verdict
1	2412	-12.54	Plot A	8	PASS
6	2437	-13.12	Plot B	8	PASS
11	2462	-12.01	Plot C	8	PASS
Measurement uncertainty: ± 1.3 dB					

B. Test Plots:

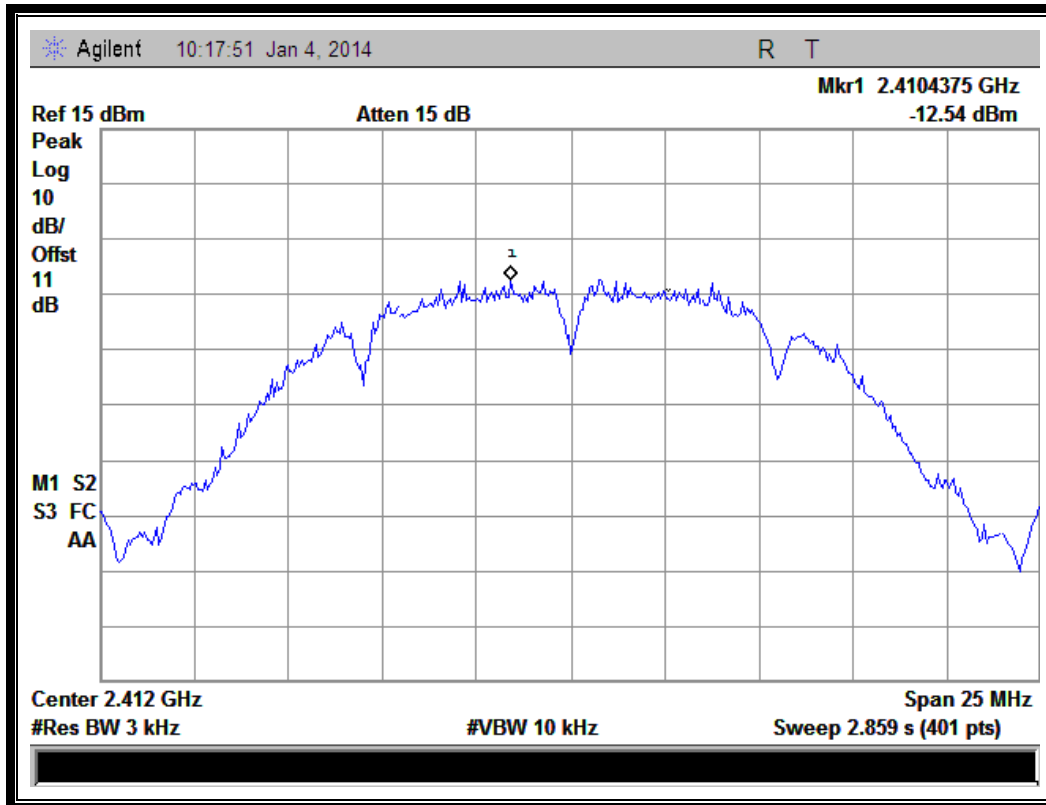

(Plot A: Channel = 1 @ 802.11b)

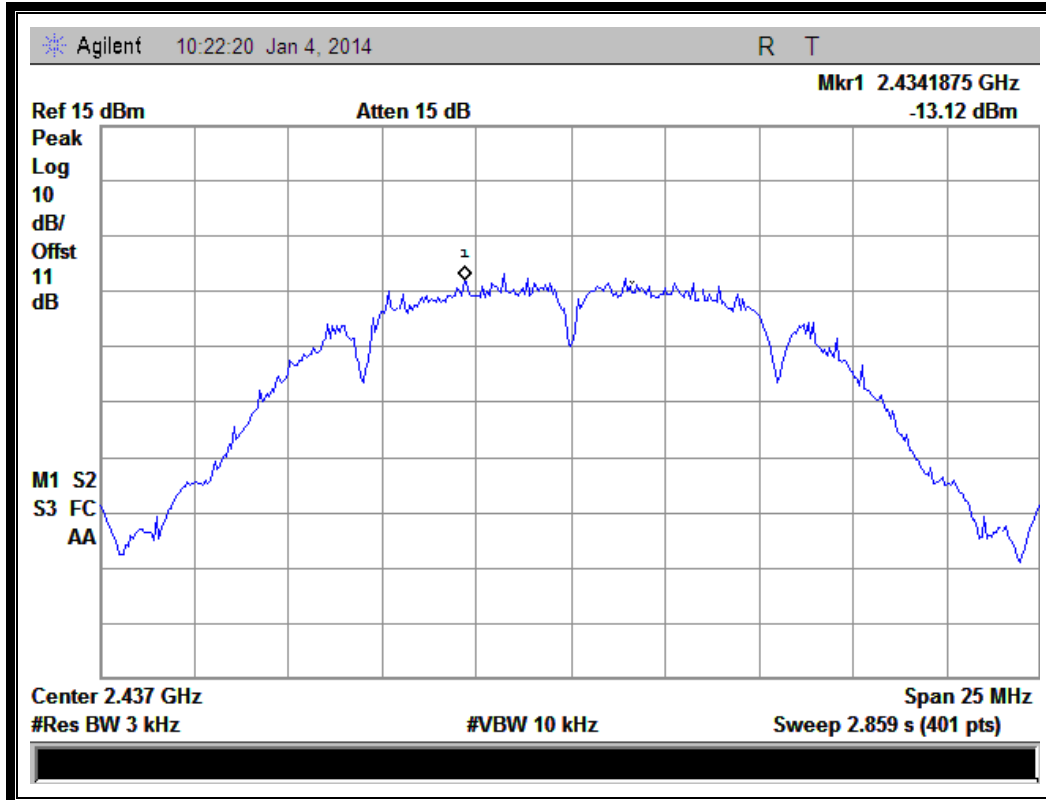

(Plot B: Channel = 6 @ 802.11b)

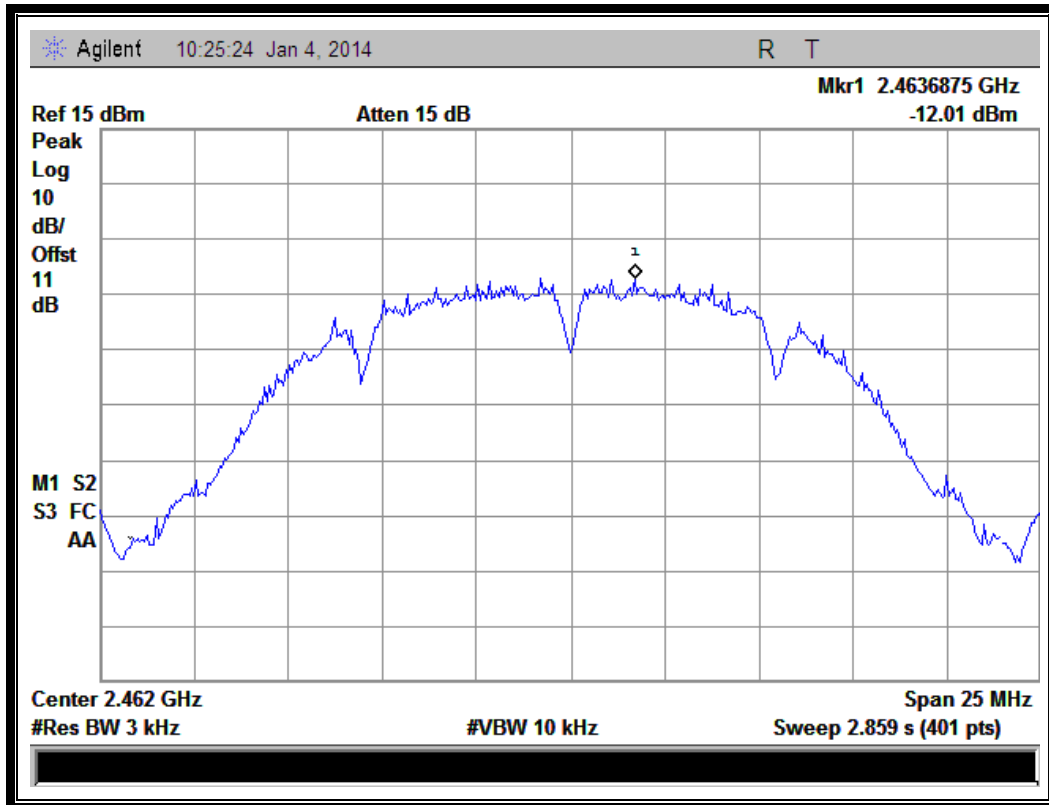

(Plot C: Channel = 11 @ 802.11b)

3.5.3.2. 802.11g Test mode

A. Test Verdict:

Spectral power density (dBm/3kHz)					
Channel	Frequency (MHz)	Measured PSD (dBm/3kHz)	Refer to Plot	Limit (dBm/3kHz)	Verdict
1	2412	-12.92	Plot A	8	PASS
6	2437	-12.85	Plot B	8	PASS
11	2462	-12.56	Plot C	8	PASS
Measurement uncertainty: ± 1.3 dB					

B. Test Plots:

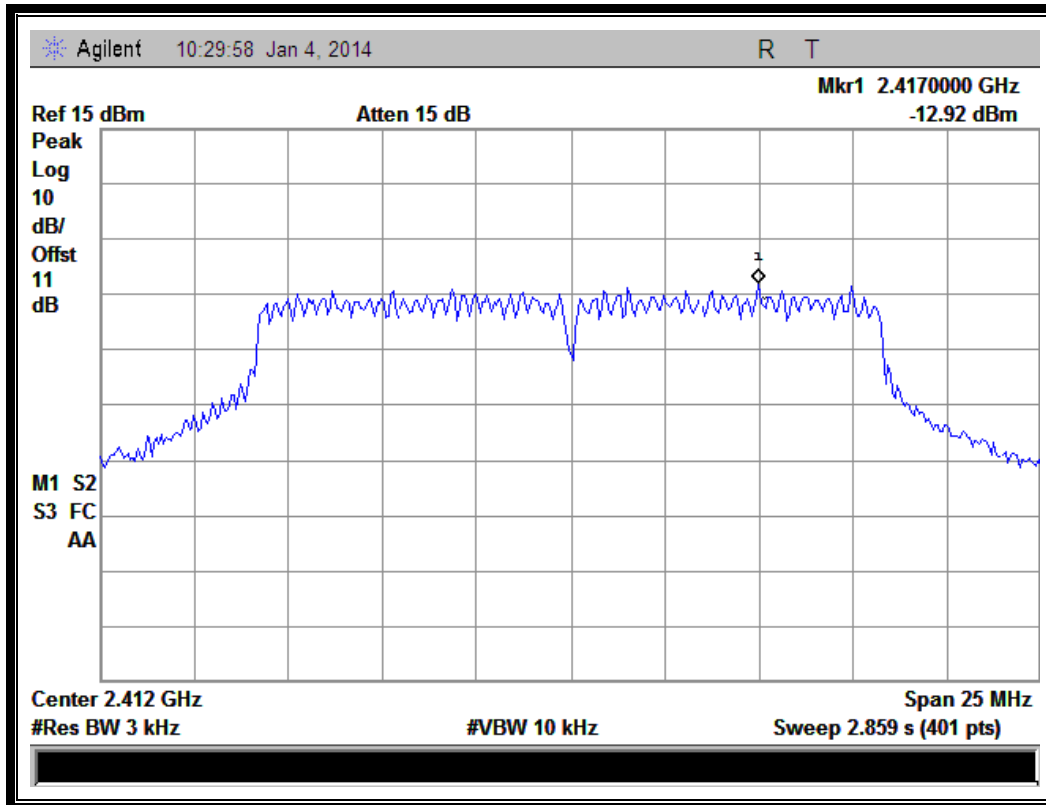

(Plot D: Channel = 1 @ 802.11g)

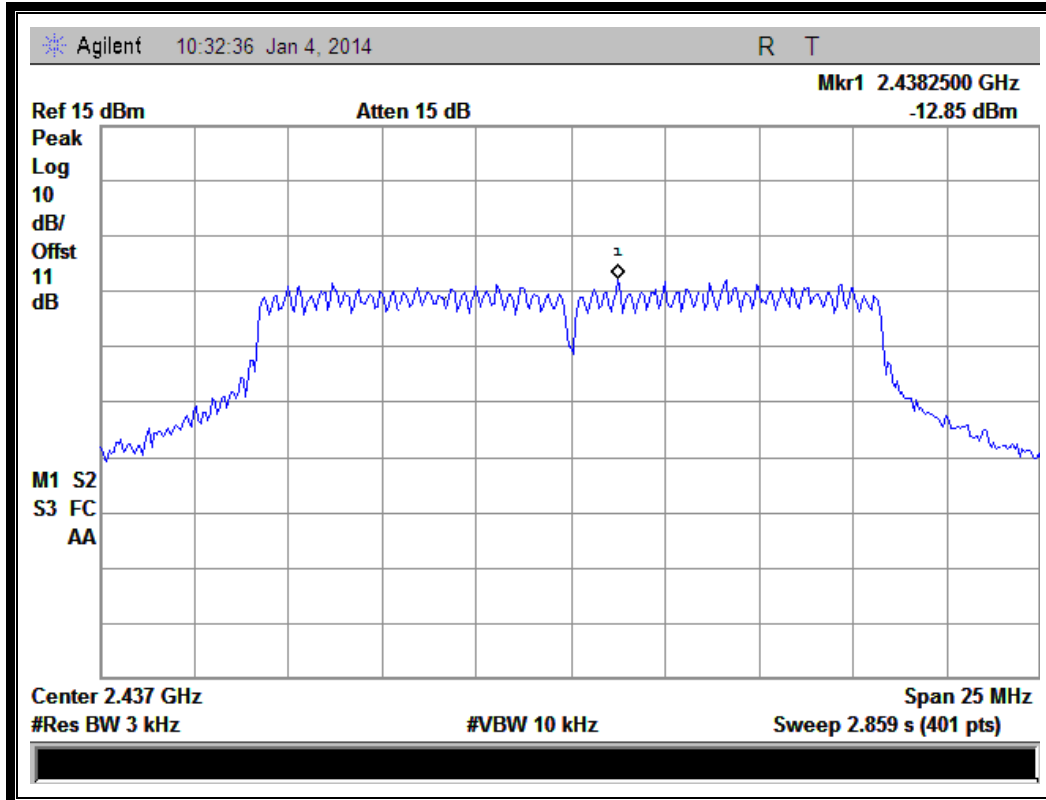

(Plot E: Channel = 6 @ 802.11g)

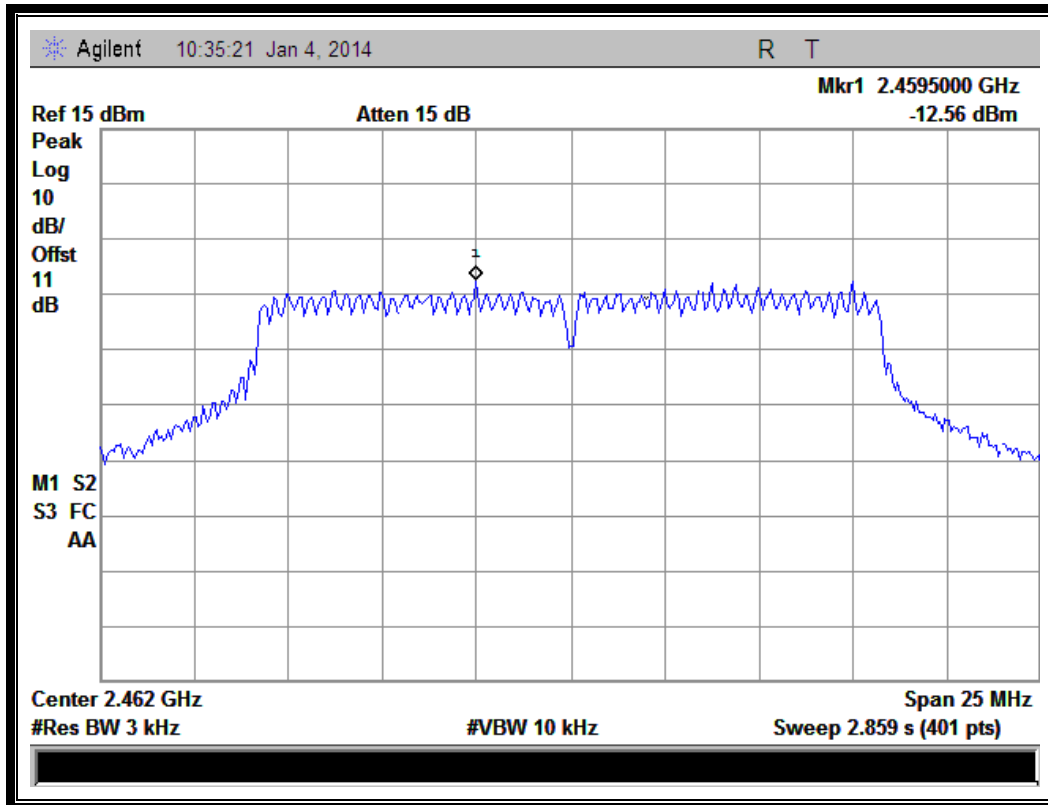

(Plot F: Channel = 11 @ 802.11g)

3.5.3.3. 802.11n-20MHz Test mode

A. Test Verdict:

Spectral power density (dBm/3kHz)					
Channel	Frequency (MHz)	Measured PSD (dBm/3kHz)	Refer to Plot	Limit (dBm/3kHz)	Verdict
1	2412	-12.85	Plot A	8	PASS
6	2437	-12.45	Plot B	8	PASS
11	2462	12.62	Plot C	8	PASS
Measurement uncertainty: ± 1.3 dB					

B. Test Plots:

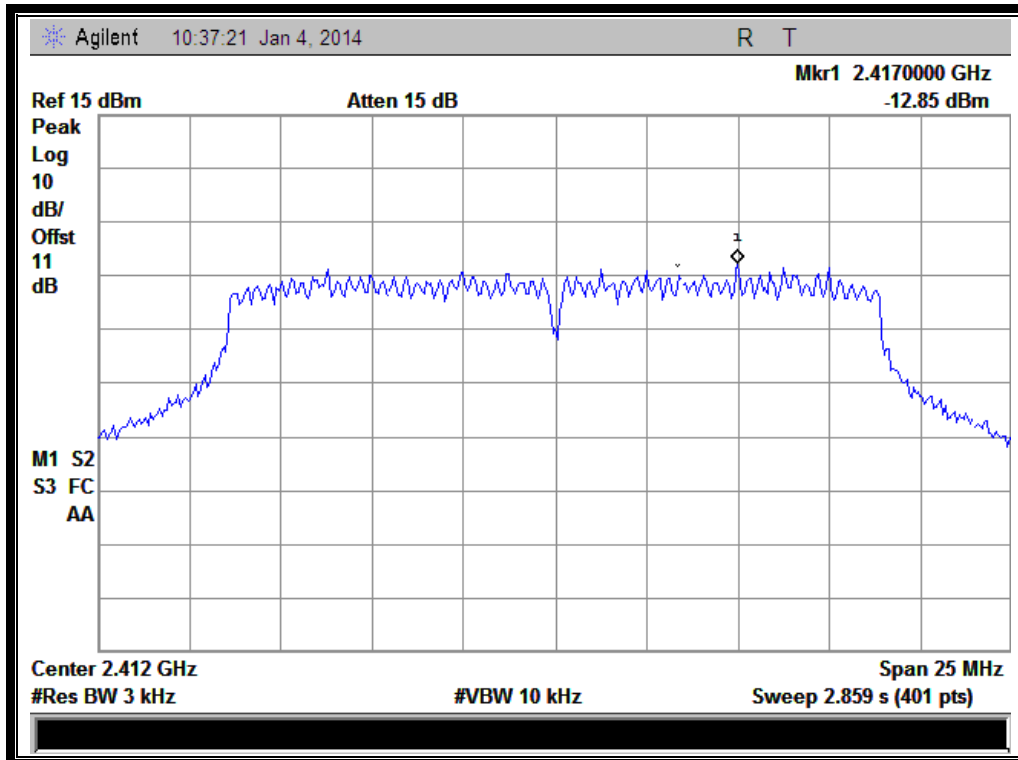

(Plot G: Channel = 1 @ 802.11n-20MHz)

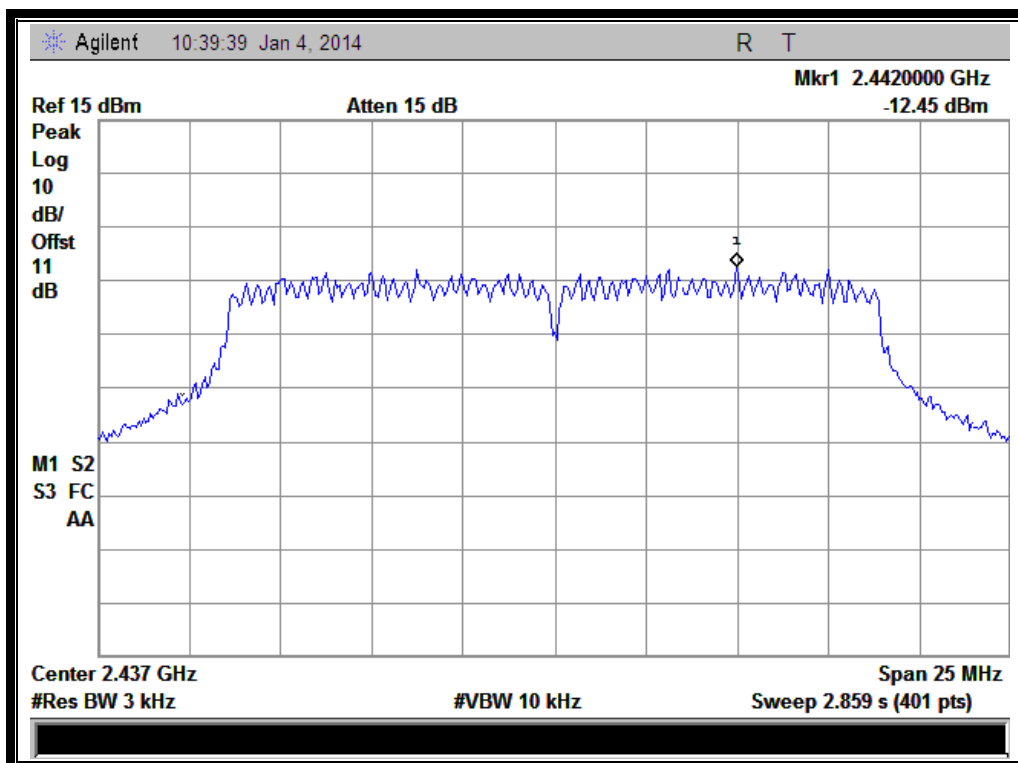

(Plot H: Channel = 6 @ 802.11n-20MHz)

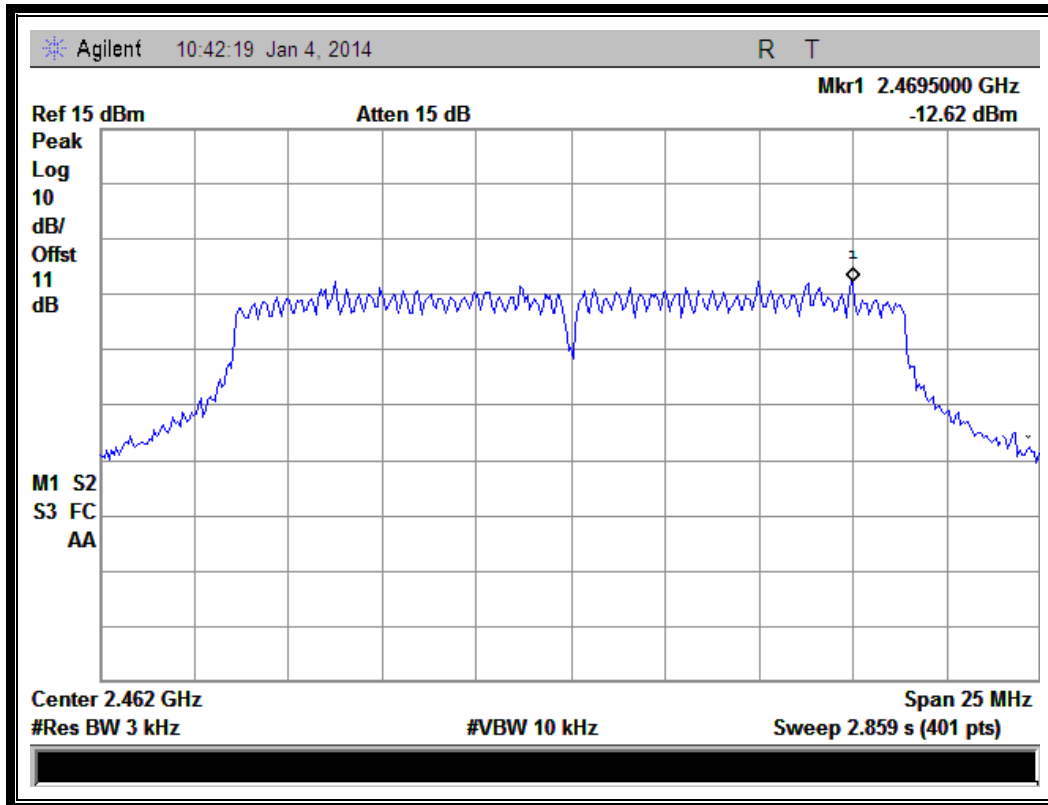

(Plot I: Channel = 11 @ 802.11n-20MHz)

3.6. Restricted Frequency Bands

3.6.1. Requirement

In any 100kHz bandwidth outside the frequency band in which the spread spectrum or digitally modulated intentional radiator is operating, the radio frequency power that is produced by the intentional radiator shall be at least 20dB below that in the 100kHz bandwidth within the band that contains the highest level of the desired power, In addition, radiated emissions which fall in the restricted bands, as defined in 15.205(a), must also comply with the radiated emission limits specified in 15.209(a).

3.6.2. Test Description

A. Test Setup

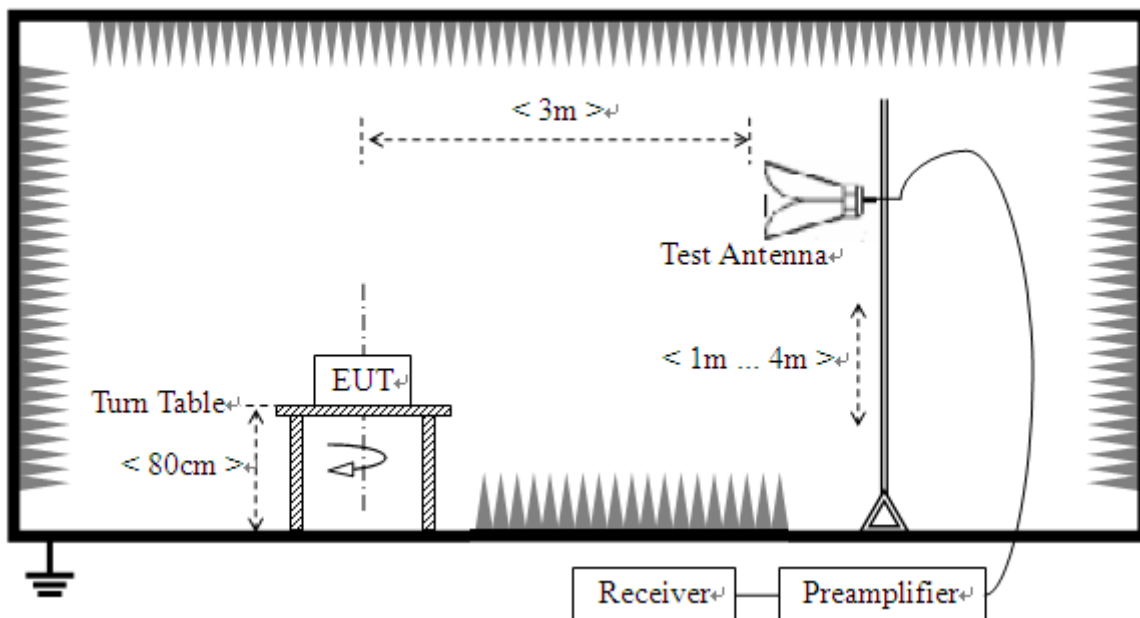

The Module is located in a 3m Semi-Anechoic Chamber; the antenna factors, cable loss and so on of the site as factors are calculated to correct the reading.

For the Test Antenna:

Test Antenna is 3m away from the EUT. Test Antenna height is varied from 1m to 4m above the ground to determine the maximum value of the field strength.

B. Equipments List:

Description	Manufacturer	Model	Serial No.	Cal. Date	Cal. Due
Receiver	Agilent	E7405A	US44210471	2013.05.13	2014.05.12
Full-Anechoic Chamber	Albatross	9m*6m*6m	(n.a.)	2013.05.13	2014.05.12
Test Antenna - Horn	Schwarzbeck	BBHA 9120D	9120D-963	2013.05.13	2014.05.12

3.6.3. Test Result

The lowest and highest channels are tested to verify Restricted Frequency Bands.

The measurement results are obtained as below:

$$E \text{ [dB}\mu\text{V/m]} = U_R + A_T + A_{\text{Factor}} \text{ [dB]}; A_T = L_{\text{Cable loss}} \text{ [dB]} - G_{\text{preamp}} \text{ [dB]}$$

A_T : Total correction Factor except Antenna

U_R : Receiver Reading

G_{preamp} : Preamplifier Gain

A_{Factor} : Antenna Factor at 3m

Note: Restricted Frequency Bands were performed when antenna was at vertical and horizontal polarity, and only the worse test condition (vertical) was recorded in this test report.

3.6.3.1. 802.11b Test mode

The lowest and highest channels are tested to verify the band edge emissions.

A. Test Verdict:

Channel	Frequency (MHz)	Detector	Receiver Reading UR (dBuV)	AT (dB)	AFactor (dB@3m)	Max. Emission E (dBμV/m)	Limit (dBμV/m)	Verdict
		PK/ AV						
1	2397.16	PK	52.95	-30.93	32.56	54.58	74	Pass
1	2397.72	AV	39.95	-30.93	32.56	41.58	54	Pass
11	2491.94	PK	54.45	-29.05	32.50	57.90	74	Pass
11	2485.37	AV	41.89	-29.05	32.50	45.34	54	Pass

B. Test Plots:

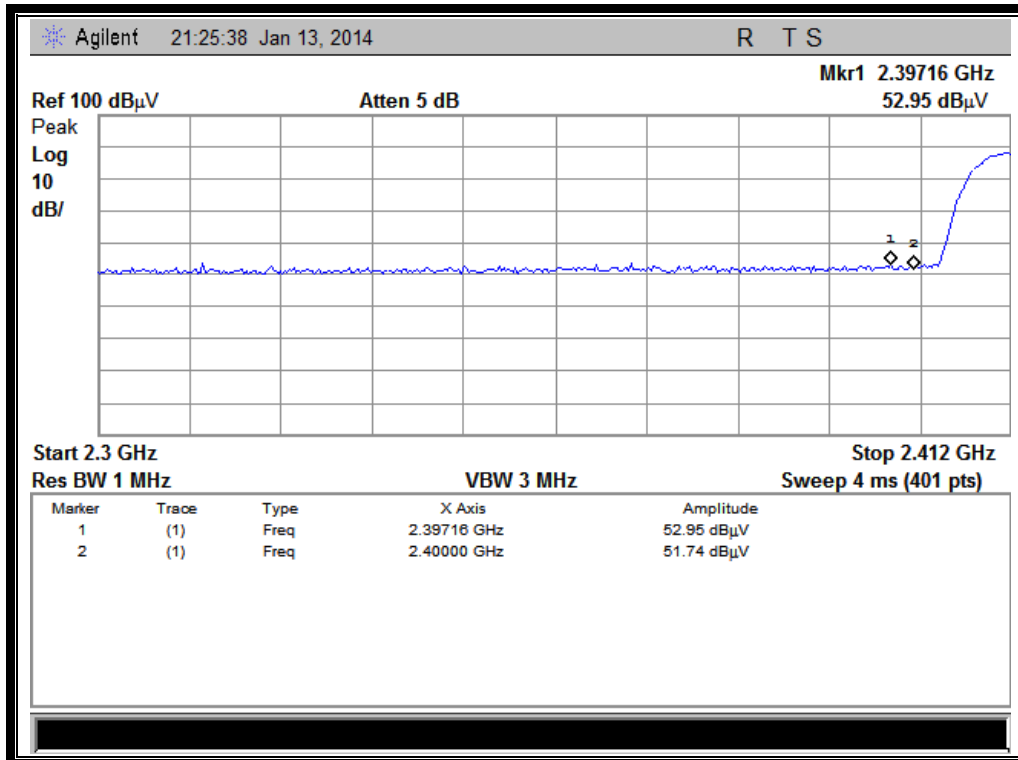

(Plot A1: Channel = 1 PEAK @ 802.11b)

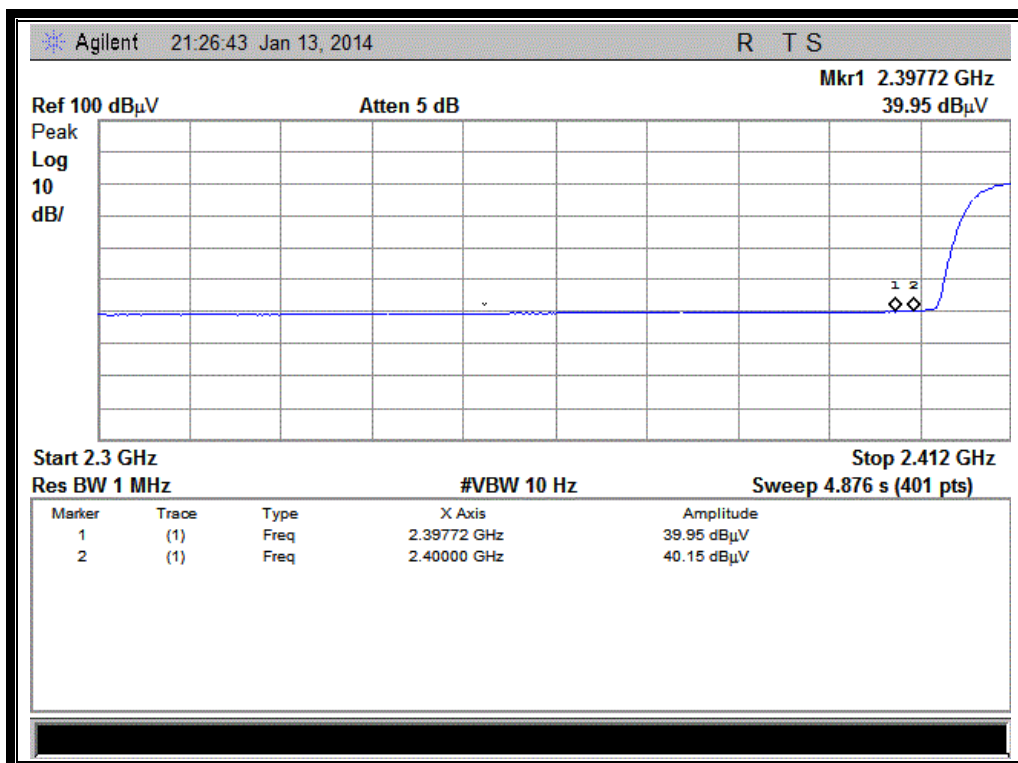

(Plot A2: Channel = 1 AVG @ 802.11b)

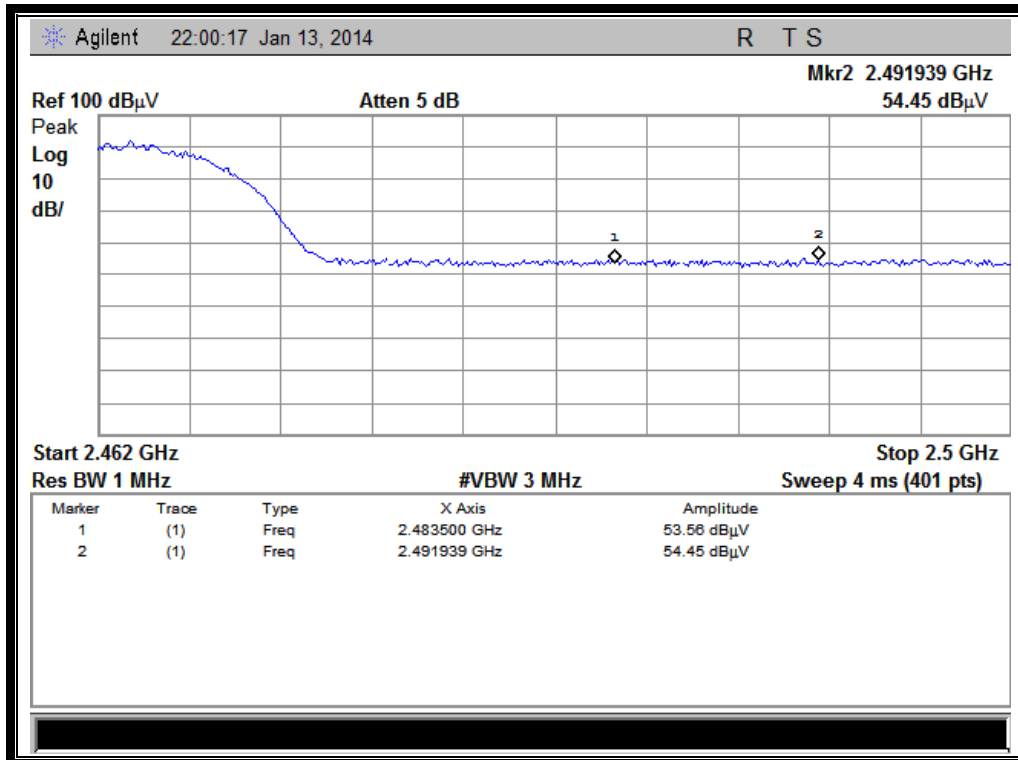

(Plot B1: Channel = 11 PEAK @ 802.11b)

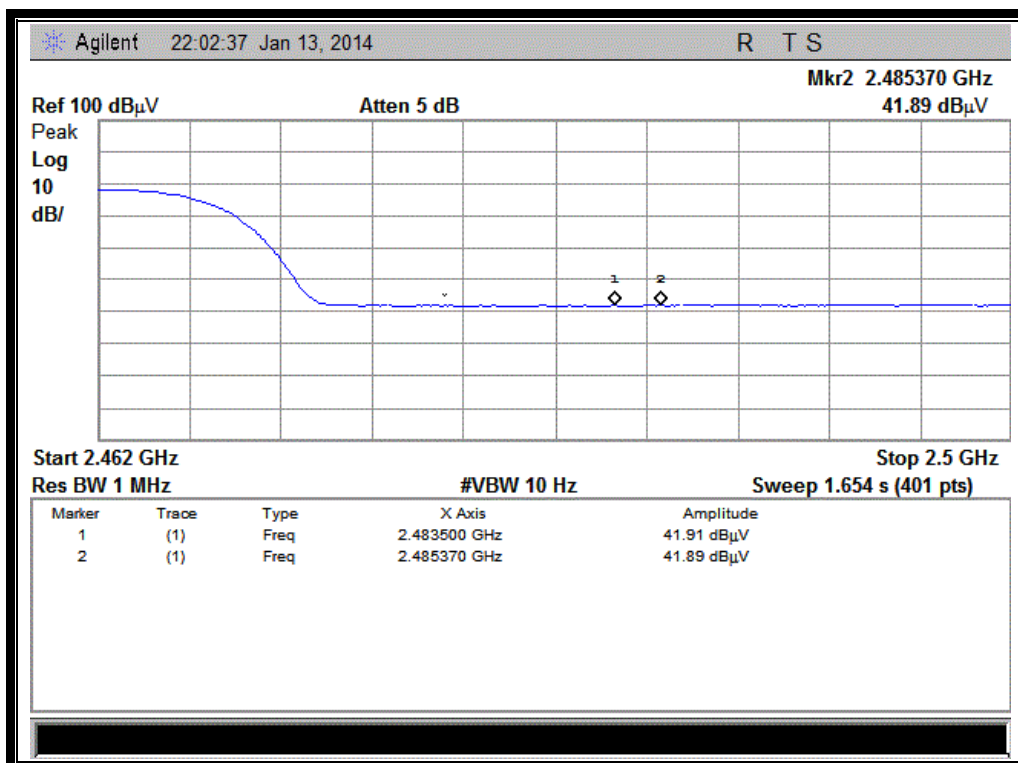

(Plot B2: Channel = 11 AVG @ 802.11b)

3.6.3.2. 802.11g Test mode

The lowest and highest channels are tested to verify the band edge emissions.

A. Test Verdict:

Channel	Frequency (MHz)	Detector	Receiver Reading UR (dBuV)	AT (dB)	AFactor (dB@3m)	Max. Emission E (dBμV/m)	Limit (dBμV/m)	Verdict
		PK/ AV						
1	2392.68	PK	52.75	-30.93	32.56	54.38	74	Pass
1	2397.72	AV	40.48	-30.93	32.56	42.11	54	Pass
11	2489.28	PK	55.01	-29.05	32.50	58.46	74	Pass
11	2483.50	AV	42.18	-29.05	32.50	45.63	54	Pass

B. Test Plots:

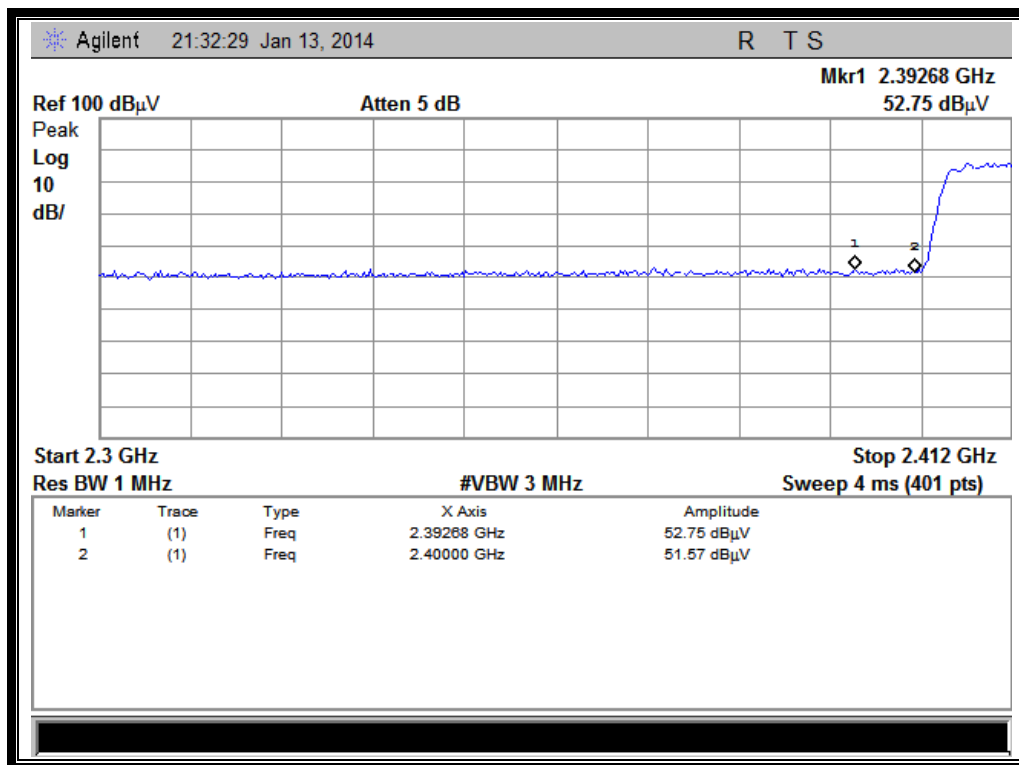

(Plot C1: Channel = 1 PEAK @ 802.11g)

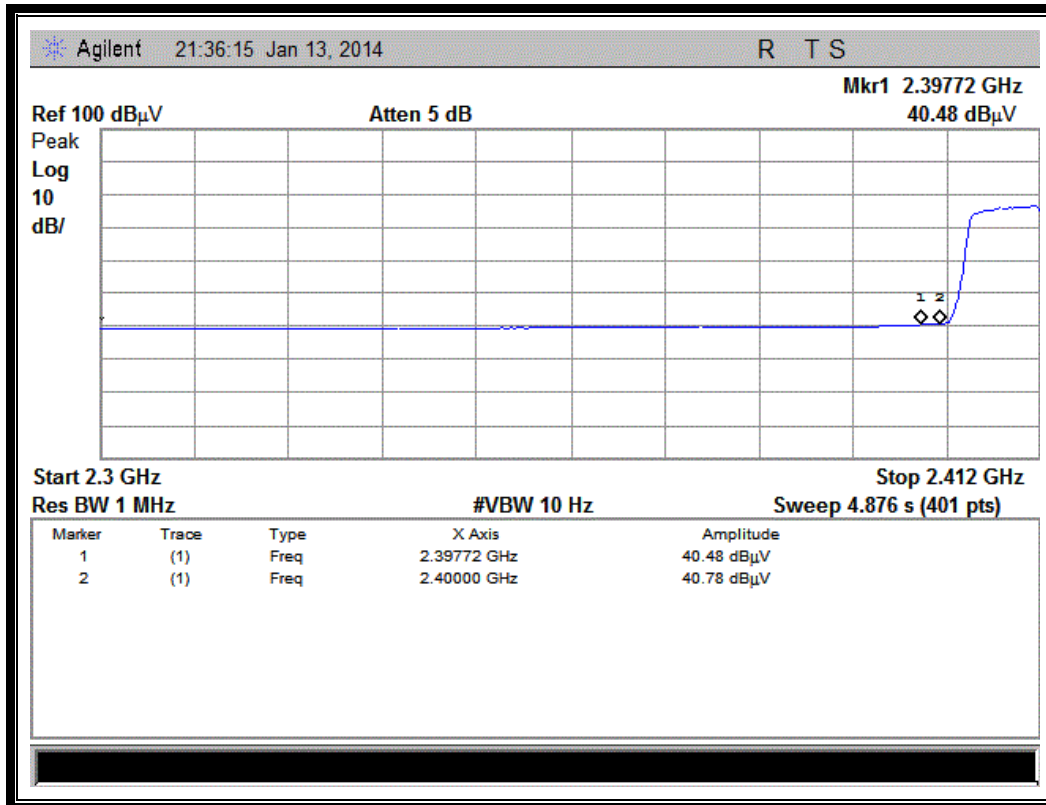

(Plot C2: Channel = 1 AVG @ 802.11g)

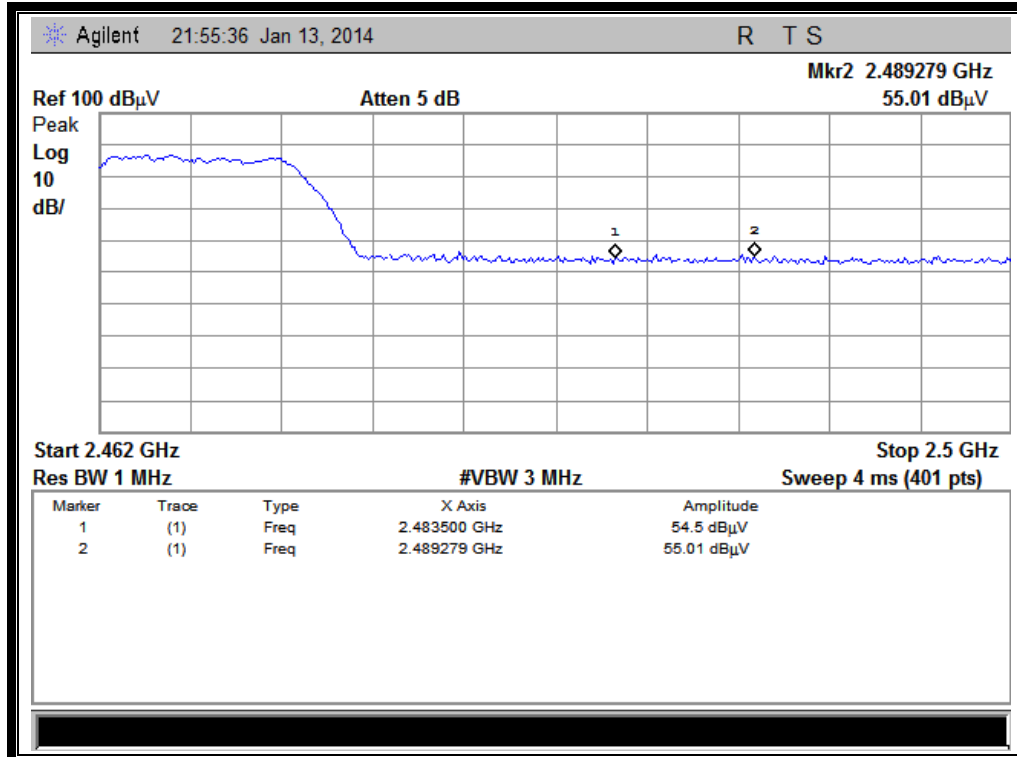

(Plot D1: Channel = 11 PEAK @ 802.11g)

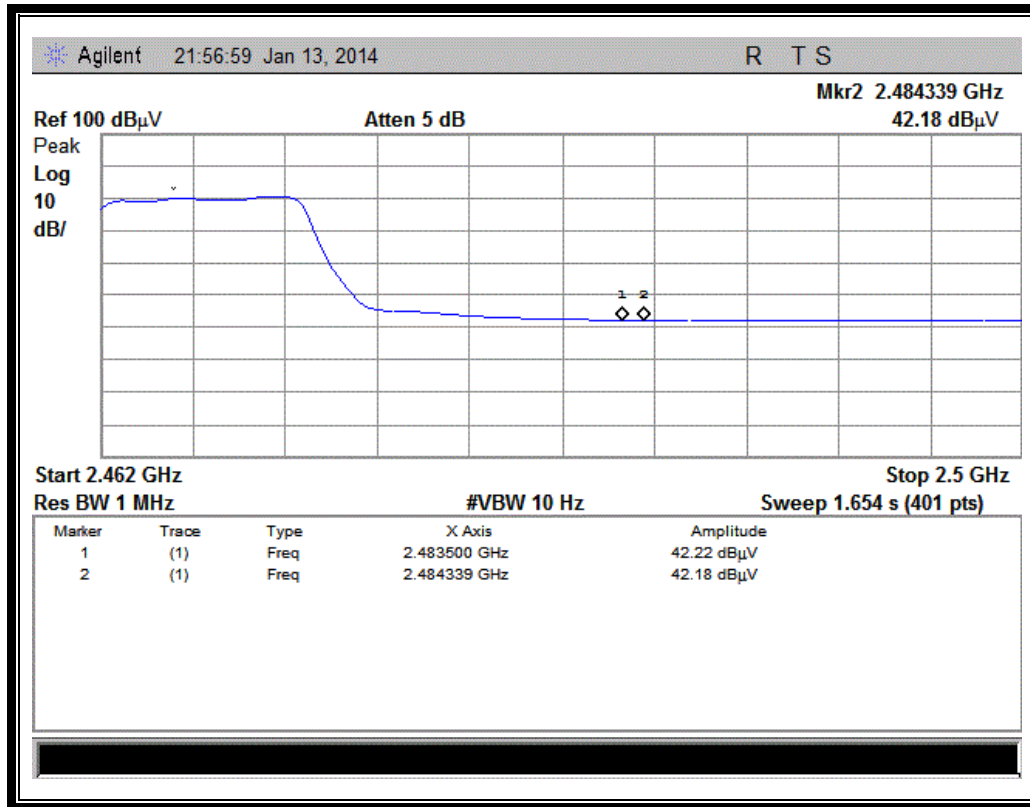

(Plot D2: Channel = 11 AVG @ 802.11g)

3.6.3.3. 802.11n-20MHz Test mode

The lowest and highest channels are tested to verify the band edge emissions.

A. Test Verdict:

Channel	Frequency (MHz)	Detector	Receiver Reading UR (dBuV)	AT (dB)	AFactor (dB@3m)	Max. Emission E (dBμV/m)	Limit (dBμV/m)	Verdict
		PK/ AV						
1	2379.24	PK	53.31	-30.93	32.56	54.94	74	Pass
1	2397.72	AV	40.48	-30.93	32.56	42.11	54	Pass
11	2481.15	PK	55.82	-29.05	32.50	59.27	74	Pass
11	2483.50	AV	42.78	-29.05	32.50	46.23	54	Pass

B. Test Plots:

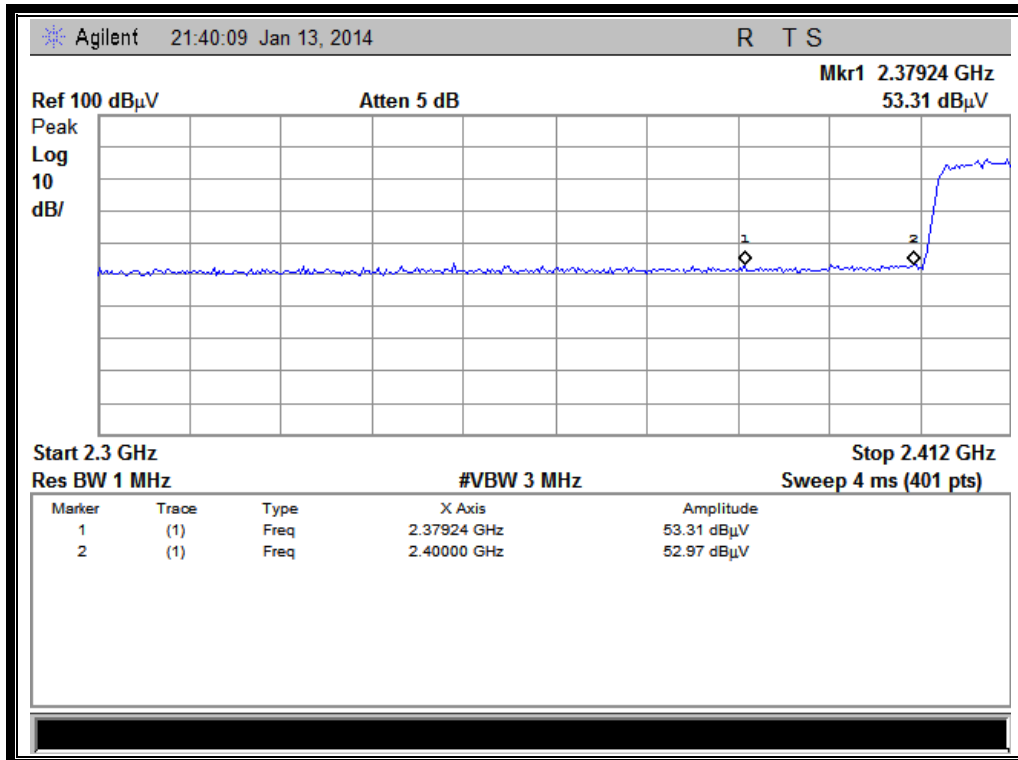

(Plot E1: Channel = 1 PEAK @ 802.11n-20)

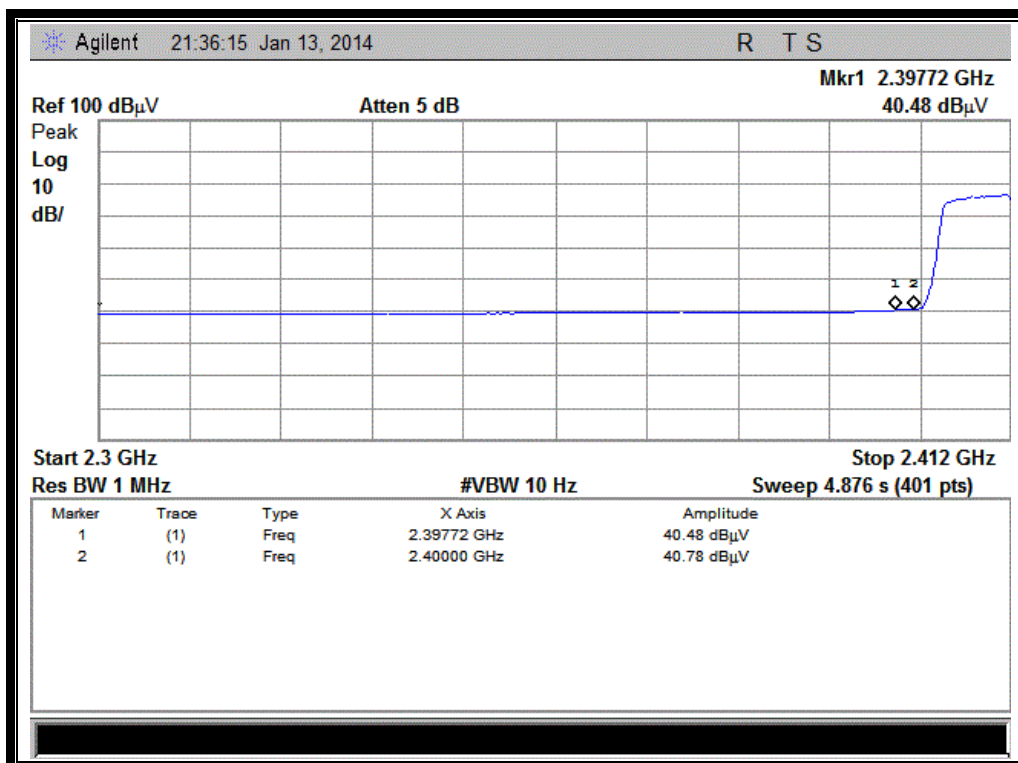

(Plot E2: Channel = 1 AVG @ 802.11n-20)

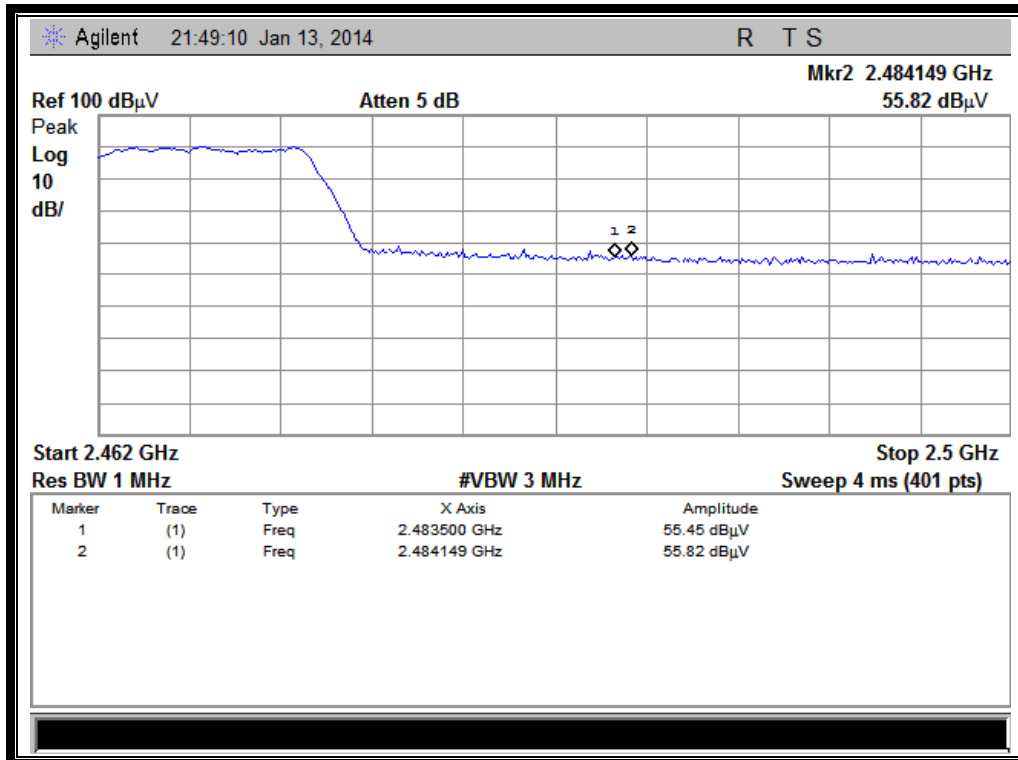

(Plot F1: Channel = 11 PEAK @ 802.11n-20)

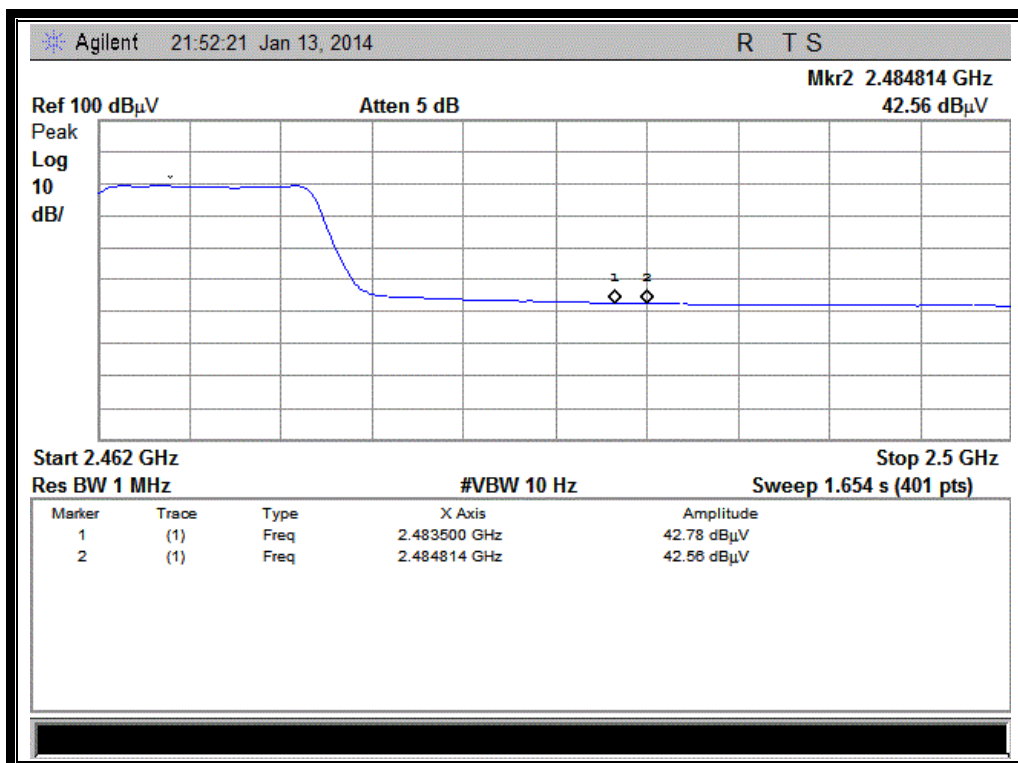

(Plot F2: Channel = 11 AVG @ 802.11n-20)

3.7. Conducted Emission

3.7.1. Requirement

For an intentional radiator that is designed to be connected to the public utility (AC) power line, the radio frequency voltage that is conducted back onto the AC power line on any frequency within the band 150kHz to 30MHz shall not exceed the limits in the following table, as measured using a 50 μ H/50 Ω line impedance stabilization network (LISN).

Frequency range (MHz)	Conducted Limit (dB μ V)	
	Quai-peak	Average
0.15 - 0.50	66 to 56	56 to 46
0.50 - 5	56	46
5 - 30	60	50

NOTE:

- (a) The lower limit shall apply at the band edges.
- (b) The limit decreases linearly with the logarithm of the frequency in the range 0.15 - 0.50MHz.

3.7.2. Test Description

A. Test Setup:

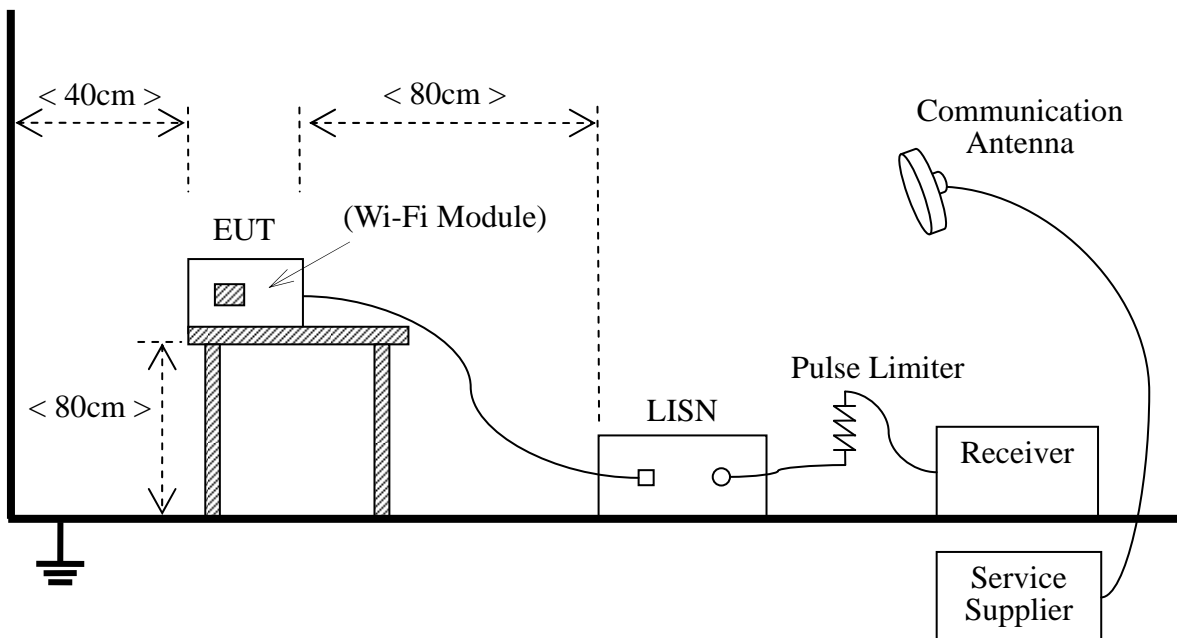

The Table-top EUT was placed upon a non-metallic table 0.8m above the horizontal metal reference ground plane. EUT was connected to LISN and LISN was connected to reference Ground Plane. EUT was 80cm from LISN. The set-up and test methods were according to ANSI C63.4:2009

The EUT is powered by the Battery charged with the AC Adapter which is powered by 120V, 60Hz AC mains supply. The factors of the site are calibrated to correct the reading. During the measurement, the EUT is activated and controlled by the Wi-Fi Service Supplier (SS) via a Common Antenna.

B. Equipments List:

Description	Manufacturer	Model	Serial No.	Cal. Date	Cal. Due
Receiver	Agilent	E7405A	US44210471	2013.05.13	2014.05.12
LISN	Schwarzbeck	NSLK 8127	812744	2013.05.13	2014.05.12
Service Supplier	R&S	CMU200	100448	2013.05.13	2014.05.12
Pulse Limiter (20dB)	Schwarzbeck	VTSD 9561-D	9391	(n.a.)	(n.a.)

3.7.3. Test Result

The maximum conducted interference is searched using Peak (PK), if the emission levels more than the AV and QP limits, and that have narrow margins from the AV and QP limits will be re-measured with AV and QP detectors. Tests for both L phase and N phase lines of the power mains connected to the EUT are performed. Refer to recorded points and plots below.

A. Test setup:

The EUT configuration of the emission tests is EUT + Link.

B. Test Plots:

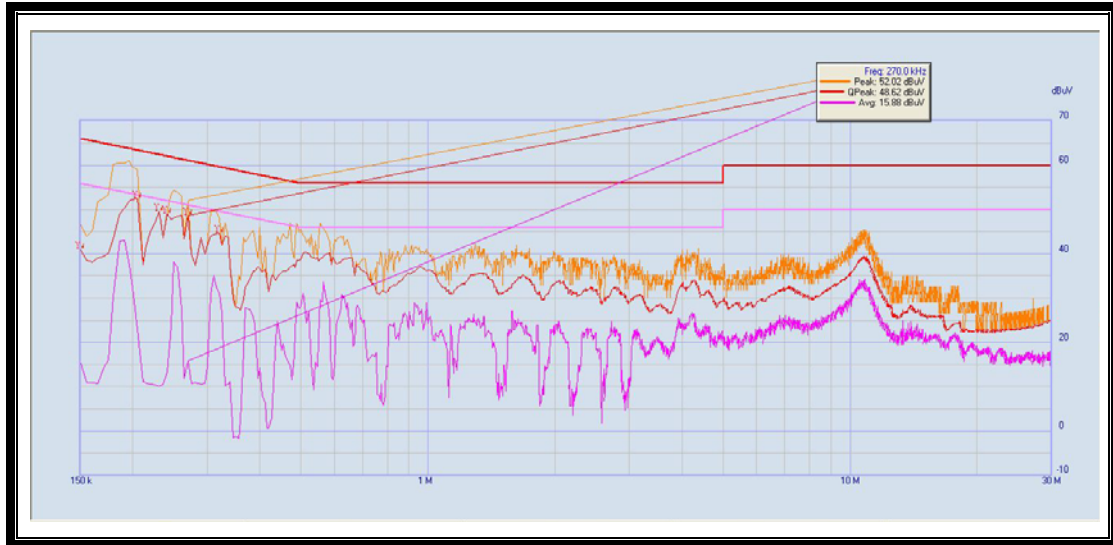

NO.	Fre. (MHz)	Emission Level (dBµV)		Limit (dBµV)		Power-line	Verdict
		Quai-peak	Average	Quai-peak	Average		
1	0.15	41.00	21.05	66.00	56.00	Line	PASS
2	0.205	52.41	34.34	64.43	54.43		PASS
3	0.23	49.60	17.51	63.71	53.71		PASS
4	0.24	49.01	17.74	63.43	53.43		PASS
5	0.27	48.62	15.88	62.57	52.57		PASS
6	0.32	44.67	20.07	61.14	51.14		PASS

(Plot A:L Phase)

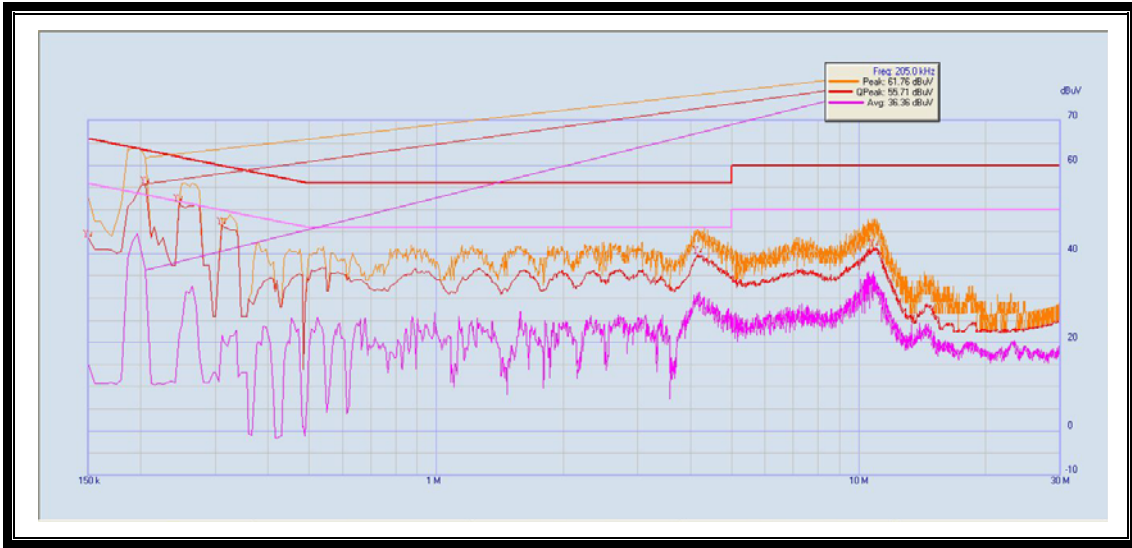

NO.	Fre. (MHz)	Emission Level (dBµV)		Limit (dBµV)		Power-line	Verdict
		Quai-peak	Average	Quai-peak	Average		
1	0.15	43.61	23.28	66.00	56.00	Neutral	PASS
2	0.205	55.71	35.25	64.43	54.43		PASS
3	0.245	51.77	36.36	63.29	53.29		PASS
4	0.31	46.46	25.19	61.43	51.43		PASS
5	4.165	39.24	20.34	56.00	46.00		PASS
6	10.88	41.34	24.61	60.00	50.00		PASS

(Plot B:N Phase)

3.8. Radiated Emission

3.8.1. Requirement

Radiated emission outside the frequency band attenuation below the general limits specified in FCC section 15.209(a) is not required. In addition, radiated emissions which fall in the restricted bands, as defined in FCC section 15.205(a), must also comply with the radiated emission limits specified in FCC section 15.209(a).

According to FCC section 15.209 (a), except as provided elsewhere in this subpart, the emissions from an intentional radiator shall not exceed the field strength levels specified in the following table:

Frequency (MHz)	Field Strength ($\mu\text{V}/\text{m}$)	Measurement Distance (m)
0.009 - 0.490	2400/F(kHz)	300
0.490 - 1.705	24000/F(kHz)	30
1.705 - 30.0	30	30
30 - 88	100	3
88 - 216	150	3
216 - 960	200	3
Above 960	500	3

Note:

1. For Above 1000MHz, the emission limit in this paragraph is based on measurement instrumentation employing an average detector, measurement using instrumentation with a peak detector function, corresponding to 20dB above the maximum permitted average limit.
2. For above 1000MHz, limit field strength of harmonics: 54dBuV/m@3m (AV) and 74dBuV/m@3m (PK)

In addition, radiated emissions which fall in the restricted bands, as defined in Section 15.205(a), also should comply with the radiated emission limits specified in Section 15.209(a)(above table)

3.8.2. Test Description

A. Test Setup:

- 1) For radiated emissions from 9kHz to 30MHz

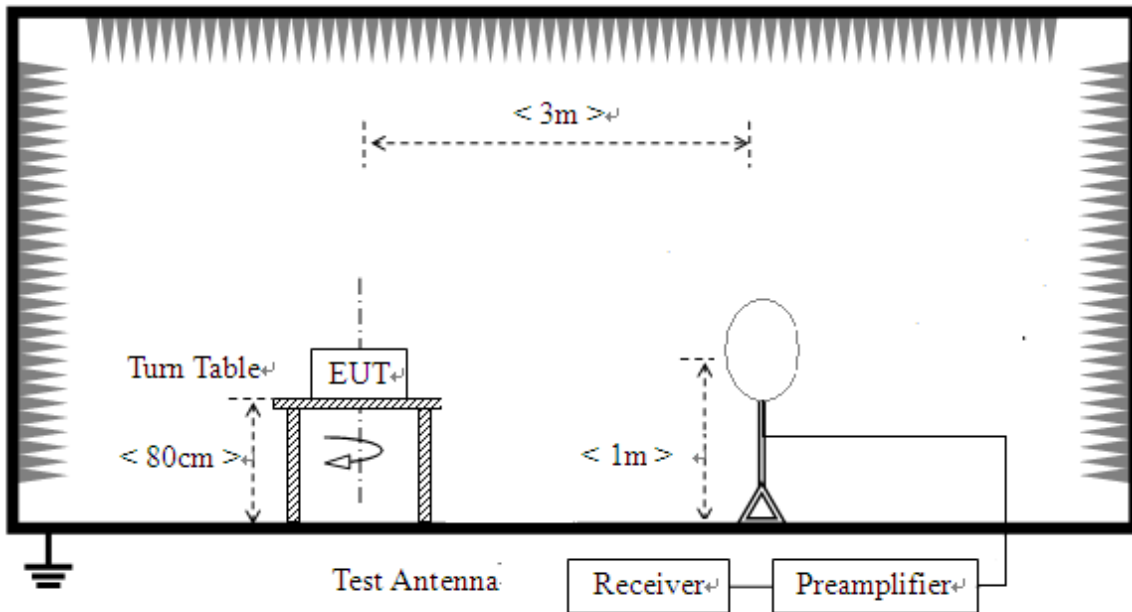

2) For radiated emissions from 30MHz to 1GHz

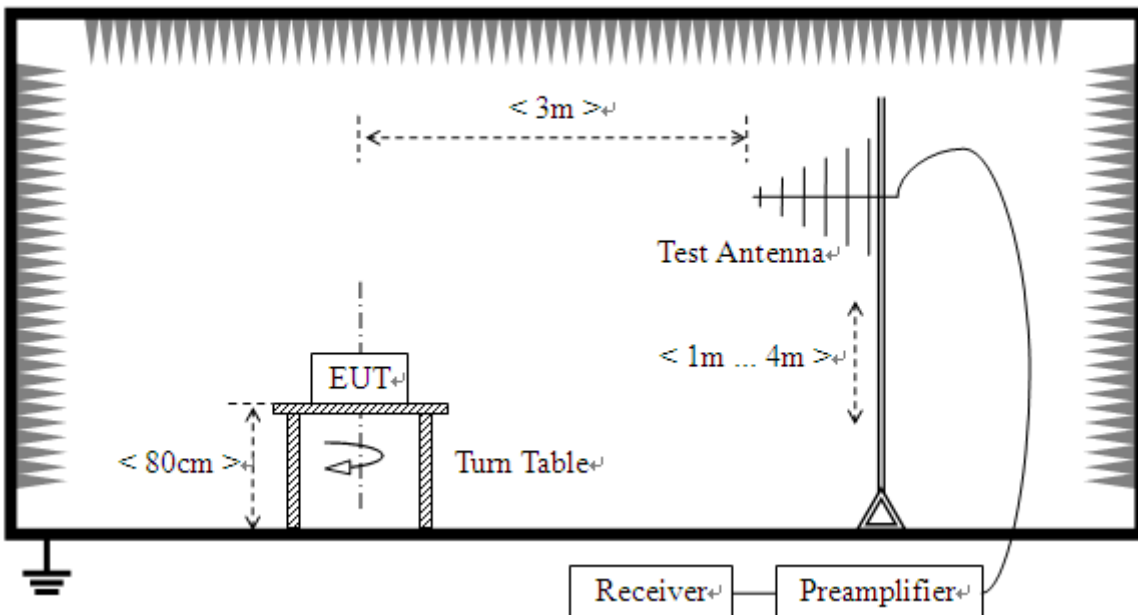

3) For radiated emissions above 1GHz

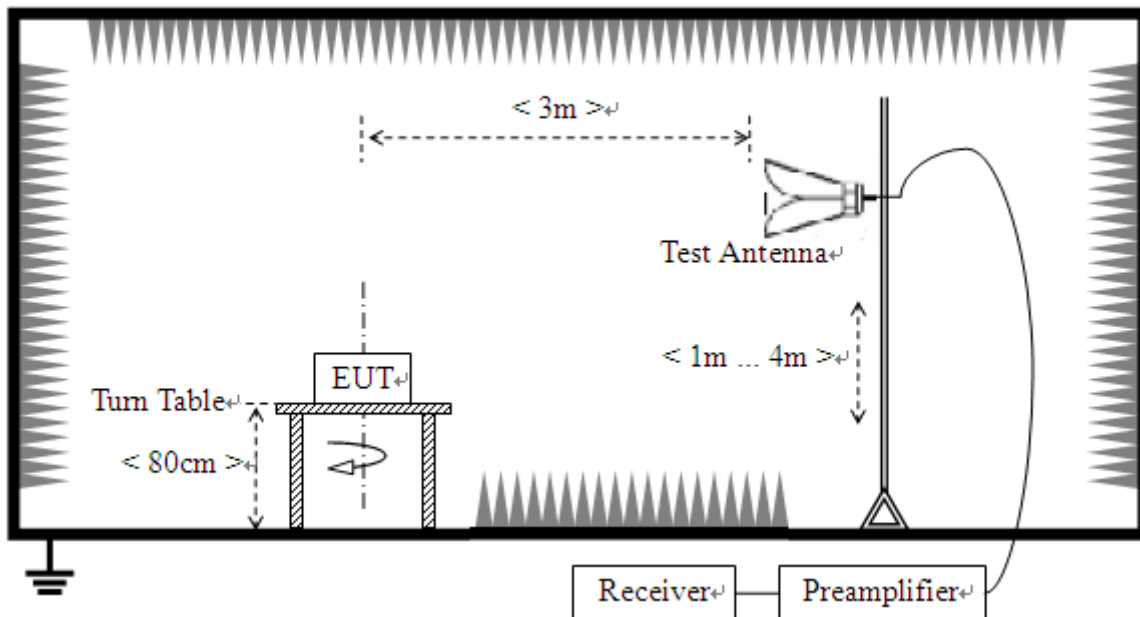

The test site semi-anechoic chamber has met the requirement of NSA tolerance 4dB according to the standards: ANSI C63.4 (2009). The EUT was set-up on insulator 80cm above the Ground Plane. The set-up and test methods were according to ANSI C63.4.

The EUT of the EUT is powered by the Battery charged with the AC Adapter which is powered by 120V, 60Hz AC mains supply. The Module is located in a 3m Semi-Anechoic Chamber; the antenna factors, cable loss and so on of the site as factors are calculated to correct the reading. During the measurement, the EUT is activated and controlled by the Wireless Router via a Common Antenna, and is set to operate under hopping-on test mode.

For the Test Antenna:

- (a) In the frequency range of 9kHz to 30MHz, magnetic field is measured with Loop Test Antenna. The Test Antenna is positioned with its plane vertical at 1m distance from the EUT. The center of the Loop Test Antenna is 1m above the ground. During the measurement the Loop Test Antenna rotates about its vertical axis for maximum response at each azimuth about the EUT.
- (b) In the frequency range above 30MHz, Bi-Log Test Antenna (30MHz to 2GHz) and Horn Test Antenna (above 2GHz) are used. Test Antenna is 3m away from the EUT. Test Antenna height is varied from 1m to 4m above the ground to determine the maximum value of the field strength. The emission levels at both horizontal and vertical polarizations should be tested.

B. Equipments List:

Description	Manufacturer	Model	Serial No.	Cal. Date	Cal. Due
System Simulator	R&S	CMU200	100448	2013.05.13	2014.05.12
Receiver	Agilent	E7405A	US44210471	2013.05.13	2014.05.12
Full-Anechoic Chamber	Albatross	9m*6m*6m	(n.a.)	2013.05.13	2014.05.12
Test Antenna - Bi-Log	Schwarzbeck	VULB 9163	9163-274	2013.05.13	2014.05.12
Test Antenna - Horn	Schwarzbeck	BBHA 9120D	9120D-963	2013.05.13	2014.05.12
Test Antenna - Horn	R&S	HL050S7	71688	2013.05.13	2014.05.12
Test Antenna -Loop	Schwarzbeck	FMZB 1519	1519-022	2013.05.13	2014.05.12

3.8.3. Test Result

According to ANSI C63.4 selection 4.2.2, because of peak detection will yield amplitudes equal to or greater than amplitudes measured with the quasi-peak (or average) detector, the measurement data from a spectrum analyzer peak detector will represent the worst-case results, if the peak measured value complies with the quasi-peak limit, it is unnecessary to perform an quasi-peak measurement.

The measurement results are obtained as below:

$$E \text{ [dB}\mu\text{V/m]} = U_R + A_T + A_{\text{Factor}} \text{ [dB]}; A_T = L_{\text{Cable loss}} \text{ [dB]} - G_{\text{preamp}} \text{ [dB]}$$

A_T : Total correction Factor except Antenna

U_R : Receiver Reading

G_{preamp} : Preamplifier Gain

A_{Factor} : Antenna Factor at 3m

During the test, the total correction Factor A_T and A_{Factor} were built in test software.

Note: All radiated emission tests were performed in X, Y, Z axis direction. And only the worst axis test condition was recorded in this test report.

The low frequency, which started from 9KHz to 30MHz, was pre-scanned and the result which was 20dB lower than the limit line per 15.31(o) was not reported.

3.8.3.1. 802.11b Test mode**A. Test Plots for the Whole Measurement Frequency Range:**

Plots for Channel = 1

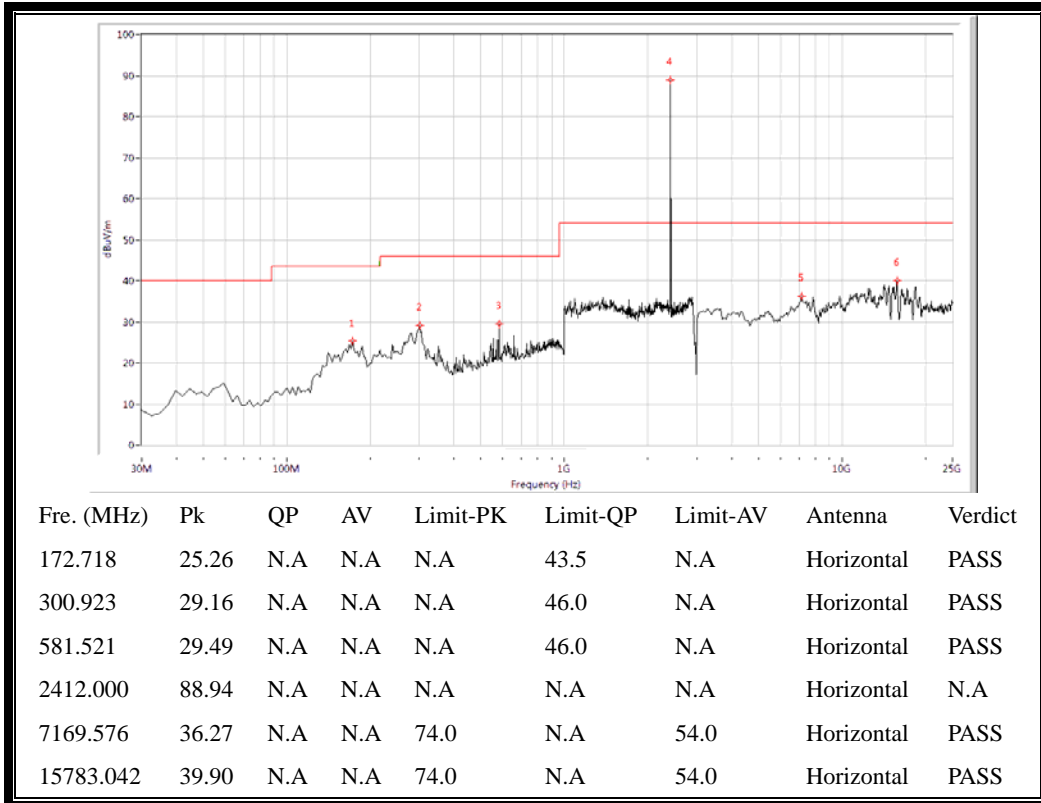

(Plot A.2: Antenna Horizontal, 30MHz to 25GHz)

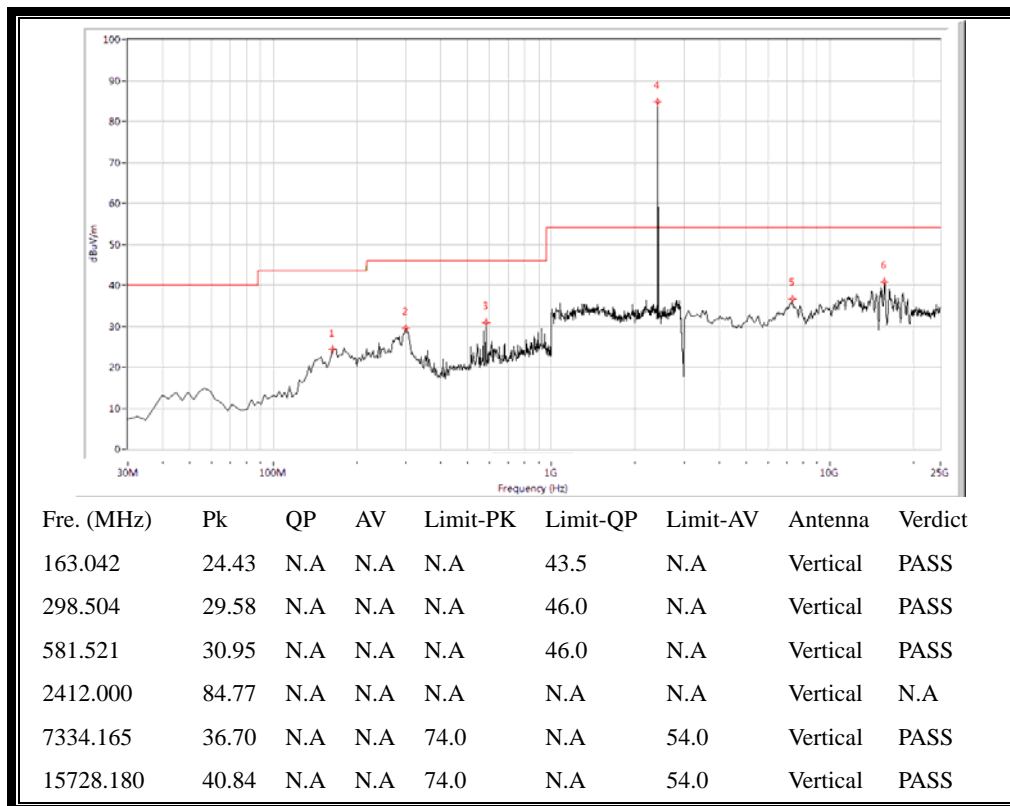

(Plot A.3: Antenna Vertical, 30MHz to 25GHz)

Plot for Channel = 6

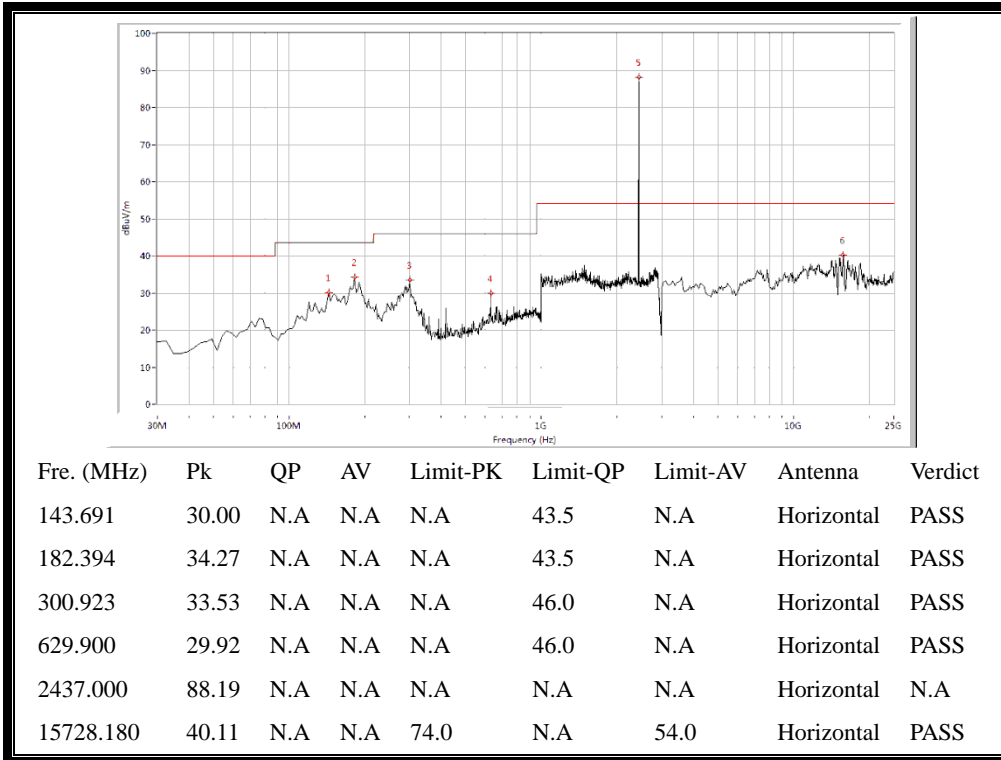

(Plot B.2: Antenna Horizontal, 30MHz to 25GHz)

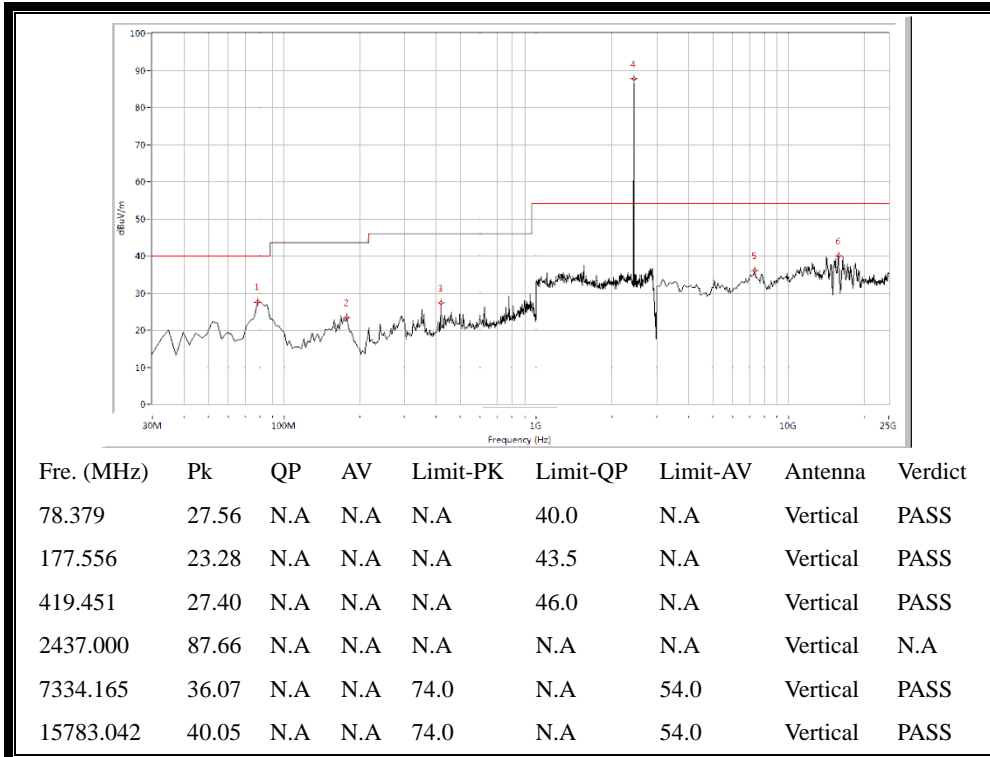

(Plot B.3: Antenna Vertical, 30MHz to 25GHz)

Plot for Channel = 11

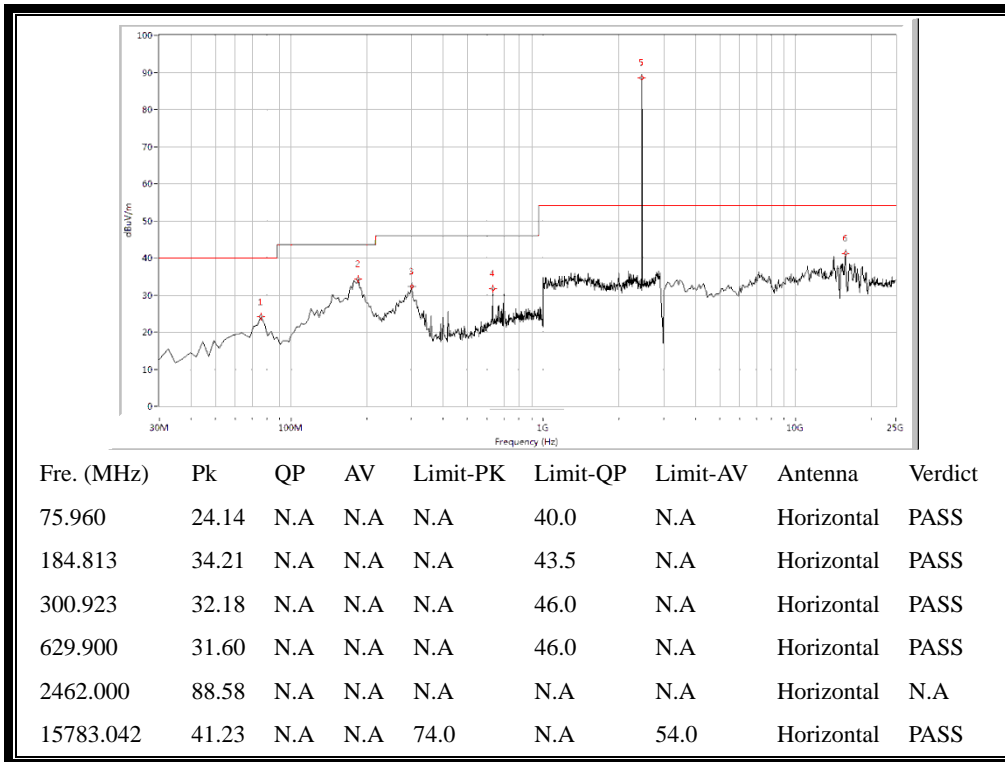

(Plot C.2: Antenna Horizontal, 30MHz to 25GHz)

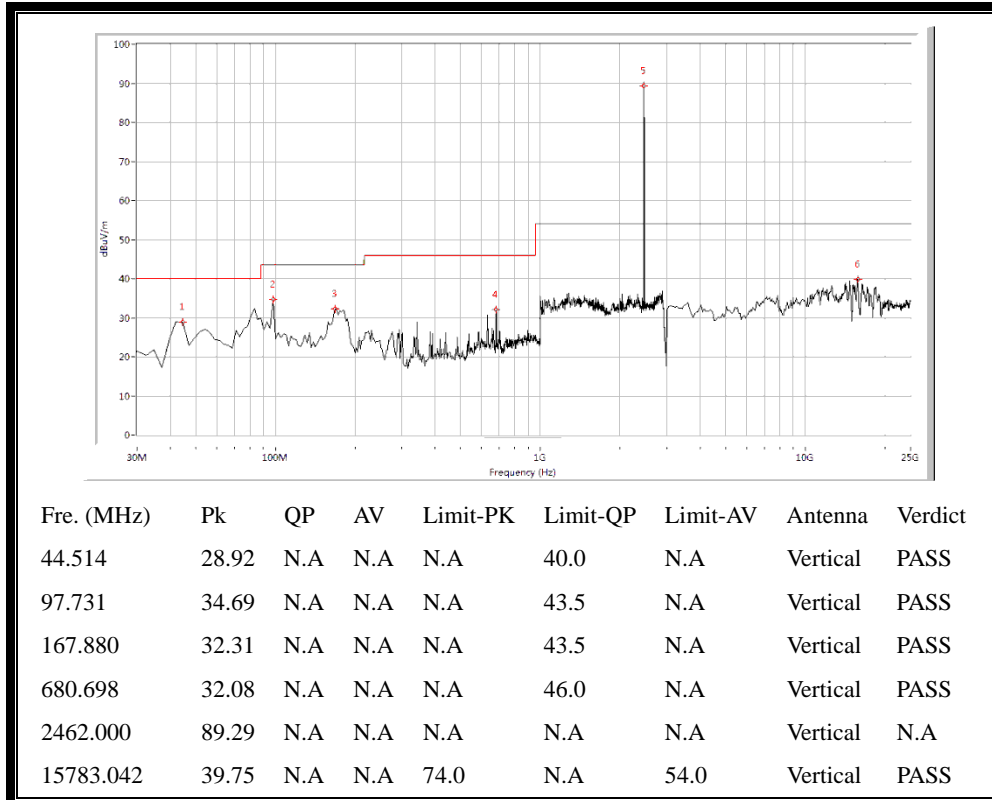

(Plot C.3: Antenna Vertical, 30MHz to 25GHz)

3.8.3.2. 802.11g Test mode

A. Test Plots for the Whole Measurement Frequency Range:

Plots for Channel = 1

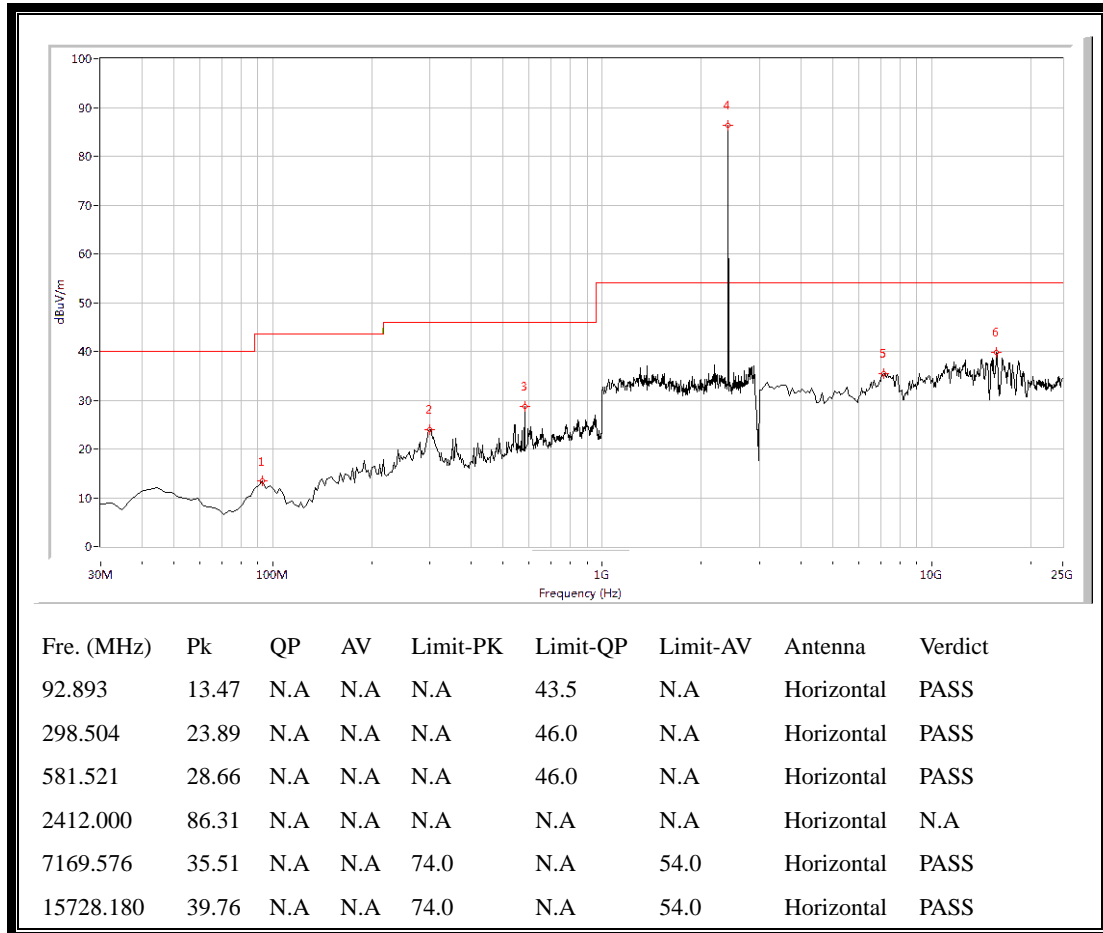

(Plot D.2: Antenna Horizontal, 30MHz to 25GHz)

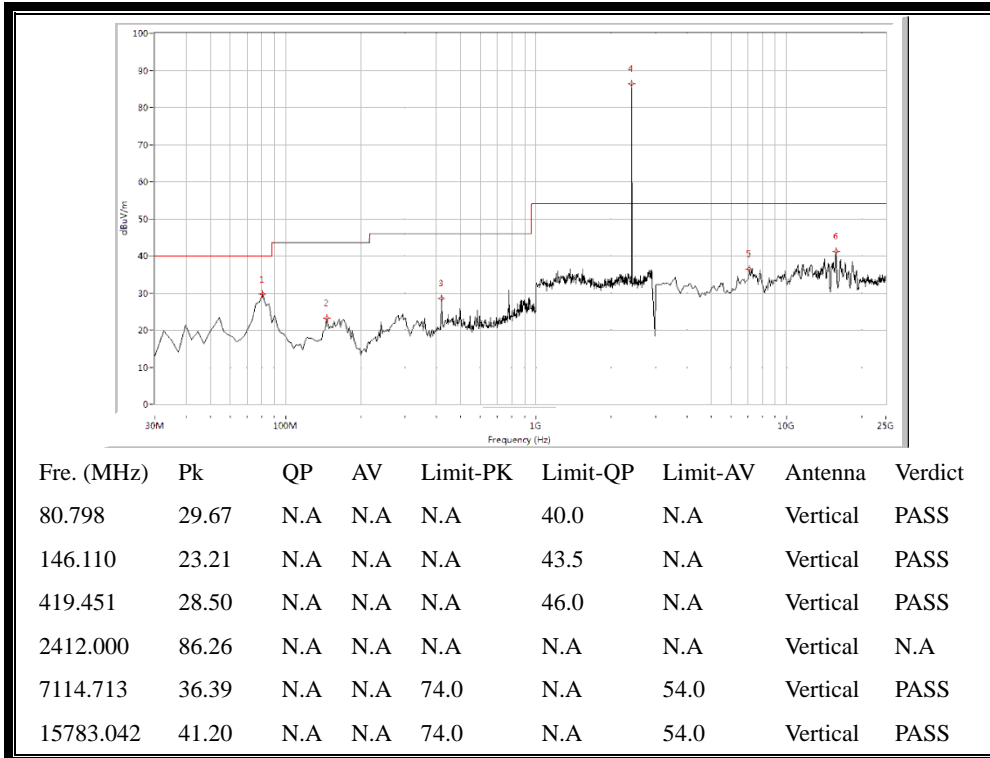

(Plot D.3: Antenna Vertical, 30MHz to 25GHz)

Plot for Channel = 6

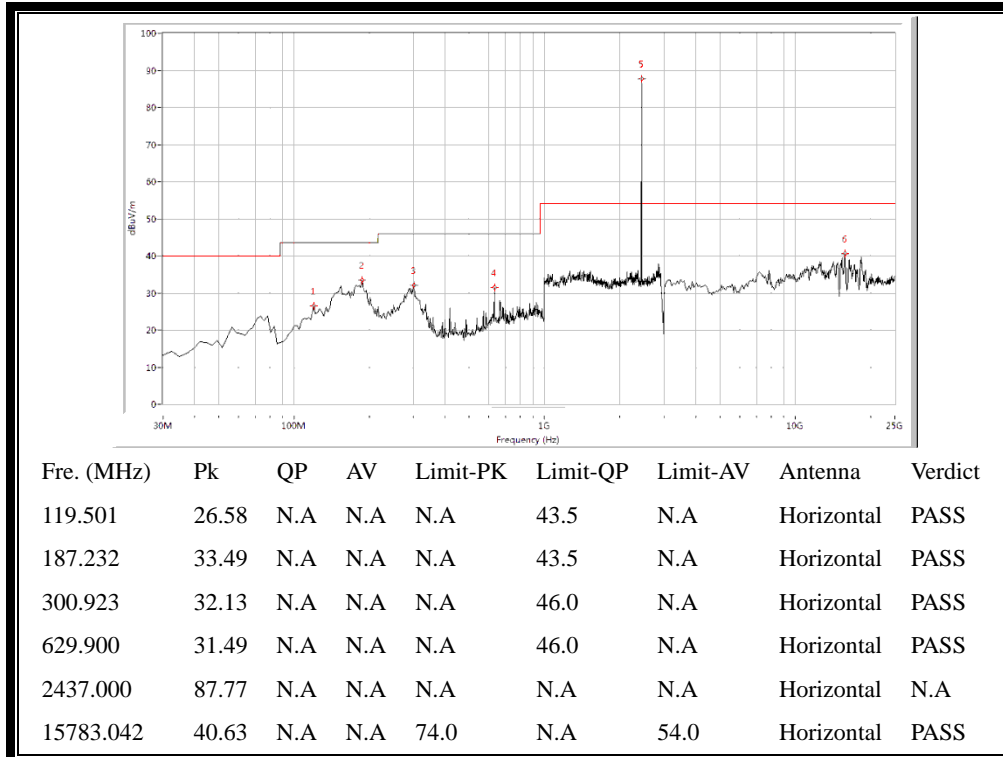

(Plot E.2: Antenna Horizontal, 30MHz to 25GHz)

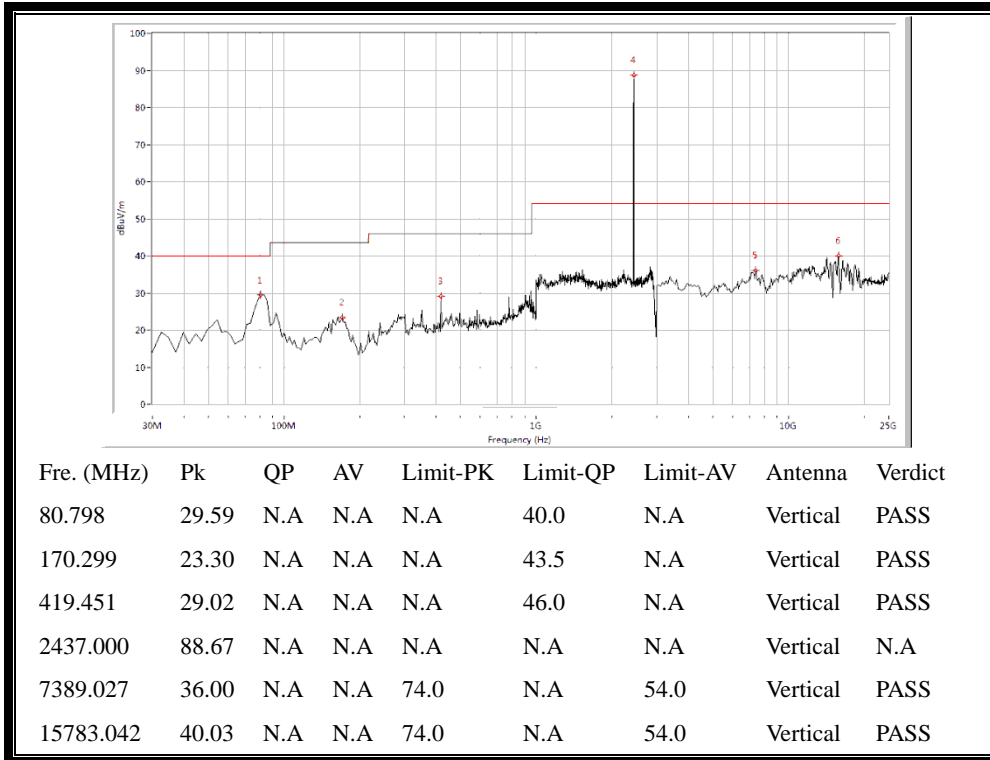

(Plot E.3: Antenna Vertical, 30MHz to 25GHz)

Plot for Channel = 11

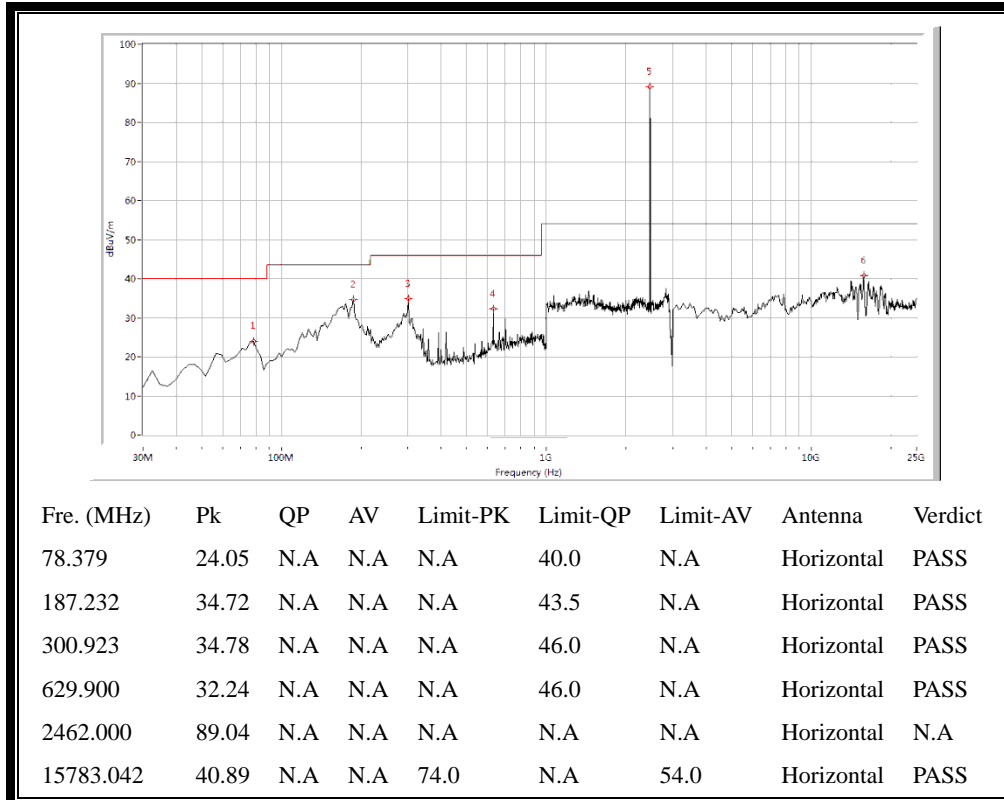

(Plot F.2: Antenna Horizontal, 30MHz to 25GHz)

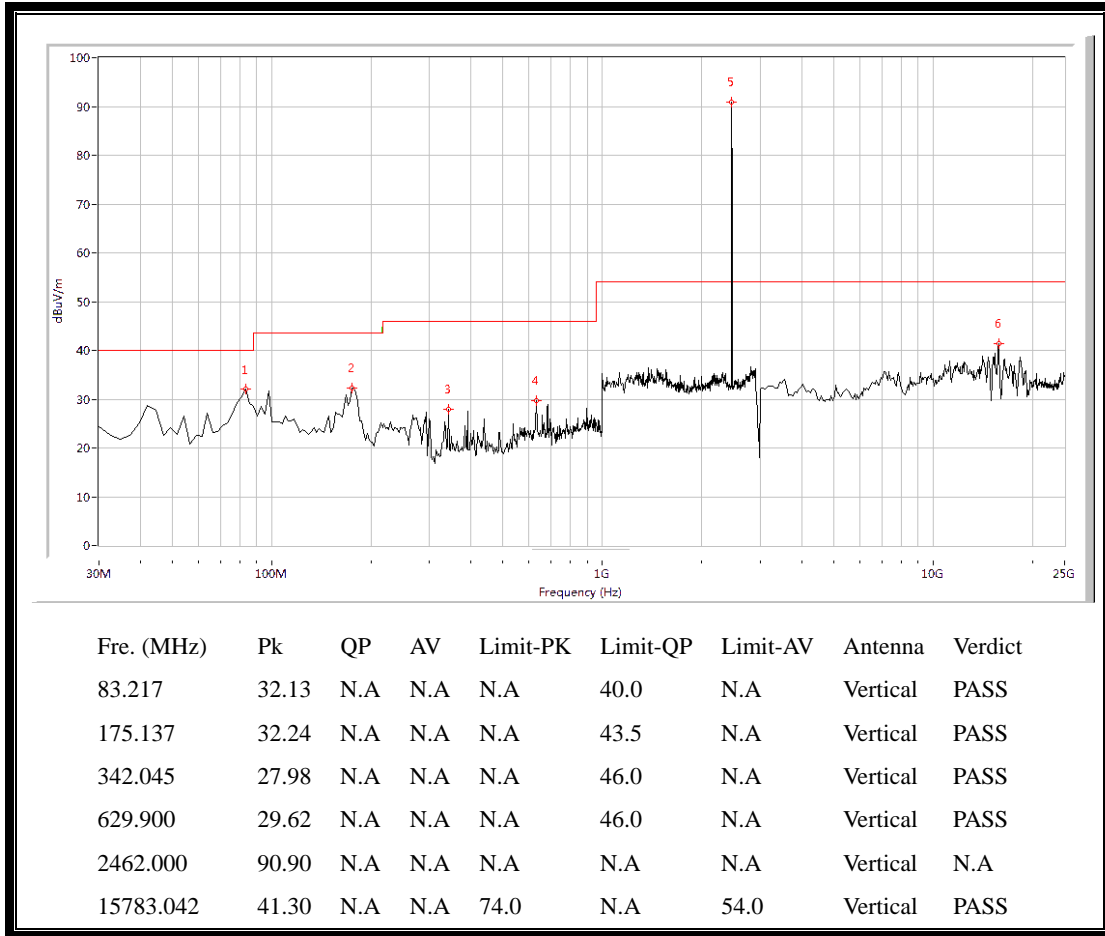

(Plot F.3: Antenna Vertical, 30MHz to 25GHz)

3.8.3.3. 802.11n-20MHz Test mode

A. Test Plots for the Whole Measurement Frequency Range:

Plots for Channel = 1

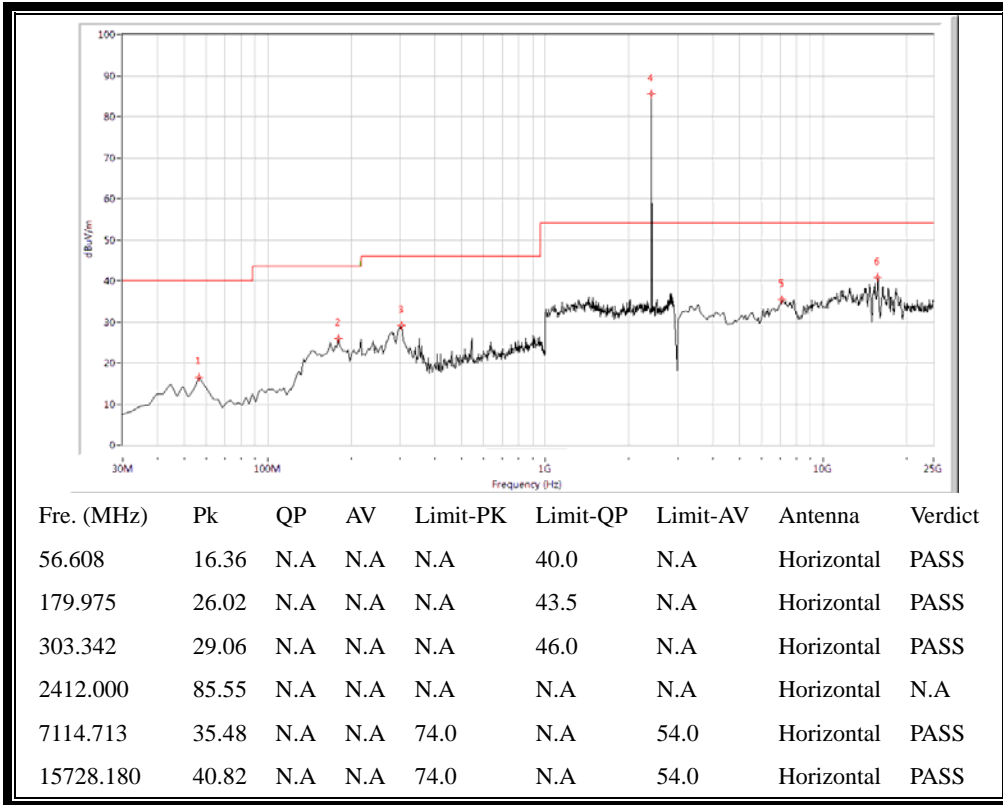

(Plot G.2: Antenna Horizontal, 30MHz to 25GHz)

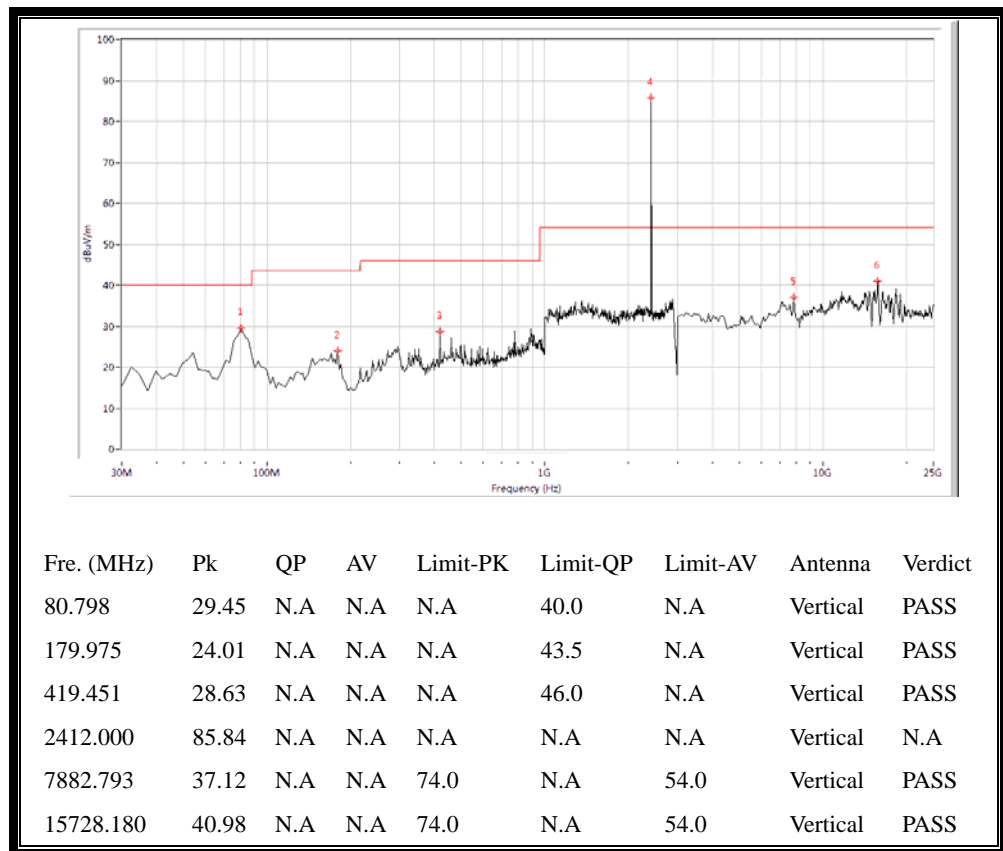

(Plot G.3: Antenna Vertical, 30MHz to 25GHz)

Plot for Channel = 6

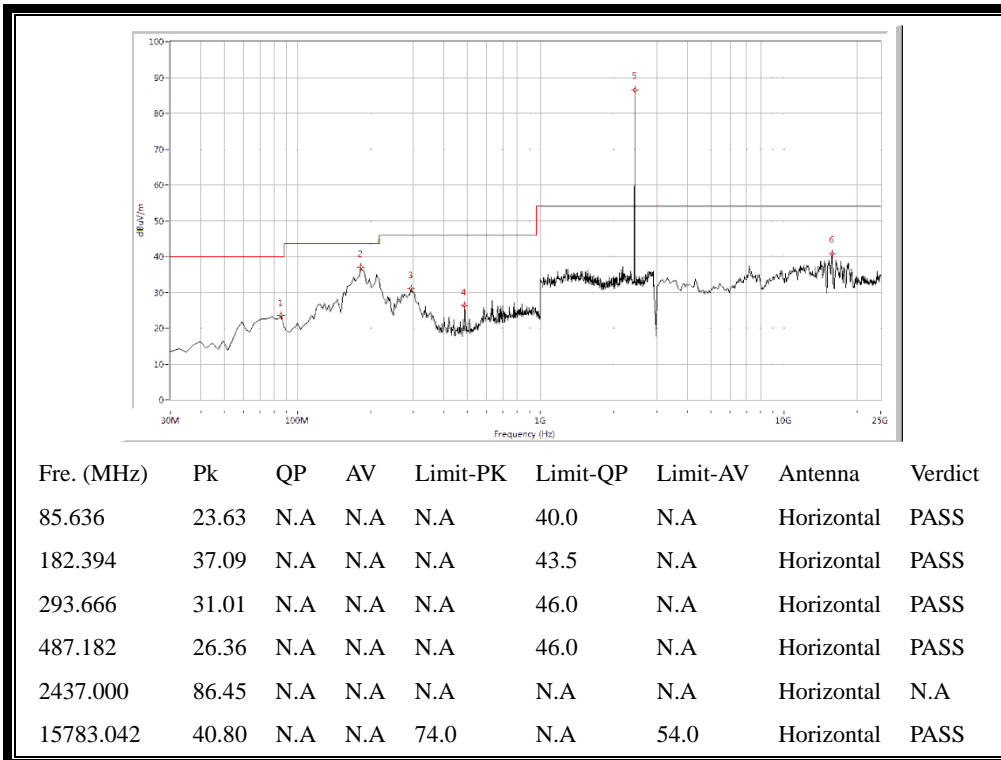

(Plot H.2: Antenna Horizontal, 30MHz to 25GHz)

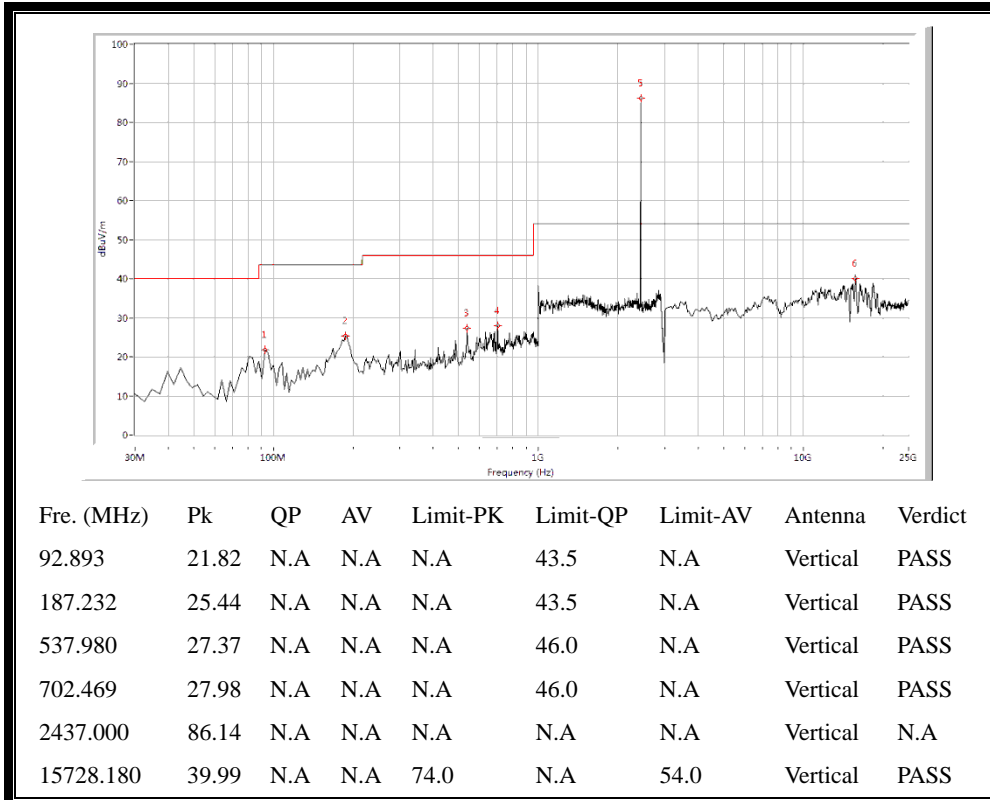

(Plot H.3: Antenna Vertical, 30MHz to 25GHz)

Plot for Channel = 11

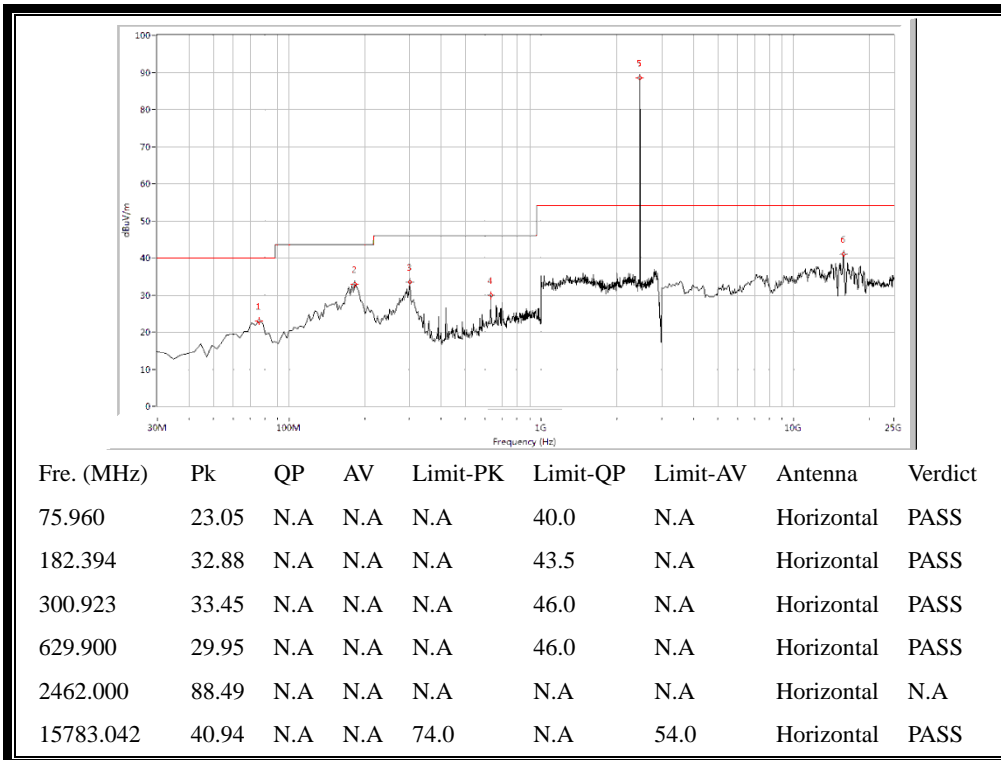

(Plot I.2: Antenna Horizontal, 30MHz to 25GHz)

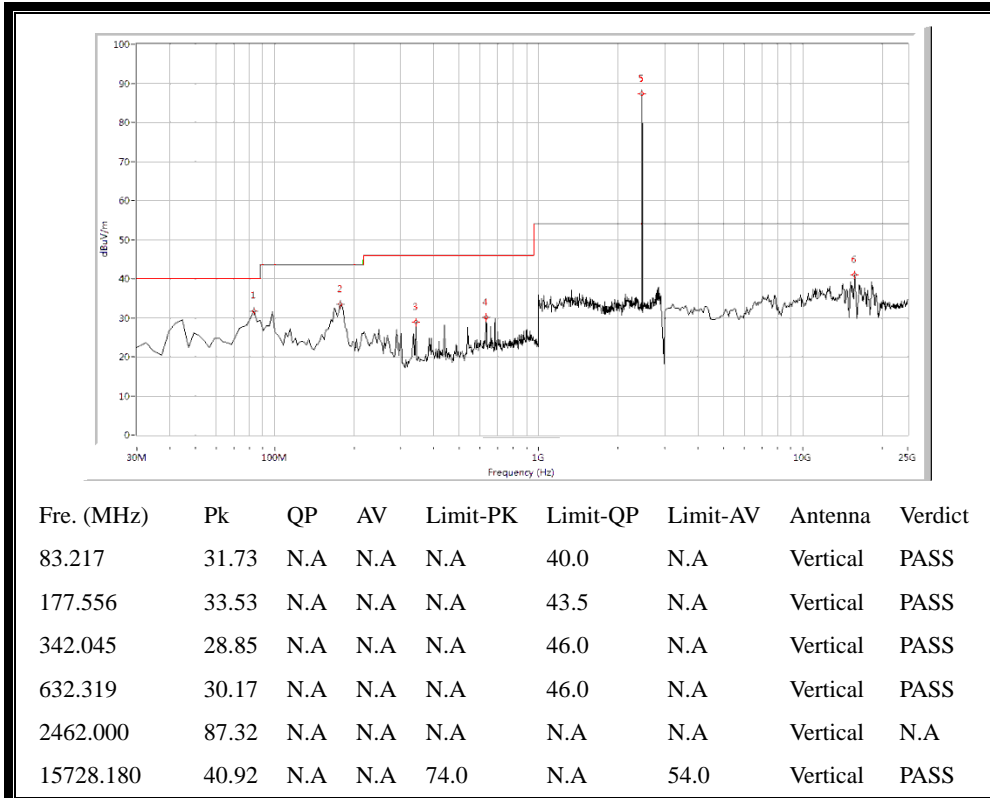

(Plot I.3: Antenna Vertical, 30MHz to 25GHz)

3.9. RF exposure evaluation

3.9.1. Requirement

According to § 1.1307(b)(1), systems operating under the provisions of this section shall be operated in a manner that ensure that the public is not exposed to radio frequency energy level in excess of Commission's guideline.

3.9.2. Result

Please refer to SAR report.

**** END OF REPORT ****