

# TEST REPORT

ACCORDING TO: FCC parts 22, 24 and part 15 subpart B

FOR:

**Motorola Communications Israel Ltd.**  
**QuadBand GSM module 850/1900 MHz**  
**Model:G24**  
**FCC ID:IHDT56FV1**

This report is in conformity with ISO/IEC 17025. The A2LA logo endorsement applies only to the test methods and the standards that are listed in the scope of Hermon Laboratories accreditation. The test results relate only to the items tested. This test report shall not be reproduced in any form except in full with the written approval of Hermon Laboratories Ltd.



## Table of contents

1	Applicant information .....	3
2	Equipment under test attributes .....	3
3	Manufacturer information .....	3
4	Test details .....	3
5	Tests summary .....	4
6	EUT description .....	5
6.1	General information .....	5
6.2	Support and test equipment .....	5
6.3	Operating frequencies .....	5
6.4	Changes made in the EUT .....	5
6.5	Transmitter characteristics .....	6
7	Transmitter tests according to 47CFR part 22 requirements .....	7
7.1	Peak output power .....	7
7.2	Occupied bandwidth test .....	10
7.3	Spurious emissions at RF antenna connector test .....	17
7.4	Field strength of spurious emissions .....	42
7.5	Frequency stability test .....	60
8	Transmitter tests according to 47CFR part 24 requirements .....	63
8.1	Peak output power .....	63
8.2	Occupied bandwidth test .....	66
8.3	Spurious emissions at RF antenna connector test .....	73
8.4	Field strength of spurious emissions .....	101
8.5	Frequency stability test .....	122
9	Unintentional radiation tests according to 47CFR part 15 subpart B requirements .....	125
9.1	Conducted emissions .....	125
9.2	Radiated emissions .....	129
10	APPENDIX A Test equipment and ancillaries used for tests .....	139
11	APPENDIX B Measurement uncertainties .....	141
12	APPENDIX C Test facility description .....	142
13	APPENDIX D Specification references .....	142
14	APPENDIX E Abbreviations and acronyms .....	143
15	APPENDIX F Test equipment correction factors .....	144

## 1 Applicant information

**Client name:** Motorola Communications Israel Ltd.  
**Address:** 3 Kremenetski street, P.O.B. 25016, 67899 Tel Aviv, Israel  
**Telephone:** +972 3565 8888  
**Fax:** +972 3565 9968  
**E-mail:** alfred.firouz@motorola.com  
**Contact name:** Mr. Alfred Firouz

## 2 Equipment under test attributes

**Product name:** QuadBand GSM module 850/1900 MHz  
**Model(s):** G24  
**Serial number:** FCN5538DXY600173  
**Hardware version:** P4  
**Software release:** 33D  
**Receipt date** 10/16/2005

## 3 Manufacturer information

**Client name:** Motorola Communications Israel Ltd.  
**Address:** 3 Kremenetski street, P.O.B. 25016, 67899 Tel Aviv, Israel  
**Telephone:** +972 3565 8888  
**Fax:** +972 3565 9968  
**E-mail:** alfred.firouz@motorola.com  
**Contact name:** Mr. Alfred Firouz



## 4 Test details

**Project ID:** 16719  
**Location:** Hermon Laboratories Ltd. P.O.Box 23, Binyamina 30500, Israel  
**Test started:** 10/16/2005  
**Test completed:** 11/06/2005  
**Test specification(s):** FCC 47 CFR parts 22, 24:2004, part 15:2005 subpart B, §§15.107, 15.109

## 5 Tests summary

Test	Status
<b>Transmitter characteristics</b>	
Sections 22.913, 24.232, RF output power	Pass
Sections 24.238(b), 2.1049, Occupied bandwidth	Pass
Sections 22.917, 24.238, Spurious emissions at antenna terminal	Pass
Sections 22.917, 24.238, Emissions at band edges	Pass
Sections 22.917, 24.238, Radiated spurious emissions	Pass
Sections 22.355, 24.235, Frequency stability	Pass
<b>Unintentional emissions</b>	
Section 15.107, Conducted emission at AC power port	Pass
Section 15.109, Radiated emission	Pass

Testing was completed against all relevant requirements of the test standard. Results obtained indicate that the product under test complies in full with the requirements tested.  
The test results relate only to the items tested. Pass/ fail decision was based on nominal values.

	Name and Title	Date	Signature
<b>Tested by:</b>	Mr. A. Adelberg, test engineer	November 6, 2005	
<b>Reviewed by:</b>	Mrs. M. Cherniavsky, certification engineer	November 7, 2005	
<b>Approved by:</b>	Mr. M. Nikishin, EMC group leader	November 28, 2005	

## 6 EUT description

### 6.1 General information

The EUT is a QuadBand GSM module, powered by DC power supply. Throughout the testing the EUT was installed into an evaluation board.

### 6.2 Support and test equipment

Description	Manufacturer	Model number	Serial number
Evaluation board	Motorola	G24eboard	8488899V01P1

### 6.3 Operating frequencies

Source	Frequency, MHz		
Digital portion	26	NA	NA
Cell 850	824.2	836.4	848.8
PCS 1900	1850.2	1880	1909.8

### 6.4 Changes made in the EUT

No changes were implemented.

## 6.5 Transmitter characteristics

### 6.5.1 G24, cell 850/PCS 1900 transmitter under the FCC ID:IHDT56FV1, manufactured by Motorola, Inc

<b>Type of equipment</b>						
	Stand-alone (Equipment with or without its own control provisions)					
	Combined equipment (Equipment where the radio part is fully integrated within another type of equipment)					
X	Plug-in card (Equipment intended for a variety of host systems)					
<b>Intended use</b>		<b>Condition of use</b>				
	fixed	Always at a distance more than 2 m from all people				
	mobile	Always at a distance more than 20 cm from all people				
X	portable	May operate at a distance closer than 20 cm to human body				
<b>Assigned frequency range</b>		824 – 849 MHz/1850 – 1910 MHz				
<b>Operating frequency range</b>		824.2 – 848.8 MHz/1850.2 – 1909.8 MHz				
<b>RF channel spacing</b>		200 kHz				
<b>Maximum rated output power</b>		At transmitter 50 $\Omega$ RF output connector		850 – 33.03 dBm 1900 –30.17 dBm		
		Effective radiated power (for equipment with no RF connector)				
<b>Is transmitter output power variable?</b>		No		continuous variable		
		X	Yes	X	stepped variable with stepsize	2 dB
					minimum RF power	0 dBm
					maximum RF power	850 – 33.03 dBm 1900 –30.17 dBm
<b>Antenna connection</b>						
unique coupling	MMCX	standard connector	X	integral	X with temporary RF connector without temporary RF connector	
<b>Antenna/s technical characteristics</b>						
Type	Frequency range		Maximum permissive gain of antenna assembly including cable loss			
External	824.0 – 849.0 MHz		5.4 dBd (7.55 dBi)			
	1850 – 1910 MHz		2.8 dBi			
<b>Transmitter 99% power bandwidth</b>		250 kHz				
<b>Transmitter aggregate data rate/s</b>		270.883 kbps				
<b>Transmitter aggregate symbol (baud) rate/s</b>		270.883 kbps				
<b>Type of modulation</b>		FSK				
<b>Type of multiplexing</b>		TDMA				
<b>Modulating test signal (baseband)</b>		GSM				
<b>Maximum transmitter duty cycle in normal use</b>		12.5 %	<b>Tx ON time</b>	0.55 msec	<b>Period</b>	4.5 msec
<b>Transmitter duty cycle supplied for test</b>		12.5 %	<b>Tx ON time</b>	0.55 msec	<b>Period</b>	4.5 msec
<b>Transmitter power source</b>						
X	DC	<b>Nominal rated voltage</b>	3.3 - 4.2 VDC	<b>Battery type</b>		
<b>Common power source for transmitter and receiver</b>			X	yes	no	

<b>Test specification:</b>	<b>Section 22.913, Peak output power</b>		
<b>Test procedure:</b>	FCC part 22, Section 22.913		
<b>Test mode:</b>	Compliance	Verdict: <b>PASS</b>	
<b>Date &amp; Time:</b>	11/4/2005 3:46:51 PM		
<b>Temperature:</b> 22°C	<b>Air Pressure:</b> 1012 hPa	<b>Relative Humidity:</b> 46 %	<b>Power Supply:</b> 4 VDC
<b>Remarks:</b>			

## 7 Transmitter tests according to 47CFR part 22 requirements

### 7.1 Peak output power

#### 7.1.1 General

This test was performed to measure the peak output power at RF antenna connector. Specification test limits are given in Table 7.1.1.

Table 7.1.1 Peak output power limits

Assigned frequency range, MHz	Maximum peak output power	
	W	dBm
824 – 849	7.0	38.45

#### 7.1.2 Test procedure

7.1.2.1 The EUT was set up as shown in Figure 7.1.1, energized and its proper operation was checked.

7.1.2.2 The EUT was adjusted to produce maximum available to the end user RF output power.

7.1.2.3 The peak output power was measured with spectrum analyzer as provided in Table 7.1.2 and associated plots.

Figure 7.1.1 Peak output power test setup

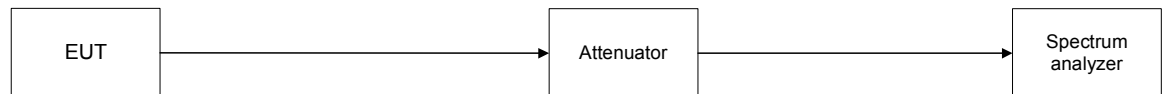

Photograph 7.1.2 Peak output power test setup



<b>Test specification:</b>		<b>Section 22.913, Peak output power</b>	
<b>Test procedure:</b>		FCC part 22, Section 22.913	
<b>Test mode:</b>	Compliance	<b>Verdict:</b>	<b>PASS</b>
<b>Date &amp; Time:</b>	11/4/2005 3:46:51 PM		
<b>Temperature:</b> 22°C	<b>Air Pressure:</b> 1012 hPa	<b>Relative Humidity:</b> 46 %	<b>Power Supply:</b> 4 VDC
<b>Remarks:</b>			

Table 7.1.2 Peak output power test results

OPERATING FREQUENCY RANGE: 824 - 849 MHz  
 DETECTOR USED: Peak  
 RESOLUTION BANDWIDTH: 2000 kHz  
 VIDEO BANDWIDTH: 3000 kHz  
 MODULATION: FSK  
 MODULATING SIGNAL: PRBS  
 BIT RATE: 270 kbps  
 TRANSMITTER OUTPUT POWER SETTINGS: Maximum

Carrier frequency, MHz	Spectrum analyzer reading, dBm	External attenuation, dB	Cable loss, dB	RF output power, dBm	Limit, dBm	Margin, dB	Verdict
824.4	33.00	Included	Included	33.00	38.45	-5.45	Pass
836.4	33.03	Included	Included	33.03	38.45	-5.42	Pass
848.8	33.03	Included	Included	33.03	38.45	-5.42	Pass

Reference numbers of test equipment used

HL 1424	HL 2524	HL 2634					
---------	---------	---------	--	--	--	--	--

Full description is given in Appendix A.

Plot 7.1.1 Peak output power test results at low frequency

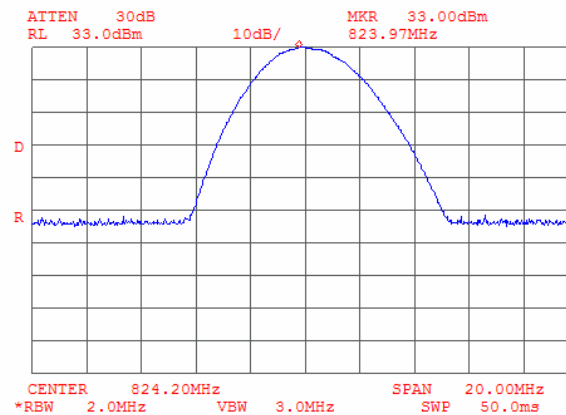



<b>Test specification:</b>	<b>Section 22.913, Peak output power</b>		
<b>Test procedure:</b>	FCC part 22, Section 22.913		
<b>Test mode:</b>	Compliance	Verdict: <b>PASS</b>	
<b>Date &amp; Time:</b>	11/4/2005 3:46:51 PM		
<b>Temperature: 22°C</b>	<b>Air Pressure: 1012 hPa</b>	<b>Relative Humidity: 46 %</b>	<b>Power Supply: 4 VDC</b>
<b>Remarks:</b>			

Plot 7.1.2 Peak output power test results at mid frequency

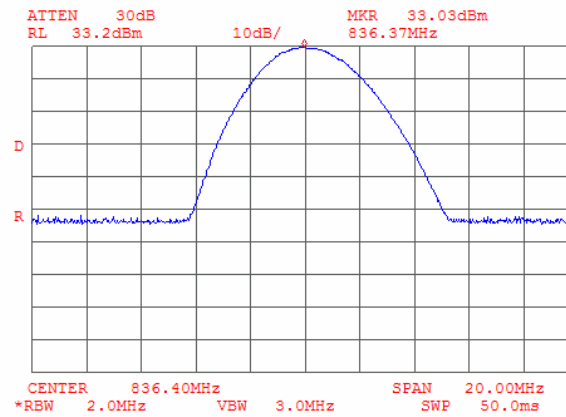

Plot 7.1.3 Peak output power test results at high frequency

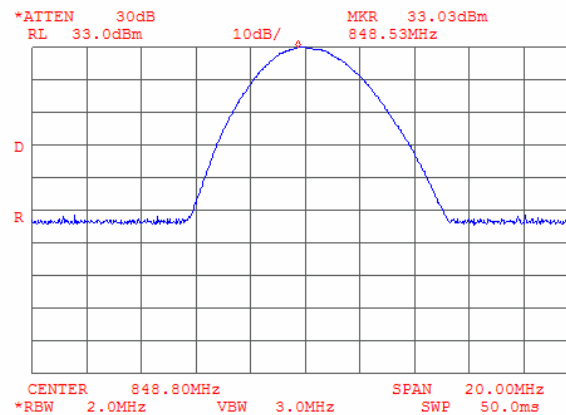

<b>Test specification:</b>	<b>Section 2.1049, Occupied bandwidth</b>		
<b>Test procedure:</b>	FCC part 2, Section 2.1049		
<b>Test mode:</b>	Compliance	<b>Verdict:</b>	<b>PASS</b>
<b>Date &amp; Time:</b>	10/20/2005 9:39:03 AM		
<b>Temperature:</b> 23°C	<b>Air Pressure:</b> 1007 hPa	<b>Relative Humidity:</b> 40%	<b>Power Supply:</b> 4 V DC
<b>Remarks:</b>			

## 7.2 Occupied bandwidth test

### 7.2.1 General

This test was performed to measure transmitter occupied bandwidth. Specification test limits are given in Table 7.2.1.

**Table 7.2.1 Occupied bandwidth limits**

Assigned frequency, MHz	Modulation envelope reference points*, dBc
824 - 849	26

\* - Modulation envelope reference points are provided in terms of attenuation below the unmodulated carrier.

### 7.2.2 Test procedure

**7.2.2.1** The EUT was set up as shown in Figure 7.2.1, energized and its proper operation was checked.

**7.2.2.2** The EUT was set to transmit the unmodulated carrier and the reference peak power level was measured.

**7.2.2.3** The EUT was set to transmit the normally modulated carrier.

**7.2.2.4** The transmitter occupied bandwidth was measured with spectrum analyzer as a frequency delta between the reference points on modulation envelope and the results provided in Table 7.2.2 and the associated plots.

**Figure 7.2.1 Occupied bandwidth test setup**

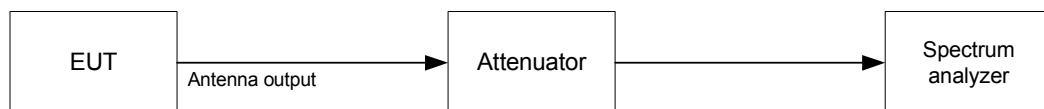

**Photograph 7.2.2 Occupied bandwidth test setup**



<b>Test specification:</b>	<b>Section 2.1049, Occupied bandwidth</b>		
<b>Test procedure:</b>	FCC part 2, Section 2.1049		
<b>Test mode:</b>	Compliance	<b>Verdict: PASS</b>	
<b>Date &amp; Time:</b>	10/20/2005 9:39:03 AM		
<b>Temperature:</b> 23°C	<b>Air Pressure:</b> 1007 hPa	<b>Relative Humidity:</b> 40%	<b>Power Supply:</b> 4 V DC
<b>Remarks:</b>			

**Table 7.2.2 Occupied bandwidth test results**

DETECTOR USED: Peak hold  
 RESOLUTION BANDWIDTH: 3 kHz  
 VIDEO BANDWIDTH: 10 kHz  
 MODULATION ENVELOPE REFERENCE POINTS: 26 dBc  
 MODULATION: FSK  
 MODULATING SIGNAL: PRBS  
 BIT RATE: 270 kbps

Carrier frequency, MHz	Lower reference point, MHz	Upper reference point, MHz	Occupied bandwidth, kHz
824.2	824.065	824.347	282
836.4	836.262	836.540	278
848.8	848.660	848.943	283

**Reference numbers of test equipment used**

HL 1424	HL 2399	HL 2524				
---------	---------	---------	--	--	--	--

Full description is given in Appendix A.

<b>Test specification:</b>	<b>Section 2.1049, Occupied bandwidth</b>		
<b>Test procedure:</b>	FCC part 2, Section 2.1049		
<b>Test mode:</b>	Compliance	<b>Verdict:</b>	<b>PASS</b>
<b>Date &amp; Time:</b>	10/20/2005 9:39:03 AM		
<b>Temperature:</b> 23°C	<b>Air Pressure:</b> 1007 hPa	<b>Relative Humidity:</b> 40%	<b>Power Supply:</b> 4 V DC
<b>Remarks:</b>			

Plot 7.2.1 Occupied bandwidth test result at low frequency, reference level

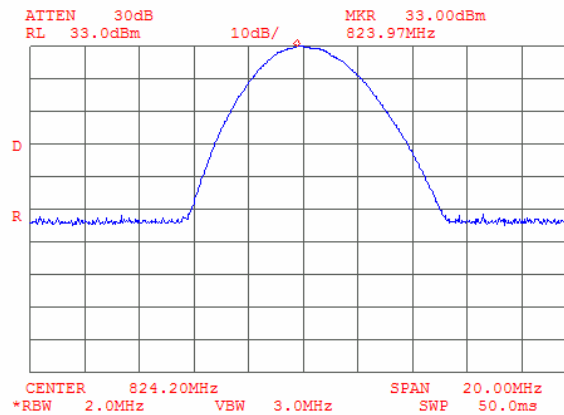

Plot 7.2.2 Occupied bandwidth test result at low frequency, lower reference point

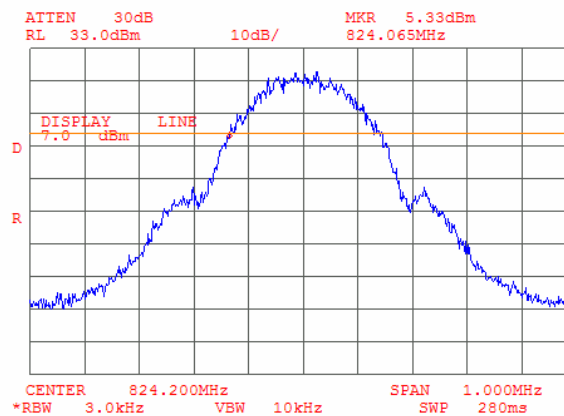

<b>Test specification:</b>	<b>Section 2.1049, Occupied bandwidth</b>		
<b>Test procedure:</b>	FCC part 2, Section 2.1049		
<b>Test mode:</b>	Compliance	<b>Verdict: PASS</b>	
<b>Date &amp; Time:</b>	10/20/2005 9:39:03 AM		
<b>Temperature:</b> 23°C	<b>Air Pressure:</b> 1007 hPa	<b>Relative Humidity:</b> 40%	<b>Power Supply:</b> 4 V DC
<b>Remarks:</b>			

Plot 7.2.3 Occupied bandwidth test result at low frequency, higher reference point

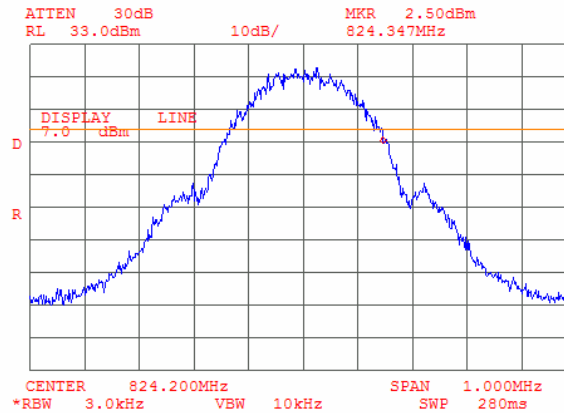

Plot 7.2.4 Occupied bandwidth test result at mid frequency, reference level

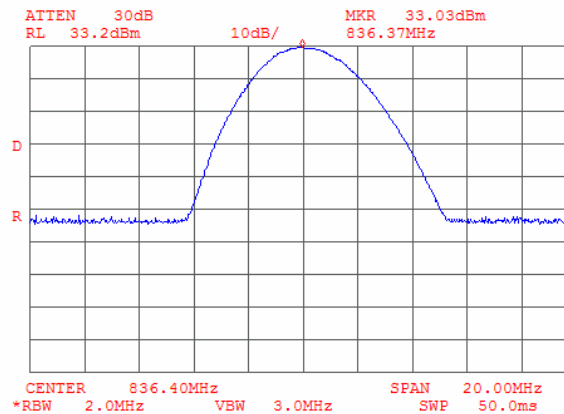

<b>Test specification:</b>	<b>Section 2.1049, Occupied bandwidth</b>		
<b>Test procedure:</b>	FCC part 2, Section 2.1049		
<b>Test mode:</b>	Compliance	<b>Verdict:</b>	<b>PASS</b>
<b>Date &amp; Time:</b>	10/20/2005 9:39:03 AM		
<b>Temperature:</b> 23°C	<b>Air Pressure:</b> 1007 hPa	<b>Relative Humidity:</b> 40%	<b>Power Supply:</b> 4 V DC
<b>Remarks:</b>			

Plot 7.2.5 Occupied bandwidth test result at mid frequency, lower reference point

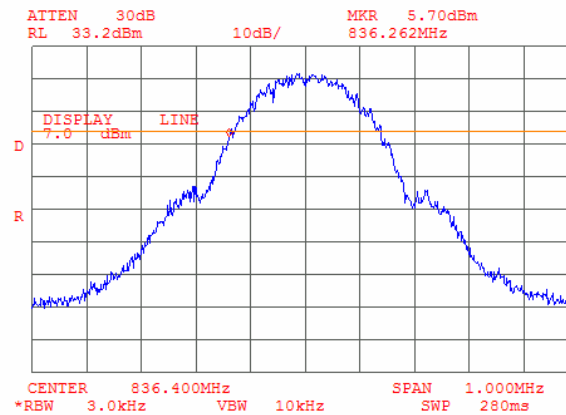

Plot 7.2.6 Occupied bandwidth test result at mid frequency, higher reference point

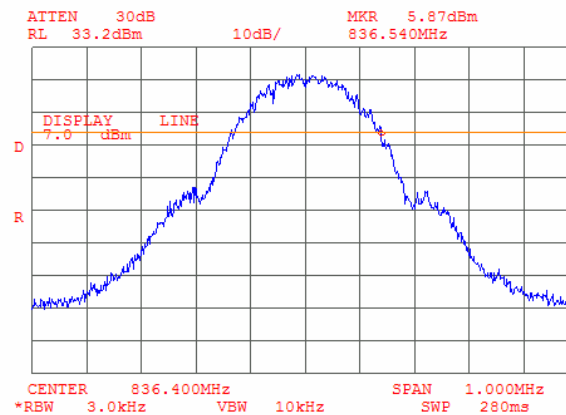

<b>Test specification:</b>	<b>Section 2.1049, Occupied bandwidth</b>		
<b>Test procedure:</b>	FCC part 2, Section 2.1049		
<b>Test mode:</b>	Compliance	<b>Verdict: PASS</b>	
<b>Date &amp; Time:</b>	10/20/2005 9:39:03 AM		
<b>Temperature:</b> 23°C	<b>Air Pressure:</b> 1007 hPa	<b>Relative Humidity:</b> 40%	<b>Power Supply:</b> 4 V DC
<b>Remarks:</b>			

Plot 7.2.7 Occupied bandwidth test result at high frequency, reference level

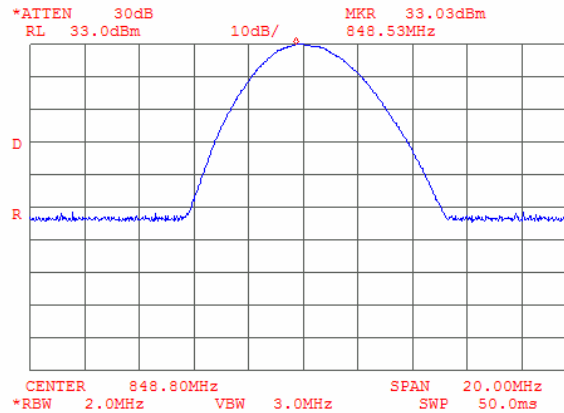

Plot 7.2.8 Occupied bandwidth test result at high frequency, lower reference point

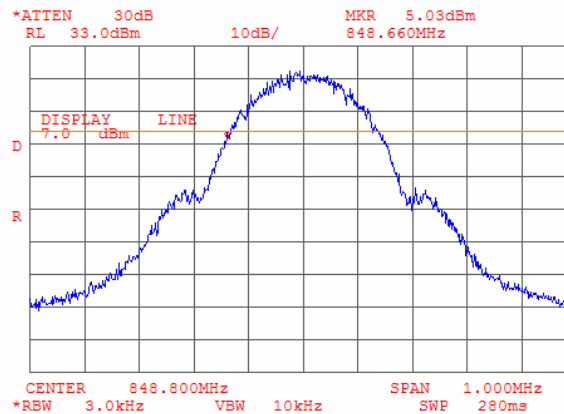

<b>Test specification:</b>	<b>Section 2.1049, Occupied bandwidth</b>		
<b>Test procedure:</b>	FCC part 2, Section 2.1049		
<b>Test mode:</b>	Compliance	<b>Verdict:</b>	<b>PASS</b>
<b>Date &amp; Time:</b>	10/20/2005 9:39:03 AM		
<b>Temperature:</b> 23°C	<b>Air Pressure:</b> 1007 hPa	<b>Relative Humidity:</b> 40%	<b>Power Supply:</b> 4 V DC
<b>Remarks:</b>			

Plot 7.2.9 Occupied bandwidth test result at high frequency, higher reference point

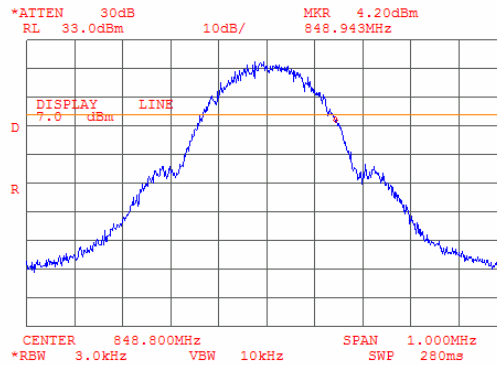

Plot 7.2.10 Bandedge emission measurements in 823 - 824 MHz range at low carrier frequency

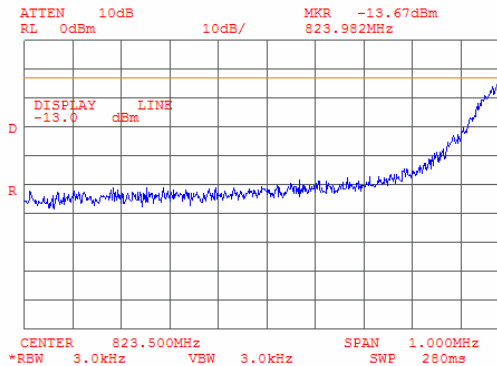

Plot 7.2.11 Bandedge emission measurements in 849 - 850 MHz range at high carrier frequency

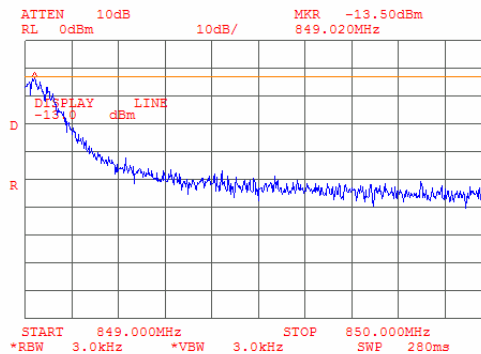

For bandedge emissions measurement procedure refer to section 7.3



<b>Test specification:</b>	<b>Section 22.917, Spurious emission at antenna terminal</b>		
<b>Test procedure:</b>	FCC part 22, Section 22.917		
<b>Test mode:</b>	Compliance	<b>Verdict:</b>	<b>PASS</b>
<b>Date &amp; Time:</b>	10/20/2005 4:03:01 PM		
<b>Temperature:</b> 22 °C	<b>Air Pressure:</b> 1012 hPa	<b>Relative Humidity:</b> 46 %	<b>Power Supply:</b> 4 VDC
<b>Remarks:</b>			

### 7.3 Spurious emissions at RF antenna connector test

#### 7.3.1 General

This test was performed to measure spurious emissions at RF antenna connector. Specification test limits are given in Table 7.3.1.

Table 7.3.1 Spurious emission limits

Frequency, MHz	Attenuation below carrier, dBc	ERP of spurious, dBm
0.009 – 10 <sup>th</sup> harmonic*	43+10logP*	-13.0

- spurious emission limits do not apply to the in band emission within  $\pm 250$  % of the authorized bandwidth from the carrier; investigated in course of emission mask testing

#### 7.3.2 Test procedure

7.3.2.1 The EUT was set up as shown in Figure 7.3.1, energized and its proper operation was checked.

7.3.2.2 The EUT was adjusted to produce maximum available for end user RF output power.

7.3.2.3 The spurious emission was measured with spectrum analyzer as provided in Table 7.3.2 and associated plots.

Figure 7.3.1 Spurious emission test setup



Photograph 7.3.2 Spurious emission test setup



<b>Test specification:</b>	<b>Section 22.917, Spurious emission at antenna terminal</b>			
<b>Test procedure:</b>	FCC part 22, Section 22.917			
<b>Test mode:</b>	Compliance	<b>Verdict:</b>		<b>PASS</b>
<b>Date &amp; Time:</b>	10/20/2005 4:03:01 PM			
<b>Temperature:</b> 22 °C	<b>Air Pressure:</b> 1012 hPa	<b>Relative Humidity:</b> 46 %	<b>Power Supply:</b> 4 VDC	
<b>Remarks:</b>				

**Table 7.3.2 Spurious emission test results**

ASSIGNED FREQUENCY RANGE: 824 - 849 MHz  
 INVESTIGATED FREQUENCY RANGE: 0.009 – 9000 MHz  
 DETECTOR USED: Peak  
 VIDEO BANDWIDTH: ≥ Resolution bandwidth  
 MODULATION: FSK  
 MODULATING SIGNAL: PRBS  
 BIT RATE: 270 kbps  
 TRANSMITTER OUTPUT POWER SETTINGS: Maximum  
 TRANSMITTER OUTPUT POWER: 30.00 dBm at low frequency  
 30.03 dBm at mid frequency  
 30.03 dBm at high frequency

Frequency, MHz	SA reading, dBm	Attenuator, dB	Cable loss, dB	RBW, kHz	Spurious emission, dBm	Attenuation below carrier, dBc	Limit, dBc	Margin, dB*	Verdict
<b>Low carrier frequency</b>									
1648.25	-31.67	Included	Included	1000	-31.67	64.67	46.00	18.67	Pass
2472.72	-29.83	Included	Included	1000	-29.83	62.83	46.00	16.83	Pass
3297.02	-39.50	Included	Included	1000	-39.50	72.50	46.00	26.50	Pass
4121.27	-58.87	Included	Included	1000	-58.87	91.87	46.00	45.87	Pass
6593.72	-57.53	Included	Included	1000	-57.53	90.53	46.00	44.53	Pass
8242.72	-54.20	Included	Included	1000	-54.20	87.20	46.00	41.20	Pass
<b>Mid carrier frequency</b>									
1673.00	-31.17	Included	Included	1000	-31.17	64.20	46.03	18.17	Pass
2509.15	-30.00	Included	Included	1000	-30.00	63.03	46.03	17.00	Pass
3345.27	-41.83	Included	Included	1000	-41.83	74.86	46.03	28.83	Pass
4181.63	-58.03	Included	Included	1000	-58.03	91.06	46.03	45.03	Pass
6690.65	-56.70	Included	Included	1000	-56.70	89.73	46.03	43.70	Pass
8364.50	-53.70	Included	Included	1000	-53.70	86.73	46.03	40.70	Pass
<b>High carrier frequency</b>									
1697.60	-31.17	Included	Included	1000	-31.17	64.20	46.03	18.17	Pass
2546.30	-31.50	Included	Included	1000	-31.50	64.53	46.03	18.50	Pass
3394.92	-48.53	Included	Included	1000	-48.53	81.56	46.03	35.53	Pass
4244.02	-57.03	Included	Included	1000	-57.03	90.06	46.03	44.03	Pass
6790.70	-55.70	Included	Included	1000	-55.70	88.73	46.03	42.70	Pass
8487.37	-55.70	Included	Included	1000	-55.70	55.70	13.00	42.70	Pass

\*- Margin = Spurious emission – specification limit.

**Reference numbers of test equipment used**

HL 1424	HL 2399	HL 2524				
---------	---------	---------	--	--	--	--

Full description is given in Appendix A.

<b>Test specification:</b>	<b>Section 22.917, Spurious emission at antenna terminal</b>		
<b>Test procedure:</b>	FCC part 22, Section 22.917		
<b>Test mode:</b>	Compliance	<b>Verdict:</b>	<b>PASS</b>
<b>Date &amp; Time:</b>	10/20/2005 4:03:01 PM		
<b>Temperature:</b> 22 °C	<b>Air Pressure:</b> 1012 hPa	<b>Relative Humidity:</b> 46 %	<b>Power Supply:</b> 4 VDC
<b>Remarks:</b>			

Plot 7.3.1 Spurious emission measurements in 9 - 150 kHz range at low carrier frequency

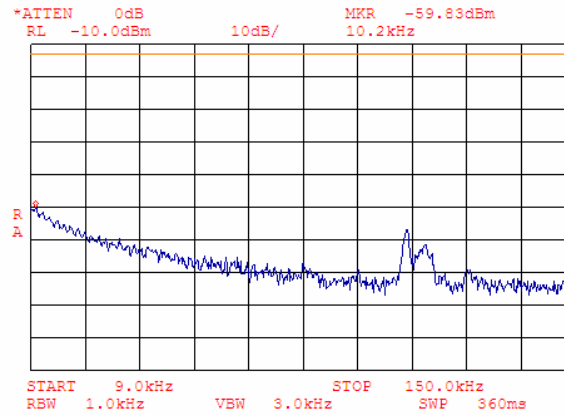

Plot 7.3.2 Spurious emission measurements in 9 - 150 kHz range at mid carrier frequency

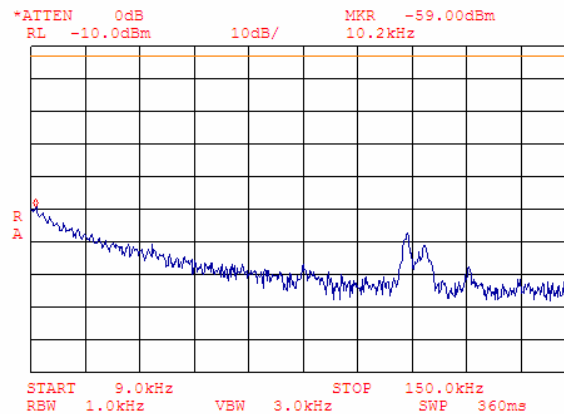

<b>Test specification:</b>	<b>Section 22.917, Spurious emission at antenna terminal</b>		
<b>Test procedure:</b>	FCC part 22, Section 22.917		
<b>Test mode:</b>	Compliance	<b>Verdict:</b>	<b>PASS</b>
<b>Date &amp; Time:</b>	10/20/2005 4:03:01 PM		
<b>Temperature:</b> 22 °C	<b>Air Pressure:</b> 1012 hPa	<b>Relative Humidity:</b> 46 %	<b>Power Supply:</b> 4 VDC
<b>Remarks:</b>			

Plot 7.3.3 Spurious emission measurements in 9 - 150 kHz range at high carrier frequency

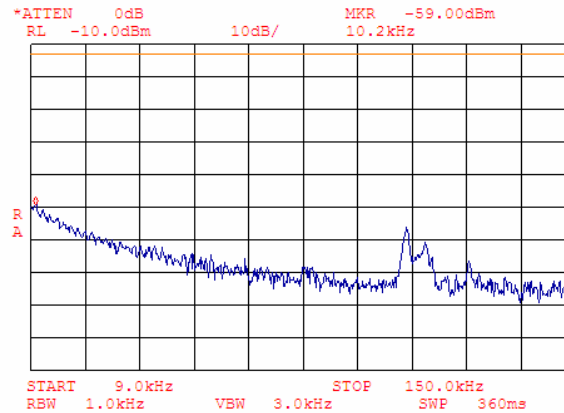

Plot 7.3.4 Spurious emission measurements in 0.15 - 30.0 MHz range at low carrier frequency

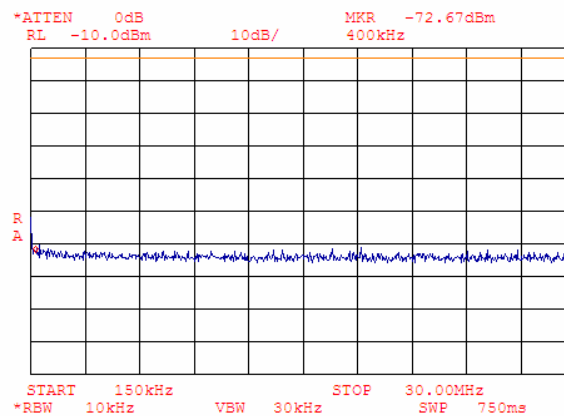

<b>Test specification:</b>	<b>Section 22.917, Spurious emission at antenna terminal</b>		
<b>Test procedure:</b>	FCC part 22, Section 22.917		
<b>Test mode:</b>	Compliance	<b>Verdict:</b>	<b>PASS</b>
<b>Date &amp; Time:</b>	10/20/2005 4:03:01 PM		
<b>Temperature:</b> 22 °C	<b>Air Pressure:</b> 1012 hPa	<b>Relative Humidity:</b> 46 %	<b>Power Supply:</b> 4 VDC
<b>Remarks:</b>			

Plot 7.3.5 Spurious emission measurements in 0.15 - 30.0 MHz range at mid carrier frequency

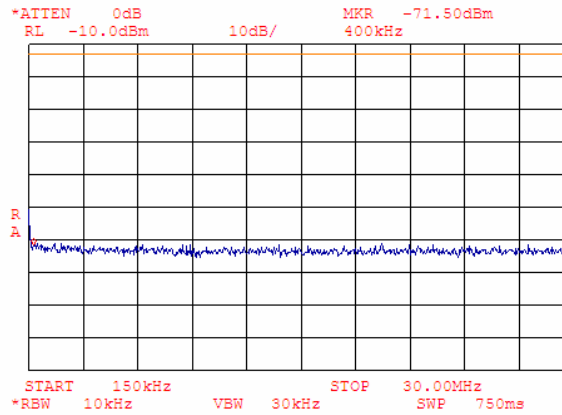

Plot 7.3.6 Spurious emission measurements in 0.15 - 30.0 MHz range at high carrier frequency

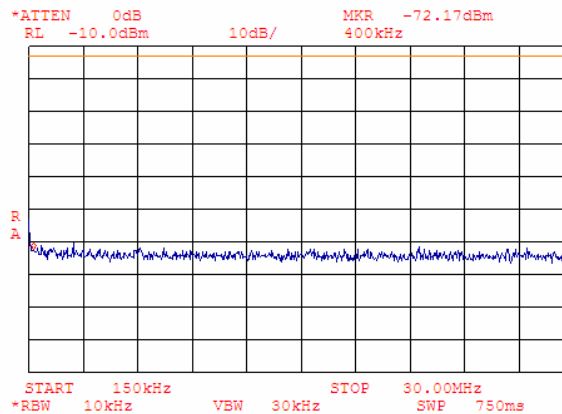

<b>Test specification:</b>	<b>Section 22.917, Spurious emission at antenna terminal</b>		
<b>Test procedure:</b>	FCC part 22, Section 22.917		
<b>Test mode:</b>	Compliance	<b>Verdict:</b>	<b>PASS</b>
<b>Date &amp; Time:</b>	10/20/2005 4:03:01 PM		
<b>Temperature:</b> 22 °C	<b>Air Pressure:</b> 1012 hPa	<b>Relative Humidity:</b> 46 %	<b>Power Supply:</b> 4 VDC
<b>Remarks:</b>			

Plot 7.3.7 Spurious emission measurements in 30.0 - 815 MHz range at low carrier frequency

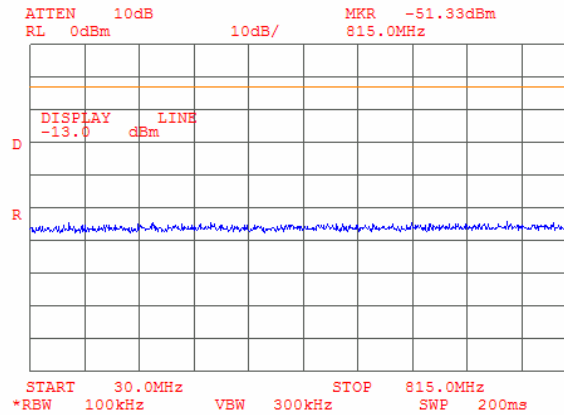

Plot 7.3.8 Spurious emission measurements in 815 - 823 MHz range at low carrier frequency

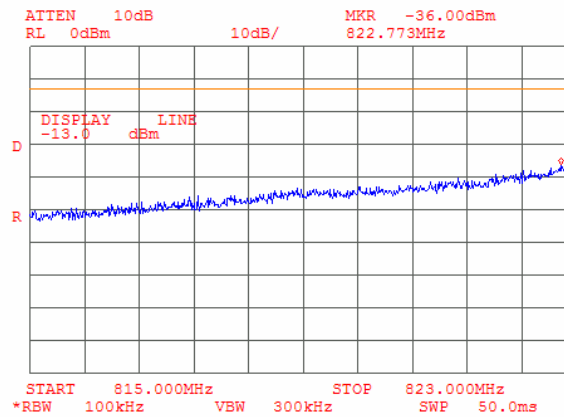

<b>Test specification:</b>	<b>Section 22.917, Spurious emission at antenna terminal</b>		
<b>Test procedure:</b>	FCC part 22, Section 22.917		
<b>Test mode:</b>	Compliance	<b>Verdict:</b>	<b>PASS</b>
<b>Date &amp; Time:</b>	10/20/2005 4:03:01 PM		
<b>Temperature:</b> 22 °C	<b>Air Pressure:</b> 1012 hPa	<b>Relative Humidity:</b> 46 %	<b>Power Supply:</b> 4 VDC
<b>Remarks:</b>			

Plot 7.3.9 Spurious emission measurements in 30.0 - 823 MHz range at mid carrier frequency

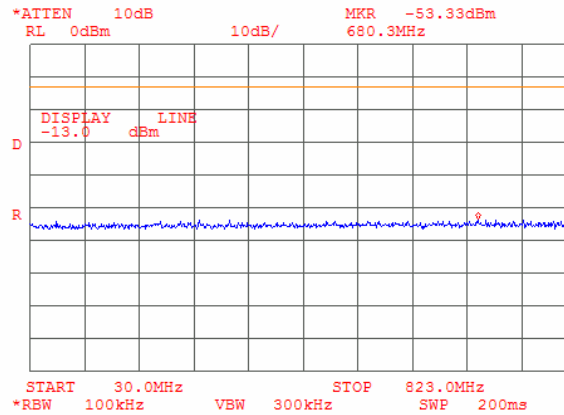

Plot 7.3.10 Spurious emission measurements in 30.0 - 823 MHz range at high carrier frequency

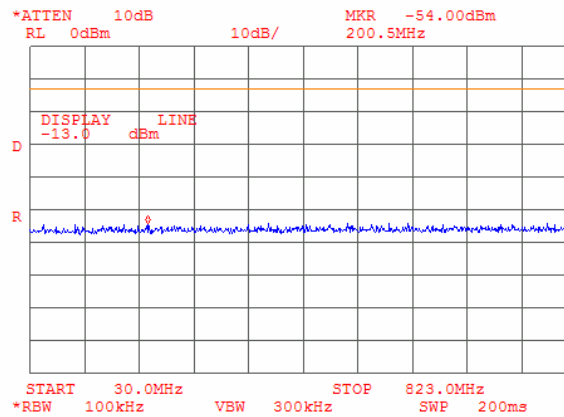

<b>Test specification:</b>	<b>Section 22.917, Spurious emission at antenna terminal</b>		
<b>Test procedure:</b>	FCC part 22, Section 22.917		
<b>Test mode:</b>	Compliance	<b>Verdict:</b>	<b>PASS</b>
<b>Date &amp; Time:</b>	10/20/2005 4:03:01 PM		
<b>Temperature:</b> 22 °C	<b>Air Pressure:</b> 1012 hPa	<b>Relative Humidity:</b> 46 %	<b>Power Supply:</b> 4 VDC
<b>Remarks:</b>			

Plot 7.3.11 Spurious emission measurements in 823 - 824 MHz range at low carrier frequency

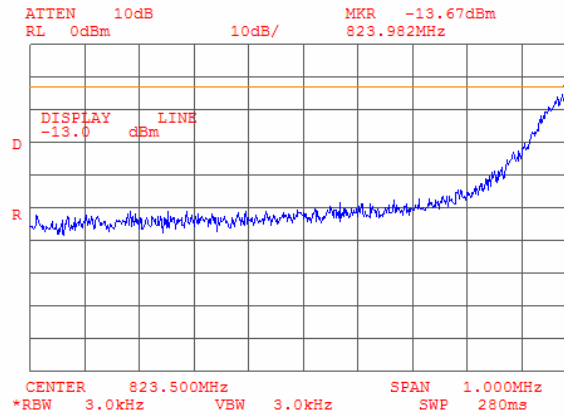

Plot 7.3.12 Spurious emission measurements in 849 - 850 MHz range at high carrier frequency

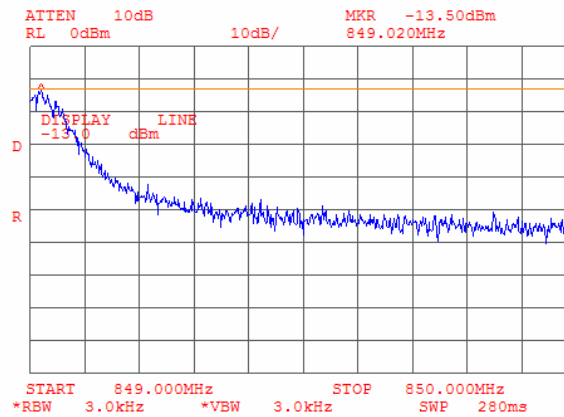



<b>Test specification:</b>	<b>Section 22.917, Spurious emission at antenna terminal</b>		
<b>Test procedure:</b>	FCC part 22, Section 22.917		
<b>Test mode:</b>	Compliance	<b>Verdict:</b>	<b>PASS</b>
<b>Date &amp; Time:</b>	10/20/2005 4:03:01 PM		
<b>Temperature:</b> 22 °C	<b>Air Pressure:</b> 1012 hPa	<b>Relative Humidity:</b> 46 %	<b>Power Supply:</b> 4 VDC
<b>Remarks:</b>			

Plot 7.3.13 Spurious emission measurements in 850 - 1000 MHz range at low carrier frequency

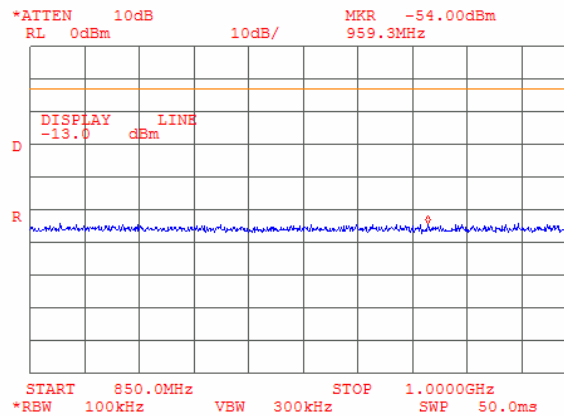

Plot 7.3.14 Spurious emission measurements in 850 - 1000 MHz range at mid carrier frequency



<b>Test specification:</b>	<b>Section 22.917, Spurious emission at antenna terminal</b>		
<b>Test procedure:</b>	FCC part 22, Section 22.917		
<b>Test mode:</b>	Compliance	<b>Verdict:</b>	<b>PASS</b>
<b>Date &amp; Time:</b>	10/20/2005 4:03:01 PM		
<b>Temperature:</b> 22 °C	<b>Air Pressure:</b> 1012 hPa	<b>Relative Humidity:</b> 46 %	<b>Power Supply:</b> 4 VDC
<b>Remarks:</b>			

Plot 7.3.15 Spurious emission measurements in 850 - 855 MHz range at high carrier frequency

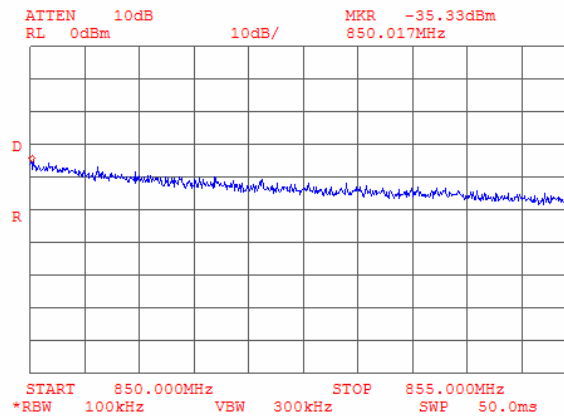

Plot 7.3.16 Spurious emission measurements in 855 - 1000 MHz range at high carrier frequency

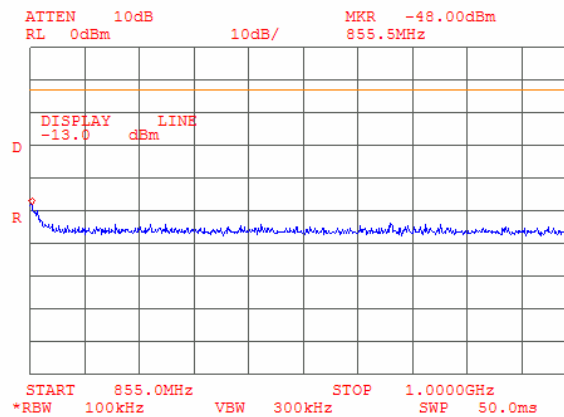

<b>Test specification:</b>	<b>Section 22.917, Spurious emission at antenna terminal</b>		
<b>Test procedure:</b>	FCC part 22, Section 22.917		
<b>Test mode:</b>	Compliance	<b>Verdict:</b>	<b>PASS</b>
<b>Date &amp; Time:</b>	10/20/2005 4:03:01 PM		
<b>Temperature:</b> 22 °C	<b>Air Pressure:</b> 1012 hPa	<b>Relative Humidity:</b> 46 %	<b>Power Supply:</b> 4 VDC
<b>Remarks:</b>			

Plot 7.3.17 Spurious emission measurements in 1000 - 9000 MHz range at low carrier frequency

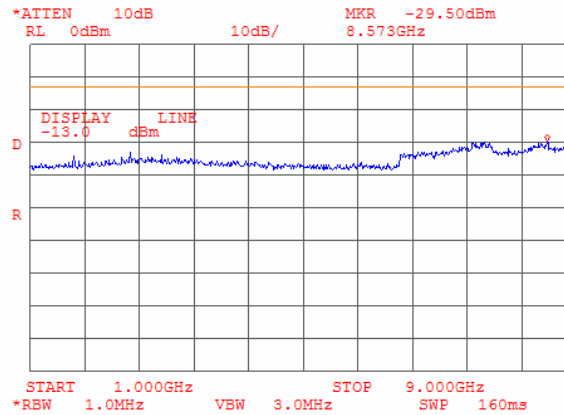

Plot 7.3.18 Spurious emission measurements in 1000 - 9000 MHz range at mid carrier frequency



<b>Test specification:</b>	<b>Section 22.917, Spurious emission at antenna terminal</b>		
<b>Test procedure:</b>	FCC part 22, Section 22.917		
<b>Test mode:</b>	Compliance	<b>Verdict:</b>	<b>PASS</b>
<b>Date &amp; Time:</b>	10/20/2005 4:03:01 PM		
<b>Temperature:</b> 22 °C	<b>Air Pressure:</b> 1012 hPa	<b>Relative Humidity:</b> 46 %	<b>Power Supply:</b> 4 VDC
<b>Remarks:</b>			

Plot 7.3.19 Spurious emission measurements in 1000 - 9000 MHz range at high carrier frequency



Plot 7.3.20 Conducted spurious emission measurements at the 2<sup>nd</sup> harmonic of low carrier frequency

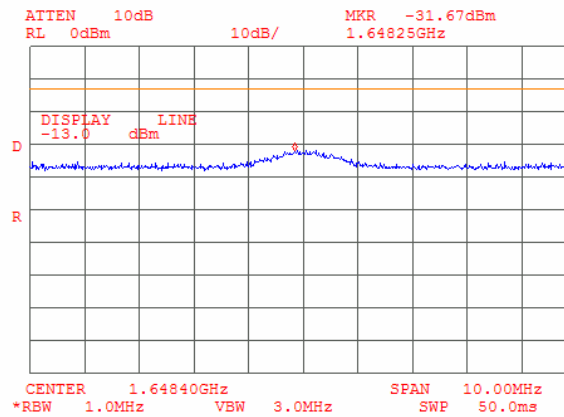

<b>Test specification:</b>	<b>Section 22.917, Spurious emission at antenna terminal</b>		
<b>Test procedure:</b>	FCC part 22, Section 22.917		
<b>Test mode:</b>	Compliance	<b>Verdict: PASS</b>	
<b>Date &amp; Time:</b>	10/20/2005 4:03:01 PM		
<b>Temperature:</b> 22 °C	<b>Air Pressure:</b> 1012 hPa	<b>Relative Humidity:</b> 46 %	<b>Power Supply:</b> 4 VDC
<b>Remarks:</b>			

Plot 7.3.21 Conducted spurious emission measurements at the 2<sup>nd</sup> harmonic of mid carrier frequency

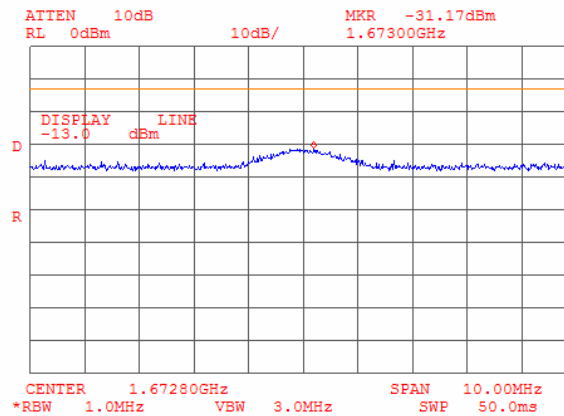

Plot 7.3.22 Conducted spurious emission measurements at the 2<sup>nd</sup> harmonic of high carrier frequency

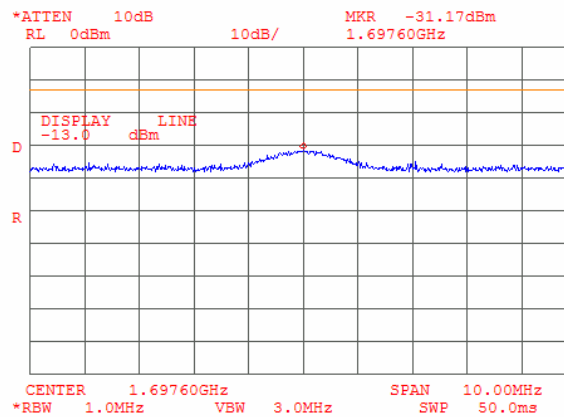

<b>Test specification:</b>	<b>Section 22.917, Spurious emission at antenna terminal</b>		
<b>Test procedure:</b>	FCC part 22, Section 22.917		
<b>Test mode:</b>	Compliance	<b>Verdict:</b>	<b>PASS</b>
<b>Date &amp; Time:</b>	10/20/2005 4:03:01 PM		
<b>Temperature:</b> 22 °C	<b>Air Pressure:</b> 1012 hPa	<b>Relative Humidity:</b> 46 %	<b>Power Supply:</b> 4 VDC
<b>Remarks:</b>			

Plot 7.3.23 Conducted spurious emission measurements at the 3<sup>rd</sup> harmonic of low carrier frequency

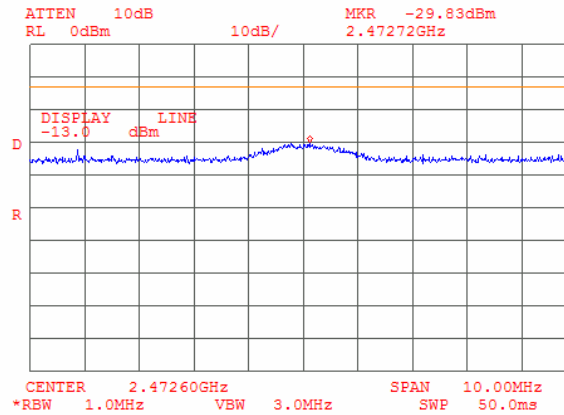

Plot 7.3.24 Conducted spurious emission measurements at the 3<sup>rd</sup> harmonic of mid carrier frequency

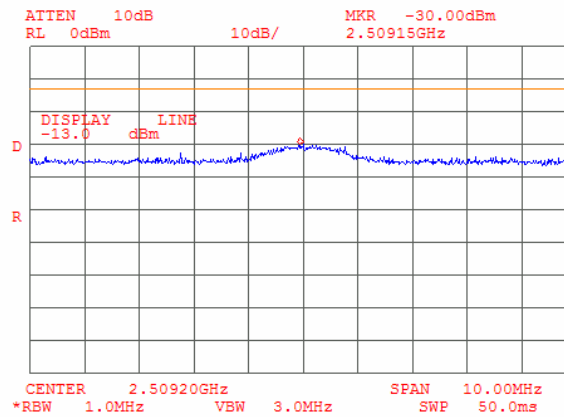

<b>Test specification:</b>	<b>Section 22.917, Spurious emission at antenna terminal</b>		
<b>Test procedure:</b>	FCC part 22, Section 22.917		
<b>Test mode:</b>	Compliance	<b>Verdict:</b>	<b>PASS</b>
<b>Date &amp; Time:</b>	10/20/2005 4:03:01 PM		
<b>Temperature:</b> 22 °C	<b>Air Pressure:</b> 1012 hPa	<b>Relative Humidity:</b> 46 %	<b>Power Supply:</b> 4 VDC
<b>Remarks:</b>			

Plot 7.3.25 Conducted spurious emission measurements at the 3<sup>rd</sup> harmonic of high carrier frequency

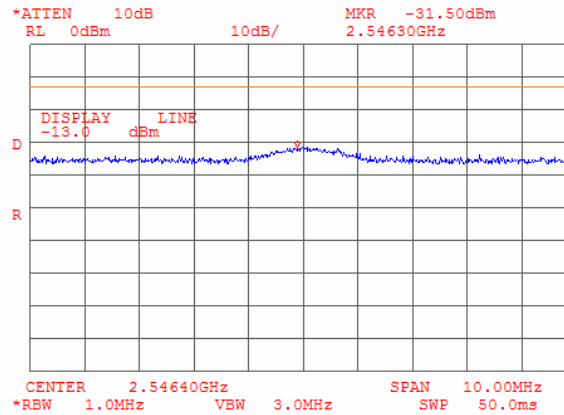

Plot 7.3.26 Conducted spurious emission measurements at the 4<sup>th</sup> harmonic of low carrier frequency

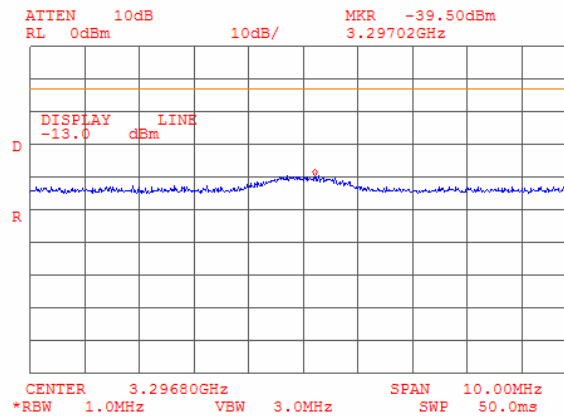

<b>Test specification:</b>	<b>Section 22.917, Spurious emission at antenna terminal</b>		
<b>Test procedure:</b>	FCC part 22, Section 22.917		
<b>Test mode:</b>	Compliance	<b>Verdict: PASS</b>	
<b>Date &amp; Time:</b>	10/20/2005 4:03:01 PM		
<b>Temperature:</b> 22 °C	<b>Air Pressure:</b> 1012 hPa	<b>Relative Humidity:</b> 46 %	<b>Power Supply:</b> 4 VDC
<b>Remarks:</b>			

Plot 7.3.27 Conducted spurious emission measurements at the 4<sup>th</sup> harmonic of mid carrier frequency

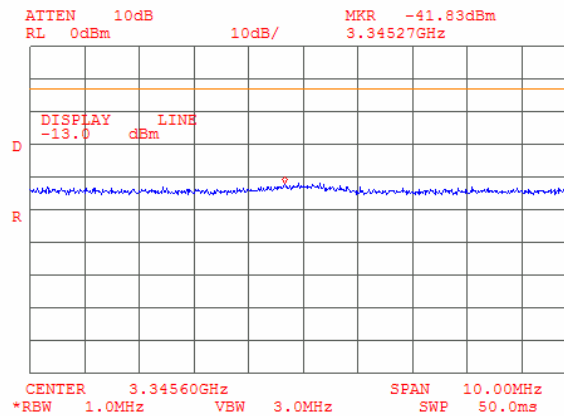

Plot 7.3.28 Conducted spurious emission measurements at the 4<sup>th</sup> harmonic of high carrier frequency

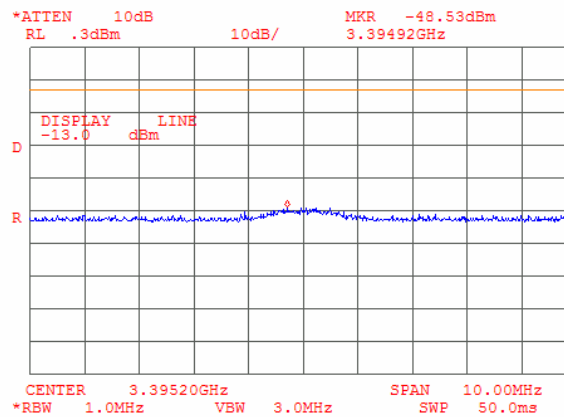



<b>Test specification:</b>	<b>Section 22.917, Spurious emission at antenna terminal</b>		
<b>Test procedure:</b>	FCC part 22, Section 22.917		
<b>Test mode:</b>	Compliance	<b>Verdict:</b>	<b>PASS</b>
<b>Date &amp; Time:</b>	10/20/2005 4:03:01 PM		
<b>Temperature:</b> 22 °C	<b>Air Pressure:</b> 1012 hPa	<b>Relative Humidity:</b> 46 %	<b>Power Supply:</b> 4 VDC
<b>Remarks:</b>			

Plot 7.3.29 Conducted spurious emission measurements at the 5<sup>th</sup> harmonic of low carrier frequency

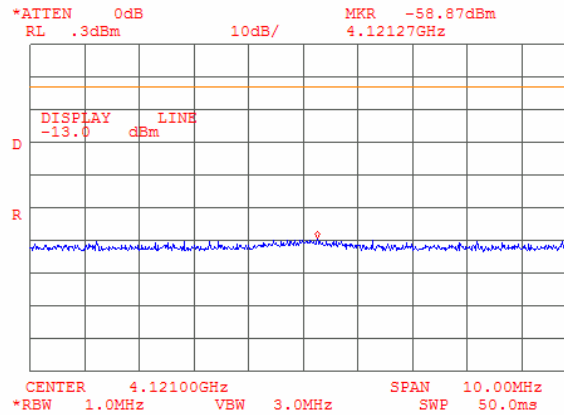

Plot 7.3.30 Conducted spurious emission measurements at the 5<sup>th</sup> harmonic of mid carrier frequency

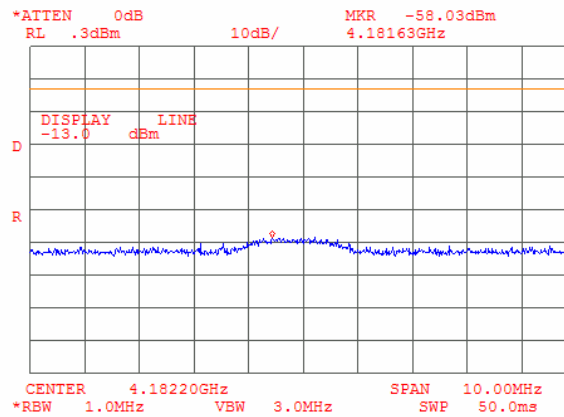

<b>Test specification:</b>	<b>Section 22.917, Spurious emission at antenna terminal</b>		
<b>Test procedure:</b>	FCC part 22, Section 22.917		
<b>Test mode:</b>	Compliance	<b>Verdict:</b>	<b>PASS</b>
<b>Date &amp; Time:</b>	10/20/2005 4:03:01 PM		
<b>Temperature:</b> 22 °C	<b>Air Pressure:</b> 1012 hPa	<b>Relative Humidity:</b> 46 %	<b>Power Supply:</b> 4 VDC
<b>Remarks:</b>			

Plot 7.3.31 Conducted spurious emission measurements at the 5<sup>th</sup> harmonic of high carrier frequency

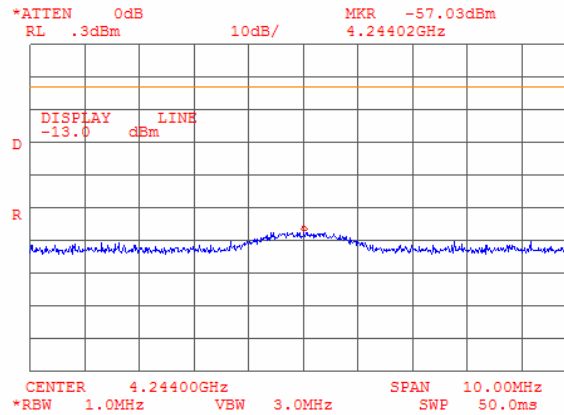

Plot 7.3.32 Conducted spurious emission measurements at the 6<sup>th</sup> harmonic of low carrier frequency

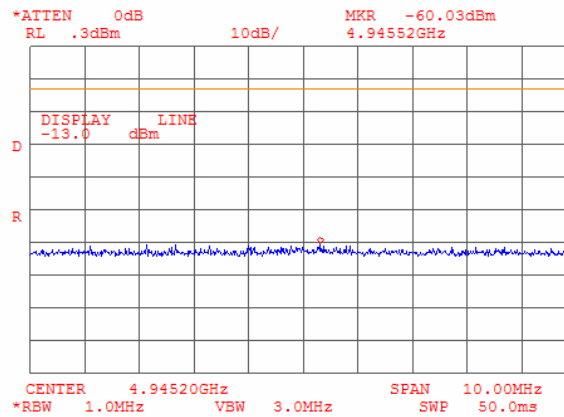

<b>Test specification:</b>	<b>Section 22.917, Spurious emission at antenna terminal</b>		
<b>Test procedure:</b>	FCC part 22, Section 22.917		
<b>Test mode:</b>	Compliance	<b>Verdict: PASS</b>	
<b>Date &amp; Time:</b>	10/20/2005 4:03:01 PM		
<b>Temperature:</b> 22 °C	<b>Air Pressure:</b> 1012 hPa	<b>Relative Humidity:</b> 46 %	<b>Power Supply:</b> 4 VDC
<b>Remarks:</b>			

Plot 7.3.33 Conducted spurious emission measurements at the 6<sup>th</sup> harmonic of mid carrier frequency

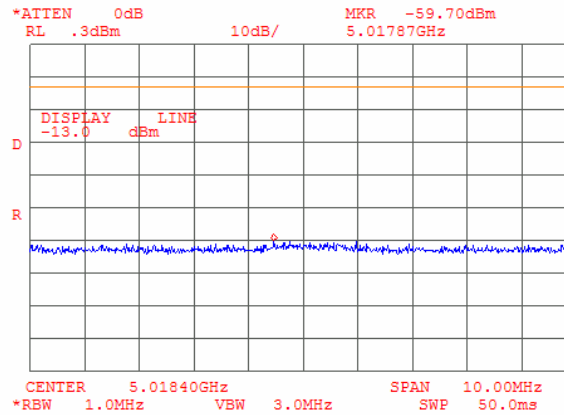

Plot 7.3.34 Conducted spurious emission measurements at the 6<sup>th</sup> harmonic of high carrier frequency

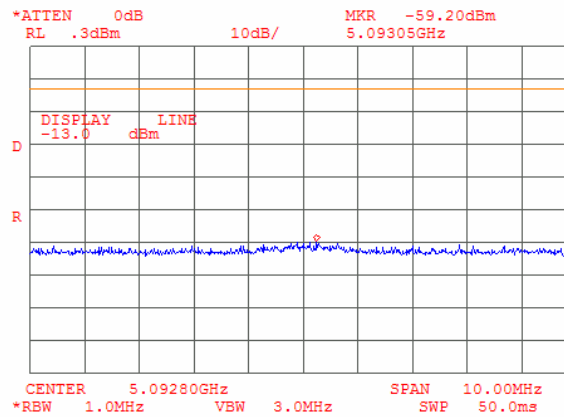

<b>Test specification:</b>	<b>Section 22.917, Spurious emission at antenna terminal</b>		
<b>Test procedure:</b>	FCC part 22, Section 22.917		
<b>Test mode:</b>	Compliance	<b>Verdict:</b>	<b>PASS</b>
<b>Date &amp; Time:</b>	10/20/2005 4:03:01 PM		
<b>Temperature:</b> 22 °C	<b>Air Pressure:</b> 1012 hPa	<b>Relative Humidity:</b> 46 %	<b>Power Supply:</b> 4 VDC
<b>Remarks:</b>			

Plot 7.3.35 Conducted spurious emission measurements at the 7<sup>th</sup> harmonic of low carrier frequency

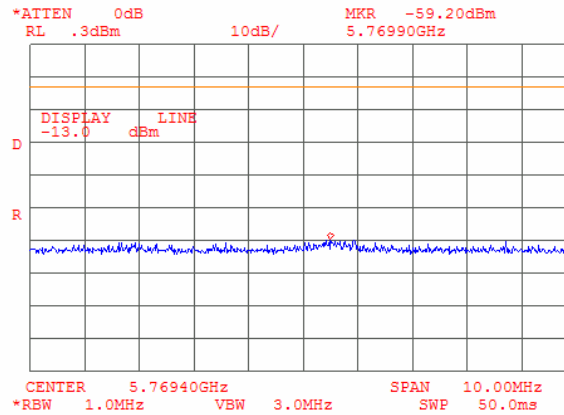

Plot 7.3.36 Conducted spurious emission measurements at the 7<sup>th</sup> harmonic of mid carrier frequency

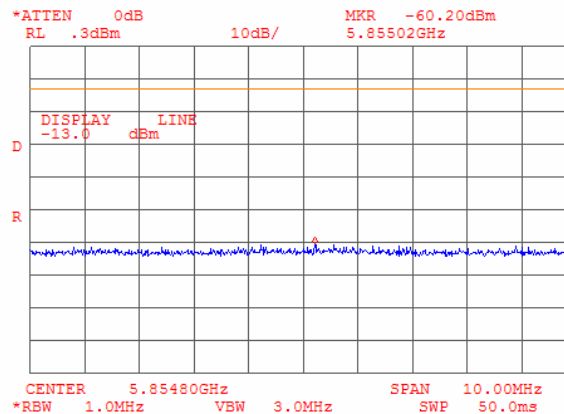

<b>Test specification:</b>	<b>Section 22.917, Spurious emission at antenna terminal</b>		
<b>Test procedure:</b>	FCC part 22, Section 22.917		
<b>Test mode:</b>	Compliance	<b>Verdict:</b>	<b>PASS</b>
<b>Date &amp; Time:</b>	10/20/2005 4:03:01 PM		
<b>Temperature:</b> 22 °C	<b>Air Pressure:</b> 1012 hPa	<b>Relative Humidity:</b> 46 %	<b>Power Supply:</b> 4 VDC
<b>Remarks:</b>			

Plot 7.3.37 Conducted spurious emission measurements at the 7<sup>th</sup> harmonic of high carrier frequency

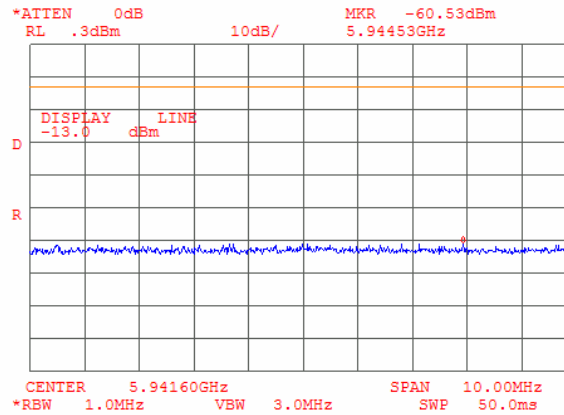

Plot 7.3.38 Conducted spurious emission measurements at the 8<sup>th</sup> harmonic of low carrier frequency

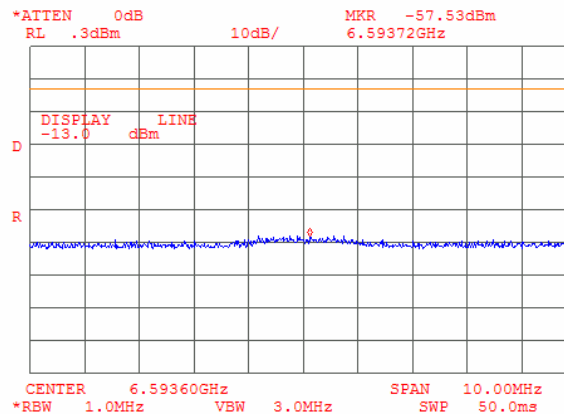

<b>Test specification:</b>	<b>Section 22.917, Spurious emission at antenna terminal</b>		
<b>Test procedure:</b>	FCC part 22, Section 22.917		
<b>Test mode:</b>	Compliance	<b>Verdict:</b>	<b>PASS</b>
<b>Date &amp; Time:</b>	10/20/2005 4:03:01 PM		
<b>Temperature:</b> 22 °C	<b>Air Pressure:</b> 1012 hPa	<b>Relative Humidity:</b> 46 %	<b>Power Supply:</b> 4 VDC
<b>Remarks:</b>			

Plot 7.3.39 Conducted spurious emission measurements at the 8<sup>th</sup> harmonic of mid carrier frequency

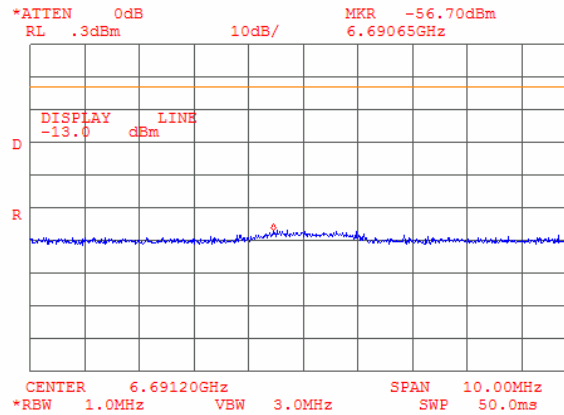

Plot 7.3.40 Conducted spurious emission measurements at the 8<sup>th</sup> harmonic of high carrier frequency

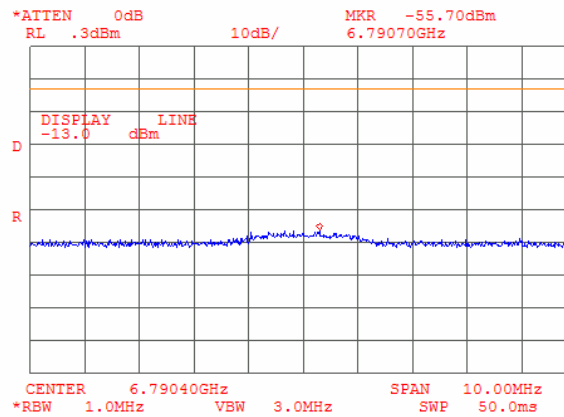

<b>Test specification:</b>	<b>Section 22.917, Spurious emission at antenna terminal</b>		
<b>Test procedure:</b>	FCC part 22, Section 22.917		
<b>Test mode:</b>	Compliance	<b>Verdict:</b>	<b>PASS</b>
<b>Date &amp; Time:</b>	10/20/2005 4:03:01 PM		
<b>Temperature:</b> 22 °C	<b>Air Pressure:</b> 1012 hPa	<b>Relative Humidity:</b> 46 %	<b>Power Supply:</b> 4 VDC
<b>Remarks:</b>			

Plot 7.3.41 Conducted spurious emission measurements at the 9<sup>th</sup> harmonic of low carrier frequency

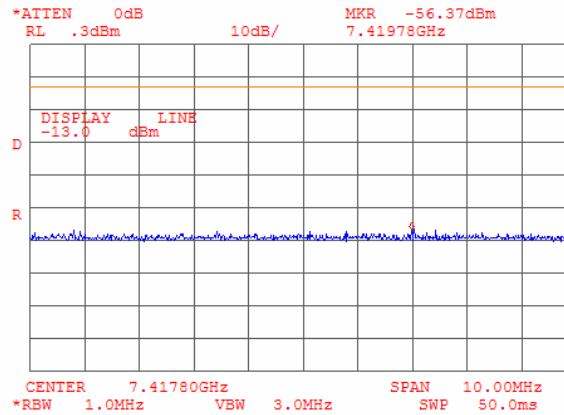

Plot 7.3.42 Conducted spurious emission measurements at the 9<sup>th</sup> harmonic of mid carrier frequency

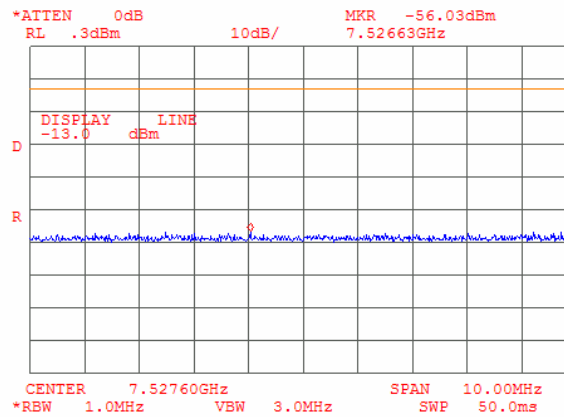

<b>Test specification:</b>	<b>Section 22.917, Spurious emission at antenna terminal</b>		
<b>Test procedure:</b>	FCC part 22, Section 22.917		
<b>Test mode:</b>	Compliance	<b>Verdict:</b>	<b>PASS</b>
<b>Date &amp; Time:</b>	10/20/2005 4:03:01 PM		
<b>Temperature:</b> 22 °C	<b>Air Pressure:</b> 1012 hPa	<b>Relative Humidity:</b> 46 %	<b>Power Supply:</b> 4 VDC
<b>Remarks:</b>			

Plot 7.3.43 Conducted spurious emission measurements at the 9<sup>th</sup> harmonic of high carrier frequency

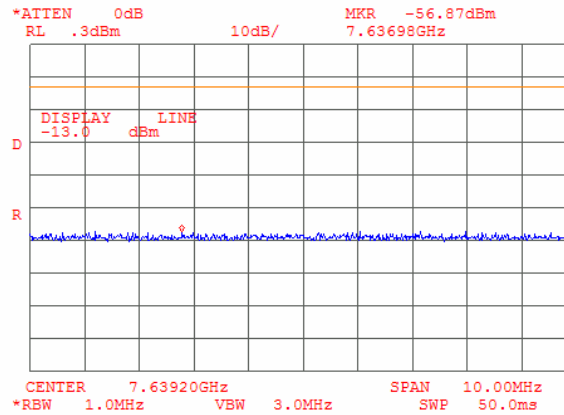

Plot 7.3.44 Conducted spurious emission measurements at the 10<sup>th</sup> harmonic of low carrier frequency

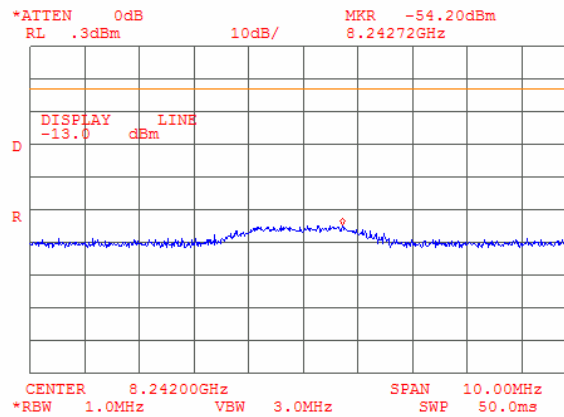



<b>Test specification:</b>	<b>Section 22.917, Spurious emission at antenna terminal</b>		
<b>Test procedure:</b>	FCC part 22, Section 22.917		
<b>Test mode:</b>	Compliance	<b>Verdict:</b>	<b>PASS</b>
<b>Date &amp; Time:</b>	10/20/2005 4:03:01 PM		
<b>Temperature:</b> 22 °C	<b>Air Pressure:</b> 1012 hPa	<b>Relative Humidity:</b> 46 %	<b>Power Supply:</b> 4 VDC
<b>Remarks:</b>			

Plot 7.3.45 Conducted spurious emission measurements at the 10<sup>th</sup> harmonic of mid carrier frequency

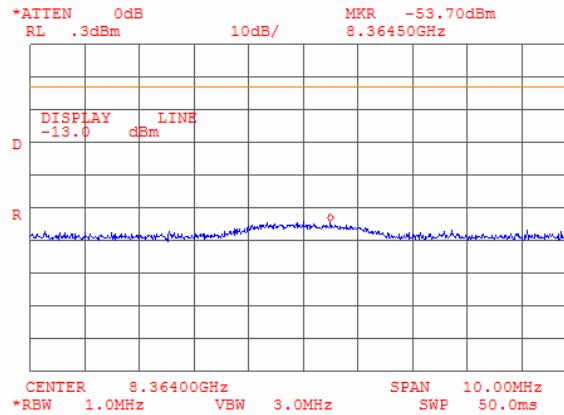

Plot 7.3.46 Conducted spurious emission measurements at the 10<sup>th</sup> harmonic of high carrier frequency

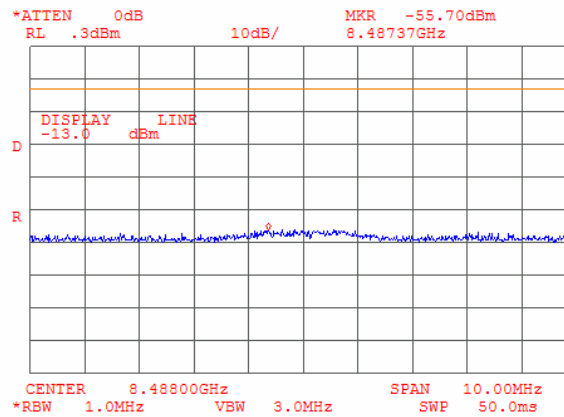

<b>Test specification:</b>	<b>Section 22.917, Radiated spurious emissions</b>		
<b>Test procedure:</b>	FCC part 22, Section 22.917		
<b>Test mode:</b>	Compliance	<b>Verdict:</b>	<b>PASS</b>
<b>Date &amp; Time:</b>	10/16/2005 3:30:32 PM		
<b>Temperature:</b> 24 °C	<b>Air Pressure:</b> 1012 hPa	<b>Relative Humidity:</b> 45 %	<b>Power Supply:</b> 4 VDC
<b>Remarks:</b>			

## 7.4 Field strength of spurious emissions

### 7.4.1 General

This test was performed to measure field strength of spurious emissions from the EUT. Specification test limit is given in Table 7.4.1.

**Table 7.4.1 Radiated spurious emissions limits**

Frequency, MHz	Attenuation below carrier, dBc	ERP of spurious, dBm	Equivalent field strength limit @ 3m, dB( $\mu$ V/m)**
0.009 – 10 <sup>th</sup> harmonic	43+10logP*	-13	84.4

\* - P is transmitter output power in Watts.

\*\* - Equivalent field strength limit was calculated from maximum allowed ERP of spurious as follows:  $E = \sqrt{30 \times P \times 1.64} / r$ , where P is ERP in Watts, 1.64 is numeric gain of ideal dipole and r is antenna to EUT distance in meters.

### 7.4.2 Test procedure for spurious emission field strength measurements in 9 kHz to 30 MHz band

7.4.2.1 The EUT was set up as shown in Figure 7.4.1, energized and the performance check was conducted.

7.4.2.2 The specified frequency range was investigated with antenna connected to spectrum analyzer/ EMI receiver. To find maximum radiation the turntable was rotated 360° and the measuring antenna was rotated around its vertical axis.

7.4.2.3 The worst test results (the lowest margins) were recorded and shown in the associated plots.

### 7.4.3 Test procedure for spurious emission field strength measurements above 30 MHz

7.4.3.1 The EUT was set up as shown in Figure 7.4.2, energized and the performance check was conducted.

7.4.3.2 The specified frequency range was investigated with antenna connected to spectrum analyzer/ EMI receiver. To find maximum radiation the turntable was rotated 360°, the measuring antenna height was changed from 1 to 4 m, its polarization was switched from vertical to horizontal.

7.4.3.3 The worst test results (the lowest margins) were recorded and shown in the associated plots.

<b>Test specification:</b> Section 22.917, Radiated spurious emissions			
<b>Test procedure:</b> FCC part 22, Section 22.917			
<b>Test mode:</b> Compliance	<b>Verdict:</b> PASS		
<b>Date &amp; Time:</b> 10/16/2005 3:30:32 PM			
<b>Temperature:</b> 24 °C	<b>Air Pressure:</b> 1012 hPa	<b>Relative Humidity:</b> 45 %	<b>Power Supply:</b> 4 VDC
<b>Remarks:</b>			

Figure 7.4.1 Setup for spurious emission field strength measurements below 30 MHz

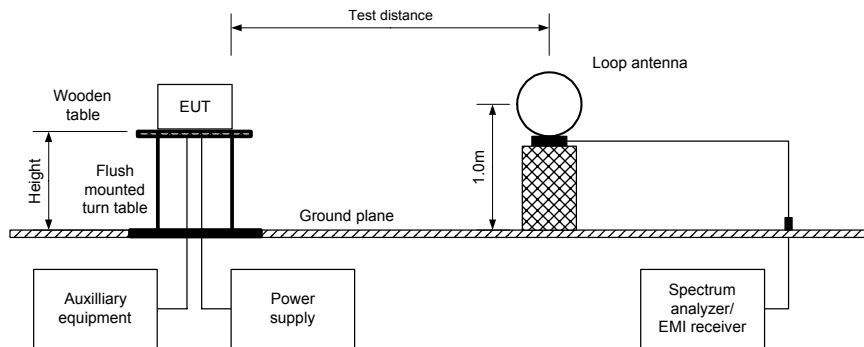
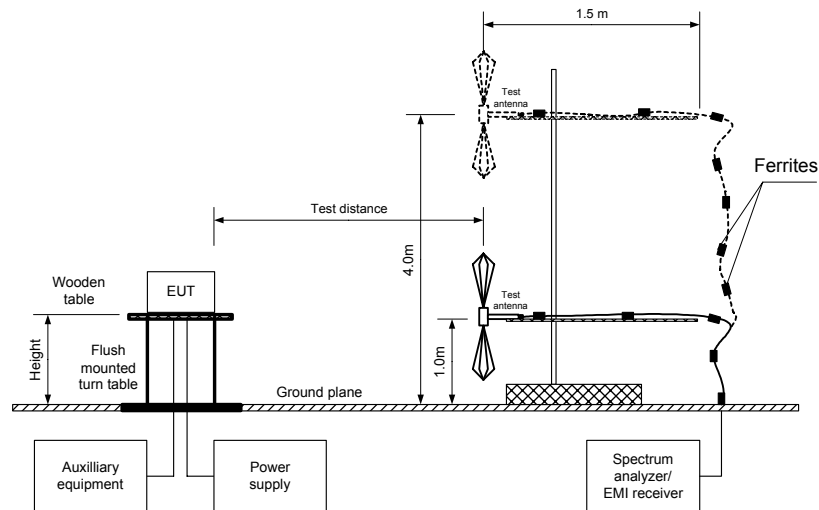

Figure 7.4.2 Setup for spurious emission field strength measurements above 30 MHz



<b>Test specification: Section 22.917, Radiated spurious emissions</b>			
<b>Test procedure:</b> FCC part 22, Section 22.917			
<b>Test mode:</b> Compliance		<b>Verdict: PASS</b>	
<b>Date &amp; Time:</b> 10/16/2005 3:30:32 PM			
<b>Temperature:</b> 24 °C	<b>Air Pressure:</b> 1012 hPa	<b>Relative Humidity:</b> 45 %	<b>Power Supply:</b> 4 VDC
<b>Remarks:</b>			

**Table 7.4.2 Field strength of emissions**

ASSIGNED FREQUENCY RANGE: 824 - 850 MHz  
 INVESTIGATED FREQUENCY RANGE: 0.009 – 9000 MHz  
 TEST DISTANCE: 3 m  
 MODULATION: Modulated  
 DUTY CYCLE: 100 %  
 TRANSMITTER OUTPUT POWER SETTINGS: Maximum  
 TRANSMITTER OUTPUT POWER: 33.00 dBm at low carrier frequency  
 33.03 dBm at mid carrier frequency  
 33.03 dBm at high carrier frequency

DETECTOR USED: Peak  
 TEST ANTENNA TYPE: Active loop (9 kHz – 30 MHz)  
 Biconilog (30 MHz – 1000 MHz)  
 Double ridged guide (above 1000 MHz)

Frequency, MHz	Field strength of spurious, dB(μV/m)	Limit, dB(μV/m)	Margin, dB	Antenna polarization	Antenna height, m	Azimuth, degrees*
<b>Low carrier frequency</b>						
1648.33	46.34	84.38	-38.04	Vertical	1.0	110
2472.58	48.61	84.38	-35.77	Vertical	1.0	98
<b>Mid carrier frequency</b>						
1672.9	46.71	84.38	-37.67	Vertical	1.1	102
2509.1	47.51	84.38	-36.87	Vertical	1.0	89
<b>High carrier frequency</b>						
No spurious emissions were found						

\*- EUT front panel refers to 0 degrees position of turntable.  
 \*\*- Margin = Attenuation below carrier – specification limit.

**Table 7.4.3 Substitution method**

ASSIGNED FREQUENCY: 824 - 849 MHz  
 INVESTIGATED FREQUENCY RANGE: 30 – 9000 MHz  
 TEST DISTANCE: 3 m  
 RESOLUTION BANDWIDTH: 1 MHz (above 1000 MHz)  
 VIDEO BANDWIDTH: > Resolution bandwidth  
 TEST ANTENNA TYPE: Double ridged guide (above 1000 MHz)

Frequency, MHz	Field strength, dB(μV/m)	Antenna polarization	RF generator output, dBm	Ant gain, dBd	Cable loss, dB	ERP, dBm	Atten. below carrier, dBc	Limit, dBc	Margin, dB*	Verdict
<b>Low carrier frequency</b>										
1648.33	46.34	Vertical	-56.52	6.8	3.4	-53.12	-86.12	-46.0	-40.12	Pass
2472.58	48.61	Vertical	-54.21	7.4	4.2	-51.01	-84.01	-46.0	-38.01	Pass
<b>Mid carrier frequency</b>										
1672.9	46.71	Vertical	-54.94	6.8	3.4	-51.54	-84.54	-46.3	-38.24	Pass
2509.1	47.51	Vertical	-54.6	7.4	4.2	-51.40	-84.40	-46.3	-38.10	Pass

\*- Margin = Attenuation below carrier - limit.

**Reference numbers of test equipment used**

HL 0410	HL 0446	HL 0521	HL 0589	HL 0592	HL 0593	HL 0594	HL 0604
HL 0768	HL 1200	HL 1424	HL 1942	HL 1947	HL 1984	HL 2009	HL 2259
HL 2260	HL 2387	HL 2399					

Full description is given in Appendix A.

<b>Test specification:</b> Section 22.917, Radiated spurious emissions			
<b>Test procedure:</b> FCC part 22, Section 22.917			
<b>Test mode:</b> Compliance	<b>Verdict:</b> PASS		
<b>Date &amp; Time:</b> 10/16/2005 3:30:32 PM			
<b>Temperature:</b> 24 °C	<b>Air Pressure:</b> 1012 hPa	<b>Relative Humidity:</b> 45 %	<b>Power Supply:</b> 4 VDC
<b>Remarks:</b>			

**Plot 7.4.1 Radiated emission measurements from 9 to 150 kHz at the low carrier frequency**

TEST SITE: Semi anechoic chamber  
TEST DISTANCE: 3 m  
ANTENNA POLARIZATION: Vertical

10:04:48 OCT 17, 2005

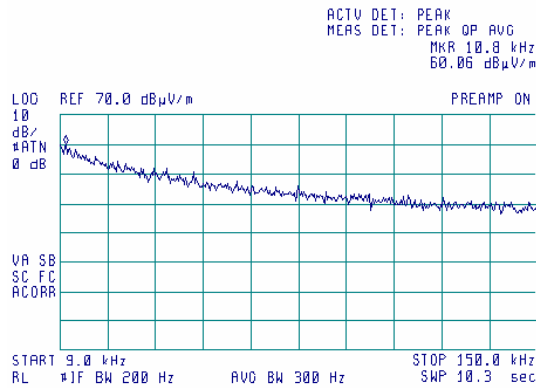

**Plot 7.4.2 Radiated emission measurements from 9 to 150 kHz at the mid carrier frequency**

TEST SITE: Semi anechoic chamber  
TEST DISTANCE: 3 m  
ANTENNA POLARIZATION: Vertical

10:16:26 OCT 17, 2005

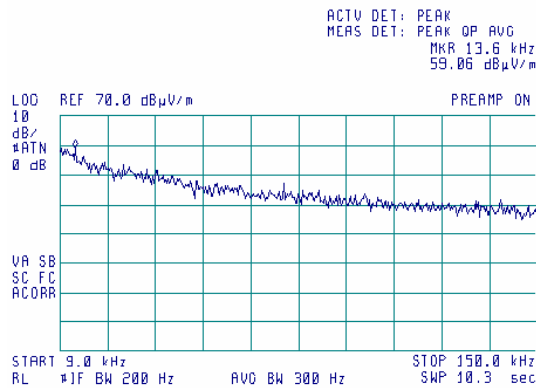

<b>Test specification:</b> Section 22.917, Radiated spurious emissions			
<b>Test procedure:</b> FCC part 22, Section 22.917			
<b>Test mode:</b> Compliance	<b>Verdict:</b> PASS		
<b>Date &amp; Time:</b> 10/16/2005 3:30:32 PM			
<b>Temperature:</b> 24 °C	<b>Air Pressure:</b> 1012 hPa	<b>Relative Humidity:</b> 45 %	<b>Power Supply:</b> 4 VDC
<b>Remarks:</b>			

**Plot 7.4.3 Radiated emission measurements from 9 to 150 kHz at the high carrier frequency**

TEST SITE: Semi anechoic chamber  
TEST DISTANCE: 3 m  
ANTENNA POLARIZATION: Vertical

10:19:00 OCT 17, 2005

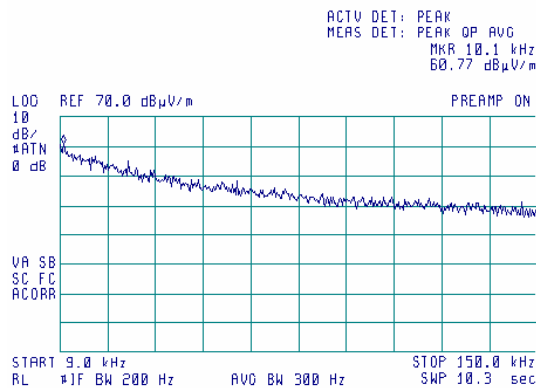

**Plot 7.4.4 Radiated emission measurements from 0.15 to 30 MHz at the low carrier frequency**

TEST SITE: Semi anechoic chamber  
TEST DISTANCE: 3 m  
ANTENNA POLARIZATION: Vertical

10:00:17 OCT 17, 2005

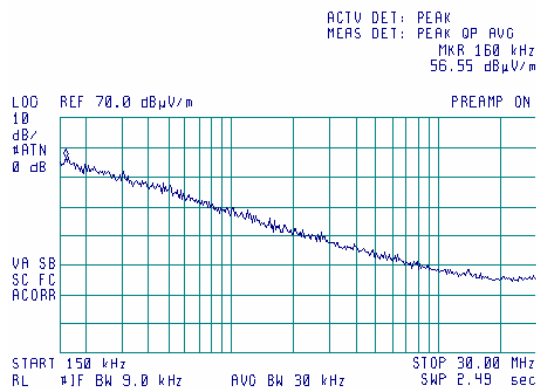

<b>Test specification:</b>	<b>Section 22.917, Radiated spurious emissions</b>		
<b>Test procedure:</b>	FCC part 22, Section 22.917		
<b>Test mode:</b>	Compliance	<b>Verdict:</b>	<b>PASS</b>
<b>Date &amp; Time:</b>	10/16/2005 3:30:32 PM		
<b>Temperature:</b> 24 °C	<b>Air Pressure:</b> 1012 hPa	<b>Relative Humidity:</b> 45 %	<b>Power Supply:</b> 4 VDC
<b>Remarks:</b>			

**Plot 7.4.5 Radiated emission measurements from 0.15 to 30 MHz at the mid carrier frequency**

TEST SITE: Semi anechoic chamber  
TEST DISTANCE: 3 m  
ANTENNA POLARIZATION: Vertical

10:13:27 OCT 17, 2005

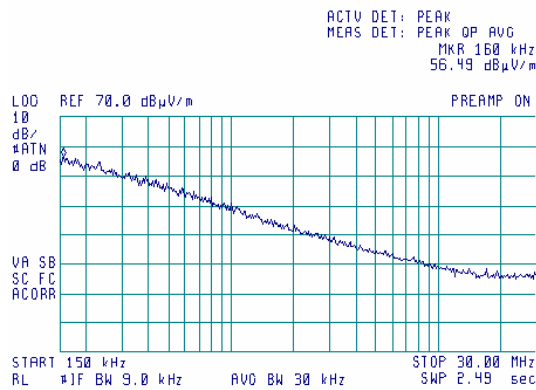

**Plot 7.4.6 Radiated emission measurements from 0.15 to 30 MHz at the high carrier frequency**

TEST SITE: Semi anechoic chamber  
TEST DISTANCE: 3 m  
ANTENNA POLARIZATION: Vertical

10:22:05 OCT 17, 2005

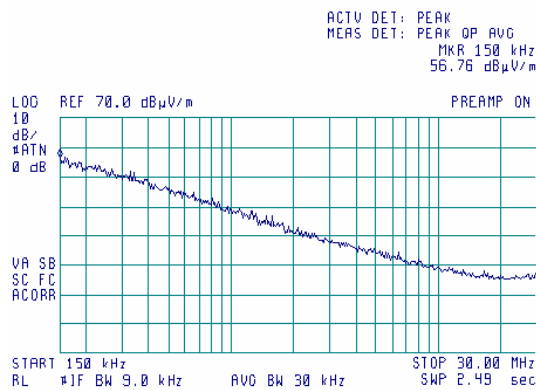

<b>Test specification:</b> Section 22.917, Radiated spurious emissions			
<b>Test procedure:</b> FCC part 22, Section 22.917			
<b>Test mode:</b> Compliance	<b>Verdict:</b> PASS		
<b>Date &amp; Time:</b> 10/16/2005 3:30:32 PM			
<b>Temperature:</b> 24 °C	<b>Air Pressure:</b> 1012 hPa	<b>Relative Humidity:</b> 45 %	<b>Power Supply:</b> 4 VDC
<b>Remarks:</b>			

**Plot 7.4.7 Radiated emission measurements from 30 to 1000 MHz at the low carrier frequency**

TEST SITE: Semi anechoic chamber  
TEST DISTANCE: 3 m  
ANTENNA POLARIZATION: Vertical and Horizontal

14:29:36 OCT 16, 2005

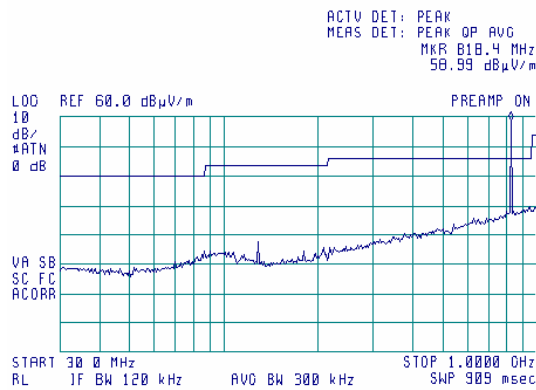

**Plot 7.4.8 Radiated emission measurements from 30 to 1000 MHz at the mid carrier frequency**

TEST SITE: Semi anechoic chamber  
TEST DISTANCE: 3 m  
ANTENNA POLARIZATION: Vertical and Horizontal

14:34:45 OCT 16, 2005

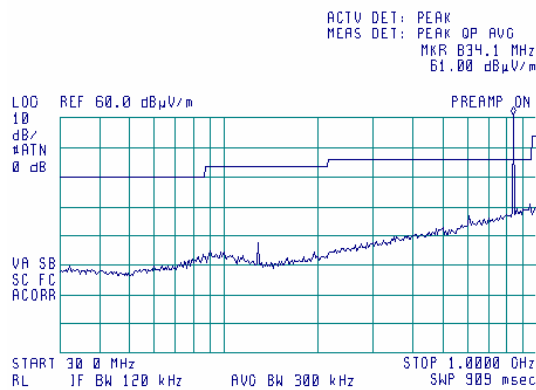



<b>Test specification:</b> Section 22.917, Radiated spurious emissions			
<b>Test procedure:</b> FCC part 22, Section 22.917			
<b>Test mode:</b> Compliance	<b>Verdict:</b> PASS		
<b>Date &amp; Time:</b> 10/16/2005 3:30:32 PM			
<b>Temperature:</b> 24 °C	<b>Air Pressure:</b> 1012 hPa	<b>Relative Humidity:</b> 45 %	<b>Power Supply:</b> 4 VDC
<b>Remarks:</b>			

**Plot 7.4.9 Radiated emission measurements from 30 to 1000 MHz at the high carrier frequency**

TEST SITE: Semi anechoic chamber  
TEST DISTANCE: 3 m  
ANTENNA POLARIZATION: Vertical and Horizontal

14:41:59 OCT 16, 2005

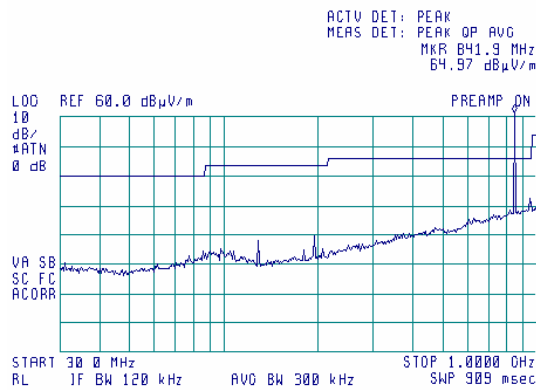

**Plot 7.4.10 Radiated emission measurements from 1000 to 2900 MHz at the low carrier frequency**

TEST SITE: Semi anechoic chamber  
TEST DISTANCE: 3 m  
ANTENNA POLARIZATION: Vertical and Horizontal

16:31:13 OCT 16, 2005

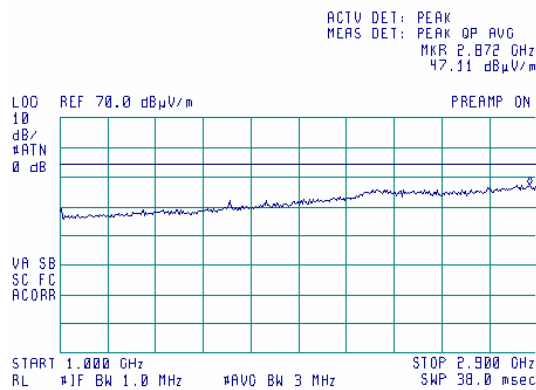

<b>Test specification:</b>	<b>Section 22.917, Radiated spurious emissions</b>		
<b>Test procedure:</b>	FCC part 22, Section 22.917		
<b>Test mode:</b>	Compliance	<b>Verdict:</b>	<b>PASS</b>
<b>Date &amp; Time:</b>	10/16/2005 3:30:32 PM		
<b>Temperature:</b> 24 °C	<b>Air Pressure:</b> 1012 hPa	<b>Relative Humidity:</b> 45 %	<b>Power Supply:</b> 4 VDC
<b>Remarks:</b>			

**Plot 7.4.11 Radiated emission measurements from 1000 to 2900 MHz at the mid carrier frequency**

TEST SITE: Semi anechoic chamber  
TEST DISTANCE: 3 m  
ANTENNA POLARIZATION: Vertical and Horizontal

16:21:58 OCT 16, 2005

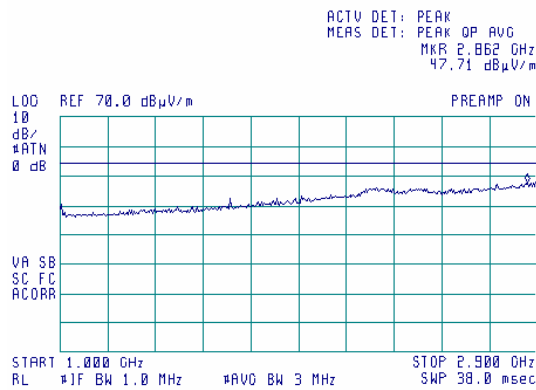

**Plot 7.4.12 Radiated emission measurements from 1000 to 2900 MHz at the high carrier frequency**

TEST SITE: Semi anechoic chamber  
TEST DISTANCE: 3 m  
ANTENNA POLARIZATION: Vertical and Horizontal

16:34:51 OCT 16, 2005

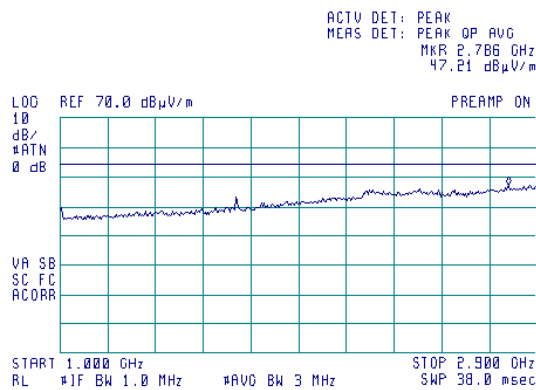

<b>Test specification:</b>	<b>Section 22.917, Radiated spurious emissions</b>		
<b>Test procedure:</b>	FCC part 22, Section 22.917		
<b>Test mode:</b>	Compliance	<b>Verdict:</b>	<b>PASS</b>
<b>Date &amp; Time:</b>	10/16/2005 3:30:32 PM		
<b>Temperature:</b> 24 °C	<b>Air Pressure:</b> 1012 hPa	<b>Relative Humidity:</b> 45 %	<b>Power Supply:</b> 4 VDC
<b>Remarks:</b>			

**Plot 7.4.13 Radiated emission measurements from 2900 to 6500 MHz at the low carrier frequency**

TEST SITE: Semi anechoic chamber  
TEST DISTANCE: 3 m  
ANTENNA POLARIZATION: Vertical and Horizontal

16:14:58 OCT 16, 2005

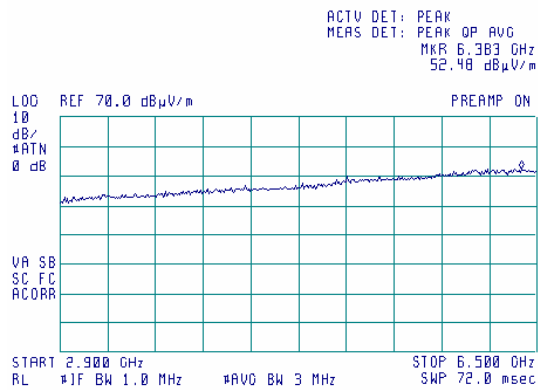

**Plot 7.4.14 Radiated emission measurements from 2900 to 6500 MHz at the mid carrier frequency**

TEST SITE: Semi anechoic chamber  
TEST DISTANCE: 3 m  
ANTENNA POLARIZATION: Vertical and Horizontal

16:17:33 OCT 16, 2005

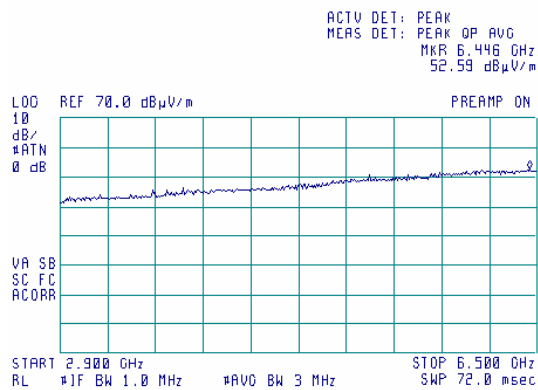

<b>Test specification:</b>	<b>Section 22.917, Radiated spurious emissions</b>		
<b>Test procedure:</b>	FCC part 22, Section 22.917		
<b>Test mode:</b>	Compliance	<b>Verdict:</b>	<b>PASS</b>
<b>Date &amp; Time:</b>	10/16/2005 3:30:32 PM		
<b>Temperature:</b> 24 °C	<b>Air Pressure:</b> 1012 hPa	<b>Relative Humidity:</b> 45 %	<b>Power Supply:</b> 4 VDC
<b>Remarks:</b>			

**Plot 7.4.15 Radiated emission measurements from 2900 to 6500 MHz at the high carrier frequency**

TEST SITE: Semi anechoic chamber  
TEST DISTANCE: 3 m  
ANTENNA POLARIZATION: Vertical and Horizontal

16:36:54 OCT 16, 2005

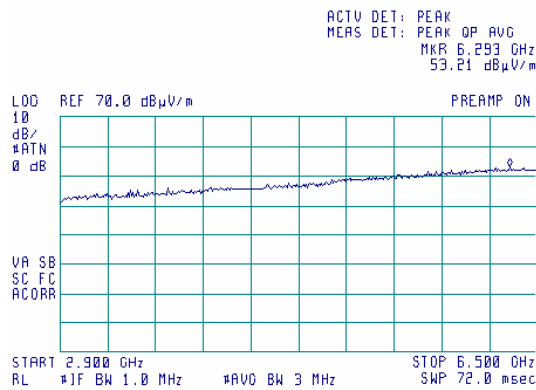

**Plot 7.4.16 Radiated emission measurements from 6.5 to 9 GHz at the low carrier frequency**

TEST SITE: Semi anechoic chamber  
TEST DISTANCE: 3 m  
ANTENNA POLARIZATION: Vertical and Horizontal

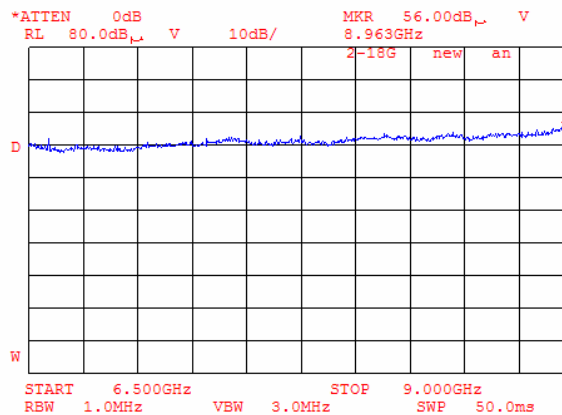

<b>Test specification:</b>	<b>Section 22.917, Radiated spurious emissions</b>		
<b>Test procedure:</b>	FCC part 22, Section 22.917		
<b>Test mode:</b>	Compliance	<b>Verdict:</b>	<b>PASS</b>
<b>Date &amp; Time:</b>	10/16/2005 3:30:32 PM		
<b>Temperature:</b> 24 °C	<b>Air Pressure:</b> 1012 hPa	<b>Relative Humidity:</b> 45 %	<b>Power Supply:</b> 4 VDC
<b>Remarks:</b>			

**Plot 7.4.17 Radiated emission measurements from 6.5 to 9 GHz at the mid carrier frequency**

TEST SITE: Semi anechoic chamber  
TEST DISTANCE: 3 m  
ANTENNA POLARIZATION: Vertical and Horizontal

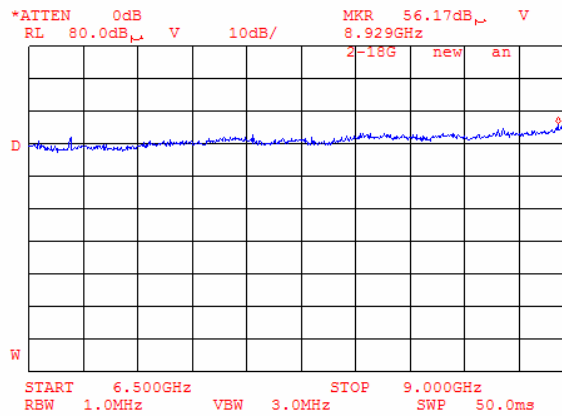

**Plot 7.4.18 Radiated emission measurements from 6.5 to 9 GHz at the high carrier frequency**

TEST SITE: Semi anechoic chamber  
TEST DISTANCE: 3 m  
ANTENNA POLARIZATION: Vertical and Horizontal

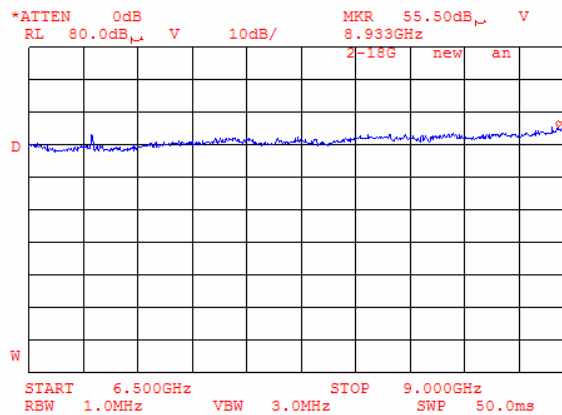

<b>Test specification:</b>	<b>Section 22.917, Radiated spurious emissions</b>		
<b>Test procedure:</b>	FCC part 22, Section 22.917		
<b>Test mode:</b>	Compliance	<b>Verdict:</b>	<b>PASS</b>
<b>Date &amp; Time:</b>	10/16/2005 3:30:32 PM		
<b>Temperature:</b> 24 °C	<b>Air Pressure:</b> 1012 hPa	<b>Relative Humidity:</b> 45 %	<b>Power Supply:</b> 4 VDC
<b>Remarks:</b>			

**Plot 7.4.19 Radiated emission measurements at the second harmonic of low carrier frequency**

TEST SITE: Semi anechoic chamber  
TEST DISTANCE: 3 m

17:34:02 OCT 16, 2005

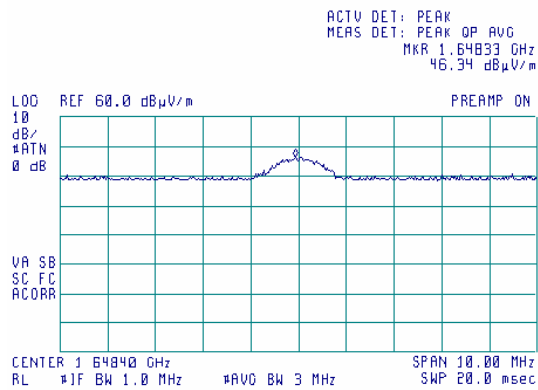

**Plot 7.4.20 Radiated emission measurements at the second harmonic of mid carrier frequency**

TEST SITE: Semi anechoic chamber  
TEST DISTANCE: 3 m

17:28:09 OCT 16, 2005

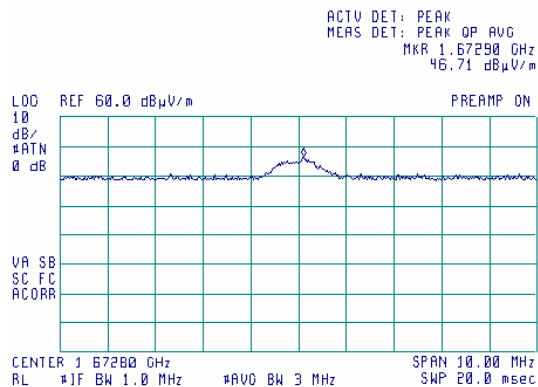

<b>Test specification:</b>	<b>Section 22.917, Radiated spurious emissions</b>		
<b>Test procedure:</b>	FCC part 22, Section 22.917		
<b>Test mode:</b>	Compliance	<b>Verdict:</b>	<b>PASS</b>
<b>Date &amp; Time:</b>	10/16/2005 3:30:32 PM		
<b>Temperature:</b> 24 °C	<b>Air Pressure:</b> 1012 hPa	<b>Relative Humidity:</b> 45 %	<b>Power Supply:</b> 4 VDC
<b>Remarks:</b>			

**Plot 7.4.21 Radiated emission measurements at the second harmonic of high carrier frequency**

TEST SITE: Semi anechoic chamber  
TEST DISTANCE: 3 m

16:46:01 OCT 16, 2005

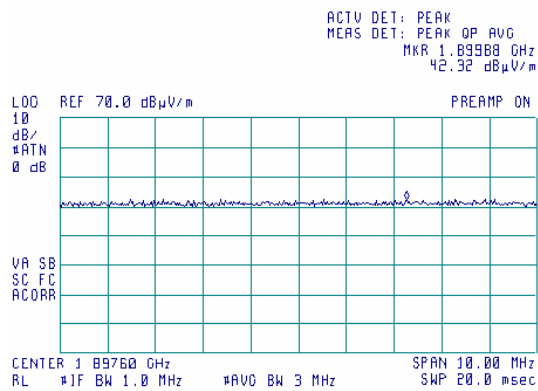

**Plot 7.4.22 Radiated emission measurements at the third harmonic of low carrier frequency**

TEST SITE: Semi anechoic chamber  
TEST DISTANCE: 3 m

17:35:55 OCT 16, 2005

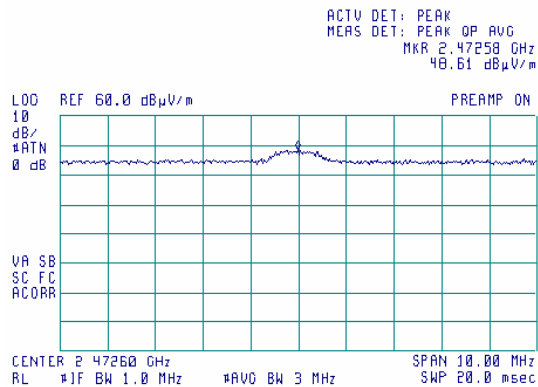

<b>Test specification:</b>	<b>Section 22.917, Radiated spurious emissions</b>		
<b>Test procedure:</b>	FCC part 22, Section 22.917		
<b>Test mode:</b>	Compliance	<b>Verdict:</b>	<b>PASS</b>
<b>Date &amp; Time:</b>	10/16/2005 3:30:32 PM		
<b>Temperature:</b> 24 °C	<b>Air Pressure:</b> 1012 hPa	<b>Relative Humidity:</b> 45 %	<b>Power Supply:</b> 4 VDC
<b>Remarks:</b>			

**Plot 7.4.23 Radiated emission measurements at the third harmonic of mid carrier frequency**

TEST SITE: Semi anechoic chamber  
TEST DISTANCE: 3 m

17:23:30 OCT 16, 2005

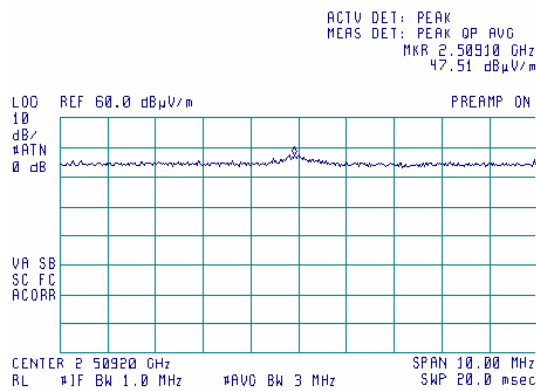

**Plot 7.4.24 Radiated emission measurements at the third harmonic of high carrier frequency**

TEST SITE: Semi anechoic chamber  
TEST DISTANCE: 3 m

16:51:06 OCT 16, 2005

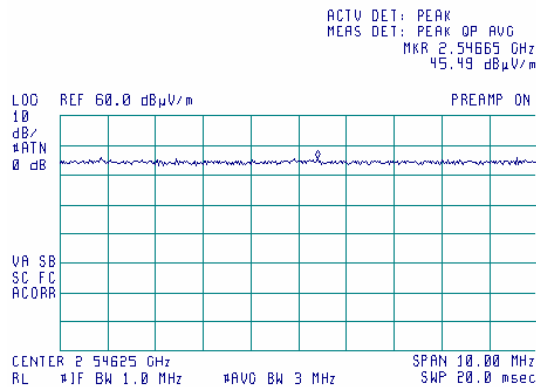



<b>Test specification:</b> Section 22.917, Radiated spurious emissions			
<b>Test procedure:</b> FCC part 22, Section 22.917			
<b>Test mode:</b> Compliance	<b>Verdict:</b> PASS		
<b>Date &amp; Time:</b> 10/16/2005 3:30:32 PM			
<b>Temperature:</b> 24 °C	<b>Air Pressure:</b> 1012 hPa	<b>Relative Humidity:</b> 45 %	<b>Power Supply:</b> 4 VDC
<b>Remarks:</b>			

**Plot 7.4.25 Radiated emission measurements at the fourth harmonic of low carrier frequency**

TEST SITE: Semi anechoic chamber  
TEST DISTANCE: 3 m

17:39:15 OCT 16, 2005

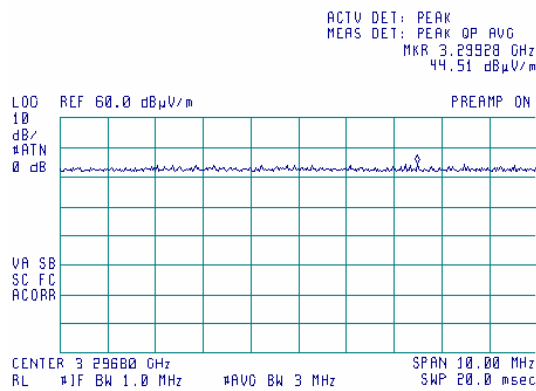

**Plot 7.4.26 Radiated emission measurements at the fourth harmonic of mid carrier frequency**

TEST SITE: Semi anechoic chamber  
TEST DISTANCE: 3 m

17:10:50 OCT 16, 2005

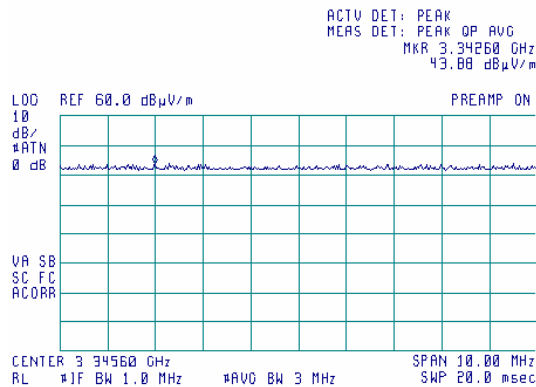

<b>Test specification:</b>	<b>Section 22.917, Radiated spurious emissions</b>		
<b>Test procedure:</b>	FCC part 22, Section 22.917		
<b>Test mode:</b>	Compliance	<b>Verdict:</b>	<b>PASS</b>
<b>Date &amp; Time:</b>	10/16/2005 3:30:32 PM		
<b>Temperature:</b> 24 °C	<b>Air Pressure:</b> 1012 hPa	<b>Relative Humidity:</b> 45 %	<b>Power Supply:</b> 4 VDC
<b>Remarks:</b>			

**Plot 7.4.27 Radiated emission measurements at the fourth harmonic of high carrier frequency**

TEST SITE: Semi anechoic chamber  
TEST DISTANCE: 3 m

17:02:19 OCT 16, 2005

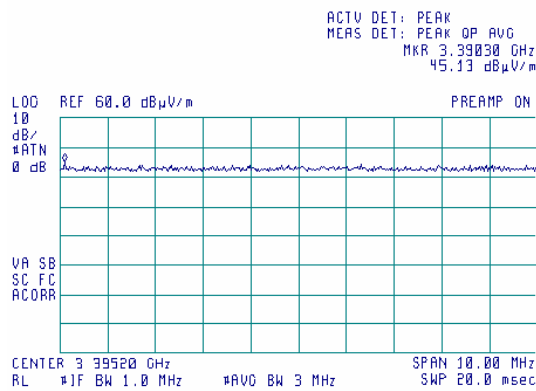

**Plot 7.4.28 Radiated emission measurements at the fifth harmonic of low carrier frequency**

TEST SITE: Semi anechoic chamber  
TEST DISTANCE: 3 m

17:42:18 OCT 16, 2005

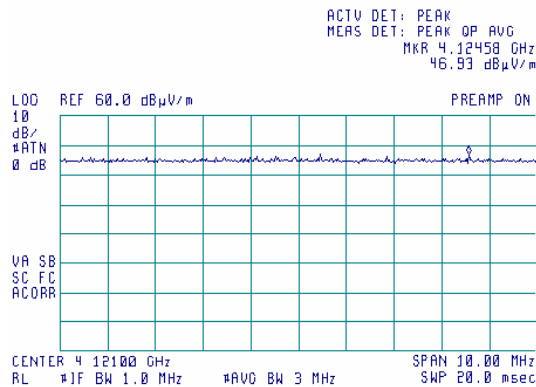

<b>Test specification:</b>	<b>Section 22.917, Radiated spurious emissions</b>		
<b>Test procedure:</b>	FCC part 22, Section 22.917		
<b>Test mode:</b>	Compliance	<b>Verdict:</b>	<b>PASS</b>
<b>Date &amp; Time:</b>	10/16/2005 3:30:32 PM		
<b>Temperature:</b> 24 °C	<b>Air Pressure:</b> 1012 hPa	<b>Relative Humidity:</b> 45 %	<b>Power Supply:</b> 4 VDC
<b>Remarks:</b>			

**Plot 7.4.29 Radiated emission measurements at the fifth harmonic of mid carrier frequency**

TEST SITE: Semi anechoic chamber  
TEST DISTANCE: 3 m

17:17:06 OCT 16, 2005

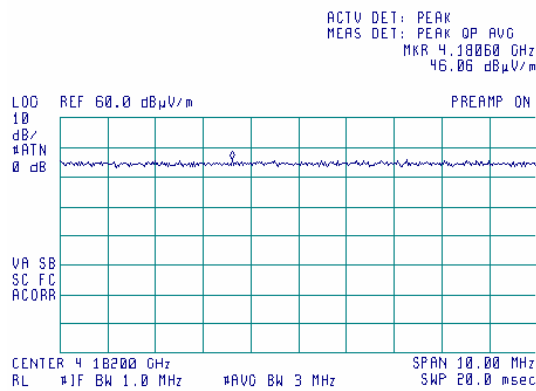

**Plot 7.4.30 Radiated emission measurements at the fifth harmonic of high carrier frequency**

TEST SITE: Semi anechoic chamber  
TEST DISTANCE: 3 m

17:00:39 OCT 16, 2005

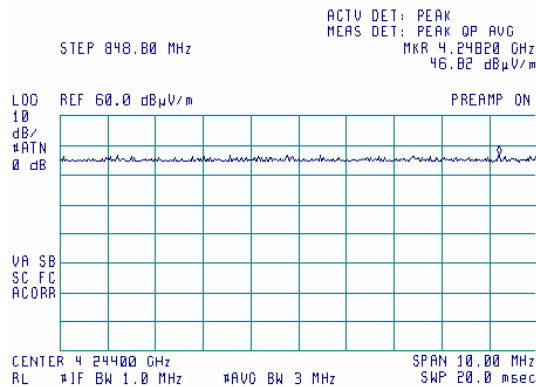

<b>Test specification:</b>	<b>Section 22.355, Frequency stability test</b>		
<b>Test procedure:</b>	FCC part 22, Section 22.355, part 2 section 2.1055		
<b>Test mode:</b>	Compliance	<b>Verdict:</b>	<b>PASS</b>
<b>Date &amp; Time:</b>	10/26/2005 13:48:01 PM		
<b>Temperature:</b> 24 °C	<b>Air Pressure:</b> 1012 hPa	<b>Relative Humidity:</b> 45 %	<b>Power Supply:</b> 4 VDC
<b>Remarks:</b>			

## 7.5 Frequency stability test

### 7.5.1 General

This test was performed to measure frequency stability of transmitter RF carrier. Specification test limits are given in Table 7.5.1. The test results are provided in Table 7.5.2.

**Table 7.5.1 Frequency stability limits**

Assigned frequency, MHz	Limit, ppm	Limits, Hz
824.2	2.5	2060
836.4		2090
848.8		2120

### 7.5.2 Test procedure

- 7.5.2.1 The EUT was set up as shown in Figure 8.5.1, energized and its proper operation was checked.
- 7.5.2.2 The EUT power was turned off. Temperature within test chamber was set to +30°C and a period of time sufficient to stabilize all of the oscillator circuit components was allowed.
- 7.5.2.3 The EUT was powered on and carrier frequency was measured at start up moment and then every minute until frequency had been stabilized or 10 minutes elapsed whichever reached the last. The EUT was powered off.
- 7.5.2.4 The above procedure was repeated at 0°C and at the lowest test temperature.
- 7.5.2.5 The EUT was powered on and carrier frequency was measured at start up moment and at the end of stabilization period at the rest of test temperatures and voltages. The EUT was powered off.
- 7.5.2.6 Frequency displacement was calculated and compared with the limit as provided in Table 7.5.2

**Figure 7.5.1 Frequency stability test setup**

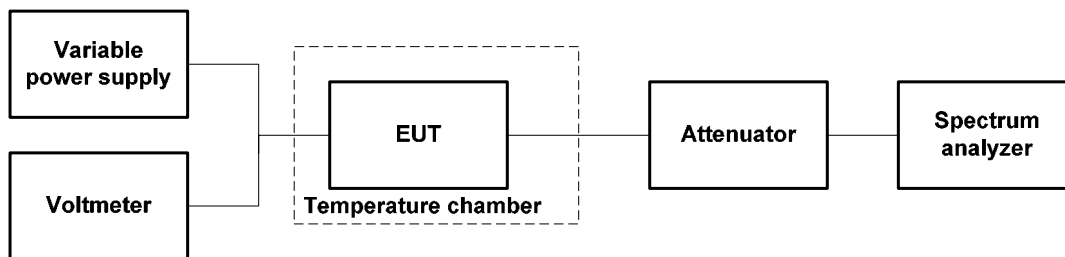

<b>Test specification:</b>	<b>Section 22.355, Frequency stability test</b>		
<b>Test procedure:</b>	FCC part 22, Section 22.355, part 2 section 2.1055		
<b>Test mode:</b>	Compliance	<b>Verdict:</b>	<b>PASS</b>
<b>Date &amp; Time:</b>	10/26/2005 13:48:01 PM		
<b>Temperature:</b> 24 °C	<b>Air Pressure:</b> 1012 hPa	<b>Relative Humidity:</b> 45 %	<b>Power Supply:</b> 4 VDC
<b>Remarks:</b>			

Photograph 7.5.1 Frequency stability test setup



<b>Test specification:</b>		<b>Section 22.355, Frequency stability test</b>			
<b>Test procedure:</b>		FCC part 22, Section 22.355, part 2 section 2.1055			
<b>Test mode:</b>	Compliance	<b>Verdict:</b>		<b>PASS</b>	
<b>Date &amp; Time:</b>	10/26/2005 13:48:01 PM				
<b>Temperature:</b> 24 °C	<b>Air Pressure:</b> 1012 hPa	<b>Relative Humidity:</b> 45 %	<b>Power Supply:</b> 4 VDC		
<b>Remarks:</b>					

**Table 7.5.2 Frequency stability test results**

OPERATING FREQUENCY: 824.2 – 848.8 MHz  
 NOMINAL POWER VOLTAGE: 4 Vdc  
 TEMPERATURE STABILIZATION PERIOD: 20 min  
 POWER DURING TEMPERATURE TRANSITION: Off  
 SPECTRUM ANALYZER MODE: Counter  
 RESOLUTION BANDWIDTH: 100 kHz  
 VIDEO BANDWIDTH: 100 kHz  
 MODULATION: FSK

T, °C	Voltage, V	Frequency, MHz							Max frequency drift, Hz	
		Start up	1 <sup>st</sup> min	2 <sup>nd</sup> min	3 <sup>rd</sup> min	4 <sup>th</sup> min	5 <sup>th</sup> min	10 <sup>th</sup> min	Positive	Negative
<b>Low carrier frequency, limit 2060 Hz</b>										
-30	nominal	824.200625	824.200850	824.200850	824.198750	824.198750	824.200000	824.200000	0	-1250
-20	nominal	824.201000	NA	NA	NA	NA	NA	824.201000	0	-500
-10	nominal	824.199200	NA	NA	NA	NA	NA	824.200000	0	-800
0	nominal	824.199375	824.200000	824.200625	824.200625	824.201250	824.200000	824.201250	1250	0
10	nominal	824.199375	NA	NA	NA	NA	NA	824.200400	0	-625
20	+15%	824.201250	NA	NA	NA	NA	NA	824.201250	0	-250
20	nominal	824.201250	NA	NA	NA	NA	NA	824.201500*	250	0
20	-15%	824.199375	NA	NA	NA	NA	NA	824.200400	0	-1025
30	nominal	824.200850	NA	NA	NA	NA	NA	824.200000	850	0
40	nominal	824.201000	NA	NA	NA	NA	NA	824.200000	1000	0
50	nominal	824.199600	824.199200	824.200850	824.200000	824.200000	824.198750	824.200000	0	-1250
<b>Mid carrier frequency, , limit 2090 Hz</b>										
-30	nominal	836.402000	836.402000	836.401700	836.401700	836.402000	836.402000	836.400450	0	-1550
-20	nominal	836.400000	NA	NA	NA	NA	NA	836.399375	0	-675
-10	nominal	836.400000	NA	NA	NA	NA	NA	836.400450	0	-450
0	nominal	836.402000	836.402000	836.402000	836.402000	836.401700	836.402000	836.402000	0	-300
10	nominal	836.402000	NA	NA	NA	NA	NA	836.401250	750	0
20	+15%	836.400000	NA	NA	NA	NA	NA	836.400000	0	0
20	nominal	836.400000	NA	NA	NA	NA	NA	836.399750*	0	-250
20	-15%	836.400000	NA	NA	NA	NA	NA	836.400000	0	0
30	nominal	836.400450	NA	NA	NA	NA	NA	836.401250	0	-800
40	nominal	836.400000	NA	NA	NA	NA	NA	836.400000	0	0
50	nominal	836.402000	836.400800	836.401700	836.400800	836.400850	836.400000	836.400400	1300	0
<b>High carrier frequency, , limit 2120 Hz</b>										
-30	nominal	848.800000	848.800450	848.800450	848.800000	848.800450	848.800450	848.800000	0	-450
-20	nominal	848.800000	NA	NA	NA	NA	NA	848.801250	1200	0
-10	nominal	848.801250	NA	NA	NA	NA	NA	848.800400	0	-850
0	nominal	848.800800	848.801250	848.800800	848.800450	848.800450	848.800450	848.800400	850	0
10	nominal	848.801250	NA	NA	NA	NA	NA	848.800850	400	0
20	+15%	848.800400	NA	NA	NA	NA	NA	848.800350	50	0
20	nominal	848.800000	NA	NA	NA	NA	NA	848.800000*	0	0
20	-15%	848.801250	NA	NA	NA	NA	NA	848.800400	850	0
30	nominal	848.800400	NA	NA	NA	NA	NA	848.800350	50	0
40	nominal	848.800000	NA	NA	NA	NA	NA	848.800625	0	-620
50	nominal	848.800450	848.800450	848.800450	848.800000	848.800450	848.801650	848.800450	1200	0

\* - Reference frequency

**Reference numbers of test equipment used**

HL 0278	HL 0493	HL 1097	HL 1204	HL 1653			
---------	---------	---------	---------	---------	--	--	--

Full description is given in Appendix A.

<b>Test specification:</b>	<b>Section 24.232, Peak output power</b>		
<b>Test procedure:</b>	FCC part 24, Section 24.232		
<b>Test mode:</b>	Compliance	Verdict: <b>PASS</b>	
<b>Date &amp; Time:</b>	11/4/2005 3:46:51 PM		
<b>Temperature:</b> 22°C	<b>Air Pressure:</b> 1012 hPa	<b>Relative Humidity:</b> 46 %	<b>Power Supply:</b> 4 VDC
<b>Remarks:</b>			

## 8 Transmitter tests according to 47CFR part 24 requirements

### 8.1 Peak output power

#### 8.1.1 General

This test was performed to measure the peak output power at RF antenna connector. Specification test limits are given in Table 8.1.1.

Table 8.1.1 Peak output power limits

Assigned frequency range, MHz	Maximum peak output power	
	W	dBm
1850 - 1910	2.0	33.0

#### 8.1.2 Test procedure

8.1.2.1 The EUT was set up as shown in Figure 8.1.1, energized and its proper operation was checked.

8.1.2.2 The EUT was adjusted to produce maximum available to the end user RF output power.

8.1.2.3 The peak output power was measured with spectrum analyzer as provided in Table 8.1.2 and associated plots.

Figure 8.1.1 Peak output power test setup

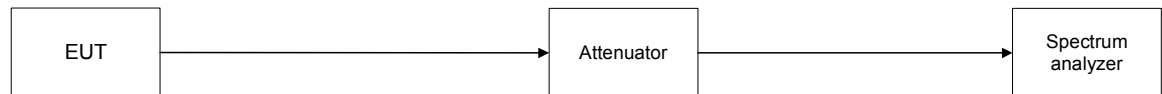

<b>Test specification:</b>		<b>Section 24.232, Peak output power</b>	
<b>Test procedure:</b>		FCC part 24, Section 24.232	
<b>Test mode:</b>	Compliance	<b>Verdict:</b>	<b>PASS</b>
<b>Date &amp; Time:</b>	11/4/2005 3:46:51 PM		
<b>Temperature:</b> 22°C	<b>Air Pressure:</b> 1012 hPa	<b>Relative Humidity:</b> 46 %	<b>Power Supply:</b> 4 VDC
<b>Remarks:</b>			

**Table 8.1.2 Peak output power test results**

OPERATING FREQUENCY RANGE: 1850 - 1910 MHz  
 DETECTOR USED: Peak  
 RESOLUTION BANDWIDTH: 2000 kHz  
 VIDEO BANDWIDTH: 3000 kHz  
 MODULATION: FSK  
 MODULATING SIGNAL: PRBS  
 BIT RATE: 270 kbps  
 TRANSMITTER OUTPUT POWER SETTINGS: Maximum

Carrier frequency, MHz	Spectrum analyzer reading, dBm	External attenuation, dB	Cable loss, dB	RF output power, dBm	Limit, dBm	Margin, dB	Verdict
1850.2	30.13	Included	Included	30.13	33.00	-2.87	Pass
1880.0	30.17	Included	Included	30.17	33.00	-2.83	Pass
1909.8	30.00	Included	Included	30.00	33.00	-3.00	Pass

**Reference numbers of test equipment used**

HL 1424	HL 2524	HL 2634					
---------	---------	---------	--	--	--	--	--

Full description is given in Appendix A.

**Plot 8.1.1 Peak output power test results at low frequency**

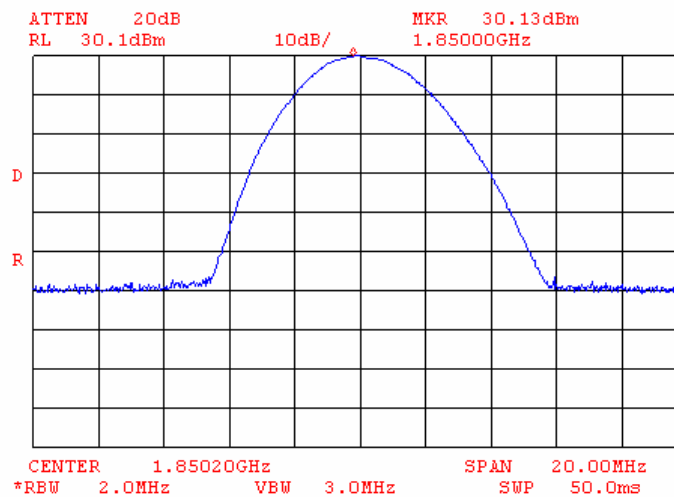



<b>Test specification:</b>	<b>Section 24.232, Peak output power</b>		
<b>Test procedure:</b>	FCC part 24, Section 24.232		
<b>Test mode:</b>	Compliance	Verdict: <b>PASS</b>	
<b>Date &amp; Time:</b>	11/4/2005 3:46:51 PM		
<b>Temperature: 22°C</b>	<b>Air Pressure: 1012 hPa</b>	<b>Relative Humidity: 46 %</b>	<b>Power Supply: 4 VDC</b>
<b>Remarks:</b>			

Plot 8.1.2 Peak output power test results at mid frequency

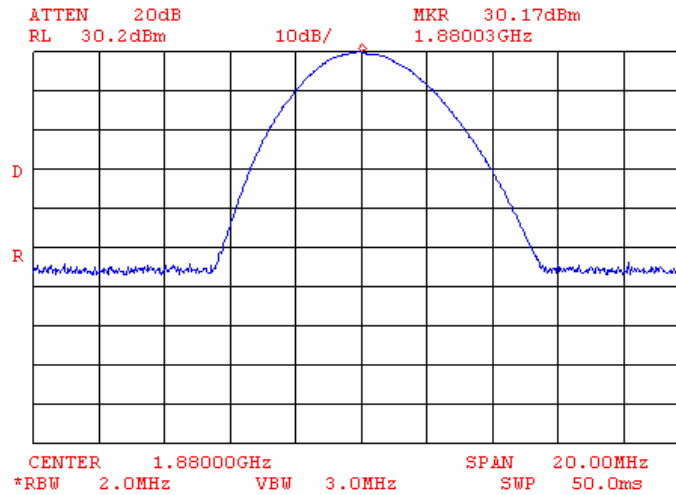

Plot 8.1.3 Peak output power test results at high frequency

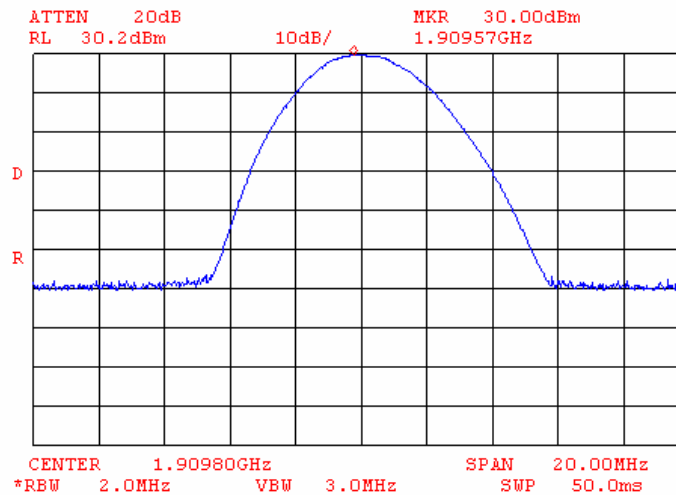

<b>Test specification:</b>	<b>Section 24.238(b), Occupied bandwidth</b>		
<b>Test procedure:</b>	FCC part 24, Section 24.238		
<b>Test mode:</b>	Compliance	<b>Verdict:</b>	<b>PASS</b>
<b>Date &amp; Time:</b>	10/20/2005 9:39:03 AM		
<b>Temperature:</b> 23°C	<b>Air Pressure:</b> 1007 hPa	<b>Relative Humidity:</b> 40%	<b>Power Supply:</b> 4 V DC
<b>Remarks:</b>			

## 8.2 Occupied bandwidth test

### 8.2.1 General

This test was performed to measure transmitter occupied bandwidth. Specification test limits are given in Table 8.2.1

**Table 8.2.1 Occupied bandwidth limits**

Assigned frequency, MHz	Modulation envelope reference points*, dBc
1850 – 1910	26

\* - Modulation envelope reference points are provided in terms of attenuation below the unmodulated carrier.

### 8.2.2 Test procedure

- 8.2.2.1 The EUT was set up as shown in Figure 8.2.1, energized and its proper operation was checked.
- 8.2.2.2 The EUT was set to transmit the unmodulated carrier and the reference peak power level was measured.
- 8.2.2.3 The EUT was set to transmit the normally modulated carrier.
- 8.2.2.4 The transmitter occupied bandwidth was measured with spectrum analyzer as a frequency delta between the reference points on modulation envelope and the results provided in Table 8.2.2 and the associated plots.

**Figure 8.2.1 Occupied bandwidth test setup**

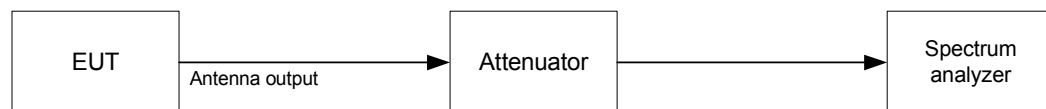

<b>Test specification:</b>	<b>Section 24.238(b), Occupied bandwidth</b>		
<b>Test procedure:</b>	FCC part 24, Section 24.238		
<b>Test mode:</b>	Compliance	<b>Verdict:</b>	<b>PASS</b>
<b>Date &amp; Time:</b>	10/20/2005 9:39:03 AM		
<b>Temperature:</b> 23°C	<b>Air Pressure:</b> 1007 hPa	<b>Relative Humidity:</b> 40%	<b>Power Supply:</b> 4 V DC
<b>Remarks:</b>			

**Table 8.2.2 Occupied bandwidth test results**

DETECTOR USED: Peak hold  
 RESOLUTION BANDWIDTH: 3 kHz  
 VIDEO BANDWIDTH: 10 kHz  
 MODULATION ENVELOPE REFERENCE POINTS: 26 dBc  
 MODULATION: FSK  
 MODULATING SIGNAL: PRBS  
 BIT RATE: 270 kbps

Carrier frequency, MHz	Lower reference point, MHz	Upper reference point, MHz	Occupied bandwidth, kHz
1850.2	1850.062	1850.338	276
1880.0	1879.863	1880.140	277
1909.8	1909.660	1909.933	273

**Reference numbers of test equipment used**

HL 1424	HL 2399	HL 2524				
---------	---------	---------	--	--	--	--

Full description is given in Appendix A.

<b>Test specification:</b>	<b>Section 24.238(b), Occupied bandwidth</b>		
<b>Test procedure:</b>	FCC part 24, Section 24.238		
<b>Test mode:</b>	Compliance	<b>Verdict:</b>	<b>PASS</b>
<b>Date &amp; Time:</b>	10/20/2005 9:39:03 AM		
<b>Temperature:</b> 23°C	<b>Air Pressure:</b> 1007 hPa	<b>Relative Humidity:</b> 40%	<b>Power Supply:</b> 4 V DC
<b>Remarks:</b>			

Plot 8.2.1 Occupied bandwidth test result at low frequency, reference level

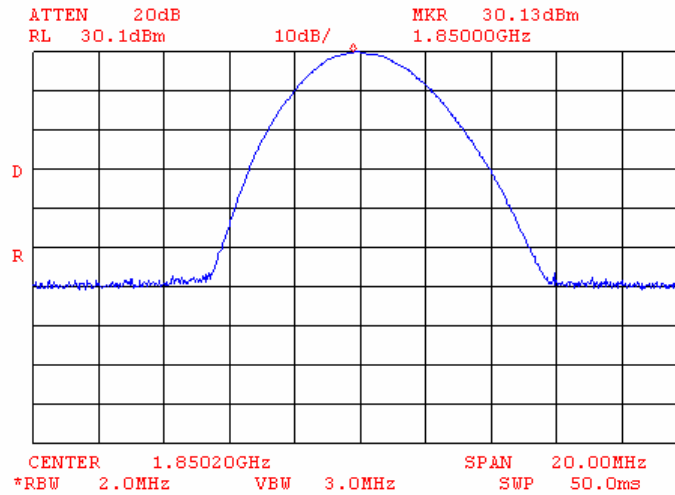

Plot 8.2.2 Occupied bandwidth test result at low frequency, lower reference point

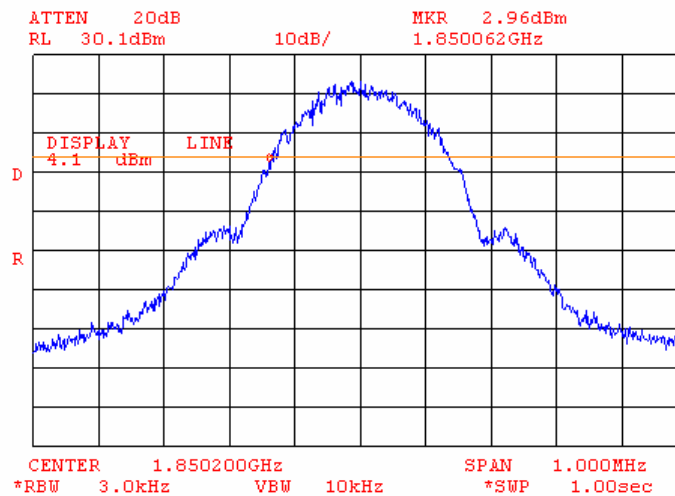

<b>Test specification:</b>	<b>Section 24.238(b), Occupied bandwidth</b>		
<b>Test procedure:</b>	FCC part 24, Section 24.238		
<b>Test mode:</b>	Compliance	<b>Verdict:</b>	<b>PASS</b>
<b>Date &amp; Time:</b>	10/20/2005 9:39:03 AM		
<b>Temperature:</b> 23°C	<b>Air Pressure:</b> 1007 hPa	<b>Relative Humidity:</b> 40%	<b>Power Supply:</b> 4 V DC
<b>Remarks:</b>			

Plot 8.2.3 Occupied bandwidth test result at low frequency, higher reference point

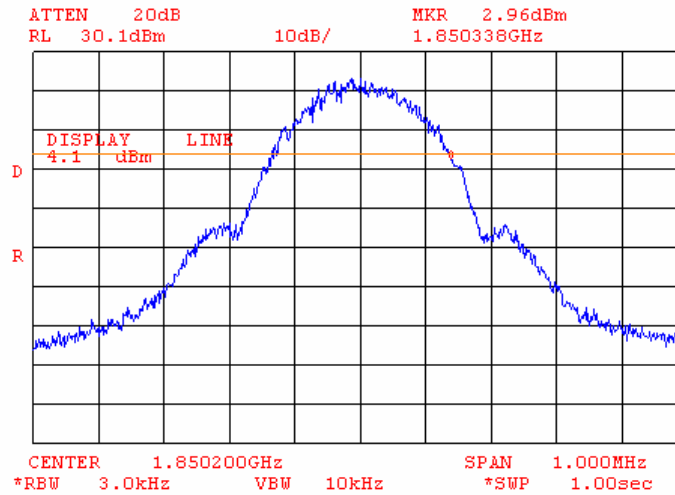

Plot 8.2.4 Occupied bandwidth test result at mid frequency, reference level

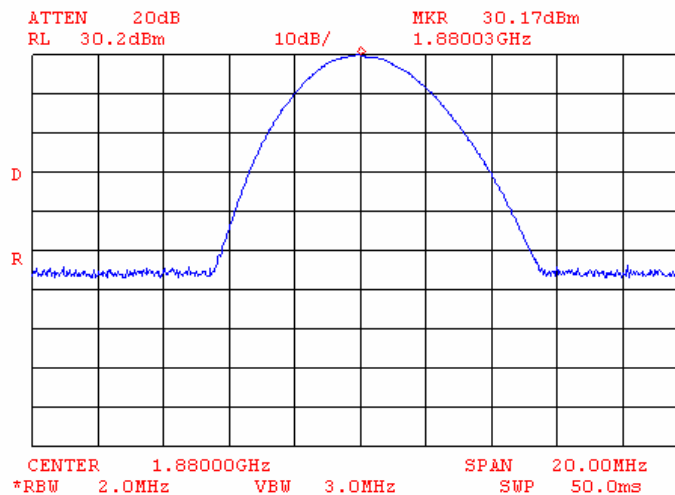



<b>Test specification:</b>	<b>Section 24.238(b), Occupied bandwidth</b>		
<b>Test procedure:</b>	FCC part 24, Section 24.238		
<b>Test mode:</b>	Compliance	<b>Verdict:</b>	<b>PASS</b>
<b>Date &amp; Time:</b>	10/20/2005 9:39:03 AM		
<b>Temperature:</b> 23°C	<b>Air Pressure:</b> 1007 hPa	<b>Relative Humidity:</b> 40%	<b>Power Supply:</b> 4 V DC
<b>Remarks:</b>			

Plot 8.2.7 Occupied bandwidth test result at high frequency, reference level

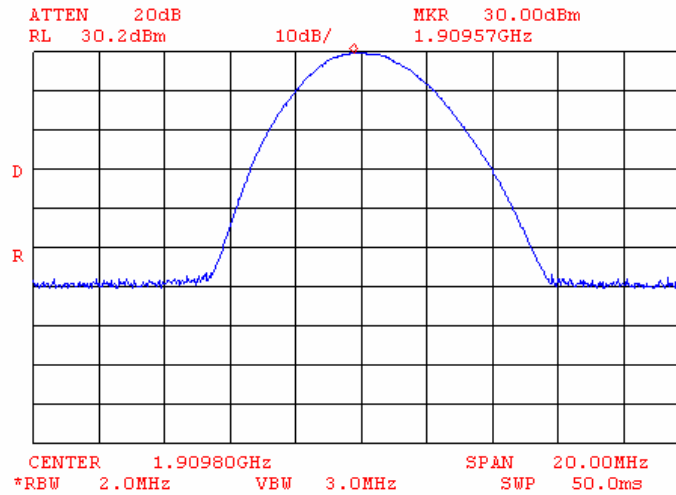

Plot 8.2.8 Occupied bandwidth test result at high frequency, lower reference point

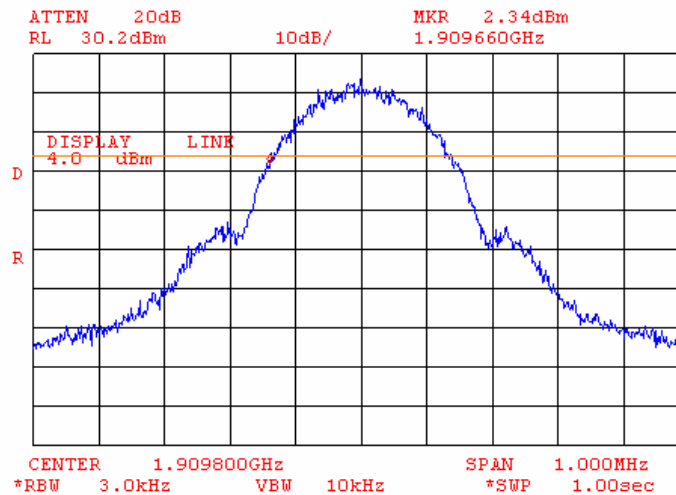

<b>Test specification:</b>	<b>Section 24.238(b), Occupied bandwidth</b>		
<b>Test procedure:</b>	FCC part 24, Section 24.238		
<b>Test mode:</b>	Compliance	<b>Verdict:</b>	<b>PASS</b>
<b>Date &amp; Time:</b>	10/20/2005 9:39:03 AM		
<b>Temperature:</b> 23°C	<b>Air Pressure:</b> 1007 hPa	<b>Relative Humidity:</b> 40%	<b>Power Supply:</b> 4 V DC
<b>Remarks:</b>			

Plot 8.2.9 Occupied bandwidth test result at high frequency, higher reference point

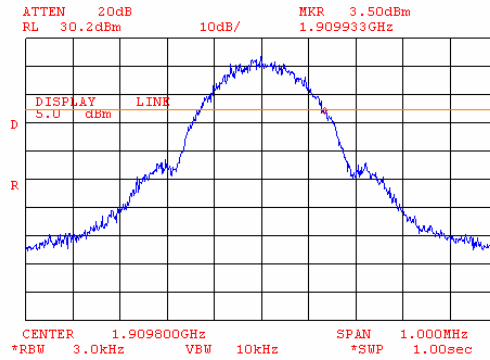

Plot 8.2.10 Bandedge emission measurements in 1849 - 1850 MHz range at low carrier frequency

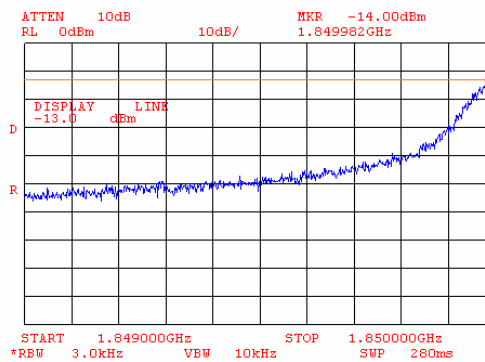

Plot 8.2.11 Bandedge emission measurements in 1910 - 1911 MHz range at high carrier frequency

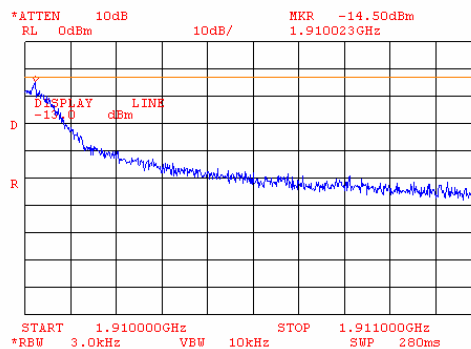

For bandedge emissions measurement procedure refer to section 8.3.



<b>Test specification:</b>	<b>Section 24.238, Spurious emission at antenna terminal</b>		
<b>Test procedure:</b>	FCC part 24, Section 24.238		
<b>Test mode:</b>	Compliance	<b>Verdict:</b>	<b>PASS</b>
<b>Date &amp; Time:</b>	10/20/2005 4:03:01 PM		
<b>Temperature:</b> 22 °C	<b>Air Pressure:</b> 1012 hPa	<b>Relative Humidity:</b> 46 %	<b>Power Supply:</b> 4 VDC
<b>Remarks:</b>			

### 8.3 Spurious emissions at RF antenna connector test

#### 8.3.1 General

This test was performed to measure spurious emissions at RF antenna connector. Specification test limits are given in Table 8.3.1.

Table 8.3.1 Spurious emission limits

Frequency, MHz	Attenuation below carrier, dBc	ERP of spurious, dBm
0.009 – 10 <sup>th</sup> harmonic*	43+10logP*	-13.0

#### 8.3.2 Test procedure

8.3.2.1 The EUT was set up as shown in Figure 8.3.1, energized and its proper operation was checked.

8.3.2.2 The EUT was adjusted to produce maximum available for end user RF output power.

8.3.2.3 The spurious emission was measured with spectrum analyzer as provided in Table 8.3.2 and associated plots.

Figure 8.3.1 Spurious emission test setup



<b>Test specification:</b>	<b>Section 24.238, Spurious emission at antenna terminal</b>			
<b>Test procedure:</b>	FCC part 24, Section 24.238			
<b>Test mode:</b>	Compliance	<b>Verdict:</b>		<b>PASS</b>
<b>Date &amp; Time:</b>	10/20/2005 4:03:01 PM			
<b>Temperature:</b> 22 °C	<b>Air Pressure:</b> 1012 hPa	<b>Relative Humidity:</b> 46 %	<b>Power Supply:</b> 4 VDC	
<b>Remarks:</b>				

**Table 8.3.2 Spurious emission test results**

ASSIGNED FREQUENCY RANGE: 1850 - 1910 MHz  
 INVESTIGATED FREQUENCY RANGE: 0.009 – 20000 MHz  
 DETECTOR USED: Peak  
 VIDEO BANDWIDTH: ≥ Resolution bandwidth  
 MODULATION: FSK  
 MODULATING SIGNAL: PRBS  
 BIT RATE: 270 kbps  
 TRANSMITTER OUTPUT POWER SETTINGS: Maximum  
 TRANSMITTER OUTPUT POWER: 30.13 dBm at low frequency  
 30.17 dBm at mid frequency  
 30.00 dBm at high frequency

Frequency, MHz	SA reading, dBm	Attenuator, dB	Cable loss, dB	RBW, kHz	Spurious emission, dBm	Attenuation below carrier, dBc	Limit, dBc	Margin, dB*	Verdict
<b>Low carrier frequency</b>									
3700.32	-43.33	Included	Included	1000	-43.33	73.46	43.13	30.33	Pass
5550.45	-47.00	Included	Included	1000	-47.00	77.13	43.13	34.00	Pass
7400.70	-43.50	Included	Included	1000	-43.50	73.63	43.13	30.50	Pass
9250.87	-40.67	Included	Included	1000	-40.67	70.80	43.13	27.67	Pass
11100.77	-31.17	Included	Included	1000	-31.17	61.30	43.13	18.17	Pass
14800.73	-39.17	Included	Included	1000	-39.17	69.30	43.13	26.17	Pass
<b>Mid carrier frequency</b>									
3760.07	-43.83	Included	Included	1000	-43.83	74.00	43.17	30.83	Pass
5639.53	-48.67	Included	Included	1000	-48.67	78.84	43.17	35.67	Pass
7519.75	-44.00	Included	Included	1000	-44.00	74.17	43.17	31.00	Pass
9399.60	-39.33	Included	Included	1000	-39.33	69.50	43.17	26.33	Pass
11279.60	-29.83	Included	Included	1000	-29.83	60.00	43.17	16.83	Pass
15039.65	-37.00	Included	Included	1000	-37.00	67.17	43.17	24.00	Pass
<b>High carrier frequency</b>									
3819.25	-44.67	Included	Included	1000	-44.67	74.67	43.00	31.67	Pass
5729.40	-38.17	Included	Included	1000	-38.17	68.17	43.00	25.17	Pass
7638.85	-44.17	Included	Included	1000	-44.17	74.17	43.00	31.17	Pass
9549.07	-40.67	Included	Included	1000	-40.67	70.67	43.00	27.67	Pass
11458.35	-33.50	Included	Included	1000	-33.50	63.50	43.00	20.50	Pass
15278.92	-37.33	Included	Included	1000	-37.33	37.33	13.00	24.33	Pass

\*- Margin = Spurious emission – specification limit.

**Reference numbers of test equipment used**

HL 1424	HL 2254	HL 2524			
---------	---------	---------	--	--	--

Full description is given in Appendix A.

<b>Test specification:</b>	<b>Section 24.238, Spurious emission at antenna terminal</b>		
<b>Test procedure:</b>	FCC part 24, Section 24.238		
<b>Test mode:</b>	Compliance	<b>Verdict:</b>	<b>PASS</b>
<b>Date &amp; Time:</b>	10/20/2005 4:03:01 PM		
<b>Temperature:</b> 22 °C	<b>Air Pressure:</b> 1012 hPa	<b>Relative Humidity:</b> 46 %	<b>Power Supply:</b> 4 VDC
<b>Remarks:</b>			

Plot 8.3.1 Spurious emission measurements in 9 - 150 kHz range at low carrier frequency

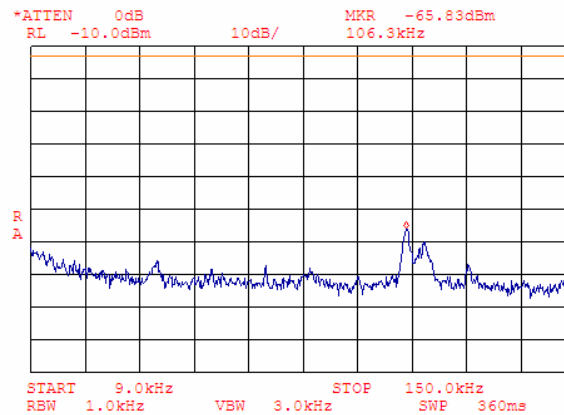

Plot 8.3.2 Spurious emission measurements in 9 - 150 kHz range at mid carrier frequency

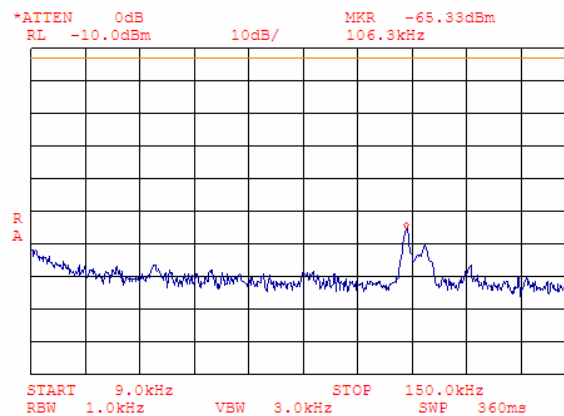

<b>Test specification:</b>	<b>Section 24.238, Spurious emission at antenna terminal</b>		
<b>Test procedure:</b>	FCC part 24, Section 24.238		
<b>Test mode:</b>	Compliance	<b>Verdict:</b>	<b>PASS</b>
<b>Date &amp; Time:</b>	10/20/2005 4:03:01 PM		
<b>Temperature:</b> 22 °C	<b>Air Pressure:</b> 1012 hPa	<b>Relative Humidity:</b> 46 %	<b>Power Supply:</b> 4 VDC
<b>Remarks:</b>			

Plot 8.3.3 Spurious emission measurements in 9 - 150 kHz range at high carrier frequency

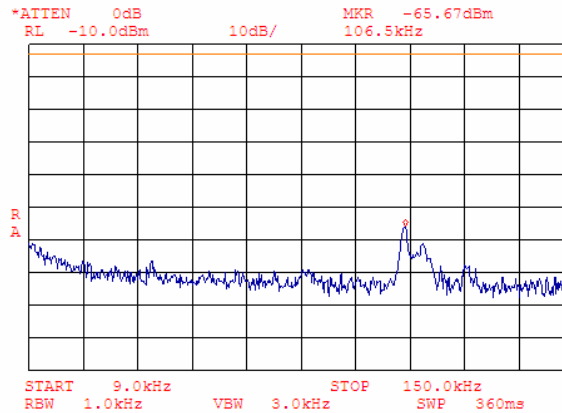

Plot 8.3.4 Spurious emission measurements in 0.15 - 30.0 MHz range at low carrier frequency

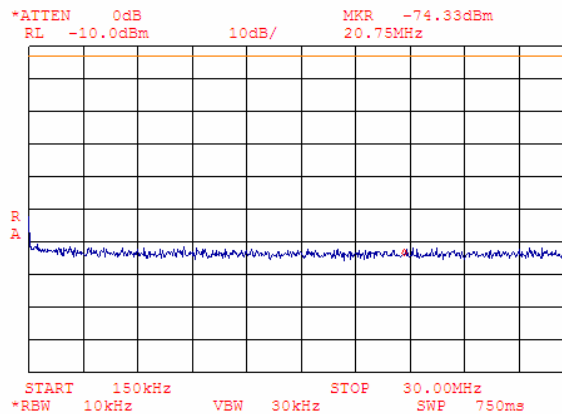

<b>Test specification:</b>	<b>Section 24.238, Spurious emission at antenna terminal</b>		
<b>Test procedure:</b>	FCC part 24, Section 24.238		
<b>Test mode:</b>	Compliance	<b>Verdict:</b>	<b>PASS</b>
<b>Date &amp; Time:</b>	10/20/2005 4:03:01 PM		
<b>Temperature:</b> 22 °C	<b>Air Pressure:</b> 1012 hPa	<b>Relative Humidity:</b> 46 %	<b>Power Supply:</b> 4 VDC
<b>Remarks:</b>			

Plot 8.3.5 Spurious emission measurements in 0.15 - 30.0 MHz range at mid carrier frequency

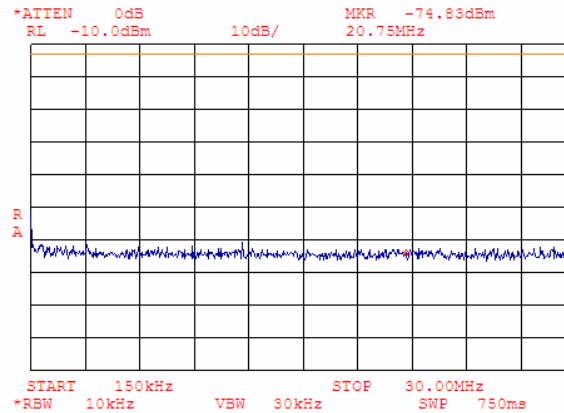

Plot 8.3.6 Spurious emission measurements in 0.15 - 30.0 MHz range at high carrier frequency

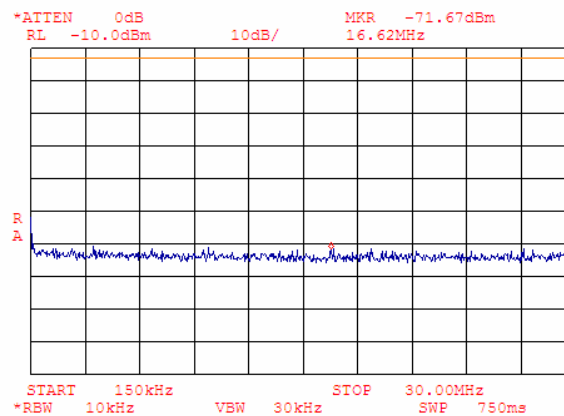

<b>Test specification:</b>	<b>Section 24.238, Spurious emission at antenna terminal</b>		
<b>Test procedure:</b>	FCC part 24, Section 24.238		
<b>Test mode:</b>	Compliance	<b>Verdict: PASS</b>	
<b>Date &amp; Time:</b>	10/20/2005 4:03:01 PM		
<b>Temperature:</b> 22 °C	<b>Air Pressure:</b> 1012 hPa	<b>Relative Humidity:</b> 46 %	<b>Power Supply:</b> 4 VDC
<b>Remarks:</b>			

Plot 8.3.7 Spurious emission measurements in 30.0 - 1000 MHz range at low carrier frequency

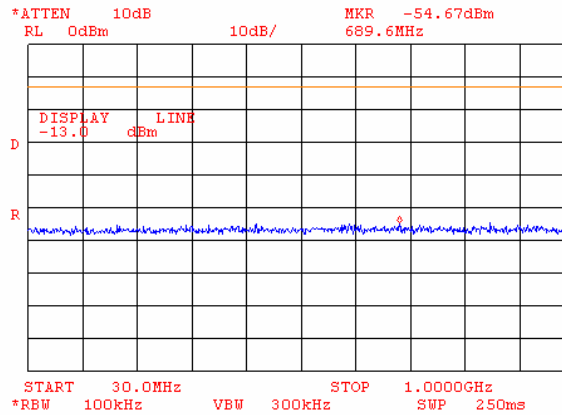

Plot 8.3.8 Spurious emission measurements in 30.0 - 1000 MHz range at mid carrier frequency

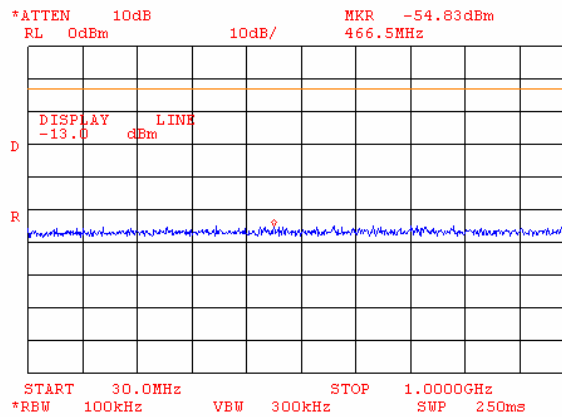

<b>Test specification:</b>	<b>Section 24.238, Spurious emission at antenna terminal</b>		
<b>Test procedure:</b>	FCC part 24, Section 24.238		
<b>Test mode:</b>	Compliance	<b>Verdict: PASS</b>	
<b>Date &amp; Time:</b>	10/20/2005 4:03:01 PM		
<b>Temperature:</b> 22 °C	<b>Air Pressure:</b> 1012 hPa	<b>Relative Humidity:</b> 46 %	<b>Power Supply:</b> 4 VDC
<b>Remarks:</b>			

Plot 8.3.9 Spurious emission measurements in 30.0 - 1000 MHz range at high carrier frequency

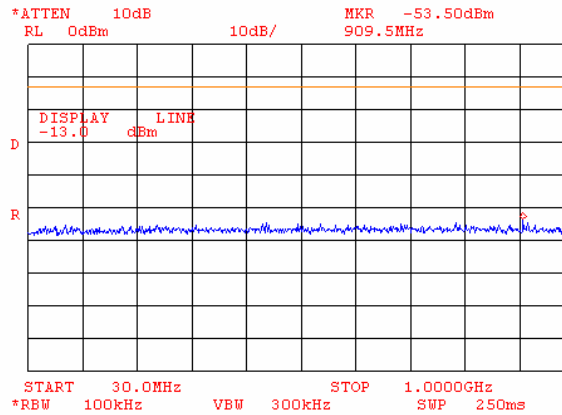

Plot 8.3.10 Spurious emission measurements in 1000 - 1845 MHz range at low carrier frequency

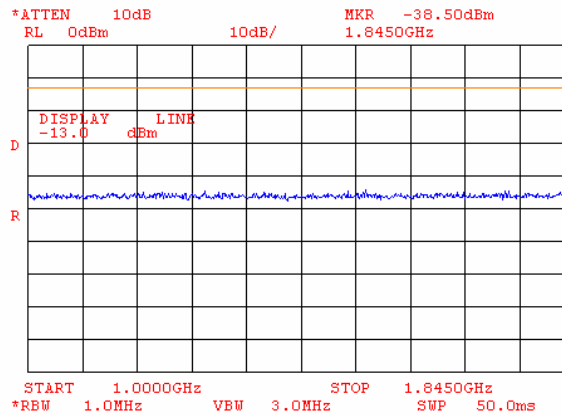

<b>Test specification:</b>	<b>Section 24.238, Spurious emission at antenna terminal</b>		
<b>Test procedure:</b>	FCC part 24, Section 24.238		
<b>Test mode:</b>	Compliance	<b>Verdict: PASS</b>	
<b>Date &amp; Time:</b>	10/20/2005 4:03:01 PM		
<b>Temperature:</b> 22 °C	<b>Air Pressure:</b> 1012 hPa	<b>Relative Humidity:</b> 46 %	<b>Power Supply:</b> 4 VDC
<b>Remarks:</b>			

Plot 8.3.11 Spurious emission measurements in 1845 - 1849 MHz range at low carrier frequency

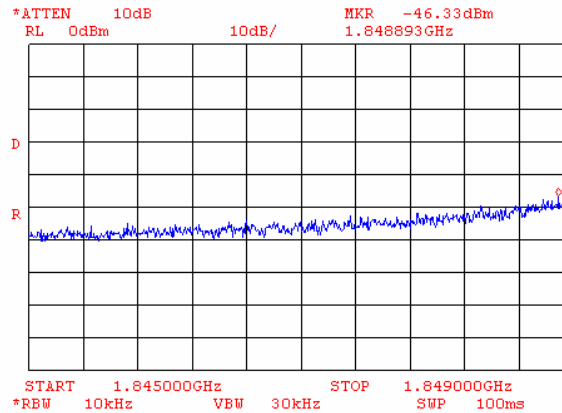

Note:  $P_{Signal} = P_{SA\ reading} + 10\log(1\text{MHz}/\text{RBW}) = -46.33 + 10\log(100) = -46.33 + 20 = -26.33\text{ dBm}$   
Limit = -13 dBm



<b>Test specification:</b>	<b>Section 24.238, Spurious emission at antenna terminal</b>		
<b>Test procedure:</b>	FCC part 24, Section 24.238		
<b>Test mode:</b>	Compliance	<b>Verdict:</b>	<b>PASS</b>
<b>Date &amp; Time:</b>	10/20/2005 4:03:01 PM		
<b>Temperature:</b> 22 °C	<b>Air Pressure:</b> 1012 hPa	<b>Relative Humidity:</b> 46 %	<b>Power Supply:</b> 4 VDC
<b>Remarks:</b>			

Plot 8.3.12 Spurious emission measurements in 1000 - 1849 MHz range at mid carrier frequency

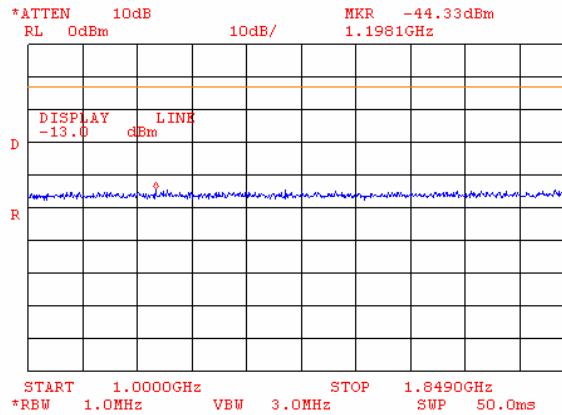

Plot 8.3.13 Spurious emission measurements in 1000 - 1849 MHz range at high carrier frequency

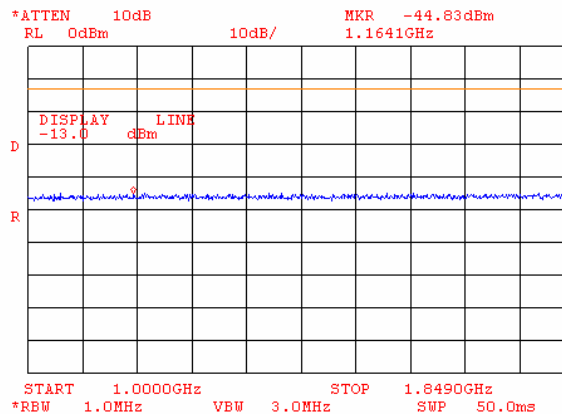

<b>Test specification:</b>	<b>Section 24.238, Spurious emission at antenna terminal</b>		
<b>Test procedure:</b>	FCC part 24, Section 24.238		
<b>Test mode:</b>	Compliance	<b>Verdict:</b>	<b>PASS</b>
<b>Date &amp; Time:</b>	10/20/2005 4:03:01 PM		
<b>Temperature:</b> 22 °C	<b>Air Pressure:</b> 1012 hPa	<b>Relative Humidity:</b> 46 %	<b>Power Supply:</b> 4 VDC
<b>Remarks:</b>			

Plot 8.3.14 Spurious emission measurements in 1849 - 1850 MHz range at low carrier frequency

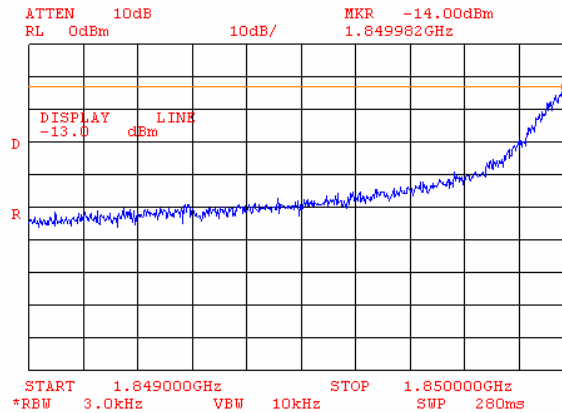

Plot 8.3.15 Spurious emission measurements in 1910 - 1911 MHz range at high carrier frequency

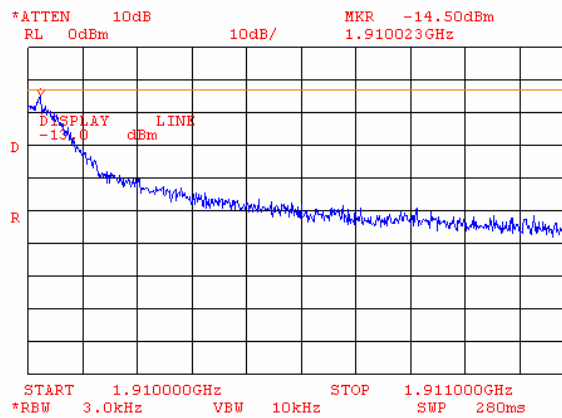

<b>Test specification:</b>	<b>Section 24.238, Spurious emission at antenna terminal</b>		
<b>Test procedure:</b>	FCC part 24, Section 24.238		
<b>Test mode:</b>	Compliance	<b>Verdict:</b>	<b>PASS</b>
<b>Date &amp; Time:</b>	10/20/2005 4:03:01 PM		
<b>Temperature:</b> 22 °C	<b>Air Pressure:</b> 1012 hPa	<b>Relative Humidity:</b> 46 %	<b>Power Supply:</b> 4 VDC
<b>Remarks:</b>			

Plot 8.3.16 Spurious emission measurements in 1911 - 5000 MHz range at low carrier frequency

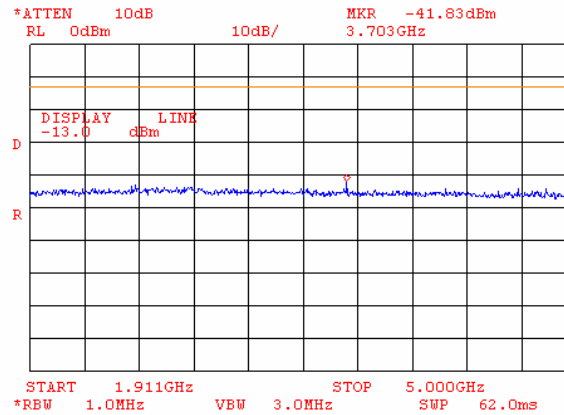

Plot 8.3.17 Spurious emission measurements in 1911 - 5000 MHz range at mid carrier frequency

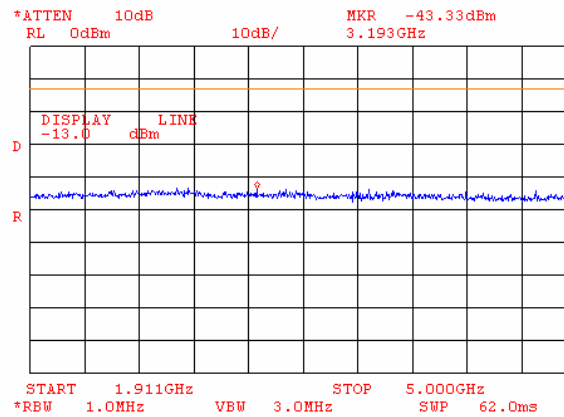

<b>Test specification:</b>	<b>Section 24.238, Spurious emission at antenna terminal</b>		
<b>Test procedure:</b>	FCC part 24, Section 24.238		
<b>Test mode:</b>	Compliance	<b>Verdict: PASS</b>	
<b>Date &amp; Time:</b>	10/20/2005 4:03:01 PM		
<b>Temperature:</b> 22 °C	<b>Air Pressure:</b> 1012 hPa	<b>Relative Humidity:</b> 46 %	<b>Power Supply:</b> 4 VDC
<b>Remarks:</b>			

Plot 8.3.18 Spurious emission measurements in 1911 - 1915 MHz range at high carrier frequency

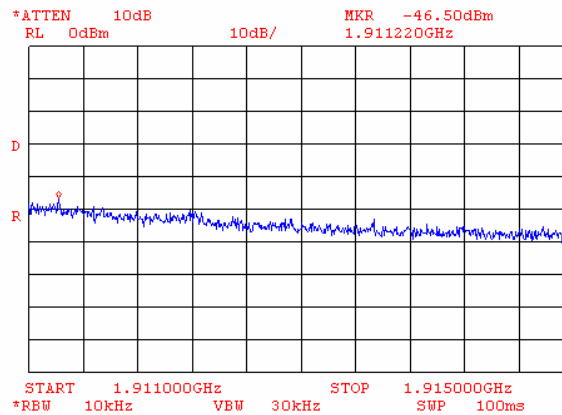

Note:  $P_{Signal} = P_{SA\ reading} + 10\log(1\text{MHz}/\text{RBW}) = -46.50 + 10\log(100) = -46.50 + 20 = -26.50\text{ dBm}$   
Limit = -13 dBm

<b>Test specification:</b>	<b>Section 24.238, Spurious emission at antenna terminal</b>		
<b>Test procedure:</b>	FCC part 24, Section 24.238		
<b>Test mode:</b>	Compliance	<b>Verdict:</b>	<b>PASS</b>
<b>Date &amp; Time:</b>	10/20/2005 4:03:01 PM		
<b>Temperature:</b> 22 °C	<b>Air Pressure:</b> 1012 hPa	<b>Relative Humidity:</b> 46 %	<b>Power Supply:</b> 4 VDC
<b>Remarks:</b>			

Plot 8.3.19 Spurious emission measurements in 1915 - 5000 MHz range at high carrier frequency

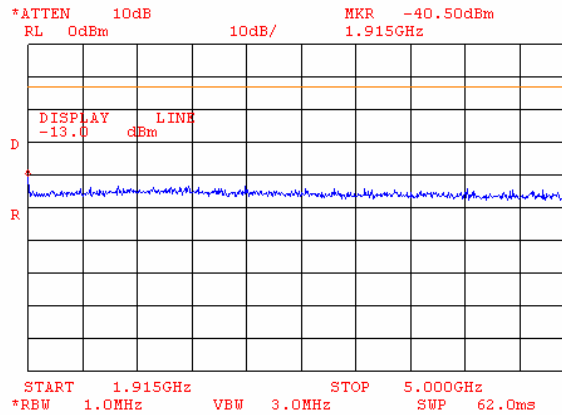

Plot 8.3.20 Spurious emission measurements in 5000 - 20000 MHz range at low carrier frequency

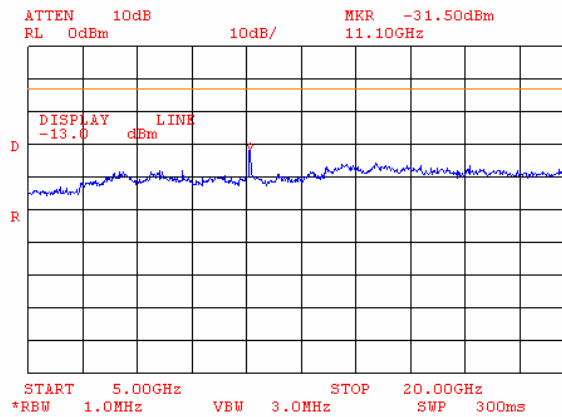

<b>Test specification:</b>	<b>Section 24.238, Spurious emission at antenna terminal</b>		
<b>Test procedure:</b>	FCC part 24, Section 24.238		
<b>Test mode:</b>	Compliance	<b>Verdict:</b>	<b>PASS</b>
<b>Date &amp; Time:</b>	10/20/2005 4:03:01 PM		
<b>Temperature:</b> 22 °C	<b>Air Pressure:</b> 1012 hPa	<b>Relative Humidity:</b> 46 %	<b>Power Supply:</b> 4 VDC
<b>Remarks:</b>			

Plot 8.3.21 Spurious emission measurements in 5000 - 20000 MHz range at mid carrier frequency

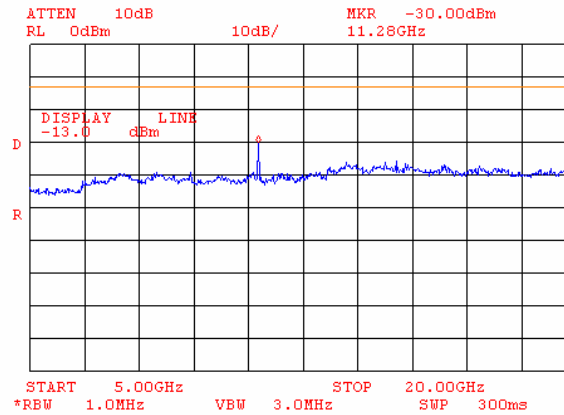

Plot 8.3.22 Spurious emission measurements in 5000 - 20000 MHz range at high carrier frequency

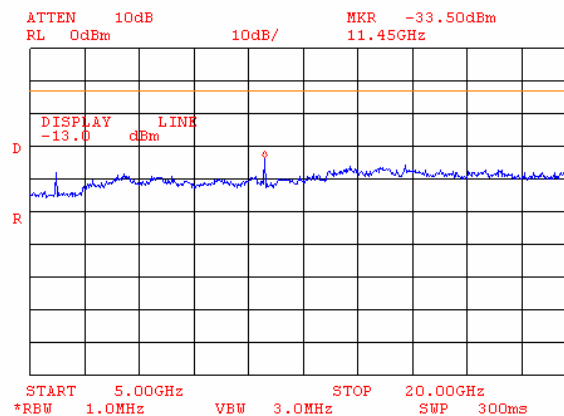

<b>Test specification:</b>	<b>Section 24.238, Spurious emission at antenna terminal</b>		
<b>Test procedure:</b>	FCC part 24, Section 24.238		
<b>Test mode:</b>	Compliance	<b>Verdict:</b>	<b>PASS</b>
<b>Date &amp; Time:</b>	10/20/2005 4:03:01 PM		
<b>Temperature:</b> 22 °C	<b>Air Pressure:</b> 1012 hPa	<b>Relative Humidity:</b> 46 %	<b>Power Supply:</b> 4 VDC
<b>Remarks:</b>			

Plot 8.3.23 Conducted spurious emission measurements at the 2<sup>nd</sup> harmonic of low carrier frequency

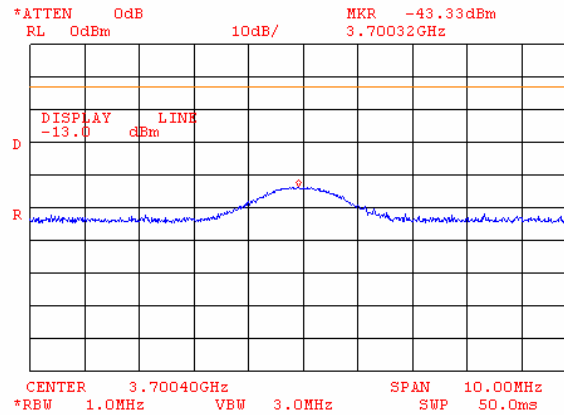

Plot 8.3.24 Conducted spurious emission measurements at the 2<sup>nd</sup> harmonic of mid carrier frequency

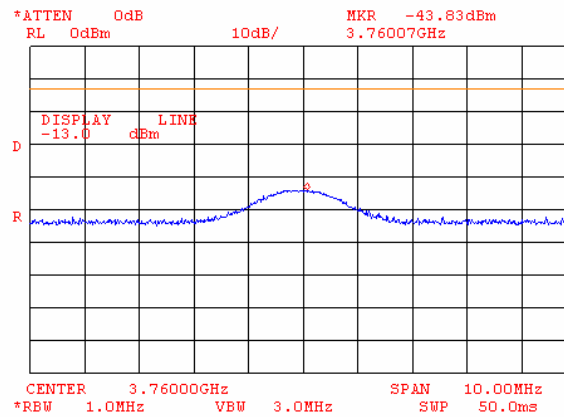

<b>Test specification:</b>	<b>Section 24.238, Spurious emission at antenna terminal</b>		
<b>Test procedure:</b>	FCC part 24, Section 24.238		
<b>Test mode:</b>	Compliance	<b>Verdict:</b>	<b>PASS</b>
<b>Date &amp; Time:</b>	10/20/2005 4:03:01 PM		
<b>Temperature:</b> 22 °C	<b>Air Pressure:</b> 1012 hPa	<b>Relative Humidity:</b> 46 %	<b>Power Supply:</b> 4 VDC
<b>Remarks:</b>			

Plot 8.3.25 Conducted spurious emission measurements at the 2<sup>nd</sup> harmonic of high carrier frequency

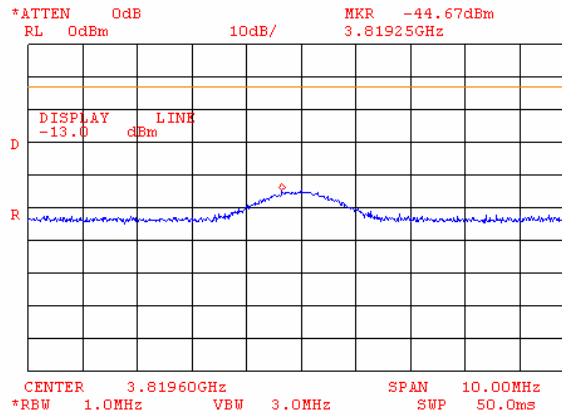

Plot 8.3.26 Conducted spurious emission measurements at the 3<sup>rd</sup> harmonic of low carrier frequency

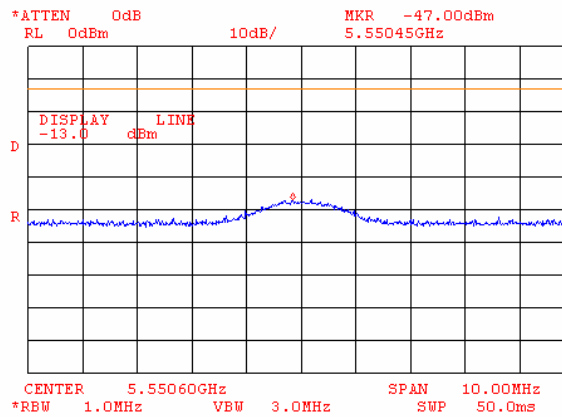



<b>Test specification:</b>	<b>Section 24.238, Spurious emission at antenna terminal</b>		
<b>Test procedure:</b>	FCC part 24, Section 24.238		
<b>Test mode:</b>	Compliance	<b>Verdict:</b>	<b>PASS</b>
<b>Date &amp; Time:</b>	10/20/2005 4:03:01 PM		
<b>Temperature:</b> 22 °C	<b>Air Pressure:</b> 1012 hPa	<b>Relative Humidity:</b> 46 %	<b>Power Supply:</b> 4 VDC
<b>Remarks:</b>			

Plot 8.3.27 Conducted spurious emission measurements at the 3<sup>rd</sup> harmonic of mid carrier frequency

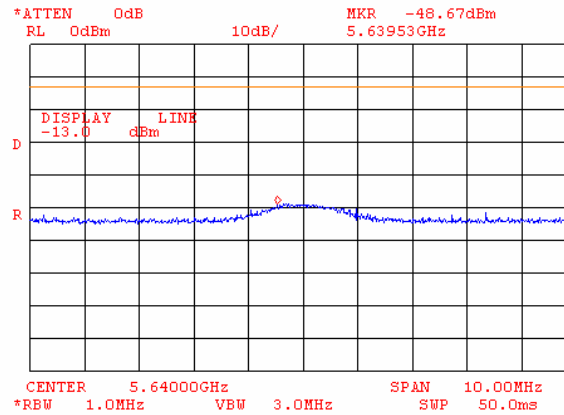

Plot 8.3.28 Conducted spurious emission measurements at the 3<sup>rd</sup> harmonic of high carrier frequency

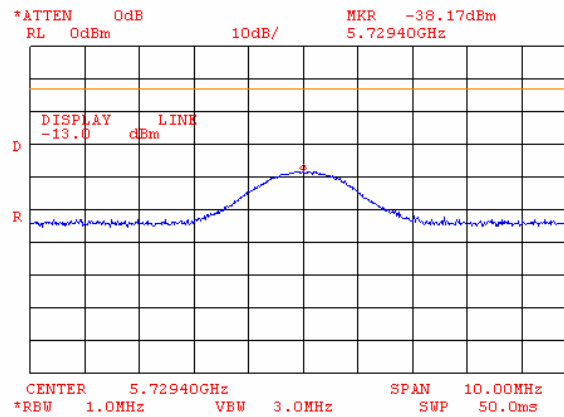

<b>Test specification:</b>	<b>Section 24.238, Spurious emission at antenna terminal</b>		
<b>Test procedure:</b>	FCC part 24, Section 24.238		
<b>Test mode:</b>	Compliance	<b>Verdict:</b>	<b>PASS</b>
<b>Date &amp; Time:</b>	10/20/2005 4:03:01 PM		
<b>Temperature:</b> 22 °C	<b>Air Pressure:</b> 1012 hPa	<b>Relative Humidity:</b> 46 %	<b>Power Supply:</b> 4 VDC
<b>Remarks:</b>			

Plot 8.3.29 Conducted spurious emission measurements at the 4<sup>th</sup> harmonic of low carrier frequency

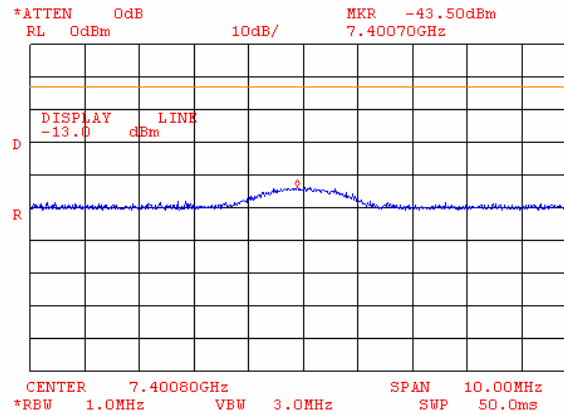

Plot 8.3.30 Conducted spurious emission measurements at the 4<sup>th</sup> harmonic of mid carrier frequency

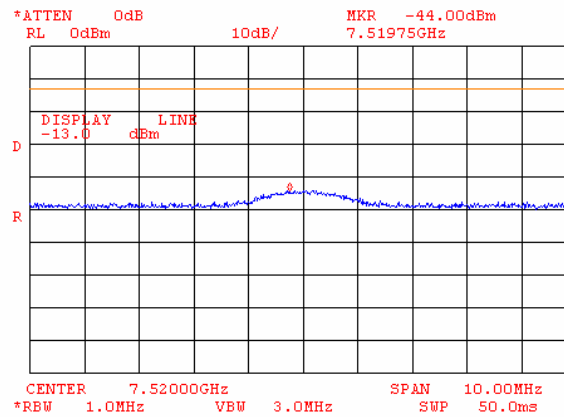

<b>Test specification:</b>	<b>Section 24.238, Spurious emission at antenna terminal</b>		
<b>Test procedure:</b>	FCC part 24, Section 24.238		
<b>Test mode:</b>	Compliance	<b>Verdict:</b>	<b>PASS</b>
<b>Date &amp; Time:</b>	10/20/2005 4:03:01 PM		
<b>Temperature:</b> 22 °C	<b>Air Pressure:</b> 1012 hPa	<b>Relative Humidity:</b> 46 %	<b>Power Supply:</b> 4 VDC
<b>Remarks:</b>			

Plot 8.3.31 Conducted spurious emission measurements at the 4<sup>th</sup> harmonic of high carrier frequency

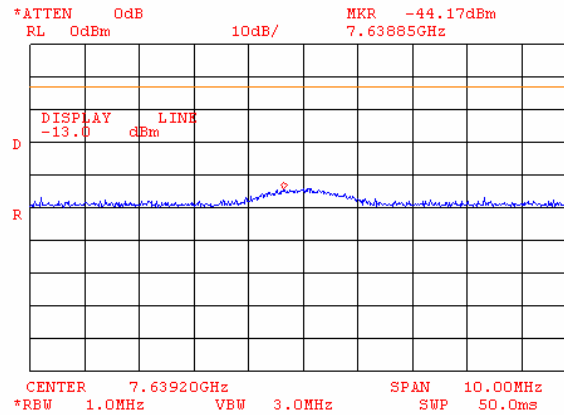

Plot 8.3.32 Conducted spurious emission measurements at the 5<sup>th</sup> harmonic of low carrier frequency

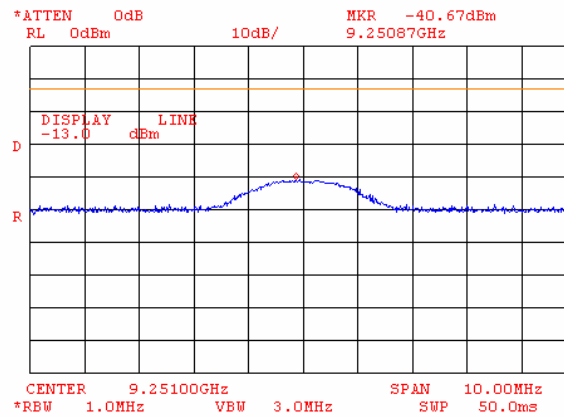

<b>Test specification:</b>	<b>Section 24.238, Spurious emission at antenna terminal</b>		
<b>Test procedure:</b>	FCC part 24, Section 24.238		
<b>Test mode:</b>	Compliance	<b>Verdict:</b>	<b>PASS</b>
<b>Date &amp; Time:</b>	10/20/2005 4:03:01 PM		
<b>Temperature:</b> 22 °C	<b>Air Pressure:</b> 1012 hPa	<b>Relative Humidity:</b> 46 %	<b>Power Supply:</b> 4 VDC
<b>Remarks:</b>			

Plot 8.3.33 Conducted spurious emission measurements at the 5<sup>th</sup> harmonic of mid carrier frequency

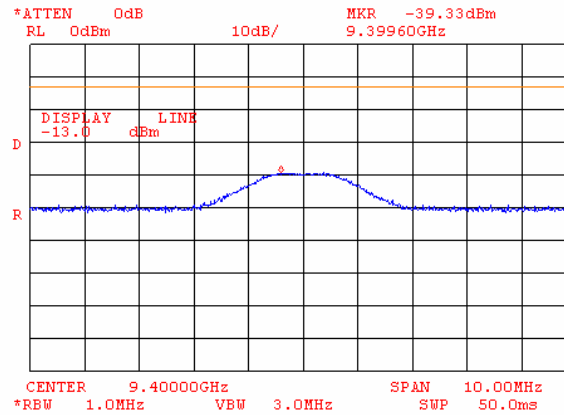

Plot 8.3.34 Conducted spurious emission measurements at the 5<sup>th</sup> harmonic of high carrier frequency

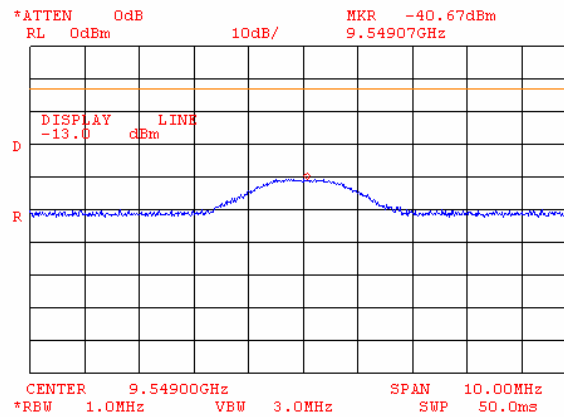

<b>Test specification:</b>	<b>Section 24.238, Spurious emission at antenna terminal</b>		
<b>Test procedure:</b>	FCC part 24, Section 24.238		
<b>Test mode:</b>	Compliance	<b>Verdict:</b>	<b>PASS</b>
<b>Date &amp; Time:</b>	10/20/2005 4:03:01 PM		
<b>Temperature:</b> 22 °C	<b>Air Pressure:</b> 1012 hPa	<b>Relative Humidity:</b> 46 %	<b>Power Supply:</b> 4 VDC
<b>Remarks:</b>			

Plot 8.3.35 Conducted spurious emission measurements at the 6<sup>th</sup> harmonic of low carrier frequency

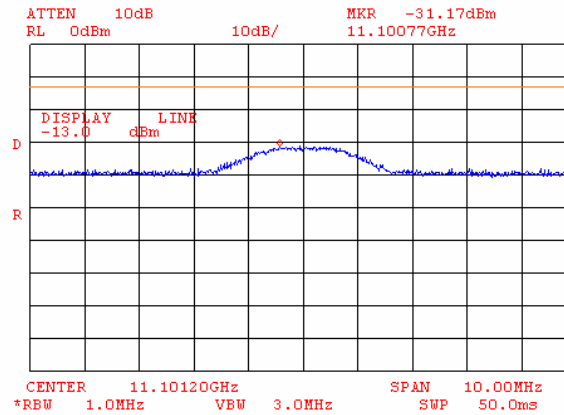

Plot 8.3.36 Conducted spurious emission measurements at the 6<sup>th</sup> harmonic of mid carrier frequency

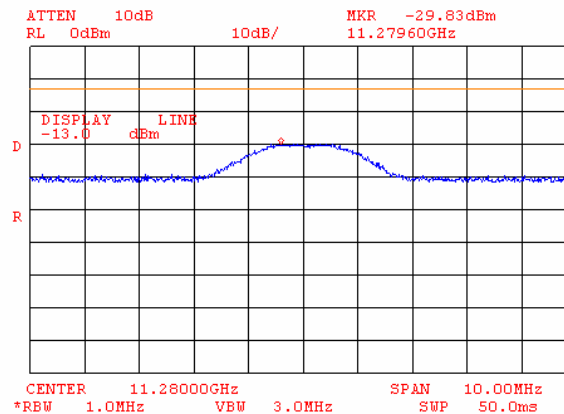

<b>Test specification:</b>	<b>Section 24.238, Spurious emission at antenna terminal</b>		
<b>Test procedure:</b>	FCC part 24, Section 24.238		
<b>Test mode:</b>	Compliance	<b>Verdict:</b>	<b>PASS</b>
<b>Date &amp; Time:</b>	10/20/2005 4:03:01 PM		
<b>Temperature:</b> 22 °C	<b>Air Pressure:</b> 1012 hPa	<b>Relative Humidity:</b> 46 %	<b>Power Supply:</b> 4 VDC
<b>Remarks:</b>			

Plot 8.3.37 Conducted spurious emission measurements at the 6<sup>th</sup> harmonic of high carrier frequency

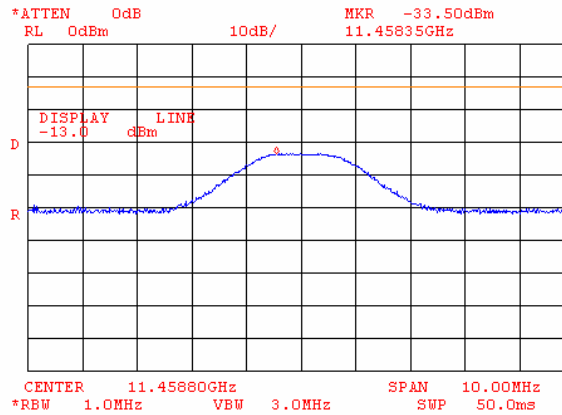

Plot 8.3.38 Conducted spurious emission measurements at the 7<sup>th</sup> harmonic of low carrier frequency

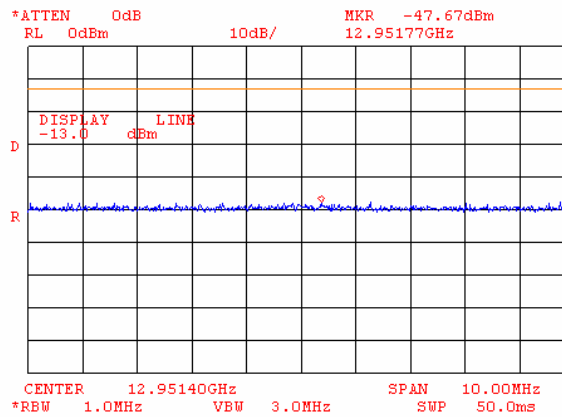

<b>Test specification:</b>	<b>Section 24.238, Spurious emission at antenna terminal</b>		
<b>Test procedure:</b>	FCC part 24, Section 24.238		
<b>Test mode:</b>	Compliance	<b>Verdict:</b>	<b>PASS</b>
<b>Date &amp; Time:</b>	10/20/2005 4:03:01 PM		
<b>Temperature:</b> 22 °C	<b>Air Pressure:</b> 1012 hPa	<b>Relative Humidity:</b> 46 %	<b>Power Supply:</b> 4 VDC
<b>Remarks:</b>			

Plot 8.3.39 Conducted spurious emission measurements at the 7<sup>th</sup> harmonic of mid carrier frequency

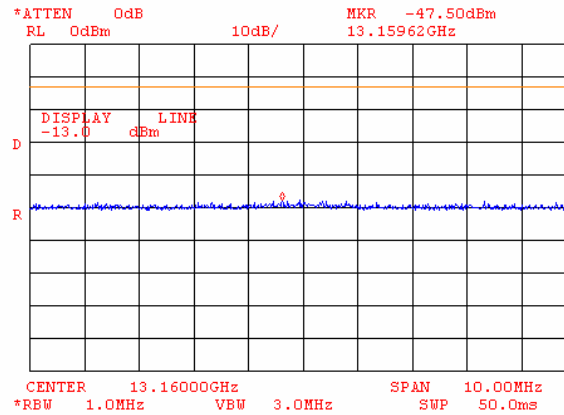

Plot 8.3.40 Conducted spurious emission measurements at the 7<sup>th</sup> harmonic of high carrier frequency

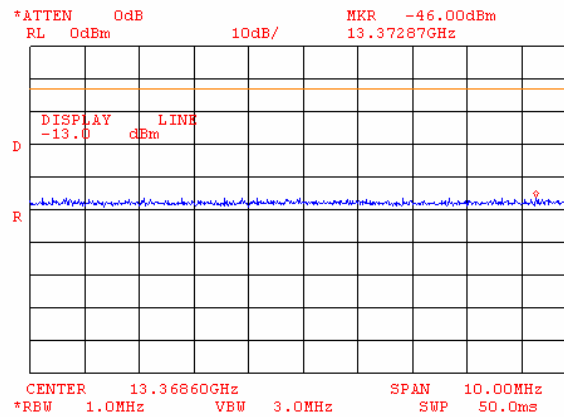

<b>Test specification:</b>	<b>Section 24.238, Spurious emission at antenna terminal</b>		
<b>Test procedure:</b>	FCC part 24, Section 24.238		
<b>Test mode:</b>	Compliance	<b>Verdict:</b>	<b>PASS</b>
<b>Date &amp; Time:</b>	10/20/2005 4:03:01 PM		
<b>Temperature:</b> 22 °C	<b>Air Pressure:</b> 1012 hPa	<b>Relative Humidity:</b> 46 %	<b>Power Supply:</b> 4 VDC
<b>Remarks:</b>			

Plot 8.3.41 Conducted spurious emission measurements at the 8<sup>th</sup> harmonic of low carrier frequency

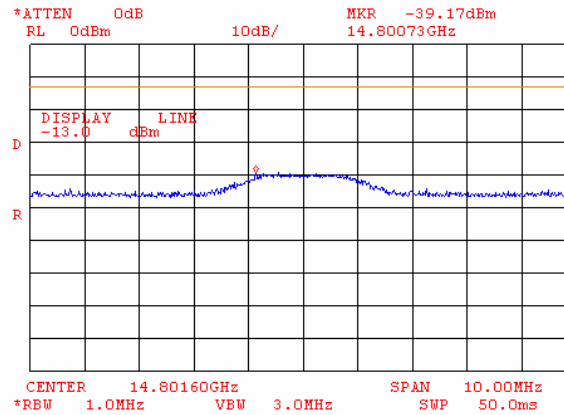

Plot 8.3.42 Conducted spurious emission measurements at the 8<sup>th</sup> harmonic of mid carrier frequency

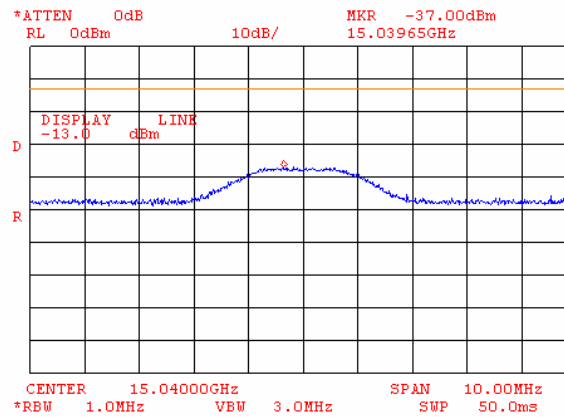



<b>Test specification:</b>	<b>Section 24.238, Spurious emission at antenna terminal</b>		
<b>Test procedure:</b>	FCC part 24, Section 24.238		
<b>Test mode:</b>	Compliance	<b>Verdict:</b>	<b>PASS</b>
<b>Date &amp; Time:</b>	10/20/2005 4:03:01 PM		
<b>Temperature:</b> 22 °C	<b>Air Pressure:</b> 1012 hPa	<b>Relative Humidity:</b> 46 %	<b>Power Supply:</b> 4 VDC
<b>Remarks:</b>			

Plot 8.3.43 Conducted spurious emission measurements at the 8<sup>th</sup> harmonic of high carrier frequency

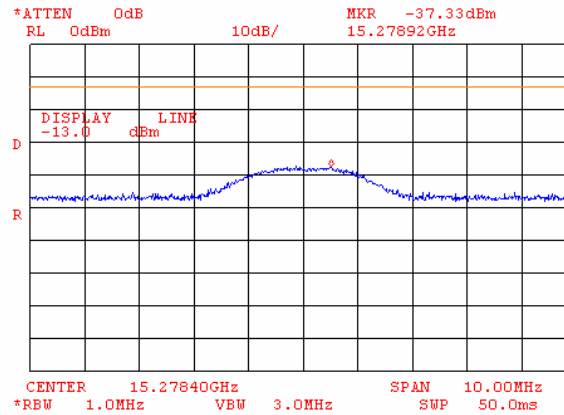

Plot 8.3.44 Conducted spurious emission measurements at the 9<sup>th</sup> harmonic of low carrier frequency

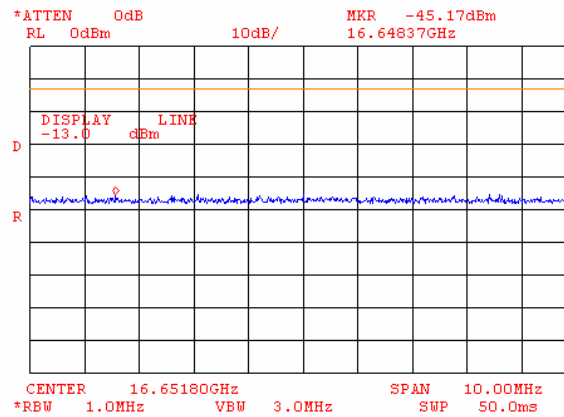

<b>Test specification:</b>	<b>Section 24.238, Spurious emission at antenna terminal</b>		
<b>Test procedure:</b>	FCC part 24, Section 24.238		
<b>Test mode:</b>	Compliance	<b>Verdict:</b>	<b>PASS</b>
<b>Date &amp; Time:</b>	10/20/2005 4:03:01 PM		
<b>Temperature:</b> 22 °C	<b>Air Pressure:</b> 1012 hPa	<b>Relative Humidity:</b> 46 %	<b>Power Supply:</b> 4 VDC
<b>Remarks:</b>			

Plot 8.3.45 Conducted spurious emission measurements at the 9<sup>th</sup> harmonic of mid carrier frequency

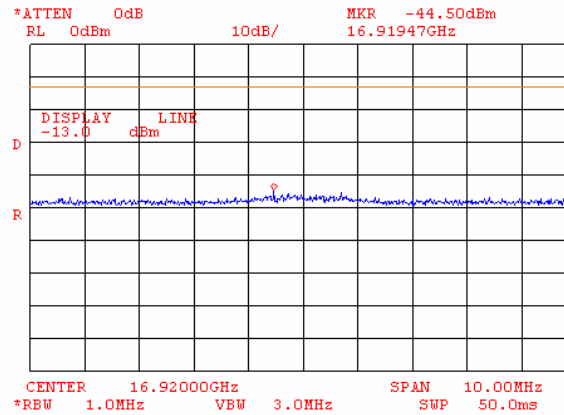

Plot 8.3.46 Conducted spurious emission measurements at the 9<sup>th</sup> harmonic of high carrier frequency

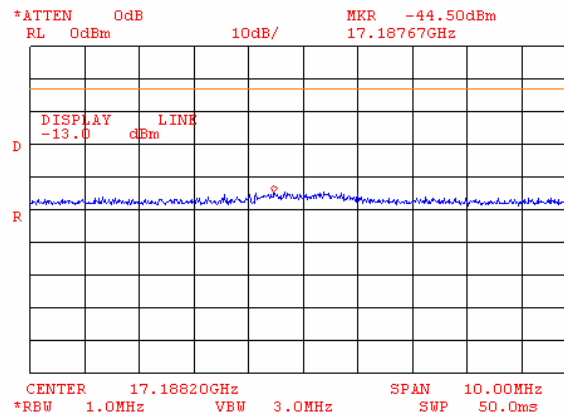

<b>Test specification:</b>	<b>Section 24.238, Spurious emission at antenna terminal</b>		
<b>Test procedure:</b>	FCC part 24, Section 24.238		
<b>Test mode:</b>	Compliance	<b>Verdict:</b>	<b>PASS</b>
<b>Date &amp; Time:</b>	10/20/2005 4:03:01 PM		
<b>Temperature:</b> 22 °C	<b>Air Pressure:</b> 1012 hPa	<b>Relative Humidity:</b> 46 %	<b>Power Supply:</b> 4 VDC
<b>Remarks:</b>			

Plot 8.3.47 Conducted spurious emission measurements at the 10<sup>th</sup> harmonic of low carrier frequency

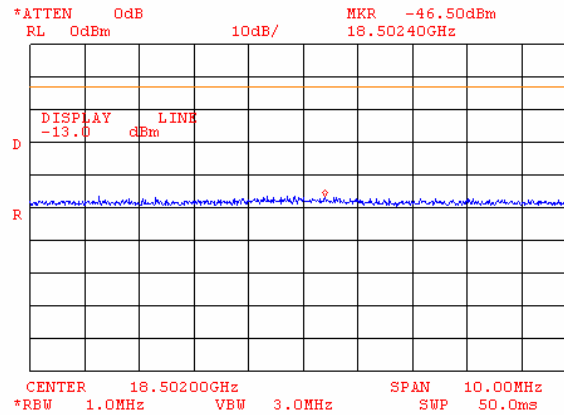

Plot 8.3.48 Conducted spurious emission measurements at the 10<sup>th</sup> harmonic of mid carrier frequency

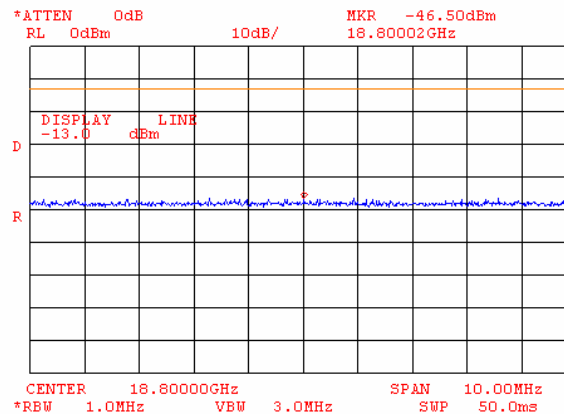

<b>Test specification:</b>	<b>Section 24.238, Spurious emission at antenna terminal</b>		
<b>Test procedure:</b>	FCC part 24, Section 24.238		
<b>Test mode:</b>	Compliance	<b>Verdict:</b>	<b>PASS</b>
<b>Date &amp; Time:</b>	10/20/2005 4:03:01 PM		
<b>Temperature:</b> 22 °C	<b>Air Pressure:</b> 1012 hPa	<b>Relative Humidity:</b> 46 %	<b>Power Supply:</b> 4 VDC
<b>Remarks:</b>			

Plot 8.3.49 Conducted spurious emission measurements at the 10<sup>th</sup> harmonic of high carrier frequency

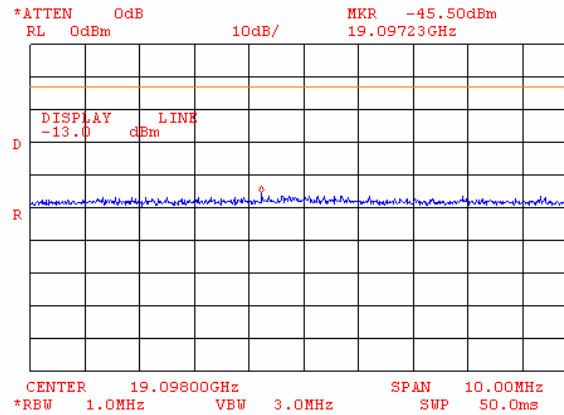

<b>Test specification:</b>	<b>Section 24.238, Radiated spurious emissions</b>		
<b>Test procedure:</b>	Public notice DA 00-705		
<b>Test mode:</b>	Compliance	<b>Verdict:</b>	<b>PASS</b>
<b>Date &amp; Time:</b>	10/16/2005 3:30:32 PM		
<b>Temperature:</b> 24 °C	<b>Air Pressure:</b> 1012 hPa	<b>Relative Humidity:</b> 45 %	<b>Power Supply:</b> 4 VDC
<b>Remarks:</b>			

## 8.4 Field strength of spurious emissions

### 8.4.1 General

This test was performed to measure field strength of spurious emissions from the EUT. Specification test limit is given in Table 8.4.1.

**Table 8.4.1 Radiated spurious emissions limits**

Frequency, MHz	Attenuation below carrier, dBc	ERP of spurious, dBm	Equivalent field strength limit @ 3m, dB( $\mu$ V/m)**
0.009 – 10 <sup>th</sup> harmonic	43+10logP*	-13	84.4

\* - P is transmitter output power in Watts.

\*\* - Equivalent field strength limit was calculated from maximum allowed ERP of spurious as follows:  $E = \sqrt{30 \times P \times 1.64} / r$ , where P is ERP in Watts, 1.64 is numeric gain of ideal dipole and r is antenna to EUT distance in meters.

### 8.4.2 Test procedure for spurious emission field strength measurements in 9 kHz to 30 MHz band

8.4.2.1 The EUT was set up as shown in Figure 8.4.1, energized and the performance check was conducted.

8.4.2.2 The specified frequency range was investigated with antenna connected to spectrum analyzer/ EMI receiver. To find maximum radiation the turntable was rotated 360° and the measuring antenna was rotated around its vertical axis.

8.4.2.3 The worst test results (the lowest margins) were recorded and shown in the associated plots.

### 8.4.3 Test procedure for spurious emission field strength measurements above 30 MHz

8.4.3.1 The EUT was set up as shown in Figure 8.4.2, energized and the performance check was conducted.

8.4.3.2 The specified frequency range was investigated with antenna connected to spectrum analyzer/ EMI receiver. To find maximum radiation the turntable was rotated 360°, the measuring antenna height was changed from 1 to 4 m, its polarization was switched from vertical to horizontal.

8.4.3.3 The worst test results (the lowest margins) were recorded and shown in the associated plots.

<b>Test specification:</b> Section 24.238, Radiated spurious emissions			
<b>Test procedure:</b> Public notice DA 00-705			
<b>Test mode:</b> Compliance	<b>Verdict:</b> PASS		
<b>Date &amp; Time:</b> 10/16/2005 3:30:32 PM			
<b>Temperature:</b> 24 °C	<b>Air Pressure:</b> 1012 hPa	<b>Relative Humidity:</b> 45 %	<b>Power Supply:</b> 4 VDC
<b>Remarks:</b>			

Figure 8.4.1 Setup for spurious emission field strength measurements below 30 MHz

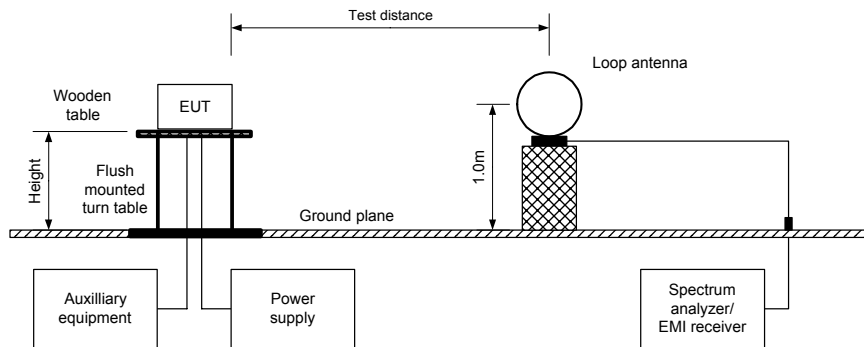
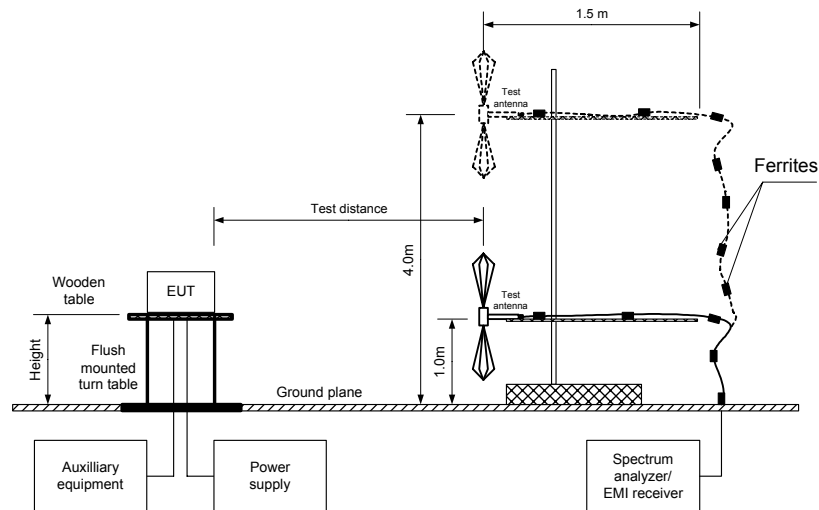

Figure 8.4.2 Setup for spurious emission field strength measurements above 30 MHz



<b>Test specification:</b>		<b>Section 24.238, Radiated spurious emissions</b>	
<b>Test procedure:</b>		Public notice DA 00-705	
<b>Test mode:</b>	Compliance	<b>Verdict:</b>	<b>PASS</b>
<b>Date &amp; Time:</b>	10/16/2005 3:30:32 PM		
<b>Temperature:</b> 24 °C	<b>Air Pressure:</b> 1012 hPa	<b>Relative Humidity:</b> 45 %	<b>Power Supply:</b> 4 VDC
<b>Remarks:</b>			

**Table 8.4.2 Field strength of emissions**

ASSIGNED FREQUENCY RANGE: 1850 - 1910 MHz  
 INVESTIGATED FREQUENCY RANGE: 0.009 – 20000 MHz  
 TEST DISTANCE: 3 m  
 MODULATION: Unmodulated  
 DUTY CYCLE: 100 %  
 TRANSMITTER OUTPUT POWER SETTINGS: Maximum  
 TRANSMITTER OUTPUT POWER: 30.13 dBm at low carrier frequency  
 30.17 dBm at mid carrier frequency  
 30.00 dBm at high carrier frequency

DETECTOR USED: Peak  
 TEST ANTENNA TYPE: Active loop (9 kHz – 30 MHz)  
 Biconilog (30 MHz – 1000 MHz)  
 Double ridged guide (1000 MHz – 18000 MHz)  
 Standard gain horn (above 18 GHz)

Frequency, MHz	Field strength of spurious, dB(μV/m)	Limit, dB(μV/m)	Margin, dB	Antenna polarization	Antenna height, m	Azimuth, degrees*
No spurious emissions were found						

\*- EUT front panel refers to 0 degrees position of turntable.

\*\*- Margin = Attenuation below carrier – specification limit.

**Reference numbers of test equipment used**

HL 0410	HL 0446	HL 0521	HL 0589	HL 0592	HL 0593	HL 0594	HL 0604
HL 0768	HL 1200	HL 1424	HL 1942	HL 1947	HL 1984	HL 2009	HL 2259
HL 2260	HL 2387	HL 2399					

Full description is given in Appendix A.

<b>Test specification:</b> Section 24.238, Radiated spurious emissions			
<b>Test procedure:</b> Public notice DA 00-705			
<b>Test mode:</b> Compliance	<b>Verdict:</b> PASS		
<b>Date &amp; Time:</b> 10/16/2005 3:30:32 PM			
<b>Temperature:</b> 24 °C	<b>Air Pressure:</b> 1012 hPa	<b>Relative Humidity:</b> 45 %	<b>Power Supply:</b> 4 VDC
<b>Remarks:</b>			

**Plot 8.4.1 Radiated emission measurements from 9 to 150 kHz at the low carrier frequency**

TEST SITE: Semi anechoic chamber  
TEST DISTANCE: 3 m  
ANTENNA POLARIZATION: Vertical

10:36:23 OCT 17, 2005

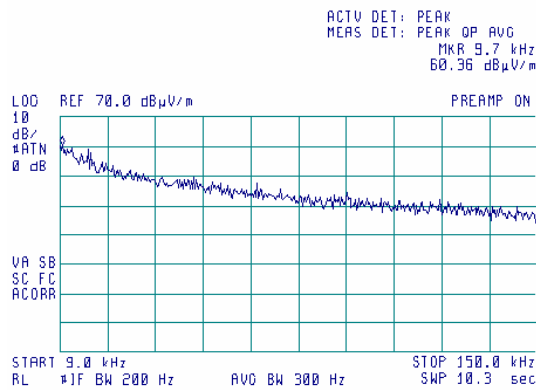

**Plot 8.4.2 Radiated emission measurements from 9 to 150 kHz at the mid carrier frequency**

TEST SITE: Semi anechoic chamber  
TEST DISTANCE: 3 m  
ANTENNA POLARIZATION: Vertical

10:44:44 OCT 17, 2005

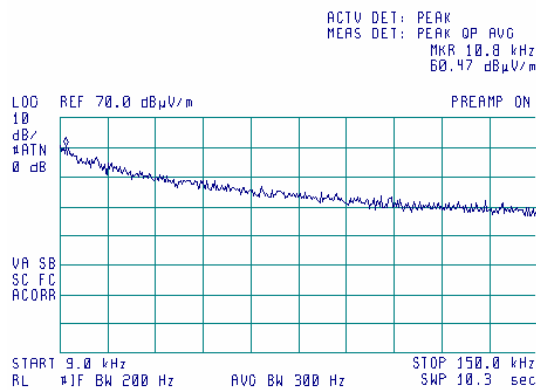



<b>Test specification:</b>	<b>Section 24.238, Radiated spurious emissions</b>		
<b>Test procedure:</b>	Public notice DA 00-705		
<b>Test mode:</b>	Compliance	<b>Verdict:</b>	<b>PASS</b>
<b>Date &amp; Time:</b>	10/16/2005 3:30:32 PM		
<b>Temperature:</b> 24 °C	<b>Air Pressure:</b> 1012 hPa	<b>Relative Humidity:</b> 45 %	<b>Power Supply:</b> 4 VDC
<b>Remarks:</b>			

**Plot 8.4.3 Radiated emission measurements from 9 to 150 kHz at the high carrier frequency**

TEST SITE: Semi anechoic chamber  
TEST DISTANCE: 3 m  
ANTENNA POLARIZATION: Vertical

10:58:51 OCT 17, 2005

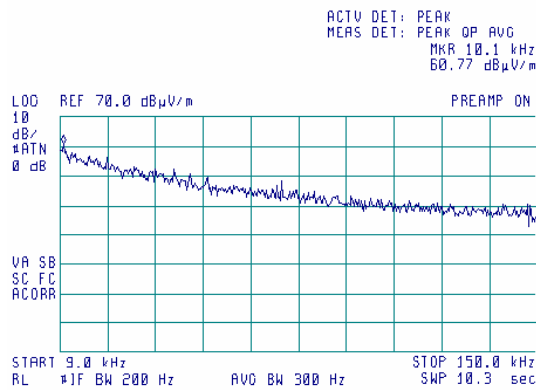

**Plot 8.4.4 Radiated emission measurements from 0.15 to 30 MHz at the low carrier frequency**

TEST SITE: Semi anechoic chamber  
TEST DISTANCE: 3 m  
ANTENNA POLARIZATION: Vertical

10:27:09 OCT 17, 2005

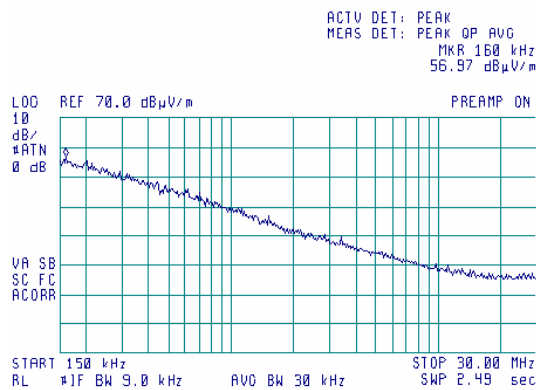

<b>Test specification:</b> Section 24.238, Radiated spurious emissions			
<b>Test procedure:</b> Public notice DA 00-705			
<b>Test mode:</b> Compliance	<b>Verdict:</b> PASS		
<b>Date &amp; Time:</b> 10/16/2005 3:30:32 PM			
<b>Temperature:</b> 24 °C	<b>Air Pressure:</b> 1012 hPa	<b>Relative Humidity:</b> 45 %	<b>Power Supply:</b> 4 VDC
<b>Remarks:</b>			

**Plot 8.4.5 Radiated emission measurements from 0.15 to 30 MHz at the mid carrier frequency**

TEST SITE: Semi anechoic chamber  
TEST DISTANCE: 3 m  
ANTENNA POLARIZATION: Vertical

10:51:04 OCT 17, 2005

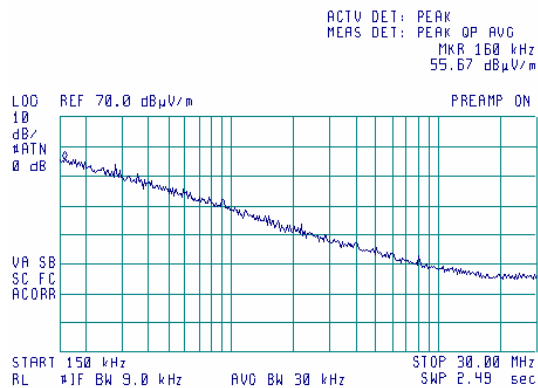

**Plot 8.4.6 Radiated emission measurements from 0.15 to 30 MHz at the high carrier frequency**

TEST SITE: Semi anechoic chamber  
TEST DISTANCE: 3 m  
ANTENNA POLARIZATION: Vertical

10:55:55 OCT 17, 2005

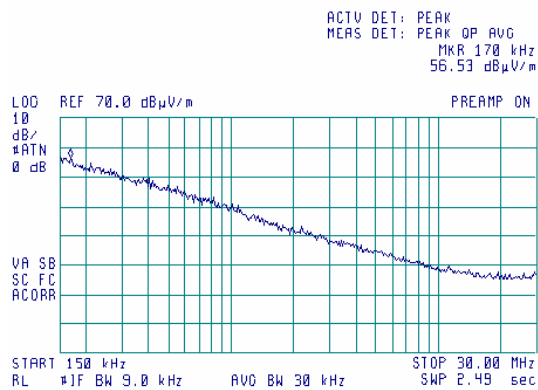

<b>Test specification:</b> Section 24.238, Radiated spurious emissions			
<b>Test procedure:</b> Public notice DA 00-705			
<b>Test mode:</b> Compliance	<b>Verdict:</b> PASS		
<b>Date &amp; Time:</b> 10/16/2005 3:30:32 PM			
<b>Temperature:</b> 24 °C	<b>Air Pressure:</b> 1012 hPa	<b>Relative Humidity:</b> 45 %	<b>Power Supply:</b> 4 VDC
<b>Remarks:</b>			

**Plot 8.4.7 Radiated emission measurements from 30 to 1000 MHz at the low carrier frequency**

TEST SITE: Semi anechoic chamber  
TEST DISTANCE: 3 m  
ANTENNA POLARIZATION: Vertical and Horizontal

14:46:09 OCT 16, 2005

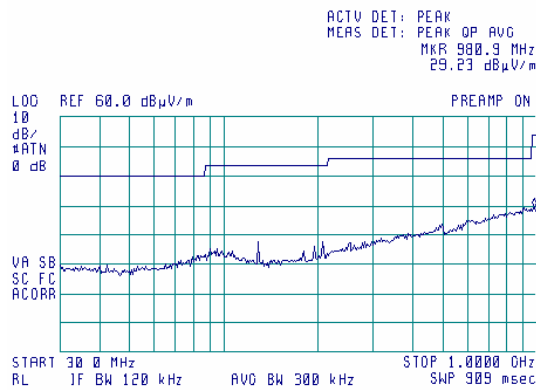

**Plot 8.4.8 Radiated emission measurements from 30 to 1000 MHz at the mid carrier frequency**

TEST SITE: Semi anechoic chamber  
TEST DISTANCE: 3 m  
ANTENNA POLARIZATION: Vertical and Horizontal

14:50:24 OCT 16, 2005

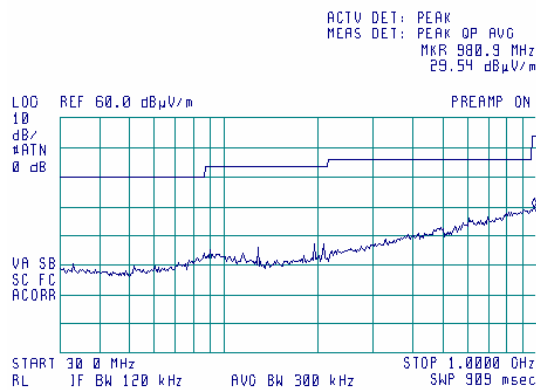

<b>Test specification:</b>	<b>Section 24.238, Radiated spurious emissions</b>		
<b>Test procedure:</b>	Public notice DA 00-705		
<b>Test mode:</b>	Compliance	<b>Verdict:</b>	<b>PASS</b>
<b>Date &amp; Time:</b>	10/16/2005 3:30:32 PM		
<b>Temperature:</b> 24 °C	<b>Air Pressure:</b> 1012 hPa	<b>Relative Humidity:</b> 45 %	<b>Power Supply:</b> 4 VDC
<b>Remarks:</b>			

**Plot 8.4.9 Radiated emission measurements from 30 to 1000 MHz at the high carrier frequency**

TEST SITE: Semi anechoic chamber  
TEST DISTANCE: 3 m  
ANTENNA POLARIZATION: Vertical and Horizontal

14:53:30 OCT 16, 2005

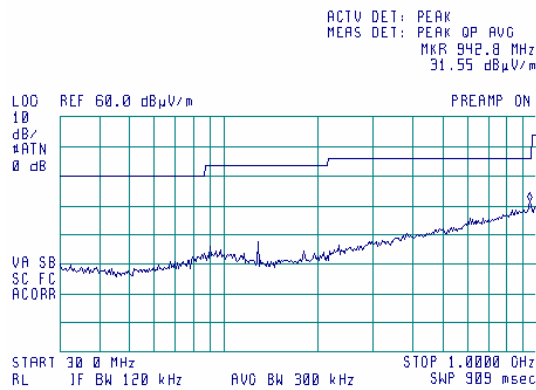

**Plot 8.4.10 Radiated emission measurements from 1000 to 2900 MHz at the low carrier frequency**

TEST SITE: Semi anechoic chamber  
TEST DISTANCE: 3 m  
ANTENNA POLARIZATION: Vertical and Horizontal

15:36:34 OCT 16, 2005

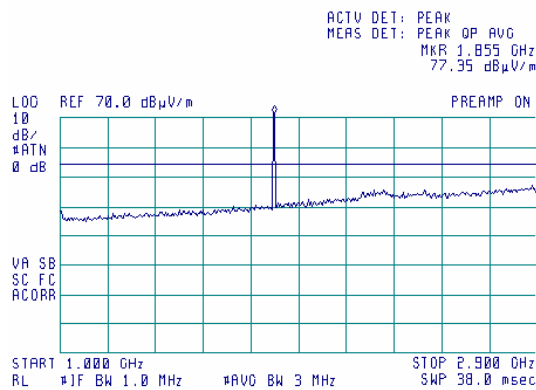

<b>Test specification:</b>		<b>Section 24.238, Radiated spurious emissions</b>	
<b>Test procedure:</b>		Public notice DA 00-705	
<b>Test mode:</b>	Compliance	<b>Verdict:</b>	PASS
<b>Date &amp; Time:</b>	10/16/2005 3:30:32 PM		
<b>Temperature:</b> 24 °C	<b>Air Pressure:</b> 1012 hPa	<b>Relative Humidity:</b> 45 %	<b>Power Supply:</b> 4 VDC
<b>Remarks:</b>			

**Plot 8.4.11 Radiated emission measurements from 1000 to 2900 MHz at the mid carrier frequency**

TEST SITE: Semi anechoic chamber  
TEST DISTANCE: 3 m  
ANTENNA POLARIZATION: Vertical and Horizontal

15:18:04 OCT 16, 2005

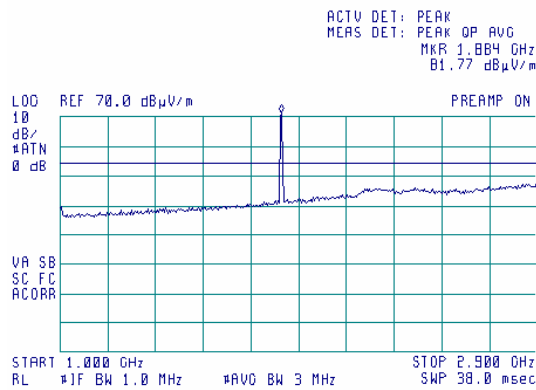

**Plot 8.4.12 Radiated emission measurements from 1000 to 2900 MHz at the high carrier frequency**

TEST SITE: Semi anechoic chamber  
TEST DISTANCE: 3 m  
ANTENNA POLARIZATION: Vertical and Horizontal

15:13:47 OCT 16, 2005

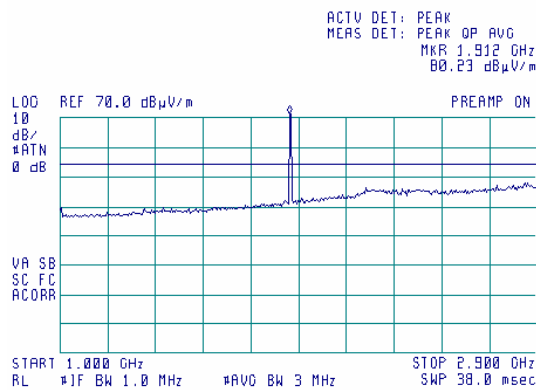

<b>Test specification:</b>	<b>Section 24.238, Radiated spurious emissions</b>		
<b>Test procedure:</b>	Public notice DA 00-705		
<b>Test mode:</b>	Compliance	<b>Verdict:</b>	<b>PASS</b>
<b>Date &amp; Time:</b>	10/16/2005 3:30:32 PM		
<b>Temperature:</b> 24 °C	<b>Air Pressure:</b> 1012 hPa	<b>Relative Humidity:</b> 45 %	<b>Power Supply:</b> 4 VDC
<b>Remarks:</b>			

**Plot 8.4.13 Radiated emission measurements from 2900 to 6500 MHz at the low carrier frequency**

TEST SITE: Semi anechoic chamber  
TEST DISTANCE: 3 m  
ANTENNA POLARIZATION: Vertical and Horizontal

15:31:47 OCT 16, 2005

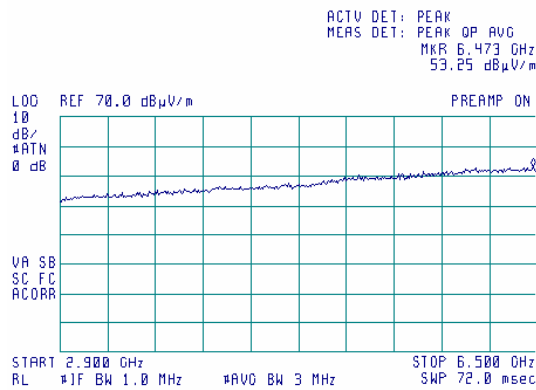

**Plot 8.4.14 Radiated emission measurements from 2900 to 6500 MHz at the mid carrier frequency**

TEST SITE: Semi anechoic chamber  
TEST DISTANCE: 3 m  
ANTENNA POLARIZATION: Vertical and Horizontal

15:22:51 OCT 16, 2005

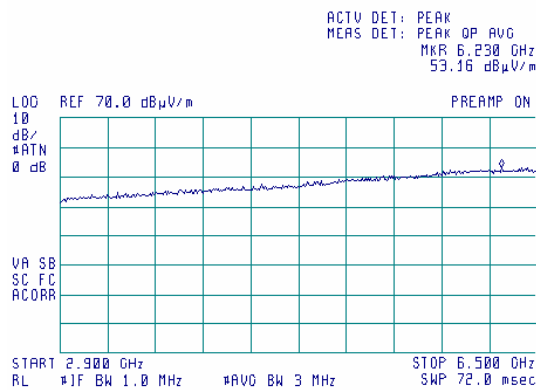

<b>Test specification:</b>	<b>Section 24.238, Radiated spurious emissions</b>		
<b>Test procedure:</b>	Public notice DA 00-705		
<b>Test mode:</b>	Compliance	<b>Verdict:</b>	<b>PASS</b>
<b>Date &amp; Time:</b>	10/16/2005 3:30:32 PM		
<b>Temperature:</b> 24 °C	<b>Air Pressure:</b> 1012 hPa	<b>Relative Humidity:</b> 45 %	<b>Power Supply:</b> 4 VDC
<b>Remarks:</b>			

**Plot 8.4.15 Radiated emission measurements from 2900 to 6500 MHz at the high carrier frequency**

TEST SITE: Semi anechoic chamber  
TEST DISTANCE: 3 m  
ANTENNA POLARIZATION: Vertical and Horizontal

15:27:09 OCT 16, 2005

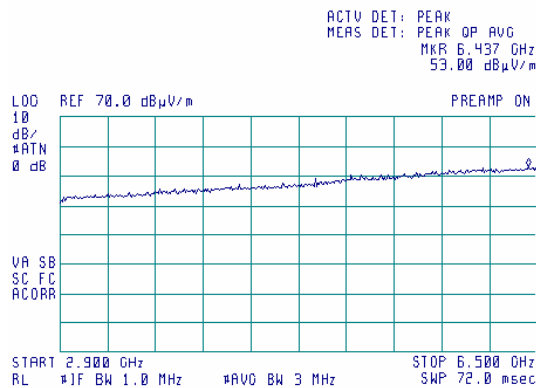

**Plot 8.4.16 Radiated emission measurements from 6.5 to 14 GHz at the low carrier frequency**

TEST SITE: Semi anechoic chamber  
TEST DISTANCE: 3 m  
ANTENNA POLARIZATION: Vertical and Horizontal

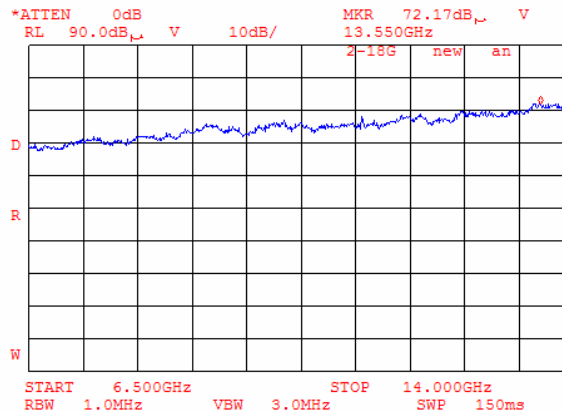

<b>Test specification:</b>	<b>Section 24.238, Radiated spurious emissions</b>		
<b>Test procedure:</b>	Public notice DA 00-705		
<b>Test mode:</b>	Compliance	<b>Verdict:</b>	<b>PASS</b>
<b>Date &amp; Time:</b>	10/16/2005 3:30:32 PM		
<b>Temperature:</b> 24 °C	<b>Air Pressure:</b> 1012 hPa	<b>Relative Humidity:</b> 45 %	<b>Power Supply:</b> 4 VDC
<b>Remarks:</b>			

**Plot 8.4.17 Radiated emission measurements from 6.5 to 14 GHz at the mid carrier frequency**

TEST SITE: Semi anechoic chamber  
TEST DISTANCE: 3 m  
ANTENNA POLARIZATION: Vertical and Horizontal

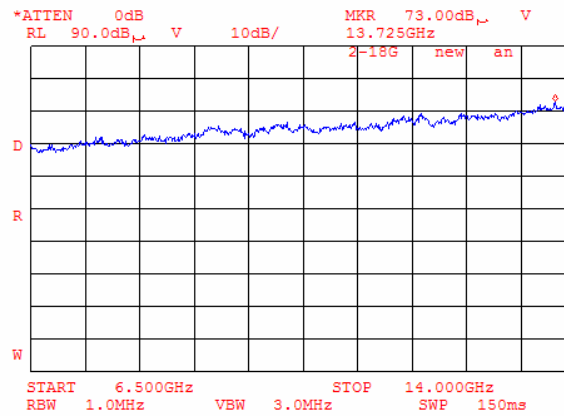

**Plot 8.4.18 Radiated emission measurements from 6.5 to 14 GHz at the high carrier frequency**

TEST SITE: Semi anechoic chamber  
TEST DISTANCE: 3 m  
ANTENNA POLARIZATION: Vertical and Horizontal

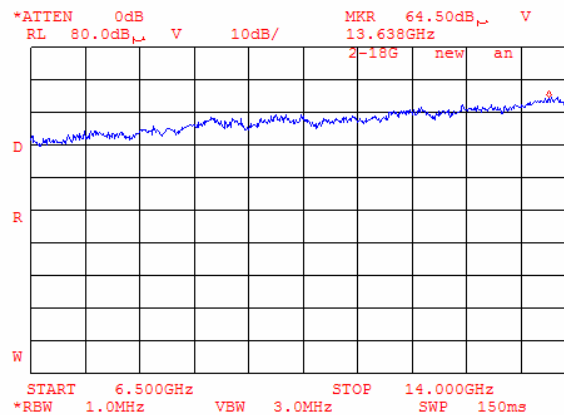



<b>Test specification:</b>	<b>Section 24.238, Radiated spurious emissions</b>		
<b>Test procedure:</b>	Public notice DA 00-705		
<b>Test mode:</b>	Compliance	<b>Verdict:</b>	<b>PASS</b>
<b>Date &amp; Time:</b>	10/16/2005 3:30:32 PM		
<b>Temperature:</b> 24 °C	<b>Air Pressure:</b> 1012 hPa	<b>Relative Humidity:</b> 45 %	<b>Power Supply:</b> 4 VDC
<b>Remarks:</b>			

**Plot 8.4.19 Radiated emission measurements from 14 to 18 GHz at the low carrier frequency**

TEST SITE: Semi anechoic chamber  
TEST DISTANCE: 3 m  
ANTENNA POLARIZATION: Vertical and Horizontal

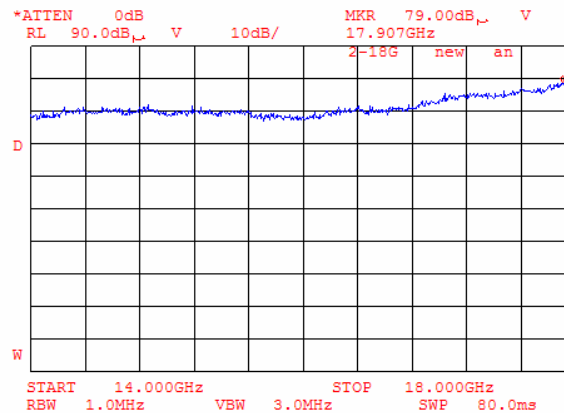

**Plot 8.4.20 Radiated emission measurements from 14 to 18 GHz at the mid carrier frequency**

TEST SITE: Semi anechoic chamber  
TEST DISTANCE: 3 m  
ANTENNA POLARIZATION: Vertical and Horizontal

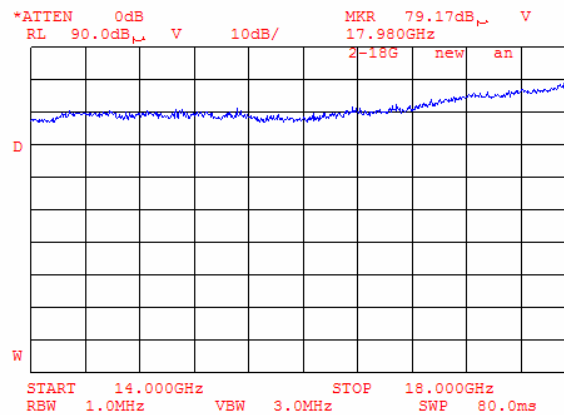

<b>Test specification:</b>	<b>Section 24.238, Radiated spurious emissions</b>		
<b>Test procedure:</b>	Public notice DA 00-705		
<b>Test mode:</b>	Compliance	<b>Verdict:</b>	<b>PASS</b>
<b>Date &amp; Time:</b>	10/16/2005 3:30:32 PM		
<b>Temperature:</b> 24 °C	<b>Air Pressure:</b> 1012 hPa	<b>Relative Humidity:</b> 45 %	<b>Power Supply:</b> 4 VDC
<b>Remarks:</b>			

**Plot 8.4.21 Radiated emission measurements from 14 to 18 GHz at the high carrier frequency**

TEST SITE: Semi anechoic chamber  
TEST DISTANCE: 3 m  
ANTENNA POLARIZATION: Vertical and Horizontal

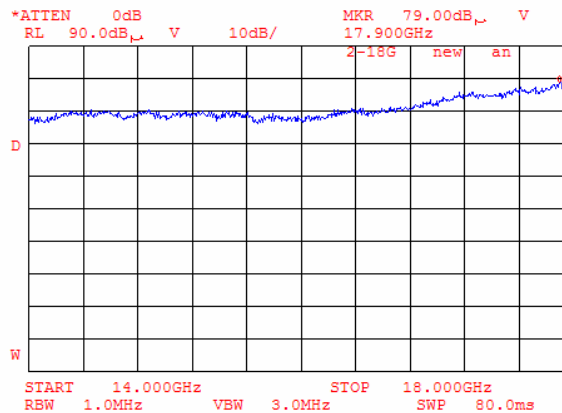

**Plot 8.4.22 Radiated emission measurements from 18 to 20 GHz at the low carrier frequency**

TEST SITE: OATS  
TEST DISTANCE: 3 m  
ANTENNA POLARIZATION: Vertical and Horizontal

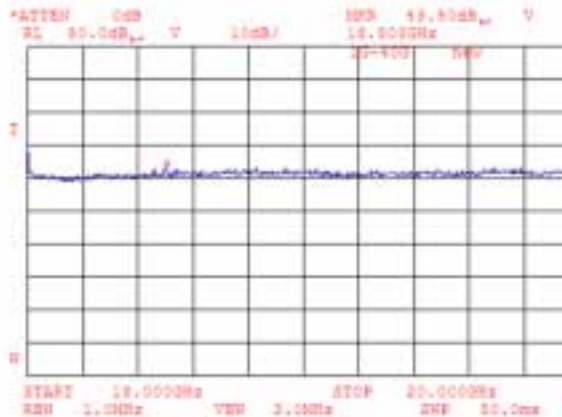

<b>Test specification:</b>		<b>Section 24.238, Radiated spurious emissions</b>	
<b>Test procedure:</b>		Public notice DA 00-705	
<b>Test mode:</b>	Compliance	<b>Verdict:</b>	PASS
<b>Date &amp; Time:</b>	10/16/2005 3:30:32 PM		
<b>Temperature:</b> 24 °C	<b>Air Pressure:</b> 1012 hPa	<b>Relative Humidity:</b> 45 %	<b>Power Supply:</b> 4 VDC
<b>Remarks:</b>			

Plot 8.4.23 Radiated emission measurements from 18 to 20 GHz at the mid carrier frequency

TEST SITE: OATS  
TEST DISTANCE: 3 m  
ANTENNA POLARIZATION: Vertical and Horizontal

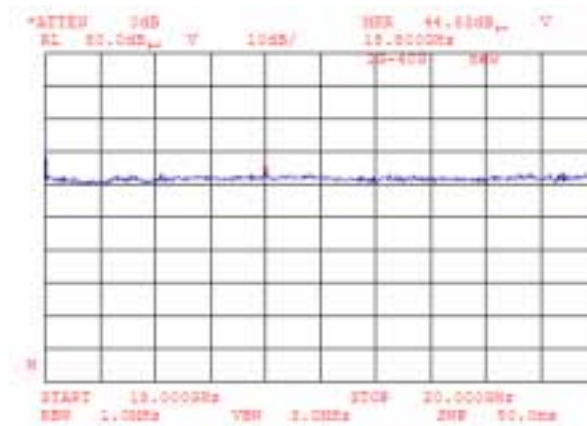

Plot 8.4.24 Radiated emission measurements from 18 to 20 GHz at the high carrier frequency

TEST SITE: OATS  
TEST DISTANCE: 3 m  
ANTENNA POLARIZATION: Vertical and Horizontal

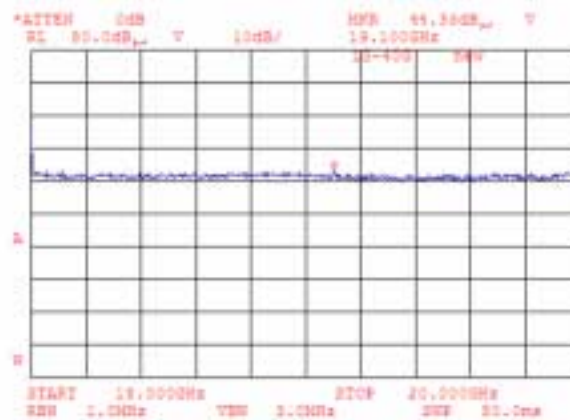

<b>Test specification:</b>	<b>Section 24.238, Radiated spurious emissions</b>		
<b>Test procedure:</b>	Public notice DA 00-705		
<b>Test mode:</b>	Compliance	<b>Verdict:</b>	<b>PASS</b>
<b>Date &amp; Time:</b>	10/16/2005 3:30:32 PM		
<b>Temperature:</b> 24 °C	<b>Air Pressure:</b> 1012 hPa	<b>Relative Humidity:</b> 45 %	<b>Power Supply:</b> 4 VDC
<b>Remarks:</b>			

**Plot 8.4.25 Radiated emission measurements at the second harmonic of low carrier frequency**

TEST SITE: Semi anechoic chamber  
TEST DISTANCE: 3 m

17:57:33 OCT 16, 2005

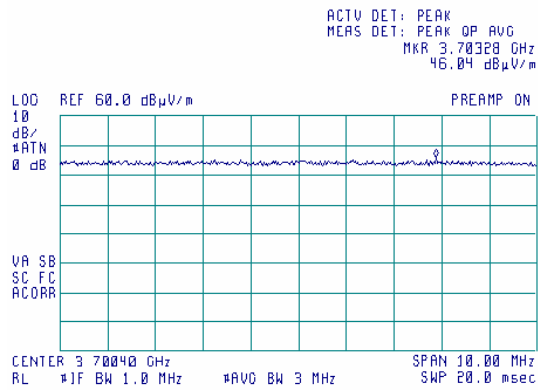

**Plot 8.4.26 Radiated emission measurements at the second harmonic of mid carrier frequency**

TEST SITE: Semi anechoic chamber  
TEST DISTANCE: 3 m

18:21:51 OCT 16, 2005

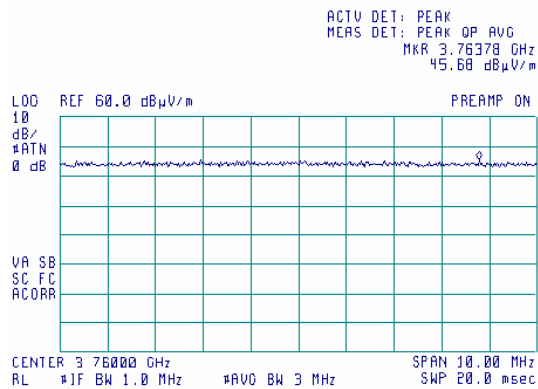

<b>Test specification:</b>	<b>Section 24.238, Radiated spurious emissions</b>		
<b>Test procedure:</b>	Public notice DA 00-705		
<b>Test mode:</b>	Compliance	<b>Verdict:</b>	<b>PASS</b>
<b>Date &amp; Time:</b>	10/16/2005 3:30:32 PM		
<b>Temperature:</b> 24 °C	<b>Air Pressure:</b> 1012 hPa	<b>Relative Humidity:</b> 45 %	<b>Power Supply:</b> 4 VDC
<b>Remarks:</b>			

**Plot 8.4.27 Radiated emission measurements at the second harmonic of high carrier frequency**

TEST SITE: Semi anechoic chamber  
TEST DISTANCE: 3 m

18:31:38 OCT 16, 2005

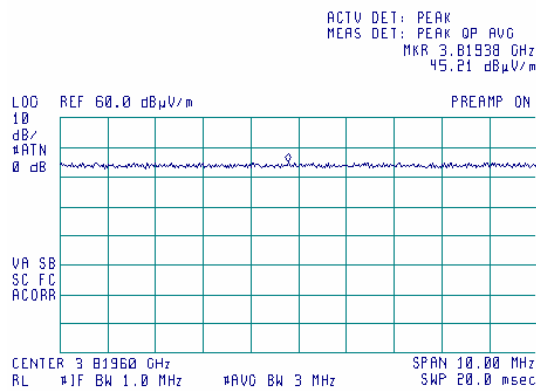

**Plot 8.4.28 Radiated emission measurements at the third harmonic of low carrier frequency**

TEST SITE: Semi anechoic chamber  
TEST DISTANCE: 3 m

18:00:59 OCT 16, 2005

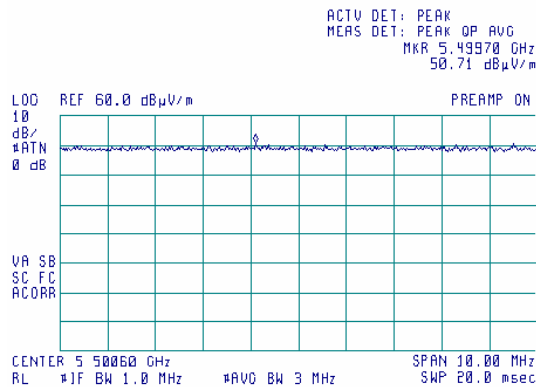

<b>Test specification:</b>		<b>Section 24.238, Radiated spurious emissions</b>	
<b>Test procedure:</b>		Public notice DA 00-705	
<b>Test mode:</b>	Compliance	<b>Verdict:</b>	PASS
<b>Date &amp; Time:</b>	10/16/2005 3:30:32 PM		
<b>Temperature:</b> 24 °C	<b>Air Pressure:</b> 1012 hPa	<b>Relative Humidity:</b> 45 %	<b>Power Supply:</b> 4 VDC
<b>Remarks:</b>			

**Plot 8.4.29 Radiated emission measurements at the third harmonic of mid carrier frequency**

TEST SITE: Semi anechoic chamber  
TEST DISTANCE: 3 m

18:24:59 OCT 16, 2005

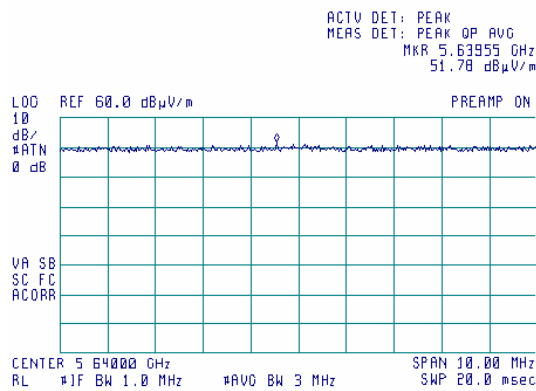

**Plot 8.4.30 Radiated emission measurements at the third harmonic of high carrier frequency**

TEST SITE: Semi anechoic chamber  
TEST DISTANCE: 3 m

18:28:58 OCT 16, 2005

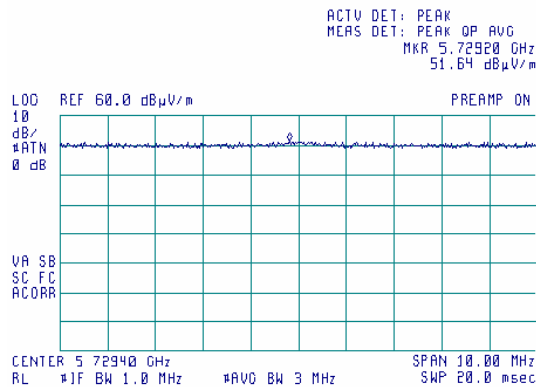

<b>Test specification:</b>	<b>Section 24.238, Radiated spurious emissions</b>		
<b>Test procedure:</b>	Public notice DA 00-705		
<b>Test mode:</b>	Compliance	<b>Verdict:</b>	<b>PASS</b>
<b>Date &amp; Time:</b>	10/16/2005 3:30:32 PM		
<b>Temperature:</b> 24 °C	<b>Air Pressure:</b> 1012 hPa	<b>Relative Humidity:</b> 45 %	<b>Power Supply:</b> 4 VDC
<b>Remarks:</b>			

**Plot 8.4.31 Radiated emission measurements at the fourth harmonic of low carrier frequency**

TEST SITE: Semi anechoic chamber  
TEST DISTANCE: 3 m

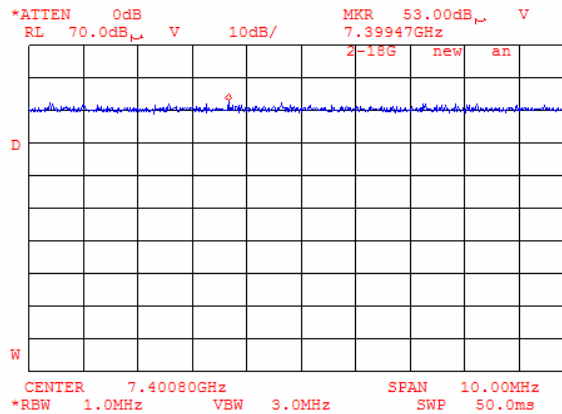

**Plot 8.4.32 Radiated emission measurements at the fourth harmonic of mid carrier frequency**

TEST SITE: Semi anechoic chamber  
TEST DISTANCE: 3 m

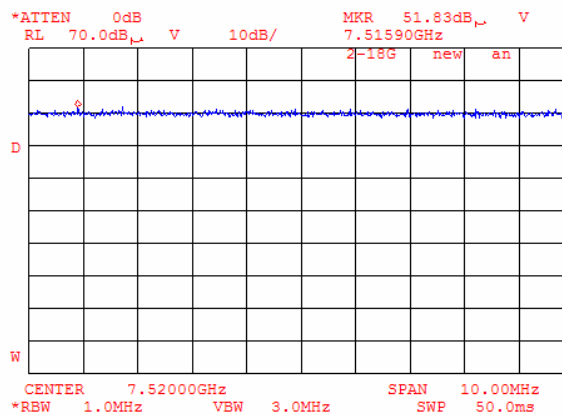

<b>Test specification:</b>	<b>Section 24.238, Radiated spurious emissions</b>		
<b>Test procedure:</b>	Public notice DA 00-705		
<b>Test mode:</b>	Compliance	<b>Verdict: PASS</b>	
<b>Date &amp; Time:</b>	10/16/2005 3:30:32 PM		
<b>Temperature:</b> 24 °C	<b>Air Pressure:</b> 1012 hPa	<b>Relative Humidity:</b> 45 %	<b>Power Supply:</b> 4 VDC
<b>Remarks:</b>			

**Plot 8.4.33 Radiated emission measurements at the fourth harmonic of high carrier frequency**

TEST SITE: Semi anechoic chamber  
TEST DISTANCE: 3 m

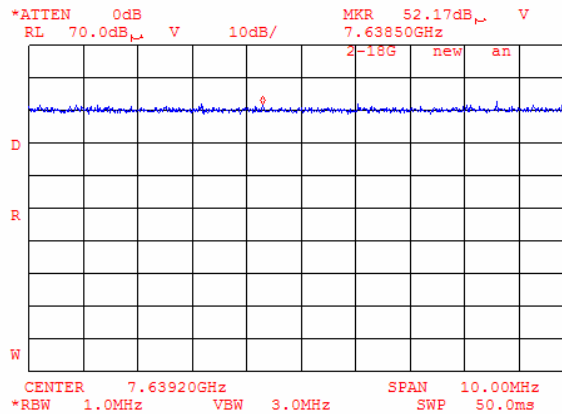

**Plot 8.4.34 Radiated emission measurements at the fifth harmonic of low carrier frequency**

TEST SITE: OATS  
TEST DISTANCE: 3 m

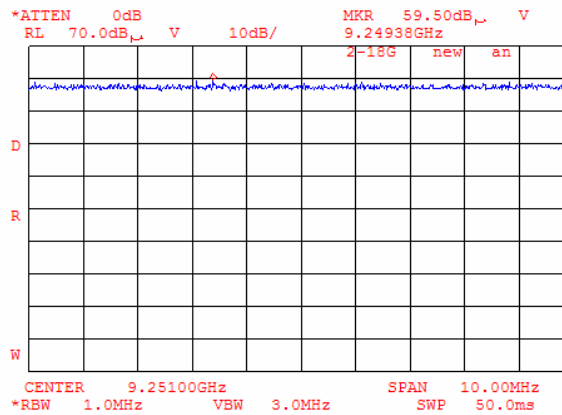



<b>Test specification:</b>	<b>Section 24.238, Radiated spurious emissions</b>		
<b>Test procedure:</b>	Public notice DA 00-705		
<b>Test mode:</b>	Compliance	<b>Verdict:</b>	<b>PASS</b>
<b>Date &amp; Time:</b>	10/16/2005 3:30:32 PM		
<b>Temperature:</b> 24 °C	<b>Air Pressure:</b> 1012 hPa	<b>Relative Humidity:</b> 45 %	<b>Power Supply:</b> 4 VDC
<b>Remarks:</b>			

**Plot 8.4.35 Radiated emission measurements at the fifth harmonic of mid carrier frequency**

TEST SITE: OATS  
TEST DISTANCE: 3 m

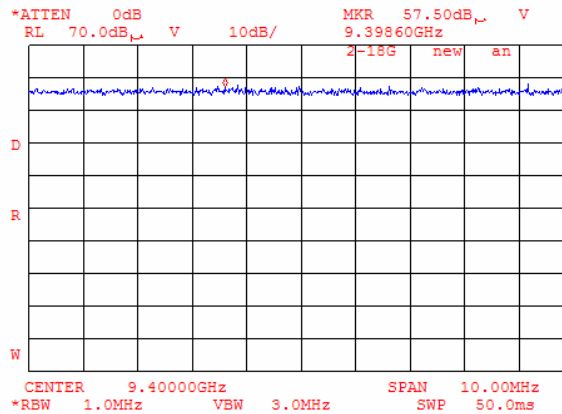

**Plot 8.4.36 Radiated emission measurements at the fifth harmonic of high carrier frequency**

TEST SITE: OATS  
TEST DISTANCE: 3 m

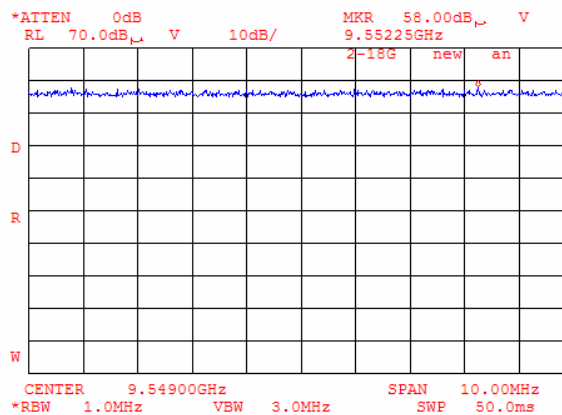

<b>Test specification:</b> Section 24.235, Frequency stability test			
<b>Test procedure:</b> FCC part 24, Section 24.235, part 2 section 2.1055			
<b>Test mode:</b> Compliance	<b>Verdict:</b> PASS		
<b>Date &amp; Time:</b> 10/23/2005 13:48:01 PM			
<b>Temperature:</b> 24 °C	<b>Air Pressure:</b> 1012 hPa	<b>Relative Humidity:</b> 45 %	<b>Power Supply:</b> 4 VDC
<b>Remarks:</b>			

## 8.5 Frequency stability test

### 8.5.1 General

This test was performed to measure frequency stability of transmitter RF carrier. Specification test limits are given in Table 8.5.1.

Table 8.5.1 Frequency stability limits

Assigned frequency, MHz	Limits
1850.2	26 dBc points including frequency tolerance shall remain within the authorized frequency block
1880.0	
1909.8	

### 8.5.2 Test procedure

- 8.5.2.1 The EUT was set up as shown in Figure 8.5.1, energized and its proper operation was checked.
- 8.5.2.2 The EUT power was turned off. Temperature within test chamber was set to +30°C and a period of time sufficient to stabilize all of the oscillator circuit components was allowed.
- 8.5.2.3 The EUT was powered on and carrier frequency was measured at start up moment and then every minute until frequency had been stabilized or 10 minutes elapsed whichever reached the last. The EUT was powered off.
- 8.5.2.4 The above procedure was repeated at 0°C and at the lowest test temperature.
- 8.5.2.5 The EUT was powered on and carrier frequency was measured at start up moment and at the end of stabilization period at the rest of test temperatures and voltages. The EUT was powered off.
- 8.5.2.6 Frequency displacement was calculated and compared with the limit as provided in Table 8.5.2

Figure 8.5.1 Frequency stability test setup

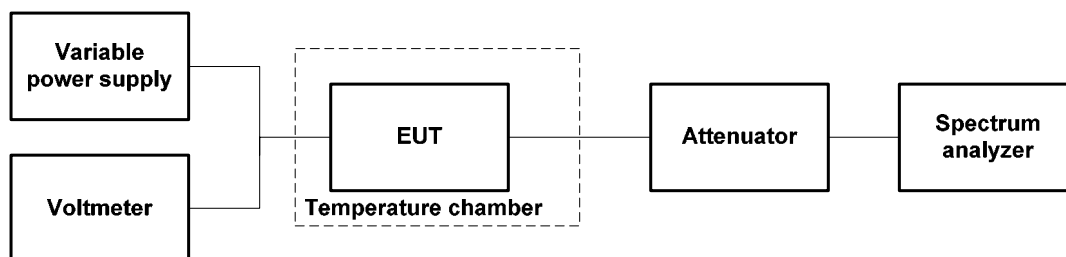

<b>Test specification:</b>		<b>Section 24.235, Frequency stability test</b>			
<b>Test procedure:</b>		FCC part 24, Section 24.235, part 2 section 2.1055			
<b>Test mode:</b>		Compliance		<b>Verdict:</b> PASS	
<b>Date &amp; Time:</b>		10/23/2005 13:48:01 PM			
<b>Temperature:</b> 24 °C		<b>Air Pressure:</b> 1012 hPa		<b>Relative Humidity:</b> 45 %	
<b>Remarks:</b>		<b>Power Supply:</b> 4 VDC			

Table 8.5.2 Frequency stability test results

OPERATING FREQUENCY: 1850.2 – 1909.8 MHz  
 NOMINAL POWER VOLTAGE: 4 Vdc  
 TEMPERATURE STABILIZATION PERIOD: 20 min  
 POWER DURING TEMPERATURE TRANSITION: Off  
 SPECTRUM ANALYZER MODE: Counter  
 RESOLUTION BANDWIDTH: 100 kHz  
 VIDEO BANDWIDTH: 100 kHz  
 MODULATION: FSK

T, °C	Voltage, V	Frequency, MHz							Max frequency drift, Hz	
		Start up	1 <sup>st</sup> min	2 <sup>nd</sup> min	3 <sup>rd</sup> min	4 <sup>th</sup> min	5 <sup>th</sup> min	10 <sup>th</sup> min	Positive	Negative
<b>Low carrier frequency</b>										
-30	nominal	1850.200400	1850.200400	1850.200450	1850.200450	1850.200400	1850.198750	1850.200450	450	-1250
-20	nominal	1850.200400	NA	NA	NA	NA	NA	1850.200000	400	0
-10	nominal	1850.198750	NA	NA	NA	NA	NA	1850.200400	400	-1250
0	nominal	1850.198750	1850.200000	1850.200000	1850.200400	1850.200450	1850.200000	1850.200400	450	-1250
10	nominal	1850.198750	NA	NA	NA	NA	NA	1850.200000	0	-1250
20	+15%	1850.198750	NA	NA	NA	NA	NA	1850.200400	400	-1250
20	nominal	1850.200400	NA	NA	NA	NA	NA	1850.200540*	540	0
20	-15%	1850.199375	NA	NA	NA	NA	NA	1850.200000	0	-625
30	nominal	1850.200850	NA	NA	NA	NA	NA	1850.200000	850	0
40	nominal	1850.199375	NA	NA	NA	NA	NA	1850.200000	0	-625
50	nominal	1850.200450	1850.200400	1850.200400	1850.200400	1850.200000	1850.200450	1850.200450	450	0
<b>Mid carrier frequency</b>										
-30	nominal	1880.005000	1880.005000	1,880.004600	1,880.004600	1880.005000	1880.005400	1,880.004600	0	-850
-20	nominal	1880.003350	NA	NA	NA	NA	NA	1880.003350	0	-2100
-10	nominal	1880.005000	NA	NA	NA	NA	NA	1,880.004600	0	-850
0	nominal	1880.005450	1880.005400	1,880.004600	1880.005000	1880.005450	1880.005000	1880.005400	0	-850
10	nominal	1880.005000	NA	NA	NA	NA	NA	1880.006650	1200	-450
20	+15%	1880.003350	NA	NA	NA	NA	NA	1880.005450	0	-2100
20	nominal	1880.005450	NA	NA	NA	NA	NA	1880.005000*	0	-450
20	-15%	1880.005000	NA	NA	NA	NA	NA	1,880.004600	0	-850
30	nominal	1880.003350	NA	NA	NA	NA	NA	1880.005450	0	-2100
40	nominal	1880.002500	NA	NA	NA	NA	NA	1880.001875	0	-3575
50	nominal	1880.005450	1880.005450	1880.005000	1880.005450	1880.005450	1880.005400	1880.005000	0	-450
<b>High carrier frequency</b>										
-30	nominal	1909.800850	1909.801200	1909.800850	1909.800850	1909.800000	1909.800850	1909.801200	0	-2544
-20	nominal	1909.801250	NA	NA	NA	NA	NA	1909.800800	1970	0
-10	nominal	1909.800850	NA	NA	NA	NA	NA	1909.800250	1837	0
0	nominal	1909.800850	1909.800850	1909.800800	1909.800850	1909.800000	1909.800000	1909.800250	7293	0
10	nominal	1909.801200	NA	NA	NA	NA	NA	1909.800250	0	-3127
20	+15%	1909.800000	NA	NA	NA	NA	NA	1909.800250	0	-11427
20	nominal	1909.800850	NA	NA	NA	NA	NA	1909.800250*	0	-10975
20	-15%	1909.799375	NA	NA	NA	NA	NA	1909.799375	0	-10872
30	nominal	1909.799375	NA	NA	NA	NA	NA	1909.799375	0	-10872
40	nominal	1909.800000	NA	NA	NA	NA	NA	1909.800250	0	-11427
50	nominal	1909.800000	1909.801250	1909.800000	1909.800800	1909.800850	1909.800000	1909.800000	0	-10905

\* - Reference frequency

<b>Test specification:</b>		<b>Section 24.235, Frequency stability test</b>	
<b>Test procedure:</b>		FCC part 24, Section 24.235, part 2 section 2.1055	
<b>Test mode:</b>	Compliance	<b>Verdict:</b>	<b>PASS</b>
<b>Date &amp; Time:</b>	10/23/2005 13:48:01 PM		
<b>Temperature:</b> 24 °C	<b>Air Pressure:</b> 1012 hPa	<b>Relative Humidity:</b> 45 %	<b>Power Supply:</b> 4 VDC
<b>Remarks:</b>			

Table 8.5.3 Transmitter operating range including frequency drift

Carrier frequency, MHz	Lower reference point, MHz	Upper reference point, MHz	Maximum negative drift, Hz	Maximum positive drift, Hz	Frequency tolerance, MHz	Limit, MHz	Margin, kHz	Verdict
1850.2	1850.062	1850.338	1250	1650	1850.06075	1850	60.75	Pass
1880.0	1879.863	1880.140	3575	1200	NA	NA	NA	NA
1909.8	1909.660	1909.933	0	1925	1909.93493	1910	-65.075	Pass

Reference numbers of test equipment used

HL 0278	HL 0493	HL 1097	HL 1204	HL 1653			
---------	---------	---------	---------	---------	--	--	--

Full description is given in Appendix A.

<b>Test specification:</b>		<b>Section 15.107 Conducted emission</b>	
<b>Test procedure:</b>		ANSI C63.4, Section 13.1.3; Sections 11.5 and 12.1.3	
<b>Test mode:</b>	Compliance	<b>Verdict:</b>	PASS
<b>Date &amp; Time:</b>	11/4/2005 4:03:01 PM		
<b>Temperature:</b> 24 °C	<b>Air Pressure:</b> 1011 hPa	<b>Relative Humidity:</b> 44 %	<b>Power Supply:</b> 120 V AC
<b>Remarks:</b>			

## 9 Unintentional radiation tests according to 47CFR part 15 subpart B requirements

### 9.1 Conducted emissions

#### 9.1.1 General

This test was performed to measure common mode conducted emissions at the power port. Specification test limits are given in Table 9.1.1. The worst test results (the lowest margins) were recorded in Table 9.1.2 and shown in the associated plots.

Table 9.1.1 Limits for conducted emissions

Frequency, MHz	Class B limit, dB( $\mu$ V)	
	QP	AVRG
0.15 - 0.5	66 - 56*	56 - 46*
0.5 - 5.0	56	46
5.0 - 30	60	50

\* The limit decreases linearly with the logarithm of frequency.

#### 9.1.2 Test procedure

9.1.2.1 The EUT was set up as shown in Figure 9.1.1, energized and the performance check was conducted.

9.1.2.2 The measurements were performed at power terminals with the LISN, connected to a spectrum analyzer in the frequency range referred to in Table 9.1.2. Unused coaxial connector of the LISN was terminated with 50 Ohm. Quasi-peak and average detectors were used throughout the testing.

9.1.2.3 The position of the device cables was varied to determine maximum emission level.

Figure 9.1.1 Setup for conducted emission measurements, table-top equipment

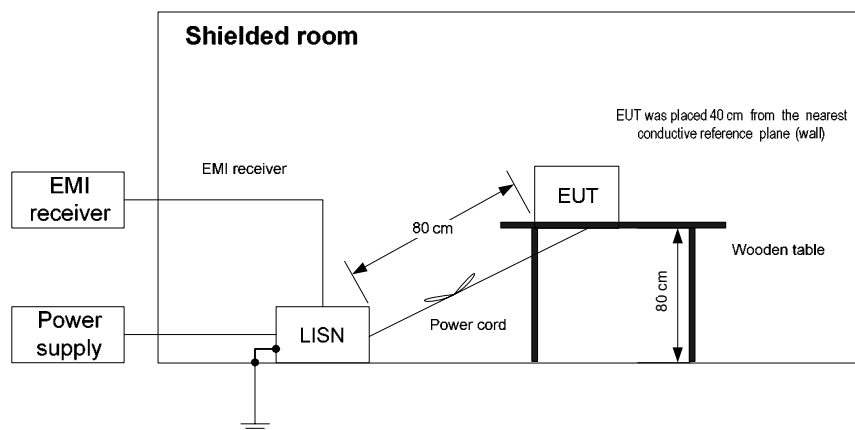

<b>Test specification:</b>	<b>Section 15.107 Conducted emission</b>		
<b>Test procedure:</b>	ANSI C63.4, Section 13.1.3; Sections 11.5 and 12.1.3		
<b>Test mode:</b>	Compliance	<b>Verdict:</b>	<b>PASS</b>
<b>Date &amp; Time:</b>	11/4/2005 4:03:01 PM		
<b>Temperature:</b> 24 °C	<b>Air Pressure:</b> 1011 hPa	<b>Relative Humidity:</b> 44 %	<b>Power Supply:</b> 120 V AC
<b>Remarks:</b>			

**Photograph 9.1.1 Setup for conducted emission measurements**



<b>Test specification:</b>		<b>Section 15.107 Conducted emission</b>	
<b>Test procedure:</b>		ANSI C63.4, Section 13.1.3; Sections 11.5 and 12.1.3	
<b>Test mode:</b>	Compliance	<b>Verdict: PASS</b>	
<b>Date &amp; Time:</b>	11/4/2005 4:03:01 PM		
<b>Temperature:</b> 24 °C	<b>Air Pressure:</b> 1011 hPa	<b>Relative Humidity:</b> 44 %	<b>Power Supply:</b> 120 V AC
<b>Remarks:</b>			

Table 9.1.2 Conducted emission test results

LINE: AC mains  
 EUT SET UP: TABLE-TOP  
 TEST SITE: SHIELDED ROOM  
 DETECTORS USED: PEAK / QUASI-PEAK / AVERAGE  
 FREQUENCY RANGE: 150 kHz - 30 MHz  
 RESOLUTION BANDWIDTH: 9 kHz  
 EUT MODE: Receive

Frequency, MHz	Peak emission, dB(μV)	Quasi-peak			Average			Line ID	Verdict
		Measured emission, dB(μV)	Limit, dB(μV)	Margin, dB*	Measured emission, dB(μV)	Limit, dB(μV)	Margin, dB*		
0.171209	23.29	15.19	64.97	-49.78	2.49	54.97	-52.48	L1	Pass
0.207759	25.68	23.25	63.36	-40.11	16.04	53.36	-37.32		
14.489674	32.51	27.95	60.00	-32.05	20.99	50.00	-29.01		
0.169099	24.19	17.69	65.07	-47.38	14.02	55.07	-41.05	L2	Pass
0.207852	26.89	24.22	63.35	-39.13	17.59	53.35	-35.76		
13.990632	31.23	27.61	60.00	-32.39	20.77	50.00	-29.23		

\*- Margin = Measured emission - specification limit.

Reference numbers of test equipment used

HL 0447	HL 0580	HL 1094	HL 1430	HL 1503	HL 1512	HL 2634	
---------	---------	---------	---------	---------	---------	---------	--

Full description is given in Appendix A.

<b>Test specification:</b> Section 15.107 Conducted emission			
<b>Test procedure:</b> ANSI C63.4, Section 13.1.3; Sections 11.5 and 12.1.3			
<b>Test mode:</b> Compliance	<b>Verdict:</b> PASS		
<b>Date &amp; Time:</b> 11/4/2005 4:03:01 PM			
<b>Temperature:</b> 24 °C	<b>Air Pressure:</b> 1011 hPa	<b>Relative Humidity:</b> 44 %	<b>Power Supply:</b> 120 V AC
<b>Remarks:</b>			

**Plot 9.1.1 Conducted emission measurements**

LINE: L1  
LIMIT: QUASI-PEAK, AVERAGE  
DETECTOR: PEAK  
EUT MODE: Receive

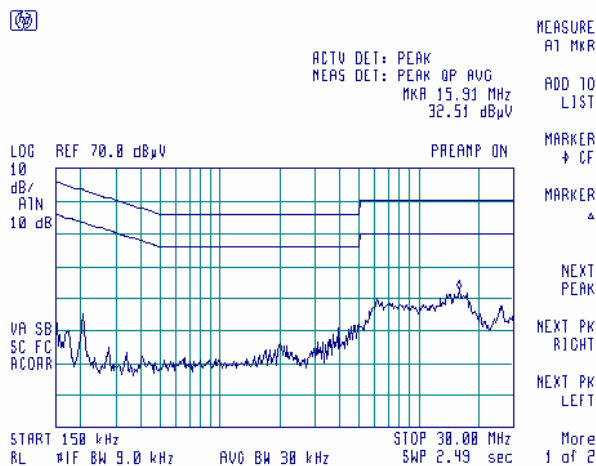

**Plot 9.1.2 Conducted emission measurements**

LINE: L2  
LIMIT: QUASI-PEAK, AVERAGE  
DETECTOR: PEAK  
EUT MODE: Receive

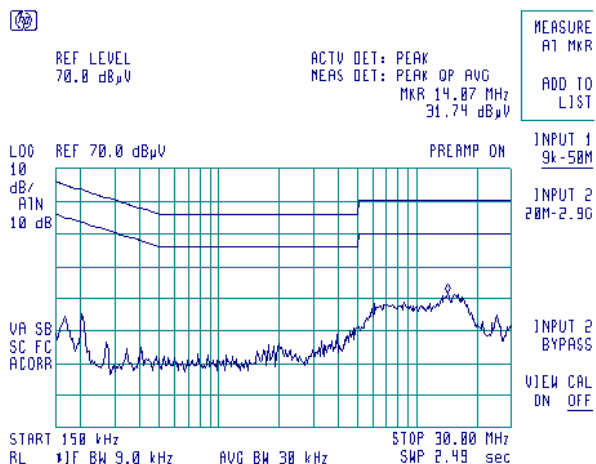



<b>Test specification:</b> Section 15.109, Radiated emission			
<b>Test procedure:</b> ANSI C63.4, Sections 11.6 and 12.1.4			
<b>Test mode:</b> Compliance		<b>Verdict:</b> PASS	
<b>Date &amp; Time:</b> 10/16/2005 3:24:17 PM			
<b>Temperature:</b> 21 °C	<b>Air Pressure:</b> 1012 hPa	<b>Relative Humidity:</b> 39 %	<b>Power Supply:</b> 4 VDC
<b>Remarks:</b>			

## 9.2 Radiated emissions

### 9.2.1 General

This test was performed to measure radiated emissions from the EUT enclosure. Specification test limits are given in Table 9.2.1.

Table 9.2.1 Radiated emission test limits

Frequency, MHz	Class B limit, dB(μV/m)		Class A limit, dB(μV/m)	
	10 m distance	3 m distance	10 m distance	3 m distance
30 - 88	29.5*	40.0	39.0	49.5*
88 - 216	33.0*	43.5	43.5	54.0*
216 - 960	35.5*	46.0	46.4	56.9*
Above 960	43.5*	54.0	49.5	60.0*

\* The limit for test distance other than specified was calculated using the inverse linear distance extrapolation factor as follows:  $Lim_{S_2} = Lim_{S_1} + 20 \log(S_1/S_2)$ , where  $S_1$  and  $S_2$  – standard defined and test distance respectively in meters.

### 9.2.2 Test procedure for measurements in semi-anechoic chamber

9.2.2.1 The EUT was set up as shown in Figure 9.2.1 and associated photograph/s, energized and the performance check was conducted.

9.2.2.2 The specified frequency range was investigated with biconilog antenna connected to EMI receiver. To find maximum radiation the turntable was rotated 360°, the measuring antenna height was changed from 1 to 4 m, its polarization was switched from vertical to horizontal and the EUT cables position was varied.

9.2.2.3 The worst test results (the lowest margins) were recorded in Table 9.2.2 and shown in the associated plots.

<b>Test specification:</b> Section 15.109, Radiated emission			
<b>Test procedure:</b> ANSI C63.4, Sections 11.6 and 12.1.4			
<b>Test mode:</b> Compliance		<b>Verdict:</b> PASS	
<b>Date &amp; Time:</b> 10/16/2005 3:24:17 PM			
<b>Temperature:</b> 21 °C	<b>Air Pressure:</b> 1012 hPa	<b>Relative Humidity:</b> 39 %	<b>Power Supply:</b> 4 VDC
<b>Remarks:</b>			

Figure 9.2.1 Setup for radiated emission measurements in anechoic chamber, table-top equipment

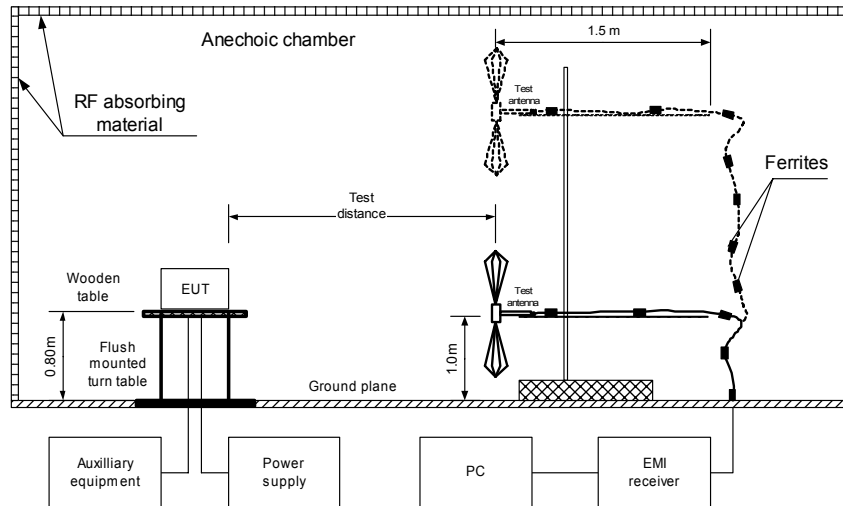

<b>Test specification:</b>	<b>Section 15.109, Radiated emission</b>		
<b>Test procedure:</b>	ANSI C63.4, Sections 11.6 and 12.1.4		
<b>Test mode:</b>	Compliance	<b>Verdict:</b>	<b>PASS</b>
<b>Date &amp; Time:</b>	10/16/2005 3:24:17 PM		
<b>Temperature:</b> 21 °C	<b>Air Pressure:</b> 1012 hPa	<b>Relative Humidity:</b> 39 %	<b>Power Supply:</b> 4 VDC
<b>Remarks:</b>			

Photograph 9.2.1 Setup for radiated emission measurements, below 1 GHz

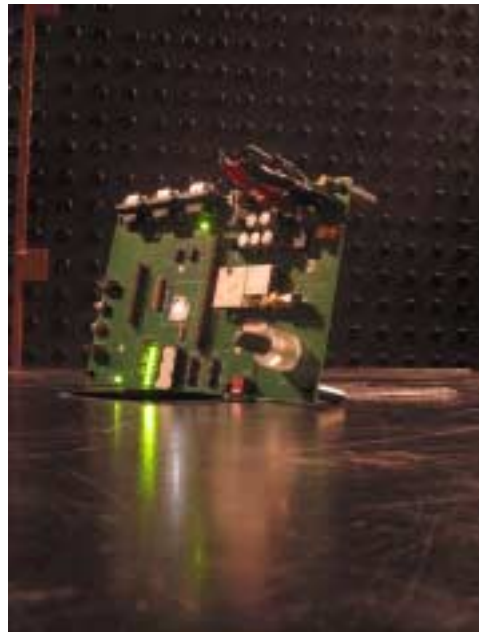

<b>Test specification:</b>	<b>Section 15.109, Radiated emission</b>		
<b>Test procedure:</b>	ANSI C63.4, Sections 11.6 and 12.1.4		
<b>Test mode:</b>	Compliance	<b>Verdict:</b>	<b>PASS</b>
<b>Date &amp; Time:</b>	10/16/2005 3:24:17 PM		
<b>Temperature:</b> 21 °C	<b>Air Pressure:</b> 1012 hPa	<b>Relative Humidity:</b> 39 %	<b>Power Supply:</b> 4 VDC
<b>Remarks:</b>			

Figure 9.2.2 Setup for radiated emission measurements, table-top equipment

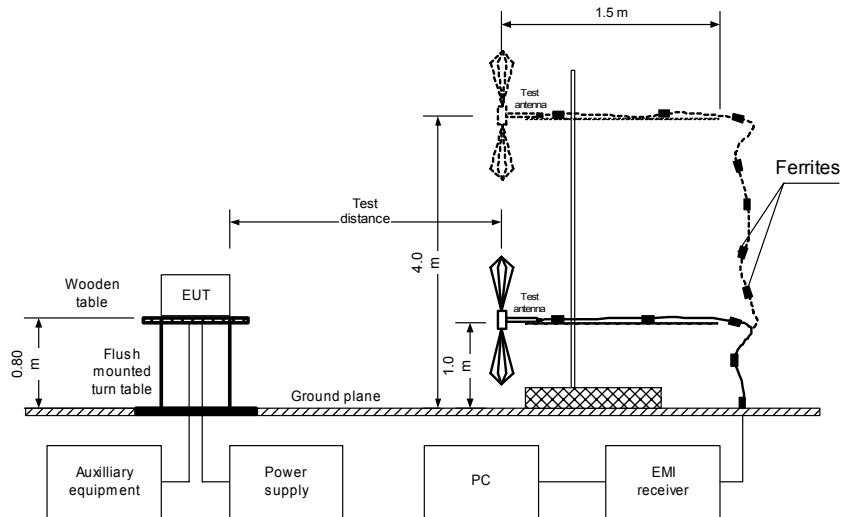

<b>Test specification:</b>	<b>Section 15.109, Radiated emission</b>		
<b>Test procedure:</b>	ANSI C63.4, Sections 11.6 and 12.1.4		
<b>Test mode:</b>	Compliance	<b>Verdict:</b>	<b>PASS</b>
<b>Date &amp; Time:</b>	10/16/2005 3:24:17 PM		
<b>Temperature:</b> 21 °C	<b>Air Pressure:</b> 1012 hPa	<b>Relative Humidity:</b> 39 %	<b>Power Supply:</b> 4 VDC
<b>Remarks:</b>			

Photograph 9.2.2 Setup for radiated emission measurements, above 1 GHz

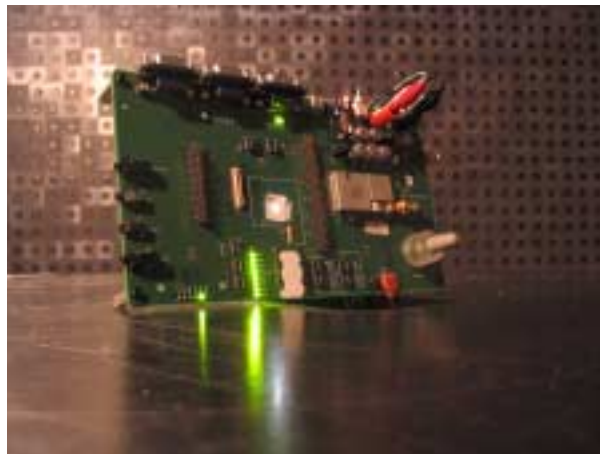

<b>Test specification:</b> Section 15.109, Radiated emission			
<b>Test procedure:</b> ANSI C63.4, Sections 11.6 and 12.1.4			
<b>Test mode:</b> Compliance	<b>Verdict:</b> PASS		
<b>Date &amp; Time:</b> 10/16/2005 3:24:17 PM			
<b>Temperature:</b> 21 °C	<b>Air Pressure:</b> 1012 hPa	<b>Relative Humidity:</b> 39 %	<b>Power Supply:</b> 4 VDC
<b>Remarks:</b>			

Table 9.2.2 Radiated emission test results

EUT SET UP: TABLE-TOP  
LIMIT: Class B  
EUT OPERATING MODE: Receive / Stand-by  
TEST SITE: SEMI ANECHOIC CHAMBER  
TEST DISTANCE: 3 m  
DETECTORS USED: PEAK / QUASI-PEAK  
FREQUENCY RANGE: 30 MHz – 1000 MHz  
RESOLUTION BANDWIDTH: 120 kHz

Frequency, MHz	Peak emission, dB(μV/m)	Quasi-peak			Antenna polarization	Antenna height, m	Turn-table position**, degrees	Verdict
		Measured emission, dB(μV/m)	Limit, dB(μV/m)	Margin, dB*				
No emissions were found								Pass

TEST SITE: SEMI ANECHOIC CHAMBER  
TEST DISTANCE: 3 m  
DETECTORS USED: PEAK / AVERAGE  
FREQUENCY RANGE: 1000 MHz – 10000 MHz  
RESOLUTION BANDWIDTH: 1000 kHz

Frequency, MHz	Peak emission, dB(μV/m)	Average			Antenna polarization	Antenna height, m	Turn-table position**, degrees	Verdict
		Measured emission, dB(μV/m)	Limit, dB(μV/m)	Margin, dB*				
No emissions were found								Pass

\*- Margin = Measured emission - specification limit.

\*\* - EUT front panel refer to 0 degrees position of turntable.

Reference numbers of test equipment used

HL 0410	HL 0521	HL 0589	HL 0592	HL 0593	HL 0594	HL 0604	HL 1200
HL 1424	HL 1942	HL 1947	HL 1984	HL 2009	HL 2259		

Full description is given in Appendix A.

<b>Test specification:</b>	<b>Section 15.109, Radiated emission</b>		
<b>Test procedure:</b>	ANSI C63.4, Sections 11.6 and 12.1.4		
<b>Test mode:</b>	Compliance	<b>Verdict:</b>	<b>PASS</b>
<b>Date &amp; Time:</b>	10/16/2005 3:24:17 PM		
<b>Temperature:</b> 21 °C	<b>Air Pressure:</b> 1012 hPa	<b>Relative Humidity:</b> 39 %	<b>Power Supply:</b> 4 VDC
<b>Remarks:</b>			

**Plot 9.2.1 Radiated emission measurements in 30- 1000 MHz range, vertical antenna polarization**

TEST SITE: Semi anechoic chamber  
LIMIT: Class B  
TEST DISTANCE: 3 m  
EUT OPERATING MODE: Receive / Stand-by

13:32:38 OCT 16, 2005

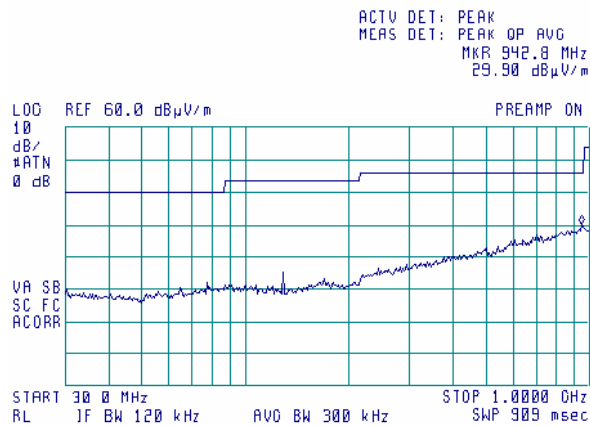

**Plot 9.2.2 Radiated emission measurements in 30- 1000 MHz range, horizontal antenna polarization**

TEST SITE: Semi anechoic chamber  
LIMIT: Class B  
TEST DISTANCE: 3 m  
EUT OPERATING MODE: Receive / Stand-by

13:30:20 OCT 16, 2005

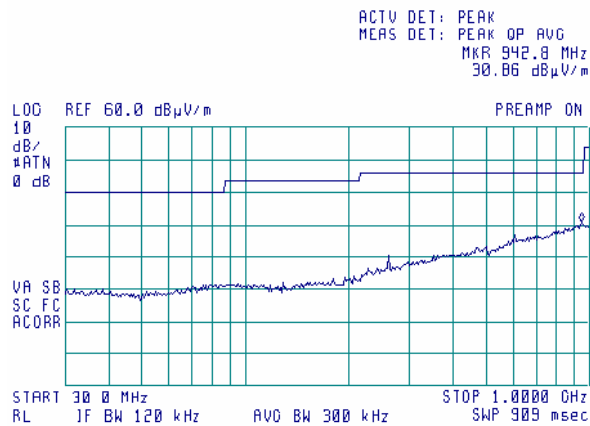

<b>Test specification:</b>		<b>Section 15.109, Radiated emission</b>	
<b>Test procedure:</b>		ANSI C63.4, Sections 11.6 and 12.1.4	
<b>Test mode:</b>	Compliance	<b>Verdict:</b>	PASS
<b>Date &amp; Time:</b>	10/16/2005 3:24:17 PM		
<b>Temperature:</b> 21 °C	<b>Air Pressure:</b> 1012 hPa	<b>Relative Humidity:</b> 39 %	<b>Power Supply:</b> 4 VDC
<b>Remarks:</b>			

**Plot 9.2.3 Radiated emission measurements in 1000- 2900 MHz range, vertical antenna polarization**

TEST SITE: Semi anechoic chamber  
LIMIT: Class B  
TEST DISTANCE: 3 m  
EUT OPERATING MODE: Receive / Stand-by

15:55:25 OCT 16, 2005

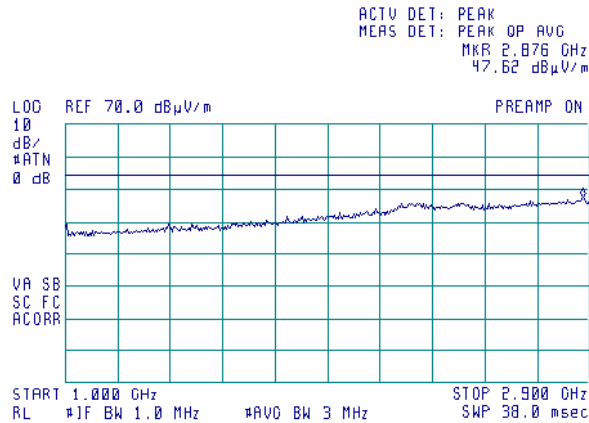

**Plot 9.2.4 Radiated emission measurements in 1000- 2900 MHz range, horizontal antenna polarization**

TEST SITE: Semi anechoic chamber  
LIMIT: Class B  
TEST DISTANCE: 3 m  
EUT OPERATING MODE: Receive / Stand-by

15:52:25 OCT 16, 2005

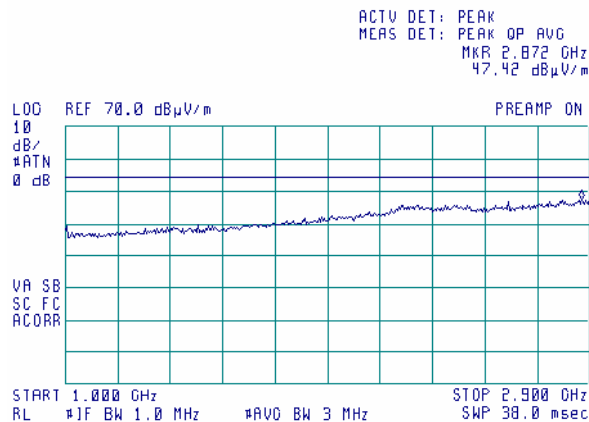



<b>Test specification:</b>		<b>Section 15.109, Radiated emission</b>	
<b>Test procedure:</b>		ANSI C63.4, Sections 11.6 and 12.1.4	
<b>Test mode:</b>	Compliance	<b>Verdict:</b>	PASS
<b>Date &amp; Time:</b>	10/16/2005 3:24:17 PM		
<b>Temperature:</b> 21 °C	<b>Air Pressure:</b> 1012 hPa	<b>Relative Humidity:</b> 39 %	<b>Power Supply:</b> 4 VDC
<b>Remarks:</b>			

**Plot 9.2.5 Radiated emission measurements in 2900 - 5000 MHz range, vertical antenna polarization**

TEST SITE: Semi anechoic chamber  
LIMIT: Class B  
TEST DISTANCE: 3 m  
EUT OPERATING MODE: Receive / Stand-by

15:59:39 OCT 16, 2005

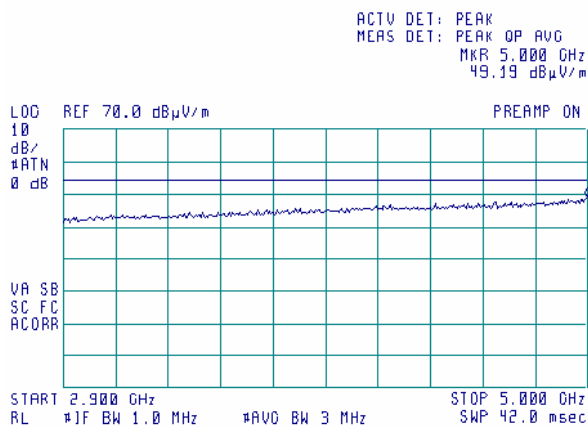

**Plot 9.2.6 Radiated emission measurements in 2900 - 5000 MHz range, horizontal antenna polarization**

TEST SITE: Semi anechoic chamber  
LIMIT: Class B  
TEST DISTANCE: 3 m  
EUT OPERATING MODE: Receive / Stand-by

16:01:55 OCT 16, 2005

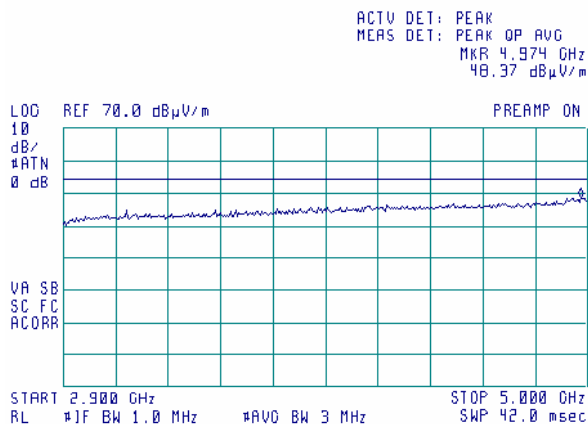

<b>Test specification:</b>	<b>Section 15.109, Radiated emission</b>		
<b>Test procedure:</b>	ANSI C63.4, Sections 11.6 and 12.1.4		
<b>Test mode:</b>	Compliance	<b>Verdict:</b>	<b>PASS</b>
<b>Date &amp; Time:</b>	10/16/2005 3:24:17 PM		
<b>Temperature:</b> 21 °C	<b>Air Pressure:</b> 1012 hPa	<b>Relative Humidity:</b> 39 %	<b>Power Supply:</b> 4 VDC
<b>Remarks:</b>			

**Plot 9.2.7 Radiated emission measurements in 5000 - 10000 MHz range, vertical and horizontal antenna polarization**

TEST SITE: Semi anechoic chamber  
LIMIT: Class B  
TEST DISTANCE: 3 m  
EUT OPERATING MODE: Receive / Stand-by

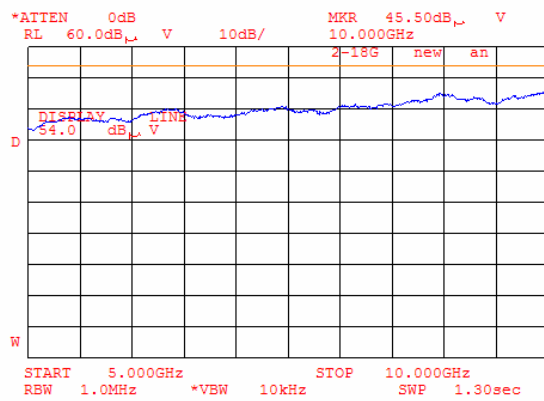

## 10 APPENDIX A Test equipment and ancillaries used for tests

HL No	Description	Manufacturer	Model	Ser. No.	Last Cal.	Due Cal.
0278	Thermometer, -200 - +760C	Fluke	51K/J	5045468	28-Apr-05	28-Apr-06
0410	Cable, Coax, Microwave, DC-18 GHz, N-N, 1 m	Gore	PFP01P0 1039.4	9338767	17-Oct-04	17-Oct-05
0446	Antenna, Loop active, 10kHz-30MHz	EMCO	6502	2857	28-Jun-05	28-Jun-06
0447	LISN, 16/2, 300V RMS	HL	LISN 16 - 1	066	03-Nov-05	03-Nov-06
0493	Oven temperature -45...175 deg C	Thermotron	S-1.2 Mini-Max	14016	23-Sep-05	23-Sep-06
0521	EMI Receiver (Spectrum Analyzer) with RF filter section 9 kHz-6.5 GHz	Hewlett Packard	8546A	3617A 00319, 3448A002 53	26-Sep-05	26-Sep-06
0580	DC block adaptor 10 kHz - 2.2 GHz	Anritsu	MA8601 A	580	22-Dec-04	22-Dec-05
0589	Cable Coaxial, GORE A2P01POL118, 2.3 m	HL	GORE-3	176	02-Dec-04	02-Dec-05
0592	Position Controller	HL	L2- SR3000 (HL CRL- 3)	100	18-May-05	18-May-06
0593	Antenna Mast, 1-4 m Pneumatic	Madgesh	AM-F1	101	03-Feb-05	03-Feb-06
0594	Turn Table FOR ANECHOIC CHAMBER flush mount d=1.2 m Pneumatic	HL	TT-WDC1	102	27-Jan-05	27-Jan-06
0604	Antenna BiconiLog Log-Periodic/T Bow-TIE 26 - 2000 MHz	EMCO	3141	9611-1011	27-Jan-05	27-Jan-06
0768	Antenna Standard Gain Horn, 18-26.5 GHz, WR-42, K-band, Gain - 25 dB	Quinstar Technology	QWH- 4200-BA	110	10-Jan-05	10-Jan-06
1094	Attenuator, 50 Ohm, 2 W, DC to 1500 MHz, 10 dB	Mini-Circuits	NAT-10	1094	15-Jan-05	15-Jan-06
1097	Attenuator, 50 Ohm, 5 W, DC to 8 GHz, 20 dB	Midwest Microwave	0793-20- NN-07	1097	15-Jan-05	15-Jan-06
1200	Quadruplexer 1-12 GHz (1-2 GHz; 2-4GHz;4-8 GHz; 8-12GHz)	Elettronica S.p.A. - Roma	UE 84	D/00240	10-Feb-05	10-Feb-06
1204	One phase Voltage regulator, 2kVA, 0-250V	HL	TDGC-2	99	04-Jun-05	04-Jun-06
1424	Spectrum Analyzer, 30 Hz- 40 GHz	Agilent Technologies (HP)	8564EC	3946A002 19	04-Jun-05	04-Jun-06
1430	EMI Receiver, 9 kHz - 2.9 GHz, System: HL1431, HL1432	Agilent Technologies (HP)	8542E	3807A002 62,3705A0 0217	04-Jun-05	04-Jun-06
1503	Cable RF, 6 m	Belden	M17/167 MIL-C-17	1503	11-Sep-05	11-Sep-06
1512	Cable RF, 8 m	Belden	M17/167 MIL-C-17	1512	11-Sep-05	11-Sep-06
1653	Analyzer EMC 9 kHz - 1.5 GHz	Agilent Technologies (HP)	E7401A	US394402 81	11-Sep-05	11-Sep-06
1942	Cable 18GHz, 4 m, blue	Rhophase Microwave Limited	SPS- 1803A- 4000-NPS	T4658	11-Sep-05	11-Sep-06
1947	Cable 18GHz, 6.5 m, blue	Rhophase Microwave Limited	NPS- 1803A- 6500-NPS	T4974	11-Sep-05	11-Sep-06
1984	Antenna, Double-Ridged Waveguide Horn, 1-18 GHz, 300 W, N-type	EMC Test Systems	3115	9911-5964	11-Sep-05	11-Sep-06

HL No	Description	Manufacturer	Model	Ser. No.	Last Cal.	Due Cal.
2009	Cable RF, 8 m	Alpha Wire	RG-214	C-56	11-Sep-05	11-Sep-06
2254	Cable 40GHz, 0.8 m, blue	Rhophase Microwave Limited	KPS-1503A-800-KPS	W4907	11-Sep-05	11-Sep-06
2259	Amplifier Low Noise 2-20 GHz	Sophia Wireless	LNA0220-C	0223	11-Sep-05	11-Sep-06
2260	Amplifier Low Noise 14-33 GHz	Sophia Wireless	LNA28-B	0233	11-Sep-05	11-Sep-06
2387	Filter Bandpass, 8-14 GHz	HL	FBP8-14	2387	11-Sep-05	11-Sep-06
2399	Cable 40GHz, 1.5 m, blue	Rhophase Microwave Limited	KPS-1503A-1500-KPS	X2945	11-Sep-05	11-Sep-06
2524	Attenuator, 10 dB, DC-18 GHz	Midwest Microwave	263-10	2524	11-Sep-05	11-Sep-06
2634	Power Supply, 0-36.0 VDC, 0-12.0 A	Nemic-Lambda	UP36-12	2634	29-Aug-05	29-Aug-06

## 11 APPENDIX B Measurement uncertainties

Expanded uncertainty at 95% confidence in Hermon Labs EMC measurements

Test description	Expanded uncertainty
Conducted carrier power at RF antenna connector	Below 12.4 GHz: $\pm 1.7$ dB 12.4 GHz to 40 GHz: $\pm 2.3$ dB
Conducted emissions at RF antenna connector	9 kHz to 2.9 GHz: $\pm 2.6$ dB 2.9 GHz to 6.46 GHz: $\pm 3.5$ dB 6.46 GHz to 13.2 GHz: $\pm 4.3$ dB 13.2 GHz to 22.0 GHz: $\pm 5.0$ dB 22.0 GHz to 26.8 GHz: $\pm 5.5$ dB 26.8 GHz to 40.0 GHz: $\pm 4.8$ dB
Occupied bandwidth	$\pm 8.0$ %
Duty cycle, timing (Tx ON / OFF) and average factor measurements	$\pm 1.0$ %
Conducted emissions with LISN	9 kHz to 150 kHz: $\pm 3.9$ dB 150 kHz to 30 MHz: $\pm 3.8$ dB
Radiated emissions at 3 m measuring distance Horizontal polarization  Vertical polarization	Biconilog antenna: $\pm 5.3$ dB Biconical antenna: $\pm 5.0$ dB Log periodic antenna: $\pm 5.3$ dB Double ridged horn antenna: $\pm 5.3$ dB Biconilog antenna: $\pm 6.0$ dB Biconical antenna: $\pm 5.7$ dB Log periodic antenna: $\pm 6.0$ dB Double ridged horn antenna: $\pm 6.0$ dB

The test equipment has been calibrated according to its recommended procedures and is within the manufacturer's published limit of error. The standards and instruments used in the calibration system conform to the present requirements of ISO/IEC 17025 (or alternately ANSI/NCSL Z540-1).

The laboratory calibrates its measurement standards by a third party (traceable to NIST, USA) on a regular basis according to equipment manufacturer requirements. The Hermon Labs EMC measurements uncertainty is given in the table above.

## 12 APPENDIX C Test facility description

Tests were performed at Hermon Laboratories Ltd., which is a fully independent, private, EMC, safety, environmental and telecommunication testing facility. Hermon Laboratories is listed by the Federal Communications Commission (USA) for all parts of Code of Federal Regulations 47 (CFR 47) and by Industry Canada for electromagnetic emissions (file numbers IC 2186-1 for OATS and IC 2186-2 for anechoic chamber), certified by VCCI, Japan (the registration numbers are R-808 for OATS, R-1082 for anechoic chamber, C-845 for conducted emissions site), assessed by TNO Certification EP&S (Netherlands) for a number of EMC, telecommunications, environmental, safety standards, and by AMTAC (UK) for safety of medical devices. The laboratory is accredited by American Association for Laboratory Accreditation (USA) according to ISO/IEC 17025 for electromagnetic compatibility, product safety, telecommunications testing and environmental simulation (for exact scope please refer to Certificate No. 839.01).

Address: P.O. Box 23, Binyamina 30500, Israel.  
Telephone: +972 4628 8001  
Fax: +972 4628 8277  
e-mail: mail@hermonlabs.com  
website: www.hermonlabs.com

Person for contact: Mr. Alex Usoskin, CEO.

## 13 APPENDIX D Specification references

47CFR part 22:2004	Public Mobile Services
47CFR part 24: 2004	Personal Communications Services
47CFR part 15:2004	Radio Frequency Devices
ANSI C63.2: 1996	American National Standard for Instrumentation-Electromagnetic Noise and Field Strength, 10 kHz to 40 GHz-Specifications.
ANSI C63.4: 2003	American National Standard for Methods of Measurement of Radio-Noise Emissions from Low-Voltage Electrical and Electronic Equipment in the Range of 9 kHz to 40 GHz.

## 14 APPENDIX E Abbreviations and acronyms

A	ampere
AC	alternating current
A/m	ampere per meter
AM	amplitude modulation
AVRG	average (detector)
cm	centimeter
dB	decibel
dBm	decibel referred to one milliwatt
dB( $\mu$ V)	decibel referred to one microvolt
dB( $\mu$ V/m)	decibel referred to one microvolt per meter
dB( $\mu$ A)	decibel referred to one microampere
dB $\Omega$	decibel referred to one Ohm
DC	direct current
DTS	digital transmission system
EIRP	equivalent isotropically radiated power
ERP	effective radiated power
EUT	equipment under test
F	frequency
FHSS	frequency hopping spread spectrum
GHz	gigahertz
GND	ground
H	height
HL	Hermon laboratories
Hz	hertz
ITE	information technology equipment
k	kilo
kHz	kilohertz
LISN	line impedance stabilization network
LO	local oscillator
m	meter
MHz	megahertz
min	minute
mm	millimeter
ms	millisecond
$\mu$ s	microsecond
NA	not applicable
NT	not tested
OATS	open area test site
$\Omega$	Ohm
PCB	printed circuit board
PM	pulse modulation
PS	power supply
ppm	part per million ( $10^{-6}$ )
QP	quasi-peak
RE	radiated emission
RF	radio frequency
rms	root mean square
Rx	receive
s	second
T	temperature
Tx	transmit
V	volt
VA	volt-ampere

**15 APPENDIX F Test equipment correction factors**

**Correction factor  
Line impedance stabilization network  
Model LISN 16 - 1  
Hermon Laboratories**

<b>Frequency, kHz</b>	<b>Correction factor, dB</b>
10	4.9
15	2.86
20	1.83
25	1.25
30	0.91
35	0.69
40	0.53
50	0.35
60	0.25
70	0.18
80	0.14
90	0.11
100	0.09
125	0.06
150	0.04

The correction factor in dB is to be added to meter readings of an interference analyzer or a spectrum analyzer.



**Antenna factor**

**Biconilog antenna EMCO, model 3141, serial number 1011, HL 0604**

Frequency, MHz	Antenna factor, dB(1/m)	Frequency, MHz	Antenna factor, dB(1/m)	Frequency, MHz	Antenna factor, dB(1/m)
26	7.8	560	19.8	1300	27.0
28	7.8	580	20.6	1320	27.8
30	7.8	600	21.3	1340	28.3
40	7.2	620	21.5	1360	28.2
60	7.1	640	21.2	1380	27.9
70	8.5	660	21.4	1400	27.9
80	9.4	680	21.9	1420	27.9
90	9.8	700	22.2	1440	27.8
100	9.7	720	22.2	1460	27.8
110	9.3	740	22.1	1480	28.0
120	8.8	760	22.3	1500	28.5
130	8.7	780	22.6	1520	28.9
140	9.2	800	22.7	1540	29.6
150	9.8	820	22.9	1560	29.8
160	10.2	840	23.1	1580	29.6
170	10.4	860	23.4	1600	29.5
180	10.4	880	23.8	1620	29.3
190	10.3	900	24.1	1640	29.2
200	10.6	920	24.1	1660	29.4
220	11.6	940	24.0	1680	29.6
240	12.4	960	24.1	1700	29.8
260	12.8	980	24.5	1720	30.3
280	13.7	1000	24.9	1740	30.8
300	14.7	1020	25.0	1760	31.1
320	15.2	1040	25.2	1780	31.0
340	15.4	1060	25.4	1800	30.9
360	16.1	1080	25.6	1820	30.7
380	16.4	1100	25.7	1840	30.6
400	16.6	1120	26.0	1860	30.6
420	16.7	1140	26.4	1880	30.6
440	17.0	1160	27.0	1900	30.6
460	17.7	1180	27.0	1920	30.7
480	18.1	1200	26.7	1940	30.9
500	18.5	1220	26.5	1960	31.2
520	19.1	1240	26.5	1980	31.6
540	19.5	1260	26.5	2000	32.0
		1280	26.6		

Antenna factor in dB(1/m) is to be added to receiver meter reading in dB( $\mu$ V) to convert it into field intensity in dB( $\mu$ V/m).

**Antenna factor**  
**Double-ridged wave guide horn antenna**  
**EMC Test Systems, model 3115, serial no: 9911-5964, HL 1984**

Frequency, MHz	Antenna gain, dBi	Antenna factor. dB(1/m)
1000.0	5.8	24.5
1500.0	9.0	24.8
2000.0	8.6	27.7
2500.0	9.5	28.7
3000.0	8.9	30.8
3500.0	8.2	32.9
4000.0	9.6	32.7
4500.0	11.2	32.1
5000.0	10.6	33.6
5500.0	9.8	35.3
6000.0	10.1	35.7
6500.0	10.7	35.8
7000.0	10.9	36.2
7500.0	10.5	37.2
8000.0	11.1	37.2
8500.0	10.8	38.1
9000.0	10.7	38.6
9500.0	11.5	38.3
10000.0	11.8	38.4
10500.0	12.3	38.3
11000.0	12.3	38.8
11500.0	11.5	39.9
12000.0	12.2	39.6
12500.0	12.6	39.5
13000.0	12.0	40.5
13500.0	11.7	41.1
14000.0	11.7	41.5
14500.0	12.7	40.8
15000.0	14.2	39.5
15500.0	16.0	38.1
16000.0	16.2	38.1
16500.0	14.5	40.1
17000.0	12.2	42.6
17500.0	9.7	45.4
18000.0	6.6	48.7

Antenna factor is to be added to receiver meter reading in dB( $\mu$ V) to convert it into field intensity in dB( $\mu$ V/m).

**Antenna Factor**  
**Active Loop Antenna**  
**EMC Test Systems, model 6502, serial number 2857, HL 0446**

Frequency, MHz	Magnetic Antenna Factor, dB(S/m)	Electric Antenna Factor, dB(1/m)
0.009	-32.8	18.7
0.010	-33.8	17.7
0.020	-38.3	13.2
0.050	-41.1	10.4
0.075	-41.3	10.2
0.100	-41.6	9.9
0.150	-41.7	9.8
0.250	-41.6	9.9
0.500	-41.8	9.7
0.750	-41.9	9.6
1.000	-41.4	10.1
2.000	-41.5	10.0
3.000	-41.4	10.1
4.000	-41.4	10.1
5.000	-41.5	10.0
10.000	-41.9	9.6
15.000	-41.9	9.6
20.000	-42.2	9.3
25.000	-42.8	8.7
30.000	-44.0	7.5

Antenna factor in dB(S/m) is to be added to receiver meter reading in dB( $\mu$ V) to convert it into field intensity in dB( $\mu$ A/m).

**Antenna factor**  
**Standard gain horn antenna**  
**Quinstar Technology**  
**Model QWH**  
**HL 0768, 0769, 0770, 0771, 0772**

Frequency min, GHz	Frequency max, GHz	Antenna factor, dB(1/m)
18.000	26.500	32.01
26.500	40.000	35.48
40.000	60.000	39.03
60.000	90.000	42.55
90.000	140.000	46.23
140.000	220.000	50.11

Antenna factor in dB(1/m) is to be added to receiver meter reading in dB( $\mu$ V) to convert it into field intensity in dB( $\mu$ V/m).

**Cable loss**  
**Cable GORE, HL 0410**

No.	Frequency, GHz	Cable loss, dB
1	0.5	0.16
2	1	0.28
3	2	0.38
4	4	0.55
5	6	0.85
6	8	0.90
7	10	1.07
8	12	1.11
9	14	1.29
10	16	1.41
11	18	1.73

**Cable loss**  
**Cable Coaxial, GORE A2P01POL118, 2.3 m, model:GORE-3, HL 0589**  
**+ Cable Coaxial, ANDREW PSWJ4, 6m, model: ANDREW-6, HL 1004**

No.	Frequency, MHz	Cable loss, dB	Tolerance (Specification), dB	Measurement uncertainty, dB
1	30	0.33	≤ 6.5	±0.12
2	50	0.40		
3	100	0.57		
4	300	0.97		
5	500	1.25		
6	800	1.59		
7	1000	1.81		
8	1200	1.97		
9	1400	2.15		
10	1600	2.28		
11	1800	2.43		
12	2000	2.61		
13	2200	2.75		
14	2400	2.89		
15	2600	2.97		
16	2800	3.21	≤ 6.5	±0.12
17	3000	3.32		
18	3300	3.47		
19	3600	3.62		
20	3900	3.84		
21	4200	3.92		
22	4500	4.07		
23	4800	4.36		
24	5100	4.62		
25	5400	4.78		
26	5700	5.16		
27	6000	5.67		
28	6500	5.99		

**Cable loss**  
**Cable 18 GHz, 4 m, blue, model: SPS-1803A-4000-NPS, S/N T4658, HL 1942**

Frequency, GHz	Cable loss, dB
0.03	0.21
0.05	0.26
0.10	0.36
0.20	0.50
0.30	0.61
0.40	0.70
0.50	0.78
0.60	0.85
0.70	0.93
0.80	0.99
0.90	1.04
1.00	1.10
1.10	1.16
1.20	1.22
1.30	1.26
1.40	1.31
1.50	1.35
1.60	1.41
1.70	1.45
1.80	1.49
1.90	1.53
2.00	1.57
2.10	1.61
2.20	1.65
2.30	1.69
2.40	1.72
2.50	1.76
2.60	1.79
2.70	1.83
2.80	1.87
2.90	1.90
3.10	1.97
3.30	2.04
3.50	2.11
3.70	2.18
3.90	2.24
4.10	2.31
4.30	2.38
4.50	2.43
4.70	2.53
4.90	2.53
5.10	2.63
5.30	2.65
5.50	2.72
5.70	2.76
5.90	2.79

Frequency, GHz	Cable loss, dB
6.10	2.88
6.30	2.90
6.50	2.97
6.70	3.02
6.90	3.04
7.10	3.07
7.30	3.12
7.50	3.13
7.70	3.19
7.90	3.24
8.10	3.30
8.30	3.36
8.50	3.45
8.70	3.41
8.90	3.45
9.10	3.42
9.30	3.55
9.50	3.48
9.70	3.58
9.90	3.61
10.10	3.66
10.30	3.68
10.50	3.70
10.70	3.70
10.90	3.75
11.10	3.78
11.30	3.86
11.50	3.98
11.70	4.10
11.90	4.12
12.10	4.09
12.40	4.13
13.00	4.23
13.50	4.35
14.00	4.40
14.50	4.44
15.00	4.57
15.50	4.66
16.00	4.64
16.50	4.66
17.00	4.75
17.50	4.85
18.00	4.93

**Cable loss**  
**Cable 18 GHz, 6.5 m, blue, model: NPS-1803A-6500-NPS, S/N T4974, HL 1947**

Frequency, GHz	Cable loss, dB
0.03	0.30
0.05	0.38
0.10	0.53
0.20	0.74
0.30	0.91
0.40	1.05
0.50	1.18
0.60	1.29
0.70	1.40
0.80	1.50
0.90	1.59
1.00	1.68
1.10	1.77
1.20	1.86
1.30	1.94
1.40	2.01
1.50	2.08
1.60	2.16
1.70	2.22
1.80	2.29
1.90	2.36
2.00	2.42
2.10	2.48
2.20	2.54
2.30	2.60
2.40	2.66
2.50	2.71
2.60	2.77
2.70	2.83
2.80	2.89
2.90	2.95
3.10	3.06
3.30	3.17
3.50	3.28
3.70	3.39
3.90	3.51
4.10	3.62
4.30	3.76
4.50	3.87
4.70	4.01
4.90	4.10
5.10	4.21
5.30	4.31
5.50	4.43
5.70	4.56
5.90	4.71

Frequency, GHz	Cable loss, dB
6.10	4.87
6.30	4.95
6.50	4.94
6.70	4.88
6.90	4.87
7.10	4.83
7.30	4.85
7.50	4.86
7.70	4.91
7.90	4.96
8.10	5.03
8.30	5.08
8.50	5.13
8.70	5.21
8.90	5.22
9.10	5.34
9.30	5.35
9.50	5.52
9.70	5.51
9.90	5.66
10.10	5.70
10.30	5.78
10.50	5.79
10.70	5.82
10.90	5.86
11.10	5.94
11.30	6.06
11.50	6.21
11.70	6.44
11.90	6.61
12.10	6.76
12.40	6.68
13.00	6.66
13.50	6.81
14.00	6.90
14.50	6.90
15.00	6.97
15.50	7.17
16.00	7.28
16.50	7.27
17.00	7.38
17.50	7.68
18.00	7.92

**Cable loss**  
**RF cable 8 m, model RG-214, HL 2009**

No.	Frequency, MHz	Cable loss, dB	Tolerance (Specification), dB	Measurement uncertainty, dB
1	1	0.10	NA	±0.12
2	10	0.14		
3	30	0.25		
4	50	0.34		
5	100	0.53		
6	300	0.99		
7	500	1.31		
8	800	1.73		
9	1000	1.98		
10	1100	2.11		
11	1200	2.21		
12	1300	2.35		
13	1400	2.46		
14	1500	2.55		
15	1600	2.68		
16	1700	2.78		
17	1800	2.88		
18	1900	2.98		
19	2000	3.09		

**Cable loss**  
**Cable 40 GHz, 0.8 m, blue, model: KPS-1503A-800-KPS, S/N W4907, HL 2254**

Frequency, GHz	Cable loss, dB	Frequency, GHz	Cable loss, dB	Frequency, GHz	Cable loss, dB
0.03	0.04	5.10	0.80	15.00	1.49
0.05	0.07	5.30	0.83	15.50	1.49
0.10	0.09	5.50	0.83	16.00	1.46
0.20	0.15	5.70	0.84	16.50	1.47
0.30	0.19	5.90	0.87	17.00	1.50
0.40	0.25	6.10	0.86	17.50	1.57
0.50	0.29	6.30	0.89	18.00	1.63
0.60	0.33	6.50	0.90	18.50	1.57
0.70	0.37	6.70	0.89	19.00	1.63
0.80	0.41	6.90	0.93	19.50	1.65
0.90	0.44	7.10	0.92	20.00	1.64
1.00	0.45	7.30	0.95	20.50	1.75
1.10	0.48	7.50	0.96	21.00	1.72
1.20	0.51	7.70	0.97	21.50	1.78
1.30	0.53	7.90	1.01	22.00	1.76
1.40	0.54	8.10	1.00	22.50	1.72
1.50	0.57	8.30	1.05	23.00	1.83
1.60	0.59	8.50	1.04	23.50	1.80
1.70	0.04	8.70	1.07	24.00	1.90
1.80	0.07	8.90	1.11	24.50	1.81
1.90	0.09	9.10	1.09	25.00	1.98
2.00	0.15	9.30	1.14	25.50	1.91
2.10	0.19	9.50	1.12	26.00	2.02
2.20	0.25	9.70	1.15	26.50	1.92
2.30	0.29	9.90	1.16	27.00	1.97
2.40	0.33	10.10	1.16	28.00	2.02
2.50	0.37	10.30	1.19	29.00	1.95
2.60	0.41	10.50	1.14	30.00	1.94
2.70	0.44	10.70	1.19	31.00	2.11
2.80	0.45	10.90	1.17	32.00	2.17
2.90	0.48	11.10	1.13	33.00	2.27
3.10	0.61	11.30	1.20	34.00	2.27
3.30	0.64	11.50	1.13	35.00	2.29
3.50	0.65	11.70	1.20	36.00	2.35
3.70	0.68	11.90	1.18	37.00	2.37
3.90	0.69	12.10	1.14	38.00	2.40
4.10	0.71	12.40	1.19	39.00	2.57
4.30	0.73	13.00	1.34	40.00	2.36
4.50	0.75	13.50	1.33		
4.70	0.77	14.00	1.48		
4.90	0.79	14.50	1.45		



**Cable loss**

**Cable coaxial, 40GHz, 1.5 m, Blue, Rhophase Microwave Limited, model: KPS-1503A-1500-KPS, HL 2399**

Frequency, GHz	Cable loss, dB	Frequency, GHz	Cable loss, dB	Frequency, GHz	Cable loss, dB
0.03	0.07	6.5	1.57	15.50	2.50
0.05	0.10	6.7	1.60	16.00	2.51
0.1	0.16	6.9	1.55	16.50	2.58
0.2	0.26	7.1	1.65	17.00	2.65
0.3	0.33	7.3	1.65	17.50	2.73
0.5	0.38	7.5	1.70	18.00	2.74
0.7	0.41	7.7	1.71	18.50	2.67
0.9	0.58	7.9	1.73	19.00	2.67
1.1	0.64	8.1	1.79	19.50	2.74
1.3	0.70	8.3	1.81	20.00	2.69
1.5	0.75	8.5	1.84	20.50	2.80
1.7	0.79	8.7	1.85	21.00	2.82
1.9	0.83	8.9	1.90	21.50	2.87
2.1	0.88	9.1	1.95	22.00	2.87
2.3	0.93	9.3	1.93	22.50	2.92
2.5	0.97	9.5	1.98	23.50	3.04
2.7	1.01	9.7	1.96	24.00	3.05
2.9	1.04	9.9	2.03	24.50	3.03
3.1	1.08	10.1	1.99	25.00	3.11
3.3	1.14	10.30	2.02	25.50	3.10
3.5	1.17	10.50	2.02	26.00	3.17
3.7	1.21	10.70	2.02	26.50	3.11
3.9	1.24	10.90	2.08	27.00	3.16
4.1	1.26	11.10	2.02	28.00	3.19
4.3	1.26	11.30	2.09	29.00	3.19
4.5	1.29	11.50	2.05	30.00	3.30
4.7	1.34	11.70	2.11	31.00	3.31
4.9	1.34	11.90	2.11	32.00	3.35
5.1	1.40	12.10	2.12	33.00	3.46
5.3	1.43	12.40	2.17	34.00	3.45
5.5	1.45	13.00	2.29	35.00	3.49
5.7	1.47	13.50	2.31	36.00	3.54
5.9	1.40	14.00	2.43	37.00	3.62
6.1	1.53	14.50	2.43	39.00	3.69
6.3	1.55	15.00	2.46	40.00	3.75