

TEST REPORT

CERTIFICATE OF CONFORMITY

Standard: 47 CFR FCC Part 15, Subpart B, Class B
ANSI C63.4:2014

Report No.: FDBGUX-WTW-P22110807

Product: Telematics Control Unit

Brand: Sage

Model No.: 34770YZF_A01

FCC ID: VRB34770YZF

Received Date: 2022/11/29

Test Date: 2022/12/14 ~ 2022/12/17

Issued Date: 2023/5/10

Applicant: Sage Co., Ltd.

Address: KY building 2F-B, 2-24 Sumiyoshi-cho, Naka-ku, Yokohama, Japan

Issued By: Bureau Veritas Consumer Products Services (H.K.) Ltd., Taoyuan Branch
Lin Kou Laboratories

Lab Address: No. 47-2, 14th Ling, Chia Pau Vil., Lin Kou Dist., New Taipei City, Taiwan

Test Location: No. 19, Hwa Ya 2nd Rd., Wen Hwa Vil., Kewi Shan Dist., Taoyuan City 33383, Taiwan

FCC Registration /

Designation Number: 328930 / TW1050

Leo Hsu

Approved by: _____, **Date:** 2023/5/10
Leo Hsu / Project Engineer

This test report consists of 22 pages in total. It may be duplicated completely for legal use with the approval of the applicant. It should not be reproduced except in full, without the written approval of our laboratory. The test results in the report only apply to the tested sample. The test results in this report are traceable to the national or international standards.



Prepared by : Anna Lee / Specialist

This report is governed by, and incorporates by reference, the Conditions of Testing as posted at the date of issuance of this report at <http://www.bureauveritas.com/home/about-us/our-business/cps/about-us/terms-conditions/>, and is intended for your exclusive use. Any copying or replication of this report to or for any other person or entity, or use of our name or trademark, is permitted only with our prior written permission. This report sets forth our findings solely with respect to the test samples identified herein. The results set forth in this report are not indicative or representative of the quality or characteristics of the lot from which a test sample was taken or any similar or identical product unless specifically and expressly noted. Our report includes all of the tests requested by you and the results thereof based upon the information that you provided to us. Measurement uncertainty is only provided upon request for accredited tests. Statements of conformity are based on simple acceptance criteria without taking measurement uncertainty into account, unless otherwise requested in writing. You have 60 days from date of issuance of this report to notify us of any material error or omission caused by our negligence or if you require measurement uncertainty; provided, however, that such notice shall be in writing and shall specifically address the issue you wish to raise. A failure to raise such issue within the prescribed time shall constitute your unqualified acceptance of the completeness of this report, the tests conducted and the correctness of the report contents.

Table of Contents

Release Control Record	3
1 Certificate.....	4
2 Summary of Test Results	5
2.1 Measurement Uncertainty	5
2.2 Supplementary Information	5
3 General Information	6
3.1 Description of EUT	6
3.2 Primary Clock Frequencies of Internal Source.....	6
3.3 Features of EUT	6
3.4 Operating Modes of EUT and Determination of Worst Case Operating Mode	7
3.5 Test Program Used and Operation Descriptions	8
3.6 Connection Diagram of EUT and Peripheral Devices	8
3.7 Configuration of Peripheral Devices and Cable Connections	8
4 Test Instruments	9
4.1 Conducted Emissions from Power Ports	9
4.2 Radiated Emissions up to 1 GHz	9
4.3 Radiated Emissions above 1 GHz.....	10
5 Limits of Test Items.....	11
5.1 Conducted Emissions from Power Ports	11
5.2 Radiated Emissions up to 1 GHz	11
5.3 Radiated Emissions above 1 GHz.....	11
6 Test Arrangements.....	12
6.1 Conducted Emissions from Power Ports	12
6.2 Radiated Emissions up to 1 GHz	13
6.3 Radiated Emissions above 1 GHz.....	14
7 Test Results of Test Item	15
7.1 Conducted Emissions from Power Ports	15
7.2 Radiated Emissions up to 1 GHz	17
7.3 Radiated Emissions above 1 GHz.....	19
8 Pictures of Test Arrangements	21
9 Information of the Testing Laboratories	22



Release Control Record

Issue No.	Description	Date Issued
FDBGUX-WTW-P22110807	Original release.	2023/5/10

1 Certificate

Product: Telematics Control Unit

Brand: Sage

Test Model: 34770YZF_A01

FCC ID: VRB34770YZF

Sample Status: Engineering sample

Applicant: Sage Co., Ltd.

Test Date: 2022/12/14 ~ 2022/12/17

Standard: 47 CFR FCC Part 15, Subpart B, Class B
ANSI C63.4:2014

The above equipment has been tested by **Bureau Veritas Consumer Products Services (H.K.) Ltd., Taoyuan Branch**, and found compliance with the requirement of the above standards. The test record, data evaluation & Equipment Under Test (EUT) configurations represented herein are true and accurate accounts of the measurements of the sample's EMC characteristics under the conditions specified in this report.

2 Summary of Test Results

The test items that the EUT need to perform in accordance with its interfaces, evaluated functions, are as follows:

Standard / Clause	Test Item	Result	Remark
FCC Part 15.107	Conducted Emissions from Power Ports	Pass	Minimum passing Class B margin is -18.00 dB at 0.73000 MHz
FCC Part 15.109	Radiated Emissions up to 1 GHz	Pass	Minimum passing Class B margin is -3.17 dB at 43.14 MHz
FCC Part 15.109	Radiated Emissions above 1 GHz	Pass	Minimum passing Class B margin is -12.37 dB at 1874.99 MHz

Note: Determining compliance based on the results of the compliance measurement, not taking into account measurement instrumentation uncertainty.

2.1 Measurement Uncertainty

Where relevant, the following measurement uncertainty levels have been estimated for tests performed on the EUT as specified in CISPR 16-4-2:

Measurement	Specification	Expanded Uncertainty (k=2) (±)	Maximum allowable uncertainty (±)
Conducted Emissions from Power Ports	9 kHz ~ 30 MHz	2.99 dB	3.4 dB (U_{CISPR})
Radiated Emissions up to 1 GHz	30 MHz ~ 1 GHz	4.49 dB	6.3 dB (U_{CISPR})
Radiated Emissions above 1 GHz	1 GHz ~ 6 GHz	4.97 dB	5.2 dB (U_{CISPR})
	6 GHz ~ 18 GHz	4.79 dB	5.5 dB (U_{CISPR})

The other instruments specified are routine verified to remain within the calibrated levels, no measurement uncertainty is required to be calculated.

2.2 Supplementary Information

There is not any deviation from the test standards for the test method, and no modifications required for compliance.

3 General Information

3.1 Description of EUT

Product	Telematics Control Unit
Brand	Sage
Test Model	34770YZF_A01
FCC ID	VRB34770YZF
Contains WWAN module FCC ID	XPYUBX21BE01
Sample Status	Engineering sample
Operating Software	N/A
Power Supply Rating	10.2Vdc~13.8Vdc from DC Power Supply
Accessory Device	N/A
Data Cable Supplied	N/A

3.2 Primary Clock Frequencies of Internal Source

The highest frequency generated or used within the EUT or on which the EUT operates or tunes is 2.6 GHz, provided by Sage Co., Ltd., for detailed internal source, please refer to the manufacturer's specifications.

3.3 Features of EUT

The tests reported herein were performed according to the method specified by Sage Co., Ltd., for detailed feature description, please refer to the manufacturer's specifications or user's manual.

Please refer to appendix of the report if the applicant has provided additional descriptions of the EUT.

3.4 Operating Modes of EUT and Determination of Worst Case Operating Mode

The EUT has been pre-tested under following test modes.

Test Condition	
Mode	Conducted Emissions from Power Ports
1	EUT + GPS link
2	EUT + LTE Band 5 link (low channel)
3	EUT + LTE Band 5 link (mid channel)
4	EUT + LTE Band 5 link (high channel)
Notes:	
1. There are DC 10.2V, DC 12V and DC 13.8V to be pre-tested then DC 12V has the highest emission value.	
2. The worst case is that mode 2 is shown in bold.	
Mode	Radiated Emissions up to 1 GHz
1	EUT + GPS link
2	EUT + LTE Band 5 link (low channel)
3	EUT + LTE Band 5 link (mid channel)
4	EUT + LTE Band 5 link (high channel)
Notes:	
1. There are DC 10.2V, DC 12V and DC 13.8V to be pre-tested then DC 12V has the highest emission value.	
2. The worst case is that mode 2 is shown in bold.	

Test modes are presented in the report as below.

Test Condition	
Mode	Conducted Emissions from Power Ports
A	EUT + LTE Band 5 link (low channel)
Mode	Radiated Emissions up to 1 GHz
A	EUT + LTE Band 5 link (low channel)
Mode	Radiated Emissions above 1 GHz
A	EUT + LTE Band 5 link (low channel)

3.5 Test Program Used and Operation Descriptions

- a. The EUT powered by the dc power supply.
- b. The EUT communicated data with the Radio Communication Analyzer, which acted as communication partners.

3.6 Connection Diagram of EUT and Peripheral Devices

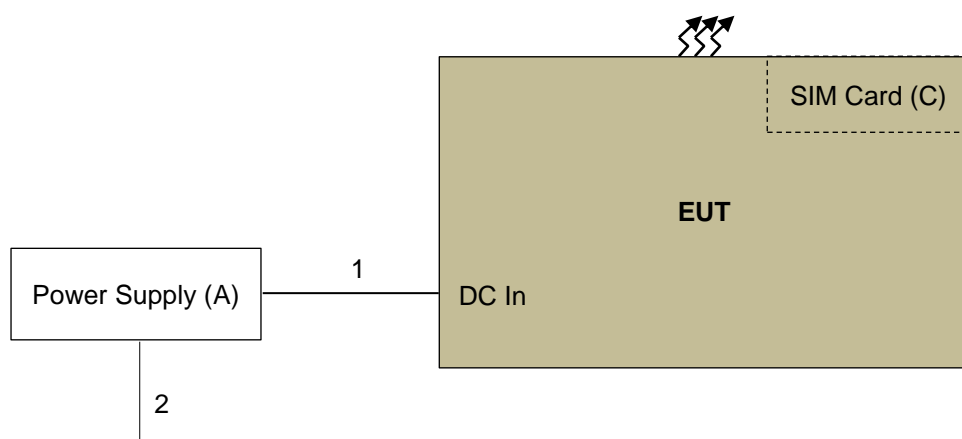

Remote Site

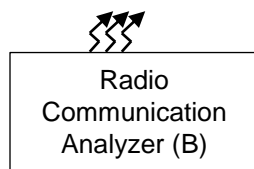

3.7 Configuration of Peripheral Devices and Cable Connections

ID	Product	Brand	Model No.	Serial No.	FCC ID	Remarks
A	Power Supply	TOP WARD	6603A	725906	N/A	Provided by Lab
B	Radio Communication Analyzer	Anritsu	MT8820C	6201010284	N/A	Provided by Lab
C	SIM Card	N/A	N/A	N/A	N/A	Provided by Lab

ID	Cable Descriptions	Qty.	Length (m)	Shielding (Yes/No)	Cores (Qty.)	Remarks
1	DC Cable	1	1.04	No	0	Supplied by applicant
2	Power cable	1	1.8	No	0	Provided by Lab

4 Test Instruments

The calibration interval of the all test instruments are 12 months and the calibrations are traceable to NML/ROC and NIST/USA.

4.1 Conducted Emissions from Power Ports

Description Manufacturer	Model No.	Serial No.	Calibrated Date	Calibrated Until
LISN R&S	ESH3-Z5	100311	2022/9/12	2023/9/11
LISN ROHDE & SCHWARZ	ENV216	101826	2022/3/14	2023/3/13
Receiver R&S	ESCI	100412	2022/8/22	2023/8/21
RF Coaxial Cable WOKEN	5D-FB	Cable-cond1-01	2022/1/15	2023/1/14
Software BVADT	BVADT_Cond_ V7.3.7.4	N/A	N/A	N/A
V-LISN Schwarzbeck	NNBL 8226-2	8226-142	2022/8/31	2023/8/30

Notes:

1. The test was performed in HY - Conduction 1.
2. The VCCI Site Registration No. is C-12040.
3. Tested Date: 2022/12/17

4.2 Radiated Emissions up to 1 GHz

Description Manufacturer	Model No.	Serial No.	Calibrated Date	Calibrated Until
Amplifier Agilent	8447D	2944A10738	2022/7/9	2023/7/8
Antenna Tower BVADT	AT100	AT93021702	N/A	N/A
Attenuator Mini-Circuits	UNAT-5+	PAD-CH3-01	2022/5/14	2023/5/13
Bi_Log Antenna Schwarzbeck	VULB9168	9168-157	2022/10/24	2023/10/23
Controller BVADT	SC100	SC93021702	N/A	N/A
RF Coaxial Cable WORKEN	8D-FB	Cable-CH3-01	2022/5/14	2023/5/13
Software BVADT	ADT_Radiated_V8.7.08	N/A	N/A	N/A
Test Receiver R&S	ESR3	102579	2022/7/1	2023/6/30
Turn Table BVADT	TT100	TT93021702	N/A	N/A

Notes:

1. The test was performed in HY - 966 Chamber 2. The test site validated date: 2022/11/5 (NSA)
2. The VCCI Site Registration No. is R-20132.
3. Tested Date: 2022/12/14

4.3 Radiated Emissions above 1 GHz

Description Manufacturer	Model No.	Serial No.	Calibrated Date	Calibrated Until
Antenna Tower BVADT	AT100	AT93021702	N/A	N/A
Attenuator Mini-Circuits	BW-N4W5+	PAD-CH3-03	2022/7/9	2023/7/8
BandPass Filter MICRO-TRONICS	BRM17690-01	002	2022/9/3	2023/9/2
	BRM50716-01	G010	2022/9/3	2023/9/2
Boresight antenna tower fixture BV	BAF-02	3	N/A	N/A
Controller BVADT	SC100	SC93021702	N/A	N/A
Horn Antenna Schwarzbeck	BBHA 9120 D	209	2022/11/13	2023/11/12
N9030B - PXA Signal Analyzer KEYSIGHT	N9030B	MY60070562	2022/1/6	2023/1/5
Pre_Amplifier Agilent	8449B	3008A02465	2022/3/19	2023/3/18
RF Coaxial Cable HUBER+SUHNER&EMCI	SUCOFLEX 104&EMC104-SM-SM- 8000	Cable-CH3- 03(309224+170907)	2022/7/9	2023/7/8
Software BVADT	ADT_Radiated_V8.7.08	N/A	N/A	N/A
Turn Table BVADT	TT100	TT93021702	N/A	N/A

Notes:

1. The test was performed in HY - 966 Chamber 2. The test site validated date: 2022/5/21 (VSWR)
2. The VCCI Site Registration No. is G-20126.
3. Tested Date: 2022/12/15

5 Limits of Test Items

5.1 Conducted Emissions from Power Ports

Frequency (MHz)	Class A (dBuV)		Class B (dBuV)	
	Quasi-peak	Average	Quasi-peak	Average
0.15 - 0.5	79	66	66 - 56	56 - 46
0.50 - 5.0	73	60	56	46
5.0 - 30.0	73	60	60	50

Notes: 1. The lower limit shall apply at the transition frequencies.
 2. The limit decreases linearly with the logarithm of the frequency in the range of 0.15 to 0.50 MHz.

5.2 Radiated Emissions up to 1 GHz

Emissions radiated outside of the specified bands, shall be according to the general radiated limits as following:

Radiated Emissions Limits at 10 meters (dB μ V/m)				
Frequencies (MHz)	FCC 15B, Class A	FCC 15B, Class B	CISPR 22, Class A	CISPR 22, Class B
30-88	39.1	29.5	40	30
88-216	43.5	33.1		
216-230	46.4	35.6		
230-960				
960-1000	49.5	43.5	47	37

Radiated Emissions Limits at 3 meters (dB μ V/m)				
Frequencies (MHz)	FCC 15B, Class A	FCC 15B, Class B	CISPR 22, Class A	CISPR 22, Class B
30-88	49.5	40.0	50.5	40.5
88-216	54.0	43.5		
216-230	56.9	46.0		
230-960				
960-1000	60.0	54.0	57.5	47.5

Notes: 1. The lower limit shall apply at the transition frequencies.

5.3 Radiated Emissions above 1 GHz

Frequency Range (For unintentional radiators)

Highest frequency generated or used in the device or on which the device operates or tunes (MHz)	Upper frequency of measurement range (MHz)
Below 1.705	30
1.705-108	1000
108-500	2000
500-1000	5000
Above 1000	5th harmonic of the highest frequency or 40GHz, whichever is lower

Radiated Emissions Limits at 3 meters (dB μ V/m)		
Frequency range	Class A	Class B
Above 1GHz	Avg: 60 Peak: 80	Avg: 54 Peak: 74

Notes: 1. These limit levels apply for a measurement distance of 3 m. If using a different measurement distance, the measured levels shall be extrapolated to the 3 m limit distance using a factor of 20 dB per decade of distance. The measurement distance shall place the measurement antenna in the far field of the ITE or digital apparatus under test.

6 Test Arrangements

6.1 Conducted Emissions from Power Ports

- For the table-top EUT is placed on a 0.8 meter insulation table; for the floor standing EUT shall be insulated (by insulation of 12 mm) from the horizontal reference ground plane. The EUT is placed 0.4 meters from the conducting wall of the shielded room with EUT being connected to the power mains through a line impedance stabilization network (LISN). Other support units are connected to the power mains through another LISN. They provide coupling impedance for the measuring instrument.
- Both lines of the power mains connected to the EUT were checked for maximum conducted interference.
- The test results of conducted emissions at mains ports are recorded of six worst margins for quasi-peak (mandatory) [and average (if necessary)] values against the limits at frequencies of interest unless the margin is 20 dB or greater.

Note: The resolution bandwidth and video bandwidth of test receiver is 9kHz for quasi-peak detection (QP) and average detection (AV) at frequency 0.15MHz-30MHz.

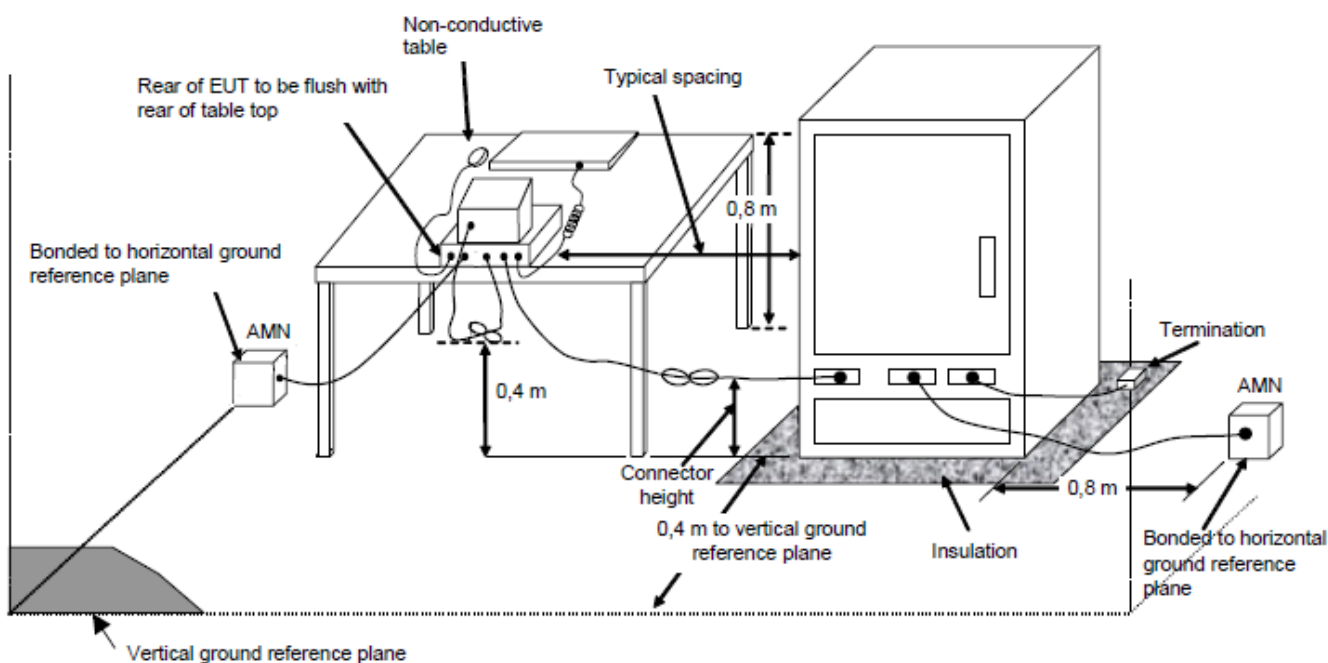

For the actual test configuration, please refer to the related Item – Photographs of the Test Configuration.

6.2 Radiated Emissions up to 1 GHz

- a. For the table-top EUT is placed on a 0.8 meter to the top of rotating table; for the floor standing EUT shall be insulated (by insulation of 12 mm) from the horizontal reference ground plane. The rotating table is rotated 360 degrees to determine the position of the highest radiation. If the equipment requires a dedicated ground connection, this shall be provided and bonded to the RGP.
- b. The EUT was set 3 meters away from the interference-receiving antenna, which was mounted on the top of a variable-height antenna tower.
- c. The antenna is a broadband antenna, and its height is varied from one meter to four meters above the ground to determine the maximum value of the field strength. Both horizontal and vertical polarizations of the antenna are set to make the measurement.
- d. For each suspected emission, the EUT was arranged to its worst case and then the antenna was tuned to heights from 1 meter to 4 meters and the rotatable table was turned from 0 degrees to 360 degrees to find the maximum reading.
- e. The test-receiver system was set to quasi-peak detect function and specified bandwidth with maximum hold mode when the test frequency is up to 1 GHz.

Note: The resolution bandwidth and video bandwidth of test receiver/spectrum analyzer is 120kHz for quasi-peak detection (QP) at frequency up to 1GHz.

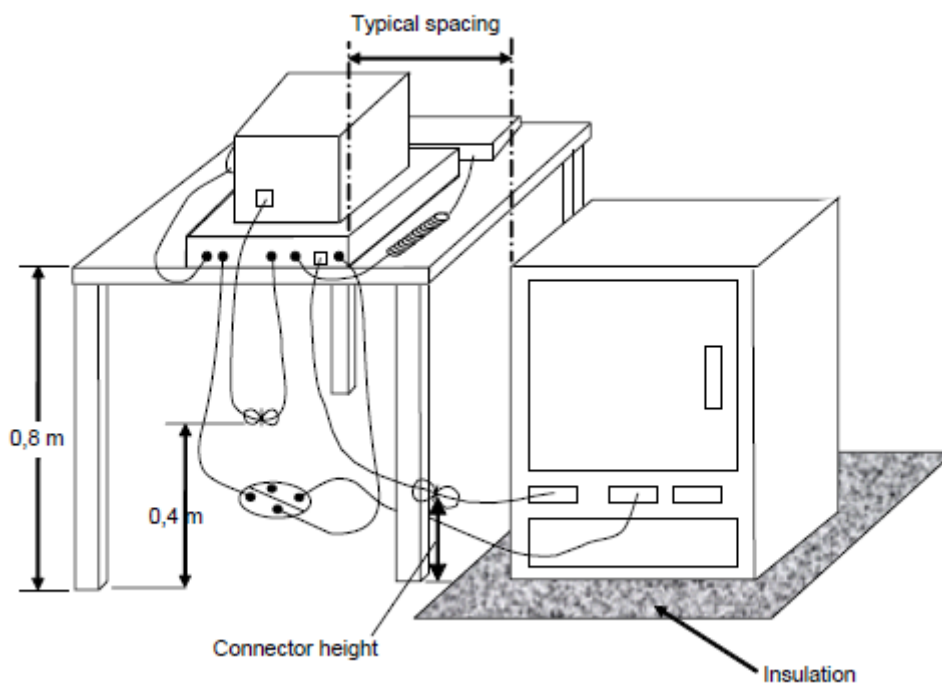

For the actual test configuration, please refer to the related Item – Photographs of the Test Configuration.

6.3 Radiated Emissions above 1 GHz

- For the table-top EUT is placed on a 0.8 meter to the top of rotating table; for the floor standing EUT shall be insulated (by insulation of 12 mm) from the horizontal reference ground plane. The rotating table is rotated 360 degrees to determine the position of the highest radiation. If the equipment requires a dedicated ground connection, this shall be provided and bonded to the RGP.
- The EUT was set $d = 3$ meters away from the interference-receiving antenna, which was mounted on the top of a variable-height antenna tower.
- The height of antenna can be varied from one meter to four meters, the height of adjustment depends on the EUT height and the antenna 3dB beamwidth both, to detect the maximum value of the field strength. Both horizontal and vertical polarizations of the antenna are set to make the measurement.
- For each suspected emission, the EUT was arranged to its worst case and then the antenna was tuned to heights and the rotatable table was turned from 0 degrees to 360 degrees to find the maximum reading.
- The spectrum analyzer system was set to peak and average detects function and specified bandwidth with maximum hold mode when the test frequency is above 1 GHz.

Note: The resolution bandwidth of test receiver/spectrum analyzer is 1MHz and video bandwidth is 3MHz for Peak detection (PK) at frequency above 1GHz. The resolution bandwidth of test receiver/spectrum analyzer is 1 MHz for Average detection (AV) at frequency above 1GHz.

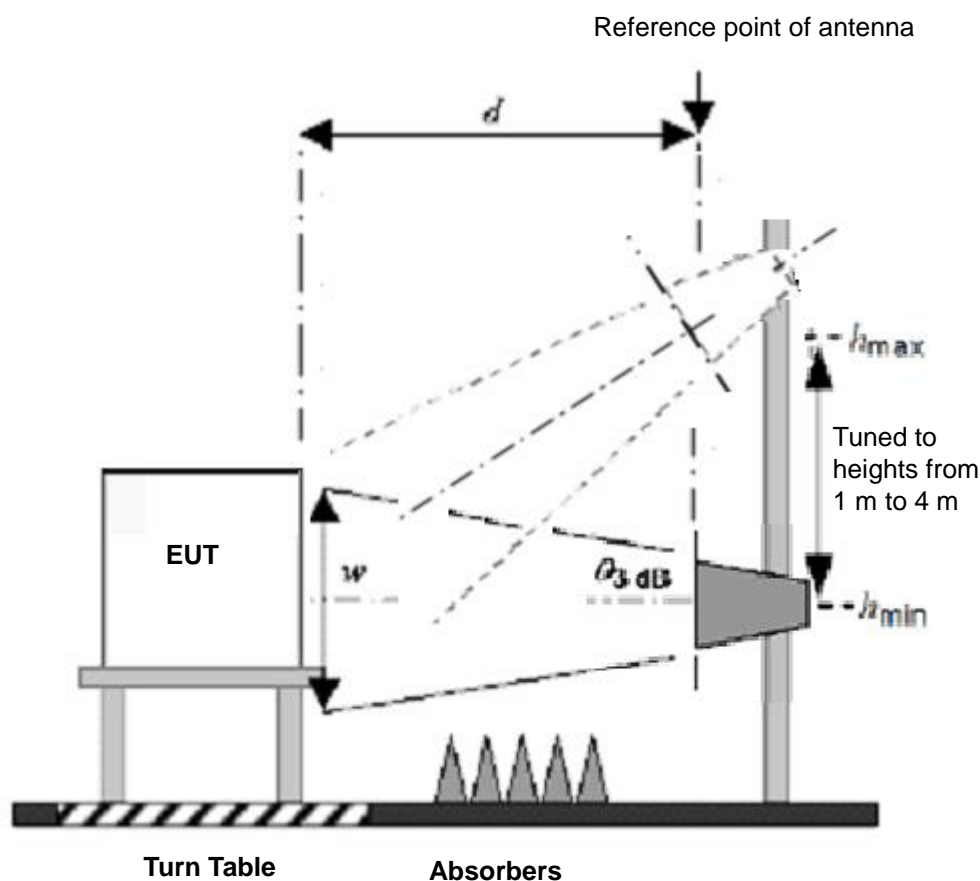

For the actual test configuration, please refer to the related item – Photographs of the Test Configuration.

7 Test Results of Test Item

7.1 Conducted Emissions from Power Ports

Mode A

Frequency Range	150 kHz ~ 30 MHz	Detector Function & Resolution Bandwidth	Quasi-Peak (QP) / Average (AV), 9kHz
Input Power	120 Vac, 60 Hz	Environmental Conditions	19°C, 63% RH
Tested by	Daniel Lin		

Phase Of Power : Line (L)										
No	Frequency (MHz)	Correction Factor (dB)	Reading Value (dBuV)		Emission Level (dBuV)		Limit (dBuV)		Margin (dB)	
			Q.P.	AV.	Q.P.	AV.	Q.P.	AV.	Q.P.	AV.
1	0.20200	9.64	7.09	4.30	16.73	13.94	63.53	53.53	-46.80	-39.59
2	0.25800	9.65	14.91	8.76	24.56	18.41	61.50	51.50	-36.94	-33.09
3	0.66987	9.69	22.77	15.65	32.46	25.34	56.00	46.00	-23.54	-20.66
4	0.73000	9.70	21.30	18.30	31.00	28.00	56.00	46.00	-25.00	-18.00
5	4.53800	9.76	11.54	8.33	21.30	18.09	56.00	46.00	-34.70	-27.91
6	22.81800	9.87	10.40	6.75	20.27	16.62	60.00	50.00	-39.73	-33.38

Remarks:

1. Q.P. and AV. are abbreviations of quasi-peak and average individually.
2. The emission levels of other frequencies were very low against the limit.
3. Margin value = Emission level – Limit value
4. Correction factor = Insertion loss + Cable loss
5. Emission Level = Correction Factor + Reading Value

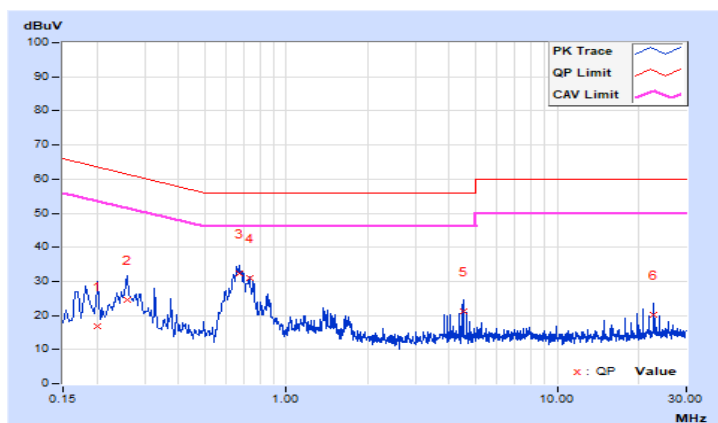

Frequency Range	150 kHz ~ 30 MHz	Detector Function & Resolution Bandwidth	Quasi-Peak (QP) / Average (AV), 9kHz
Input Power	120 Vac, 60 Hz	Environmental Conditions	19°C, 63% RH
Tested by	Daniel Lin		

Phase Of Power : Neutral (N)										
No	Frequency (MHz)	Correction Factor (dB)	Reading Value (dBuV)		Emission Level (dBuV)		Limit (dBuV)		Margin (dB)	
			Q.P.	AV.	Q.P.	AV.	Q.P.	AV.	Q.P.	AV.
1	0.15400	9.62	22.30	18.60	31.92	28.22	65.78	55.78	-33.86	-27.56
2	0.30200	9.67	13.74	4.29	23.41	13.96	60.19	50.19	-36.78	-36.23
3	0.65800	9.69	23.63	16.50	33.32	26.19	56.00	46.00	-22.68	-19.81
4	1.48200	9.71	15.30	10.30	25.01	20.01	56.00	46.00	-30.99	-25.99
5	4.54200	9.76	8.31	7.20	18.07	16.96	56.00	46.00	-37.93	-29.04
6	22.81400	9.88	14.36	10.24	24.24	20.12	60.00	50.00	-35.76	-29.88

Remarks:

1. Q.P. and AV. are abbreviations of quasi-peak and average individually.
2. The emission levels of other frequencies were very low against the limit.
3. Margin value = Emission level – Limit value
4. Correction factor = Insertion loss + Cable loss
5. Emission Level = Correction Factor + Reading Value

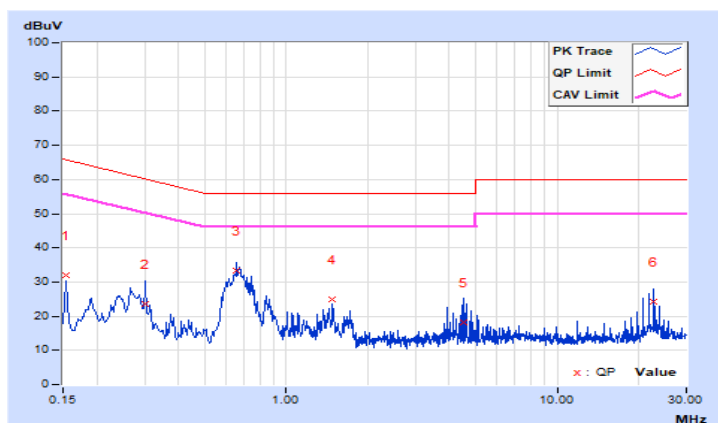

7.2 Radiated Emissions up to 1 GHz

Mode B

Frequency Range	30 MHz ~ 1 GHz	Detector Function & Resolution Bandwidth	Quasi-Peak (QP), 120 kHz
Tested By	Fox Chang	Environmental Conditions	18°C, 70% RH

Antenna Polarity & Test Distance : Horizontal at 3 m

No	Frequency (MHz)	Emission Level (dBuV/m)	Limit (dBuV/m)	Margin (dB)	Antenna Height (m)	Table Angle (Degree)	Raw Value (dBuV)	Correction Factor (dB/m)
1	61.67	33.09 QP	40.00	-6.91	3.50 H	43	43.30	-10.21
2	98.97	26.98 QP	43.50	-16.52	4.00 H	47	40.87	-13.89
3	199.95	35.09 QP	43.50	-8.41	1.50 H	37	47.02	-11.93
4	259.08	28.00 QP	46.00	-18.00	1.50 H	235	36.35	-8.35
5	440.09	32.06 QP	46.00	-13.94	2.50 H	275	36.78	-4.72
6	520.02	39.07 QP	46.00	-6.93	2.00 H	68	42.71	-3.64

Remarks:

1. Emission Level(dBuV/m) = Raw Value(dBuV) + Correction Factor(dB/m)
2. Correction Factor(dB/m) = Antenna Factor (dB/m) + Cable Factor (dB)
– Pre-Amplifier Factor (dB)
3. The other emission levels were very low against the limit.
4. Margin value = Emission level – Limit value

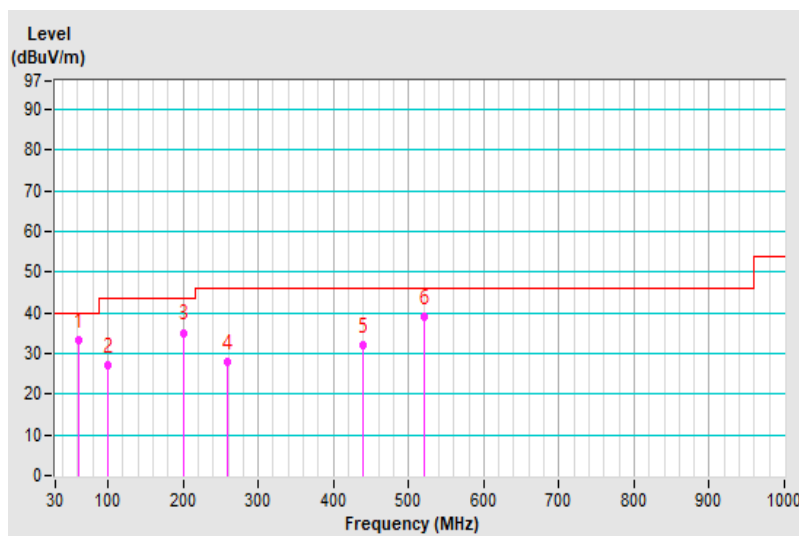

Frequency Range	30 MHz ~ 1 GHz	Detector Function & Resolution Bandwidth	Quasi-Peak (QP), 120 kHz
Tested By	Fox Chang	Environmental Conditions	18°C, 70% RH

Antenna Polarity & Test Distance : Vertical at 3 m								
No	Frequency (MHz)	Emission Level (dBuV/m)	Limit (dBuV/m)	Margin (dB)	Antenna Height (m)	Table Angle (Degree)	Raw Value (dBuV)	Correction Factor (dB/m)
1	43.14	36.83 QP	40.00	-3.17	1.00 V	351	46.50	-9.67
2	61.82	36.39 QP	40.00	-3.61	1.00 V	248	46.60	-10.21
3	98.97	25.96 QP	43.50	-17.54	4.00 V	57	39.85	-13.89
4	199.90	31.54 QP	43.50	-11.96	3.50 V	77	43.47	-11.93
5	439.99	32.83 QP	46.00	-13.17	1.50 V	197	37.55	-4.72
6	519.97	36.07 QP	46.00	-9.93	1.00 V	360	39.71	-3.64

Remarks:

1. Emission Level(dBuV/m) = Raw Value(dBuV) + Correction Factor(dB/m)
2. Correction Factor(dB/m) = Antenna Factor (dB/m) + Cable Factor (dB)
– Pre-Amplifier Factor (dB)
3. The other emission levels were very low against the limit.
4. Margin value = Emission level – Limit value

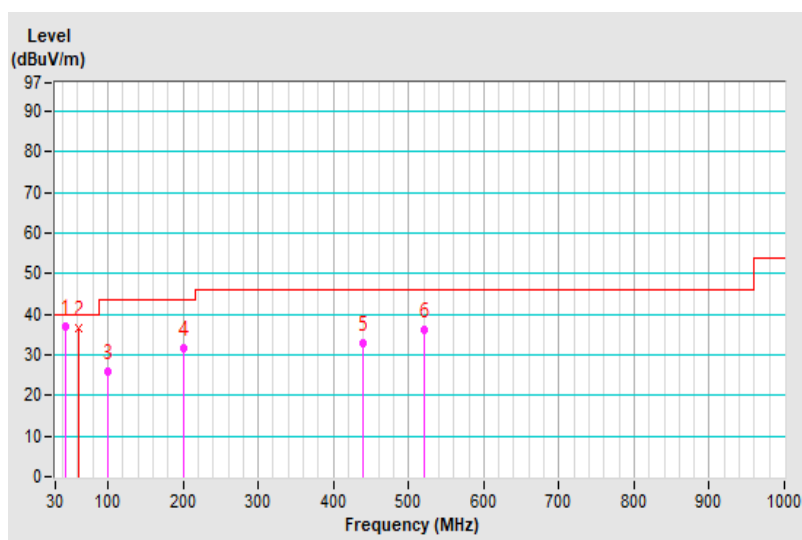

7.3 Radiated Emissions above 1 GHz

Mode A

Frequency Range	1 GHz ~ 13.5 GHz	Detector Function & Resolution Bandwidth	Peak (PK) / Average (AV), 1MHz
Tested By	Fox Chang	Environmental Conditions	18°C, 70% RH

Antenna Polarity & Test Distance : Horizontal at 3 m								
No	Frequency (MHz)	Emission Level (dBuV/m)	Limit (dBuV/m)	Margin (dB)	Antenna Height (m)	Table Angle (Degree)	Raw Value (dBuV)	Correction Factor (dB/m)
1	1119.69	45.88 PK	74.00	-28.12	1.41 H	206	49.22	-3.34
2	1119.69	28.85 AV	54.00	-25.15	1.41 H	206	32.19	-3.34
3	1874.99	45.92 PK	74.00	-28.08	1.00 H	318	47.70	-1.78
4	1874.99	41.63 AV	54.00	-12.37	1.00 H	318	43.41	-1.78
5	3117.79	45.33 PK	74.00	-28.67	1.42 H	98	43.30	2.03
6	3117.79	31.46 AV	54.00	-22.54	1.42 H	98	29.43	2.03

Remarks:

1. Emission Level(dBuV/m) = Raw Value(dBuV) + Correction Factor(dB/m)
2. Correction Factor(dB/m) = Antenna Factor (dB/m) + Cable Factor (dB)
– Pre-Amplifier Factor (dB)
3. The other emission levels were very low against the limit.
4. Margin value = Emission level – Limit value

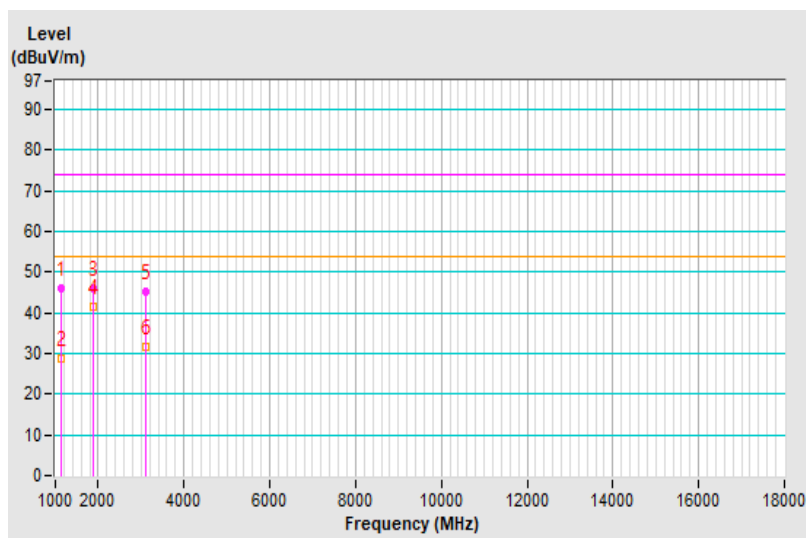

Frequency Range	1 GHz ~ 13.5 GHz	Detector Function & Resolution Bandwidth	Peak (PK) / Average (AV), 1MHz
Tested By	Fox Chang	Environmental Conditions	18°C, 70% RH

Antenna Polarity & Test Distance : Vertical at 3 m								
No	Frequency (MHz)	Emission Level (dBuV/m)	Limit (dBuV/m)	Margin (dB)	Antenna Height (m)	Table Angle (Degree)	Raw Value (dBuV)	Correction Factor (dB/m)
1	1124.38	47.65 PK	74.00	-26.35	1.59 V	334	51.01	-3.36
2	1124.38	28.48 AV	54.00	-25.52	1.59 V	334	31.84	-3.36
3	1875.03	41.33 PK	74.00	-32.67	1.28 V	280	43.10	-1.77
4	1875.03	33.96 AV	54.00	-20.04	1.28 V	280	35.73	-1.77
5	3123.68	44.95 PK	74.00	-29.05	1.00 V	67	42.93	2.02
6	3123.68	32.18 AV	54.00	-21.82	1.00 V	67	30.16	2.02

Remarks:

1. Emission Level(dBuV/m) = Raw Value(dBuV) + Correction Factor(dB/m)
2. Correction Factor(dB/m) = Antenna Factor (dB/m) + Cable Factor (dB) – Pre-Amplifier Factor (dB)
3. The other emission levels were very low against the limit.
4. Margin value = Emission level – Limit value

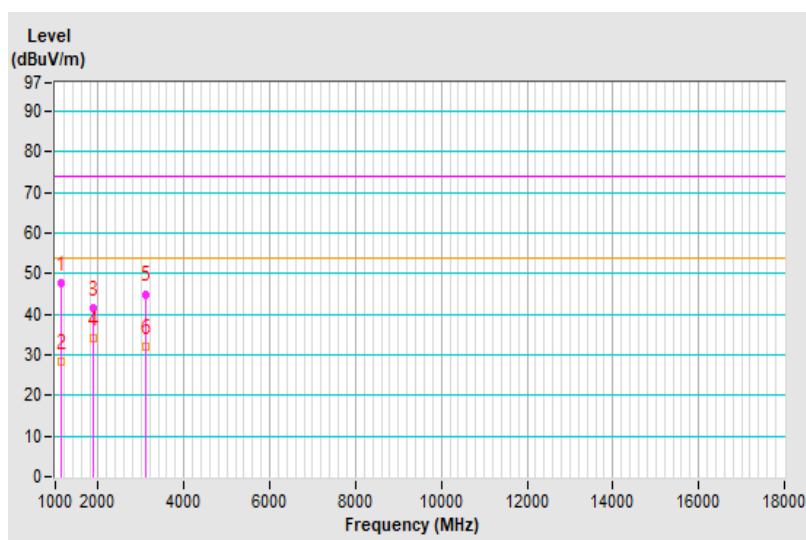

8 Pictures of Test Arrangements

Please refer to the attached file (Test Setup Photo).

9 Information of the Testing Laboratories

We, Bureau Veritas Consumer Products Services (H.K.) Ltd., Taoyuan Branch, were founded in 1988 to provide our best service in EMC, Radio, Telecom and Safety consultation. Our laboratories are FCC recognized accredited test firms and accredited according to ISO/IEC 17025.

If you have any comments, please feel free to contact us at the following:

Lin Kou EMC/RF Lab

Tel: 886-2-26052180

Fax: 886-2-26051924

Hsin Chu EMC/RF/Telecom Lab

Tel: 886-3-6668565

Fax: 886-3-6668323

Hwa Ya EMC/RF/Safety Lab

Tel: 886-3-3183232

Fax: 886-3-3270892

Email: service.adt@bureauveritas.com

Web Site: <http://ee.bureauveritas.com.tw>

The address and road map of all our labs can be found in our web site also.

--- END ---