



MET Laboratories, Inc. *Safety Certification - EMI - Telecom Environmental Simulation*

914 WEST PATAPSCO AVENUE • BALTIMORE, MARYLAND 21230-3432 • PHONE (410) 354-3300 • FAX (410) 354-3313

33439 WESTERN AVENUE • UNION CITY, CALIFORNIA 94587 • PHONE (510) 489-6300 • FAX (510) 489-6372

3162 BELICK STREET • SANTA CLARA, CA 95054 • PHONE (408) 748-3585 • FAX (510) 489-6372

13301 MCCALLEN PASS • AUSTIN, TEXAS 78753 • PHONE (512) 287-2500 • FAX (512) 287-2513

August 11, 2014

Amimon
2 Maskit St Building D, 2nd floor
Herzeliya, Israel 46733

Dear Tal Keren-Zvi,

Enclosed is the EMC Wireless test report for compliance testing of the Amimon, MAGLAN as tested to the requirements of Title 47 of the CFR, Ch. 1 (10-1-06 ed.), Title 47 of the CFR, Part 15, Subpart B and ICES-003, Issue 5 August 2012 for Unintentional Radiators, and Part 15.407 Subpart E and RSS-210, Issue 8, Dec. 2010 for Intentional Radiators.

Thank you for using the services of MET Laboratories, Inc. If you have any questions regarding these results or if MET can be of further service to you, please feel free to contact me.

Sincerely yours,
MET LABORATORIES, INC.

Jennifer Warnell
Documentation Department

Reference: (\Amimon\ EMC41655B-FCC407 UNII 3 Rev. 3)

Certificates and reports shall not be reproduced except in full, without the written permission of MET Laboratories, Inc.

Electromagnetic Compatibility Criteria Test Report

for the

**Amimon
Model MAGLAN**

Tested under
the Certification Rules
contained in
Title 47 of the CFR, Part 15, Subpart B & ICES-003
for Unintentional Radiators
and
15.407 Subpart E & & RSS-210, Issue 8, Dec. 2010
for Intentional Radiators

MET Report: EMC41655B-FCC407 UNII 3 Rev. 3

August 11, 2014

Prepared For:

**Amimon
2 Maskit St Building D, 2nd floor
Herzeliya, Israel 46733**

Prepared By:
MET Laboratories, Inc.
914 W. Patapsco Ave.
Baltimore, MD 21230

Electromagnetic Compatibility Criteria Test Report

for the

Amimon Model MAGLAN

the Certification Rules
contained in
Title 47 of the CFR, Part 15, Subpart B & ICES-003
for Unintentional Radiators
and
15.407 Subpart E & & RSS-210, Issue 8, Dec. 2010
for Intentional Radiators



Surinder Singh, Project Engineer
Electromagnetic Compatibility Lab



Jennifer Warnell
Documentation Department

Engineering Statement: The measurements shown in this report were made in accordance with the procedures indicated, and the emissions from this equipment were found to be within the limits applicable. I assume full responsibility for the accuracy and completeness of these measurements, and for the qualifications of all persons taking them. It is further stated that upon the basis of the measurements made, the equipment tested is capable of operation in accordance with the requirements of Parts 15B, 15.407, of the FCC Rules under normal use and maintenance.



Asad Bajwa
Director, Electromagnetic Compatibility Lab

Report Status Sheet

Revision	Report Date	Reason for Revision
∅	August 4, 2014	Initial Issue.
1	August 11, 2014	Revised to reflect engineer corrections.
2	August 11, 2014	Revised to reflect minor editorial corrections.
3	August 12, 2014	Revised to reflect further minor editorial corrections.

Table of Contents

I.	Executive Summary	1
	A. Purpose of Test	2
	B. Executive Summary	2
II.	Equipment Configuration	3
	A. Overview.....	4
	B. References.....	5
	C. Test Site	5
	D. Description of Test Sample.....	6
	E. Equipment Configuration.....	6
	F. Support Equipment	7
	G. Ports and Cabling Information.....	7
	H. Mode of Operation.....	7
	I. Method of Monitoring EUT Operation	7
	J. Modifications	8
	a) Modifications to EUT.....	8
	b) Modifications to Test Standard.....	8
	K. Disposition of EUT	8
III.	Electromagnetic Compatibility Criteria for Unintentional Radiators	9
	§ 15.107(a) Conducted Emissions Limits.....	10
	§ 15.109(a) Radiated Emissions Limits.....	13
IV.	Electromagnetic Compatibility Criteria for Intentional Radiators	16
	§ 15.203 Antenna Requirement	17
	§ 15.207 Conducted Emissions Limits	18
	§ 15.403(c) 26dB Bandwidth.....	21
	§ 15.407(a)(1) RF Power Output	27
	§ 15.407(a)(2) Peak Power Spectral Density	35
	§ 15.407(b)(1), (6), (7) Undesirable Emissions	50
	§ 15.407(f) RF Exposure	75
V.	Test Equipment	77
VI.	Certification & User's Manual Information	79
	A. Certification Information	80
	B. Label and User's Manual Information	84
VII.	ICES-003 Procedural & Labeling Requirements.....	86

List of Tables

Table 1. Executive Summary of EMC Part 15.407 Compliance Testing	2
Table 2. EUT Summary.....	4
Table 3. References	5
Table 4. Equipment Configuration	6
Table 5. Support Equipment.....	7
Table 6. Ports and Cabling Information	7
Table 7. Conducted Limits for Radio Frequency Devices calculated from FCC Part 15 Subsections 15.107(a) (b)	10
Table 8. Conducted Emissions - Voltage, AC Power, Phase Line	11
Table 9. Conducted Emissions - Voltage, AC Power, Neutral Line.....	12
Table 10. Radiated Emissions Limits calculated from FCC Part 15, §15.109 (a) (b)	13
Table 11. Radiated Emissions Limits, Test Results, 30 MHz – 1 GHz.....	14
Table 12. Radiated Emissions Limits, Test Results, 1 GHz – 2 GHz.....	15
Table 13. Conducted Limits for Intentional Radiators from FCC Part 15 § 15.207(a)	18
Table 14. Conducted Emissions, 15.207(a), Phase Line, Test Results	19
Table 15. Conducted Emissions, 15.207(a), Neutral Line, Test Results	20
Table 16. 26 dB Occupied Bandwidth, Test Results	21
Table 17. 26 dB Occupied Bandwidth, Test Results	21
Table 18. RF Power Output, Test Results, 5 dBi.....	27
Table 19. RF Power Output, Test Results, 13.5 dBi.....	27
Table 20. Power Spectral Density, Test Results, 5 dBi	35
Table 21. Power Spectral Density, Test Results, 13.5 dBi	35
Table 23. Test Equipment List	78

List of Figures

Figure 1. Block Diagram of Test Configuration.....	6
Figure 2. Occupied Bandwidth, Test Setup	21
Figure 3. Power Output Test Setup	28
Figure 4. Power Spectral Density Test Setup	35

List of Plots

Plot 1. Conducted Emissions, Phase Line Plot	11
Plot 2. Conducted Emissions, Neutral Line Plot	12
Plot 3. Radiated Emissions, 30 MHz - 1 GHz	14
Plot 4. Conducted Emissions, 15.207(a), Phase Line	19
Plot 5. Conducted Emissions, 15.207(a), Neutral Line	20
Plot 6. 26 dB Occupied Bandwidth, 5745 MHz	22
Plot 7. 26 dB Occupied Bandwidth, 5755 MHz	22
Plot 8. 26 dB Occupied Bandwidth, 5765 MHz	22
Plot 9. 26 dB Occupied Bandwidth, 5785 MHz	23
Plot 10. 26 dB Occupied Bandwidth, 5795 MHz	23
Plot 11. 26 dB Occupied Bandwidth, 5805 MHz	23
Plot 12. 26 dB Occupied Bandwidth, 5825 MHz	24
Plot 13. 99% Occupied Bandwidth, 5745 MHz	25
Plot 14. 99% Occupied Bandwidth, 5755 MHz	25
Plot 15. 99% Occupied Bandwidth, 5785 MHz	25
Plot 16. 99% Occupied Bandwidth, 5795 MHz	26
Plot 17. 99% Occupied Bandwidth, 5805 MHz	26
Plot 18. 99% Occupied Bandwidth, 5825 MHz	26

Plot 19. RF Power Output, 5745 MHz, 5 dBi.....	29
Plot 20. RF Power Output, 5755 MHz, 5 dBi.....	29
Plot 21. RF Power Output, 5765 MHz, 5 dBi.....	29
Plot 22. RF Power Output, 5785 MHz, 5 dBi.....	30
Plot 23. RF Power Output, 5795 MHz, 5 dBi.....	30
Plot 24. RF Power Output, 5805 MHz, 5 dBi.....	30
Plot 25. RF Power Output, 5825 MHz, 5 dBi.....	31
Plot 26. RF Power Output, 5745 MHz, 13.5 dBi.....	32
Plot 27. RF Power Output, 5755 MHz, 13.5 dBi.....	32
Plot 28. RF Power Output, 5765 MHz, 13.5 dBi.....	32
Plot 29. RF Power Output, 5785 MHz, 13.5 dBi.....	33
Plot 30. RF Power Output, 5795 MHz, 13.5 dBi.....	33
Plot 31. RF Power Output, 5805 MHz, 13.5 dBi.....	33
Plot 32. RF Power Output, 5825MHz, 13.5dBi.....	34
Plot 33. Power Spectral Density Peak Determination, 5745 MHz, 5 dBi	36
Plot 34. Power Spectral Density, 5745 MHz, 5 dBi	36
Plot 35. Power Spectral Density Peak Determination, 5755 MHz, 5 dBi	37
Plot 36. Power Spectral Density, 5755 MHz, 5 dBi	37
Plot 37. Power Spectral Density Peak Determination, 5785 MHz, 5 dBi	38
Plot 38. Power Spectral Density, 5785 MHz, 5 dBi	38
Plot 39. Power Spectral Density Peak Determination, 5795 MHz, 5 dBi	39
Plot 40. Power Spectral Density, 5795 MHz, 5 dBi	39
Plot 41. Power Spectral Density Peak Determination, 5805 MHz, 5 dBi	40
Plot 42. Power Spectral Density, 5805 MHz, 5 dBi	40
Plot 43. Power Spectral Density Peak Determination, 5825 MHz, 5 dBi	41
Plot 44. Power Spectral Density, 5825 MHz, 5 dBi	41
Plot 45. Power Spectral Density Determination, 5745 MHz, 13.5 dBi	42
Plot 46. Power Spectral Density, 5745 MHz, 13.5 dBi	42
Plot 47. Power Spectral Density Determination, 5755 MHz, 13.5 dBi	43
Plot 48. Power Spectral Density, 5755 MHz, 13.5 dBi	43
Plot 49. Power Spectral Density Determination, 5785 MHz, 13.5 dBi	44
Plot 50. Power Spectral Density, 5785 MHz, 13.5 dBi	44
Plot 51. Power Spectral Density Determination, 5795 MHz, 13.5 dBi	45
Plot 52. Power Spectral Density, 5795 MHz, 13.5 dBi	45
Plot 53. Power Spectral Density Determination, 5805 MHz, 13.5 dBi	46
Plot 54. Power Spectral Density, 5805 MHz, 13.5 dBi	46
Plot 55. Power Spectral Density Determination, 5825 MHz, 13.5 dBi	47
Plot 56. Power Spectral Density, 5825MHz, 13dBi	47
Plot 57. Maximum Conducted Output Power/1MHz, 5785 MHz, 5 dBi Antenna	48
Plot 58. PSD Maximum Conducted Output Power/1MHz, 5795 MHz, 5 dBi Antenna	48
Plot 59. PSD Maximum Conducted Output Power/1MHz, 5785 MHz, 13.5 dBi Antenna	49
Plot 60. PSD Maximum Conducted Output Power/1MHz, 5795 MHz, 13.5 dBi Antenna	49
Plot 61. Radiated Spurious Emissions, 5745 MHz, 30 MHz – 1 GHz, 2 dBi Antenna	51
Plot 62. Radiated Spurious Emissions, 5745 MHz, 1 GHz – 7 GHz, 2 dBi Antenna	51
Plot 63. Radiated Spurious Emissions, 5745 MHz, 7 GHz – 18 GHz, 2 dBi Antenna.....	51
Plot 64. Radiated Spurious Emissions, 5755 MHz, 30 MHz – 1 GHz, 2 dBi Antenna	52
Plot 65. Radiated Spurious Emissions, 5755 MHz, 1 GHz – 7 GHz, 2 dBi Antenna	52
Plot 66. Radiated Spurious Emissions, 5755 MHz, 7 GHz – 18 GHz, 2 dBi Antenna.....	52
Plot 67. Radiated Spurious Emissions, 5785 MHz, 30 MHz – 1 GHz, 2 dBi Antenna	53
Plot 68. Radiated Spurious Emissions, 5785 MHz, 1 GHz – 7 GHz, 2 dBi Antenna	53
Plot 69. Radiated Spurious Emissions, 5785 MHz, 7 GHz – 18 GHz, 2 dBi Antenna.....	53
Plot 70. Radiated Spurious Emissions, 5795 MHz, 30 MHz – 1 GHz, 2 dBi Antenna	54
Plot 71. Radiated Spurious Emissions, 5795 MHz, 1 GHz – 7 GHz, 2 dBi Antenna.....	54
Plot 72. Radiated Spurious Emissions, 5795 MHz, 7 GHz – 18 GHz, 2 dBi Antenna.....	54
Plot 73. Radiated Spurious Emissions, 5805 MHz, 30 MHz – 1 GHz, 2 dBi Antenna	55
Plot 74. Radiated Spurious Emissions, 5805 MHz, 1 GHz – 7 GHz, 2 dBi Antenna.....	55

Plot 75. Radiated Spurious Emissions, 5805 MHz, 7 GHz – 18 GHz, 2 dBi Antenna.....	55
Plot 76. Radiated Spurious Emissions, Support Equipment Present Radio Off, 30 MHz – 1 GHz, 2 dBi	56
Plot 77. Radiated Spurious Emissions, 5745 MHz, 30 MHz – 1 GHz, 5 dBi Antenna	57
Plot 78. Radiated Spurious Emissions, 5745 MHz, 1 GHz – 7 GHz, 5 dBi Antenna.....	57
Plot 79. Radiated Spurious Emissions, 5745 MHz, 7 GHz – 18 GHz, 5 dBi Antenna.....	57
Plot 80. Radiated Spurious Emissions, 5755 MHz, 30 MHz – 1 GHz, 5 dBi Antenna	58
Plot 81. Radiated Spurious Emissions, 5755 MHz, 1 GHz – 7 GHz, 5 dBi Antenna.....	58
Plot 82. Radiated Spurious Emissions, 5755 MHz, 7 GHz – 18 GHz, 5 dBi Antenna.....	58
Plot 83. Radiated Spurious Emissions, 5785 MHz, 30 MHz – 1 GHz, 5 dBi Antenna	59
Plot 84. Radiated Spurious Emissions, 5785 MHz, 1 GHz – 7 GHz, 5 dBi Antenna.....	59
Plot 85. Radiated Spurious Emissions, 5785 MHz, 7 GHz – 18 GHz, 5 dBi Antenna.....	59
Plot 86. Radiated Spurious Emissions, 5795 MHz, 30 MHz – 1 GHz, 5 dBi Antenna	60
Plot 87. Radiated Spurious Emissions, 5795 MHz, 1 GHz – 7 GHz, 5 dBi Antenna.....	60
Plot 88. Radiated Spurious Emissions, 5795 MHz, 7 GHz – 18 GHz, 5 dBi Antenna.....	60
Plot 89. Radiated Spurious Emissions, 5805 MHz, 30 MHz – 1 GHz, 5 dBi Antenna	61
Plot 90. Radiated Spurious Emissions, 5805 MHz, 1 GHz – 7 GHz, 5 dBi Antenna.....	61
Plot 91. Radiated Spurious Emissions, 5805 MHz, 7 GHz – 18 GHz, 5 dBi Antenna.....	61
Plot 92. Radiated Spurious Emissions, Support Equipment Present Radio Off, 30 MHz – 1 GHz, 5 dBi.....	62
Plot 93. Radiated Spurious Emissions, 5745 MHz, 30 MHz – 1 GHz, 13.5 dBi Antenna	63
Plot 94. Radiated Spurious Emissions, 5745 MHz, 1 GHz – 7 GHz, 13.5 dBi Antenna.....	63
Plot 95. Radiated Spurious Emissions, 5745 MHz, 7 GHz – 18 GHz, 13.5 dBi Antenna.....	63
Plot 96. Radiated Spurious Emissions, 5755 MHz, 30 MHz – 1 GHz, 13.5 dBi Antenna	64
Plot 97. Radiated Spurious Emissions, 5755 MHz, 1 GHz – 7 GHz, 13.5 dBi Antenna.....	64
Plot 98. Radiated Spurious Emissions, 5755 MHz, 7 GHz – 18 GHz, 13.5 dBi Antenna.....	64
Plot 99. Radiated Spurious Emissions, 5785 MHz, 30 MHz – 1 GHz, 13.5 dBi Antenna	65
Plot 100. Radiated Spurious Emissions, 5785 MHz, 1 GHz – 7 GHz, 13.5 dBi Antenna.....	65
Plot 101. Radiated Spurious Emissions, 5785 MHz, 7 GHz – 18 GHz, 13.5 dBi Antenna.....	65
Plot 102. Radiated Spurious Emissions, 5795 MHz, 30 MHz – 1 GHz, 13.5 dBi Antenna	66
Plot 103. Radiated Spurious Emissions, 5795 MHz, 1 GHz – 7 GHz, 13.5 dBi Antenna.....	66
Plot 104. Radiated Spurious Emissions, 5795 MHz, 7 GHz – 18 GHz, 13.5 dBi Antenna.....	66
Plot 105. Radiated Spurious Emissions, 5805 MHz, 30 MHz – 1 GHz, 13.5 dBi Antenna	67
Plot 106. Radiated Spurious Emissions, 5805 MHz, 1 GHz – 7 GHz, 13.5 dBi Antenna.....	67
Plot 107. Radiated Spurious Emissions, 5805 MHz, 7 GHz – 18 GHz, 13.5 dBi Antenna.....	67
Plot 108. Radiated Spurious Emissions, Band Edge, 5745 MHz, 2 dBi.....	68
Plot 109. Radiated Spurious Emissions, Band Edge, 5755 MHz, 2 dBi.....	68
Plot 110. Radiated Spurious Emissions, Band Edge, 5795 MHz, 2 dBi.....	68
Plot 111. Radiated Spurious Emissions, Band Edge, 5805 MHz, 2 dBi.....	69
Plot 112. Radiated Spurious Emissions, Band Edge, 5825 MHz, 2 dBi.....	69
Plot 113. Radiated Spurious Emissions, Band Edge, 5745 MHz, 5 dBi.....	70
Plot 114. Radiated Spurious Emissions, Band Edge, 5755 MHz, 5 dBi.....	70
Plot 115. Radiated Spurious Emissions, Band Edge, 5795 MHz, 5 dBi.....	70
Plot 116. Radiated Spurious Emissions, Band Edge, 5805 MHz, 5 dBi.....	71
Plot 117. Radiated Spurious Emissions, Band Edge, 5825 MHz, 5 dBi.....	71
Plot 118. Radiated Spurious Emissions, Band Edge, 5745 MHz, 13.5 dBi.....	72
Plot 119. Radiated Spurious Emissions, Band Edge, 5755 MHz, 13.5 dBi.....	72
Plot 120. Radiated Spurious Emissions, Band Edge, 5795 MHz, 13.5 dBi.....	72
Plot 121. Radiated Spurious Emissions, Band Edge, 5805 MHz, 13.5 dBi.....	73
Plot 122. Radiated Spurious Emissions, Band Edge, 5825 MHz, 13.5 dBi.....	73
Plot 123. Radiated Spurious Emissions, Band Edge, 5825 MHz, 1 MHz Integration -17dBm.....	73
Plot 124. Radiated Spurious Emissions, Band Edge, 5825 MHz, 1 MHz Integration -27dBm.....	74

List of Terms and Abbreviations

AC	Alternating Current
ACF	Antenna Correction Factor
Cal	Calibration
<i>d</i>	Measurement Distance
dB	Decibels
dBμA	Decibels above one microamp
dBμV	Decibels above one microvolt
dBμA/m	Decibels above one microamp per meter
dBμV/m	Decibels above one microvolt per meter
DC	Direct Current
E	Electric Field
DSL	Digital Subscriber Line
ESD	Electrostatic Discharge
EUT	Equipment Under Test
<i>f</i>	Frequency
FCC	Federal Communications Commission
GRP	Ground Reference Plane
H	Magnetic Field
HCP	Horizontal Coupling Plane
Hz	Hertz
IEC	International Electrotechnical Commission
kHz	kilohertz
kPa	kilopascal
kV	kilovolt
LISN	Line Impedance Stabilization Network
MHz	Megahertz
μH	microhenry
μ	microfarad
μs	microseconds
PRF	Pulse Repetition Frequency
RF	Radio Frequency
RMS	Root-Mean-Square
TWT	Traveling Wave Tube
V/m	Volts per meter
VCP	Vertical Coupling Plane

I. Executive Summary

A. Purpose of Test

An EMC evaluation was performed to determine compliance of the Amimon MAGLAN, with the requirements of Part 15, §15.407. All references are to the most current version of Title 47 of the Code of Federal Regulations in effect. In accordance with §2.1033, the following data is presented in support of the Certification of the MAGLAN. Amimon should retain a copy of this document which should be kept on file for at least two years after the manufacturing of the MAGLAN, has been **permanently** discontinued.

B. Executive Summary

The following tests were conducted on a sample of the equipment for the purpose of demonstrating compliance with Part 15, §15.407, in accordance with Amimon, purchase order number 35. All tests were conducted using measurement procedure ANSI C63.4-2003.

FCC Reference	IC Reference RSS-210 Issue 8: 2010; RSS-GEN Issue 3: 2010	Description	Results
47 CFR Part 15.107 (a)	ICES-003 Issue 5 August 2012	Conducted Emission Limits for a Class B Digital Device	Compliant
47 CFR Part 15.109 (a)	ICES-003 Issue 5 August 2012	Radiated Emission Limits for a Class B Digital Device	Compliant
Title 47 of the CFR, Part 15 §15.203	N/A	Antenna Requirement	Compliant
Title 47 of the CFR, Part 15 §15.207(a)	RSS-GEN (7.2.4)	Conducted Emission Limits	Compliant
Title 47 of the CFR, Part 15 §15.403 (i)	RSS-Gen (4.6)	26dB Occupied Bandwidth	Compliant
		99% Occupied Bandwidth	Compliant
Title 47 of the CFR, Part 15 §15.407 (a)(3)	RSS-210 (A9.2)	Conducted Transmitter Output Power	Compliant
Title 47 of the CFR, Part 15 §15.407 (a)(3)	RSS-210 (A8.2)	Power Spectral Density	Compliant
Title 47 of the CFR, Part 15 §15.407 (b)(4), (5), (6)	RSS-210 (A9.2)	Undesirable Emissions (15.205/15.209 - General Field Strength Limits (Restricted Bands and Radiated Emission Limits)	Compliant
Title 47 of the CFR, Part 15 §15.407(f)	RSS-102 (4.1)	RF Exposure	Compliant

Table 1. Executive Summary of EMC Part 15.407 Compliance Testing

II. Equipment Configuration

A. Overview

MET Laboratories, Inc. was contracted by Amimon to perform testing on the MAGLAN, under Amimon's purchase order number 35.

This document describes the test setups, test methods, required test equipment, and the test limit criteria used to perform compliance testing of the Amimon MAGLAN.

The results obtained relate only to the item(s) tested.

Model(s) Tested:	MAGLAN	
Model(s) Covered:	MAGLAN	
EUT Specifications:	Primary Power: 5VDC	
	FCC ID: VQSAMNMGIN01	
	Type of Modulations:	BPSK; OFDM
	Equipment Code:	NII
	Peak RF Output Power:	25.73dBm
	EUT Frequency Ranges:	5745-5825MHz
Analysis:	The results obtained relate only to the item(s) tested.	
Environmental Test Conditions:	Temperature: 15-35° C	
	Relative Humidity: 30-60%	
	Barometric Pressure: 860-1060 mbar	
Evaluated by:	Surinder Singh	
Report Date(s):	August 11, 2014	

Table 2. EUT Summary

B. References

CFR 47, Part 15, Subpart B	Electromagnetic Compatibility: Criteria for Radio Frequency Devices
CFR 47, Part 15, Subpart E	Unlicensed National Information Infrastructure Devices (UNII)
RSS-210, Issue 8, Dec. 2010	Low-power Licence-exempt Radiocommunications Devices (All Frequency Bands): Category I Equipment
RSS-GEN, Issue 3, Dec. 2010	General Requirements and Information for the Certification of Radio Apparatus
ICES-003, Issue 5 August 2012	Information Technology Equipment (ITE) — Limits and methods of measurement
ANSI C63.4:2003	Methods and Measurements of Radio-Noise Emissions from Low-Voltage Electrical And Electronic Equipment in the Range of 9 kHz to 40 GHz
ISO/IEC 17025:2005	General Requirements for the Competence of Testing and Calibration Laboratories
ANSI C63.10-2009	American National Standard for Testing Unlicensed Wireless Devices
FCC Document 789033 D02	General Unii Test Procedures New Rules v01

Table 3. References

C. Test Site

All testing was performed at MET Laboratories, Inc., 914 W. Patapsco Ave., Baltimore, MD 21230. All equipment used in making physical determinations is accurate and bears recent traceability to the National Institute of Standards and Technology.

Radiated Emissions measurements were performed in a 3 meter semi-anechoic chamber (equivalent to an Open Area Test Site). In accordance with §2.948(a)(3), a complete site description is contained at MET Laboratories.

D. Description of Test Sample

The MAGLAN video Sink module is designed to be at the receiver end of the WHDI downstream. The MAGLAN receives wireless downstream transmission, demodulates it and regenerates the video, audio and control content transmitted by the WHDI source.

The receiver works at the 5GHz unlicensed band.

The channel bandwidth can be operated at 40MHz and 20 MHz modes.

The MAGLAN board has 5 receiving channels (Multiple-In), and single transmitting channel (Single-Out).

The MAGLAN is a DFS Master device. It is equipped with all features and characteristics required to fully provide CAC and ISM requirements for Radar-Detection.

The MAGLAN board is designed to be integrated with any custom-designed video interface board (e.g. HDMI or DH-SDI video interfaces), to form a complete product with standard video output and wireless capabilities.

The MAGLAN board is independent module, fully performing the wireless functionality of the WHDI video link.

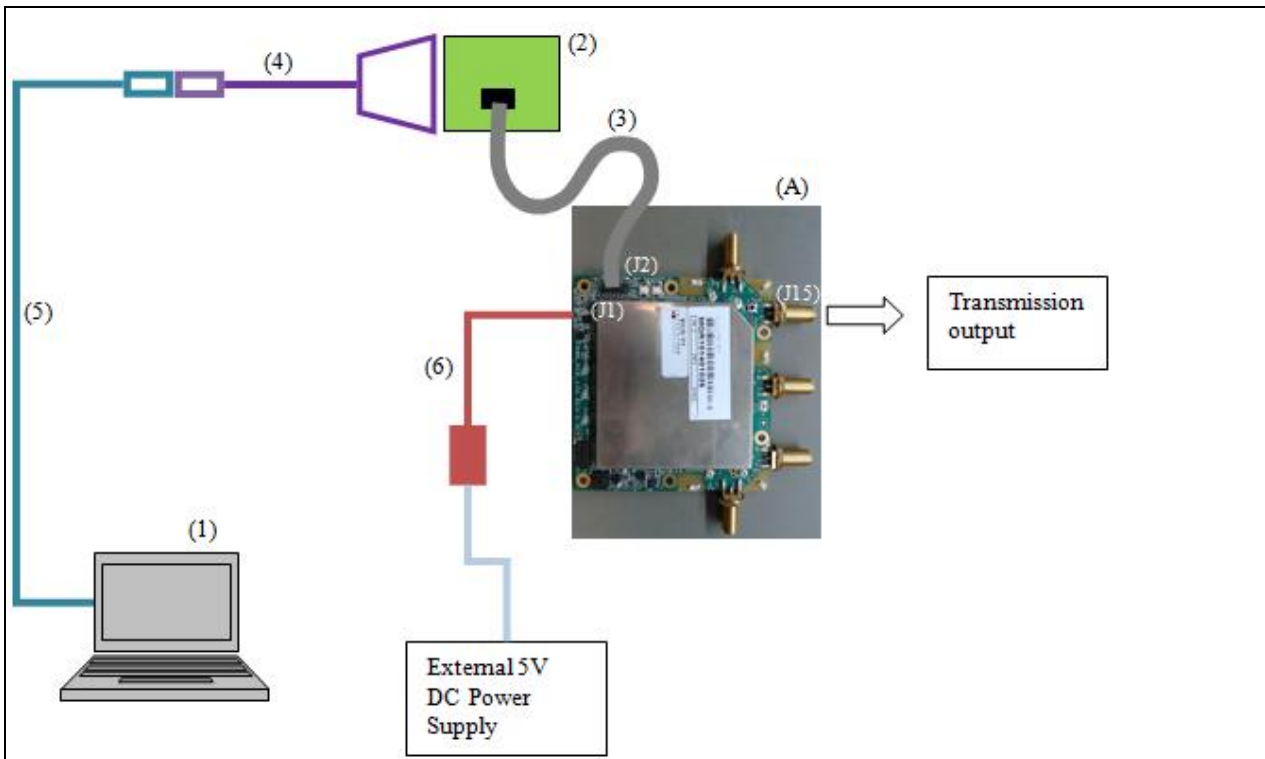

Figure 1. Block Diagram of Test Configuration

E. Equipment Configuration

All cards, racks, etc., incorporated as part of the EUT is included in the following list.

Ref. ID	Slot #	Name / Description
A	N/A	MAGLAN

Table 4. Equipment Configuration

F. Support Equipment

The EUT was set up as outlined in Figure 1, Block Diagram of Test Setup. All cards, racks, etc., incorporated as part of the EUT is included in the following list.

Ref. ID	Name / Description	Manufacturer	Model Number	Customer Supplied Calibration Data
1	PC Laptop	N/A	N/A	N/A
2	Debug Board (APP; MAGLAN)	Amimon	AMN043PCB	N/A
3	Debug Flat Cable	N/A	N/A	N/A
4	USB-to-Serial Converter (APP; MAGLAN)	ATEN	UC-232A	N/A
5	USB cable (optional)	N/A	N/A	N/A
6	MAGLAN supply cord	Amimon	-	N/A

Table 5. Support Equipment

G. Ports and Cabling Information

Ref. ID	Port Name on EUT	Cable Description	Qty.	Length (m)	Shielded (Y/N)	Termination Point
J15	RF TX Port	External Antenna	1	N/A	N/A	UL
J1	5V DC Supply	MAGLAN 5V Power Supply Cord	1	0.1	No	5VDC
J2	APP UART	Debug Flat Cable	1	0.1	No	APP
J3	MAC UART	Debug Flat Cable	1	0.1	No	MAC

Table 6. Ports and Cabling Information

H. Mode of Operation

The MAGLAN board can be set into Test mode, simulating continues normal operating mode.

This mode is enabled by simple GUI provided by AMIMON's 'AppCom' Tool.

The tool enables setting the EUT to Transmit or Receive modes. It controls the center channel frequency, the operating channel bandwidth, and the TX channel power.

A complete description of operation is detailed in 'How to use AppCom Regulation control.doc' file.

I. Method of Monitoring EUT Operation

Slow blinking (on-off once during 1sec) blue LED indicates that board is functioning.

Fast blinking (on-off 3-4 times during 1sec) same LED, means that the board is out of calibration.

When this LED is not blinking this means that board has a certain problem.

Using the SW tool to configure the board, when configuration ended successfully a clear green indication appears, while a red bad indication appears when the desired configuration fails.

J. Modifications

a) Modifications to EUT

No modifications were made to the EUT.

b) Modifications to Test Standard

No modifications were made to the test standard.

K. Disposition of EUT

The test sample including all support equipment submitted to the Electro-Magnetic Compatibility Lab for testing was returned to Amimon upon completion of testing.

III. Electromagnetic Compatibility Criteria for Unintentional Radiators

Electromagnetic Compatibility Criteria

§ 15.107 Conducted Emissions Limits

Test Requirement(s): **15.107 (a)** Except for Class A digital devices, for equipment that is designed to be connected to the public utility (AC) power line, the radio frequency voltage that is conducted back onto the AC power line on any frequency or frequencies within the band 150 kHz to 30 MHz shall not exceed the limits in Table 7. Compliance with this provision shall be based on the measurement of the radio frequency voltage between each power line and ground at the power terminals.

15.107 (b) For a Class A digital device that is designed to be connected to the public utility (AC) power line, the radio frequency voltage that is conducted back onto the AC power line on any frequency or frequencies within the band 150 kHz to 30 MHz shall not exceed the limits in Table 7. Compliance with this provision shall be based on the measurement of the radio frequency voltage between each power line and ground at the power terminals. The lower limit applies at the band edges.

Frequency range (MHz)	Class A Conducted Limits (dB μ V)		*Class B Conducted Limits (dB μ V)	
	Quasi-Peak	Average	Quasi-Peak	Average
* 0.15- 0.45	79	66	66 - 56	56 - 46
0.45 - 0.5	79	66	56	46
0.5 - 30	73	60	60	50

Note 1 — The lower limit shall apply at the transition frequencies.
Note 2 — The limit decreases linearly with the logarithm if the frequency in the range 0.15 MHz to 0.5 MHz.

Table 7. Conducted Limits for Radio Frequency Devices calculated from FCC Part 15 Subsections 15.107(a) (b)

Test Procedures: The EUT was placed on a non-metallic table, 80 cm above the ground plane inside a semi-anechoic chamber. The method of testing, test conditions, and test procedures of ANSI C63.4 were used. The EUT was powered through a 50 Ω /50 μ H LISN. An EMI receiver, connected to the measurement port of the LISN, scanned the frequency range from 150 kHz to 30 MHz in order to find the peak conducted emissions. All peak emissions within 6 dB of the limit were re-measured using a quasi-peak and/or average detector as appropriate.

Test Results: The EUT was compliant with the Class B requirement(s) of this section. Measured emissions were below applicable limits.

Test Engineer(s): Surinder Singh

Test Date(s): 05/05/14

Conducted Emissions - Voltage, AC Power, Phase Line

Frequency (MHz)	Uncorrected Meter Reading (dBuV) QP	Cable Loss (dB)	Corrected Measurement (dBuV) QP	Limit (dBuV) QP	Margin (dB) QP	Uncorrected Meter Reading (dBuV) Avg.	Cable Loss (dB)	Corrected Measurement (dBuV) Avg.	Limit (dBuV) Avg.	Margin (dB) Avg.
0.1725	27.03	0	27.03	79	-51.97	9.903	0	9.903	66	-56.097
0.8864	16.72	0	16.72	73	-56.28	5.569	0	5.569	60	-54.431
3.067	29.27	0	29.27	73	-43.73	18.1	0	18.1	60	-41.9
7.041	29.92	0.17	30.09	73	-42.91	19.15	0.17	19.32	60	-40.68
10.21	27.48	0.17	27.65	73	-45.35	17.95	0.17	18.12	60	-41.88
27.2	22.84	0.17	23.01	73	-49.99	15.35	0.17	15.52	60	-44.48

Table 8. Conducted Emissions - Voltage, AC Power, Phase Line

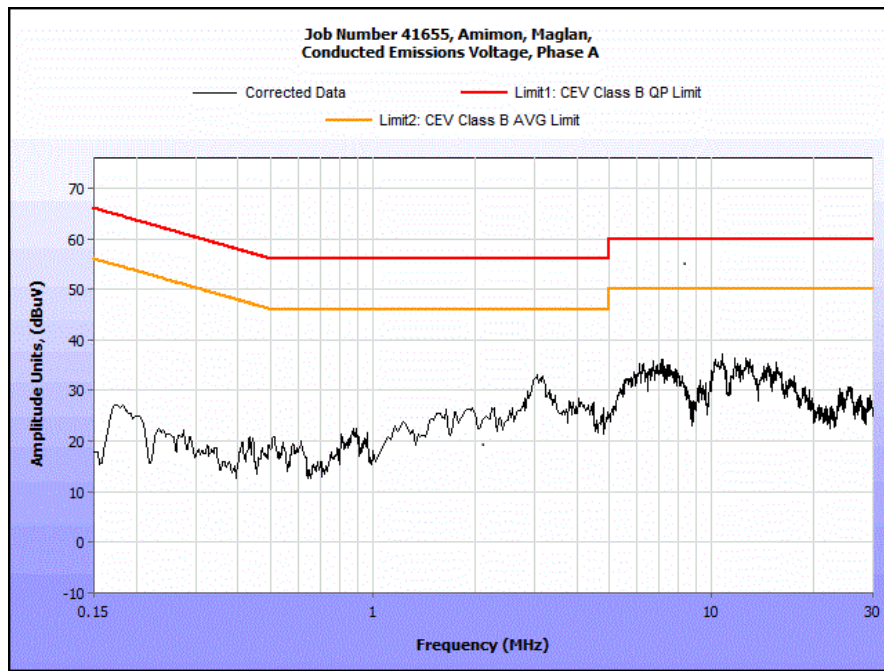

Plot 1. Conducted Emissions, Phase Line Plot

Conducted Emissions - Voltage, AC Power, Neutral Line

Frequency (MHz)	Uncorrected Meter Reading (dBuV) QP	Cable Loss (dB)	Corrected Measurement (dBuV) QP	Limit (dBuV) QP	Margin (dB) QP	Uncorrected Meter Reading (dBuV) Avg.	Cable Loss (dB)	Corrected Measurement (dBuV) Avg.	Limit (dBuV) Avg.	Margin (dB) Avg.
0.1733	21.25	0	21.25	79	-57.75	11.03	0	11.03	66	-54.97
0.531	18.03	0	18.03	73	-54.97	6.903	0	6.903	60	-53.097
0.8852	20.02	0	20.02	73	-52.98	9.722	0	9.722	60	-50.278
3.05	32.27	0	32.27	73	-40.73	21.57	0	21.57	60	-38.43
7.812	33.48	0.17	33.65	73	-39.35	25.33	0.17	25.5	60	-34.5
29.34	26.78	0.28	27.06	73	-45.94	20.9	0.28	21.18	60	-38.82

Table 9. Conducted Emissions - Voltage, AC Power, Neutral Line

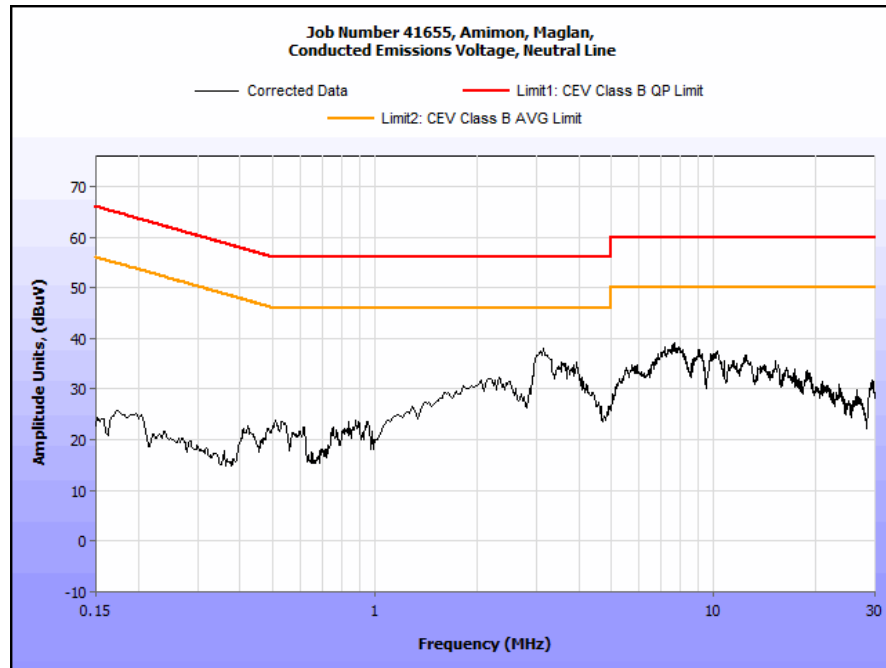

Plot 2. Conducted Emissions, Neutral Line Plot

Radiated Emission Limits

§ 15.109 Radiated Emissions Limits

Test Requirement(s): **15.109 (a)** Except for Class A digital devices, the field strength of radiated emissions from unintentional radiators at a distance of 3 meters shall not exceed the Class B limits expressed in Table 10.

15.109 (b) The field strength of radiated emissions from a Class A digital device, as determined at a distance of 10 meters, shall not exceed the Class A limits expressed in Table 10.

Frequency (MHz)	Field Strength (dB μ V/m)	
	§15.109 (b), Class A Limit (dB μ V) @ 10m	§15.109 (a), Class B Limit (dB μ V) @ 3m
30 - 88	39.00	40.00
88 - 216	43.50	43.50
216 - 960	46.40	46.00
Above 960	49.50	54.00

Table 10. Radiated Emissions Limits calculated from FCC Part 15, §15.109 (a) (b)

Test Procedures: The EUT was placed on a non-metallic table, 80 cm above the ground plane inside a semi-anechoic chamber. The method of testing and test conditions of ANSI C63.4 were used. An antenna was located 3 m from the EUT on an adjustable mast. A pre-scan was first performed in order to find prominent radiated emissions. For final emissions measurements at each frequency of interest, the EUT was rotated and the antenna height was varied between 1 m and 4 m in order to maximize the emission. Measurements in both horizontal and vertical polarities were made and the data was recorded. Unless otherwise specified, measurements were made using a quasi-peak detector with a 120 kHz bandwidth.

Test Results: The EUT was compliant with the Class B requirement(s) of this section. Measured emissions were below applicable limits.

Test Engineer(s): Surinder Singh

Test Date(s): 04/23/14 – 05/05/14

Radiated Emissions Limits Test Results, Class B

Frequency (MHz)	EUT Azimuth (Degrees)	Antenna Polarity (H/V)	Antenna HEIGHT (m)	Uncorrected Amplitude (dBuV)	Antenna Correction Factor (dB) (+)	Cable Loss (dB) (+)	Distance Correction Factor (dB) (-)	Corrected Amplitude (dBuV/m)	Limit (dBuV/m)	Margin (dB)
49.779559	2	H	1.59	9.20	8.77	0.48	0.00	18.45	40.00	-21.55
49.779559	11	V	1.61	28.84	8.77	0.48	0.00	38.09	40.00	-1.91
156.01202	22	H	1.57	9.73	12.90	0.95	0.00	23.58	43.50	-19.92
156.01202	12	V	1.55	15.29	12.90	0.95	0.00	29.14	43.50	-14.36
328.33292	24	H	1.57	4.94	14.77	1.29	0.00	21.00	46.00	-25.00
328.33292	35	V	1.60	7.78	14.77	1.29	0.00	23.84	46.00	-22.16
668.25777	35	H	1.53	11.00	20.57	2.14	0.00	33.71	46.00	-12.29
668.25777	36	V	1.60	8.30	20.57	2.14	0.00	31.01	46.00	-14.99
742.50251	23	H	1.49	7.84	21.20	2.38	0.00	31.42	46.00	-14.58
742.50251	20	V	1.43	6.58	21.20	2.38	0.00	30.16	46.00	-15.84

Table 11. Radiated Emissions Limits, Test Results, 30 MHz – 1 GHz

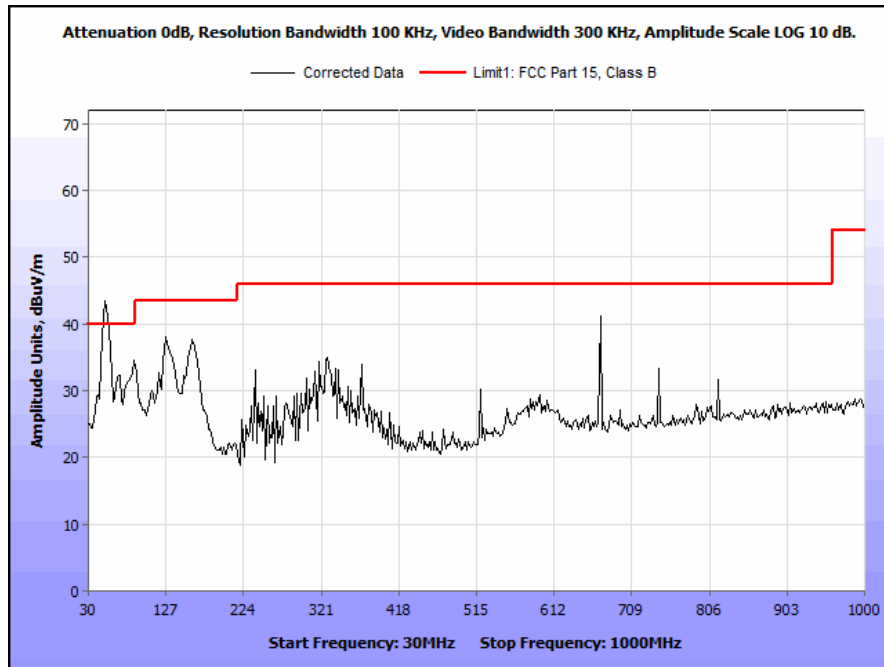

Plot 3. Radiated Emissions, 30 MHz - 1 GHz

Frequency (MHz)	EUT Azimuth (Degrees)	Antenna Polarity (H/V)	Antenna HEIGHT (m)	Uncorrected Amplitude (dBuV)	Antenna Correction Factor (dB) (+)	Cable Loss (dB) (+)	Distance Correction Factor (dB) (-)	Corrected Amplitude (dBuV/m)	Limit (dBuV/m)	Margin (dB)
1.046	34	H	1.08	8.478	24.31	5.86	0	38.64	54	-15.36
1.046	45	V	1.03	7.567	24.34	5.87	0	37.78	54	-16.22
1.256	122	H	1.12	7.673	25.57	6.08	0	33.24	54	-20.76
1.256	155	V	1.15	7.225	25.71	6.09	0	39.03	54	-14.97
1.483	132	H	1.02	8.382	25.62	7.48	0	41.48	54	-12.52
1.483	167	V	1.09	8.382	25.77	7.50	0	41.65	54	-12.35
1.645	278	H	1.05	6.378	26.09	8.05	0	40.52	54	-13.48
1.645	219	V	1.05	7.249	26.19	8.18	0	41.62	54	-12.38
1.825	356	H	1.08	7.836	27.46	7.83	0	43.13	54	-10.87
1.825	14	V	1.05	8.375	27.50	7.85	0	43.73	54	-10.27
1.948	94	H	1.12	7.372	28.13	8.24	0	43.74	54	-10.26
1.948	325	V	1.12	7.148	28.02	8.26	0	43.43	54	-10.58

Table 12. Radiated Emissions Limits, Test Results, 1 GHz – 2 GHz

IV. Electromagnetic Compatibility Criteria for Intentional Radiators

Electromagnetic Compatibility Criteria for Intentional Radiators

§ 15.203 Antenna Requirement

Test Requirement: § 15.203: An intentional radiator shall be designed to ensure that no antenna other than that furnished by the responsible party shall be used with the device. The use of a permanently attached antenna or of an antenna that uses a unique coupling to the intentional radiator shall be considered sufficient to comply with the provisions of this section. The manufacturer may design the unit so that a broken antenna can be replaced by the user, but the use of a standard antenna jack or electrical connector is prohibited.

The structure and application of the EUT were analyzed to determine compliance with Section 15.203 of the Rules. Section 15.203 states that the subject device must meet at least one of the following criteria:

- a.) Antenna must be permanently attached to the unit.
- b.) Antenna must use a unique type of connector to attach to the EUT.
- c.) Unit must be professionally installed. Installer shall be responsible for verifying that the correct antenna is employed with the unit.

Results: The EUT as tested is Not applicable to the criteria of §15.203. Depending on configuration, the EUT either has an integrated antenna or an antenna with a unique connector (reverse polarity SMA).

Test Engineer(s): Surinder Singh

Test Date(s): 05/13/14

Electromagnetic Compatibility Criteria for Intentional Radiators

§ 15.207 Conducted Emissions Limits

Test Requirement(s): § 15.207 (a): For an intentional radiator that is designed to be connected to the public utility (AC) power line, the radio frequency voltage that is conducted back onto the AC power line on any frequency or frequencies, within the band 150 kHz to 30MHz, shall not exceed the limits in the following table, as measured using a 50 μ H/50 Σ line impedance stabilization network (LISN). Compliance with the provisions of this paragraph shall be based on the measurement of the radio frequency voltage between each power line and ground at the power terminal. The lower limit applies at the boundary between the frequency ranges.

Frequency range (MHz)	§ 15.207(a), Conducted Limit (dB μ V)	
	Quasi-Peak	Average
* 0.15- 0.45	66 - 56	56 - 46
0.45 - 0.5	56	46
0.5 - 30	60	50

Table 13. Conducted Limits for Intentional Radiators from FCC Part 15 § 15.207(a)

Test Procedure: The EUT was placed on a 0.8 m-high wooden table inside a screen room. The EUT was situated such that the back of the EUT was 0.4 m from one wall of the vertical ground plane, and the remaining sides of the EUT were no closer than 0.8 m from any other conductive surface. The EUT was powered from a 50 Ω /50 μ H Line Impedance Stabilization Network (LISN). The EMC receiver scanned the frequency range from 150 kHz to 30 MHz. Conducted Emissions measurements were made in accordance with *ANSI C63.4-2003 "Methods and Measurements of Radio-Noise Emissions from Low-Voltage Electrical and Electronic Equipment in the Range of 9kHz to 40 GHz"*. The measurements were performed over the frequency range of 0.15 MHz to 30 MHz using a 50 Ω /50 μ H LISN as the input transducer to an EMC/field intensity meter. For the purpose of this testing, the transmitter was turned on. Scans were performed with the transmitter on.

Test Results: The EUT was compliant with this requirement.

Test Engineer(s): Surinder Singh

Test Date(s): 05/13/14

15.207(a) Conducted Emissions Test Results

Frequency (MHz)	Uncorrected Meter Reading (dBuV) QP	Cable Loss (dB)	Corrected Measurement (dBuV) QP	Limit (dBuV) QP	Margin (dB) QP	Uncorrected Meter Reading (dBuV) Avg.	Cable Loss (dB)	Corrected Measurement (dBuV) AVG	Limit (dBuV) AVG	Margin (dB) AVG
0.1829	21.81	0	21.81	79	-57.19	11.4	0	11.4	66	-54.6
0.4862	19.18	0	19.18	79	-59.82	9.912	0	9.912	66	-56.088
2.189	12.36	0	12.36	73	-60.64	8.251	0	8.251	60	-51.749
3.098	34.92	0	34.92	73	-38.08	23.63	0	23.63	60	-36.37
7.412	34.84	0.17	35.01	73	-37.99	26.04	0.17	26.21	60	-33.79
15.24	30.36	0	30.36	73	-42.64	22.37	0	22.37	60	-37.63

Table 14. Conducted Emissions, 15.207(a), Phase Line, Test Results

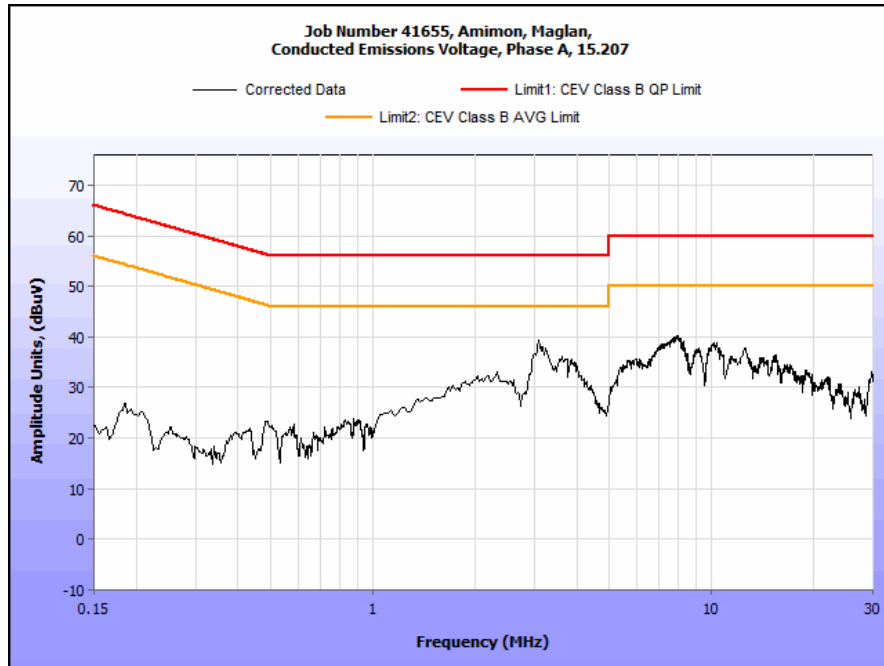

Plot 4. Conducted Emissions, 15.207(a), Phase Line

15.207(a) Conducted Emissions Test Results

Frequency (MHz)	Uncorrected Meter Reading (dBuV) QP	Cable Loss (dB)	Corrected Measurement (dBuV) QP	Limit (dBuV) QP	Margin (dB) QP	Uncorrected Meter Reading (dBuV) Avg.	Cable Loss (dB)	Corrected Measurement (dBuV) AVG	Limit (dBuV) AVG	Margin (dB) AVG
0.1824	20.74	0	20.74	79	-58.26	9.252	0	9.252	66	-56.748
0.503	13.71	0	13.71	73	-59.29	4.176	0	4.176	60	-55.824
3.085	29.53	0	29.53	73	-43.47	17.88	0	17.88	60	-42.12
7.085	30.26	0.17	30.43	73	-42.57	19.8	0.17	19.97	60	-40.03
12.53	30.11	0.12	30.23	73	-42.77	21.44	0.12	21.56	60	-38.44
29.31	23.52	0.27	23.79	73	-49.21	15.48	0.27	15.75	60	-44.25

Table 15. Conducted Emissions, 15.207(a), Neutral Line, Test Results

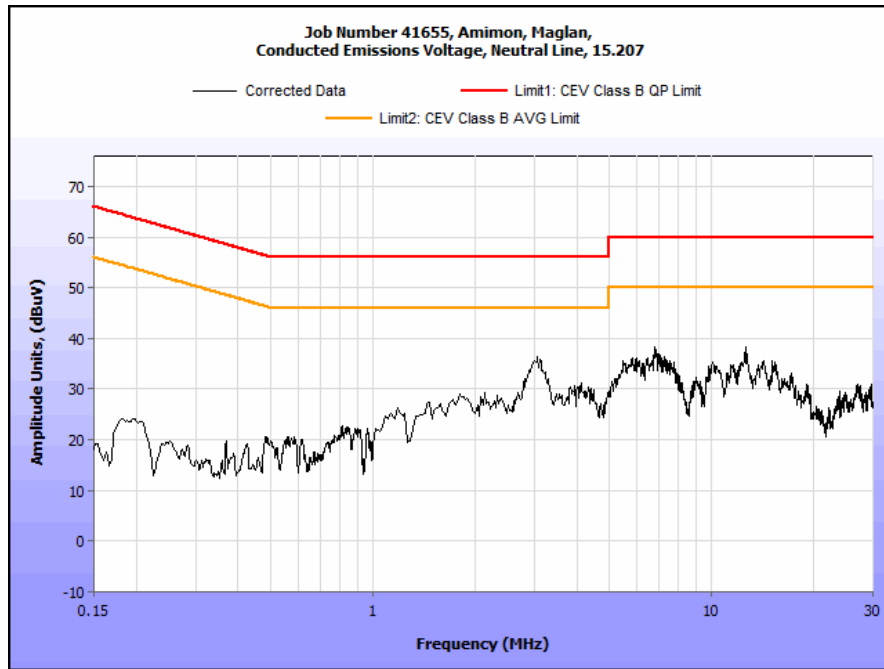

Plot 5. Conducted Emissions, 15.207(a), Neutral Line

Electromagnetic Compatibility Criteria for Intentional Radiators

§ 15.403(c) 26dB Bandwidth

Test Requirements: § 15.403 (i): For purposes of this subpart the emission bandwidth shall be determined by measuring the width of the signal between two points, one below the carrier center frequency and one above the carrier center frequency, that are 26 dB down relative to the maximum level of the modulated carrier. Determination of the emissions bandwidth is based on the use of measurement instrumentation employing a peak detector function with an instrument resolution bandwidth approximately equal to 1.0 percent of the emission bandwidth of the device under measurement.

Test Procedure: The transmitter was set to both operating frequencies at the highest output power and connected to the spectrum analyzer through an attenuator. The bandwidth of the fundamental frequency was measured with the spectrum analyzer using a RBW approximately equal to 1% of the total emission bandwidth, VBW > RBW. The 26 dB Bandwidth was measured and recorded.

Test Results The 26 dB Bandwidth was compliant with the requirements of this section and was determined from the plots on the following pages.

Test Engineer(s): Surinder Singh

Test Date(s): 04/23/14

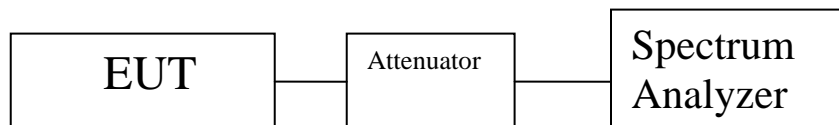

Figure 2. Occupied Bandwidth, Test Setup

Frequency (MHz)	26 dB Bandwidth (MHz)
5745	18.897
5755	38.640
5765	18.988
5785	18.958
5795	38.338
5805	18.935
5825	19.463

Table 16. 26 dB Occupied Bandwidth, Test Results

Frequency (MHz)	99% Bandwidth (MHz)
5745	15.4673
5755	31.1816
5785	15.4980
5795	31.1077
5805	15.5239
5825	15.5012

Table 17. 26 dB Occupied Bandwidth, Test Results

26 dB Occupied Bandwidth

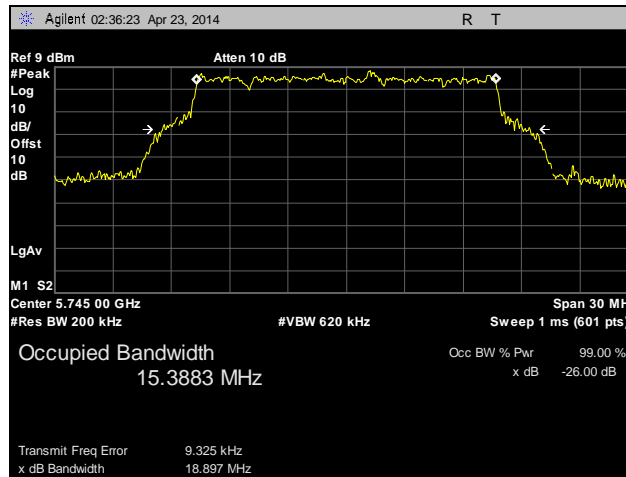

Plot 6. 26 dB Occupied Bandwidth, 5745 MHz

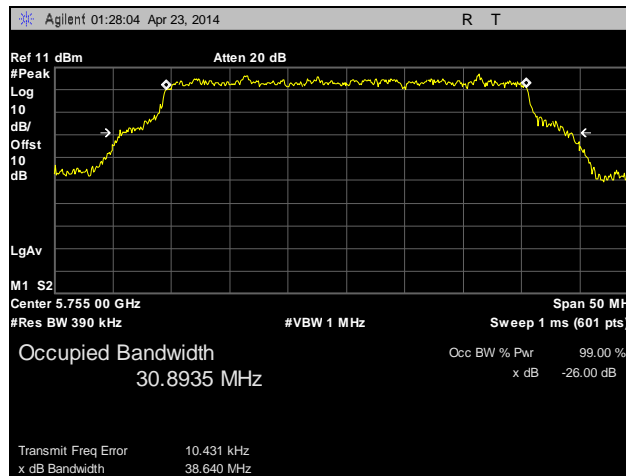

Plot 7. 26 dB Occupied Bandwidth, 5755 MHz

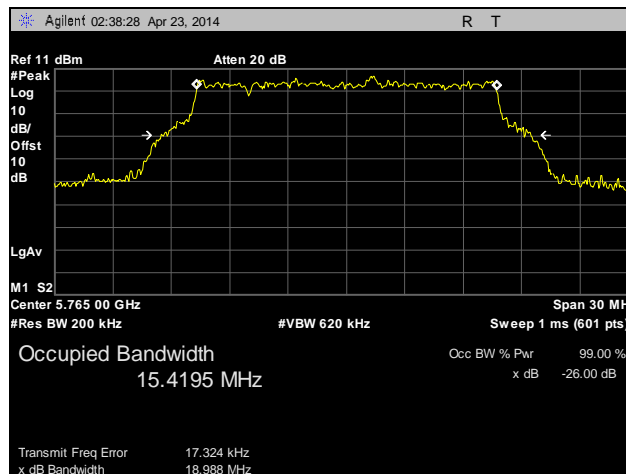

Plot 8. 26 dB Occupied Bandwidth, 5765 MHz

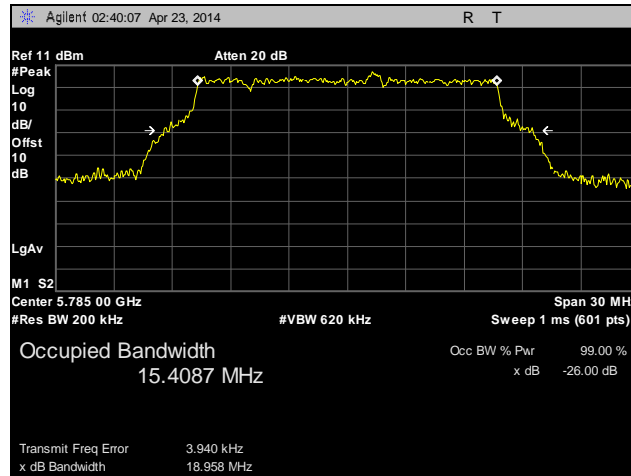

Plot 9. 26 dB Occupied Bandwidth, 5785 MHz

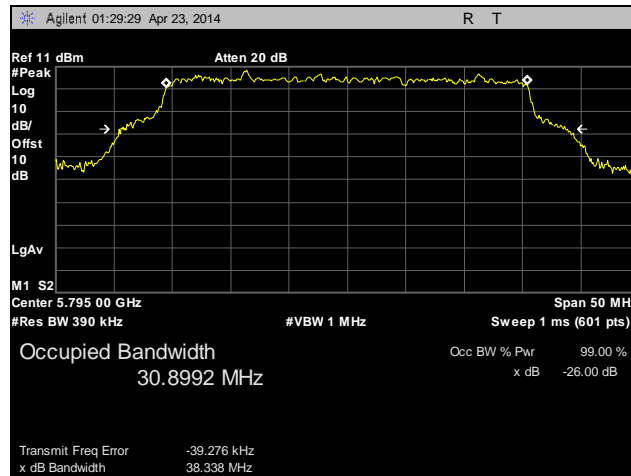

Plot 10. 26 dB Occupied Bandwidth, 5795 MHz

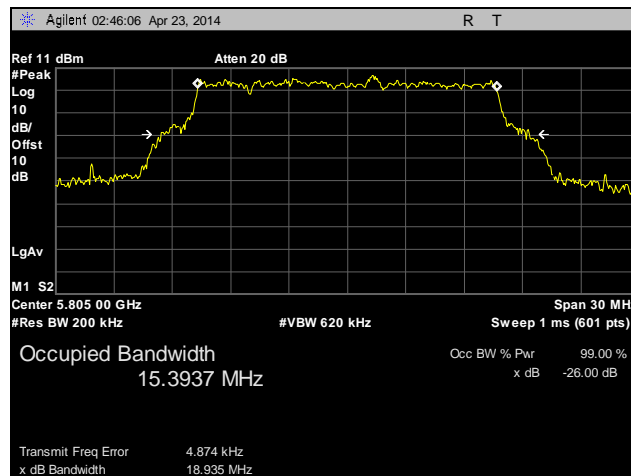

Plot 11. 26 dB Occupied Bandwidth, 5805 MHz

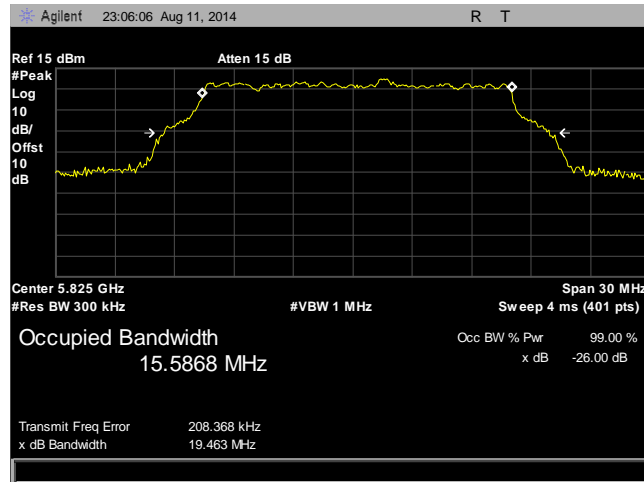

Plot 12. 26 dB Occupied Bandwidth, 5825 MHz

99% Occupied Bandwidth

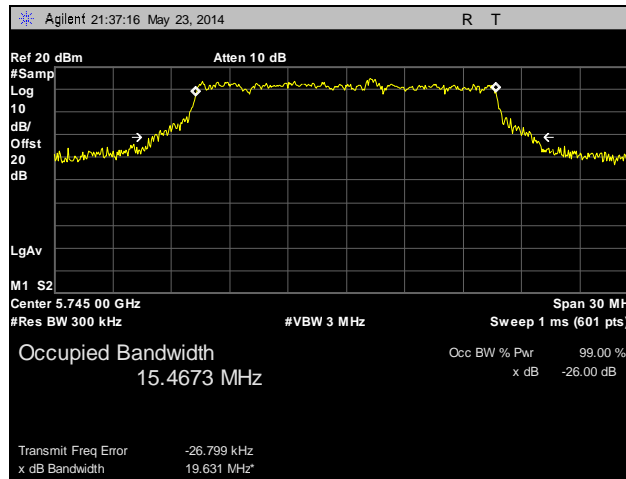

Plot 13. 99% Occupied Bandwidth, 5745 MHz

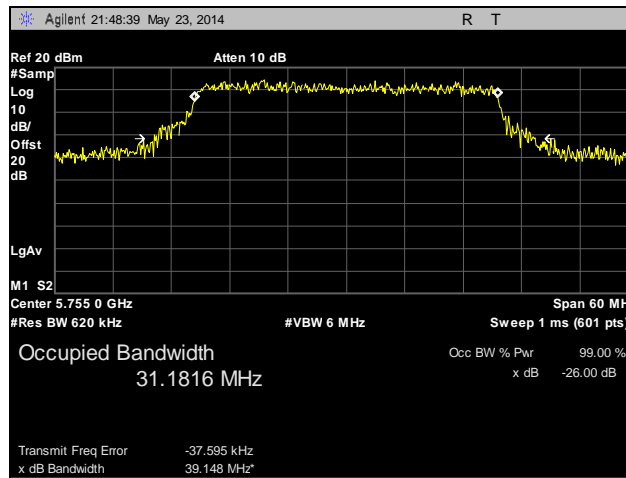

Plot 14. 99% Occupied Bandwidth, 5755 MHz

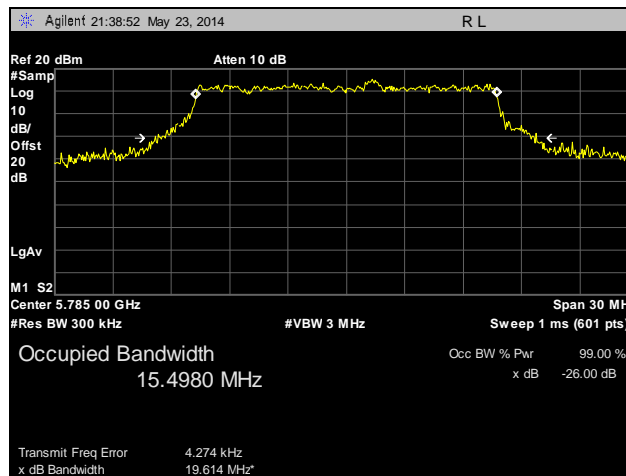

Plot 15. 99% Occupied Bandwidth, 5785 MHz

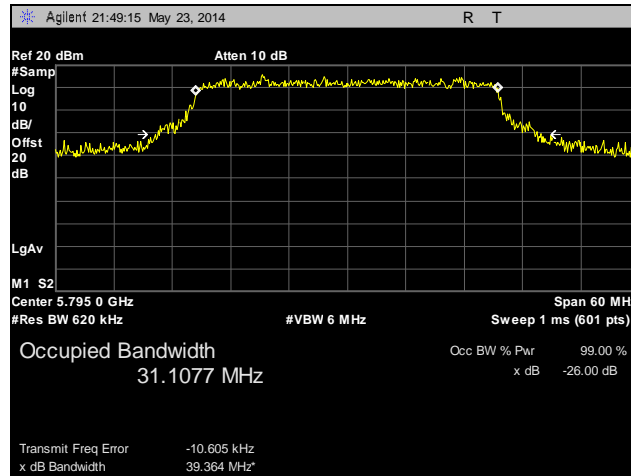

Plot 16. 99% Occupied Bandwidth, 5795 MHz

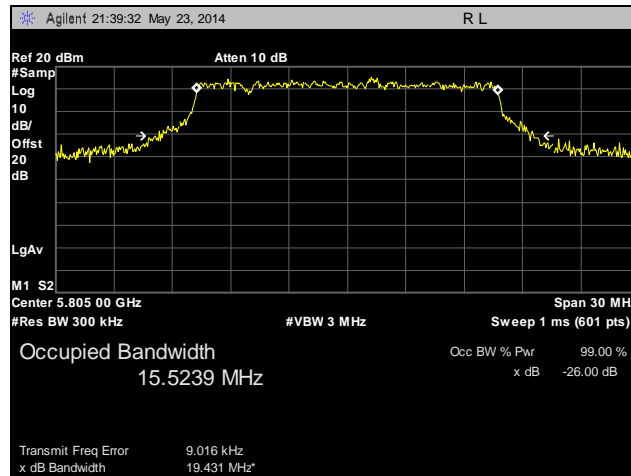

Plot 17. 99% Occupied Bandwidth, 5805 MHz

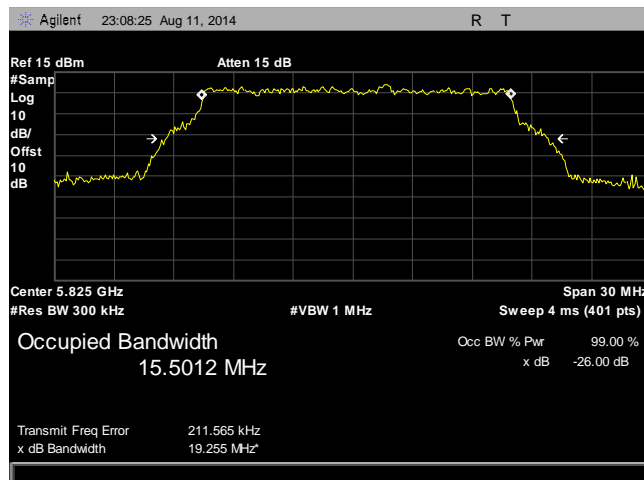

Plot 18. 99% Occupied Bandwidth, 5825 MHz

Electromagnetic Compatibility Criteria for Intentional Radiators

§ 15. 407(a)(3) RF Power Output

Test Requirements: §15.407(a)(3): For the band 5.725-5.85 GHz, the maximum conducted output power over the frequency band of operation shall not exceed 1 W. In addition, the maximum power spectral density shall not exceed 30 dBm in any 500-kHz band. If transmitting antennas of directional gain greater than 6 dBi are used, both the maximum conducted output power and the maximum power spectral density shall be reduced by the amount in dB that the directional gain of the antenna exceeds 6 dBi. However, fixed point-to-point U-NII devices operating in this band may employ transmitting antennas with directional gain greater than 6 dBi without any corresponding reduction in transmitter conducted power. Fixed, point-to-point operations exclude the use of point-to-multipoint systems, omnidirectional applications, and multiple collocated transmitters transmitting the same information. The operator of the U-NII device, or if the equipment is professionally installed, the installer, is responsible for ensuring that systems employing high gain directional antennas are used exclusively for fixed, point-to-point operations.

Test Procedure: The EUT was connected to a spectrum analyzer through an RF cable and an attenuator. The EUT was set to transmit on low, mid, and high channels and the power was measured according to method SA-1 from FCC Publication Number 789033.

Test Results: Equipment was compliant with the Peak Power Output limits of § 15.401(a)(3).

Test Engineer(s): Surinder Singh

Test Date(s): 05/13/14

Frequency (MHz)	Conducted power (dBm)
5745	24.28
5755	25.73
5765	24.17
5785	24.14
5795	25.20
5805	23.33
5825	21.29

Table 18. RF Power Output, Test Results, 5 dBi

Frequency (MHz)	Conducted power (dBm)
5745	18.10
5755	15.21
5765	21.90
5785	21.97
5795	21.94
5805	21.94
5825	21.29

Table 19. RF Power Output, Test Results, 13.5 dBi

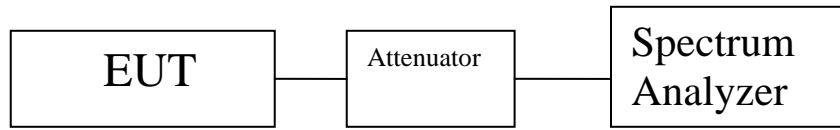
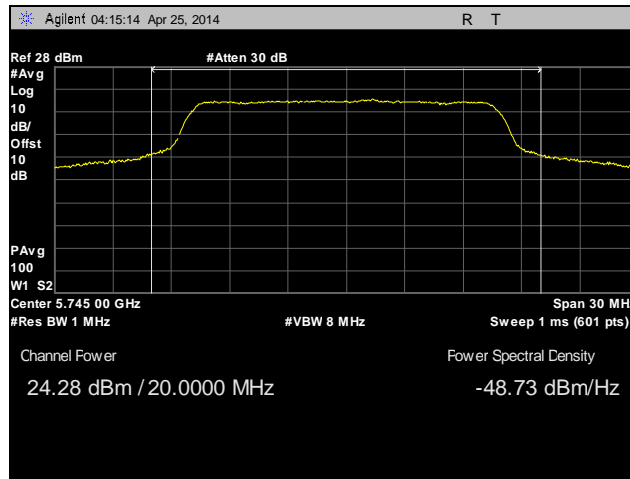
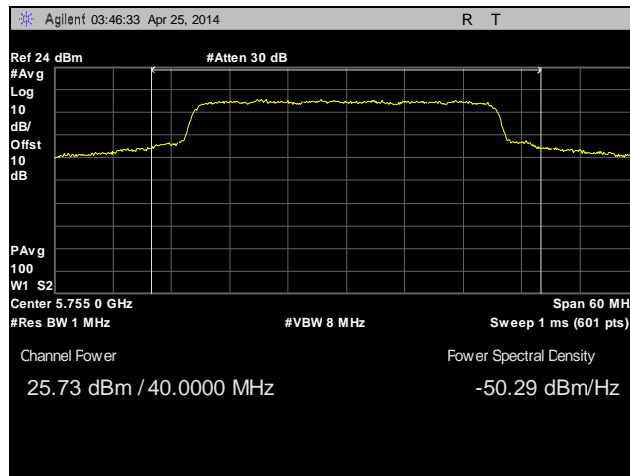

Figure 3. Power Output Test Setup

RF Power Output, 5 dBi



Plot 19. RF Power Output, 5745 MHz, 5 dBi



Plot 20. RF Power Output, 5755 MHz, 5 dBi

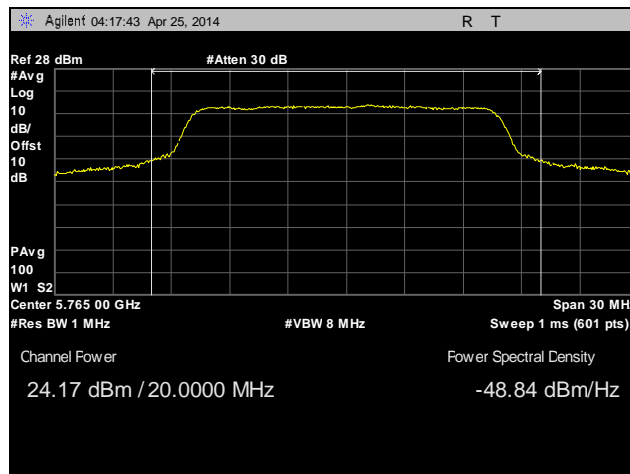

Plot 21. RF Power Output, 5765 MHz, 5 dBi

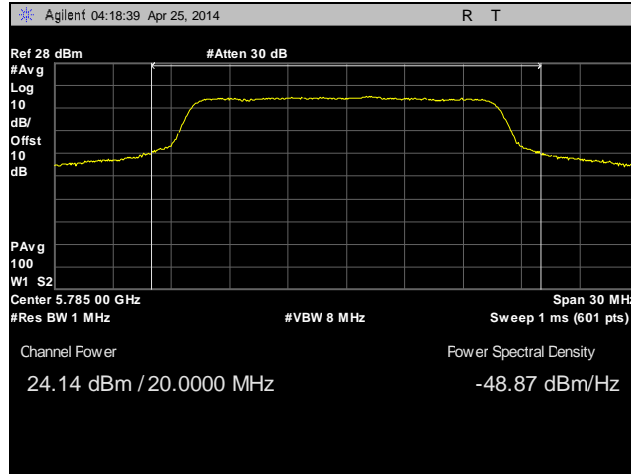

Plot 22. RF Power Output, 5785 MHz, 5 dBi

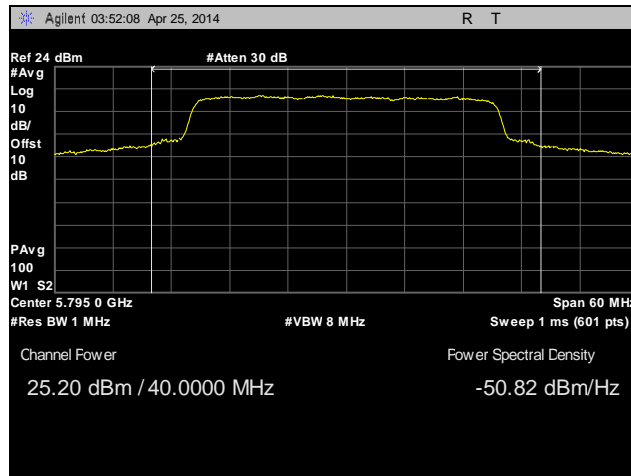

Plot 23. RF Power Output, 5795 MHz, 5 dBi

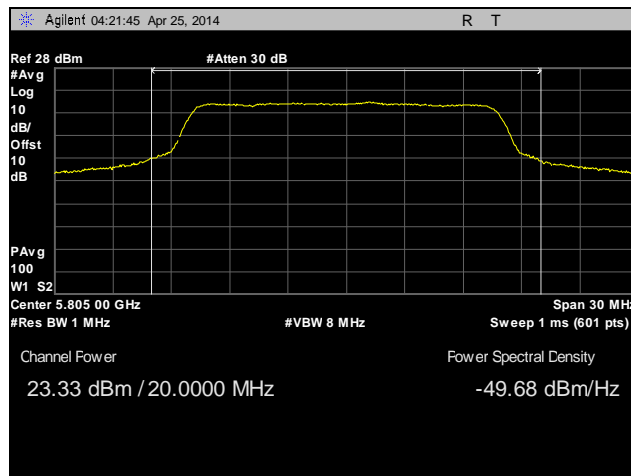

Plot 24. RF Power Output, 5805 MHz, 5 dBi

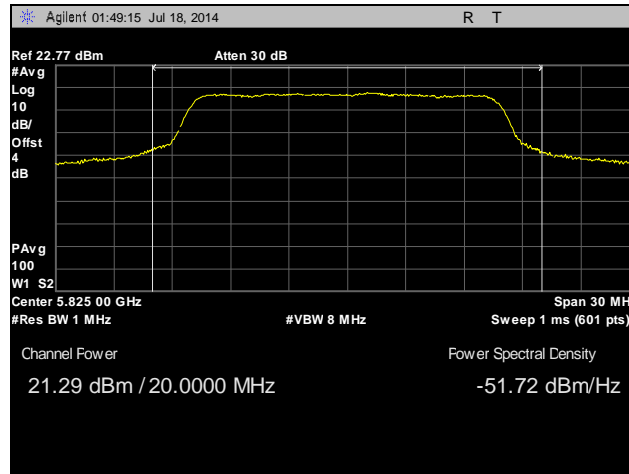

Plot 25. RF Power Output, 5825 MHz, 5 dBi

RF Power Output, 13.5 dBi

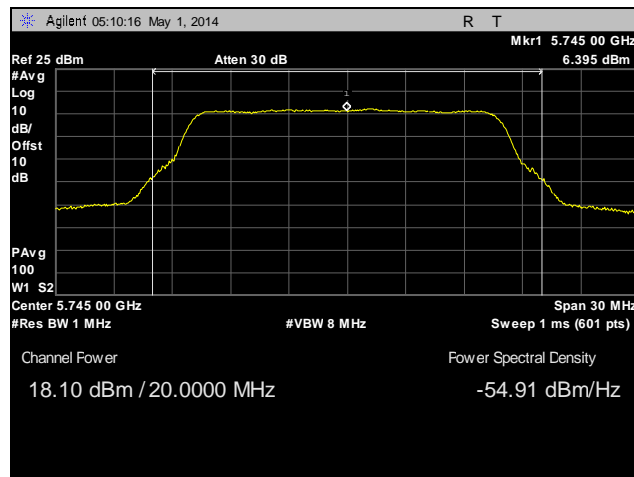

Plot 26. RF Power Output, 5745 MHz, 13.5 dBi

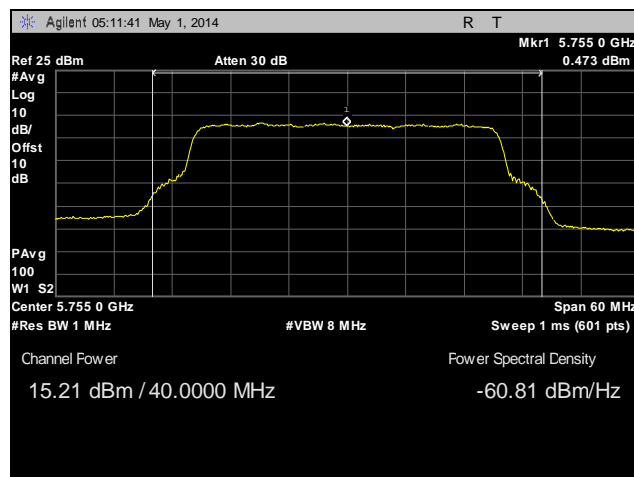

Plot 27. RF Power Output, 5755 MHz, 13.5 dBi

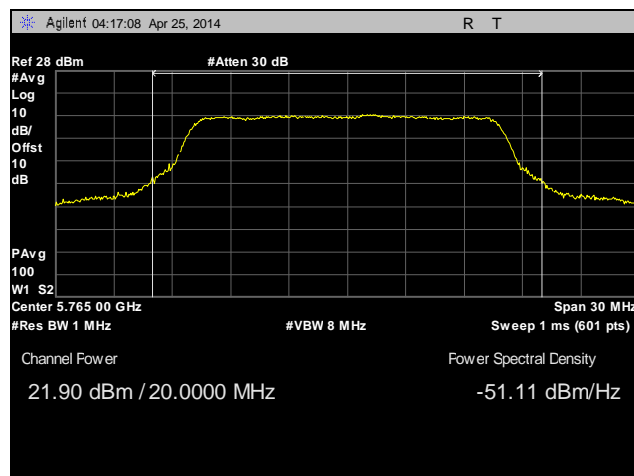

Plot 28. RF Power Output, 5765 MHz, 13.5 dBi

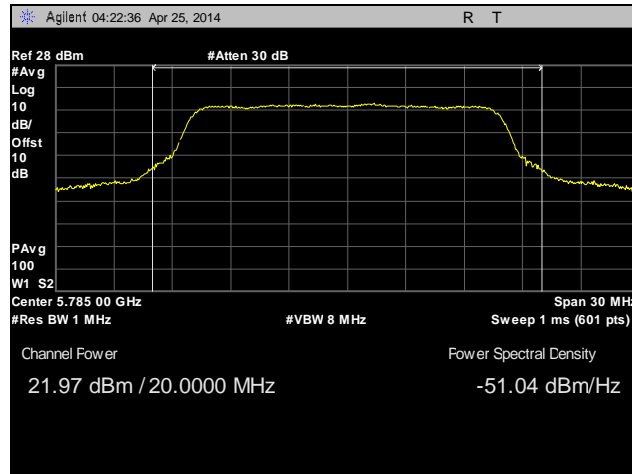

Plot 29. RF Power Output, 5785 MHz, 13.5 dBi

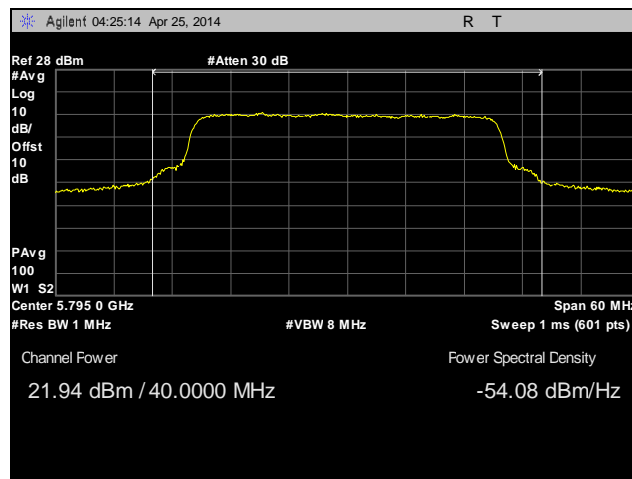

Plot 30. RF Power Output, 5795 MHz, 13.5 dBi

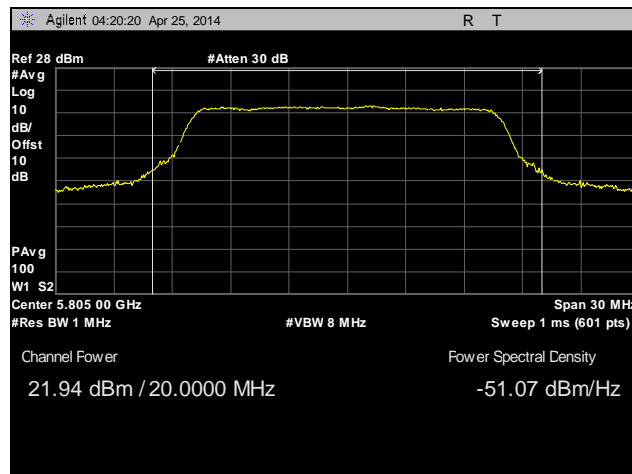

Plot 31. RF Power Output, 5805 MHz, 13.5 dBi

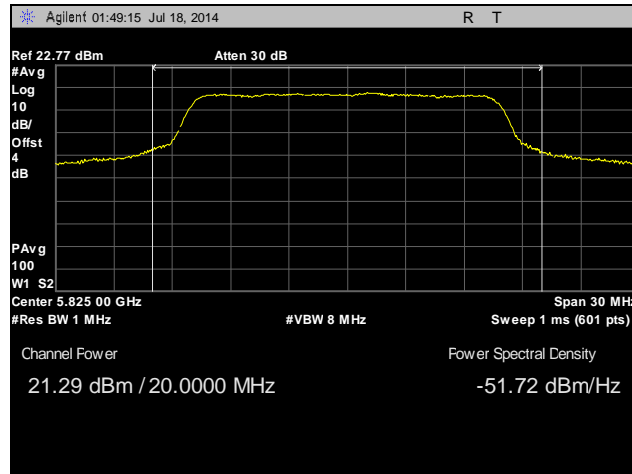

Plot 32. RF Power Output, 5825MHz, 13.5dBi

Electromagnetic Compatibility Criteria for Intentional Radiators

§ 15.407(a)(3) Peak Power Spectral Density

Test Requirements: § 15.407(a)(3): For the band 5.725-5.85 GHz, the maximum conducted output power over the frequency band of operation shall not exceed 1 W. In addition, the maximum power spectral density shall not exceed 30 dBm in any 500-kHz band. If transmitting antennas of directional gain greater than 6 dBi are used, both the maximum conducted output power and the maximum power spectral density shall be reduced by the amount in dB that the directional gain of the antenna exceeds 6 dBi.

Test Procedure: The transmitter was connected directly to a Spectrum Analyzer through an attenuator. The power level was set to the maximum level on the EUT. The RBW was set to 1MHz and the VBW was set to 3MHz to determine the peak within signal bandwidth. Determined peak value was then centered on Spectrum analyzer and channel power measurement was performed per 1MHz. The method of measurement #1 from the FCC Publication Number 789033 was used.

Test Results: Equipment was compliant with the peak power spectral density limits of § 15.407 (a)(3). The peak power spectral density was determined from plots on the following page(s).

Test Engineer(s): Surinder Singh

Test Date(s): 04/30/14

Frequency (MHz)	PSD (dBm)
5745	10.94
5755	9.67
5785	8.87
5795	9.10
5805	10.70
5825	9.42

Table 20. Power Spectral Density, Test Results, 5 dBi

Frequency (MHz)	PSD (dBm)
5745	6.28
5755	5.79
5785	8.35
5795	5.13
5805	7.96
5825	9.42

Table 21. Power Spectral Density, Test Results, 13.5 dBi

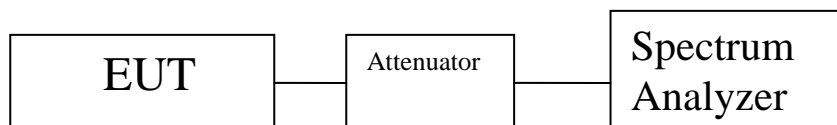
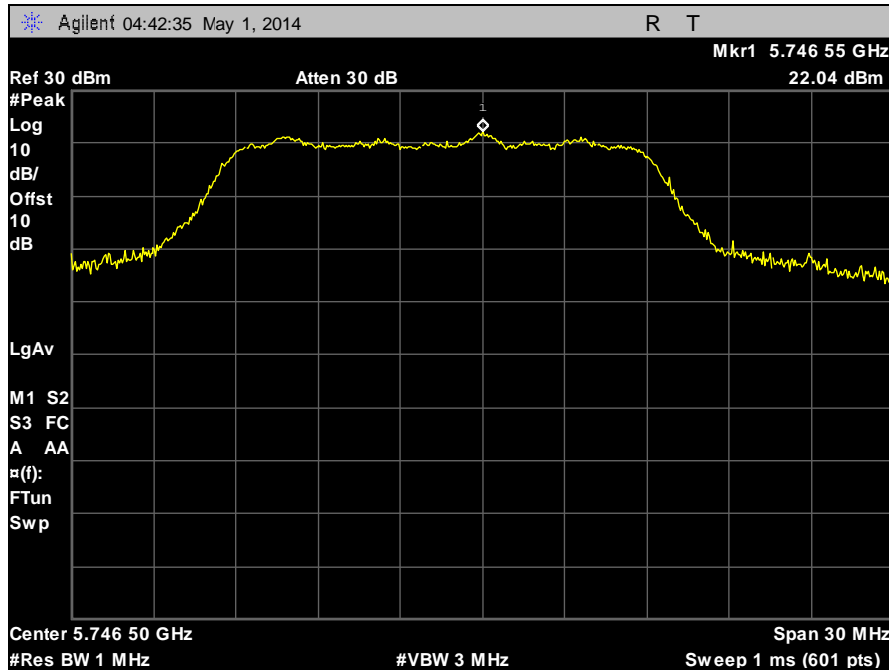
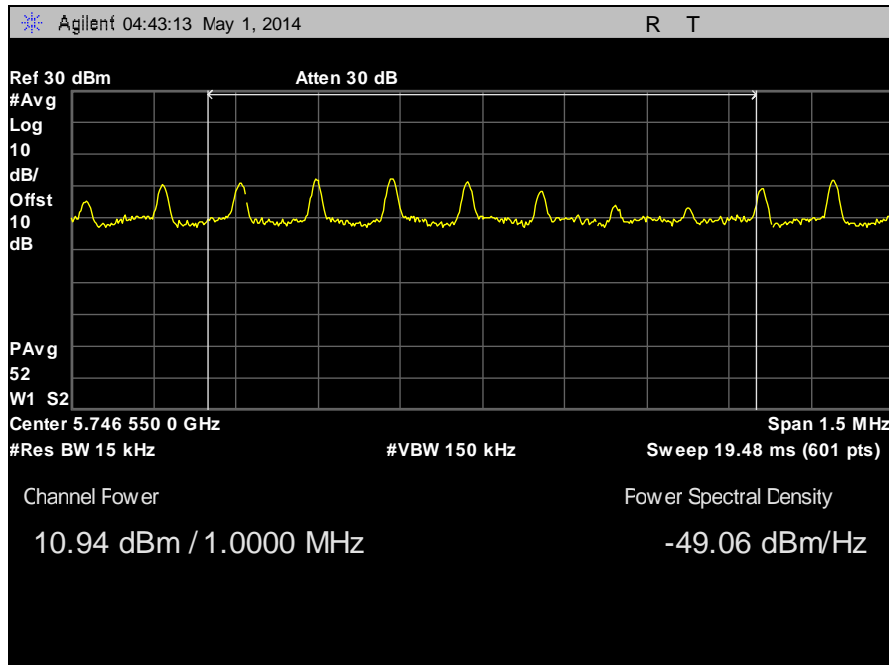

Figure 4. Power Spectral Density Test Setup

Peak Power Spectral Density, 5 dBi



Plot 33. Power Spectral Density Peak Determination, 5745 MHz, 5 dBi



Plot 34. Power Spectral Density, 5745 MHz, 5 dBi

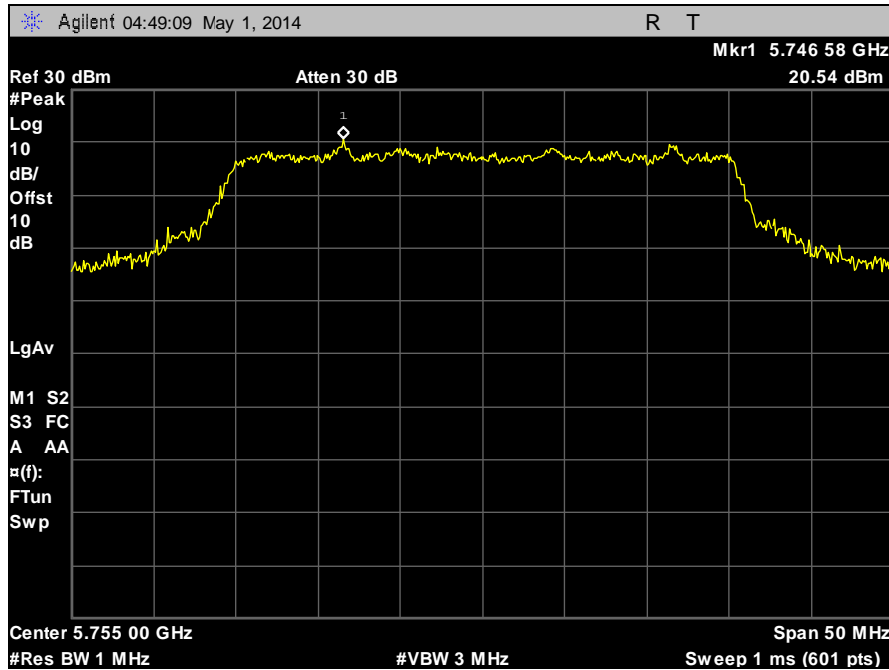

Plot 35. Power Spectral Density Peak Determination, 5755 MHz, 5 dBi

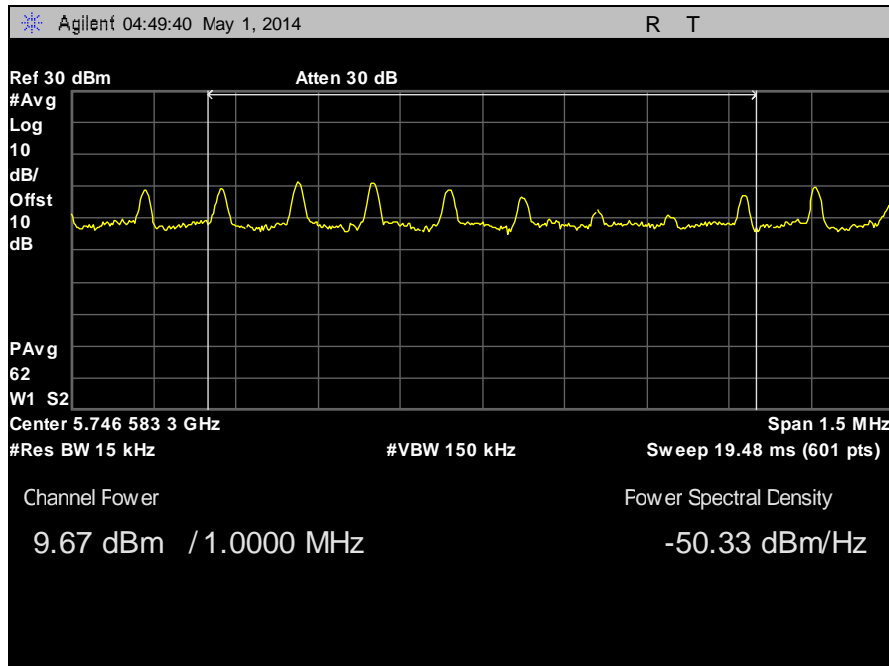

Plot 36. Power Spectral Density, 5755 MHz, 5 dBi

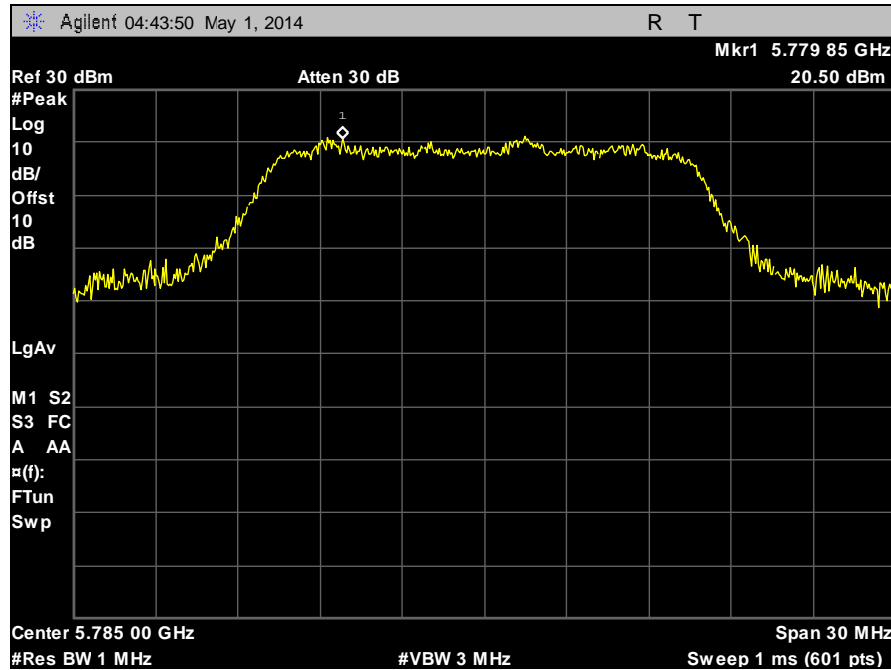

Plot 37. Power Spectral Density Peak Determination, 5785 MHz, 5 dBi

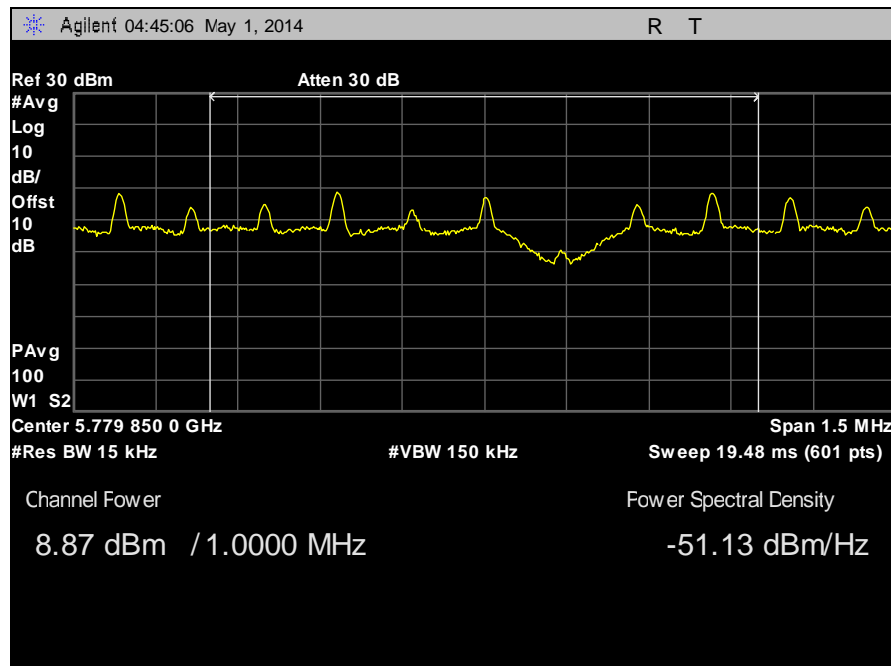

Plot 38. Power Spectral Density, 5785 MHz, 5 dBi

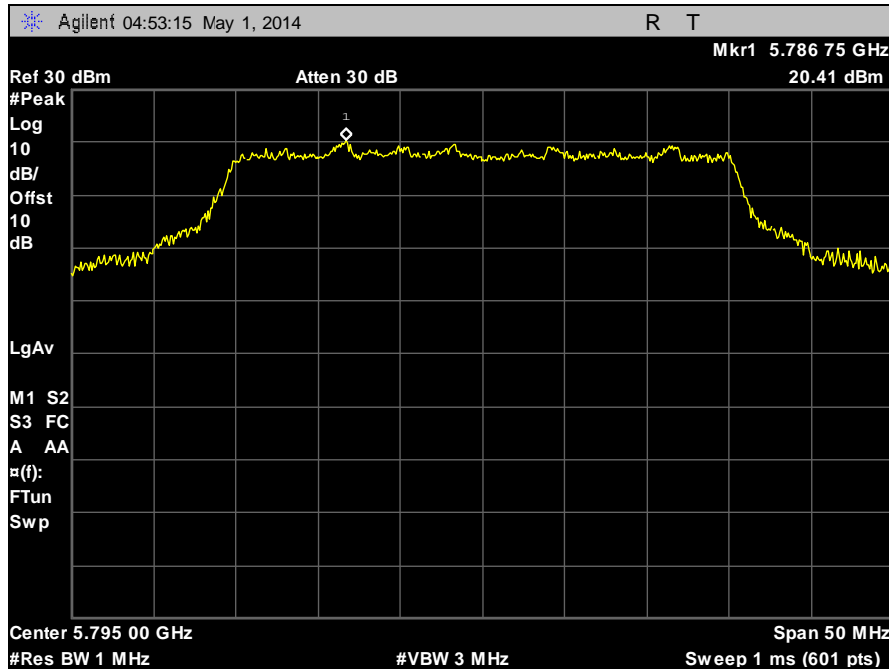

Plot 39. Power Spectral Density Peak Determination, 5795 MHz, 5 dBi

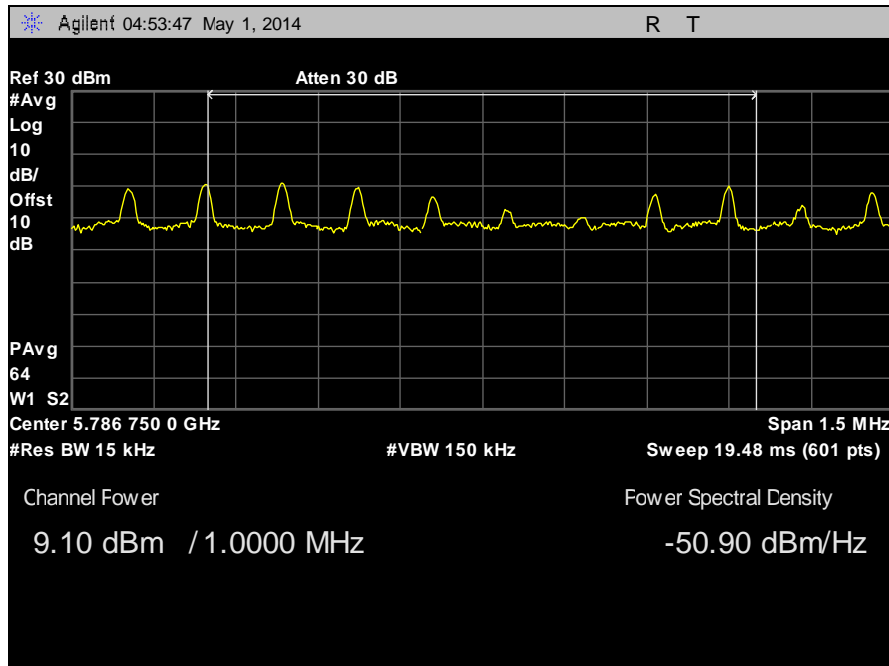

Plot 40. Power Spectral Density, 5795 MHz, 5 dBi

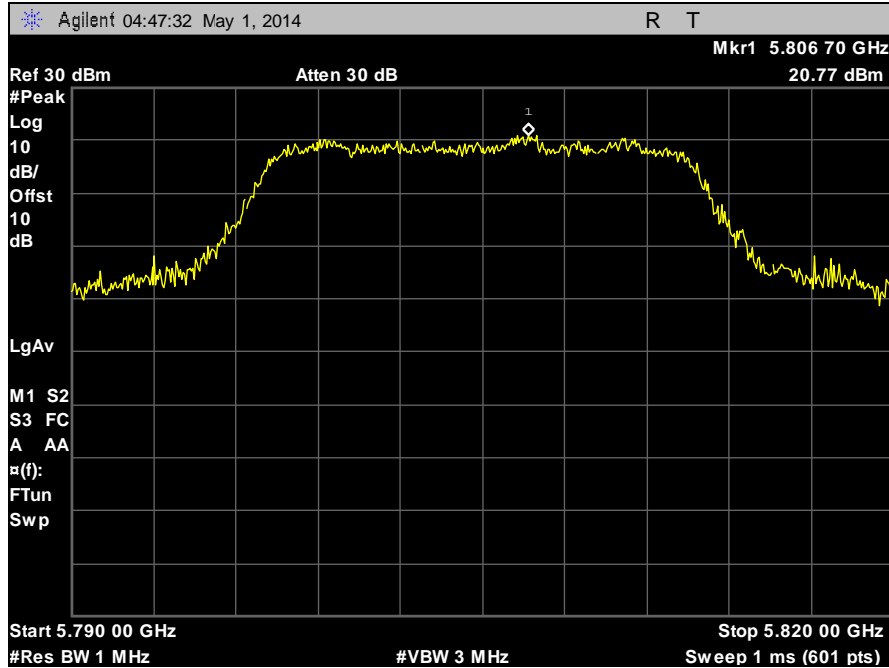

Plot 41. Power Spectral Density Peak Determination, 5805 MHz, 5 dBi

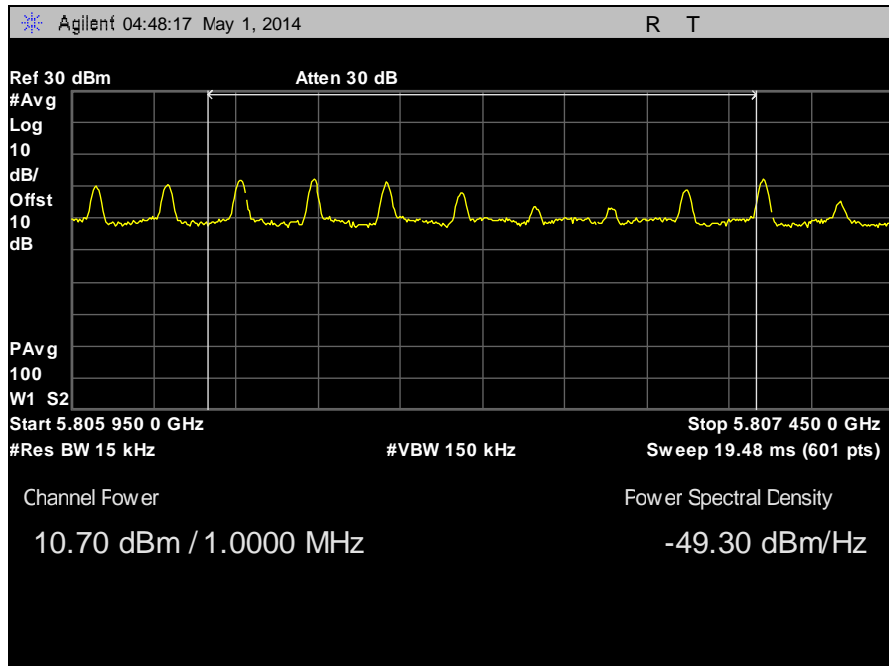

Plot 42. Power Spectral Density, 5805 MHz, 5 dBi

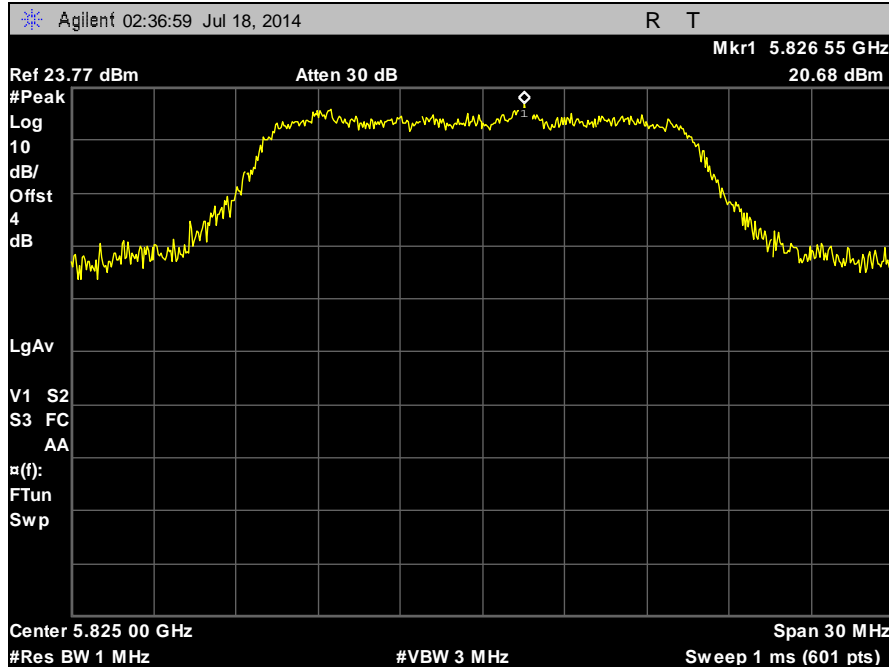

Plot 43. Power Spectral Density Peak Determination, 5825 MHz, 5 dBi

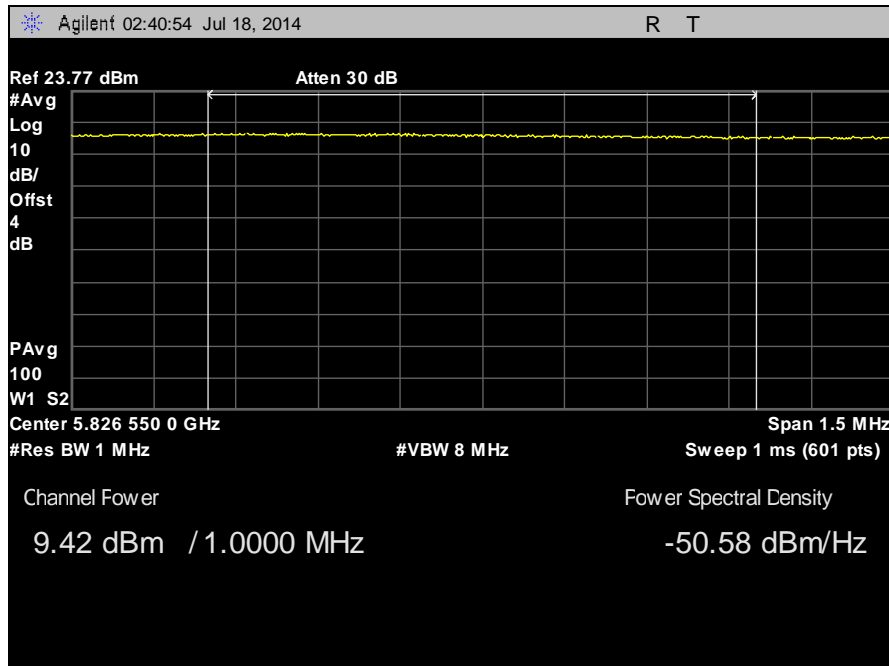

Plot 44. Power Spectral Density, 5825 MHz, 5 dBi

Peak Power Spectral Density, 13.5 dBi

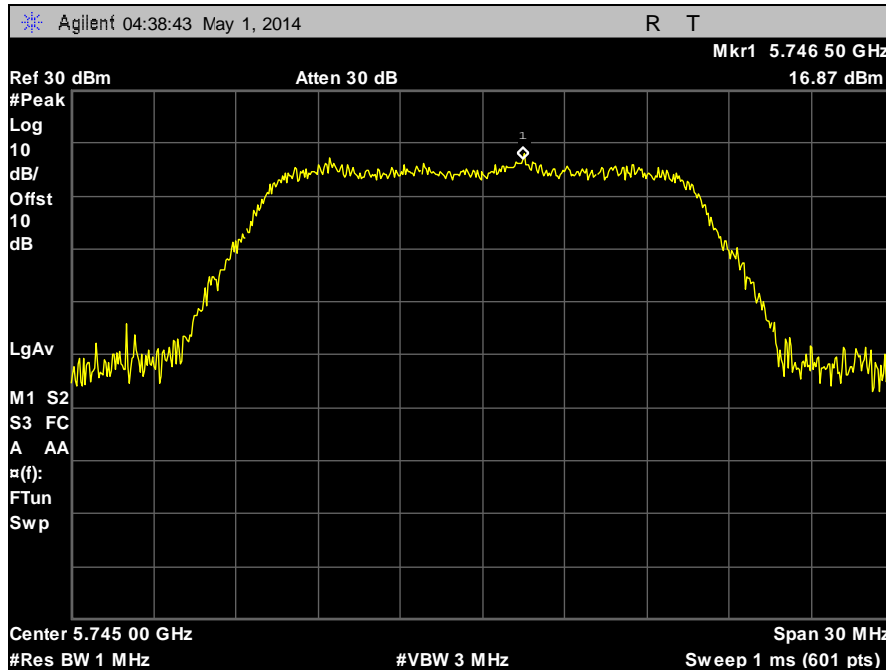

Plot 45. Power Spectral Density Determination, 5745 MHz, 13.5 dBi

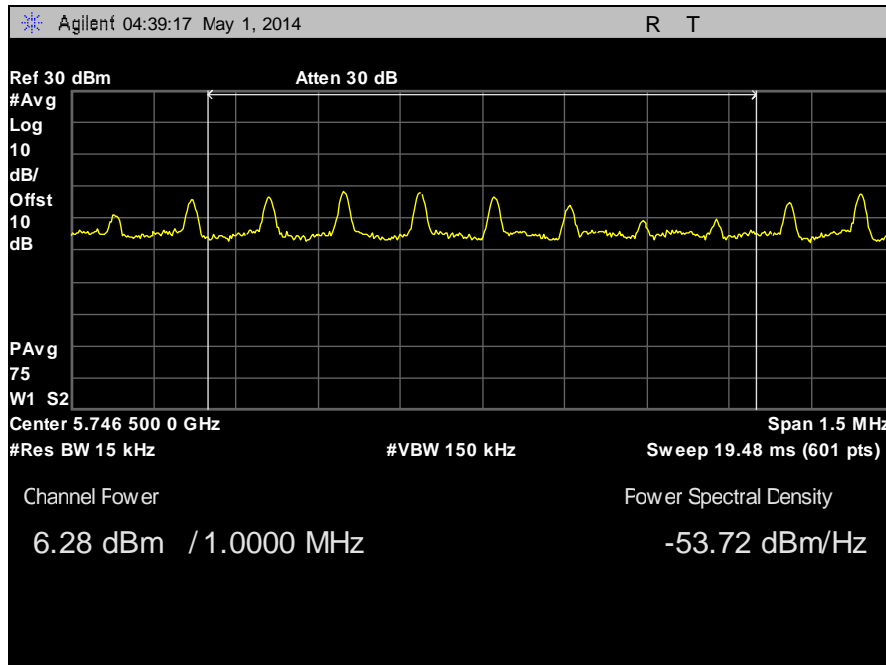

Plot 46. Power Spectral Density, 5745 MHz, 13.5 dBi

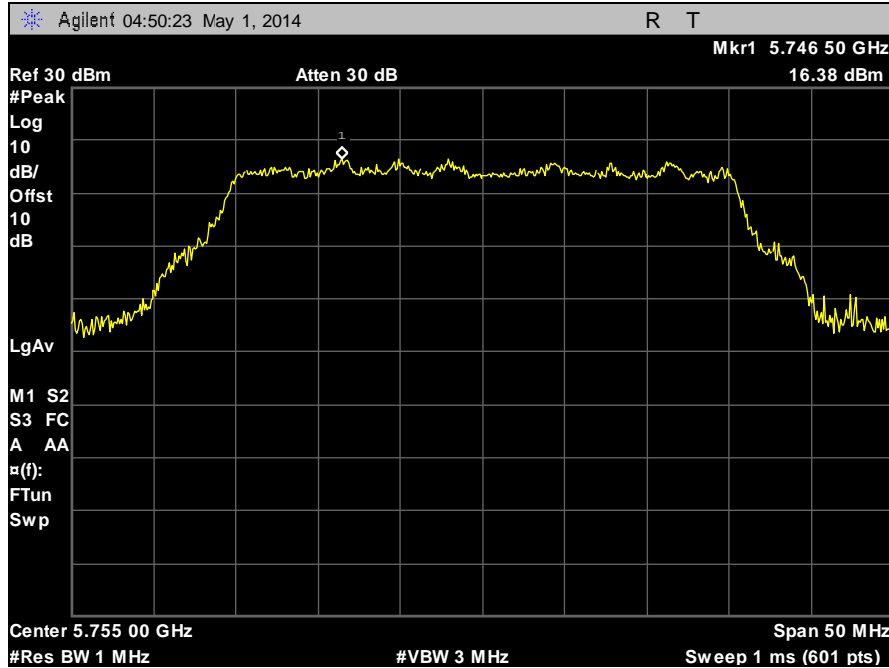

Plot 47. Power Spectral Density Determination, 5755 MHz, 13.5 dBi

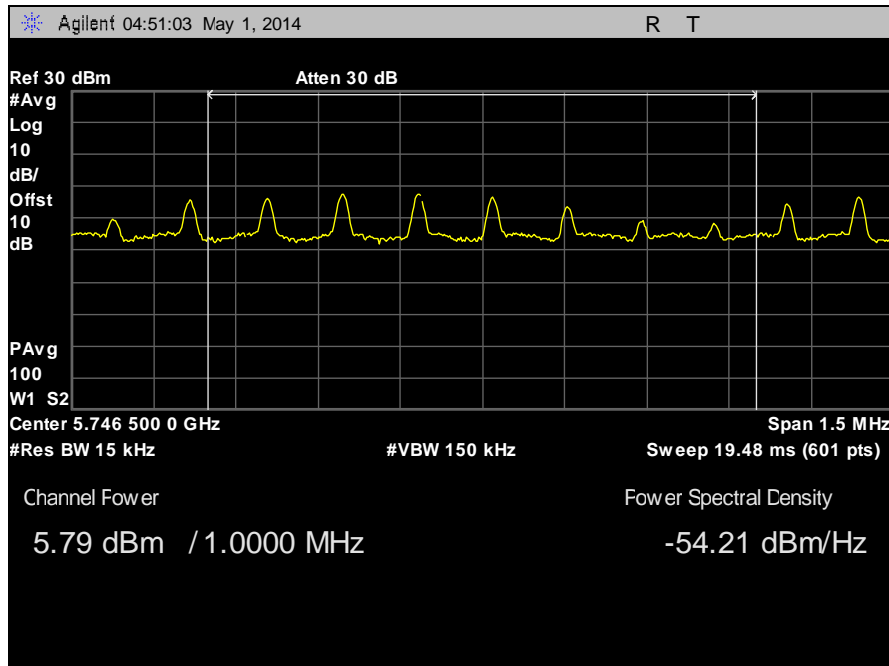

Plot 48. Power Spectral Density, 5755 MHz, 13.5 dBi

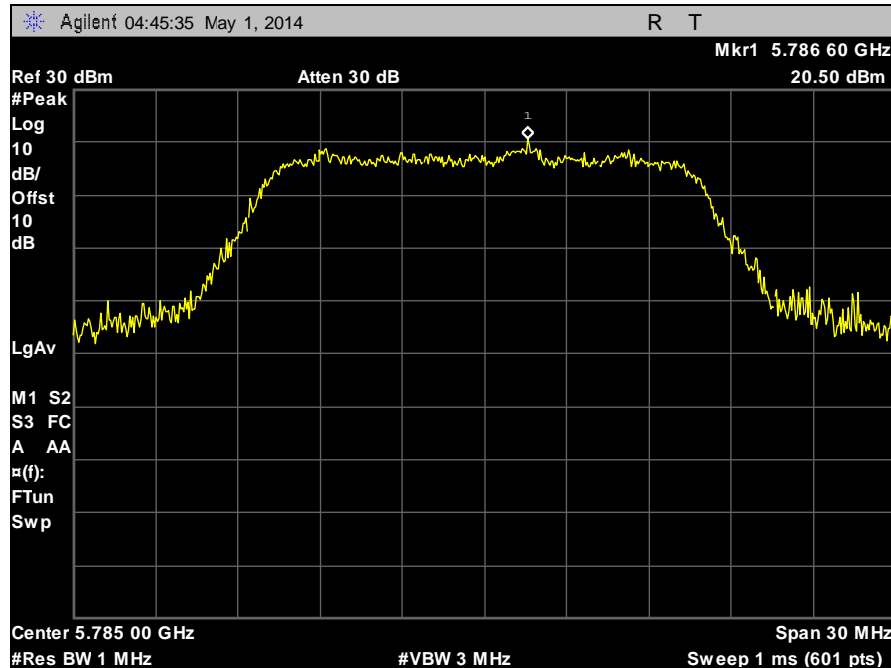

Plot 49. Power Spectral Density Determination, 5785 MHz, 13.5 dBi

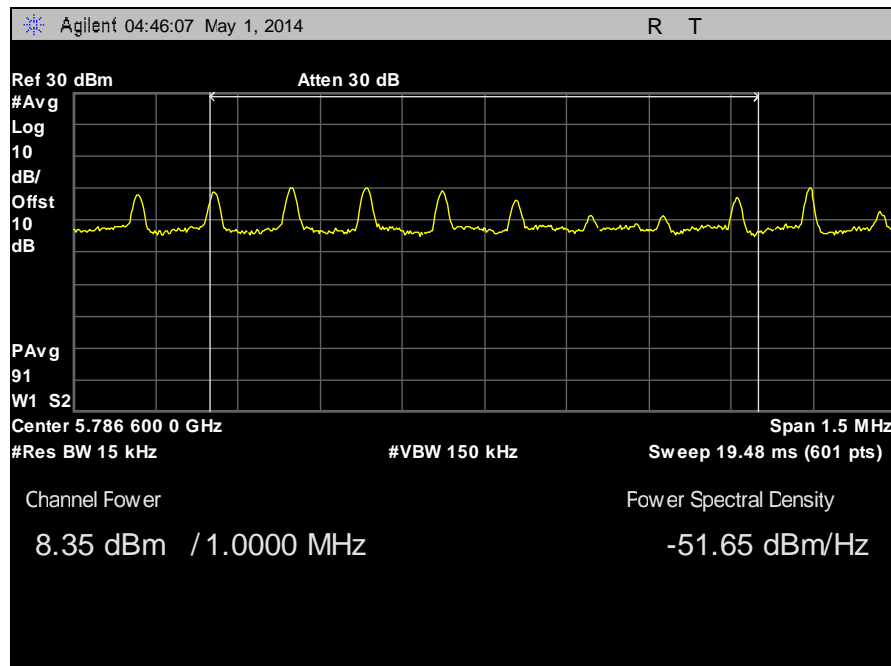

Plot 50. Power Spectral Density, 5785 MHz, 13.5 dBi

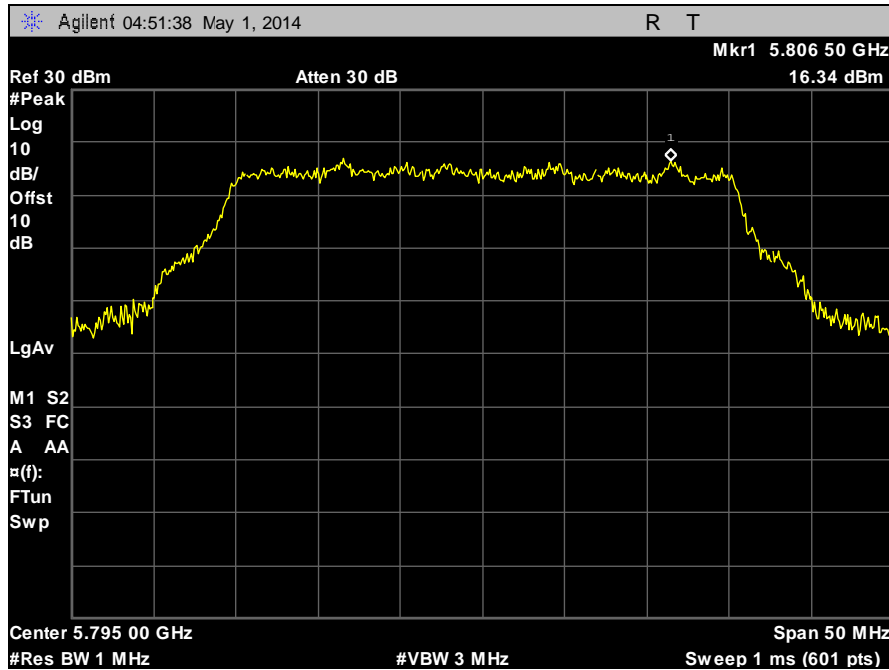

Plot 51. Power Spectral Density Determination, 5795 MHz, 13.5 dBi

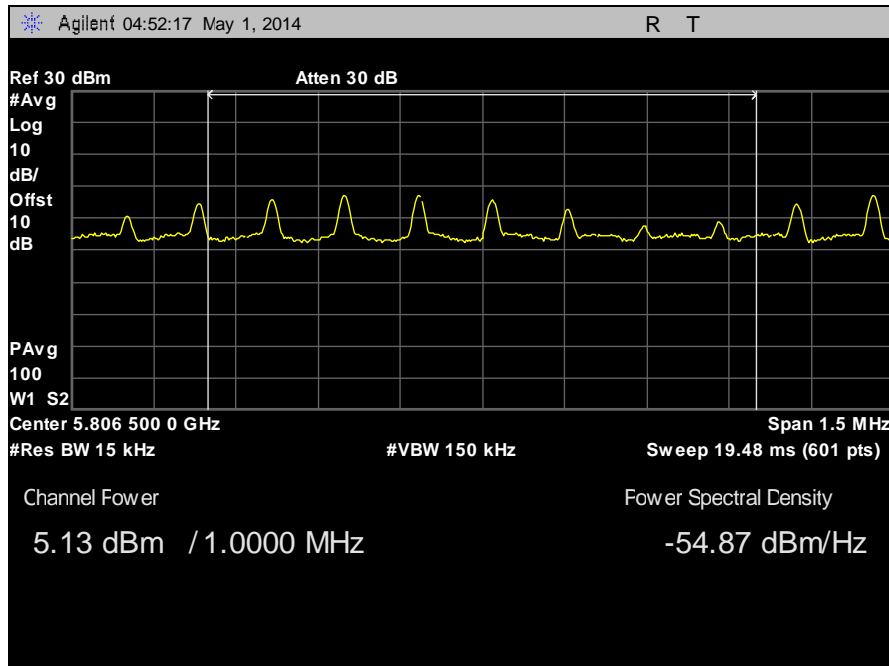

Plot 52. Power Spectral Density, 5795 MHz, 13.5 dBi

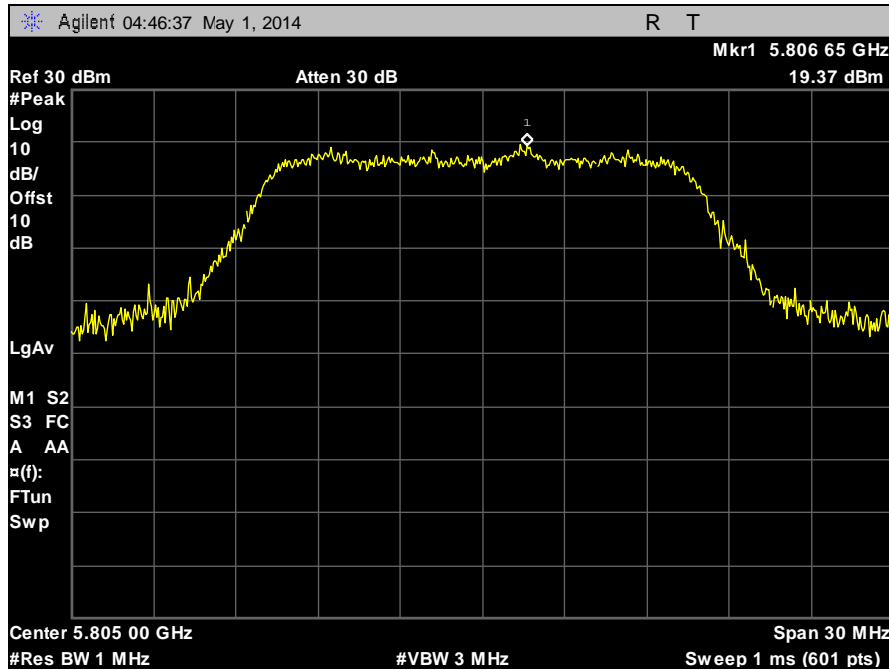

Plot 53. Power Spectral Density Determination, 5805 MHz, 13.5 dBi

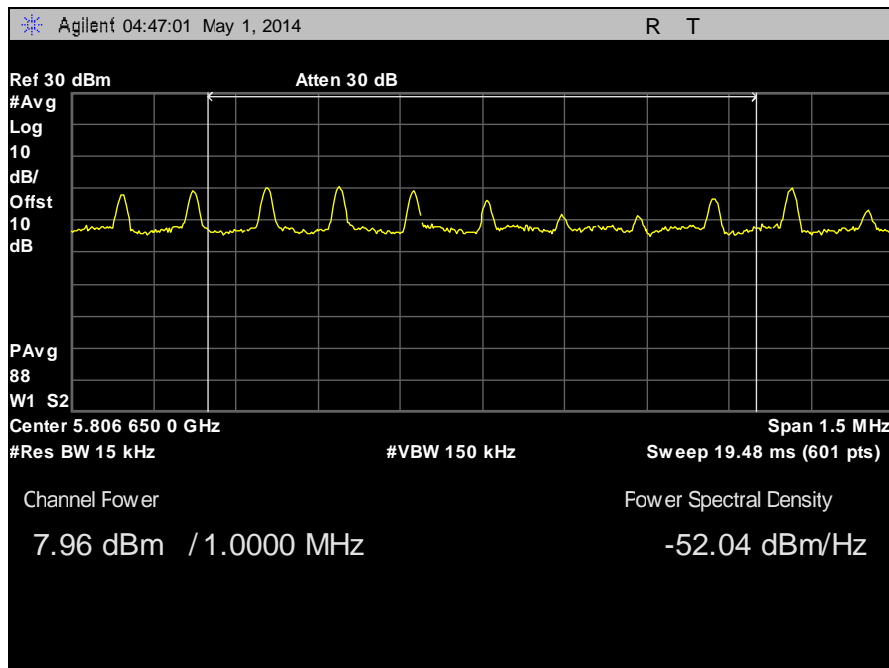

Plot 54. Power Spectral Density, 5805 MHz, 13.5 dBi

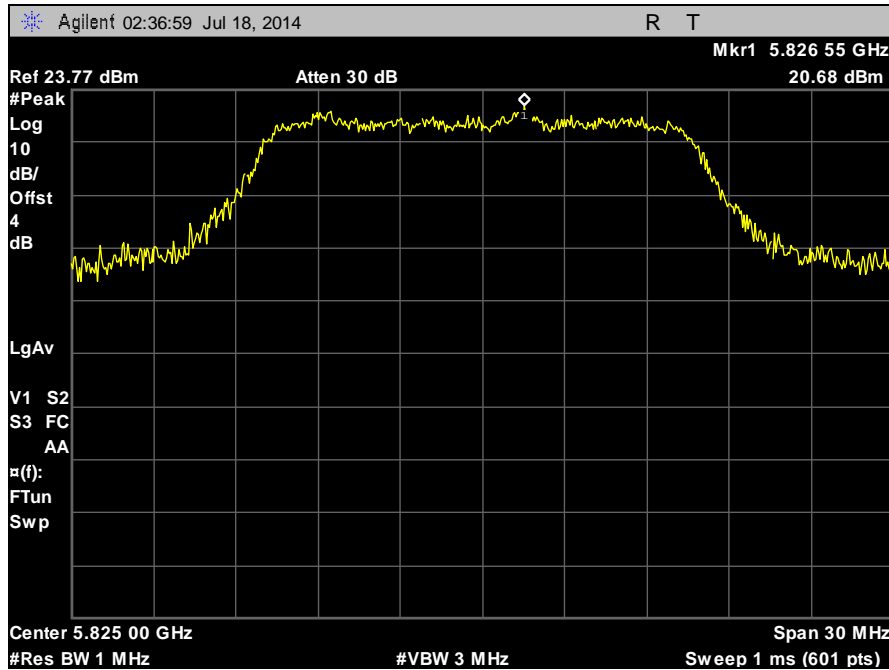

Plot 55. Power Spectral Density Determination, 5825 MHz, 13.5 dBi

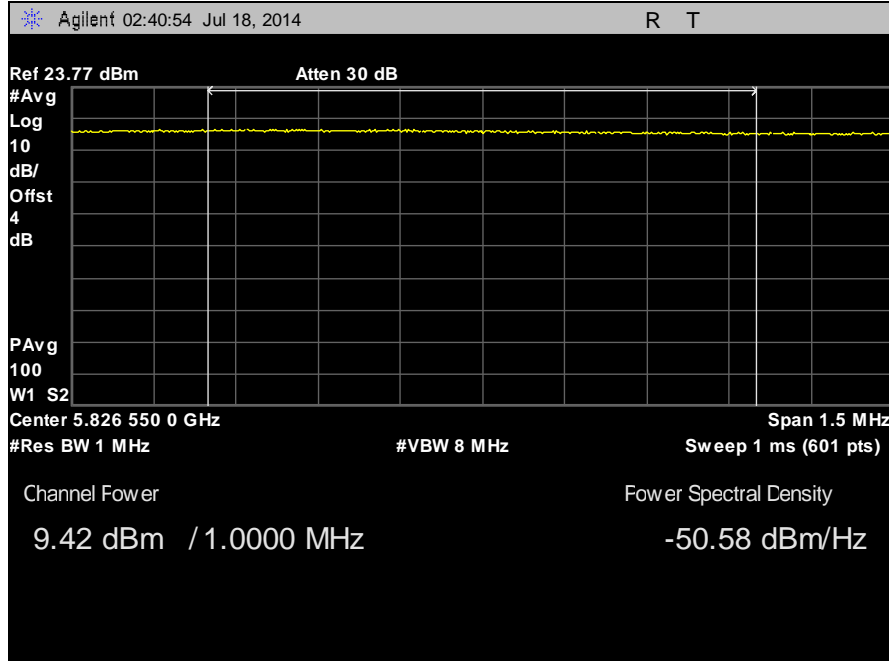

Plot 56. Power Spectral Density, 5825MHz, 13dBi

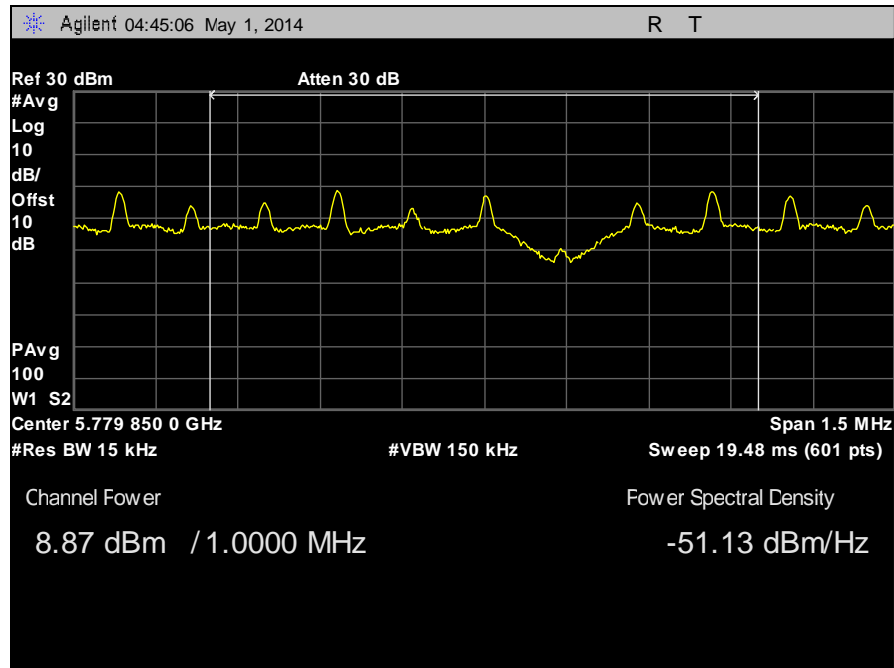

Plot 57. Maximum Conducted Output Power/1MHz, 5785 MHz, 5 dBi Antenna

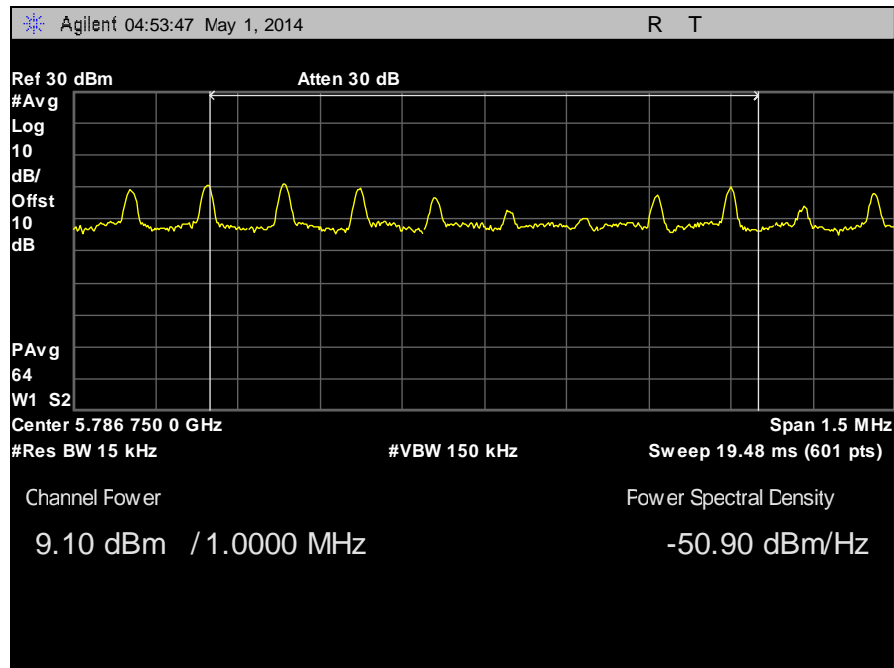

Plot 58. PSD Maximum Conducted Output Power/1MHz, 5795 MHz, 5 dBi Antenna

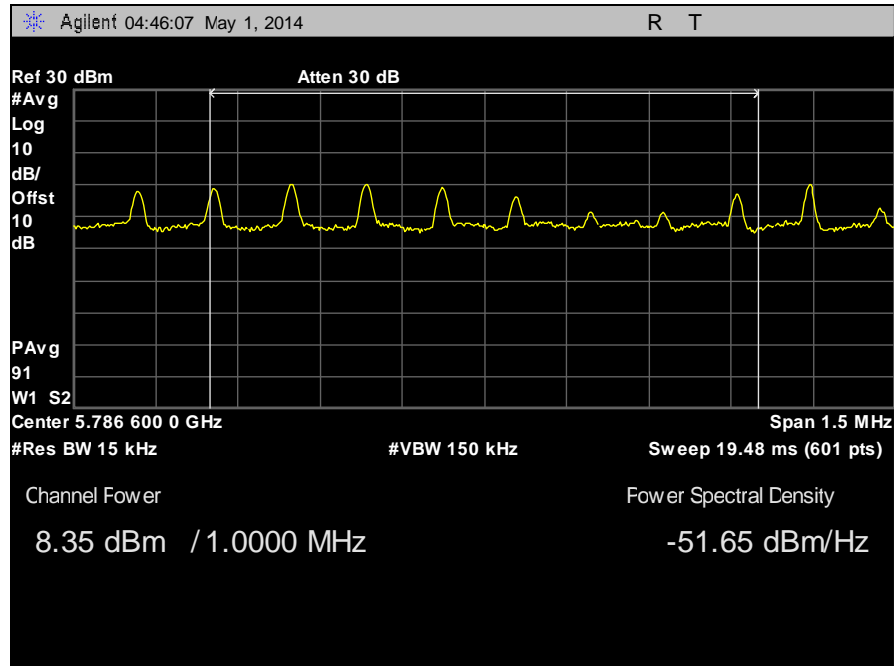

Plot 59. PSD Maximum Conducted Output Power/1MHz, 5785 MHz, 13.5 dBi Antenna

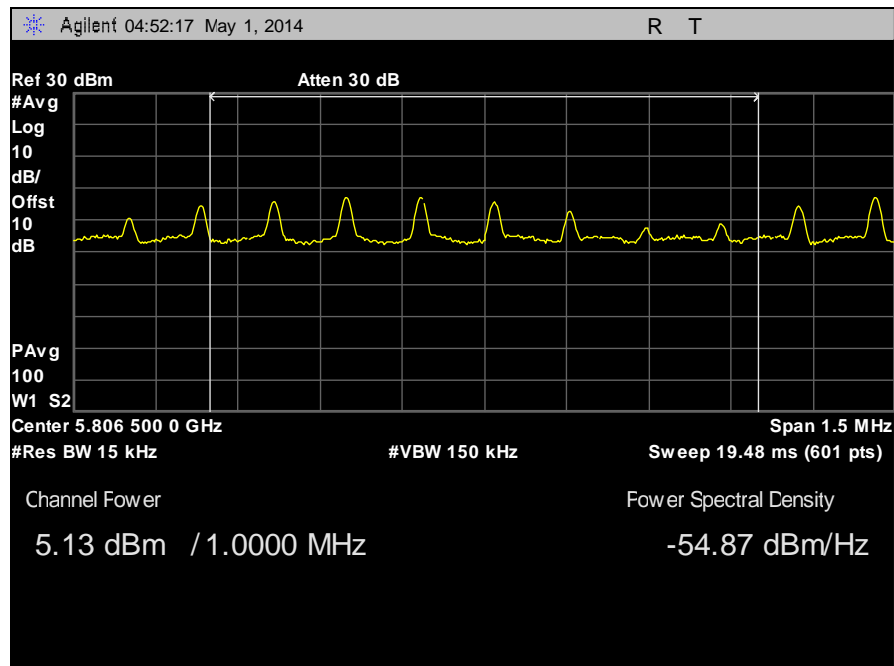

Plot 60. PSD Maximum Conducted Output Power/1MHz, 5795 MHz, 13.5 dBi Antenna

Electromagnetic Compatibility Criteria for Intentional Radiators

§ 15.407(b)(1), (6), (7) Undesirable Emissions

Test Requirements: § 15.407(b)(1), (6), (7); §15.205: Emissions outside the frequency band.

§ 15.407(b)(1): For transmitters operating in the 5.15-5.25 GHz band: all emissions outside of the 5.15-5.35 GHz band shall not exceed an EIRP of -27 dBm/MHz.

§ 15.407(b)(6): Unwanted emissions below 1 GHz must comply with the general field strength limits set forth in Section 15.209. Further, any U-NII devices using an AC power line are required to comply also with the conducted limits set forth in Section 15.207.

§ 15.407(b)(7): The provisions of Section 15.205 of this part apply to intentional radiators operating under this section.

Test Procedure: The EUT was placed on a non-conducting 0.8m high stand on a turntable in a semi-anechoic chamber. The EUT was set to transmit on low, mid, and high channels, while the turntable was rotated 360 degrees through three orthogonal axes and the receiving antenna height was varied to maximize emissions.

For frequencies from 30MHz to 1GHz, measurements were first made using a peak detector with a 100kHz resolution bandwidth. Emissions which exceeded the limits were re-measured using a quasi-peak detector with a 120kHz resolution bandwidth.

For measurements above 1 GHz, measurements were made with a Peak detector with 1 MHz resolution bandwidth. Where the spurious emissions fell into a restricted band, measurements were also made with an average detector to make sure they complied with 15.209 limits. Emissions were explored up to 40 GHz.

The equation, $EIRP = E + 20 \log D - 104.8$ was used to convert an EIRP limit to a field strength limit.

E = field strength (dBV/m)

D = Reference measurement distance

Test Results: The EUT was compliant with the Radiated Emission limits for Intentional Radiators. See following pages for detailed test results. Only noise floor was observed above 18GHz. There were some emissions over the FCC 15.209 requirement between 30MHz-1GHz. However, these emissions were still there while radio was turned off. Therefore, they are digital emissions.

Test Engineer(s): Surinder Singh

Test Date(s): 5/13/14

Radiated Spurious Emissions, Test Results, 2 dBi Antenna

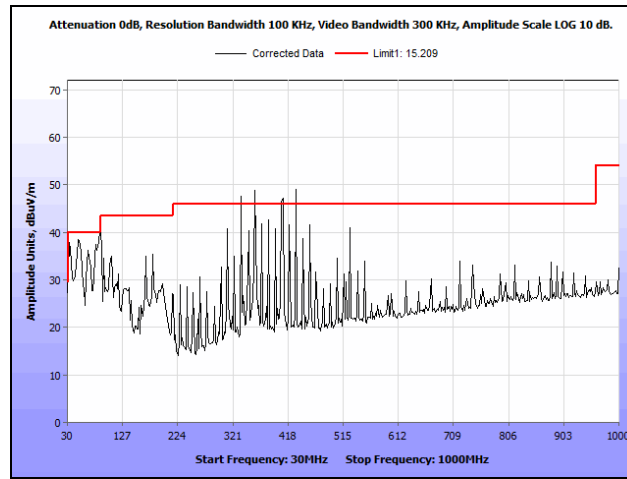

Plot 61. Radiated Spurious Emissions, 5745 MHz, 30 MHz – 1 GHz, 2 dBi Antenna

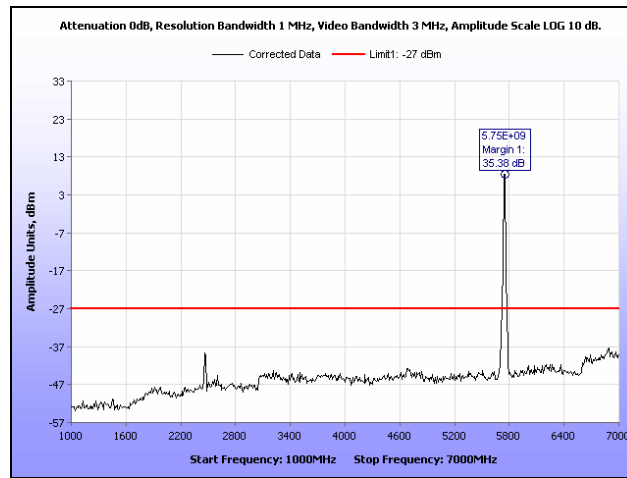

Plot 62. Radiated Spurious Emissions, 5745 MHz, 1 GHz – 7 GHz, 2 dBi Antenna

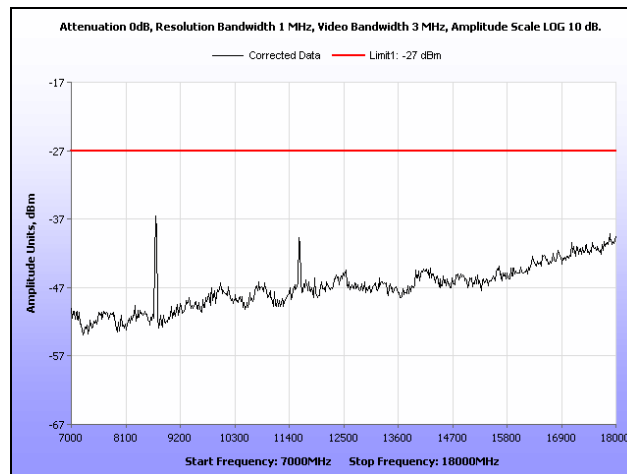

Plot 63. Radiated Spurious Emissions, 5745 MHz, 7 GHz – 18 GHz, 2 dBi Antenna

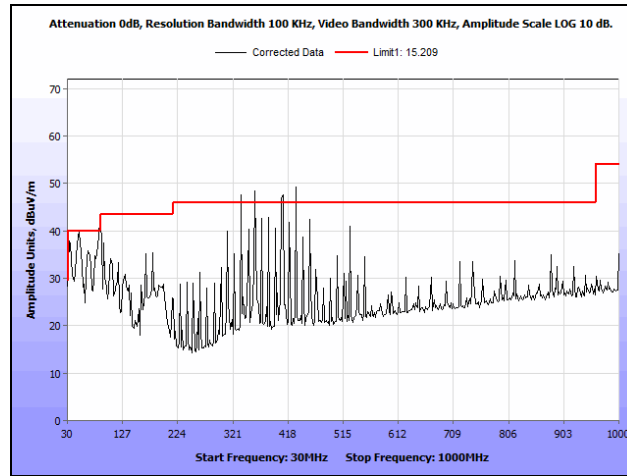

Plot 64. Radiated Spurious Emissions, 5755 MHz, 30 MHz – 1 GHz, 2 dBi Antenna

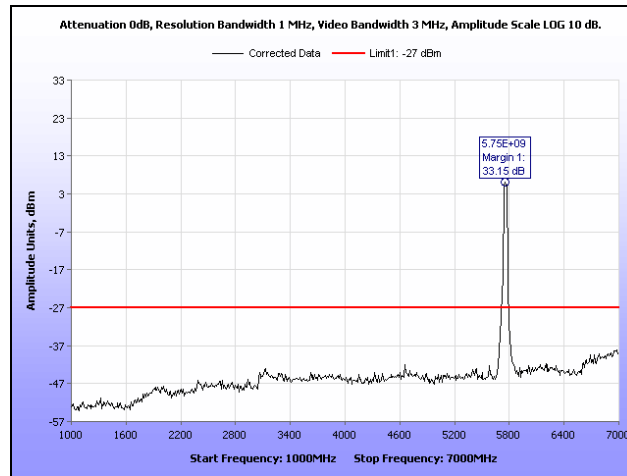

Plot 65. Radiated Spurious Emissions, 5755 MHz, 1 GHz – 7 GHz, 2 dBi Antenna

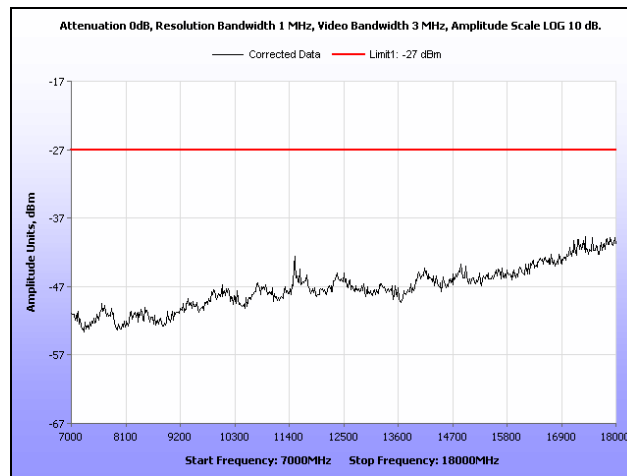

Plot 66. Radiated Spurious Emissions, 5755 MHz, 7 GHz – 18 GHz, 2 dBi Antenna

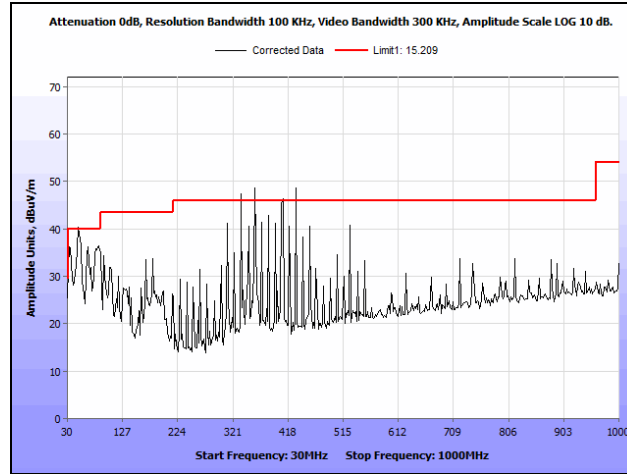

Plot 67. Radiated Spurious Emissions, 5785 MHz, 30 MHz – 1 GHz, 2 dBi Antenna

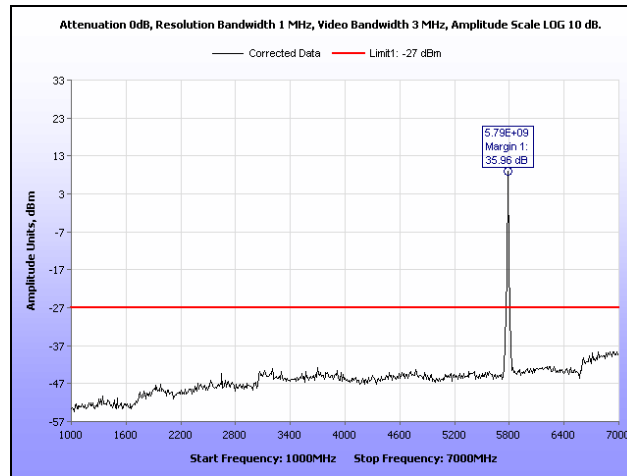

Plot 68. Radiated Spurious Emissions, 5785 MHz, 1 GHz – 7 GHz, 2 dBi Antenna

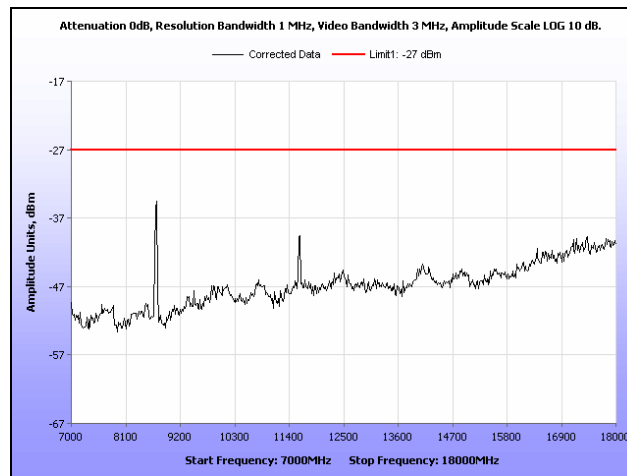

Plot 69. Radiated Spurious Emissions, 5785 MHz, 7 GHz – 18 GHz, 2 dBi Antenna

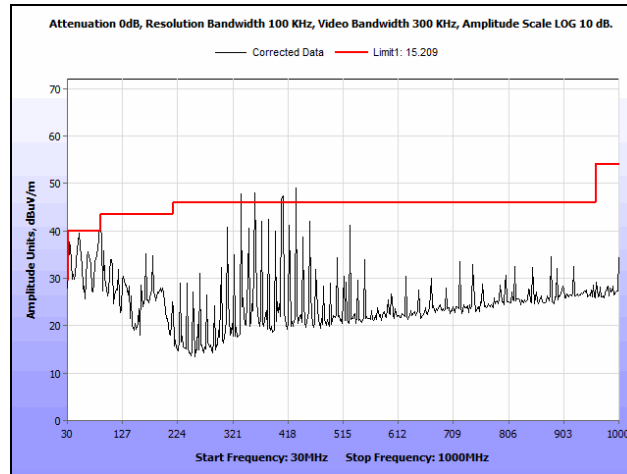

Plot 70. Radiated Spurious Emissions, 5795 MHz, 30 MHz – 1 GHz, 2 dBi Antenna

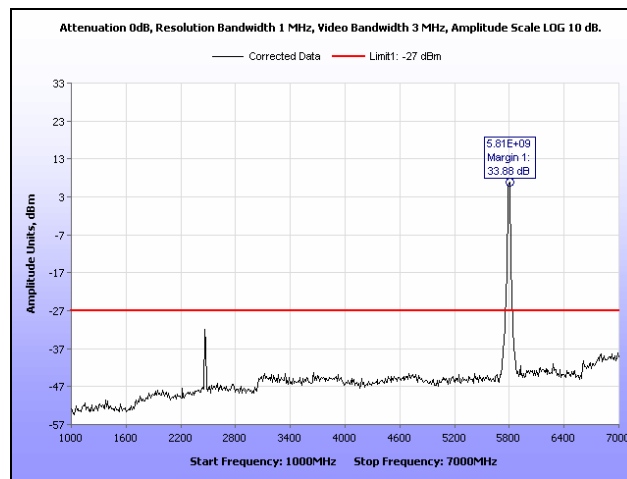

Plot 71. Radiated Spurious Emissions, 5795 MHz, 1 GHz – 7 GHz, 2 dBi Antenna

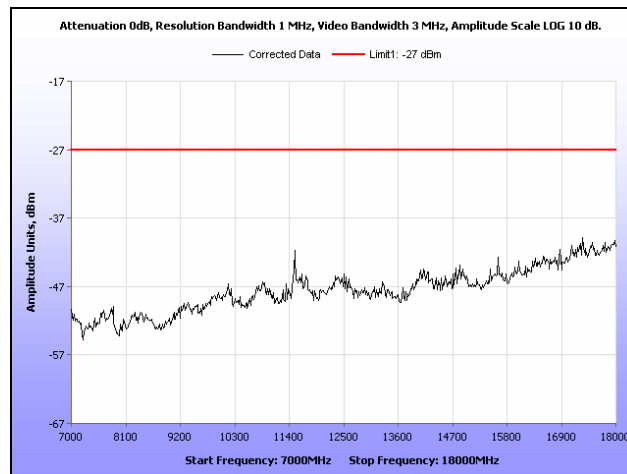

Plot 72. Radiated Spurious Emissions, 5795 MHz, 7 GHz – 18 GHz, 2 dBi Antenna

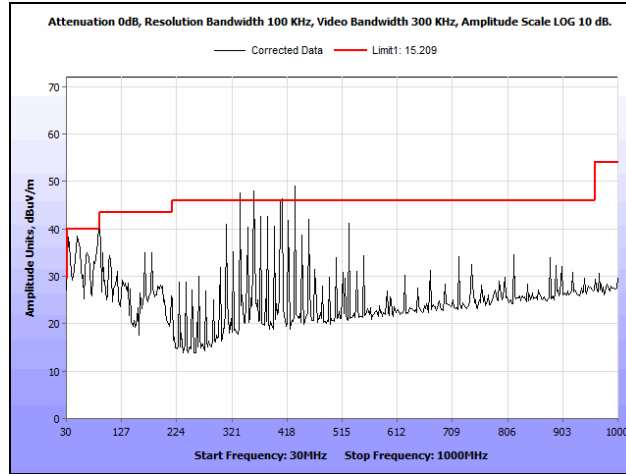

Plot 73. Radiated Spurious Emissions, 5805 MHz, 30 MHz – 1 GHz, 2 dBi Antenna

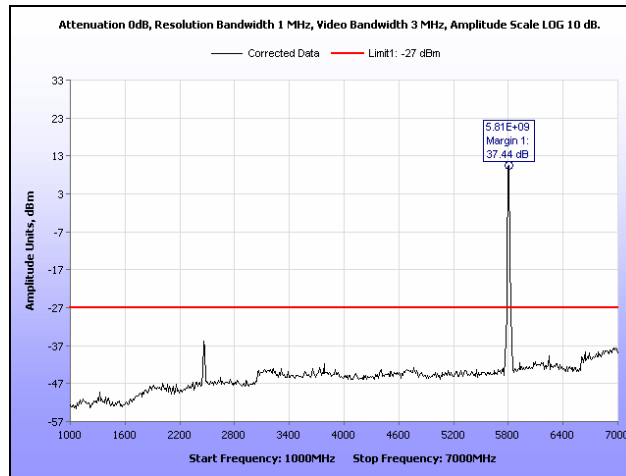

Plot 74. Radiated Spurious Emissions, 5805 MHz, 1 GHz – 7 GHz, 2 dBi Antenna

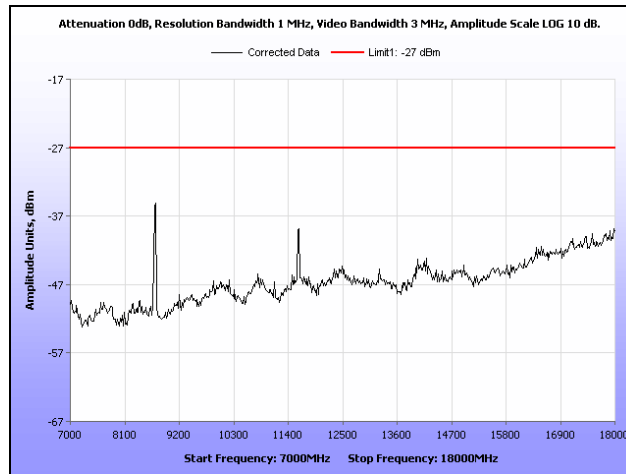

Plot 75. Radiated Spurious Emissions, 5805 MHz, 7 GHz – 18 GHz, 2 dBi Antenna

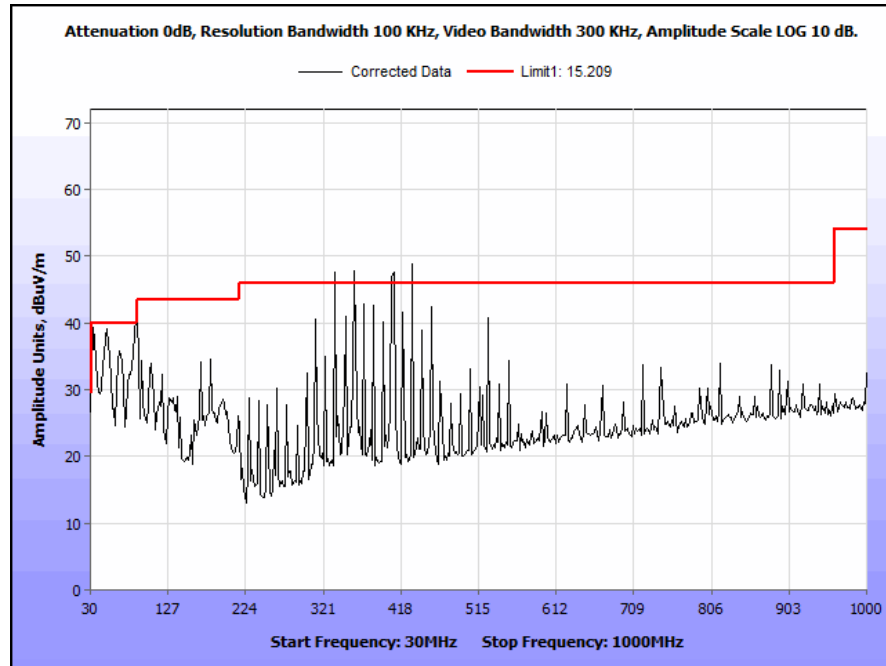

Plot 76. Radiated Spurious Emissions, Support Equipment Present Radio Off, 30 MHz – 1 GHz, 2 dBi

Radiated Spurious Emissions, Test Results, 5 dBi Antenna

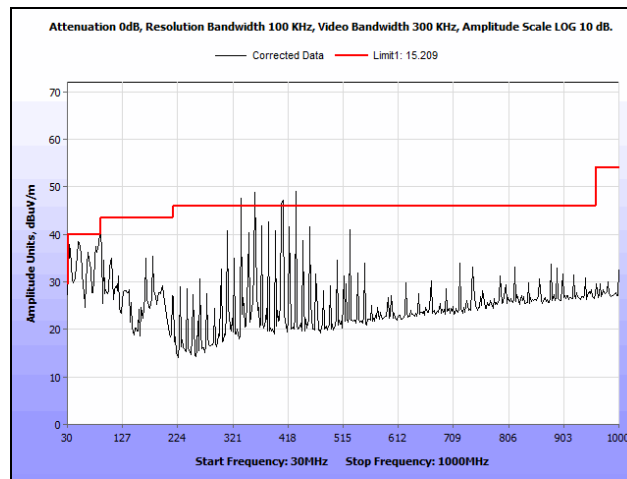

Plot 77. Radiated Spurious Emissions, 5745 MHz, 30 MHz – 1 GHz, 5 dBi Antenna

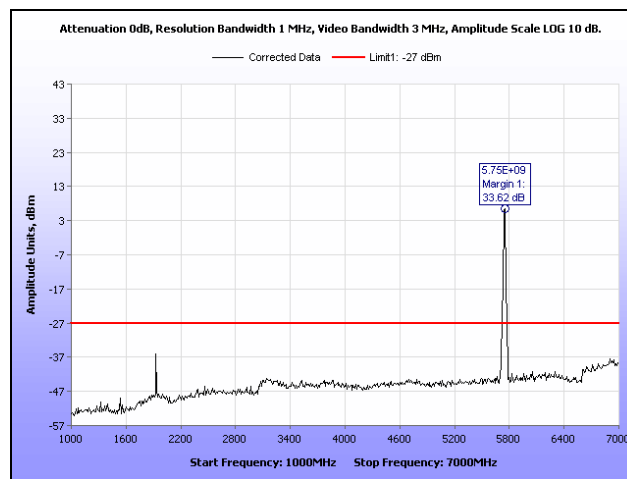

Plot 78. Radiated Spurious Emissions, 5745 MHz, 1 GHz – 7 GHz, 5 dBi Antenna

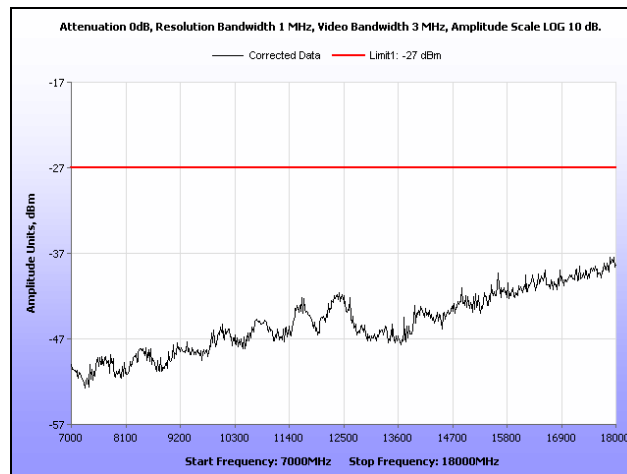

Plot 79. Radiated Spurious Emissions, 5745 MHz, 7 GHz – 18 GHz, 5 dBi Antenna

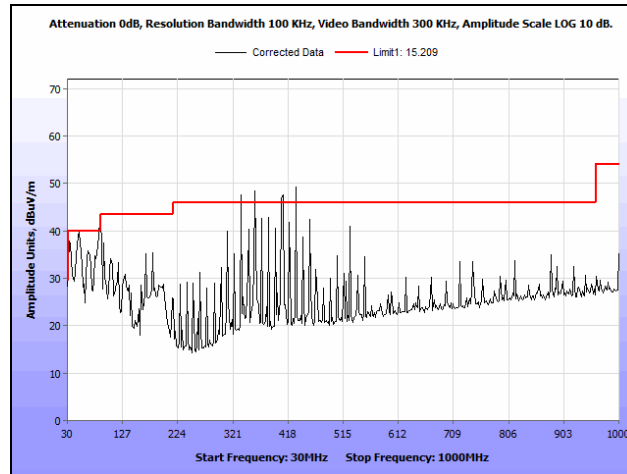

Plot 80. Radiated Spurious Emissions, 5755 MHz, 30 MHz – 1 GHz, 5 dBi Antenna

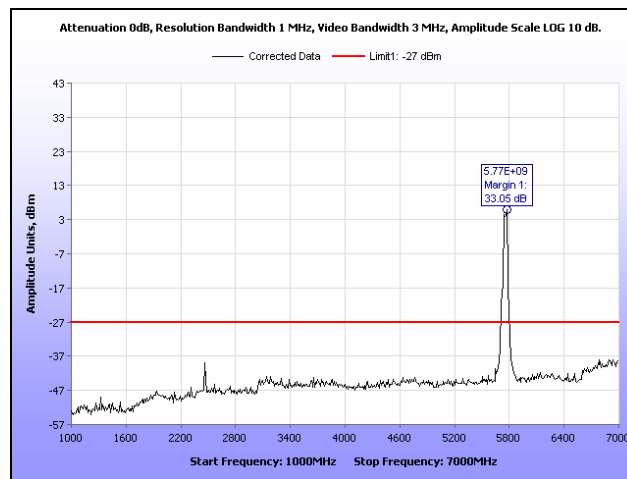

Plot 81. Radiated Spurious Emissions, 5755 MHz, 1 GHz – 7 GHz, 5 dBi Antenna

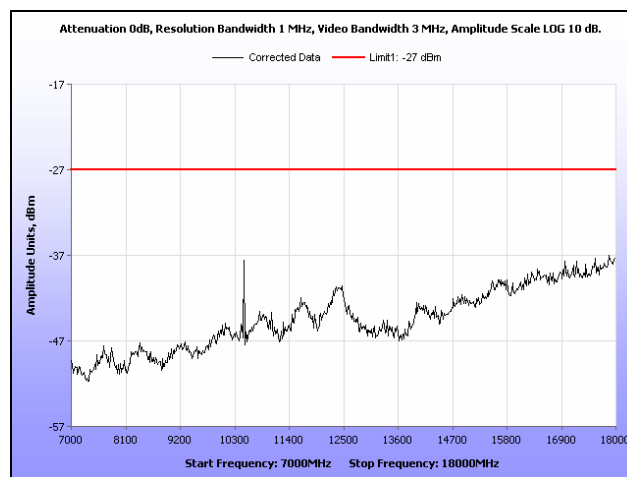

Plot 82. Radiated Spurious Emissions, 5755 MHz, 7 GHz – 18 GHz, 5 dBi Antenna

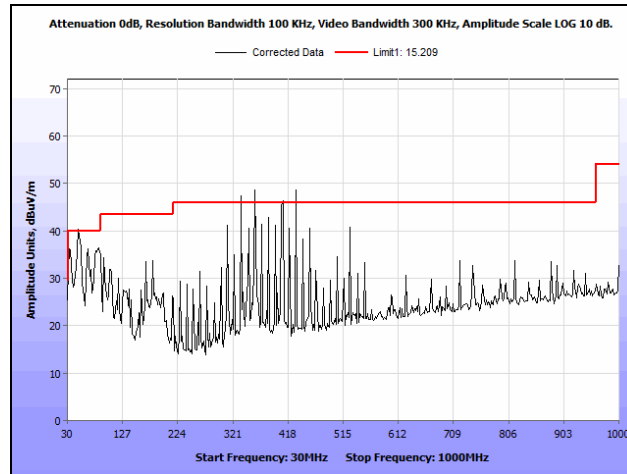

Plot 83. Radiated Spurious Emissions, 5785 MHz, 30 MHz – 1 GHz, 5 dBi Antenna

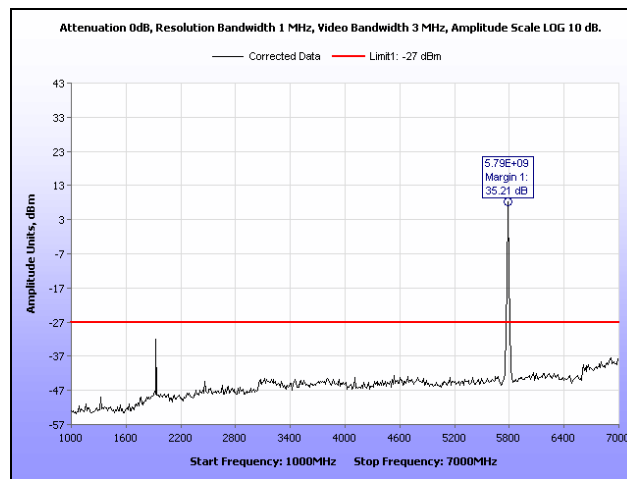

Plot 84. Radiated Spurious Emissions, 5785 MHz, 1 GHz – 7 GHz, 5 dBi Antenna

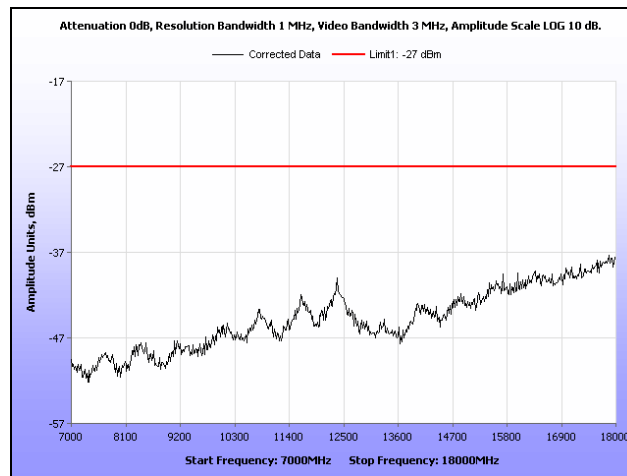

Plot 85. Radiated Spurious Emissions, 5785 MHz, 7 GHz – 18 GHz, 5 dBi Antenna

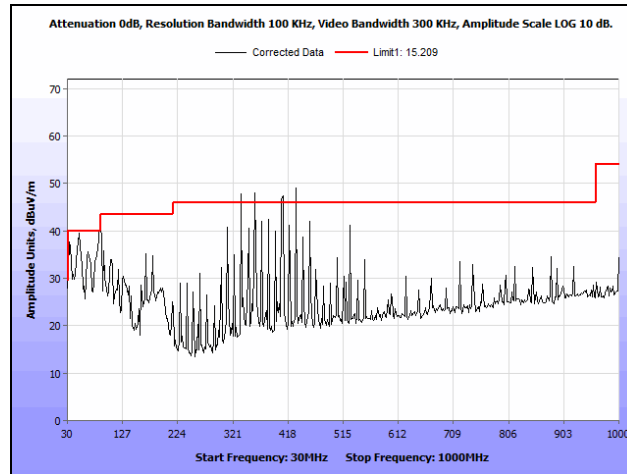

Plot 86. Radiated Spurious Emissions, 5795 MHz, 30 MHz – 1 GHz, 5 dBi Antenna

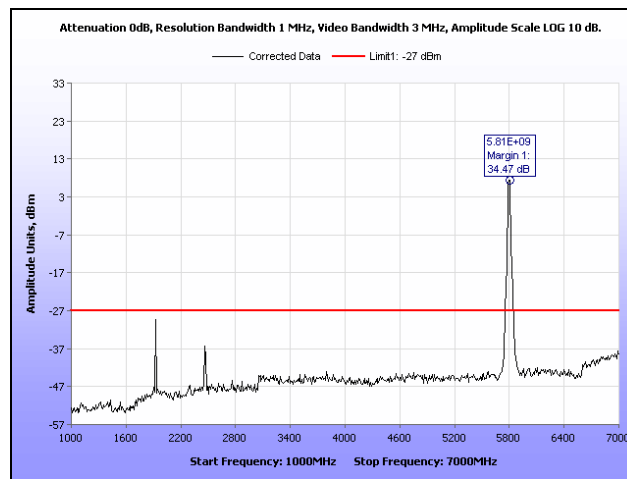

Plot 87. Radiated Spurious Emissions, 5795 MHz, 1 GHz – 7 GHz, 5 dBi Antenna

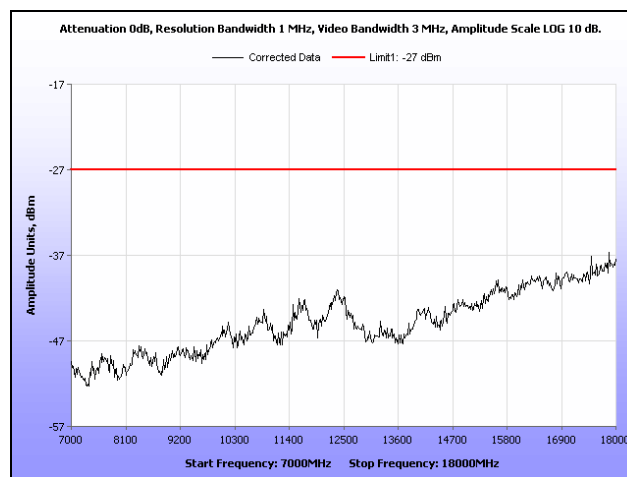

Plot 88. Radiated Spurious Emissions, 5795 MHz, 7 GHz – 18 GHz, 5 dBi Antenna

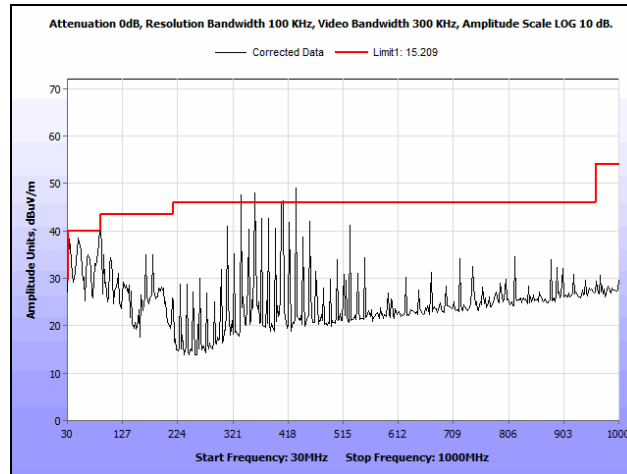

Plot 89. Radiated Spurious Emissions, 5805 MHz, 30 MHz – 1 GHz, 5 dBi Antenna

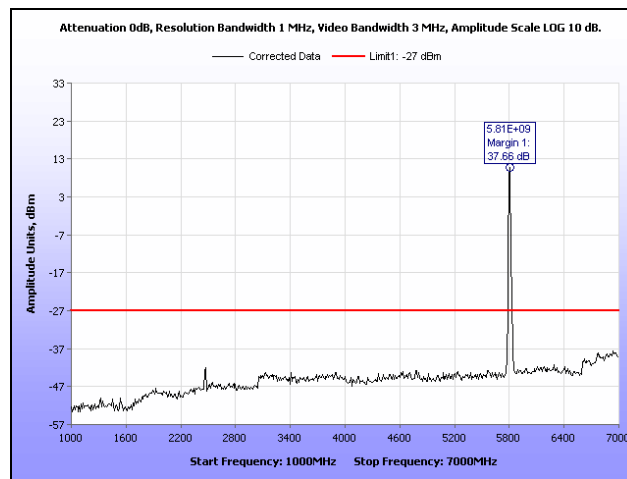

Plot 90. Radiated Spurious Emissions, 5805 MHz, 1 GHz – 7 GHz, 5 dBi Antenna

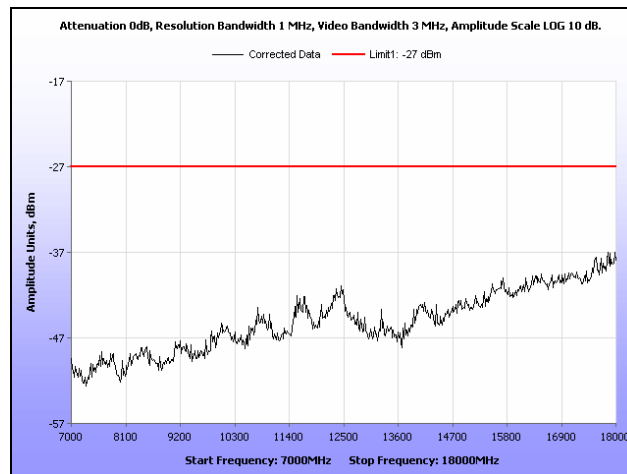

Plot 91. Radiated Spurious Emissions, 5805 MHz, 7 GHz – 18 GHz, 5 dBi Antenna

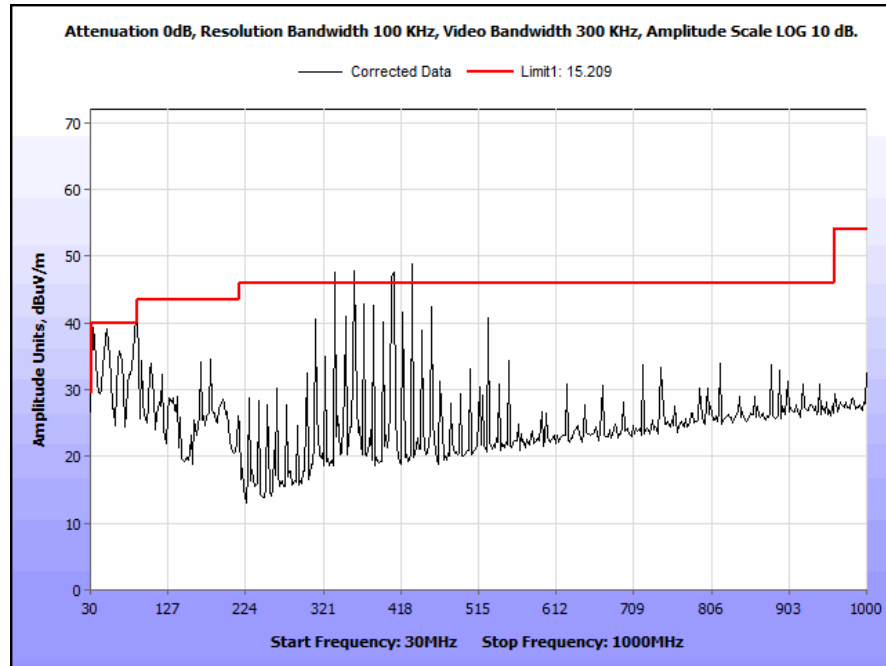

Plot 92. Radiated Spurious Emissions, Support Equipment Present Radio Off, 30 MHz – 1 GHz, 5 dBi

Radiated Spurious Emissions, Test Results, 13.5 dBi Antenna

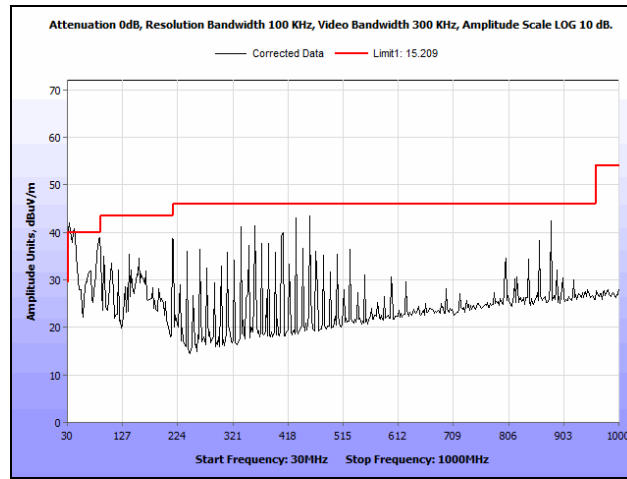

Plot 93. Radiated Spurious Emissions, 5745 MHz, 30 MHz – 1 GHz, 13.5 dBi Antenna

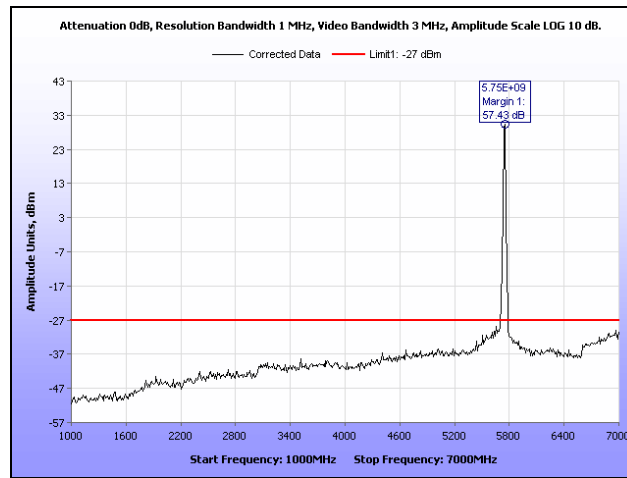

Plot 94. Radiated Spurious Emissions, 5745 MHz, 1 GHz – 7 GHz, 13.5 dBi Antenna

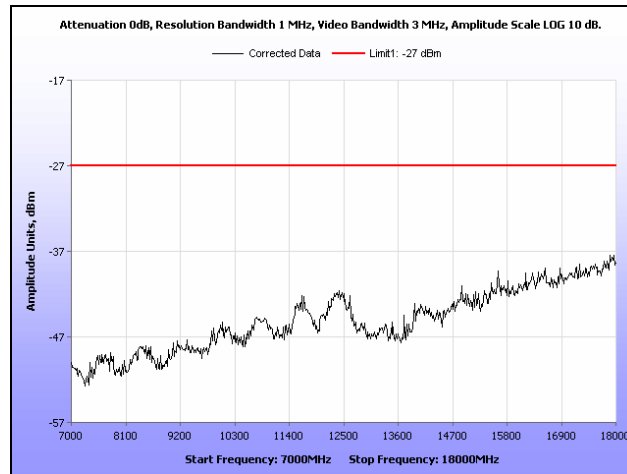

Plot 95. Radiated Spurious Emissions, 5745 MHz, 7 GHz – 18 GHz, 13.5 dBi Antenna

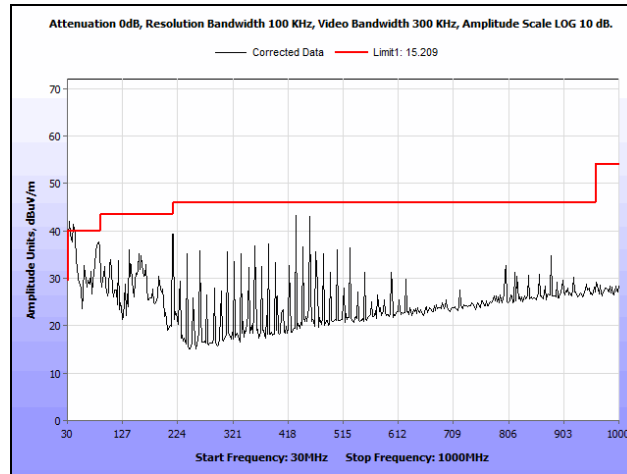

Plot 96. Radiated Spurious Emissions, 5755 MHz, 30 MHz – 1 GHz, 13.5 dBi Antenna

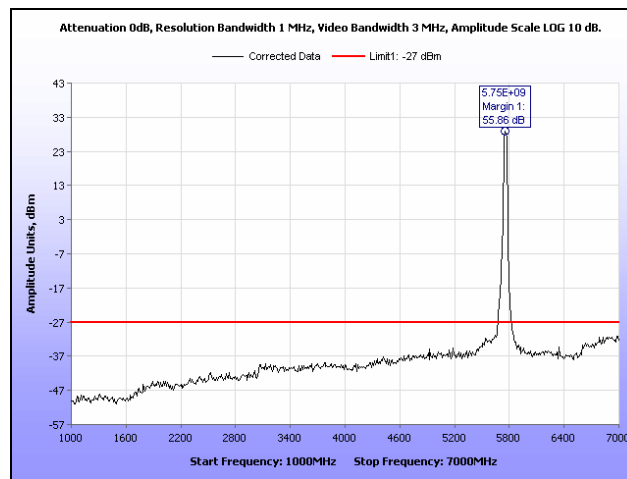

Plot 97. Radiated Spurious Emissions, 5755 MHz, 1 GHz – 7 GHz, 13.5 dBi Antenna

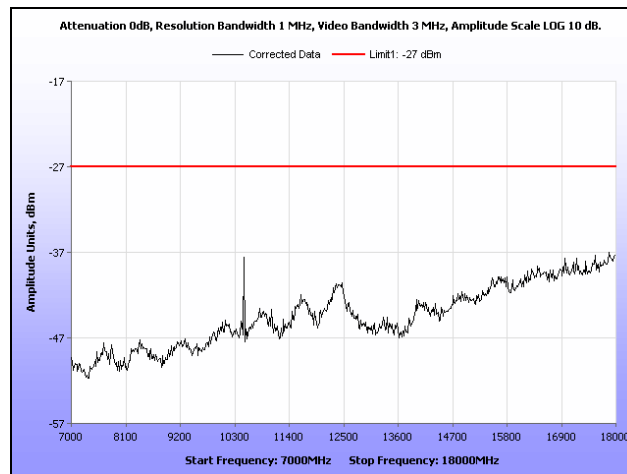

Plot 98. Radiated Spurious Emissions, 5755 MHz, 7 GHz – 18 GHz, 13.5 dBi Antenna

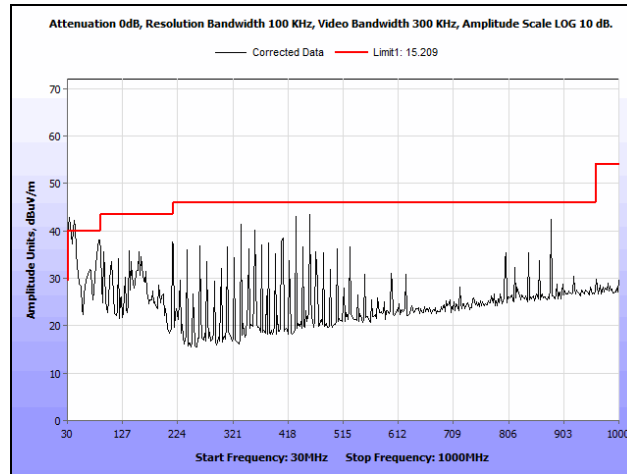

Plot 99. Radiated Spurious Emissions, 5785 MHz, 30 MHz – 1 GHz, 13.5 dBi Antenna

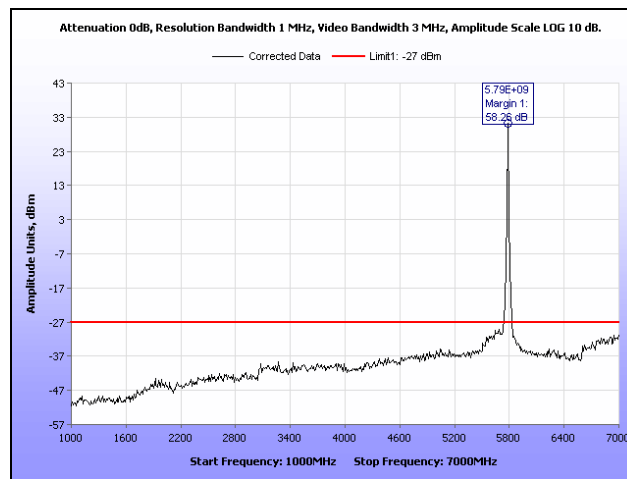

Plot 100. Radiated Spurious Emissions, 5785 MHz, 1 GHz – 7 GHz, 13.5 dBi Antenna

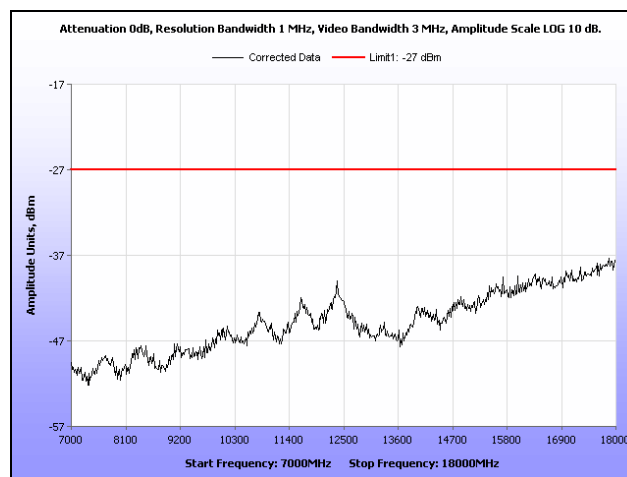

Plot 101. Radiated Spurious Emissions, 5785 MHz, 7 GHz – 18 GHz, 13.5 dBi Antenna

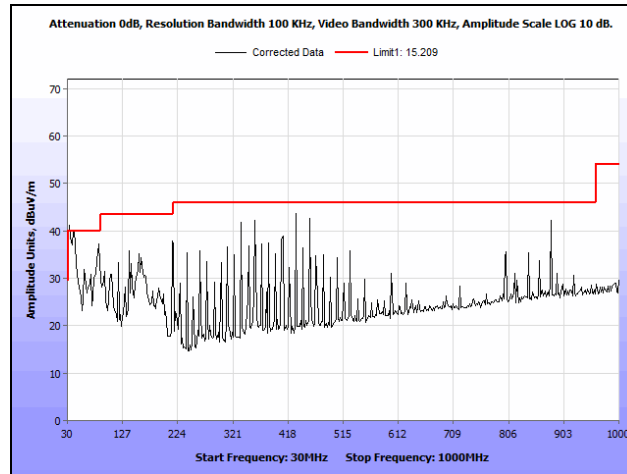

Plot 102. Radiated Spurious Emissions, 5795 MHz, 30 MHz – 1 GHz, 13.5 dBi Antenna

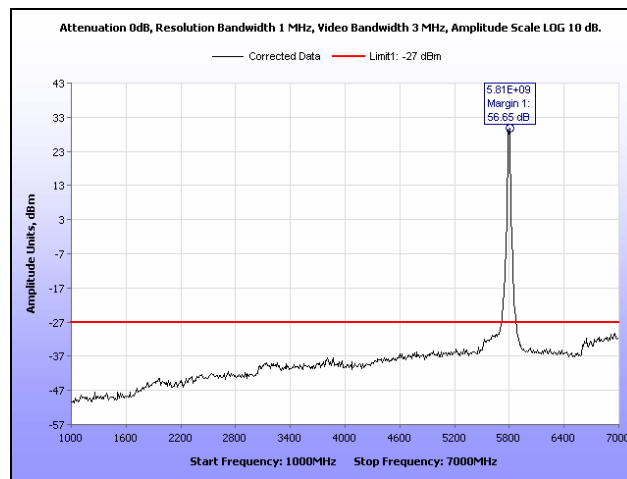

Plot 103. Radiated Spurious Emissions, 5795 MHz, 1 GHz – 7 GHz, 13.5 dBi Antenna

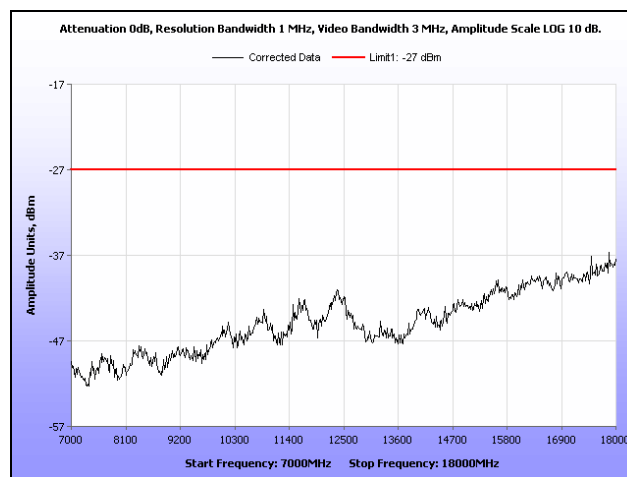

Plot 104. Radiated Spurious Emissions, 5795 MHz, 7 GHz – 18 GHz, 13.5 dBi Antenna

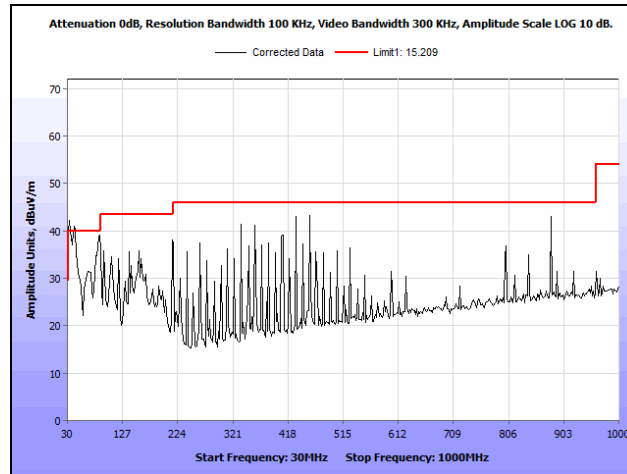

Plot 105. Radiated Spurious Emissions, 5805 MHz, 30 MHz – 1 GHz, 13.5 dBi Antenna

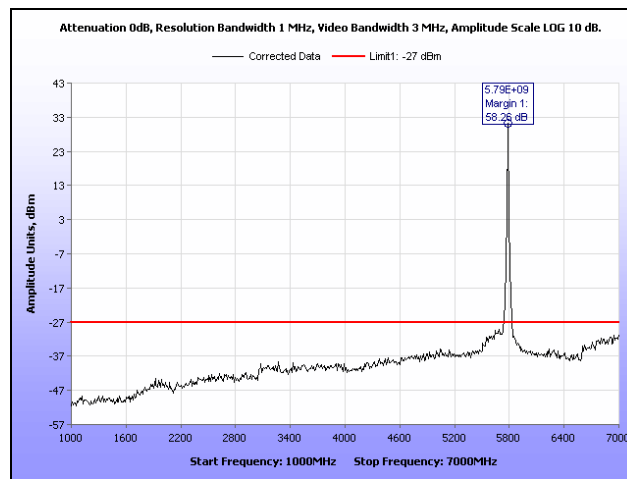

Plot 106. Radiated Spurious Emissions, 5805 MHz, 1 GHz – 7 GHz, 13.5 dBi Antenna

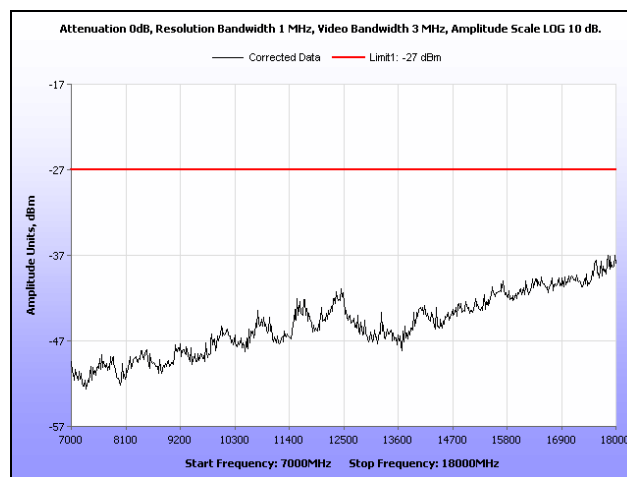

Plot 107. Radiated Spurious Emissions, 5805 MHz, 7 GHz – 18 GHz, 13.5 dBi Antenna

Band Edge, 2 dBi

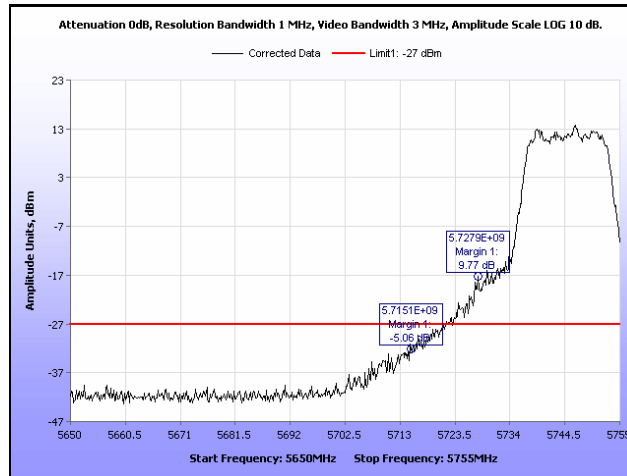

Plot 108. Radiated Spurious Emissions, Band Edge, 5745 MHz, 2 dBi

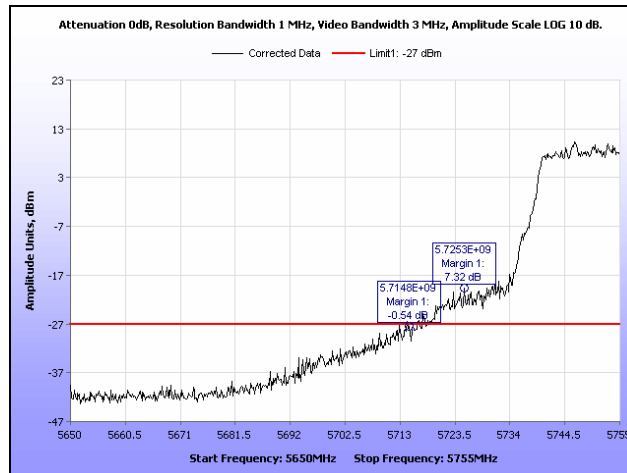

Plot 109. Radiated Spurious Emissions, Band Edge, 5755 MHz, 2 dBi

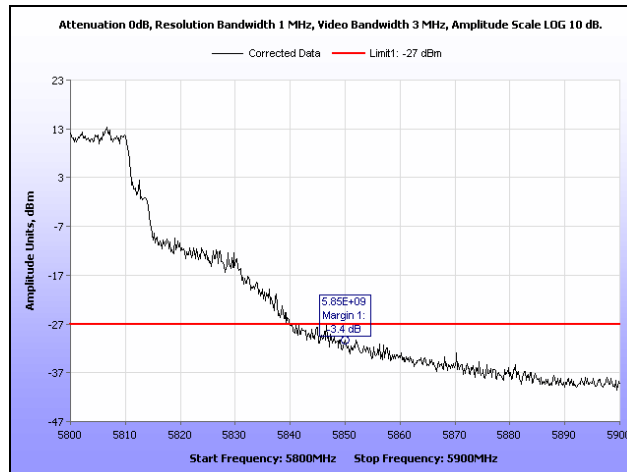

Plot 110. Radiated Spurious Emissions, Band Edge, 5795 MHz, 2 dBi

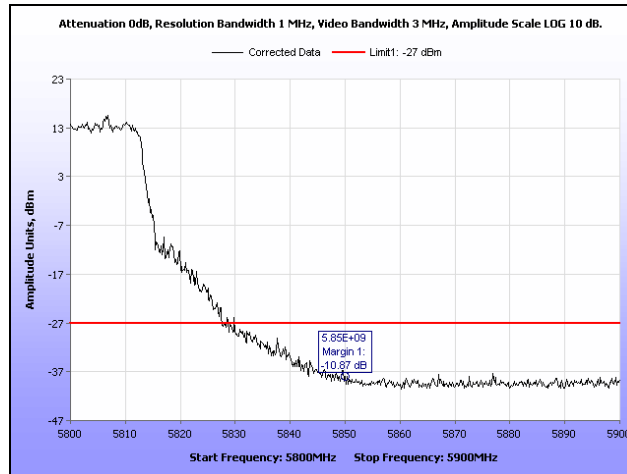

Plot 111. Radiated Spurious Emissions, Band Edge, 5805 MHz, 2 dBi

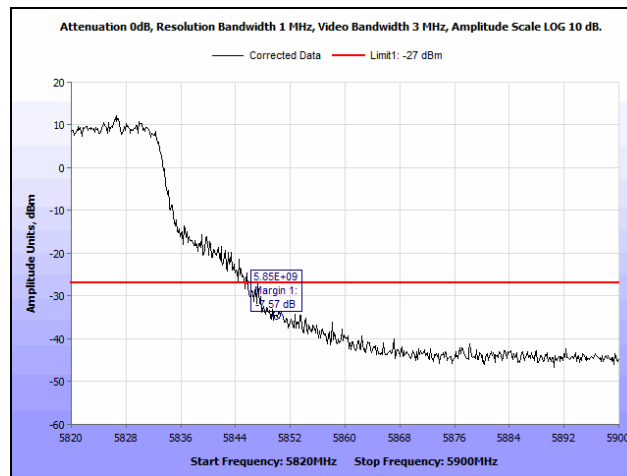

Plot 112. Radiated Spurious Emissions, Band Edge, 5825 MHz, 2 dBi

Band Edge, 5 dBi

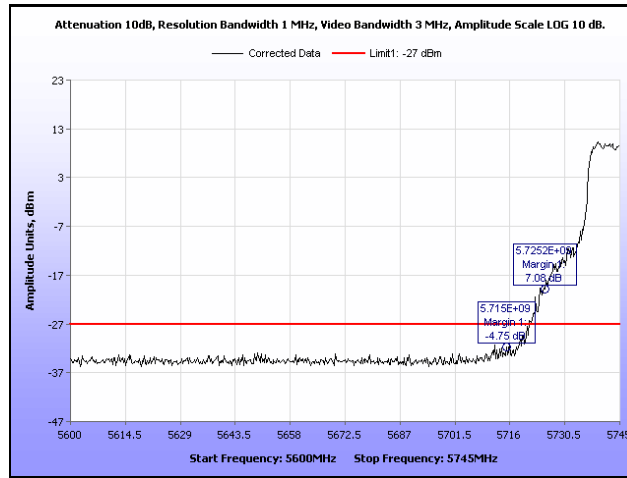

Plot 113. Radiated Spurious Emissions, Band Edge, 5745 MHz, 5 dBi

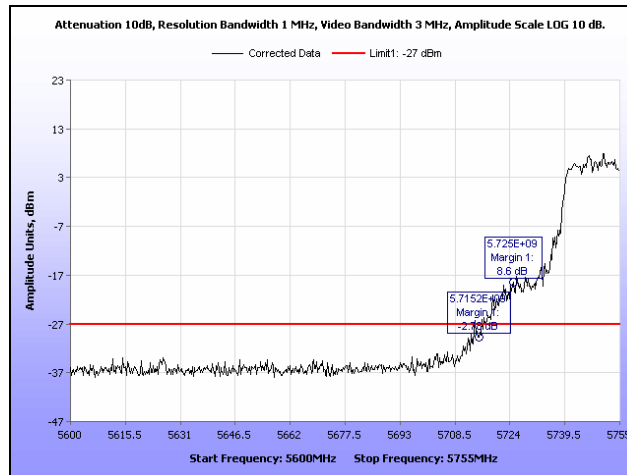

Plot 114. Radiated Spurious Emissions, Band Edge, 5755 MHz, 5 dBi

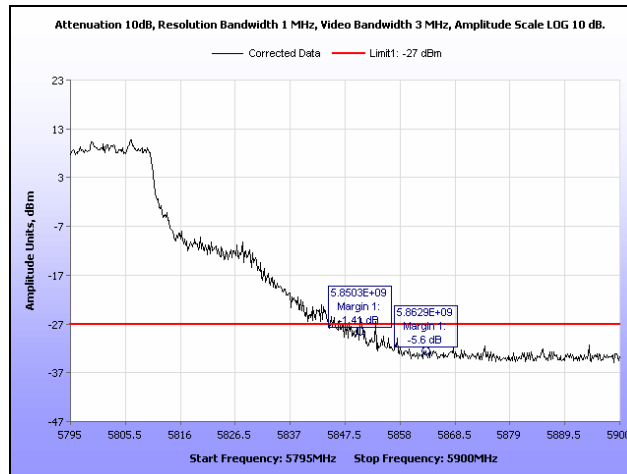

Plot 115. Radiated Spurious Emissions, Band Edge, 5795 MHz, 5 dBi

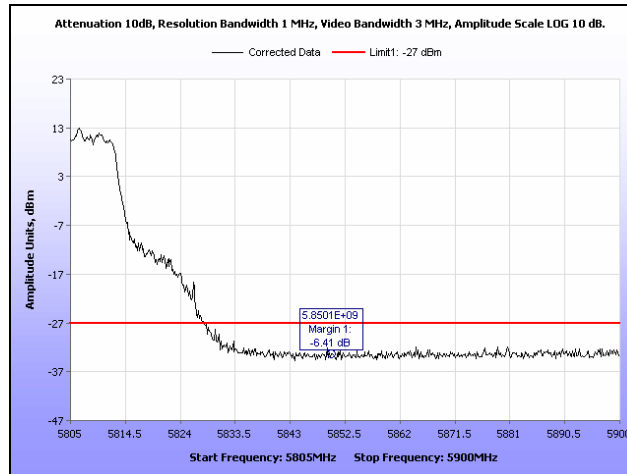

Plot 116. Radiated Spurious Emissions, Band Edge, 5805 MHz, 5 dBi

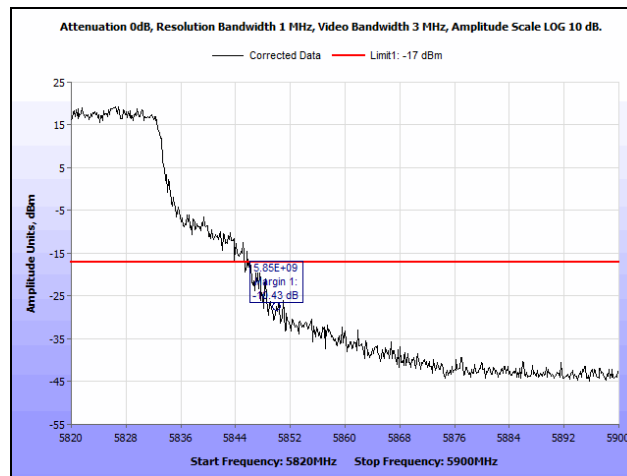

Plot 117. Radiated Spurious Emissions, Band Edge, 5825 MHz, 5 dBi

Band Edge, 13.5 dBi

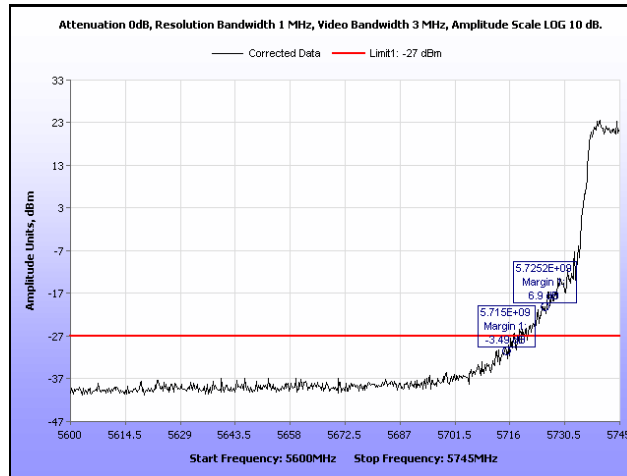

Plot 118. Radiated Spurious Emissions, Band Edge, 5745 MHz, 13.5 dBi

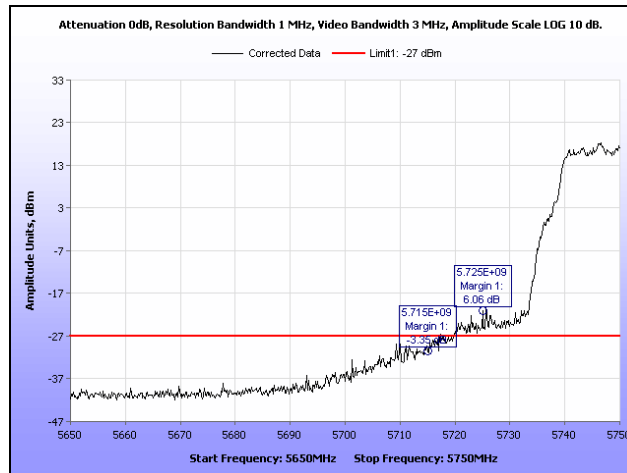

Plot 119. Radiated Spurious Emissions, Band Edge, 5755 MHz, 13.5 dBi

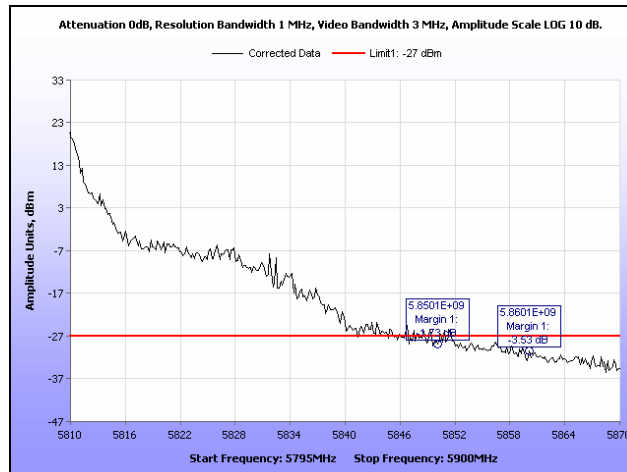

Plot 120. Radiated Spurious Emissions, Band Edge, 5795 MHz, 13.5 dBi

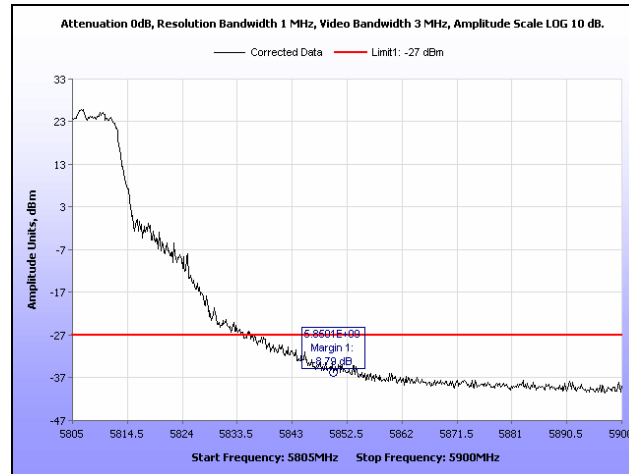

Plot 121. Radiated Spurious Emissions, Band Edge, 5805 MHz, 13.5 dBi

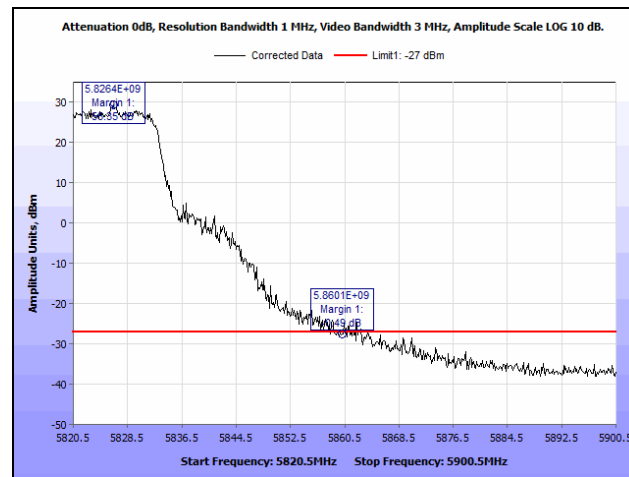

Plot 122. Radiated Spurious Emissions, Band Edge, 5825 MHz, 13.5 dBi

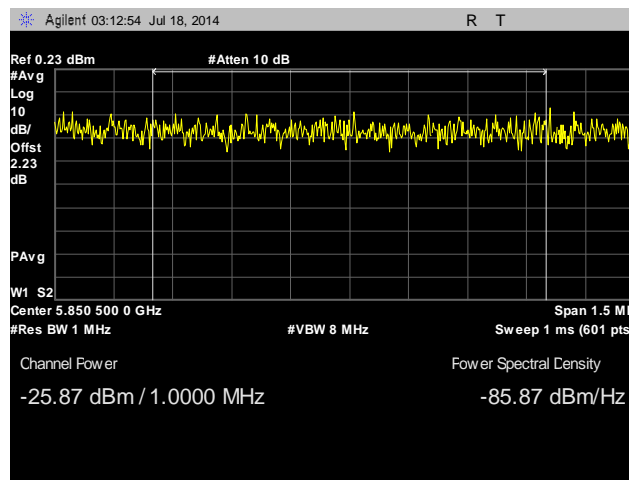

Plot 123. Radiated Spurious Emissions, Band Edge, 5825 MHz, 1 MHz Integration -17dBm

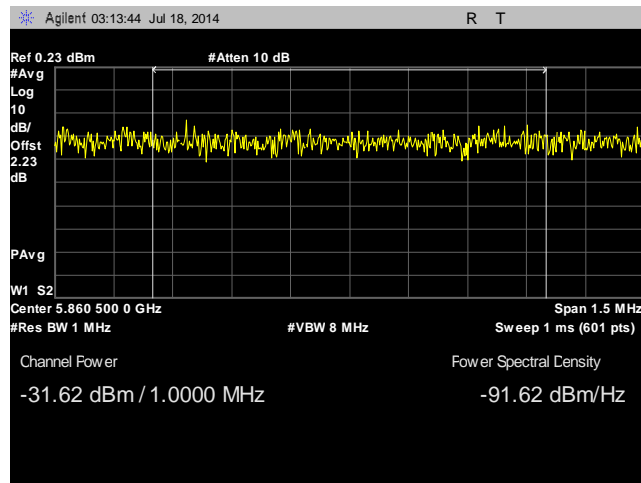

Plot 124. Radiated Spurious Emissions, Band Edge, 5825 MHz, 1 MHz Integration -27dBm

Electromagnetic Compatibility Criteria for Intentional Radiators

§ 15.407(f) RF Exposure

RF Exposure Requirements: §1.1307(b)(1) and §1.1307(b)(2): Systems operating under the provisions of this section shall be operated in a manner that ensures that the public is not exposed to radio frequency energy levels in excess of the Commission’s guidelines.

RF Radiation Exposure Limit: §1.1310: As specified in this section, the Maximum Permissible Exposure (MPE) Limit shall be used to evaluate the environmental impact of human exposure to radiofrequency (RF) radiation as specified in Sec. 1.1307(b), except in the case of portable devices which shall be evaluated according to the provisions of Sec. 2.1093 of this chapter.

5dBi Antenna Configuration:

MPE Limit Calculation: EUT’s operating frequency is 5745 MHz and 5825 MHz;. Highest conducted power = 374.11 mW (i.e. 25.73 dBm). Therefore, **Limit for Uncontrolled exposure: 1 mW/cm²**.

Equation from page 18 of OET 65, Edition 97-01

$$S = P G / 4\pi R^2$$

where,

S = Power Density mW/m²

P = Power (mW)

R = Distance to the center of radiation of the antenna

G = Maximum antenna gain

Maximum antenna gain for EUT = 5 dBi = 3.16

P = 374.11 mW

R = 20 cm

G = 3.16

$$S = 374.11 * 3.16 / 4(3.1416)(20)^2$$

$$S = 0.2351 \text{ mW/cm}^2$$

Therefore, EUT meets the Uncontrolled Exposure limit at 20cm.

13.5dBi Antenna Configuration:

MPE Limit Calculation: EUT's operating frequency is 5745 MHz and 5825 MHz;. Highest conducted power = 157.39 mW (i.e. 21.97 dBm). Therefore, **Limit for Uncontrolled exposure: 1 mW/cm²**.

Equation from page 18 of OET 65, Edition 97-01

$$S = P G / 4\pi R^2$$

where,

S = Power Density mW/m²

P = Power (mW)

R = Distance to the center of radiation of the antenna

G = Maximum antenna gain

Maximum antenna gain for EUT = 13.5 dBi = 22.39

P = 157.39 mW

R = 20 cm

G = 22.39

$$S = 157.39 * 22.39 / 4(3.1416)(20)^2$$

$$S = 0.701425 \text{ mW/cm}^2$$

Therefore, EUT meets the Uncontrolled Exposure limit at 20cm.

IV. Test Equipment

Test Equipment

Calibrated test equipment utilized during testing was maintained in a current state of calibration per the requirements of ISO/IEC 17025:2005.

MET ASSET #	EQUIPMENT	MANUFACTURER	MODEL	LAST CAL DATE	CAL DUE DATE
1T4409	EMI RECEIVER	ROHDE & SCHWARZ	ESIB7	7/16/2012	7/16/2014
1T4818	COMB GENERATOR	COM-POWER	CGO-520	SEE NOTE	
1T4787	HYGROMETER / THERMOMETER / BAROMETER / DEW POINT PEN	CONTROL COMPANY	15-078-198, FB70423, 245CD	2/15/2012	2/15/2014
1T4483	ANTENNA; HORN	EMCO	3115	9/5/2012	3/5/2014
1T4300C	SEMI-ANECHOIC 3M CHAMBER # 1 (VCCI)	EMC TEST SYSTEMS	NONE	1/31/2012	1/31/2015
1T4612	SPECTRUM ANALYZER	AGILENT TECHNOLOGIES	E4407B	7/30/2013	7/30/2014
1T4505	TEMPERATURE CHAMBER	TEST EQUITY	115	1/5/2014	1/5/2015
1T4753	ANTENNA - BILOG	SUNOL SCIENCES	JB6	7/24/2013	1/24/2015

Table 22. Test Equipment List

Note: Functionally tested equipment is verified using calibrated instrumentation at the time of testing.

V. Certification & User's Manual Information

Certification & User's Manual Information

A. Certification Information

The following is extracted from Title 47 of the Code of Federal Regulations, Part 2, Subpart I — Marketing of Radio frequency devices:

§ 2.801 Radio-frequency device defined.

As used in this part, a radio-frequency device is any device which in its operation is capable of Emitting radio-frequency energy by radiation, conduction, or other means. Radio- frequency devices include, but are not limited to:

- (a) The various types of radio communication transmitting devices described throughout this chapter.
- (b) *The incidental, unintentional and intentional radiators defined in Part 15 of this chapter.*
- (c) The industrial, scientific, and medical equipment described in Part 18 of this chapter.
- (d) Any part or component thereof which in use emits radio-frequency energy by radiation, conduction, or other means.

§ 2.803 Marketing of radio frequency devices prior to equipment authorization.

- (a) Except as provided elsewhere in this chapter, no person shall sell or lease, or offer for sale or lease (including advertising for sale or lease), or import, ship or distribute for the purpose of selling or leasing or offering for sale or lease, any radio frequency device unless:
 - (1) In the case of a device subject to certification, such device has been authorized by the Commission in accordance with the rules in this chapter and is properly identified and labeled as required by §2.925 and other relevant sections in this chapter; or
 - (2) In the case of a device that is not required to have a grant of equipment authorization issued by the Commission, but which must comply with the specified technical standards prior to use, such device also complies with all applicable administrative (including verification of the equipment or authorization under a Declaration of Conformity, where required), technical, labeling and identification requirements specified in this chapter.
- (d) Notwithstanding the provisions of paragraph (a) of this section, the offer for sale solely to business, commercial, industrial, scientific or medical users (but not an offer for sale to other parties or to end users located in a residential environment) of a radio frequency device that is in the conceptual, developmental, design or pre-production stage is permitted prior to equipment authorization or, for devices not subject to the equipment authorization requirements, prior to a determination of compliance with the applicable technical requirements *provided* that the prospective buyer is advised in writing at the time of the offer for sale that the equipment is subject to the FCC rules and that the equipment will comply with the appropriate rules before delivery to the buyer or to centers of distribution.

- (e)(1) Notwithstanding the provisions of paragraph (a) of this section, prior to equipment authorization or determination of compliance with the applicable technical requirements any radio frequency device may be operated, but not marketed, for the following purposes and under the following conditions:
- (i) *Compliance testing*;
 - (ii) Demonstrations at a trade show provided the notice contained in paragraph (c) of this section is displayed in a conspicuous location on, or immediately adjacent to, the device;
 - (iii) Demonstrations at an exhibition conducted at a business, commercial, industrial, scientific or medical location, but excluding locations in a residential environment, provided the notice contained in paragraphs (c) or (d) of this section, as appropriate, is displayed in a conspicuous location on, or immediately adjacent to, the device;
 - (iv) Evaluation of product performance and determination of customer acceptability, provided such operation takes place at the manufacturer's facilities during developmental, design or pre-production states; or
 - (v) Evaluation of product performance and determination of customer acceptability where customer acceptability of a radio frequency device cannot be determined at the manufacturer's facilities because of size or unique capability of the device, provided the device is operated at a business, commercial, industrial, scientific or medical user's site, but not at a residential site, during the development, design or pre-production stages.
- (e)(2) For the purpose of paragraphs (e)(1)(iv) and (e)(1)(v) of this section, the term *manufacturer's facilities* includes the facilities of the party responsible for compliance with the regulations and the manufacturer's premises, as well as the facilities of other entities working under the authorization of the responsible party in connection with the development and manufacture, but not the marketing, of the equipment.
- (f) For radio frequency devices subject to verification and sold solely to business, commercial, industrial, scientific and medical users (excluding products sold to other parties or for operation in a residential environment), parties responsible for verification of the devices shall have the option of ensuring compliance with the applicable technical specifications of this chapter at each end user's location after installation, provided that the purchase or lease agreement includes a proviso that such a determination of compliance be made and is the responsibility of the party responsible for verification of the equipment.

Certification & User's Manual Information

The following is extracted from Title 47 of the Code of Federal Regulations, Part 2, Subpart J — Equipment Authorization Procedures:

§ 2.901 Basis and Purpose

- (a) In order to carry out its responsibilities under the Communications Act and the various treaties and international regulations, and in order to promote efficient use of the radio spectrum, the Commission has developed technical standards for radio frequency equipment and parts or components thereof. The technical standards applicable to individual types of equipment are found in that part of the rules governing the service wherein the equipment is to be operated.¹ *In addition to the technical standards provided, the rules governing the service may require that such equipment be verified by the manufacturer or importer, be authorized under a Declaration of Conformity, or receive an equipment authorization from the Commission by one of the following procedures: certification or registration.*
- (b) The following sections describe the verification procedure, the procedure for a Declaration of Conformity, and the procedures to be followed in obtaining certification from the Commission and the conditions attendant to such a grant.

§ 2.907 Certification.

- (a) Certification is an equipment authorization issued by the Commission, based on representation and test data submitted by the applicant.
- (b) Certification attaches to all units subsequently marketed by the grantee which are identical (see Section 2.908) to the sample tested except for permissive changes or other variations authorized by the Commission pursuant to Section 2.1043.

¹ In this case, the equipment is subject to the rules of Part 15. More specifically, the equipment falls under Subpart B (of Part 15), which deals with unintentional radiators.

Certification & User's Manual Information

§ 2.948 Description of measurement facilities.

- (a) Each party making measurements of equipment that is subject to an equipment authorization under Part 15 or Part 18 of this chapter, regardless of whether the measurements are filed with the Commission or kept on file by the party responsible for compliance of equipment marketed within the U.S. or its possessions, shall compile a description of the measurement facilities employed.
- (1) If the measured equipment is subject to the verification procedure, the description of the measurement facilities shall be retained by the party responsible for verification of the equipment.
- (i) *If the equipment is verified through measurements performed by an independent laboratory, it is acceptable for the party responsible for verification of the equipment to rely upon the description of the measurement facilities retained by or placed on file with the Commission by that laboratory. In this situation, the party responsible for the verification of the equipment is not required to retain a duplicate copy of the description of the measurement facilities.*
- (ii) If the equipment is verified based on measurements performed at the installation site of the equipment, no specific site calibration data is required. It is acceptable to retain the description of the measurement facilities at the site at which the measurements were performed.
- (2) If the equipment is to be authorized by the Commission under the certification procedure, the description of the measurement facilities shall be filed with the Commission's Laboratory in Columbia, Maryland. The data describing the measurement facilities need only be filed once but must be updated as changes are made to the measurement facilities or as otherwise described in this section. At least every three years, the organization responsible for filing the data with the Commission shall certify that the data on file is current.

Certification & User's Manual Information

Label and User's Manual Information

The following is extracted from Title 47 of the Code of Federal Regulations, Part 15, Subpart A — General:

§ 15.19 Labeling requirements.

(a) *In addition to the requirements in Part 2 of this chapter, a device subject to certification or verification shall be labeled as follows:*

- (1) Receivers associated with the operation of a licensed radio service, e.g., FM broadcast under Part 73 of this chapter, land mobile operation under Part 90, etc., shall bear the following statement in a conspicuous location on the device:

This device complies with Part 15 of the FCC Rules. Operation is subject to the condition that this device does not cause harmful interference.

- (2) A stand-alone cable input selector switch, shall bear the following statement in a conspicuous location on the device:

This device is verified to comply with Part 15 of the FCC Rules for use with cable television service.

- (3) All other devices shall bear the following statement in a conspicuous location on the device:

This device complies with Part 15 of the FCC Rules. Operation is subject to the following two conditions: (1) This device may not cause harmful interference, and (2) this device must accept any interference received, including interference that may cause undesired operation.

- (4) Where a device is constructed in two or more sections connected by wires and marketed together, the statement specified under paragraph (a) of this section is required to be affixed only to the main control unit.

- (5) When the device is so small or for such use that it is not practicable to place the statement specified under paragraph (a) of this section on it, the information required by this paragraph shall be placed in a prominent location in the instruction manual or pamphlet supplied to the user or, alternatively, shall be placed on the container in which the device is marketed. However, the FCC identifier or the unique identifier, as appropriate, must be displayed on the device.

§ 15.21 Information to user.

The users manual or instruction manual for an intentional or unintentional radiator shall caution the user that changes or modifications not expressly approved by the party responsible for compliance could void the user's authority to operate the equipment.

Verification & User's Manual Information

The following is extracted from Title 47 of the Code of Federal Regulations, Part 15, Subpart B — Unintentional Radiators:

§ 15.105 Information to the user.

- (a) For a Class A digital device or peripheral, the instructions furnished the user shall include the following or similar statement, placed in a prominent location in the text of the manual:

Note: This equipment has been tested and found to comply with the limits for a Class A digital device, pursuant to Part 15 of the FCC Rules. These limits are designed to provide reasonable protection against harmful interference when the equipment is operated in a commercial environment. This equipment generates, uses, and can radiate radio frequency energy and, if not installed and used in accordance with the instruction manual, may cause harmful interference to radio communications. Operation of this equipment in a residential area is likely to cause harmful interference in which case the user will be required to correct the interference at own expense.

- (b) For a Class B digital device or peripheral, the instructions furnished the user shall include the following or similar statement, placed in a prominent location in the text of the manual:

Note: This equipment has been tested and found to comply with the limits for a Class B digital device, pursuant to Part 15 of the FCC Rules. These limits are designed to provide reasonable protection against harmful interference when the equipment is operated in a residential environment. This equipment generates, uses, and can radiate radio frequency energy and, if not installed and used in accordance with the instruction manual, may cause harmful interference to radio communications. However, there is no guarantee that interference will not occur in a particular installation. If this equipment does cause harmful interference to radio or television reception, which can be determined by turning the equipment off and on, the user is encouraged to try to correct the interference by one or more of the following measures:

- Reorient or relocate the receiving antenna.
- Increase the separation between the equipment and receiver.
- Connect the equipment into an outlet on a circuit different from that to which the receiver is connected.
- Consult the dealer or an experienced radio/TV technician for help.

ICES-003 Procedural & Labeling Requirements

From the Industry Canada Electromagnetic Compatibility Advisory Bulletin entitled, "Implementation and Interpretation of the Interference-Causing Equipment Standard for Digital Apparatus, ICES-003" (EMCAB-3, Issue 2, July 1995):

"At present, CISPR 22: 2002 and ICES technical requirements are essentially equivalent. Therefore, if you have CISPR 22: 2002 approval by meeting CISPR Publication 22, the only additional requirements are: to attach a note to the report of the test results for compliance, indicating that these results are deemed satisfactory evidence of compliance with ICES-003 of the Canadian Interference-Causing Equipment Regulations; to maintain these records on file for the requisite five year period; and to provide the device with a notice of compliance in accordance with ICES-003."

Procedural Requirements:

According to Industry Canada's Interference Causing Equipment Standard for Digital Apparatus ICES-003 Issue 5 August 2012:

- Section 6.1: A record of the measurements and results, showing the date that the measurements were completed, shall be retained by the manufacturer or importer for a period of at least five years from the date shown in the record and made available for examination on the request of the Minister.
- Section 6.2: A written notice indicating compliance must accompany each unit of digital apparatus to the end user. The notice shall be in the form of a label that is affixed to the apparatus. Where because of insufficient space or other constraints it is not feasible to affix a label to the apparatus, the notice may be in the form of a statement in the users' manual.

Labeling Requirements:

The suggested text for the notice, in English and in French, is provided below, from the Annex of ICES-003:

This Class [²] digital apparatus complies with Canadian ICES-003.

Cet appareil numérique de la classe [¹] est conforme à la norme NMB-003 du Canada.

² Insert either A or B but not both as appropriate for the equipment requirements.



Amimon
MAGLAN

Electromagnetic Compatibility
End of Report
CFR Title 47, Part 15B, 15.407; RSS-210, Issue 8, Dec. 2010 & ICES-003

End of Report