



# SAR TEST REPORT

No. I14N01237-SAR

For

**Shenzhen Sang Fei Consumer Communications Co., Ltd.**

**WCDMA/GSM digital mobile phone**

**PHILIPS S398**

With

**Hardware Version: WMBUa**

**Software Version: S398\_M6582K\_1443\_V01A\_AM\_FCC**

**FCC ID: VQRCTS398**

**Issued Date: 2014-11-24**

**Note:**

The test results in this test report relate only to the devices specified in this report. This report shall not be reproduced except in full without the written approval of TMC Beijing.

**Test Laboratory:**

TMC Beijing, Telecommunication Metrology Center of MIIT

No. 52, Huayuan Bei Road, Haidian District, Beijing, P. R. China 100191.

Tel:+86(0)10-62304633-2079, Fax:+86(0)10-62304633 Email:welcome@emcite.com. [www.emcite.com](http://www.emcite.com)

### Revision Version

Report Number	Revision	Date	Memo
I14N01237-SAR	00	2014-11-24	Initial creation of test report

## TABLE OF CONTENT

<b>1 TEST LABORATORY .....</b>	<b>6</b>
1.1 TESTING LOCATION .....	6
1.2 TESTING ENVIRONMENT.....	6
1.3 PROJECT DATA .....	6
1.4 SIGNATURE.....	6
<b>2 CLIENT INFORMATION .....</b>	<b>7</b>
2.1 APPLICANT INFORMATION .....	7
2.2 MANUFACTURER INFORMATION .....	7
<b>3 EQUIPMENT UNDER TEST (EUT) AND ANCILLARY EQUIPMENT (AE) .....</b>	<b>8</b>
3.1 ABOUT EUT .....	8
3.2 INTERNAL IDENTIFICATION OF EUT USED DURING THE TEST .....	8
3.3 INTERNAL IDENTIFICATION OF AE USED DURING THE TEST .....	8
<b>4 STATEMENT OF COMPLIANCE .....</b>	<b>9</b>
<b>5 TEST METHODOLOGY .....</b>	<b>10</b>
5.1 APPLICABLE LIMIT REGULATIONS .....	10
5.2 APPLICABLE MEASUREMENT STANDARDS.....	10
<b>6 SPECIFIC ABSORPTION RATE (SAR).....</b>	<b>11</b>
6.1 INTRODUCTION.....	11
6.2 SAR DEFINITION.....	11
<b>7 TISSUE SIMULATING LIQUIDS .....</b>	<b>12</b>
7.1 TARGETS FOR TISSUE SIMULATING LIQUID .....	12
7.2 DIELECTRIC PERFORMANCE .....	12
<b>8 SYSTEM VERIFICATION .....</b>	<b>16</b>
8.1 SYSTEM SETUP.....	16
8.2 SYSTEM VERIFICATION.....	17
<b>9 MEASUREMENT PROCEDURES .....</b>	<b>18</b>
9.1 TESTS TO BE PERFORMED .....	18
9.2 GENERAL MEASUREMENT PROCEDURE.....	19
9.3 WCDMA MEASUREMENT PROCEDURES FOR SAR .....	20
9.4 BLUETOOTH & WI-FI MEASUREMENT PROCEDURES FOR SAR .....	21
9.5 POWER DRIFT.....	21
<b>10 AREA SCAN BASED 1-G SAR.....</b>	<b>22</b>
10.1 REQUIREMENT OF KDB.....	22
10.2 FAST SAR ALGORITHMS .....	22
<b>11 CONDUCTED OUTPUT POWER.....</b>	<b>23</b>

11.1 MANUFACTURING TOLERANCE .....	23
11.2 GSM MEASUREMENT RESULT .....	24
12.2 WCDMA MEASUREMENT RESULT .....	26
11.4 WI-FI AND BT MEASUREMENT RESULT .....	26
<b>12 SIMULTANEOUS TX SAR CONSIDERATIONS.....</b>	<b>27</b>
12.1 INTRODUCTION.....	27
12.2 TRANSMIT ANTENNA SEPARATION DISTANCES .....	27
12.3 SAR MEASUREMENT POSITIONS .....	27
12.4 STANDALONE SAR TEST EXCLUSION CONSIDERATIONS .....	28
<b>13 EVALUATION OF SIMULTANEOUS.....</b>	<b>29</b>
<b>14 SAR TEST RESULT .....</b>	<b>30</b>
14.1 SAR RESULTS FOR FAST SAR.....	31
14.2 SAR RESULTS FOR STANDARD PROCEDURE.....	36
<b>15 SAR MEASUREMENT VARIABILITY.....</b>	<b>38</b>
<b>16 MEASUREMENT UNCERTAINTY .....</b>	<b>39</b>
16.1 MEASUREMENT UNCERTAINTY FOR NORMAL SAR TESTS (300MHZ~3GHZ) .....	39
16.3 MEASUREMENT UNCERTAINTY FOR FAST SAR TESTS (300MHZ~3GHZ) .....	40
<b>17 MAIN TEST INSTRUMENTS.....</b>	<b>41</b>
<b>ANNEX A GRAPH RESULTS.....</b>	<b>42</b>
<b>ANNEX B SYSTEM VERIFICATION RESULTS .....</b>	<b>62</b>
<b>ANNEX C SAR MEASUREMENT SETUP .....</b>	<b>69</b>
C.1 MEASUREMENT SET-UP .....	69
C.2 DASY4 OR DASY5 E-FIELD PROBE SYSTEM .....	70
C.3 E-FIELD PROBE CALIBRATION .....	70
C.4 OTHER TEST EQUIPMENT.....	71
C.4.1 DATA ACQUISITION ELECTRONICS(DAE) .....	71
C.4.2 ROBOT.....	72
C.4.3 MEASUREMENT SERVER.....	72
C.4.4 DEVICE HOLDER FOR PHANTOM.....	73
C.4.5 PHANTOM.....	73
<b>ANNEX D POSITION OF THE WIRELESS DEVICE IN RELATION TO THE PHANTOM .....</b>	<b>75</b>
D.1 GENERAL CONSIDERATIONS.....	75
D.2 BODY-WORN DEVICE .....	76
D.3 DESKTOP DEVICE.....	76
D.4 DUT SETUP PHOTOS.....	77
<b>ANNEX E EQUIVALENT MEDIA RECIPES.....</b>	<b>78</b>
<b>ANNEX F SYSTEM VALIDATION .....</b>	<b>79</b>
<b>ANNEX G PROBE CALIBRATION CERTIFICATE.....</b>	<b>80</b>



**ANNEX H DIPOLE CALIBRATION CERTIFICATE .....91**

## 1 Test Laboratory

### 1.1 Testing Location

Company Name: TMC Shenzhen, Telecommunication Metrology Center of MIIT  
Address: No. 12building, Shangsha Innovation and Technology Park, Futian District, Shenzhen, P. R. China  
Postal Code: 518048  
Telephone: +86-755-33322000  
Fax: +86-755-33322001

### 1.2 Testing Environment

Temperature: 18°C~25 °C,  
Relative humidity: 30%~ 70%  
Ground system resistance: < 0.5 Ω  
Ambient noise & Reflection: < 0.012 W/kg

### 1.3 Project Data

Project Leader: Zhang Bojun  
Test Engineer: Zhang Yan  
Testing Start Date: October 29<sup>th</sup>, 2014  
Testing End Date: November 5<sup>th</sup>, 2014

### 1.4 Signature



---

Zhang Yan

(Prepared this test report)

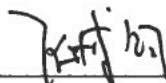

---

Zhang Bojun

(Reviewed this test report)



---

Lu Minniu

Director of the laboratory

(Approved this test report)

## 2 Client Information

### 2.1 Applicant Information

Company Name:	Shenzhen Sang Fei Consumer Communications Co., Ltd.
Address /Post:	11 Science and Technology Road, Shenzhen Hi-tech Industrial Park Nanshan District, Shenzhen, PRC
City:	Shenzhen
Postal Code:	518000
Country:	P.R.China
Contact:	Helen Lin
Email:	Helen.Lin@sangfei.com
Telephone:	0755-26633217
Fax:	0755-26635272

### 2.2 Manufacturer Information

Company Name:	Shenzhen Sang Fei Consumer Communications Co., Ltd.
Address /Post:	11 Science and Technology Road, Shenzhen Hi-tech Industrial Park Nanshan District, Shenzhen, PRC
City:	Shenzhen
Postal Code:	518000
Country:	P.R.China
Contact:	Helen Lin
Email:	Helen.Lin@sangfei.com
Telephone:	0755-26633217
Fax:	0755-26635272

### 3 Equipment Under Test (EUT) and Ancillary Equipment (AE)

#### 3.1 About EUT

Description:	WCDMA/GSM digital mobile phone
Model name:	Philips S398
Marketing name:	Philips S398
Operating mode(s):	GSM 850/1900, WCDMA 850/1900, WiFi, BT
Tested Tx Frequency:	824.2 – 848.8 MHz (GSM 850)
	1850.2 – 1909.8 MHz (GSM 1900)
	826.4-846.6MHz(WCDMA 850)
	1852.4-1908MHz(WCDMA 1900)
Test Modulation	(GSM)GMSK
GPRS class	12
GPRS capability Class:	B
EGPRS Multislot Class:	12, Downlink only
Power class:	GSM850: tested with power level 5
	GSM1900: tested with power level 0
	WCDMA: class 3, tested with power control all up bits
Test device Production information:	Production unit
Device type:	Portable device
Antenna type:	Integrated antenna
Accessories/Body-worn configurations:	/
Hotspot mode:	/
Form factor:	14.2cm × 7.1cm

#### 3.2 Internal Identification of EUT used during the test

EUT ID*	SN or IMEI	HW Version	SW Version
EUT1	IMEI1: 864359026300603 IMEI2:864359026800602	WMBUa	S398_M6582K_1443_V01A_AM_FCC

\*EUT ID: is used to identify the test sample in the lab internally.

#### 3.3 Internal Identification of AE used during the test

AE ID*	Description	Model	SN	Manufacturer
AE1	Battery	AB2040WMC	/	Zhuhai Coslight Power Co.,Ltd
AE2	Headset	TJ-100787	/	Dongguan Tenji Industrial CO.,LTD

\*AE ID: is used to identify the test sample in the lab internally.



## 4 Statement of Compliance

The maximum results of Specific Absorption Rate (SAR) found during testing for Shenzhen Sang Fei Consumer Communications Co., Ltd. WCDMA digital mobile phone PHILIPS S398 are as follows:

**Table 4.1: Highest Reported SAR (1g)**

Exposure Configuration	Technology Band	Highest Reported SAR 1g (W/Kg)	Equipment Class
Head (Separation Distance 0mm)	EGSM 850	0.533	PCE
	PCS 1900	0.321	
	WCDMA 850	0.480	
	WCDMA 1900	0.502	
	WiFi 2.4GHz	0.657	
Body-worn (Separation Distance 10mm)	EGSM 850	1.038	PCE
	PCS 1900	<b>1.044</b>	
	WCDMA 850	0.497	
	WCDMA 1900	1.006	
	WiFi 2.4GHz	0.310	

The SAR values found for the Mobile Phone are below the maximum recommended levels of 1.6 W/Kg as averaged over any 1g tissue according to the ANSI C95.1-1999.

For body worn operation, this device has been tested and meets FCC RF exposure guidelines when used with any accessory that contains no metal and which provides a minimum separation distance of 10 mm between this device and the body of the user. Use of other accessories may not ensure compliance with FCC RF exposure guidelines.

The EUT battery must be fully charged and checked periodically during the test to ascertain uniform power output.

The measurement together with the test system set-up is described in annex C of this test report. A detailed description of the equipment under test can be found in chapter 4 of this test report.

The highest reported SAR value is obtained at the case of **Table 4.1**, and the values are: **1.044 W/kg (1g)**.

**Table 4.2: The sum of reported SAR values for main antenna and WiFi**

	Position	Main antenna (W/Kg)	WiFi(W/Kg)	Sum(W/Kg)
<b>Highest reported SAR value for Head</b>	Left hand, Touch cheek	0.533	0.657	1.190
<b>Highest reported SAR value for Body</b>	Rear	1.044	0.310	1.354

Note: The distance between the EUT and the phantom bottom is 10mm.

**Table 4.3: The sum of reported SAR values for main antenna and Bluetooth**

	Position	Main antenna (W/Kg)	BT*(W/Kg)	Sum(W/Kg)
<b>Highest reported SAR value for Head</b>	Left hand, Touch cheek	1.190	0.079	1.269
<b>Highest reported SAR value for Body</b>	Rear	1.354	0.039	<b>1.393</b>

BT\* - Estimated SAR for Bluetooth (see the table 13.2)

According to the above tables, the maximum sum of reported SAR values is **1.393 W/kg (1g)**. The detail for simultaneous transmission consideration is described in chapter 13.

## 5 TEST METHODOLOGY

### 5.1 Applicable Limit Regulations

**ANSI C95.1–1999:** IEEE Standard for Safety Levels with Respect to Human Exposure to Radio Frequency Electromagnetic Fields, 3 kHz to 300 GHz.

It specifies the maximum exposure limit of **1.6 W/kg** as averaged over any 1 gram of tissue for portable devices being used within 20 cm of the user in the uncontrolled environment.

### .2 Applicable Measurement Standards

**IEEE 1528–2013:** Recommended Practice for Determining the Peak Spatial-Average Specific Absorption Rate (SAR) in the Human Body Due to Wireless Communications Devices: Experimental Techniques.

**KDB447498 D01: General RF Exposure Guidance v05r02:** Mobile and Portable Devices RF Exposure Procedures and Equipment Authorization Policies.

**KDB648474 D04 Handset SAR v01r02:** SAR Evaluation Considerations for Wireless Handsets.

**KDB941225 D06:** SAR Evaluation Procedures for Portable Devices with Wireless Router Capabilities

**KDB248227 D01 Hotspot Mode SAR v02 r03:** SAR Measurement Procedures for 802.11a/b/g transmitters.

**KDB 865664 D01 SAR measurement 100 MHz to 6 GHz v01r03:** SAR Measurement Requirements for 100 MHz to 6 GHz

**KDB 865664 D02 RF Exposure Reporting v01r01:** RF Exposure Compliance Reporting and Documentation Considerations

## 6 Specific Absorption Rate (SAR)

### 6.1 Introduction

SAR is related to the rate at which energy is absorbed per unit mass in an object exposed to a radio field. The SAR distribution in a biological body is complicated and is usually carried out by experimental techniques or numerical modeling. The standard recommends limits for two tiers of groups, occupational/controlled and general population/uncontrolled, based on a person's awareness and ability to exercise control over his or her exposure. In general, occupational/controlled exposure limits are higher than the limits for general population/uncontrolled.

### 6.2 SAR Definition

The SAR definition is the time derivative (rate) of the incremental energy ( $dW$ ) absorbed by (dissipated in) an incremental mass ( $dm$ ) contained in a volume element ( $dv$ ) of a given density ( $\rho$ ). The equation description is as below:

$$SAR = \frac{d}{dt} \left( \frac{dW}{dm} \right) = \frac{d}{dt} \left( \frac{dW}{\rho dv} \right)$$

SAR is expressed in units of Watts per kilogram (W/kg)

SAR measurement can be either related to the temperature elevation in tissue by

$$SAR = c \left( \frac{\delta T}{\delta t} \right)$$

Where:  $C$  is the specific heat capacity,  $\delta T$  is the temperature rise and  $\delta t$  is the exposure duration, or related to the electrical field in the tissue by

$$SAR = \frac{\sigma |E|^2}{\rho}$$

Where:  $\sigma$  is the conductivity of the tissue,  $\rho$  is the mass density of tissue and  $E$  is the RMS electrical field strength.

However for evaluating SAR of low power transmitter, electrical field measurement is typically applied.

## 7 Tissue Simulating Liquids

### 7.1 Targets for tissue simulating liquid

**Table 7.1: Targets for tissue simulating liquid**

Frequency (MHz)	Liquid Type	Conductivity ( $\sigma$ )	$\pm 5\%$ Range	Permittivity ( $\epsilon$ )	$\pm 5\%$ Range
835	Head	0.90	0.86~0.95	41.5	39.4~43.6
835	Body	0.97	0.92~1.02	55.2	52.4~58.0
1900	Head	1.40	1.33~1.47	40.0	38.0~42.0
1900	Body	1.52	1.44~1.60	53.3	50.6~56.0
2450	Head	1.80	1.71~1.89	39.2	37.3~41.1
2450	Body	1.95	1.85~2.05	52.7	50.1~55.3

### 7.2 Dielectric Performance

**Table 7.2: Dielectric Performance of Tissue Simulating Liquid**

Measurement Date (yyyy-mm-dd)	Type	Frequency	Permittivity $\epsilon$	Drift (%)	Conductivity $\sigma$ (S/m)	Drift (%)
2014-11-05	Head	835 MHz	41.86	0.87	0.91	1.11
2014-11-03	Body	835 MHz	55.11	-0.16	1.00	3.09
2014-11-04	Head	1900 MHz	41.19	2.97	1.40	0.00
2014-10-30	Body	1900 MHz	52.62	-1.28	1.51	-0.66
2014-11-19	Head	2450 MHz	38.57	-1.61	1.88	4.44
2014-10-29	Body	2450 MHz	52.67	-0.06	1.89	-3.08

Note: The liquid temperature is 22.0°C

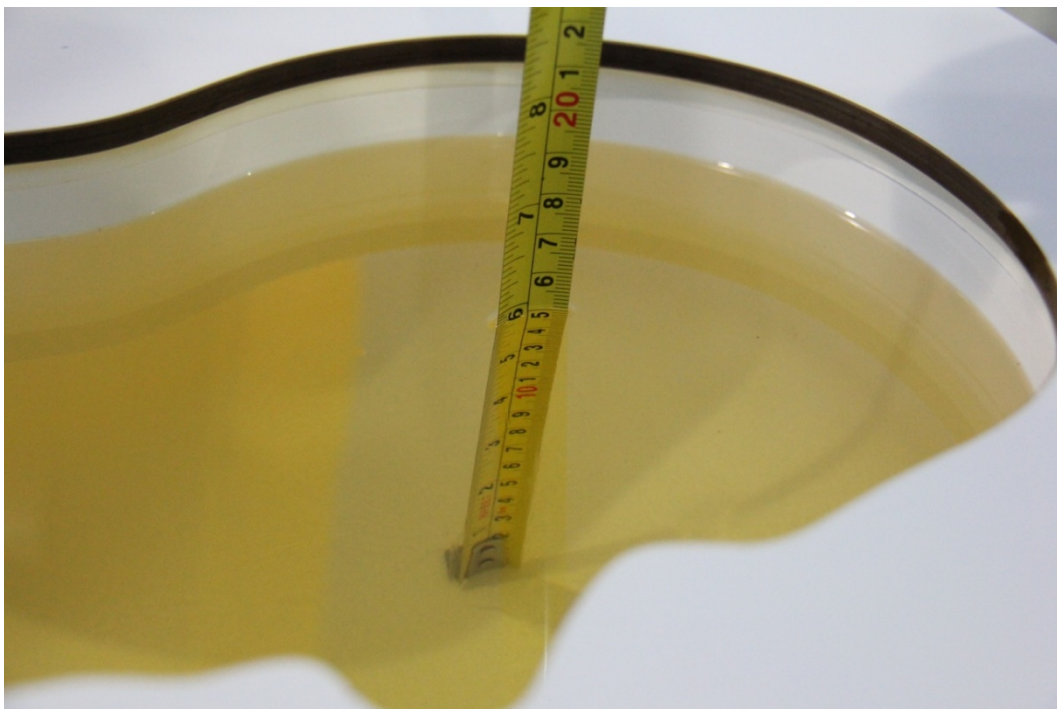

**Picture 7-1: Liquid depth in the Phantom (850 MHz Head)**

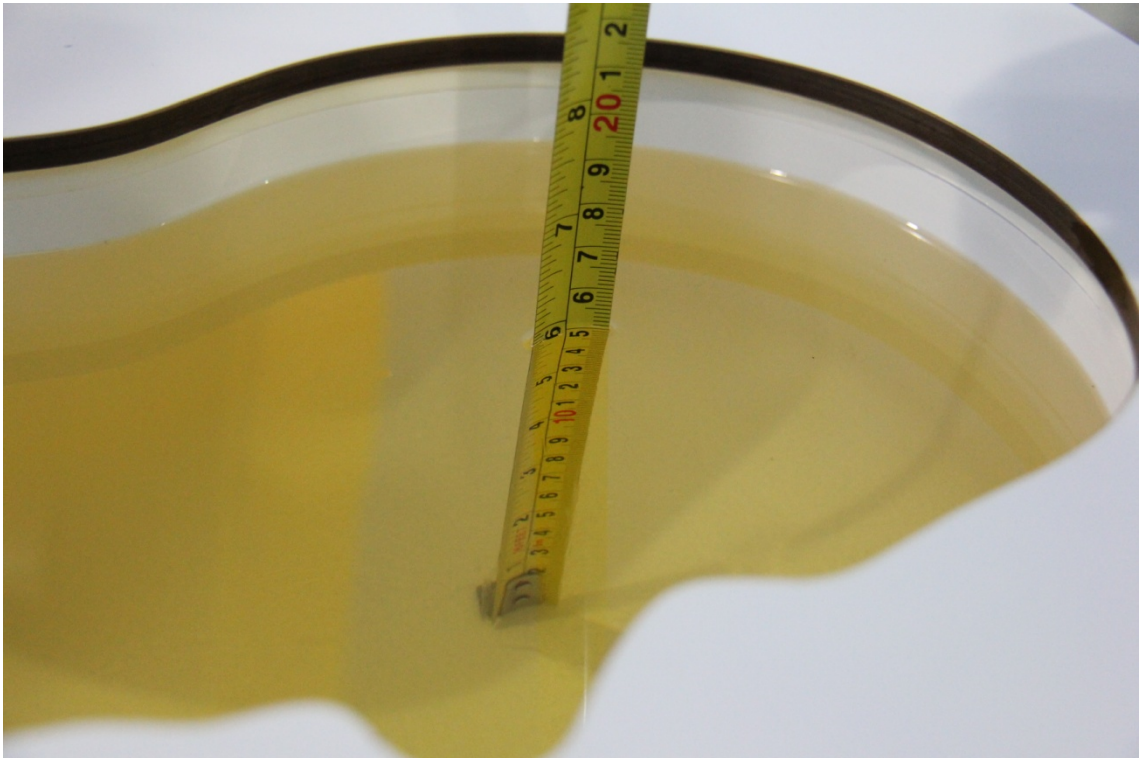

**Picture 7-1: Liquid depth in the Phantom (850 MHz body)**

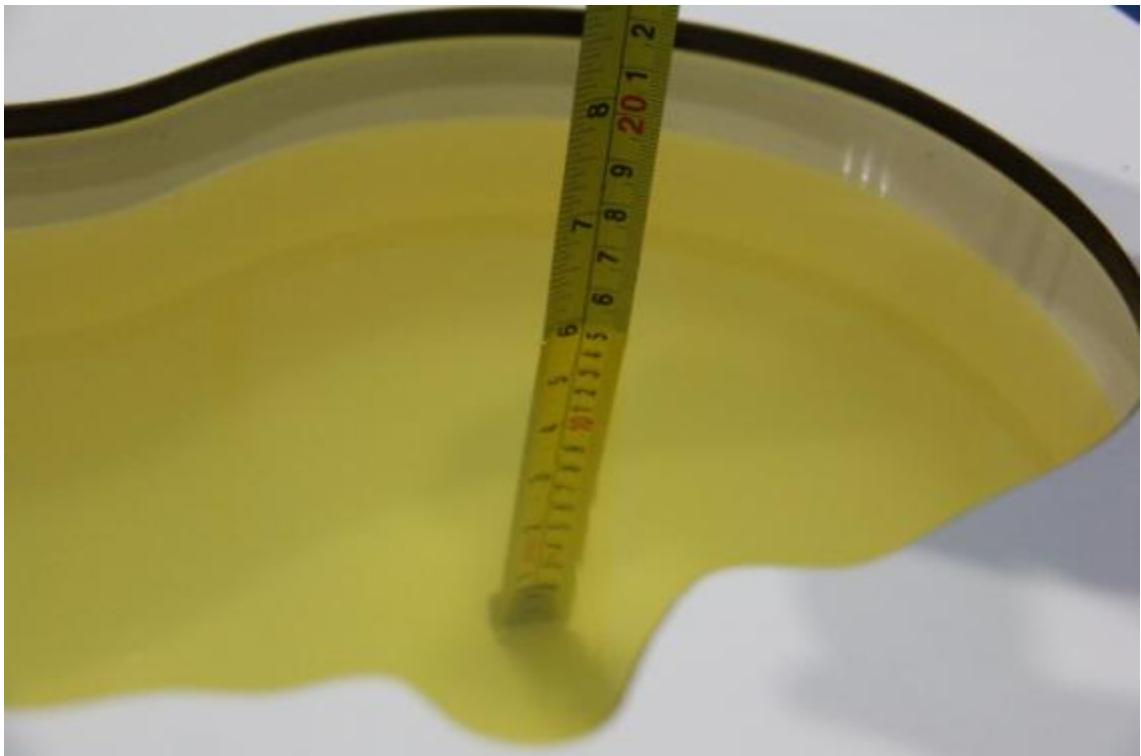

**Picture 7-1: Liquid depth in the Phantom (1900 MHz Head)**



**Picture 7-2: Liquid depth in the Flat Phantom (1900 MHz body)**



**Liquid depth in the Head Phantom (2450 MHz Head)**



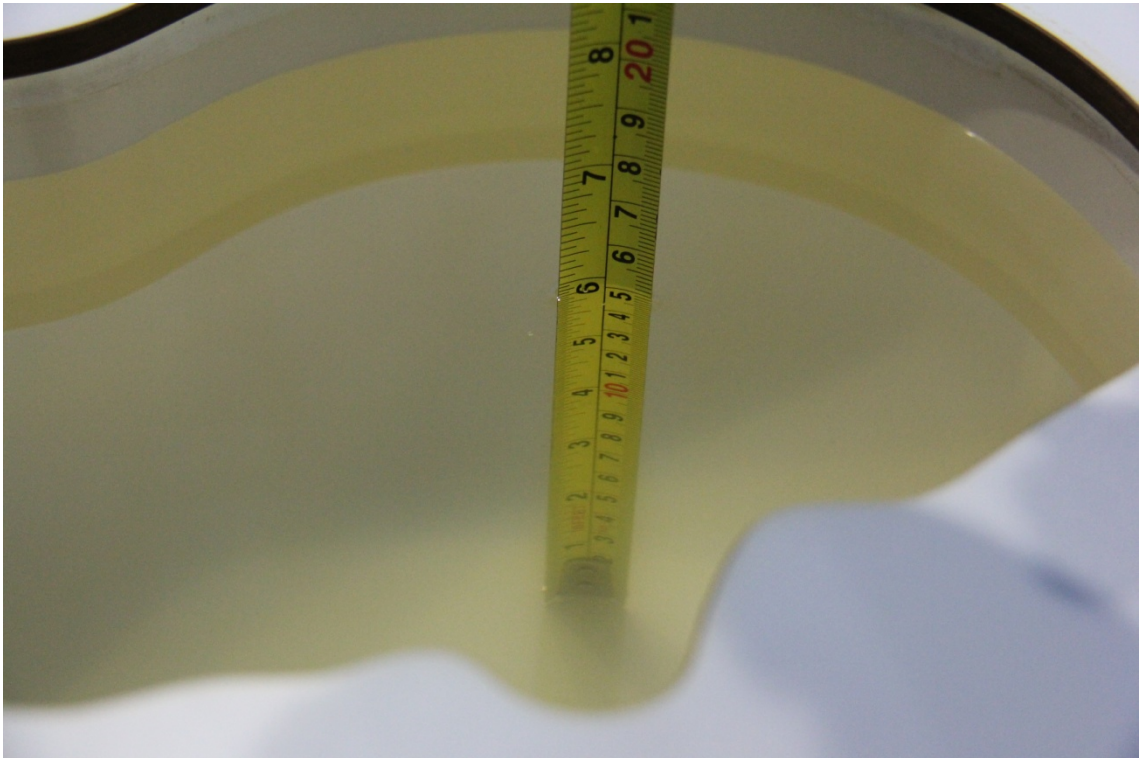

**Liquid depth in the Head Phantom (2450 MHz body)**

## 8 System verification

### 8.1 System Setup

In the simplified setup for system evaluation, the DUT is replaced by a calibrated dipole and the power source is replaced by a continuous wave that comes from a signal generator. The calibrated dipole must be placed beneath the flat phantom section of the SAM twin phantom with the correct distance holder. The distance holder should touch the phantom surface with a light pressure at the reference marking and be oriented parallel to the long side of the phantom. The equipment setup is shown below:

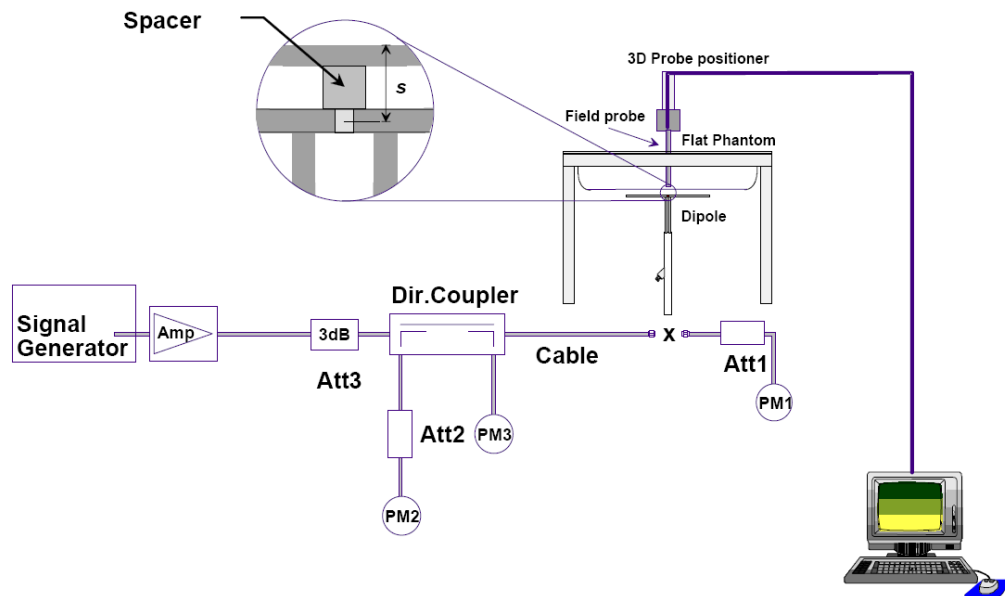

Picture 8.1 System Setup for System Evaluation

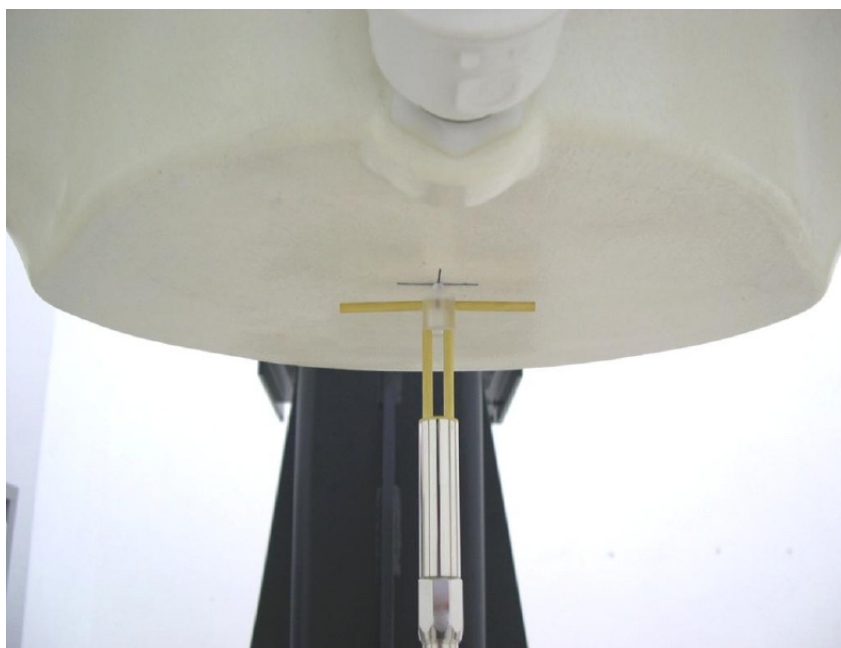

Picture 8.2 Photo of Dipole Setup



## 8.2 System Verification

SAR system verification is required to confirm measurement accuracy, according to the tissue dielectric media, probe calibration points and other system operating parameters required for measuring the SAR of a test device. The system verification must be performed for each frequency band and within the valid range of each probe calibration point required for testing the device.

The system verification results are required that the area scan estimated 1-g SAR is within 3% of the zoom scan 1-g SAR. The details are presented in annex B.

**Table 8.1: System Verification of Head**

Measurement Date (yyyy-mm-dd)	Frequency	Target value (W/kg)		Measured value (W/kg)		Deviation	
		10 g Average	1 g Average	10 g Average	1 g Average	10 g Average	1 g Average
2014-11-05	850 MHz	1.60	2.44	1.61	2.44	0.63%	0.00%
2014-11-04	1900 MHz	5.19	9.86	5.2	10.1	0.19%	2.43%
2014-11-19	2450 MHz	6.14	13.20	6.35	12.8	3.42%	-3.03%

**Table 8.2: System Verification of Body**

Measurement Date (yyyy-mm-dd)	Frequency	Target value (W/kg)		Measured value (W/kg)		Deviation	
		10 g Average	1 g Average	10 g Average	1 g Average	10 g Average	1 g Average
2014-11-03	850 MHz	1.59	2.43	1.59	2.42	0.00%	-0.41%
2014-10-30	1900 MHz	5.40	10.20	5.41	10.3	0.19%	0.98%
2014-10-29	2450 MHz	6.01	13.00	6.22	12.95	3.49%	-0.38%

## 9 Measurement Procedures

### 9.1 Tests to be performed

In order to determine the highest value of the peak spatial-average SAR of a handset, all device positions, configurations and operational modes shall be tested for each frequency band according to steps 1 to 3 below. A flowchart of the test process is shown in picture 9.1.

**Step 1:** The tests described in 9.2 shall be performed at the channel that is closest to the centre of the transmit frequency band ( $f_c$ ) for:

- a) all device positions (cheek and tilt, for both left and right sides of the SAM phantom, as described in annex D),
- b) all configurations for each device position in a), e.g., antenna extended and retracted, and
- c) all operational modes, e.g., analogue and digital, for each device position in a) and configuration in b) in each frequency band.

If more than three frequencies need to be tested according to 11.1 (i.e.,  $N_c > 3$ ), then all frequencies, configurations and modes shall be tested for all of the above test conditions.

**Step 2:** For the condition providing highest peak spatial-average SAR determined in Step 1, perform all tests described in 9.2 at all other test frequencies, i.e., lowest and highest frequencies. In addition, for all other conditions (device position, configuration and operational mode) where the peak spatial-average SAR value determined in Step 1 is within 3 dB of the applicable SAR limit, it is recommended that all other test frequencies shall be tested as well.

**Step 3:** Examine all data to determine the highest value of the peak spatial-average SAR found in Steps 1 to 2.

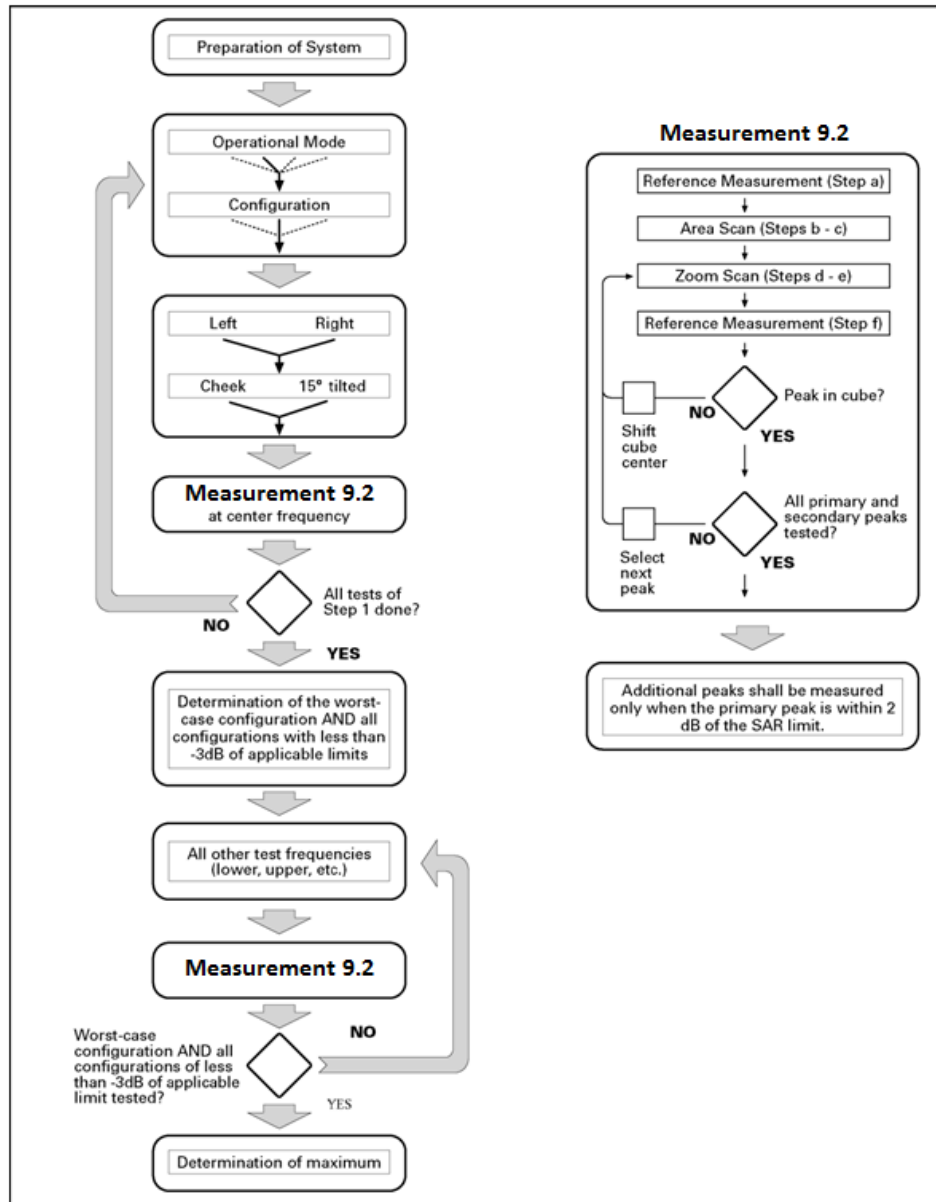

Picture 9.1 Block diagram of the tests to be performed

## 9.2 General Measurement Procedure

The area and zoom scan resolutions specified in the table below must be applied to the SAR measurements and fully documented in SAR reports to qualify for TCB approval. Probe boundary effect error compensation is required for measurements with the probe tip closer than half a probe tip diameter to the phantom surface. Both the probe tip diameter and sensor offset distance must satisfy measurement protocols; to ensure probe boundary effect errors are minimized and the higher fields closest to the phantom surface can be correctly measured and extrapolated to the phantom surface for computing 1-g SAR. Tolerances of the post-processing algorithms must be verified by the test laboratory for the scan resolutions used in the SAR measurements, according to the reference distribution functions specified in IEEE Std 1528-2003. The results should be documented as part of the system validation records and may be requested to support test results

when all the measurement parameters in the following table are not satisfied.

		$\leq 3$ GHz	$> 3$ GHz
Maximum distance from closest measurement point (geometric center of probe sensors) to phantom surface		$5 \pm 1$ mm	$\frac{1}{2} \delta \ln(2) \pm 0.5$ mm
Maximum probe angle from probe axis to phantom surface normal at the measurement location		$30^\circ \pm 1^\circ$	$20^\circ \pm 1^\circ$
Maximum area scan spatial resolution: $\Delta x_{Area}, \Delta y_{Area}$		$\leq 2$ GHz: $\leq 15$ mm 2 – 3 GHz: $\leq 12$ mm	3 – 4 GHz: $\leq 12$ mm 4 – 6 GHz: $\leq 10$ mm
		When the x or y dimension of the test device, in the measurement plane orientation, is smaller than the above, the measurement resolution must be $\leq$ the corresponding x or y dimension of the test device with at least one measurement point on the test device.	
Maximum zoom scan spatial resolution: $\Delta x_{Zoom}, \Delta y_{Zoom}$		$\leq 2$ GHz: $\leq 8$ mm 2 – 3 GHz: $\leq 5$ mm*	3 – 4 GHz: $\leq 5$ mm* 4 – 6 GHz: $\leq 4$ mm*
Maximum zoom scan spatial resolution, normal to phantom surface	uniform grid: $\Delta z_{Zoom}(n)$	$\leq 5$ mm	3 – 4 GHz: $\leq 4$ mm 4 – 5 GHz: $\leq 3$ mm 5 – 6 GHz: $\leq 2$ mm
	graded grid $\Delta z_{Zoom}(1)$ : between 1 <sup>st</sup> two points closest to phantom surface	$\leq 4$ mm	3 – 4 GHz: $\leq 3$ mm 4 – 5 GHz: $\leq 2.5$ mm 5 – 6 GHz: $\leq 2$ mm
	$\Delta z_{Zoom}(n>1)$ : between subsequent points	$\leq 1.5 \cdot \Delta z_{Zoom}(n-1)$	
Minimum zoom scan volume	x, y, z	$\geq 30$ mm	3 – 4 GHz: $\geq 28$ mm 4 – 5 GHz: $\geq 25$ mm 5 – 6 GHz: $\geq 22$ mm
Note: $\delta$ is the penetration depth of a plane-wave at normal incidence to the tissue medium; see draft standard IEEE P1528-2011 for details. * When zoom scan is required and the <i>reported</i> SAR from the area scan based <i>I-g SAR estimation</i> procedures of KDB 447498 is $\leq 1.4$ W/kg, $\leq 8$ mm, $\leq 7$ mm and $\leq 5$ mm zoom scan resolution may be applied, respectively, for 2 GHz to 3 GHz, 3 GHz to 4 GHz and 4 GHz to 6 GHz.			

### 9.3 WCDMA Measurement Procedures for SAR

The following procedures are applicable to WCDMA handsets operating under 3GPP Release99, Release 5 and Release 6. The default test configuration is to measure SAR with an established radio link between the DUT and a communication test set using a 12.2kbps RMC (reference measurement channel) configured in Test Loop Mode 1. SAR is selectively confirmed for other physical channel configurations (DPCCH & DPDCH<sub>n</sub>), HSDPA and HSPA (HSUPA/HSDPA) modes according to output power, exposure conditions and device operating capabilities. Both uplink and downlink should be configured with the same RMC or AMR, when required. SAR for Release 5 HSDPA and Release 6 HSPA are measured using the applicable FRC (fixed reference channel) and E-DCH reference channel configurations. Maximum output power is verified according to applicable versions of 3GPP TS 34.121 and SAR must be measured according to these maximum output conditions. When Maximum Power Reduction (MPR) is not implemented according to Cubic Metric (CM) requirements for Release 6 HSPA, the following procedures do not apply.

**For Release 5 HSDPA Data Devices:**

Sub-test	$\beta_c$	$\beta_d$	$\beta_d$ (SF)	$\beta_c / \beta_d$	$\beta_{hs}$	CM/dB
1	2/15	15/15	64	2/15	4/15	0.0
2	12/15	15/15	64	12/15	24/25	1.0
3	15/15	8/15	64	15/8	30/15	1.5
4	15/15	4/15	64	15/4	30/15	1.5

**For Release 6 HSPA Data Devices**

Sub-test	$\beta_c$	$\beta_d$	$\beta_d$ (SF)	$\beta_c / \beta_d$	$\beta_{hs}$	$\beta_{ec}$	$\beta_{ed}$	$\beta_{ed}$ (SF)	$\beta_{ed}$ (codes)	CM (dB)	MPR (dB)	AG Index	E-TFCI
1	11/15	15/15	64	11/15	22/15	209/225	1039/225	4	1	1.0	2.0	20	75
2	6/15	15/15	64	6/15	12/15	12/15	12/15	4	1	3.0	2.0	12	67
3	15/15	9/15	64	15/9	30/15	30/15	$\beta_{ed1}:47/15$ $\beta_{ed2}:47/15$	4	2	2.0	1.0	15	92
4	2/15	15/15	64	2/15	4/15	4/15	56/75	4	1	3.0	3.0	17	71
5	15/15	15/15	64	15/15	24/15	30/15	134/15	4	1	1.0	0.0	21	81

**9.4 Bluetooth & Wi-Fi Measurement Procedures for SAR**

Normal network operating configurations are not suitable for measuring the SAR of 802.11 transmitters in general. Unpredictable fluctuations in network traffic and antenna diversity conditions can introduce undesirable variations in SAR results. The SAR for these devices should be measured using chipset based test mode software to ensure that the results are consistent and reliable.

Chipset based test mode software is hardware dependent and generally varies among manufacturers. The device operating parameters established in a test mode for SAR measurements must be identical to those programmed in production units, including output power levels, amplifier gain settings and other RF performance tuning parameters. The test frequencies should correspond to actual channel frequencies defined for domestic use. SAR for devices with switched diversity should be measured with only one antenna transmitting at a time during each SAR measurement, according to a fixed modulation and data rate. The same data pattern should be used for all measurements.

**9.5 Power Drift**

To control the output power stability during the SAR test, DASY5 system calculates the power drift by measuring the E-field at the same location at the beginning and at the end of the measurement for each test position. These drift values can be found in Table 14.2 to Table 14.26 labeled as: (Power Drift [dB]). This ensures that the power drift during one measurement is within 5%.

## 10 Area Scan Based 1-g SAR

### 10.1 Requirement of KDB

According to the KDB447498 D01 v05, when the implementation is based the specific polynomial fit algorithm as presented at the 29th Bioelectromagnetics Society meeting (2007) and the estimated 1-g SAR is  $\leq 1.2$  W/kg, a zoom scan measurement is not required provided it is also not needed for any other purpose; for example, if the peak SAR location required for simultaneous transmission SAR test exclusion can be determined accurately by the SAR system or manually to discriminate between distinctive peaks and scattered noisy SAR distributions from area scans.

There must not be any warning or alert messages due to various measurement concerns identified by the SAR system; for example, noise in measurements, peaks too close to scan boundary, peaks are too sharp, spatial resolution and uncertainty issues etc. The SAR system verification must also demonstrate that the area scan estimated 1-g SAR is within 3% of the zoom scan 1-g SAR (See Annex B). When all the SAR results for each exposure condition in a frequency band and wireless mode are based on estimated 1-g SAR, the 1-g SAR for the highest SAR configuration must be determined by a zoom scan.

### 10.2 Fast SAR Algorithms

The approach is based on the area scan measurement applying a frequency dependent attenuation parameter. This attenuation parameter was empirically determined by analyzing a large number of phones. The MOTOROLA FAST SAR was developed and validated by the MOTOROLA Research Group in Ft. Lauderdale.

In the initial study, an approximation algorithm based on Linear fit was developed. The accuracy of the algorithm has been demonstrated across a broad frequency range (136-2450 MHz) and for both 1- and 10-g averaged SAR using a sample of 264 SAR measurements from 55 wireless handsets. For the sample size studied, the root-mean-squared errors of the algorithm are 1.2% and 5.8% for 1- and 10-g averaged SAR, respectively. The paper describing the algorithm in detail is expected to be published in August 2004 within the Special Issue of Transactions on MTT.

In the second step, the same research group optimized the fitting algorithm to an Polynomial fit whereby the frequency validity was extended to cover the range 30-6000MHz. Details of this study can be found in the BEMS 2007 Proceedings.

Both algorithms are implemented in DASYS software.

## 11 Conducted Output Power

### 11.1 Manufacturing tolerance

Note: Target Value is Average Output Power Value.

**Table 11.1: GSM Speech**

GSM 850			
Channel	Channel 251	Channel 190	Channel 128
Target (dBm)	32	32	32
Tolerance $\pm$ (dB)	1	1	1
GSM 1900			
Channel	Channel 810	Channel 661	Channel 512
Target (dBm)	30	30	30
Tolerance $\pm$ (dB)	1	1	1

**Table 11.2: GPRS**

850 MHz GPRS (GMSK)				
Channel		Channel <b>810</b>	Channel <b>661</b>	Channel <b>512</b>
1 Txslot	Target (dBm)	32	32	32
	Tolerance $\pm$ (dB)	1	1	1
2 Txslots	Target (dBm)	30	30	30
	Tolerance $\pm$ (dB)	1	1	1
3Txslots	Target (dBm)	29	29	29
	Tolerance $\pm$ (dB)	1	1	1
4 Txslots	Target (dBm)	28	28	28
	Tolerance $\pm$ (dB)	2	2	2
1900 MHz GPRS (GMSK)				
Channel		Channel <b>810</b>	Channel <b>661</b>	Channel <b>512</b>
1 Txslot	Target (dBm)	29	29	29
	Tolerance $\pm$ (dB)	1	1	1
2 Txslots	Target (dBm)	28	28	28
	Tolerance $\pm$ (dB)	1	1	1
3Txslots	Target (dBm)	27	27	27
	Tolerance $\pm$ (dB)	1	1	1
4 Txslots	Target (dBm)	26	26	26
	Tolerance $\pm$ (dB)	1	1	1

**Table 11.3: WCDMA**

UMTS Band V		Conducted Power (dBm)		
		Channel 4233	Channel 4183	Channel 4132
RMC	Target (dBm)	23	23	23
	Tolerance $\pm$ (dB)	1	1	1
HSDPA	Target (dBm)	22	22	22
	Tolerance $\pm$ (dB)	1	1	1
HSUPA	Target (dBm)	21	21	21
	Tolerance $\pm$ (dB)	2	2	2
UMTS Band II		Conducted Power (dBm)		

		Channel 9538	Channel 9400	Channel 9262
RMC	Target (dBm)	23	23	23
	Tolerance $\pm$ (dB)	1	1	1
HSDPA	Target (dBm)	22	22	22
	Tolerance $\pm$ (dB)	1	1	1
HSUPA	Target (dBm)	21	21	21
	Tolerance $\pm$ (dB)	1	1	1

**Table 11.4: WiFi**

Channel		Channel 1	Channel 6	Channel 11
WiFi 802.11b	Target (dBm)	13	13	13
	Tolerance $\pm$ (dB)	1	1	1
WiFi 802.11g	Target (dBm)	10	10	10
	Tolerance $\pm$ (dB)	1	1	1
WiFi 802.11n(20)	Target (dBm)	10	10	10
	Tolerance $\pm$ (dB)	1	1	1

**Table 11.5: Bluetooth**

Channel		Channel 1	Channel 6	Channel 11
GFSK	Target (dBm)	2	2	2
	Tolerance $\pm$ (dB)	1	1	1

## 11.2 GSM Measurement result

During the process of testing, the EUT was controlled via Agilent Digital Radio Communication tester (E5515C) to ensure the maximum power transmission and proper modulation. This result contains conducted output power for the EUT. In all cases, the measured peak output power should be greater and within 5% than EMI measurement.

**Table 11.6: The conducted power measurement results for GSM**

GSM 850MHz	Conducted Power (dBm)		
	Channel 251(848.6MHz)	Channel 190(836.8MHz)	Channel 128(824.2MHz)
	32.06	32.09	32.17
GSM 1900MHz	Channel 810(1909.8MHz)	Channel 661(1880MHz)	Channel 512(1850.2MHz)
	29.38	29.85	30.23

**Table 11.7: The conducted power measurement results for GPRS and EGPRS (Hotspot on)**

GSM850 GPRS (GMSK)	Measured Power (dBm)			calculation	Averaged Power (dBm)		
	<b>251</b>	<b>190</b>	<b>128</b>		<b>251</b>	<b>190</b>	<b>128</b>
1 Txslot	32.04	32.03	32.00	-9.03dB	23.01	23	22.97
2 Txslots	30.97	31.00	31.00	-6.02dB	24.95	24.98	24.98
3Txslots	29.17	29.22	29.20	-4.26dB	24.91	24.96	24.94
<b>4 Txslots</b>	28.19	28.22	28.26	<b>-3.01dB</b>	<b>25.18</b>	<b>25.21</b>	<b>25.25</b>
PCS1900 GPRS (GMSK)	Measured Power (dBm)			calculation	Averaged Power (dBm)		
	<b>810</b>	<b>661</b>	<b>512</b>		<b>810</b>	<b>661</b>	<b>512</b>
1 Txslot	29.52	29.57	29.54	-9.03dB	20.49	20.54	20.51
2 Txslots	28.67	28.71	28.65	-6.02dB	22.65	22.69	22.63
3Txslots	27.10	27.12	27.09	-4.26dB	22.84	22.86	22.83



<b>4 Txslots</b>	26.23	26.26	26.25	<b>-3.01dB</b>	<b>23.22</b>	<b>23.25</b>	<b>23.24</b>
------------------	-------	-------	-------	----------------	--------------	--------------	--------------

**Table 11.8: The conducted power measurement results for GPRS and EGPRS(Hotspot off)**

GSM850 GPRS (GMSK)	Measured Power (dBm)			calculation	Averaged Power (dBm)		
	<b>251</b>	<b>190</b>	<b>128</b>		<b>251</b>	<b>190</b>	<b>128</b>
1 Txslot	32.04	32.03	32.00	<b>-9.03dB</b>	23.01	23	22.97
2 Txslots	30.97	31.00	31.00	<b>-6.02dB</b>	24.95	24.98	24.98
3Txslots	29.17	29.22	29.20	<b>-4.26dB</b>	24.91	24.96	24.94
<b>4 Txslots</b>	28.19	28.22	28.26	<b>-3.01dB</b>	<b>25.18</b>	<b>25.21</b>	<b>25.25</b>
PCS1900 GPRS (GMSK)	Measured Power (dBm)			calculation	Averaged Power (dBm)		
	<b>810</b>	<b>661</b>	<b>512</b>		<b>810</b>	<b>661</b>	<b>512</b>
1 Txslot	29.52	29.57	29.54	<b>-9.03dB</b>	20.49	20.54	20.51
2 Txslots	28.67	28.71	28.65	<b>-6.02dB</b>	22.65	22.69	22.63
3Txslots	27.10	27.12	27.09	<b>-4.26dB</b>	22.84	22.86	22.83
<b>4 Txslots</b>	26.23	26.26	26.25	<b>-3.01dB</b>	<b>23.22</b>	<b>23.25</b>	<b>23.24</b>

To average the power, the division factor is as follows:

1TX-slot = 1 transmit time slot out of 8 time slots=> conducted power divided by (8/1) => -9.03dB

2TX-slots = 2 transmit time slots out of 8 time slots=> conducted power divided by (8/2) => -6.02dB

3TX-slots = 3 transmit time slots out of 8 time slots=> conducted power divided by (8/3) => -4.26dB

4TX-slots = 4 transmit time slots out of 8 time slots=> conducted power divided by (8/4) => -3.01dB

According to the conducted power as above, the body measurements are performed with 4Txslots for GSM850 and 4Txslots for PCS1900.

Note: According to the KDB941225 D03, "when SAR tests for EDGE or EGPRS mode is necessary, GMSK modulation should be used".

## 12.2 WCDMA Measurement result

Table 11.9: The conducted Power for WCDMA (Hotspot on)

UMTS Band II		Conducted Power (dBm)		
		Ch 9888 (1977.6MHz)	Ch 9750 (1950MHz)	Ch 9612 (1922.4MHz)
RMC	12.2kbps RMC	22.81	23.07	23.22
HSDPA	Sub - Test 1	21.97	22.21	22.27
	Sub - Test 2	21.98	22.18	22.24
	Sub - Test 3	21.98	22.27	22.20
	Sub - Test 4	21.99	22.25	22.24
HSUPA	Sub - Test 1	20.14	20.29	20.26
	Sub - Test 2	20.18	20.31	20.24
	Sub - Test 3	21.11	21.31	21.22
	Sub - Test 4	19.60	19.80	19.77
	Sub - Test 5	22.12	22.26	22.25
UMTS Band V		Conducted Power (dBm)		
		Ch 2863 (912.6MHz)	Ch 2788 (897.4MHz)	Ch 2712 (882.4MHz)
RMC	12.2kbps RMC	23.76	23.78	23.67
HSDPA	Sub - Test 1	22.77	22.81	22.74
	Sub - Test 2	22.79	22.86	22.72
	Sub - Test 3	22.78	22.86	22.74
	Sub - Test 4	22.69	22.84	22.67
HSUPA	Sub Test - 1	20.69	20.84	21.13
	Sub Test - 2	20.66	20.84	20.67
	Sub Test - 3	21.71	21.77	21.63
	Sub Test - 4	20.21	20.28	20.17
	Sub Test - 5	22.77	22.79	22.63

## 11.4 Wi-Fi and BT Measurement result

Table 11.10: The conducted Power for BT

mode\Channel	Measured Power (dBm)		
	Ch 0 (2402 MHz)	Ch 39 (2441 Mhz)	Ch 78 (2480 MHz)
GFSK	2.76	2.55	2.51
8DPSK	2.02	1.82	1.78
BLE	2.17	1.95	1.74

Table 11.11: The conducted Power for WIFI

mode\Channel	Measured Power (dBm)		
	Ch 1 (2412 MHz)	Ch 7 (2442Mhz)	Ch 13 (2472MHz)
802.11b	13.51	13.81	13.55
802.11g	10.73	10.75	10.72
802.11n (20MHz)	10.44	10.85	10.69
802.11n (40MHz)	9.37	9.30	10.61

## 12 Simultaneous TX SAR Considerations

### 12.1 Introduction

The following procedures adopted from “FCC SAR Considerations for Cell Phones with Multiple Transmitters” are applicable to handsets with built-in unlicensed transmitters such as 802.11 a/b/g and Bluetooth devices which may simultaneously transmit with the licensed transmitter.

For this device, the BT and Wi-Fi can transmit simultaneous with other transmitters.

### 12.2 Transmit Antenna Separation Distances

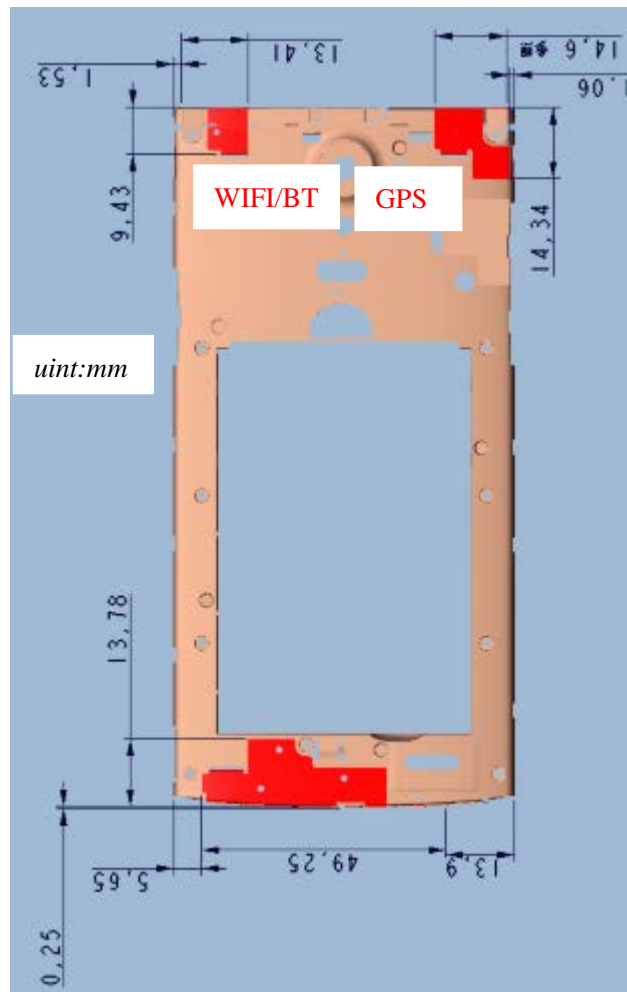

Picture 12.1 Antenna Locations

### 12.3 SAR Measurement Positions

According to the KDB941225 D06 Hot Spot SAR v01, the edges with less than 2.5 cm distance to the antennas need to be tested for SAR.

Table 12.1: SAR measurement positions

Mode	Front	Rear	Left edge	Right edge	Top edge	Bottom edge
Main antenna	Yes	Yes	Yes	No	No	Yes
WiFi antenna	Yes	Yes	Yes	No	Yes	No

## 12.4 Standalone SAR Test Exclusion Considerations

Standalone 1-g head or body SAR evaluation by measurement or numerical simulation is not required when the corresponding SAR Exclusion Threshold condition, listed below, is satisfied. The 1-g SAR test exclusion threshold for 100 MHz to 6 GHz at test separation distances  $\leq 50$  mm are determined by:

$[(\text{max. power of channel, including tune-up tolerance, mW}) / (\text{min. test separation distance, mm})] \cdot [\sqrt{f(\text{GHz})}] \leq 3.0$  for 1-g SAR, where

- $f(\text{GHz})$  is the RF channel transmit frequency in GHz
- Power and distance are rounded to the nearest mW and mm before calculation
- The result is rounded to one decimal place for comparison

### Appendix A

#### SAR Test Exclusion Thresholds for 100 MHz – 6 GHz and $\leq 50$ mm

Approximate SAR Test Exclusion Power Thresholds at Selected Frequencies and Test Separation Distances are illustrated in the following Table.

MHz	5	10	15	20	25	mm
150	39	77	116	155	194	SAR Test Exclusion Threshold (mW)
300	27	55	82	110	137	
450	22	45	67	89	112	
835	16	33	49	66	82	
900	16	32	47	63	79	
1500	12	24	37	49	61	
1900	11	22	33	44	54	
2450	10	19	29	38	48	
3600	8	16	24	32	40	
5200	7	13	20	26	33	
5400	6	13	19	26	32	
5800	6	12	19	25	31	

Picture 12.2 Power Thresholds

According to the KDB447498 appendix A, the SAR test exclusion threshold for 2450MHz at 10m test separation distances is 19mW.

Table 12.2: Standalone SAR test exclusion considerations

Band/Mode	F(GHz)	Position	SAR test exclusion threshold (mW)	RF output power		SAR test exclusion
				dBm	mW	
Bluetooth	2.402	Head	10	2.76	1.89	Yes
		Body	19	2.76	1.89	Yes
WiFi	2.442	Head	10	13.81	24.04	No
		Body	19	13.81	24.04	No

### 13 Evaluation of Simultaneous

When standalone SAR test exclusion applies to an antenna that transmits simultaneously with other antennas, the standalone SAR must be estimated according to following to determine simultaneous transmission SAR test exclusion:

$$(max. \text{ power of channel, including tune-up tolerance, } mW) / (min. \text{ test separation distance, } mm) \cdot [\sqrt{f_{(GHz)}/x}] \text{ W/kg for test separation distances } \leq 50 \text{ mm;}$$

Where x = 7.5 for 1-g SAR, AND X = 18.75 for 10-g SAR.

When the minimum test separation distance is < 5 mm, a distance of 5 mm is applied to determine SAR test exclusion.

**Table 13.1: Estimated SAR for Bluetooth**

Position	F (GHz)	Distance (mm)	Upper limit of power *		Estimated <sub>1g</sub> (W/kg)
			dBm	mW	
Head	2.402	5	3.00	1.89	0.079
Body	2.442	10	3.00	1.89	0.039

\* - Maximum possible output power declared by manufacturer

**Table 13.2: The sum of reported SAR values for main antenna and WiFi**

	Position	Main antenna (W/Kg)	WiFi(W/Kg)	Sum(W/Kg)
<b>Highest reported SAR value for Head</b>	Left hand, Touch cheek	0.533	0.657	1.190
<b>Highest reported SAR value for Body</b>	Rear	1.044	0.310	1.354

Note: The distance between the EUT and the phantom bottom is 10mm.

**Table 13.3: The sum of reported SAR values for main antenna and Bluetooth**

	Position	Main antenna (W/Kg)	BT*(W/Kg)	Sum(W/Kg)
<b>Highest reported SAR value for Head</b>	Left hand, Touch cheek	1.190	0.079	1.269
<b>Highest reported SAR value for Body</b>	Rear	1.354	0.039	<b>1.393</b>

BT\* - Estimated SAR for Bluetooth (see the table 13.2)

**Conclusion:**

According to the above tables, the sum of reported SAR values is < 1.6W/kg. So the simultaneous transmission SAR with volume scans is not required.

## 14 SAR Test Result

It is determined by user manual for the distance between the EUT and the phantom bottom.  
The distance is 10mm and just applied to the condition of body worn accessory.

It is performed for all SAR measurements with area scan based 1-g SAR estimation (Fast SAR). A zoom scan measurement is added when the estimated 1-g SAR is the highest measured SAR in each exposure configuration, wireless mode and frequency band combination or  $> 1.2\text{W/kg}$ .  
The calculated SAR is obtained by the following formula:

$$\text{Reported SAR} = \text{Measured SAR} \times 10^{(P_{\text{Target}} - P_{\text{Measured}})/10}$$

Where  $P_{\text{Target}}$  is the power of manufacturing upper limit;

$P_{\text{Measured}}$  is the measured power in chapter 11.

**Table 14.1: Duty Cycle**

<b>Mode</b>	<b>Duty Cycle</b>
Speech for GSM850/1900	1:8.3
GPRS&EGPRS for GSM850	1:2
GPRS&EGPRS for GSM1900	1:2

### 14.1 SAR results for Fast SAR

**Table 14.2: SAR Values (GSM 850 MHz Band - Head)**

Frequency		Mode/Band	Test Position	Conducte d Power (dBm)	Max tune- up Power (dBm)	Figure No.	Measured SAR(10g) (W/kg)	Reported SAR(10g (W/kg)	Measured SAR(1g) (W/kg)	Reported SAR(1g) (W/kg)	Power Drift (dB)
MHz	Ch.										
836.6	190	Speech	Left Touch	32.09	33	/	0.246	<b>0.303</b>	0.331	<b>0.408</b>	0.13
836.6	190	Speech	Left Tilt	32.09	33	/	0.107	<b>0.132</b>	0.154	<b>0.190</b>	0.08
836.6	190	Speech	Right Touch	32.09	33	/	0.230	<b>0.284</b>	0.301	<b>0.371</b>	-0.06
836.6	190	Speech	Right Tilt	32.09	33	/	0.122	<b>0.150</b>	0.174	<b>0.215</b>	-0.03
848.8	251	Speech	Left Touch	32.17	33	Fig.1	0.326	<b>0.395</b>	0.440	<b>0.533</b>	-0.12
824.2	128	Speech	Left Touch	32.06	33	/	0.174	<b>0.216</b>	0.257	<b>0.319</b>	0.15

**Table 14.3: SAR Values (GSM 850 MHz Band - Body)**

Frequency		Mode/Band	Test Position	Conducte d Power (dBm)	Max. tune- up Power (dBm)	Figure No.	Measured SAR(10g) (W/kg)	Reported SAR(10g (W/kg)	Measured SAR(1g) (W/kg)	Reported SAR(1g) (W/kg)	Power Drift (dB)
MHz	Ch.										
836.6	190	GPRS (4)	Front	28.22	29	/	0.386	<b>0.462</b>	0.554	<b>0.663</b>	0.00
836.6	190	GPRS (4)	Rear	28.22	29	/	0.621	<b>0.743</b>	0.811	<b>0.971</b>	0.08

**Table 14.4: SAR Values (GSM 850 MHz Band – Body with Hotspot on)**

Frequency		Mode/Band	Test Position	Conducte d Power (dBm)	Max. tune- up Power (dBm)	Figure No.	Measured SAR(10g) (W/kg)	Reported SAR(10g) (W/kg)	Measured SAR(1g) (W/kg)	Reported SAR(1g) (W/kg)	Power Drift (dB)
MHz	Ch.										
836.6	190	GPRS (4)	Front	28.22	29	/	0.386	<b>0.462</b>	0.554	<b>0.663</b>	0.00
836.6	190	GPRS (4)	Rear	28.22	29	/	0.621	<b>0.743</b>	0.811	<b>0.971</b>	0.08
836.6	190	GPRS (4)	Left	28.22	29	/	0.410	<b>0.491</b>	0.604	<b>0.723</b>	0.16
836.6	190	GPRS (4)	Right	28.22	29	/	0.204	<b>0.244</b>	0.301	<b>0.360</b>	0.12
836.6	190	GPRS (4)	Top	28.22	29	/	0.012	<b>0.014</b>	0.017	<b>0.020</b>	0.11
836.6	190	GPRS (4)	Bottom	28.22	29	/	0.144	<b>0.172</b>	0.251	<b>0.300</b>	0.17
848.8	251	GPRS (4)	Rear	28.26	29	Fig.2	0.666	<b>0.790</b>	0.875	<b>1.038</b>	0.10
824.2	128	GPRS (4)	Rear	28.19	29	/	0.536	<b>0.646</b>	0.763	<b>0.919</b>	0.01
836.6	190	Speech	Rear Heads et	28.22	29	/	0.408	<b>0.488</b>	0.534	<b>0.639</b>	0.06

Note: The distance between the EUT and the phantom bottom is 10mm.

**Table 14.5: SAR Values (GSM 1900 MHz Band - Head)**

Frequency		Mode/Band	Test Position	Conducte d Power (dBm)	Max tune- up Power (dBm)	Figure No.	Measured SAR(10g) (W/kg)	Reported SAR(10g (W/kg)	Measured SAR(1g) (W/kg)	Reported SAR(1g) (W/kg)	Power Drift (dB)
MHz	Ch.										
1880	661	Speech	Left Touch	29.85	31	/	0.114	<b>0.149</b>	0.181	<b>0.236</b>	-0.02
1880	661	Speech	Left Tilt	29.85	31	/	0.063	<b>0.082</b>	0.114	<b>0.149</b>	0.14
1880	661	Speech	Right Touch	29.85	31	/	0.129	<b>0.168</b>	0.205	<b>0.267</b>	-0.15
1880	661	Speech	Right Tilt	29.85	31	/	0.046	<b>0.060</b>	0.084	<b>0.109</b>	-0.18
1909.8	810	Speech	Right Touch	30.23	31	/	0.075	<b>0.090</b>	0.131	<b>0.156</b>	0.11
1850.2	512	Speech	Right Touch	29.38	31	Fig.3	0.141	<b>0.205</b>	0.221	<b>0.321</b>	-0.19

**Table 14.6: SAR Values (GSM 1900 MHz Band - Body)**

Frequency		Mode/Band	Test Position	Conducte d Power (dBm)	Max. tune- up Power (dBm)	Figure No.	Measured SAR(10g) (W/kg)	Reported SAR(10g (W/kg)	Measured SAR(1g) (W/kg)	Reported SAR(1g) (W/kg)	Power Drift (dB)
MHz	Ch.										
1880	661	GPRS (4)	Front	26.26	27	/	0.355	<b>0.421</b>	0.568	<b>0.674</b>	-0.01
1880	661	GPRS (4)	Rear	26.26	27	/	0.438	<b>0.519</b>	0.793	<b>0.940</b>	-0.06

**Table 14.7: SAR Values (GSM 1900 MHz Band – Body with Hotspot on)**

Frequency		Mode/Band	Test Position	Conducte d Power (dBm)	Max. tune- up Power (dBm)	Figure No.	Measured SAR(10g) (W/kg)	Reported SAR(10g) (W/kg)	Measured SAR(1g) (W/kg)	Reported SAR(1g) (W/kg)	Power Drift (dB)
MHz	Ch.										
1880	661	GPRS (4)	Front	26.26	27	/	0.355	<b>0.421</b>	0.568	<b>0.674</b>	-0.01
1880	661	GPRS (4)	Rear	26.26	27	/	0.438	<b>0.519</b>	0.793	<b>0.940</b>	-0.06
1880	661	GPRS (4)	Left	26.26	27	/	0.101	<b>0.120</b>	0.172	<b>0.204</b>	0.04
1880	661	GPRS (4)	Right	26.26	27	/	0.139	<b>0.165</b>	0.246	<b>0.292</b>	-0.04
1880	661	GPRS (4)	Top	26.26	27	/	0.019	<b>0.023</b>	0.033	<b>0.039</b>	0.16
1880	661	GPRS (4)	Bottom	26.26	27	/	0.377	<b>0.447</b>	0.703	<b>0.834</b>	0.10
1909.8	810	GPRS (4)	Rear	26.25	27	/	0.410	<b>0.487</b>	0.758	<b>0.901</b>	-0.00
1850.2	512	GPRS (4)	Rear	26.23	27	Fig.4	0.490	<b>0.585</b>	0.874	<b>1.044</b>	0.02
1850.2	512	Speech	Rear Headset	26.23	27	/	0.250	<b>0.298</b>	0.435	<b>0.519</b>	0.08

Note: The distance between the EUT and the phantom bottom is 10mm.



**Table 14.8: SAR Values (WCDMA 850 MHz Band - Head)**

Frequency		Mode/Band	Test Position	Conducte d Power (dBm)	Max tune- up Power (dBm)	Figure No.	Measured SAR(10g) (W/kg)	Reported SAR(10g (W/kg)	Measured SAR(1g) (W/kg)	Reported SAR(1g) (W/kg)	Power Drift (dB)
MHz	Ch.										
836.6	4183	RMC	Left Touch	23.78	24	/	0.286	<b>0.301</b>	0.385	<b>0.405</b>	0.04
836.6	4183	RMC	Left Tilt	23.78	24	/	0.122	<b>0.128</b>	0.174	<b>0.183</b>	0.08
836.6	4183	RMC	Right Touch	23.78	24	/	0.257	<b>0.270</b>	0.335	<b>0.352</b>	-0.03
836.6	4183	RMC	Right Tilt	23.78	24	/	0.141	<b>0.148</b>	0.202	<b>0.212</b>	0.04
846.6	4233	RMC	Left Touch	23.67	24	Fig.5	0.330	<b>0.356</b>	0.445	<b>0.480</b>	-0.07
826.4	4132	RMC	Left Touch	23.76	24	/	0.211	<b>0.223</b>	0.283	<b>0.299</b>	0.10

**Table 14.9: SAR Values (WCDMA 850 MHz Band - Body)**

Frequency		Mode/Band	Test Position	Conducte d Power (dBm)	Max. tune- up Power (dBm)	Figure No.	Measured SAR(10g) (W/kg)	Reported SAR(10g (W/kg)	Measured SAR(1g) (W/kg)	Reported SAR(1g) (W/kg)	Power Drift (dB)
MHz	Ch.										
836.6	4183	RMC	Front	23.78	24	/	0.239	<b>0.251</b>	0.343	<b>0.361</b>	0.06
836.6	4183	RMC	Rear	23.78	24	/	0.351	<b>0.369</b>	0.466	<b>0.490</b>	0.04

**Table 14.10: SAR Values (WCDMA 850 MHz Band – Body with Hotspot on)**

Frequency		Mode/Band	Test Position	Conducte d Power (dBm)	Max. tune- up Power (dBm)	Figure No.	Measured SAR(10g) (W/kg)	Reported SAR(10g) (W/kg)	Measured SAR(1g) (W/kg)	Reported SAR(1g) (W/kg)	Power Drift (dB)
MHz	Ch.										
836.6	4183	RMC	Front	23.78	24	/	0.239	<b>0.251</b>	0.343	<b>0.361</b>	0.06
836.6	4183	RMC	Rear	23.78	24	/	0.351	<b>0.369</b>	0.466	<b>0.490</b>	0.04
836.6	4183	RMC	Left	23.78	24	/	0.225	<b>0.237</b>	0.334	<b>0.351</b>	0.09
836.6	4183	RMC	Right	23.78	24	/	0.130	<b>0.137</b>	0.192	<b>0.202</b>	-0.00
836.6	4183	RMC	Top	23.78	24	/	0.008	<b>0.008</b>	0.011	<b>0.012</b>	-0.00
836.6	4183	RMC	Bottom	23.78	24	/	0.069	<b>0.073</b>	0.113	<b>0.119</b>	0.19
846.6	4233	RMC	Rear	23.67	24	/	0.312	<b>0.337</b>	0.450	<b>0.486</b>	0.01
826.4	4132	RMC	Rear	23.76	24	/	0.316	<b>0.334</b>	0.453	<b>0.479</b>	0.09
846.6	4233	Speech	Rear Headset	23.67	24	Fig.6	0.321	<b>0.346</b>	0.461	<b>0.497</b>	0.02

Note: The distance between the EUT and the phantom bottom is 10mm.

**Table 14.11: SAR Values (WCDMA 1900 MHz Band - Head)**

Frequency		Mode/Band	Test Position	Conducte d Power (dBm)	Max tune- up Power (dBm)	Figure No.	Measured SAR(10g) (W/kg)	Reported SAR(10g (W/kg)	Measured SAR(1g) (W/kg)	Reported SAR(1g) (W/kg)	Power Drift (dB)
MHz	Ch.										
1880	9400	RMC	Left Touch	23.07	24	/	0.213	<b>0.264</b>	0.336	<b>0.416</b>	0.16
1880	9400	RMC	Left Tilt	23.07	24	/	0.107	<b>0.133</b>	0.194	<b>0.240</b>	0.09
1880	9400	RMC	Right Touch	23.07	24	/	0.228	<b>0.282</b>	0.367	<b>0.455</b>	0.11
1880	9400	RMC	Right Tilt	23.07	24	/	0.085	<b>0.105</b>	0.149	<b>0.185</b>	-0.05
1908	9538	RMC	Right Touch	23.22	24	/	0.197	<b>0.236</b>	0.317	<b>0.379</b>	-0.12
1852.4	9262	RMC	Right Touch	22.81	24	Fig.7	0.242	<b>0.318</b>	0.382	<b>0.502</b>	0.13

**Table 14.12: SAR Values (WCDMA 1900 MHz Band - Body)**

Frequency		Mode/Band	Test Position	Conducte d Power (dBm)	Max. tune- up Power (dBm)	Figure No.	Measured SAR(10g) (W/kg)	Reported SAR(10g (W/kg)	Measured SAR(1g) (W/kg)	Reported SAR(1g) (W/kg)	Power Drift (dB)
MHz	Ch.										
1880	9400	RMC	Front	23.07	24	/	0.314	<b>0.389</b>	0.512	<b>0.634</b>	0.06
1880	9400	RMC	Rear	23.07	24	/	0.401	<b>0.497</b>	0.719	<b>0.891</b>	0.17

**Table 14.13: SAR Values (WCDMA 1900 MHz Band – Body with Hotspot on)**

Frequency		Mode/Band	Test Position	Conducte d Power (dBm)	Max. tune- up Power (dBm)	Figure No.	Measured SAR(10g) (W/kg)	Reported SAR(10g) (W/kg)	Measured SAR(1g) (W/kg)	Reported SAR(1g) (W/kg)	Power Drift (dB)
MHz	Ch.										
1880	9400	RMC	Front	23.07	24	/	0.314	<b>0.389</b>	0.512	<b>0.634</b>	0.06
1880	9400	RMC	Rear	23.07	24	/	0.401	<b>0.497</b>	0.719	<b>0.891</b>	0.17
1880	9400	RMC	Left	23.07	24	/	0.102	<b>0.126</b>	0.173	<b>0.214</b>	0.14
1880	9400	RMC	Right	23.07	24	/	0.139	<b>0.172</b>	0.236	<b>0.292</b>	0.01
1908	9538	RMC	Top	23.22	24	/	0.011	<b>0.013</b>	0.018	<b>0.022</b>	0.11
1908	9538	RMC	Bottom	23.22	24	/	0.413	<b>0.494</b>	0.768	<b>0.919</b>	0.19
1852.4	9262	RMC	Bottom	22.81	24	Fig.8	0.407	<b>0.535</b>	0.765	<b>1.006</b>	0.16
1880	9400	RMC	Bottom	23.07	24	/	0.402	<b>0.498</b>	0.743	<b>0.920</b>	0.17
1852.4	9262	Speech	Bottom Headset	22.81	24	/	0.411	<b>0.541</b>	0.763	<b>1.004</b>	0.16

Note: The distance between the EUT and the phantom bottom is 10mm.

**Table 14.14: SAR Values (WiFi 802.11b - Head)**

Frequency		Mode/Band	Test Position	Conducted Power (dBm)	Max. tune-up Power (dBm)	Figure No.	Measured SAR(10g) (W/kg)	Reported SAR(10g) (W/kg)	Measured SAR(1g) (W/kg)	Reported SAR(1g) (W/kg)	Power Drift (dB)
MHz	Ch.										
2442	7	802.11 b	Left Touch	13.81	14	/	0.246	<b>0.257</b>	0.496	<b>0.518</b>	0.13
2442	7	802.11 b	Left Tilt	13.81	14	/	0.179	<b>0.187</b>	0.369	<b>0.386</b>	0.14
2442	7	802.11 b	Right Touch	13.81	14	/	0.127	<b>0.133</b>	0.222	<b>0.232</b>	-0.11
2442	7	802.11 b	Right Tilt	13.81	14	/	0.073	<b>0.076</b>	0.139	<b>0.145</b>	0.19
2472	13	802.11 b	Left Touch	13.55	14	Fig.9	0.286	<b>0.317</b>	0.592	<b>0.657</b>	0.14
2412	1	802.11 b	Left Touch	13.51	14	/	0.227	<b>0.254</b>	0.446	<b>0.499</b>	0.15

**Table 14.15: SAR Values (WiFi 802.11b - Body)**

Frequency		Mode/Band	Test Position	Conducted Power (dBm)	Max. tune-up Power (dBm)	Figure No.	Measured SAR(10g) (W/kg)	Reported SAR(10g) (W/kg)	Measured SAR(1g) (W/kg)	Reported SAR(1g) (W/kg)	Power Drift (dB)
MHz	Ch.										
2442	7	802.11 b	Front	13.81	14	/	0.118	<b>0.123</b>	0.208	<b>0.217</b>	-0.01
2442	7	802.11 b	Rear	13.81	14	/	0.135	<b>0.141</b>	0.262	<b>0.274</b>	-0.05

**Table 14.16: SAR Values (WiFi 802.11b – Body with Hotspot on)**

Frequency		Mode/Band	Test Position	Conducted Power (dBm)	Max. tune-up Power (dBm)	Figure No.	Measured SAR(10g) (W/kg)	Reported SAR(10g) (W/kg)	Measured SAR(1g) (W/kg)	Reported SAR(1g) (W/kg)	Power Drift (dB)
MHz	Ch.										
2442	7	802.11 b	Front	13.81	14	/	0.118	<b>0.123</b>	0.208	<b>0.217</b>	-0.01
2442	7	802.11 b	Rear	13.81	14	/	0.135	<b>0.141</b>	0.262	<b>0.274</b>	-0.05
2442	7	802.11 b	Left	13.81	14	/	0.020	<b>0.021</b>	0.036	<b>0.038</b>	0.17
2442	7	802.11 b	Right	13.81	14	/	0.083	<b>0.087</b>	0.157	<b>0.164</b>	0.14
2442	7	802.11 b	Top	13.81	14	/	0.145	<b>0.151</b>	0.085	<b>0.089</b>	-0.09
2442	7	802.11 b	Bottom	13.81	14	/	0.030	<b>0.031</b>	0.059	<b>0.062</b>	0.19
2472	13	802.11 b	Rear	13.55	14	/	0.136	<b>0.151</b>	0.266	<b>0.295</b>	-0.00
2442	1	802.11 b	Rear	13.81	14	Fig.10	0.150	<b>0.157</b>	0.297	<b>0.310</b>	-0.02

Note: The distance between the EUT and the phantom bottom is 10mm.

## 14.2 SAR results for Standard procedure

There is zoom scan measurement to be added for the highest measured SAR in each exposure configuration/band.

**Table 14.17: SAR Values (GSM 850 MHz Band - Head)**

Frequency		Mode/Band	Test Position	Conducte d Power (dBm)	Max tune- up Power (dBm)	Figure No.	Measured SAR(10g) (W/kg)	Reported SAR(10g (W/kg)	Measured SAR(1g) (W/kg)	Reported SAR(1g) (W/kg)	Power Drift (dB)
MHz	Ch.										
848.8	251	Speech	Left Touch	32.17	33	/	0.326	<b>0.395</b>	0.440	<b>0.533</b>	-0.12

**Table 14.18: SAR Values (GSM 850 MHz Band – Body with Hotspot on)**

Frequency		Mode/Band	Test Position	Conducte d Power (dBm)	Max. tune- up Power (dBm)	Figure No.	Measured SAR(10g) (W/kg)	Reported SAR(10g) (W/kg)	Measured SAR(1g) (W/kg)	Reported SAR(1g) (W/kg)	Power Drift (dB)
MHz	Ch.										
848.8	251	GPRS (4)	Rear	28.26	29	/	0.666	<b>0.790</b>	0.875	<b>1.038</b>	0.10

Note: The distance between the EUT and the phantom bottom is 10mm.

**Table 14.19: SAR Values (GSM 1900 MHz Band - Head)**

Frequency		Mode/Band	Test Position	Conducte d Power (dBm)	Max tune- up Power (dBm)	Figure No.	Measured SAR(10g) (W/kg)	Reported SAR(10g (W/kg)	Measured SAR(1g) (W/kg)	Reported SAR(1g) (W/kg)	Power Drift (dB)
MHz	Ch.										
1850.2	512	Speech	Right Touch	29.38	31	/	0.141	<b>0.205</b>	0.221	<b>0.321</b>	-0.19

**Table 14.20: SAR Values (GSM 1900 MHz Band – Body with Hotspot on)**

Frequency		Mode/Band	Test Position	Conducte d Power (dBm)	Max. tune- up Power (dBm)	Figure No.	Measured SAR(10g) (W/kg)	Reported SAR(10g) (W/kg)	Measured SAR(1g) (W/kg)	Reported SAR(1g) (W/kg)	Power Drift (dB)
MHz	Ch.										
1850.2	512	GPRS (4)	Rear	26.23	27	/	0.490	<b>0.585</b>	0.874	<b>1.044</b>	0.02

Note: The distance between the EUT and the phantom bottom is 10mm.

**Table 14.21: SAR Values (WCDMA 850 MHz Band - Head)**

Frequency		Mode/Band	Test Position	Conducte d Power (dBm)	Max tune-up Power (dBm)	Figure No.	Measured SAR(10g) (W/kg)	Reported SAR(10g) (W/kg)	Measured SAR(1g) (W/kg)	Reported SAR(1g) (W/kg)	Power Drift (dB)
MHz	Ch.										
846.6	4233	RMC	Left Touch	23.67	24	/	0.330	<b>0.356</b>	0.445	<b>0.480</b>	-0.07

**Table 14.22: SAR Values (WCDMA 850 MHz Band – Body with Hotspot on)**

Frequency		Mode/Band	Test Position	Conducte d Power (dBm)	Max. tune-up Power (dBm)	Figure No.	Measured SAR(10g) (W/kg)	Reported SAR(10g) (W/kg)	Measured SAR(1g) (W/kg)	Reported SAR(1g) (W/kg)	Power Drift (dB)
MHz	Ch.										
846.6	4233	Speech	Rear Headset	23.67	24	/	0.321	<b>0.346</b>	0.461	<b>0.497</b>	0.02

Note: The distance between the EUT and the phantom bottom is 10mm.

**Table 14.23: SAR Values (WCDMA 1900 MHz Band - Head)**

Frequency		Mode/Band	Test Position	Conducte d Power (dBm)	Max tune-up Power (dBm)	Figure No.	Measured SAR(10g) (W/kg)	Reported SAR(10g) (W/kg)	Measured SAR(1g) (W/kg)	Reported SAR(1g) (W/kg)	Power Drift (dB)
MHz	Ch.										
1852.4	9262	RMC	Right Touch	22.81	24	/	0.242	<b>0.318</b>	0.382	<b>0.502</b>	0.13

**Table 14.24: SAR Values (WCDMA 1900 MHz Band – Body with Hotspot on)**

Frequency		Mode/Band	Test Position	Conducte d Power (dBm)	Max. tune-up Power (dBm)	Figure No.	Measured SAR(10g) (W/kg)	Reported SAR(10g) (W/kg)	Measured SAR(1g) (W/kg)	Reported SAR(1g) (W/kg)	Power Drift (dB)
MHz	Ch.										
1852.4	9262	RMC	Bottom	22.81	24	/	0.407	<b>0.535</b>	0.765	<b>1.006</b>	0.16

Note: The distance between the EUT and the phantom bottom is 10mm.

**Table 14.25: SAR Values (WiFi 802.11b - Head)**

Frequency		Mode/Band	Test Position	Conducte d Power (dBm)	Max. tune-up Power (dBm)	Figure No.	Measured SAR(10g) (W/kg)	Reported SAR(10g) (W/kg)	Measure d SAR(1g) (W/kg)	Reported SAR(1g) (W/kg)	Power Drift (dB)
MHz	Ch.										
2472	13	802.11 b	Left Touch	13.55	14	/	0.286	<b>0.317</b>	0.592	<b>0.657</b>	0.14

**Table 14.26: SAR Values (WiFi 802.11b – Body with Hotspot on)**

Frequency		Mode/Band	Test Position	Conducte d Power (dBm)	Max. tune-up Power (dBm)	Figure No.	Measure d SAR(10g) (W/kg)	Reported SAR(10g) (W/kg)	Measured SAR(1g) (W/kg)	Reported SAR(1g) (W/kg)	Power Drift (dB)
MHz	Ch.										
2442	1	802.11 b	Rear	13.81	14	/	0.150	<b>0.157</b>	0.297	<b>0.310</b>	-0.02

Note: The distance between the EUT and the phantom bottom is 10mm.

## 15 SAR Measurement Variability

SAR measurement variability must be assessed for each frequency band, which is determined by the SAR probe calibration point and tissue-equivalent medium used for the device measurements. When both head and body tissue-equivalent media are required for SAR measurements in a frequency band, the variability measurement procedures should be applied to the tissue medium with the highest measured SAR, using the highest measured SAR configuration for that tissue-equivalent medium.

The following procedures are applied to determine if repeated measurements are required.

- 1) Repeated measurement is not required when the original highest measured SAR is  $< 0.80$  W/kg; steps 2) through 4) do not apply.
- 2) When the original highest measured SAR is  $\geq 0.80$  W/kg, repeat that measurement once.
- 3) Perform a second repeated measurement only if the ratio of largest to smallest SAR for the original and first repeated measurements is  $> 1.20$  or when the original or repeated measurement is  $\geq 1.45$  W/kg (~ 10% from the 1-g SAR limit).
- 4) Perform a third repeated measurement only if the original, first or second repeated measurement is  $\geq 1.5$  W/kg and the ratio of largest to smallest SAR for the original, first and second repeated measurements is  $> 1.20$ .

**Table 15.1: SAR Measurement Variability for Body GSM 850 with Hotspot on (1g)**

Frequency		Mode	Test Position	Original SAR (W/kg)	First Repeated SAR (W/kg)	The Ratio	Second Repeated SAR (W/kg)
MHz	Ch.						
848.6	251	GPRS (4)	Rear	0.875	0.872	0.34	/

**Table 15.2: SAR Measurement Variability for Body PCS 1900 with Hotspot on (1g)**

Frequency		Mode	Test Position	Original SAR (W/kg)	First Repeated SAR (W/kg)	The Ratio	Second Repeated SAR (W/kg)
MHz	Ch.						
1850.2	512	GPRS	Rear	0.874	0.870	0.46	/

Note: The distance between the EUT and the phantom bottom is 10mm.

## 16 Measurement Uncertainty

### 16.1 Measurement Uncertainty for Normal SAR Tests (300MHz~3GHz)

No.	Error Description	Type	Uncertainty value	Probably Distribution	Div.	(Ci) 1g	(Ci) 10g	Std. Unc. (1g)	Std. Unc. (10g)	Degree of freedom
<b>Measurement system</b>										
1	Probe calibration	B	5.5	N	1	1	1	5.5	5.5	∞
2	Isotropy	B	4.7	R	$\sqrt{3}$	0.7	0.7	1.9	1.9	∞
3	Boundary effect	B	1.0	R	$\sqrt{3}$	1	1	0.6	0.6	∞
4	Linearity	B	4.7	R	$\sqrt{3}$	1	1	2.7	2.7	∞
5	Detection limit	B	1.0	N	1	1	1	0.6	0.6	∞
6	Readout electronics	B	0.3	R	$\sqrt{3}$	1	1	0.3	0.3	∞
7	Response time	B	0.8	R	$\sqrt{3}$	1	1	0.5	0.5	∞
8	Integration time	B	2.6	R	$\sqrt{3}$	1	1	1.5	1.5	∞
9	RF ambient conditions-noise	B	0	R	$\sqrt{3}$	1	1	0	0	∞
10	RF ambient conditions-reflection	B	0	R	$\sqrt{3}$	1	1	0	0	∞
11	Probe positioned mech. restrictions	B	0.4	R	$\sqrt{3}$	1	1	0.2	0.2	∞
12	Probe positioning with respect to phantom shell	B	2.9	R	$\sqrt{3}$	1	1	1.7	1.7	∞
13	Post-processing	B	1.0	R	$\sqrt{3}$	1	1	0.6	0.6	∞
<b>Test sample related</b>										
14	Test sample positioning	A	3.3	N	1	1	1	3.3	3.3	71
15	Device holder uncertainty	A	3.4	N	1	1	1	3.4	3.4	5
16	Drift of output power	B	5.0	R	$\sqrt{3}$	1	1	2.9	2.9	∞
<b>Phantom and set-up</b>										
17	Phantom uncertainty	B	4.0	R	$\sqrt{3}$	1	1	2.3	2.3	∞
18	Liquid conductivity (target)	B	5.0	R	$\sqrt{3}$	0.64	0.43	1.8	1.2	∞
19	Liquid conductivity (meas.)	A	2.06	N	1	0.64	0.43	1.32	0.89	43
20	Liquid permittivity (target)	B	5.0	R	$\sqrt{3}$	0.6	0.49	1.7	1.4	∞
21	Liquid permittivity (meas.)	A	1.6	N	1	0.6	0.49	1.0	0.8	521
Combined standard uncertainty			$u_c = \sqrt{\sum_{i=1}^{21} c_i^2 u_i^2}$					9.25	9.12	257
Expanded uncertainty (confidence interval of 95 %)			$u_e = 2u_c$					18.5	18.2	

### 16.3 Measurement Uncertainty for Fast SAR Tests (300MHz~3GHz)

No.	Error Description	Type	Uncertainty value	Probably Distribution	Div.	(Ci) 1g	(Ci) 10g	Std. Unc. (1g)	Std. Unc. (10g)	Degree of freedom
<b>Measurement system</b>										
1	Probe calibration	B	5.5	N	1	1	1	5.5	5.5	∞
2	Isotropy	B	4.7	R	$\sqrt{3}$	0.7	0.7	1.9	1.9	∞
3	Boundary effect	B	1.0	R	$\sqrt{3}$	1	1	0.6	0.6	∞
4	Linearity	B	4.7	R	$\sqrt{3}$	1	1	2.7	2.7	∞
5	Detection limit	B	1.0	R	$\sqrt{3}$	1	1	0.6	0.6	∞
6	Readout electronics	B	0.3	R	$\sqrt{3}$	1	1	0.3	0.3	∞
7	Response time	B	0.8	R	$\sqrt{3}$	1	1	0.5	0.5	∞
8	Integration time	B	2.6	R	$\sqrt{3}$	1	1	1.5	1.5	∞
9	RF ambient conditions-noise	B	0	R	$\sqrt{3}$	1	1	0	0	∞
10	RF ambient conditions-reflection	B	0	R	$\sqrt{3}$	1	1	0	0	∞
11	Probe positioned mech. Restrictions	B	0.4	R	$\sqrt{3}$	1	1	0.2	0.2	∞
12	Probe positioning with respect to phantom shell	B	2.9	R	$\sqrt{3}$	1	1	1.7	1.7	∞
13	Post-processing	B	1.0	R	$\sqrt{3}$	1	1	0.6	0.6	∞
14	Fast SAR z-Approximation	B	7.0	R	$\sqrt{3}$	1	1	4.0	4.0	∞
<b>Test sample related</b>										
15	Test sample positioning	A	3.3	N	1	1	1	3.3	3.3	71
16	Device holder uncertainty	A	3.4	N	1	1	1	3.4	3.4	5
17	Drift of output power	B	5.0	R	$\sqrt{3}$	1	1	2.9	2.9	∞
<b>Phantom and set-up</b>										
18	Phantom uncertainty	B	4.0	R	$\sqrt{3}$	1	1	2.3	2.3	∞
19	Liquid conductivity (target)	B	5.0	R	$\sqrt{3}$	0.64	0.43	1.8	1.2	∞
20	Liquid conductivity (meas.)	A	2.06	N	1	0.64	0.43	1.32	0.89	43
21	Liquid permittivity (target)	B	5.0	R	$\sqrt{3}$	0.6	0.49	1.7	1.4	∞
22	Liquid permittivity (meas.)	A	1.6	N	1	0.6	0.49	1.0	0.8	521
Combined standard uncertainty		$u_c = \sqrt{\sum_{i=1}^{22} c_i^2 u_i^2}$						10.1	9.95	257
Expanded uncertainty (confidence interval of 95 %)		$u_e = 2u_c$						20.2	19.9	



## 17 MAIN TEST INSTRUMENTS

**Table 17.1: List of Main Instruments**

No.	Name	Type	Serial Number	Calibration Date	Valid Period
01	Network analyzer	Agilent E5071C	MY46103759	December 27,2013	One year
02	Power meter	NRVD	101253	March 6, 2014	One year
03	Power sensor	NRV-Z5	100333		
04	Signal Generator	E4438C	MY45095825	January 14, 2014	One year
05	Amplifier	VTL5400	0404	No Calibration Requested	
06	BTS	E5515C	GB47460133	September 4, 2014	One year
07	E-field Probe	SPEAG ES3DV3	3151	September 01, 2014	One year
08	DAE	SPEAG DAE4	786	November 25, 2013	One year
09	Dipole Validation Kit	SPEAG D835V2	4d069	August 28, 2014	Two year
10	Dipole Validation Kit	SPEAG D1900V2	5d101	July 23, 2014	Two year
11	Dipole Validation Kit	SPEAG D2450V2	853	July 24, 2014	Two year

\*\*\*END OF REPORT BODY\*\*\*

## ANNEX A Graph Results

### GSM850 Left Cheek High

Date: 2014-11-5

Electronics: DAE4 Sn786

Medium: Head 900 MHz

Medium parameters used (interpolated):  $f = 848.8$  MHz;  $\sigma = 0.919$  S/m;  $\epsilon_r = 41.723$ ;  $\rho = 1000$  kg/m<sup>3</sup>

Ambient Temperature: 20.5°C      Liquid Temperature: 20.0°C

Communication System: GSM Frequency: 848.8 MHz Duty Cycle: 1:8.30042

Probe: ES3DV3 - SN3151 ConvF(6.04, 6.04, 6.04); Calibrated: 2014-9-1

**Left Cheek High/Area Scan (61x181x1):** Interpolated grid: dx=1.000 mm, dy=1.000 mm

Maximum value of SAR (interpolated) = 0.483 W/kg

**Left Cheek High/Zoom Scan (7x7x7)/Cube 0:** Measurement grid: dx=5mm, dy=5mm, dz=5mm

Reference Value = 7.591 V/m; Power Drift = -0.12 dB

Peak SAR (extrapolated) = 0.581 W/kg

**SAR(1 g) = 0.440 W/kg; SAR(10 g) = 0.326 W/kg**

Maximum value of SAR (measured) = 0.463 W/kg

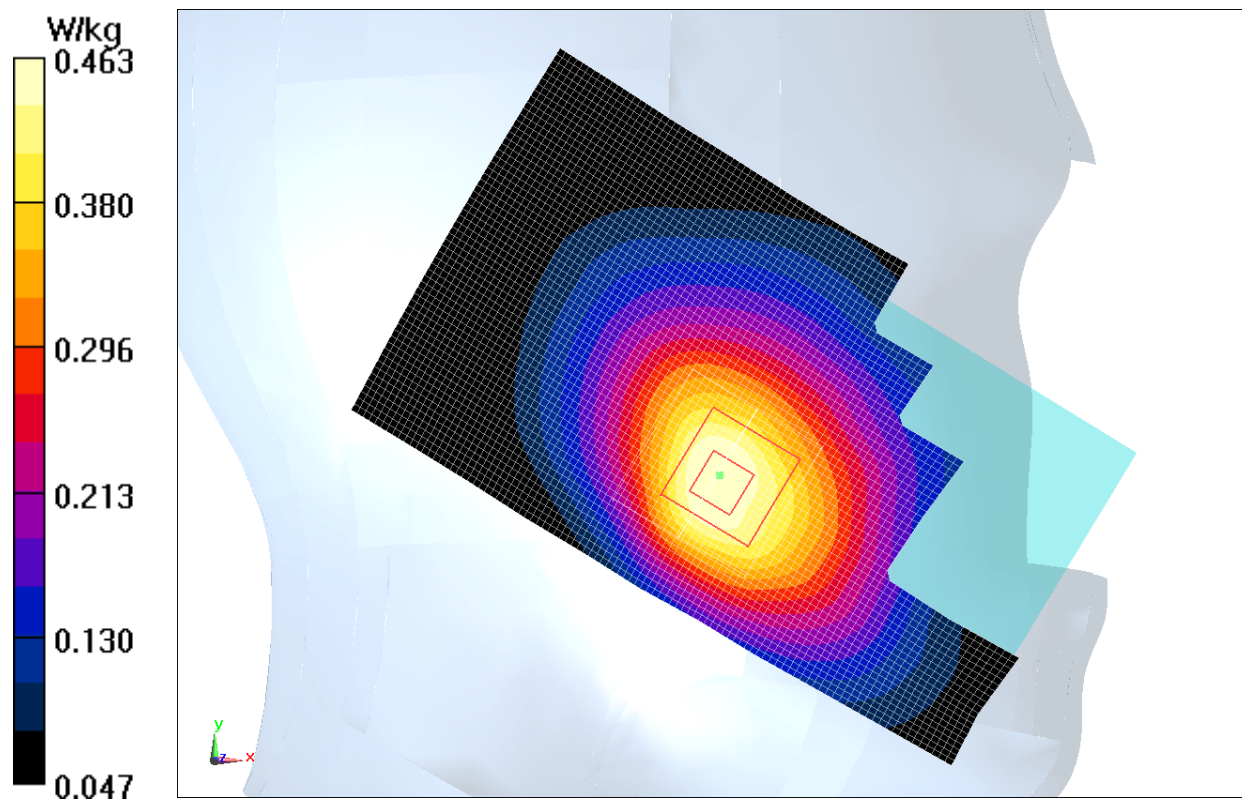
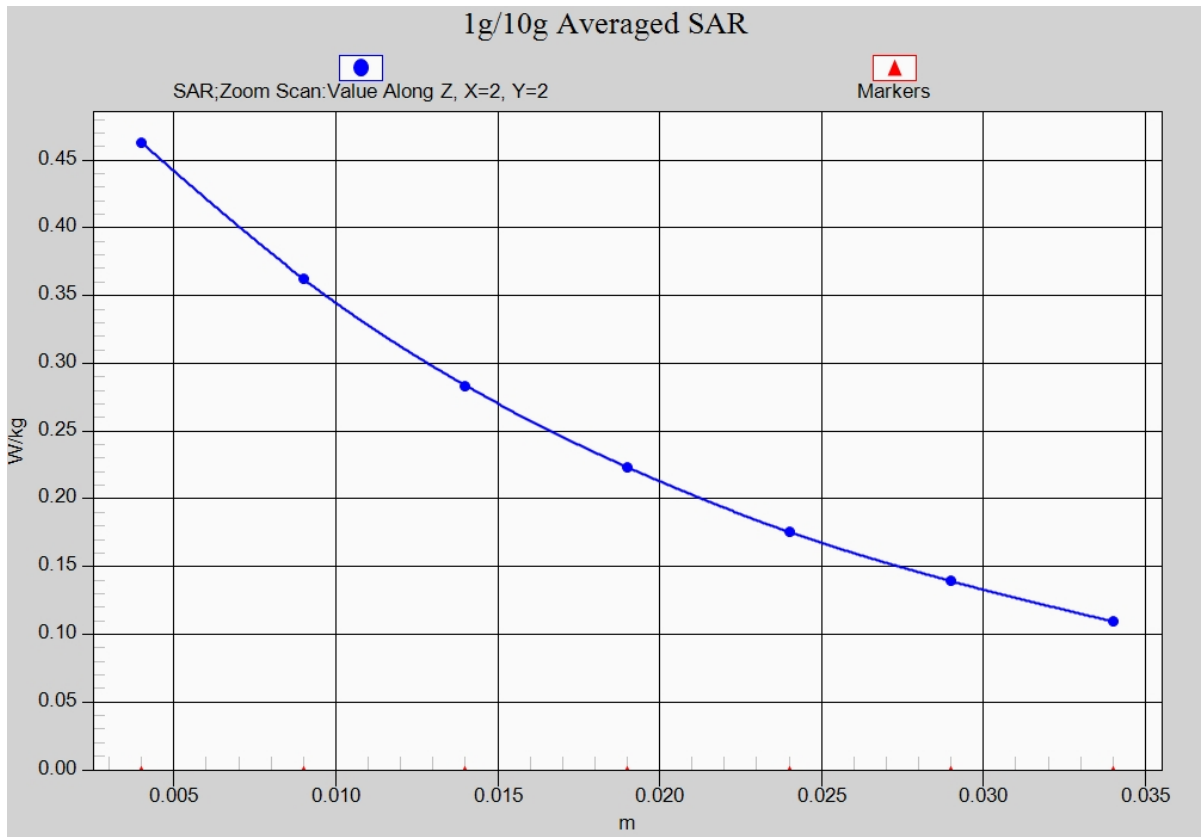

Fig.1 850 MHz CH251



**Fig. 1-1 Z-Scan at power reference point (850 MHz CH251)**

### GSM850 Body Rear High with Hotspot on

Date: 2014-11-3

Electronics: DAE4 Sn786

Medium: Body 900 MHz

Medium parameters used (interpolated):  $f = 848.8$  MHz;  $\sigma = 1.01$  S/m;  $\epsilon_r = 55.686$ ;  $\rho = 1000$  kg/m<sup>3</sup>

Ambient Temperature: 20.9°C      Liquid Temperature: 20.4°C

Communication System: 4 slot GPRS Frequency: 848.8 MHz Duty Cycle: 1:2.08

Probe: ES3DV3 - SN3151 ConvF(6.14, 6.14, 6.14); Calibrated: 2014-9-1

**Rear side High/Area Scan (61x181x1):** Interpolated grid: dx=1.000 mm, dy=1.000 mm

Maximum value of SAR (interpolated) = 0.930 W/kg

**Rear side High/Zoom Scan (7x7x7)/Cube 0:** Measurement grid: dx=5mm, dy=5mm, dz=5mm

Reference Value = 29.288 V/m; Power Drift = 0.10 dB

Peak SAR (extrapolated) = 1.09 W/kg

**SAR(1 g) = 0.875 W/kg; SAR(10 g) = 0.666 W/kg**

Maximum value of SAR (measured) = 0.914 W/kg

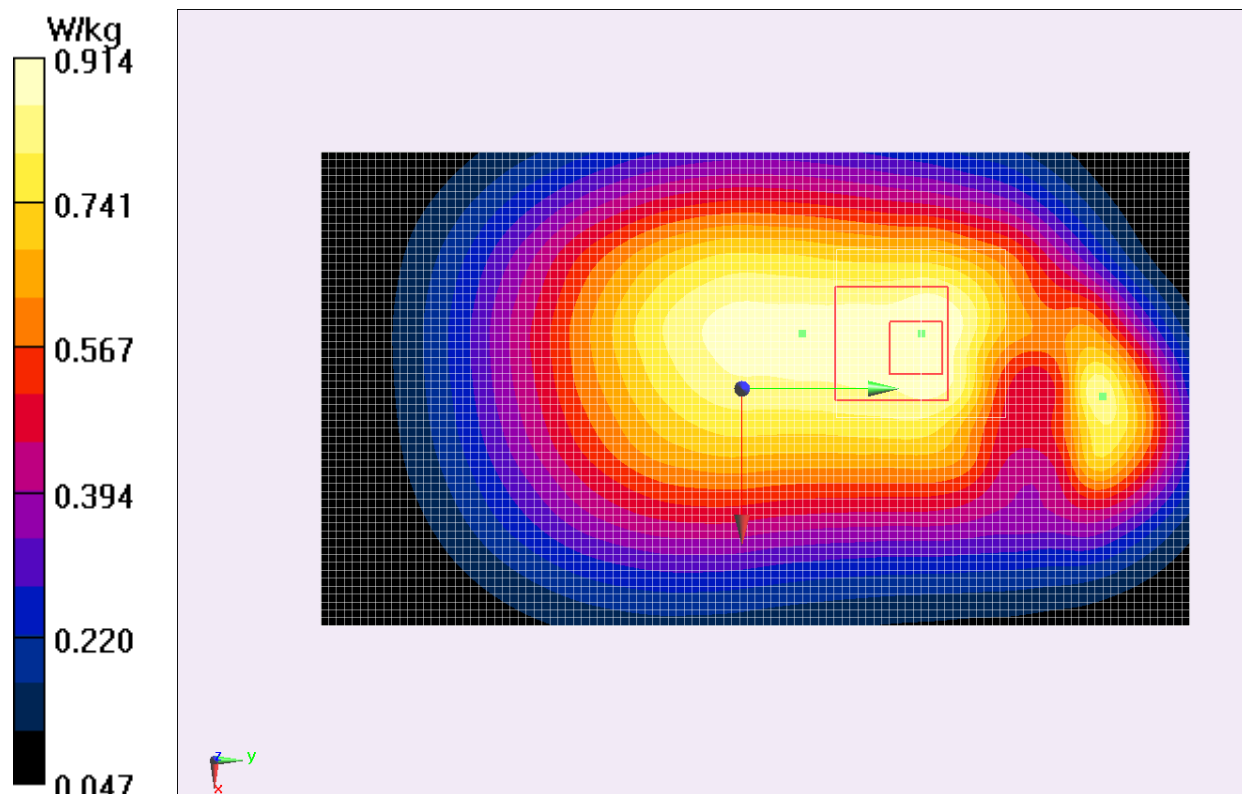
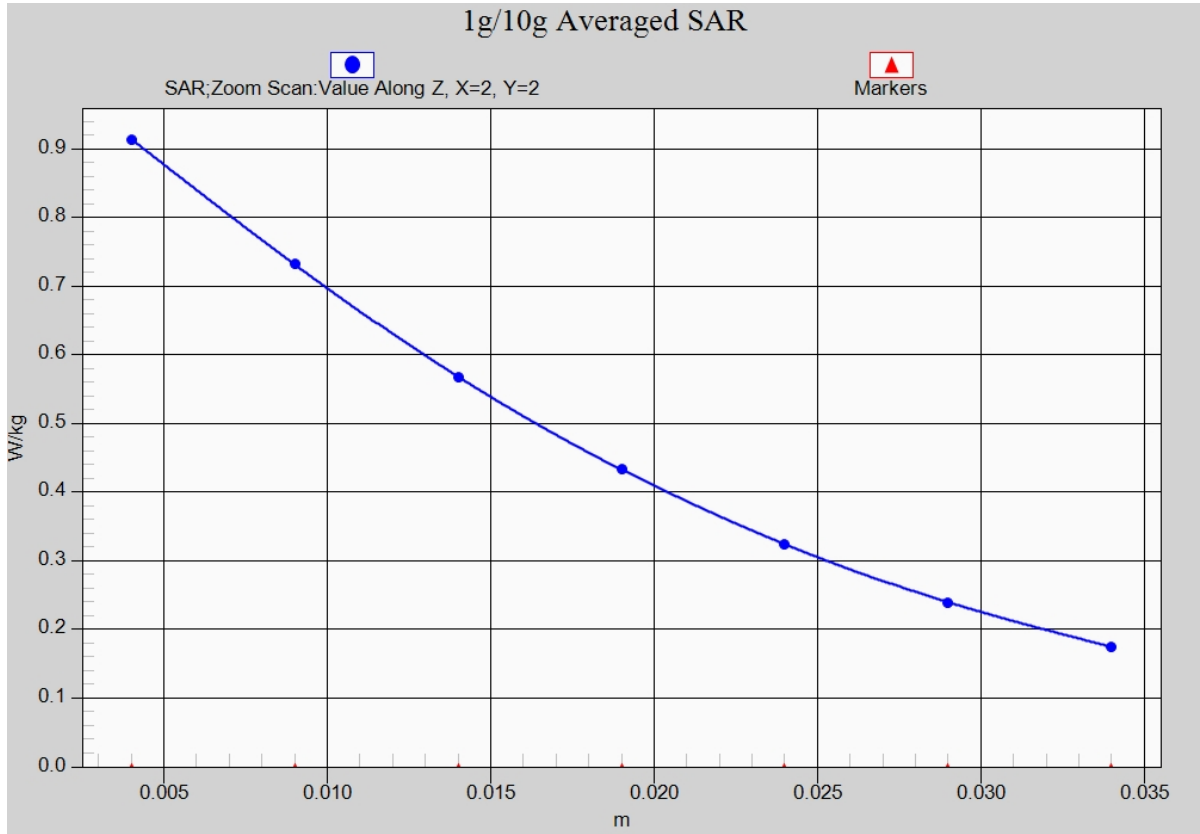

Fig.2 850 MHz CH251 Hotspot on



**Fig.2-1 Z-Scan at power reference point (850 MHz CH251) Hotspot on**

### GSM1900 Right Cheek Low

Date: 2014-11-4

Electronics: DAE4 Sn786

Medium: Head 1900 MHz

Medium parameters used (interpolated):  $f = 1850.2$  MHz;  $\sigma = 1.39$  S/m;  $\epsilon_r = 41.224$ ;  $\rho = 1000$  kg/m<sup>3</sup>

Ambient Temperature: 20.3°C      Liquid Temperature: 19.8°C

Communication System: GSM Frequency: 1850.2 MHz Duty Cycle: 1:8.3

Probe: ES3DV3 - SN3151 ConvF(5.16, 5.16, 5.16); Calibrated: 2014-9-1

**Right Cheek Low/Area Scan (61x121x1):** Interpolated grid: dx=1.000 mm, dy=1.000 mm

Maximum value of SAR (interpolated) = 0.257 W/kg

**Right Cheek Low/Zoom Scan (7x7x7)/Cube 0:** Measurement grid: dx=5mm, dy=5mm, dz=5mm

Reference Value = 4.744 V/m; Power Drift = -0.19 dB

Peak SAR (extrapolated) = 0.333 W/kg

**SAR(1 g) = 0.221 W/kg; SAR(10 g) = 0.141 W/kg**

Maximum value of SAR (measured) = 0.242 W/kg

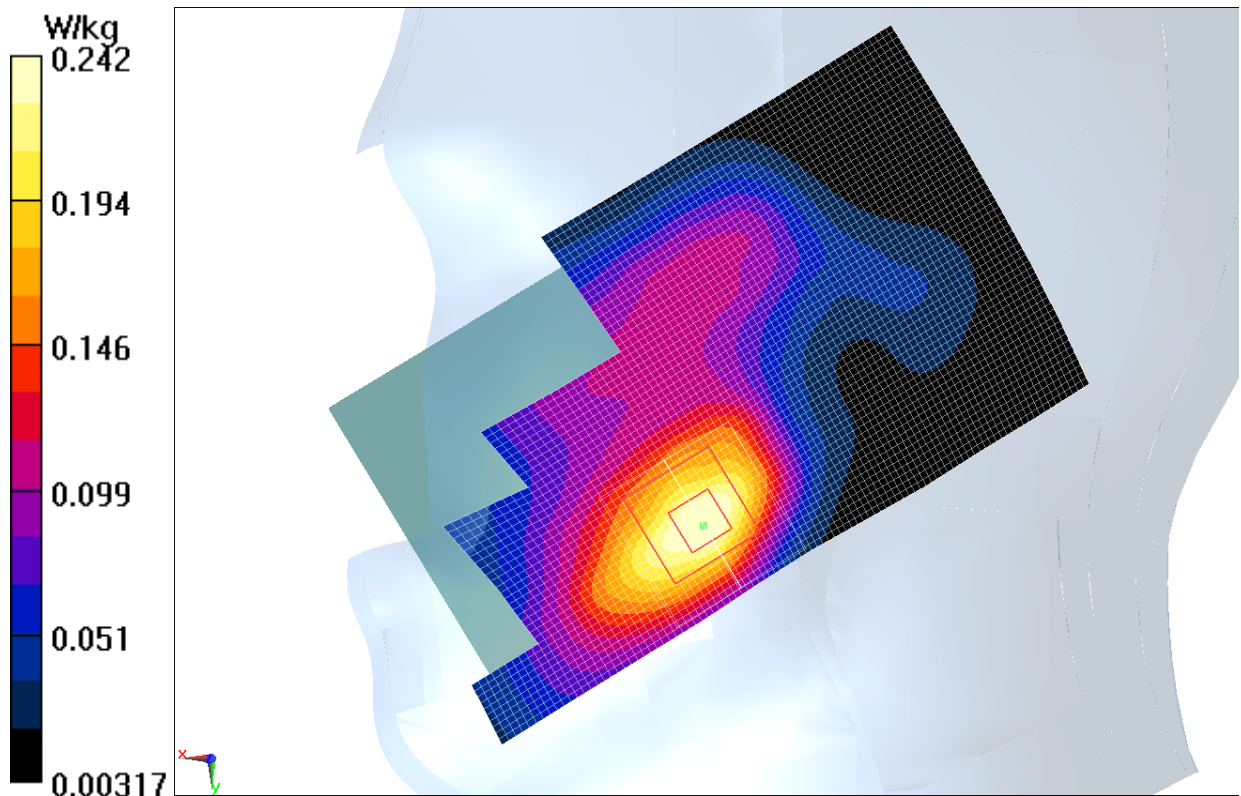

Fig.3 1900 MHz CH512

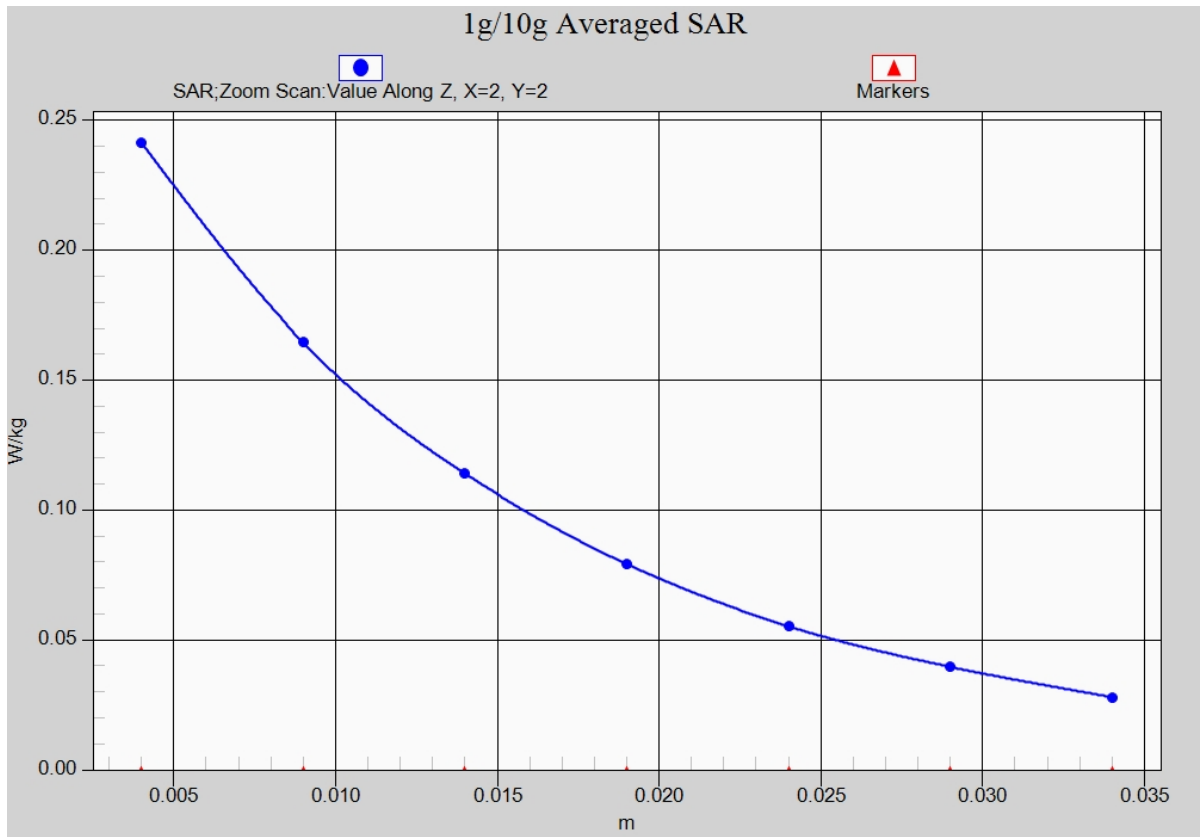

Fig. 3-1 Z-Scan at power reference point (1900 MHz CH512)

### GSM1900 Body Rear side Low with Hotspot on

Date: 2014-10-30

Electronics: DAE4 Sn786

Medium: Body 1900MHz

Medium parameters used (interpolated):  $f = 1850.2$  MHz;  $\sigma = 1.497$  S/m;  $\epsilon_r = 51.842$ ;  $\rho = 1000$  kg/m<sup>3</sup>

Ambient Temperature: 21.7°C      Liquid Temperature: 21.2°C

Communication System: 4 slot GPRS Frequency: 1850.2 MHz Duty Cycle: 1:2.08

Probe: ES3DV3 - SN3151 ConvF(4.77, 4.77, 4.77); Calibrated: 2014-9-1

**Rear side Low/Area Scan (61x121x1):** Interpolated grid: dx=1.000 mm, dy=1.000 mm

Maximum value of SAR (interpolated) = 0.974 W/kg

**Rear side Low/Zoom Scan (7x7x7)/Cube 0:** Measurement grid: dx=5mm, dy=5mm, dz=5mm

Reference Value = 11.114 V/m; Power Drift = 0.03 dB

Peak SAR (extrapolated) = 1.47 W/kg

**SAR(1 g) = 0.874 W/kg; SAR(10 g) = 0.490 W/kg**

Maximum value of SAR (measured) = 0.985 W/kg

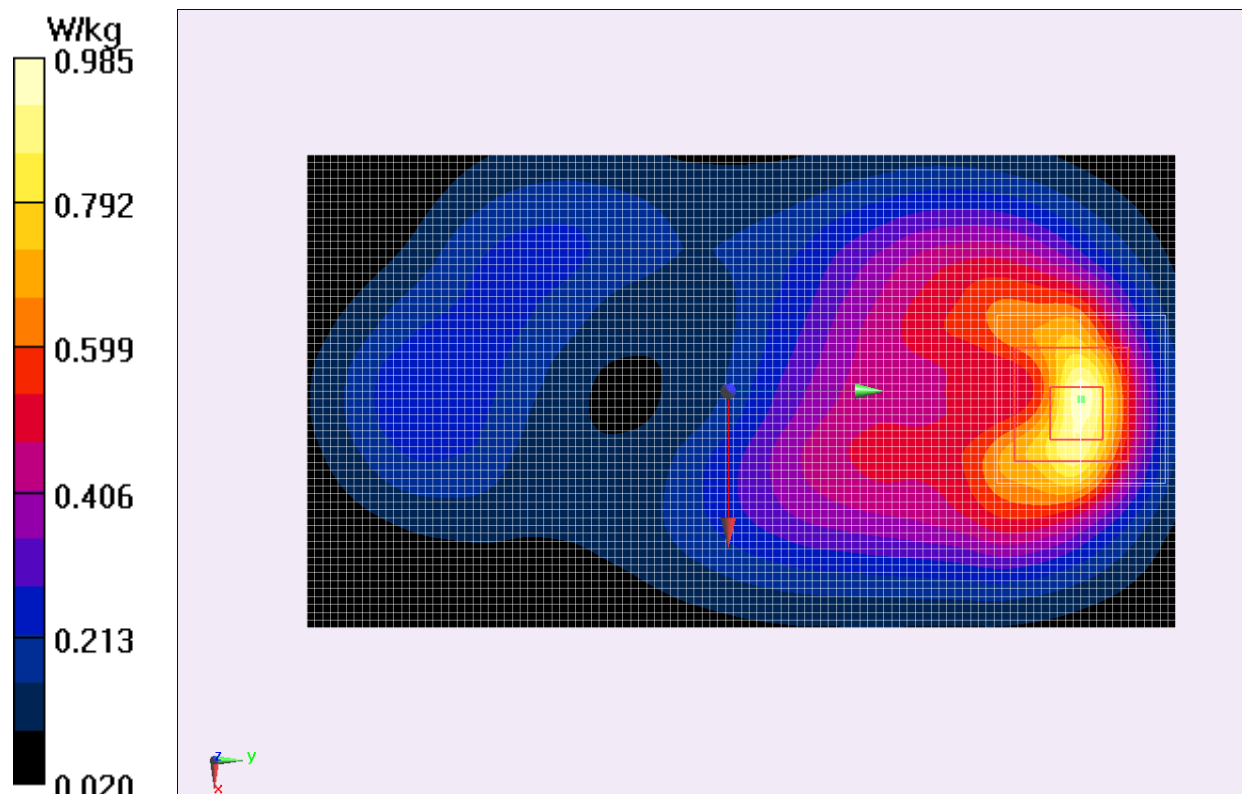

**Fig.4 1900 MHz CH512 Hotspot on**



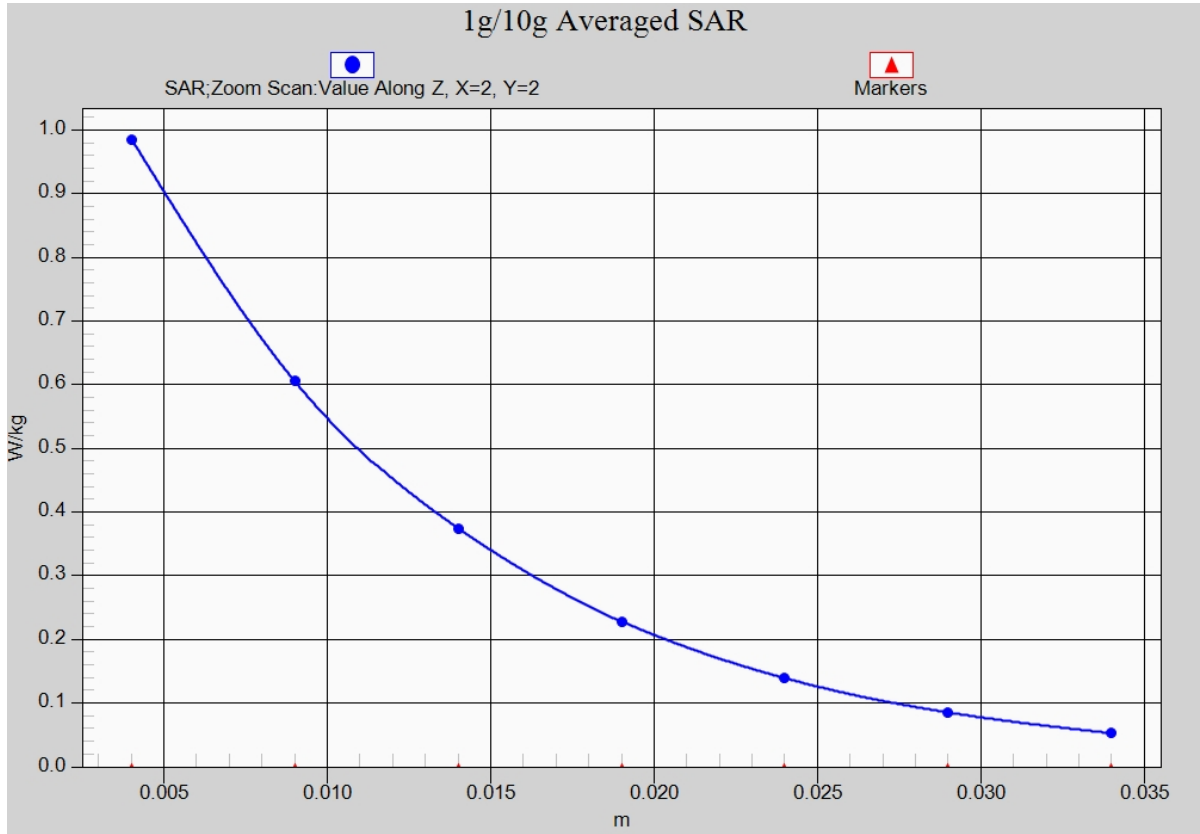

**Fig.4-1 Z-Scan at power reference point (1900 MHz CH512) Hotspot on**

**WCDMA 850 Left Cheek High**

Date: 2014-11-5

Electronics: DAE4 Sn786

Medium: Head 900 MHz

Medium parameters used (interpolated):  $f = 846.6$  MHz;  $\sigma = 0.934$  S/m;  $\epsilon_r = 41.721$ ;  $\rho = 1000$  kg/m<sup>3</sup>

Ambient Temperature: 21.7°C      Liquid Temperature: 21.2°C

Communication System: WCDMA Frequency: 846.6 MHz Duty Cycle: 1:1

Probe: ES3DV3 - SN3151 ConvF(6.04, 6.04, 6.04); Calibrated: 2014-9-1

**Left Cheek High/Area Scan (61x111x1):** Interpolated grid: dx=1.000 mm, dy=1.000 mm

Maximum value of SAR (interpolated) = 0.488 W/kg

**Left Cheek High/Zoom Scan (7x7x7)/Cube 0:** Measurement grid: dx=5mm, dy=5mm, dz=5mm

Reference Value = 6.589 V/m; Power Drift = -0.07 dB

Peak SAR (extrapolated) = 0.594 W/kg

**SAR(1 g) = 0.445 W/kg; SAR(10 g) = 0.330 W/kg**

Maximum value of SAR (measured) = 0.468 W/kg

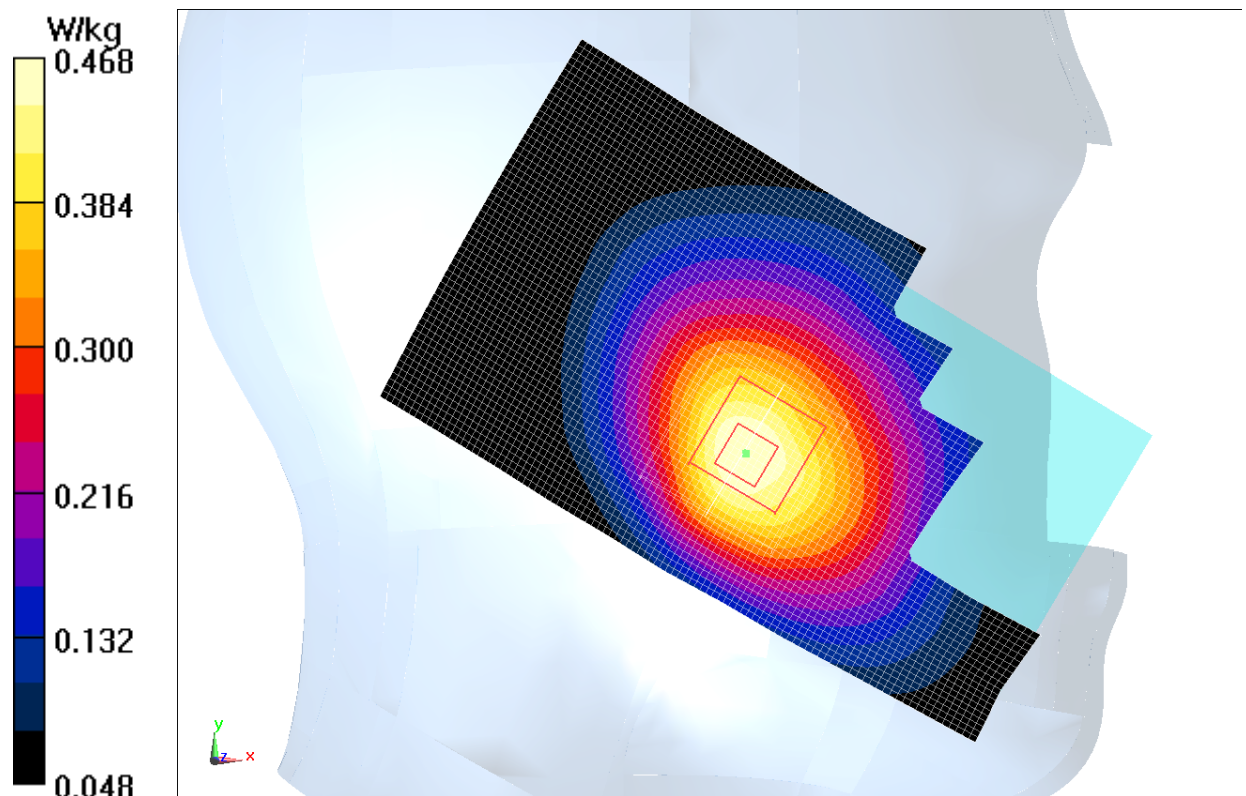

**Fig.5 Right Hand Touch Cheek WCDMA 850MHz CH4233**

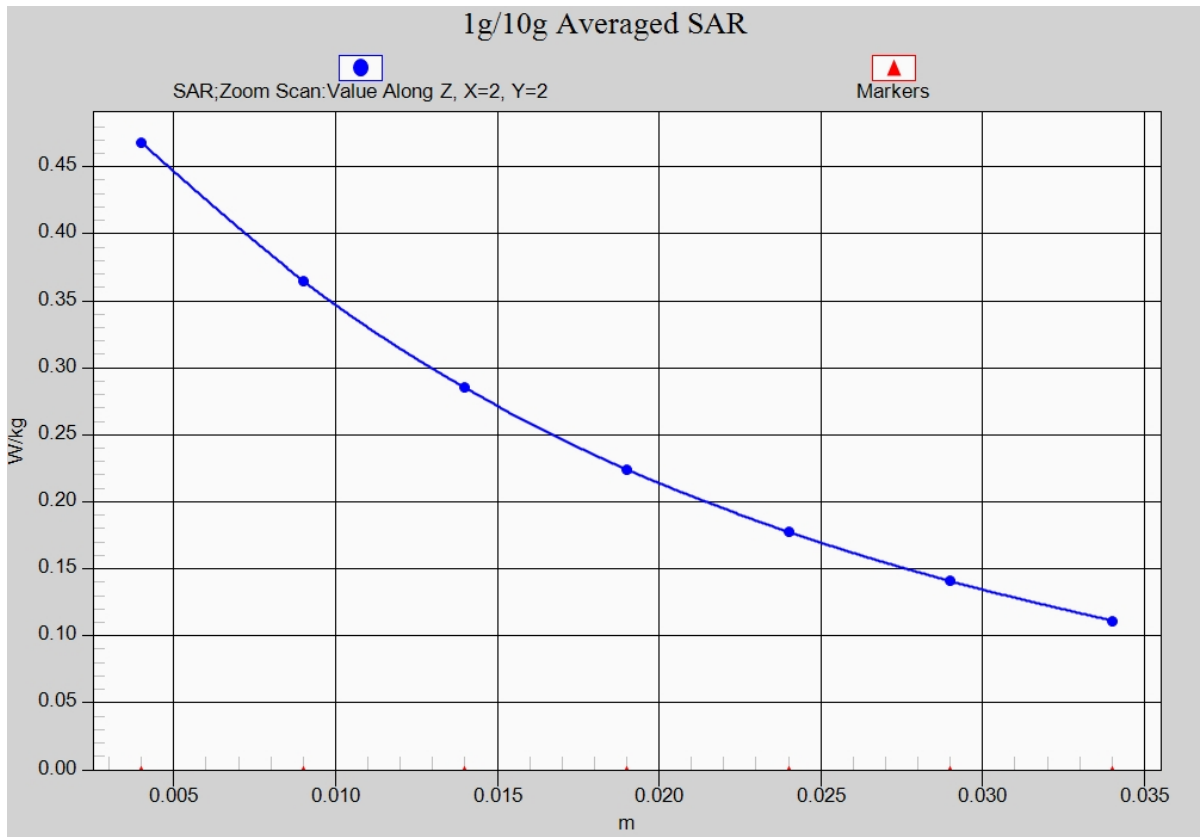

**Fig.5-1 Z-Scan at power reference point (850 MHz CH4233) Hotspot on**

**WCDMA850 Body Rear Middle with Hotspot on**

Date: 2014-11-3

Electronics: DAE4 Sn786

Medium: Body 900 MHz

Medium parameters used (interpolated):  $f = 836.6$  MHz;  $\sigma = 0.995$  S/m;  $\epsilon_r = 55.704$ ;  $\rho = 1000$  kg/m<sup>3</sup>

Ambient Temperature: 21.1°C      Liquid Temperature: 20.6°C

Communication System: WCDMA Frequency: 836.6 MHz Duty Cycle: 1:1

Probe: ES3DV3 - SN3151 ConvF(6.14, 6.14, 6.14); Calibrated: 2014-9-1

**Rear side Middle/Area Scan (61x111x1):** Interpolated grid: dx=1.000 mm, dy=1.000 mm

Maximum value of SAR (interpolated) = 0.496 W/kg

**Rear side Middle/Zoom Scan (7x7x7)/Cube 0:** Measurement grid: dx=5mm, dy=5mm, dz=5mm

Reference Value = 20.636 V/m; Power Drift = 0.04 dB

Peak SAR (extrapolated) = 0.586 W/kg

**SAR(1 g) = 0.466 W/kg; SAR(10 g) = 0.351 W/kg**

Maximum value of SAR (measured) = 0.491 W/kg

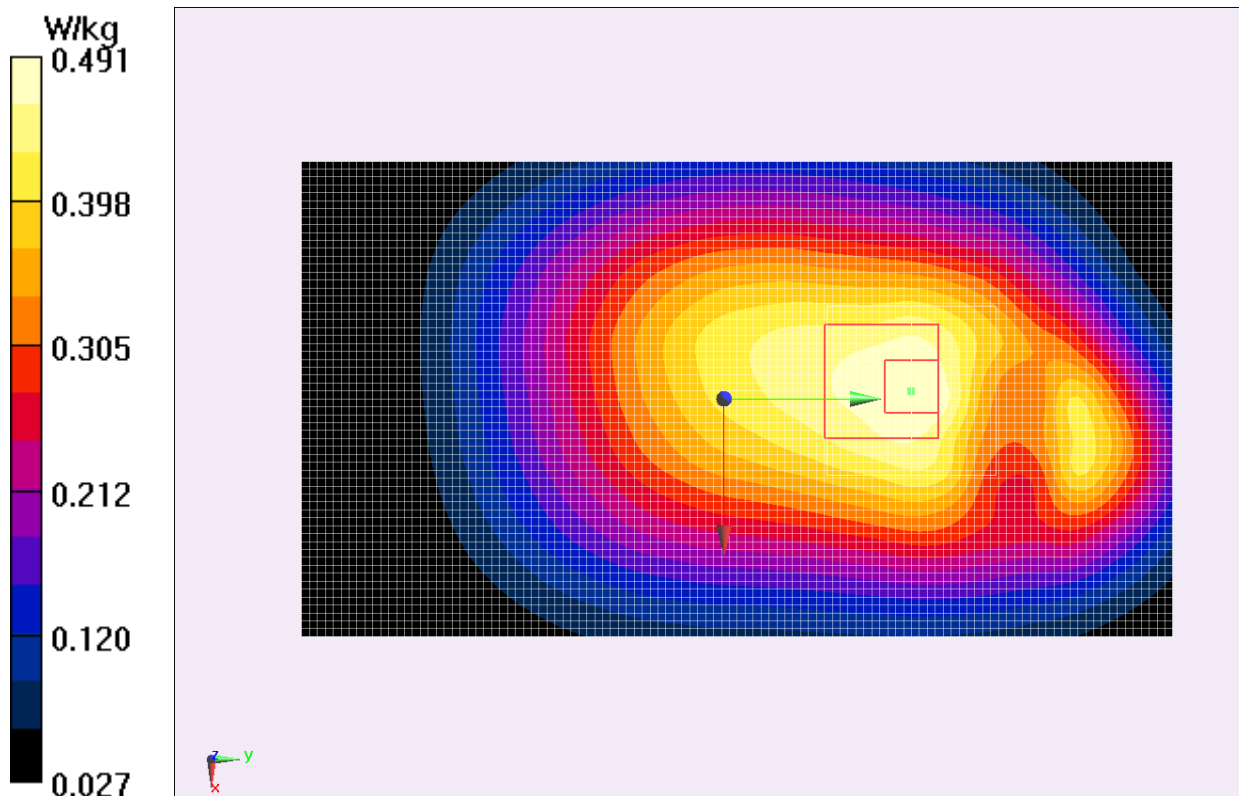

**Fig.6 Body WCDMA 850MHz CH4183**

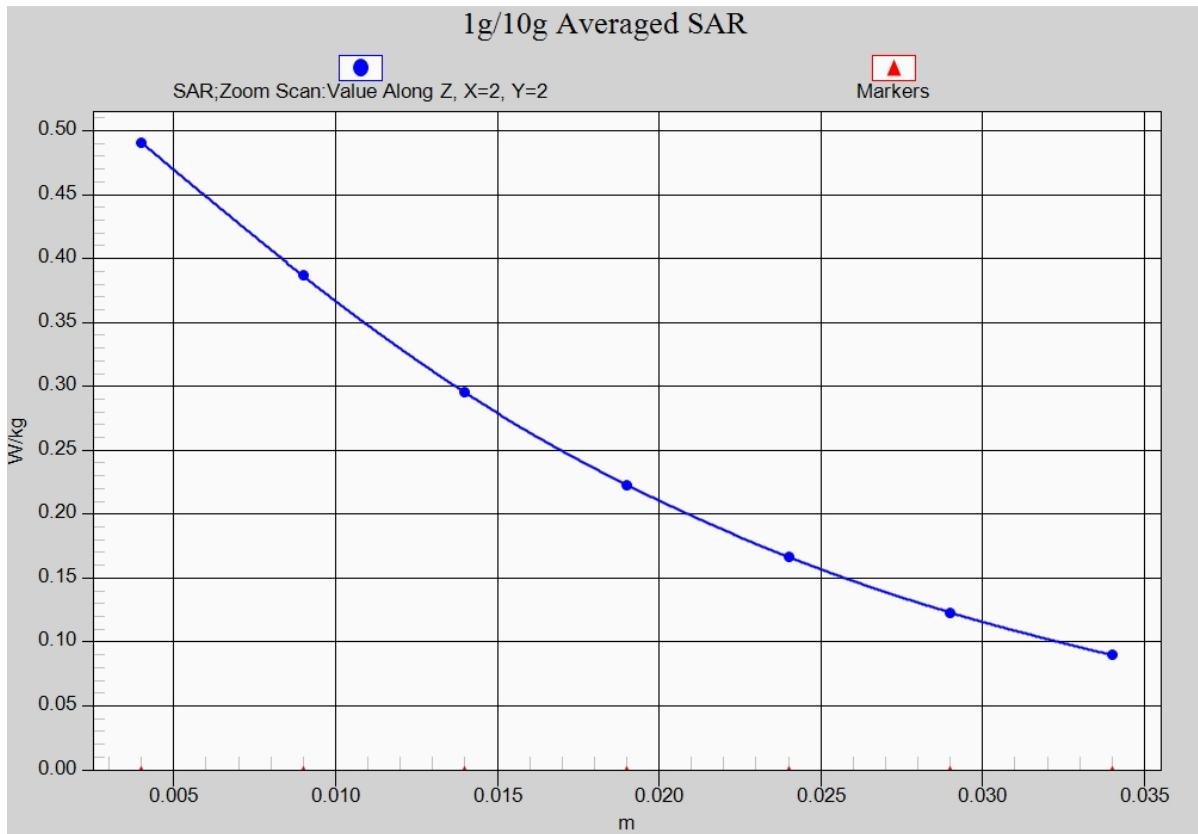

**Fig.6-1 Z-Scan at power reference point (WCDMA 850MHz CH4183) Hotspot on**

**WCDMA 1900 Right Cheek Low**

Date: 2014-11-4

Electronics: DAE4 Sn786

Medium: Head 1900 MHz

Medium parameters used (interpolated):  $f = 1852.4$  MHz;  $\sigma = 1.392$  S/m;  $\epsilon_r = 41.266$ ;  $\rho = 1000$  kg/m<sup>3</sup>

Ambient Temperature: 21.7°C      Liquid Temperature: 21.2°C

Communication System: WCDMA Frequency: 1852.4 MHz Duty Cycle: 1:1

Probe: ES3DV3 - SN3151 ConvF(5.16, 5.16, 5.16); Calibrated: 2014-9-1

**Right Cheek Low/Area Scan (61x111x1):** Interpolated grid: dx=1.000 mm, dy=1.000 mm

Maximum value of SAR (interpolated) = 0.444 W/kg

**Right Cheek Low/Zoom Scan (7x7x7)/Cube 0:** Measurement grid: dx=5mm, dy=5mm, dz=5mm

Reference Value = 5.073 V/m; Power Drift = 0.13 dB

Peak SAR (extrapolated) = 0.581 W/kg

**SAR(1 g) = 0.382 W/kg; SAR(10 g) = 0.242 W/kg**

Maximum value of SAR (measured) = 0.418 W/kg

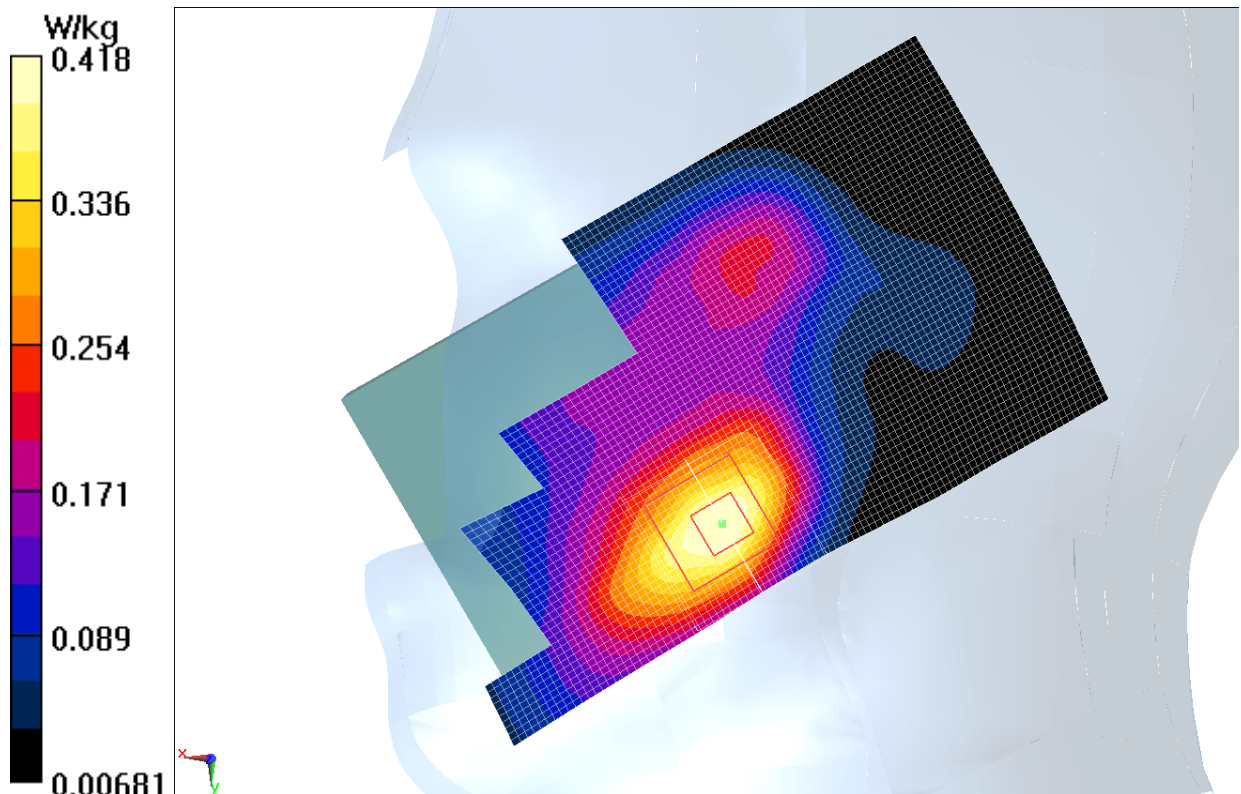

**Fig.7 Right Hand Touch Cheek WCDMA 850MHz CH9262**

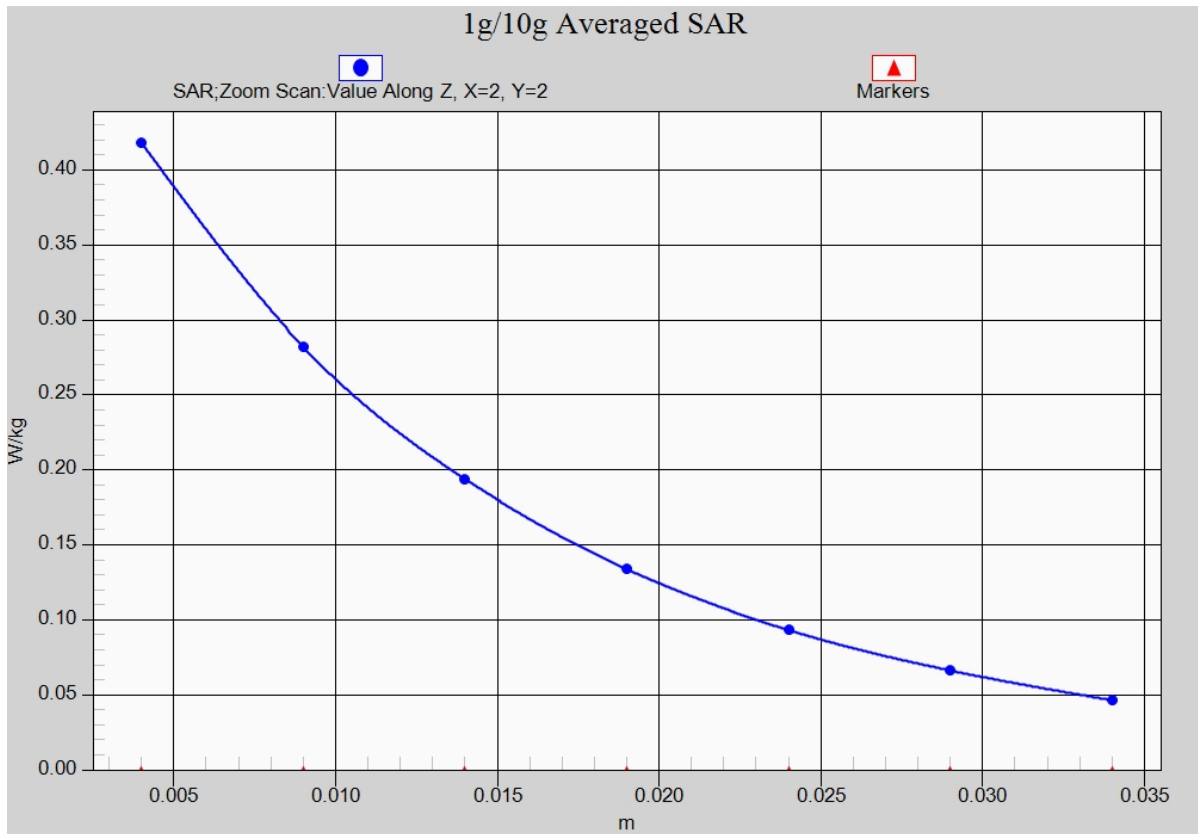

**Fig.7-1 Z-Scan at power reference point (1900 MHz CH9262) Hotspot on**

**WCDMA1900 Body Bottom High with Hotspot on**

Date/Time: 2014-10-30

Electronics: DAE4 Sn786

Medium: Body 1900

Medium parameters used:  $f = 1908 \text{ MHz}$ ;  $\sigma = 1.513 \text{ S/m}$ ;  $\epsilon_r = 52.627$ ;  $\rho = 1000 \text{ kg/m}^3$

Ambient Temperature:  $21.7^\circ\text{C}$       Liquid Temperature:  $21.2^\circ\text{C}$

Communication System: WCDMA Frequency: 1908 MHz Duty Cycle: 1:1

Probe: ES3DV3 - SN3151 ConvF(4.77, 4.77, 4.77); Calibrated: 2014-9-1

**Bottom side High/Area Scan (61x111x1):** Interpolated grid:  $dx=1.000 \text{ mm}$ ,  $dy=1.000 \text{ mm}$

Maximum value of SAR (interpolated) =  $0.844 \text{ W/kg}$

**Bottom side High/Zoom Scan (7x7x7)/Cube 0:** Measurement grid:  $dx=5\text{mm}$ ,  $dy=5\text{mm}$ ,  $dz=5\text{mm}$

Reference Value =  $22.766 \text{ V/m}$ ; Power Drift =  $0.16 \text{ dB}$

Peak SAR (extrapolated) =  $1.32 \text{ W/kg}$

**SAR(1 g) =  $0.765 \text{ W/kg}$ ; SAR(10 g) =  $0.407 \text{ W/kg}$**

Maximum value of SAR (measured) =  $0.869 \text{ W/kg}$

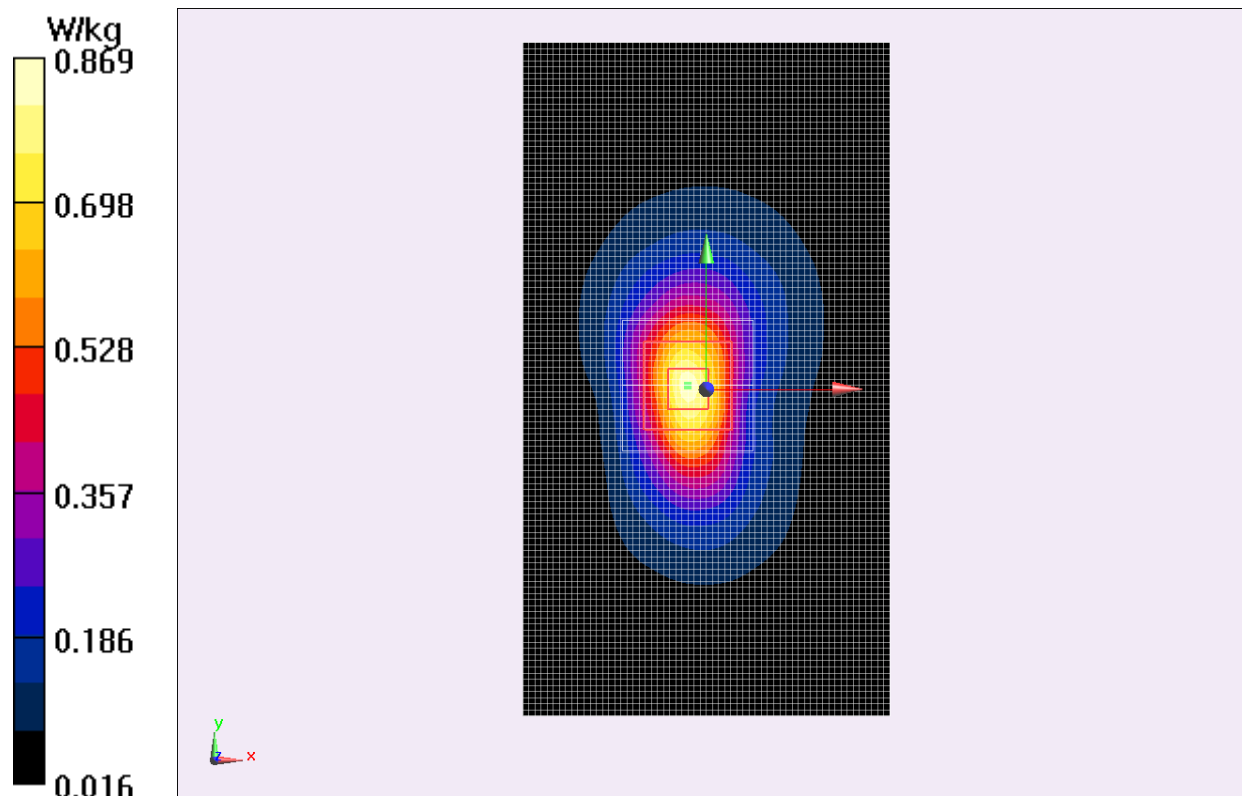

**Fig.8 Body WCDMA 1900MHz CH9400**



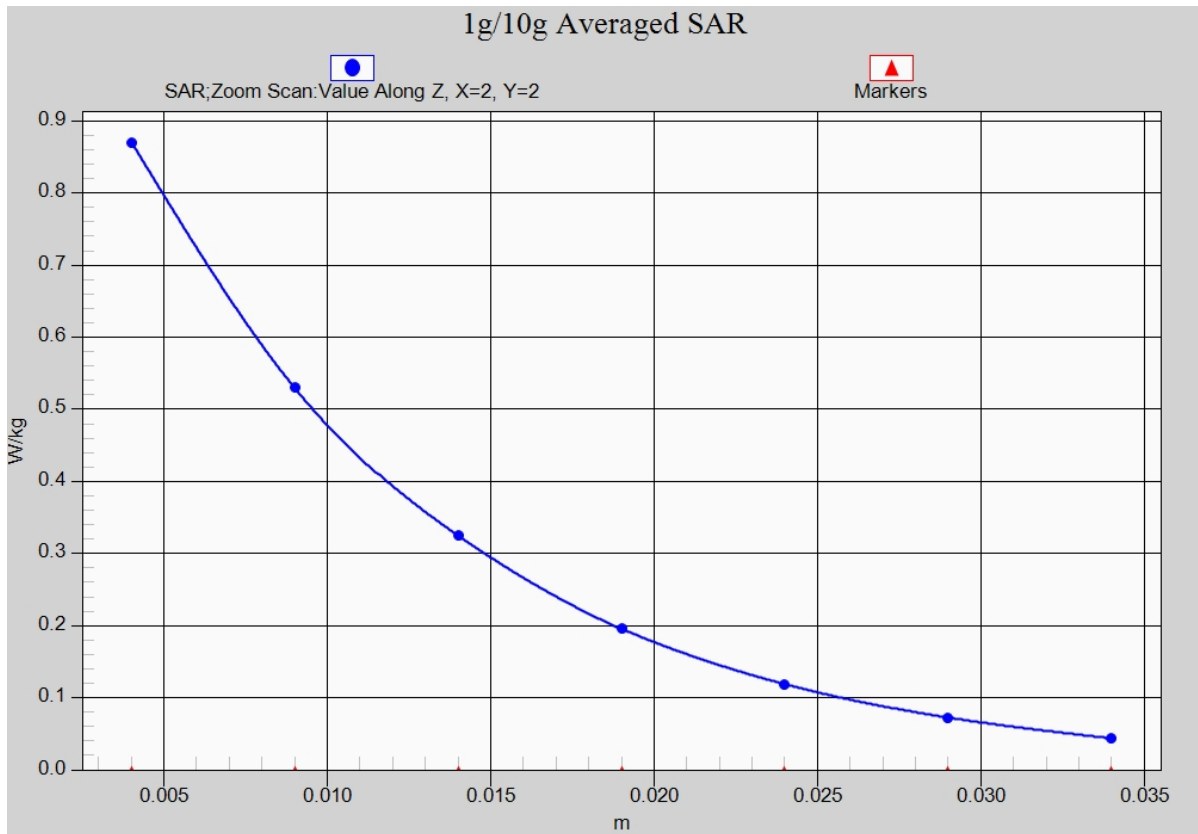

**Fig.8-1 Z-Scan at power reference point (WCDMA 1900MHz CH9400) Hotspot on**

**WiFi 802.11b 1Mbps left Cheek Channel 13**

Date: 2014-11-19

Electronics: DAE4 Sn786

Medium: Head 2450 MHz

Medium parameters used:  $f = 2462$  MHz;  $\sigma = 1.873$  S/m;  $\epsilon_r = 38.573$ ;  $\rho = 1000$  kg/m<sup>3</sup>

Ambient Temperature: 22.7°C      Liquid Temperature: 22.2°C

Communication System: WiFi Frequency: 2462 MHz Duty Cycle: 1:1

Probe: ES3DV3 - SN3151 ConvF(4.71, 4.71, 4.71); Calibrated: 2014-9-1

**left/Cheek High/Area Scan (61x111x1):** Interpolated grid: dx=1.000 mm, dy=1.000 mm

Maximum value of SAR (interpolated) = 0.650 W/kg

**left/Cheek High/Zoom Scan (7x7x7)/Cube 0:** Measurement grid: dx=5mm, dy=5mm, dz=5mm

Reference Value = 8.172 V/m; Power Drift = 0.14 dB

Peak SAR (extrapolated) = 1.23 W/kg

**SAR(1 g) = 0.592 W/kg; SAR(10 g) = 0.286 W/kg**

Maximum value of SAR (measured) = 0.674 W/kg

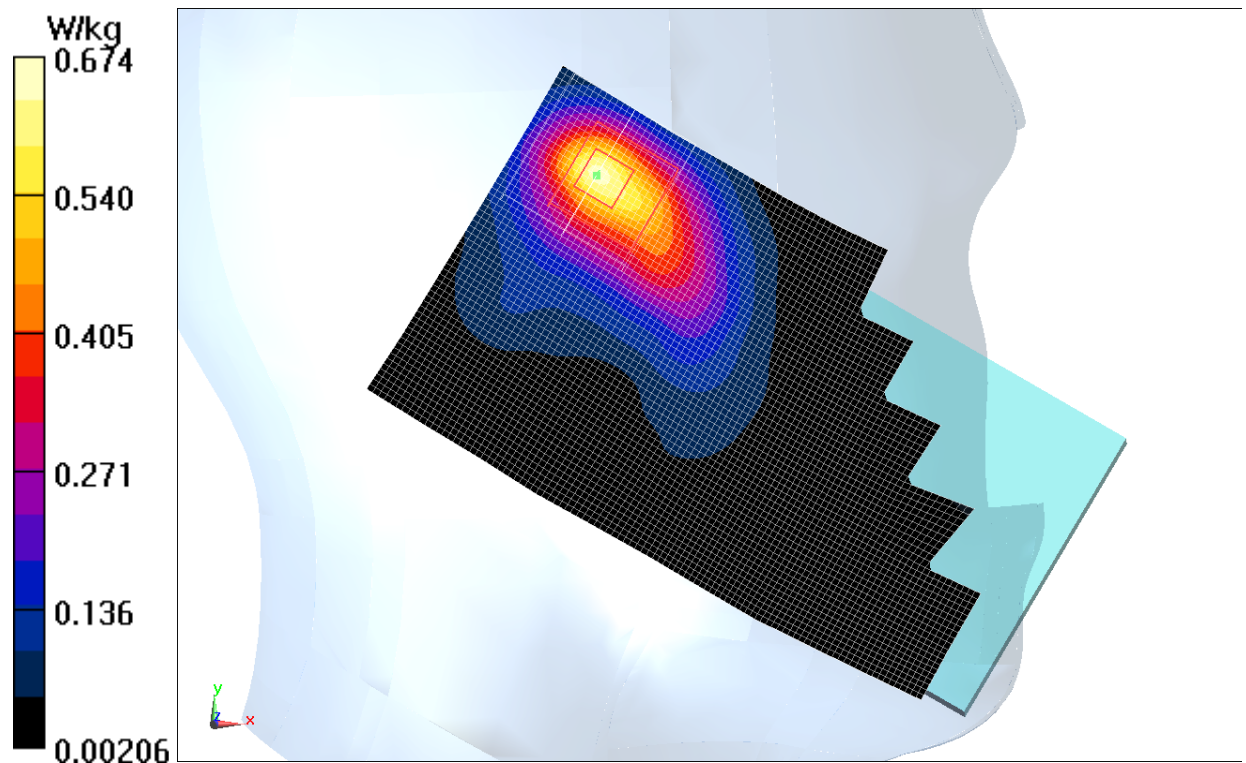

**Fig.9 802.11b 1Mbps CH13**

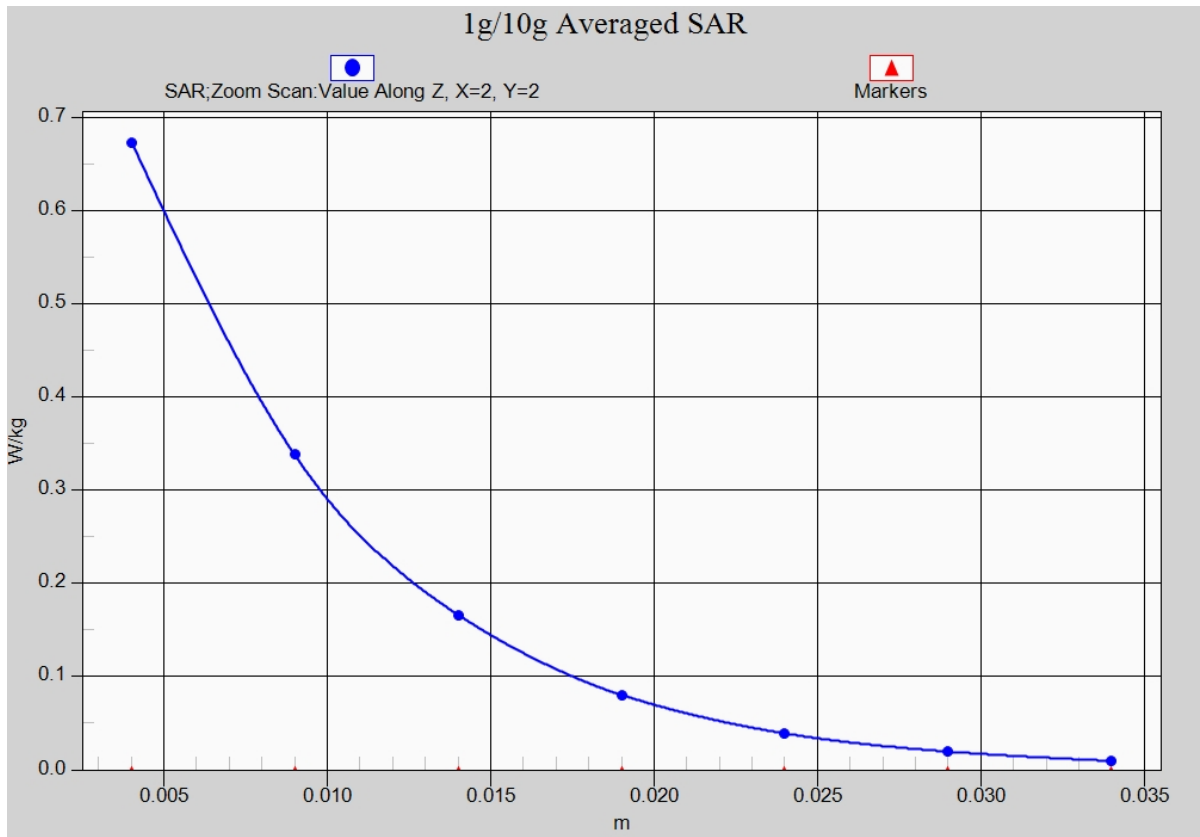

**Fig. 9-1 Z-Scan at power reference point (802.11b 1Mbps CH13)**

**WiFi 802.11b 1Mbps Body Rear Channel 1**

Date: 2014-10-29

Electronics: DAE4 Sn786

Medium: Body 2450 MHz

Medium parameters used:  $f = 2412$  MHz;  $\sigma = 1.892$  S/m;  $\epsilon_r = 52.665$ ;  $\rho = 1000$  kg/m<sup>3</sup>

Ambient Temperature: 22.7°C      Liquid Temperature: 22.2°C

Communication System: WiFi Frequency: 2412 MHz Duty Cycle: 1:1

Probe: ES3DV3 - SN3151 ConvF(4.42, 4.42, 4.42); Calibrated: 2014-9-1

**Rear side Low/Area Scan (61x111x1):** Interpolated grid: dx=1.000 mm, dy=1.000 mm

Maximum value of SAR (interpolated) = 0.338 W/kg

**Rear side Low/Zoom Scan (7x7x7)/Cube 0:** Measurement grid: dx=5mm, dy=5mm, dz=5mm

Reference Value = 7.198 V/m; Power Drift = -0.02 dB

Peak SAR (extrapolated) = 0.604 W/kg

**SAR(1 g) = 0.297 W/kg; SAR(10 g) = 0.150 W/kg**

Maximum value of SAR (measured) = 0.322 W/kg

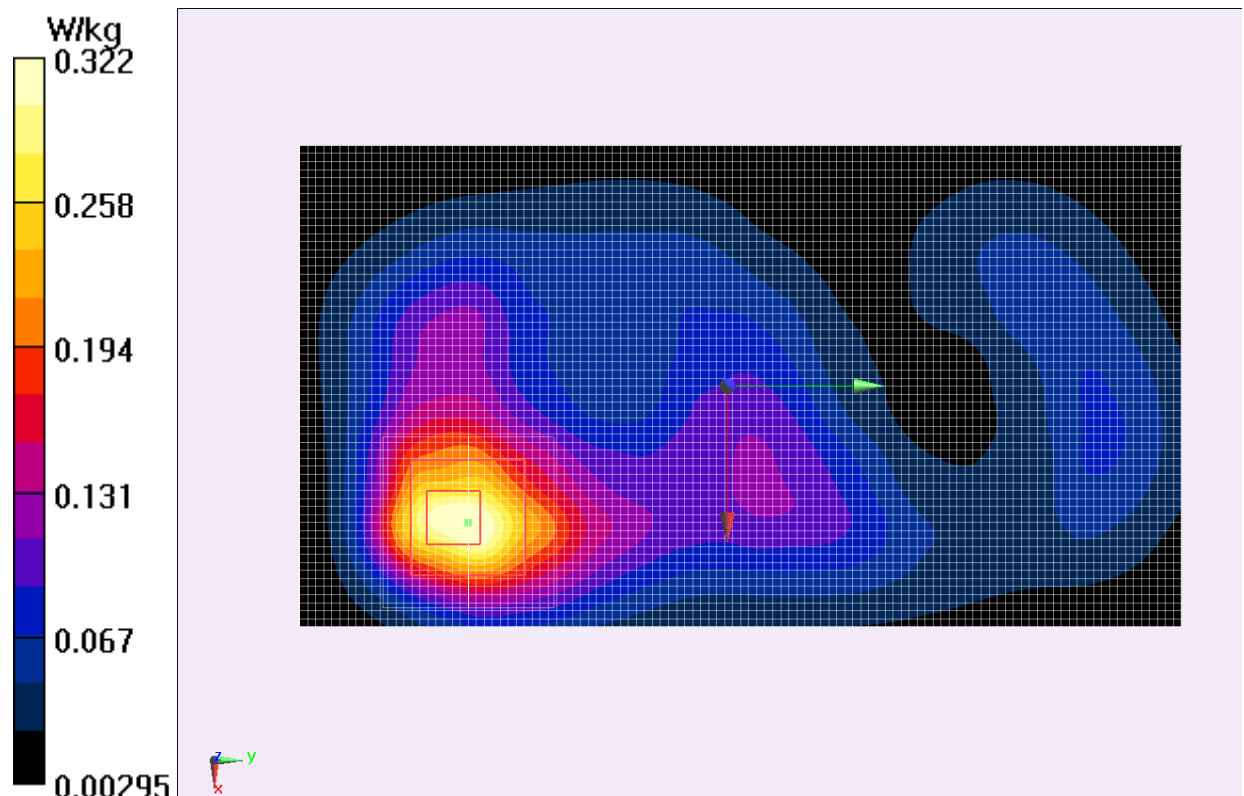

**Fig.10 802.11b 1Mbps CH1**

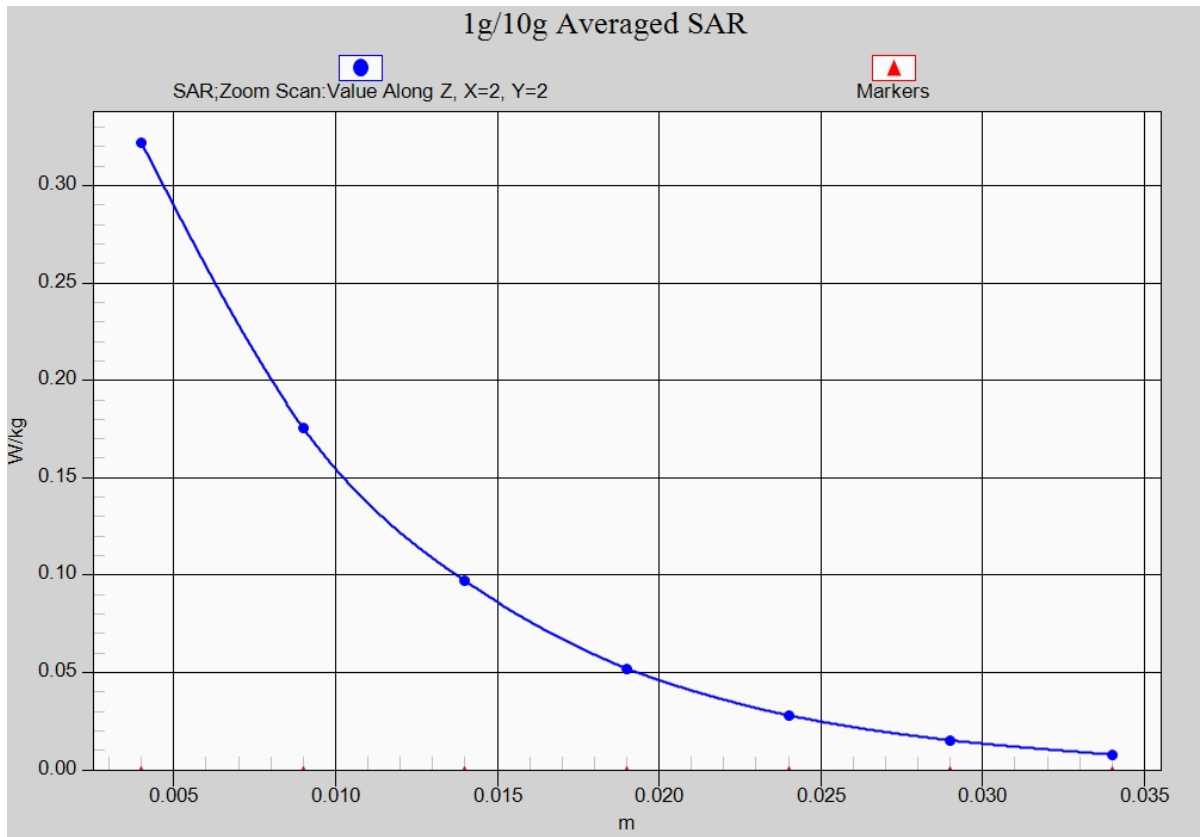

Fig. 10-1 Z-Scan at power reference point (802.11b 1Mbps CH1)

## ANNEX B System Verification Results

### 835MHz

Date: 2014-11-5

Electronics: DAE4 Sn786

Medium: Head 900MHz

Medium parameters used (interpolated):  $f = 835 \text{ MHz}$ ;  $\sigma = 0.912\text{S/m}$ ;  $\epsilon_r = 41.861$ ;  $\rho = 1000 \text{ kg/m}^3$

Ambient Temperature:  $20.5^\circ\text{C}$       Liquid Temperature:  $20.0^\circ\text{C}$

Communication System: CW\_TMC Frequency: 835 MHz Duty Cycle: 1:1

Probe: ES3DV3 - SN3151 ConvF(6.04, 6.04, 6.04);

**System Validation /Area Scan (61x181x1):** Interpolated grid:  $dx=1.000 \text{ mm}$ ,  $dy=1.000 \text{ mm}$

**Fast SAR: SAR(1 g) = 2.43 W/kg; SAR(10 g) = 1.59 W/kg**

Maximum value of SAR (interpolated) = 2.62 W/kg

**System Validation /Zoom Scan (7x7x7)/Cube 0:** Measurement grid:  $dx=5\text{mm}$ ,  $dy=5\text{mm}$ ,  $dz=5\text{mm}$

Reference Value = 54.722 V/m; Power Drift = 0.02 dB

Peak SAR (extrapolated) = 3.69 W/kg

**SAR(1 g) = 2.44 W/kg; SAR(10 g) = 1.61 W/kg**

Maximum value of SAR (measured) = 2.64 W/kg

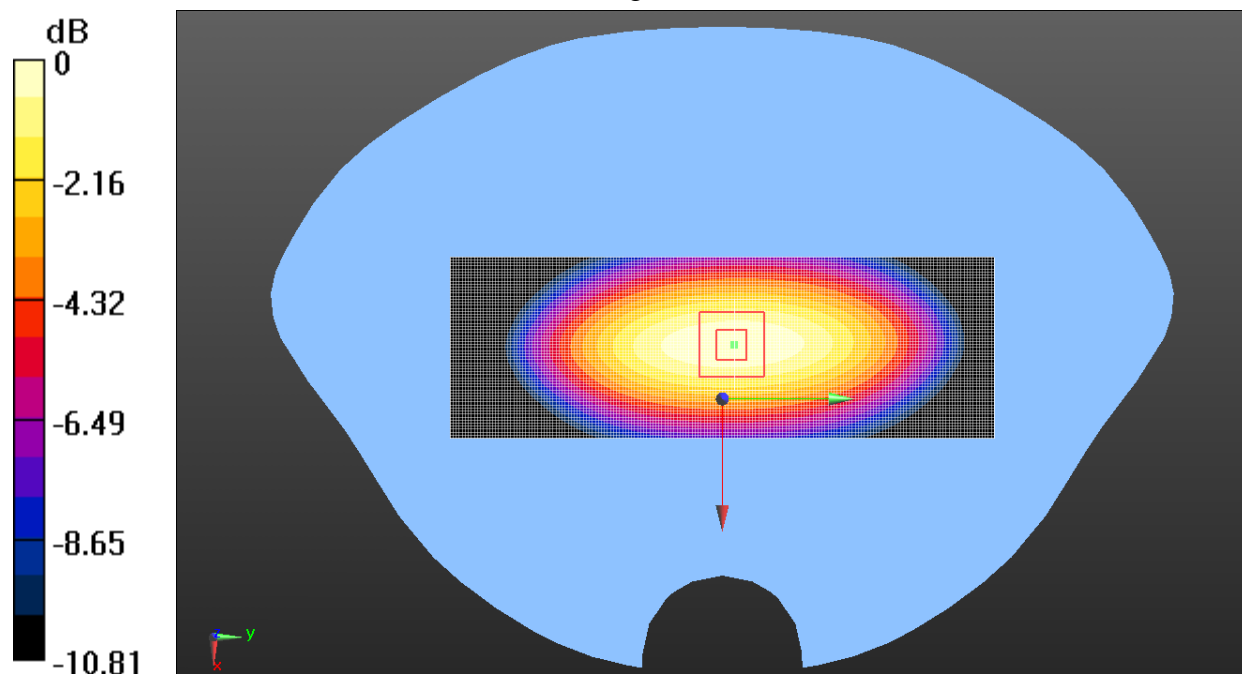

0 dB = 2.64 W/kg = 1.84 dBW/kg

**Fig.B.1 validation 835MHz 250mW**

## 835MHz

Date: 2014-11-3

Electronics: DAE4 Sn786

Medium: Body 900 MHz

Medium parameters used (interpolated):  $f = 835 \text{ MHz}$ ;  $\sigma = 0.998 \text{ S/m}$ ;  $\epsilon_r = 55.113$ ;  $\rho = 1000 \text{ kg/m}^3$

Ambient Temperature:  $23.8^\circ\text{C}$       Liquid Temperature:  $23.3^\circ\text{C}$

Communication System: CW\_TMC Frequency: 835 MHz Duty Cycle: 1:1

Probe: ES3DV3 - SN3151 ConvF(6.14, 6.14, 6.14);

**System Validation /Area Scan (61x181x1):** Interpolated grid:  $dx=1.000 \text{ mm}$ ,  $dy=1.000 \text{ mm}$

**Fast SAR: SAR(1 g) = 2.40 W/kg; SAR(10 g) = 1.56 W/kg**

Maximum value of SAR (interpolated) = 2.61 W/kg

**System Validation /Zoom Scan (7x7x7)/Cube 0:** Measurement grid:  $dx=5\text{mm}$ ,  $dy=5\text{mm}$ ,  $dz=5\text{mm}$

Reference Value = 53.566 V/m; Power Drift = -0.02 dB

Peak SAR (extrapolated) = 3.58 W/kg

**SAR(1 g) = 2.42 W/kg; SAR(10 g) = 1.59 W/kg**

Maximum value of SAR (measured) = 2.62 W/kg

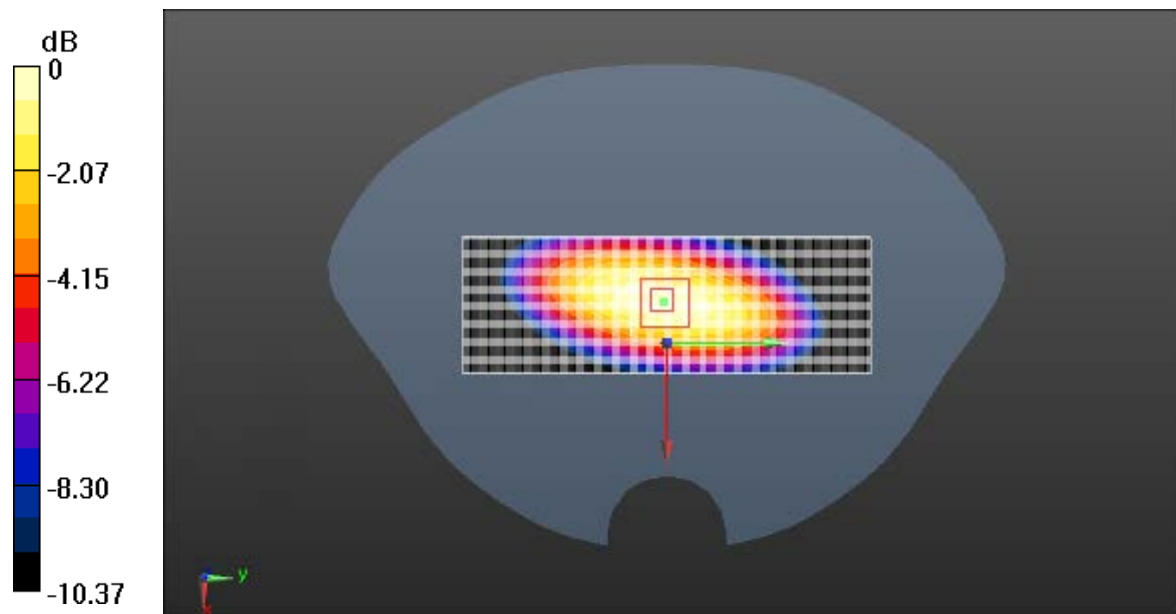

0 dB = 2.62 W/kg = 1.83 dBW/kg

**Fig.B.2 validation 835MHz 250mW**

## 1900MHz

Date: 2014-11-4

Electronics: DAE4 Sn786

Medium: Head 1900 MHz

Medium parameters used:  $f = 1900$  MHz;  $\sigma = 1.402$  S/m;  $\epsilon_r = 41.192$ ;  $\rho = 1000$  kg/m<sup>3</sup>

Ambient Temperature: 24.3°C      Liquid Temperature: 23.8°C

Communication System: CW\_TMC Frequency: 1900 MHz Duty Cycle: 1:1

Probe: ES3DV3 - SN3151 ConvF(5.16, 5.16, 5.16);

**System Validation /Area Scan (61x121x1):** Interpolated grid: dx=1.000 mm, dy=1.000 mm

Maximum value of SAR (interpolated) = 11.5 W/kg

**Fast SAR: SAR(1 g) = 9.88 W/kg; SAR(10 g) = 5.08 W/kg**

Maximum value of SAR (interpolated) = 13.5 W/kg

**System Validation /Zoom Scan (7x7x7)/Cube 0:** Measurement grid: dx=5mm, dy=5mm, dz=5mm

Reference Value = 86.259 V/m; Power Drift = -0.09 dB

Peak SAR (extrapolated) = 18.4 W/kg

**SAR(1 g) = 10.1 W/kg; SAR(10 g) = 5.20 W/kg**

Maximum value of SAR (measured) = 11.6 W/kg

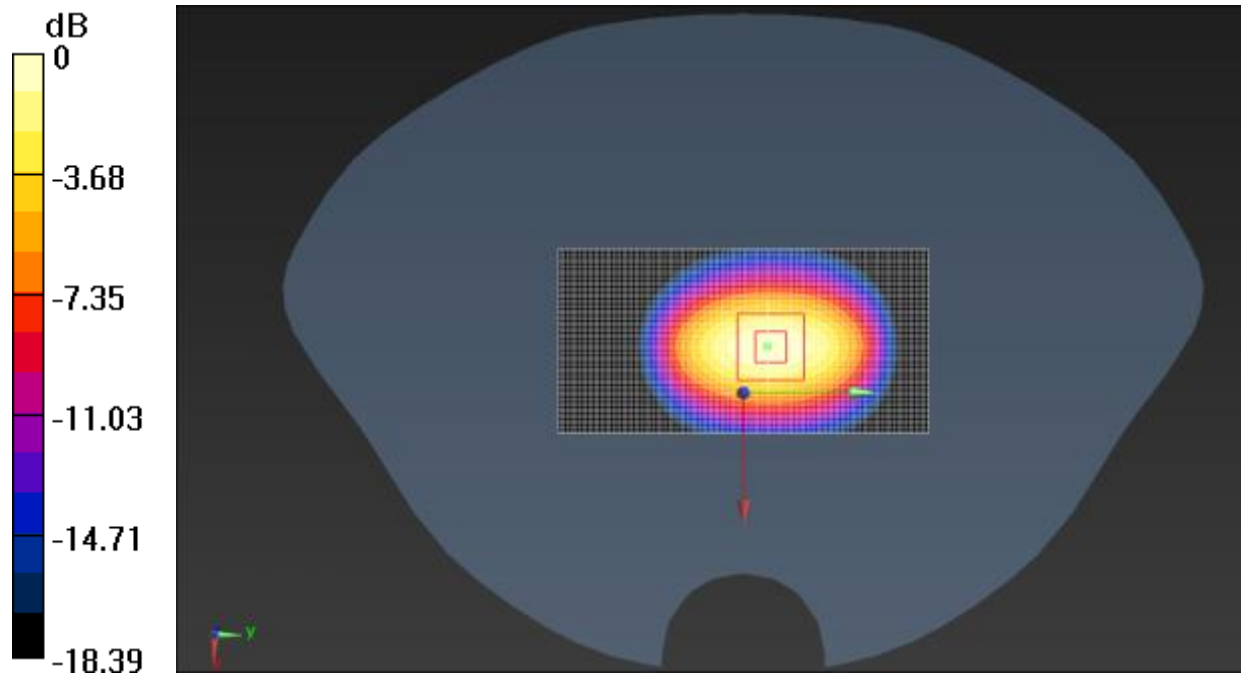

0 dB = 11.6 W/kg = 10.64 dBW/kg

**Fig.B.1 validation 1900MHz 250mW**



## 1900MHz

Date: 2014-10-30

Electronics: DAE4 Sn786

Medium: Body 1900MHz

Medium parameters used:  $f = 1900 \text{ MHz}$ ;  $\sigma = 1.512 \text{ S/m}$ ;  $\epsilon_r = 52.615$ ;  $\rho = 1000 \text{ kg/m}^3$

Ambient Temperature:  $22.5^\circ\text{C}$       Liquid Temperature:  $22.0^\circ\text{C}$

Communication System: CW\_TMC Frequency: 1900 MHz Duty Cycle: 1:1

Probe: ES3DV3 - SN3151 ConvF(4.77, 4.77, 4.77);

**System validation /Area Scan (61x121x1):** Interpolated grid:  $dx=1.000 \text{ mm}$ ,  $dy=1.000 \text{ mm}$

Maximum value of SAR (interpolated) =  $12.4 \text{ W/kg}$

**Fast SAR: SAR(1 g) =  $10.2 \text{ W/kg}$ ; SAR(10 g) =  $5.39 \text{ W/kg}$**

Maximum value of SAR (interpolated) =  $13.5 \text{ W/kg}$

**System validation /Zoom Scan (7x7x7)/Cube 0:** Measurement grid:  $dx=5\text{mm}$ ,  $dy=5\text{mm}$ ,  $dz=5\text{mm}$

Reference Value =  $60.339 \text{ V/m}$ ; Power Drift =  $0.08 \text{ dB}$

Peak SAR (extrapolated) =  $19.3 \text{ W/kg}$

**SAR(1 g) =  $10.3 \text{ W/kg}$ ; SAR(10 g) =  $5.41 \text{ W/kg}$**

Maximum value of SAR (measured) =  $12.4 \text{ W/kg}$

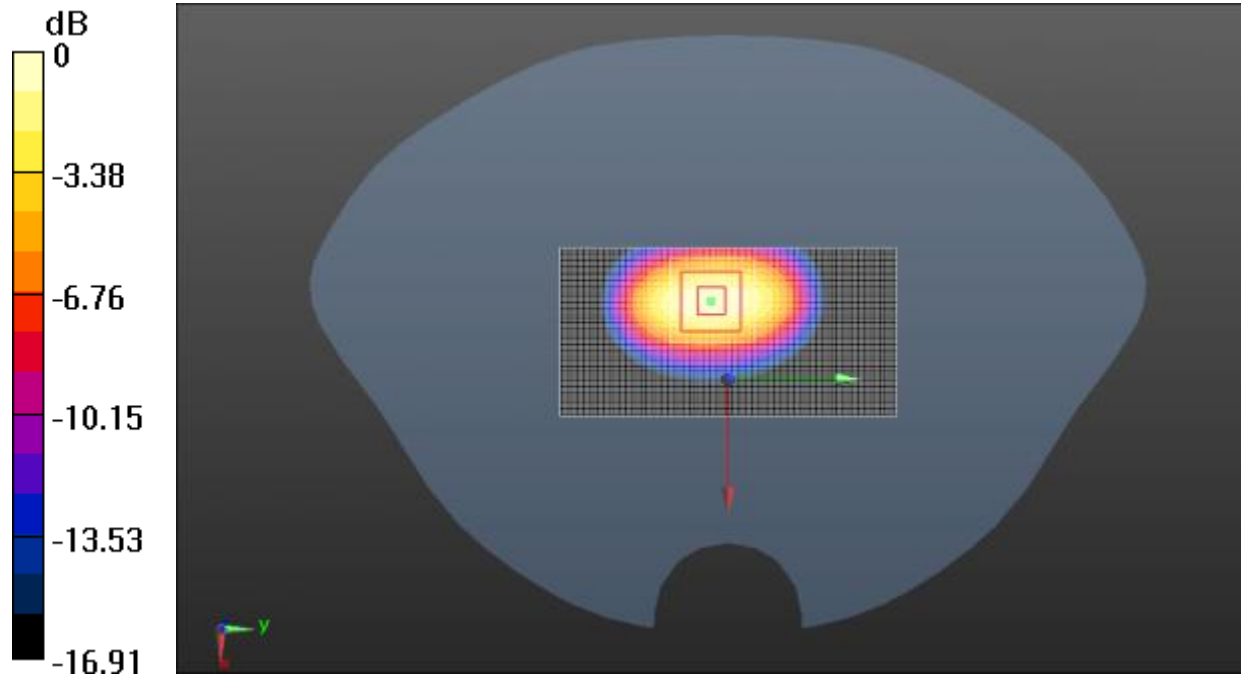

0 dB =  $12.4 \text{ W/kg} = 10.93 \text{ dBW/kg}$

**Fig.B.2 validation 1900MHz 250mW**

## 2450MHz

Date: 2014-11-19

Electronics: DAE4 Sn786

Medium: Head 2450 MHz

Medium parameters used:  $f = 2450$  MHz;  $\sigma = 1.876$  S/m;  $\epsilon_r = 38.570$ ;  $\rho = 1000$  kg/m<sup>3</sup>

Ambient Temperature: 24.8°C      Liquid Temperature: 24.3°C

Communication System: CW\_TMC Frequency: 2450 MHz Duty Cycle: 1:1

Probe: ES3DV3 - SN3151 ConvF(4.71, 4.71, 4.71);

**System Validation/Area Scan (31x91x1):** Interpolated grid: dx=1.000 mm, dy=1.000 mm

Maximum value of SAR (interpolated) = 14.9 W/kg

**Fast SAR: SAR(1 g) = 12.57 W/kg; SAR(10 g) = 6.24 W/kg**

Maximum value of SAR (interpolated) = 11.5 W/kg

**system check 2450M /Zoom Scan (7x7x7)/Cube 0:** Measurement grid: dx=5mm, dy=5mm, dz=5mm

Reference Value = 84.926 V/m; Power Drift = 0.04 dB

Peak SAR (extrapolated) = 22.1 W/kg

**SAR(1 g) = 12.8 W/kg; SAR(10 g) = 6.35 W/kg**

Maximum value of SAR (measured) = 14.8 W/kg

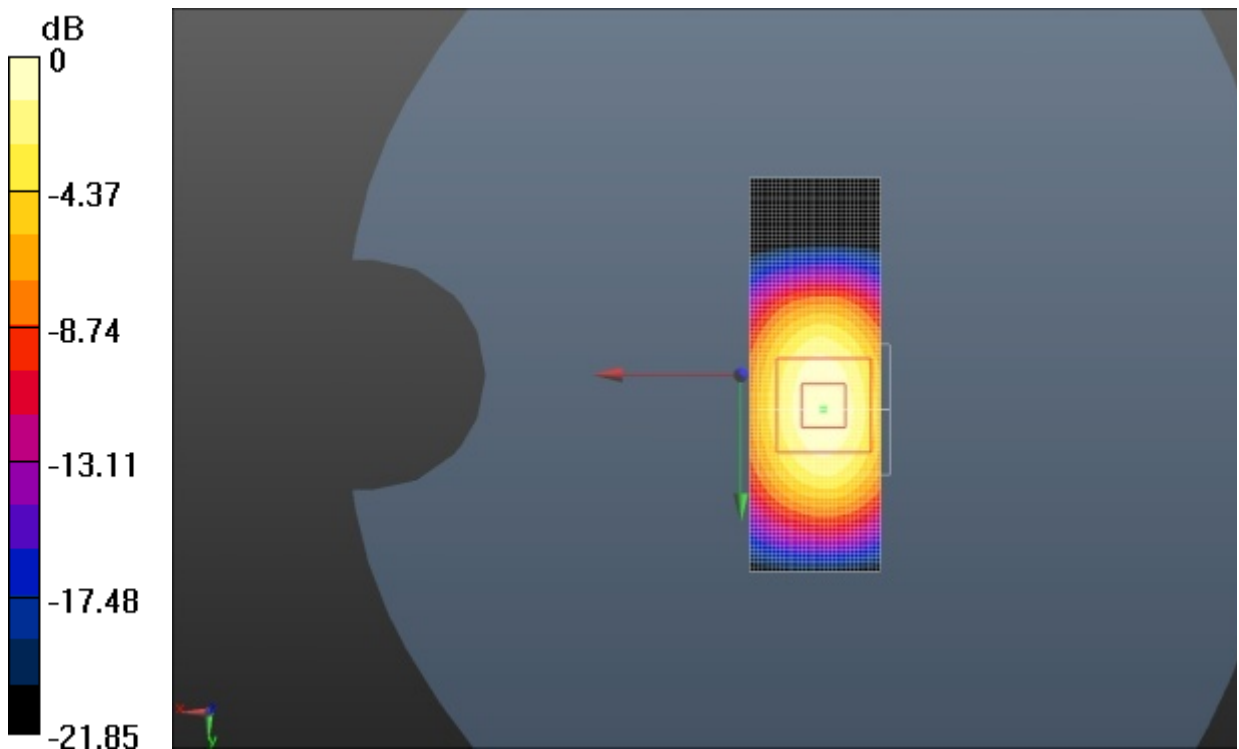

0 dB = 14.8 W/kg = 23.41 dBW/kg

**Fig.B.5 validation 2450MHz 250mW**

## 2450MHz

Date: 2014-10-29

Electronics: DAE4 Sn786

Medium: Body 2450 MHz

Medium parameters used:  $f = 2450$  MHz;  $\sigma = 1.893$  S/m;  $\epsilon_r = 52.672$ ;  $\rho = 1000$  kg/m<sup>3</sup>

Ambient Temperature: 22.8°C      Liquid Temperature: 22.3°C

Communication System: CW\_TMC Frequency: 2450 MHz Duty Cycle: 1:1

Probe: ES3DV3 - SN3151 ConvF(4.42, 4.42, 4.42);

**System Validation/Area Scan (31x91x1):** Interpolated grid: dx=1.000 mm, dy=1.000 mm

Maximum value of SAR (interpolated) = 15.3 W/kg

**Fast SAR: SAR(1 g) = 12.86 W/kg; SAR(10 g) = 6.14 W/kg**

Maximum value of SAR (interpolated) = 12.2 W/kg

**system check 2450M /Zoom Scan (7x7x7)/Cube 0:** Measurement grid: dx=5mm, dy=5mm, dz=5mm

Reference Value = 84.926 V/m; Power Drift = 0.05 dB

Peak SAR (extrapolated) = 26.2 W/kg

**SAR(1 g) = 12.95 W/kg; SAR(10 g) = 6.22 W/kg**

Maximum value of SAR (measured) = 14.4 W/kg

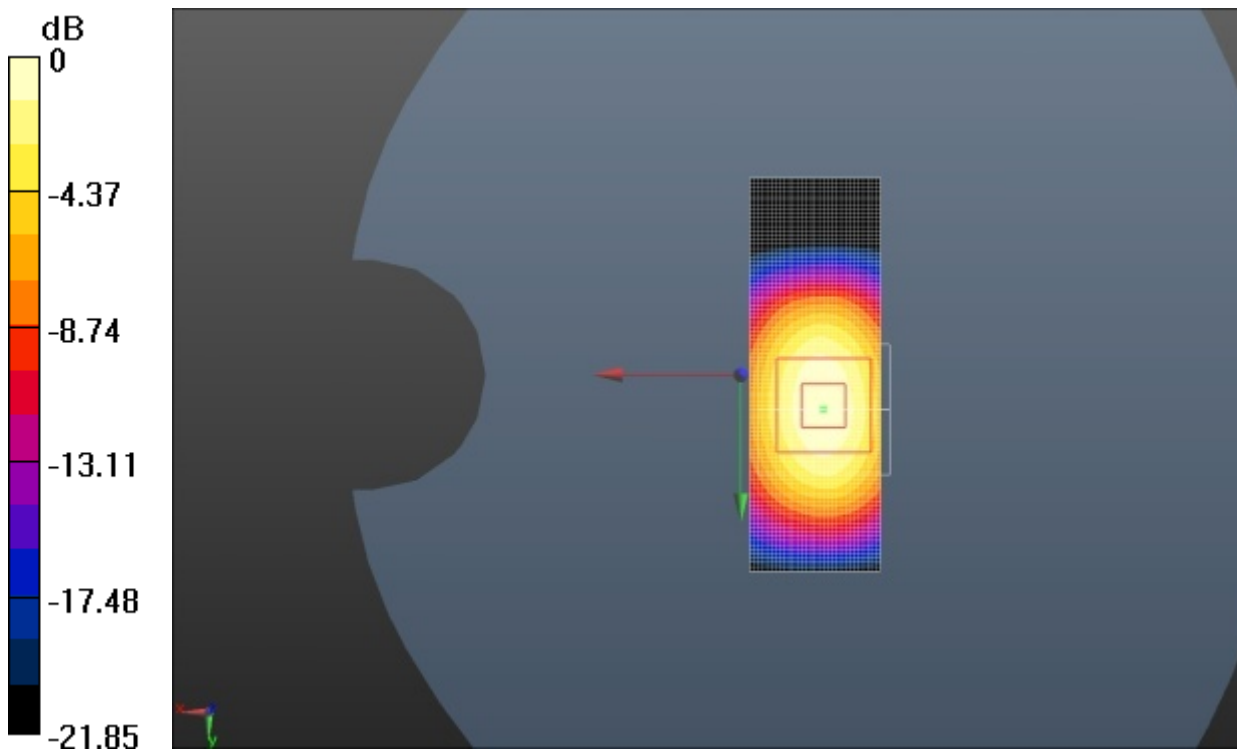

0 dB = 14.4 W/kg = 27.54 dBW/kg

**Fig.B.6 validation 2450MHz 250mW**

The SAR system verification must be required that the area scan estimated 1-g SAR is within 3% of the zoom scan 1-g SAR.

**Table B.1 Comparison between area scan and zoom scan for system verification**

<b>Band</b>	<b>Position</b>	<b>Area scan (1g)</b>	<b>Zoom scan (1g)</b>	<b>Drift (%)</b>
850	Head	2.43	2.44	0.4
850	Body	2.41	2.42	0.4
1900	Head	9.87	10.1	2.3
1900	Body	10.2	10.3	1.0
2450	Head	12.57	12.8	1.8
2450	Body	12.86	12.95	0.7