



TEST REPORT

Report No.: SRTC2014-H024-E0042

Product Name: GSM/GPRS/EDGE/UMTS

Digital Mobile Phone with Bluetooth and WiFi

Product Model: Philips S388

Applicant: Shenzhen Sang Fei Consumer Communications
Co., Ltd.

Manufacturer: Shenzhen Sang Fei Consumer Communications
Co., Ltd.

Specification: FCC Part15B (Certification)
(October 1, 2013 edition)

FCC ID: VQRCTS388

The State Radio_monitoring_center Testing Center (SRTC)

No.80 Beilishi Road Xicheng District Beijing, China

Tel: 86-10-68009202 Fax: 86-10-68009205

CONTENTS

1. General information	3
1.1 Notes of the test report	3
1.2 Information about the testing laboratory	3
1.3 Applicant's details	3
1.4 Manufacturer's details	3
1.5 Application details	4
1.6 Reference specification	4
1.7 Information of EUT	4
1.7.1 General information	4
1.7.2 EUT details	5
1.7.3 Auxiliary equipment details	5
2. Test information	6
2.1 Summary of the test results	6
2.2 Test result	7
2.2.1 Conducted Emissions-FCC Part15.107	7
2.2.2 Radiated Emissions-FCC Part15.109	16
2.3. List of test equipments	27
Appendix	28

1. General information

1.1 Notes of the test report

The test report may only be reproduced or published in full. Reproduction or publication of extracts from the report requires the prior written permission of The State Radio_monitoring_center Testing Center (SRTC).

The test results relate only to individual items of the samples which have been tested.

1.2 Information about the testing laboratory

Company: The State Radio_monitoring_center Testing Center (SRTC)
Address: No.80 Beilishi Road, Xicheng District, Beijing China
City: Beijing
Country or Region: China
Contacted person: Wang Junfeng
Tel: +86 10 68009181 +86 10 68009202
Fax: +86 10 68009195 +86 10 68009205
Email: wangjf@srrc.org.cn / wangjunfeng@srtc.org.cn

1.3 Applicant's details

Company: Shenzhen Sang Fei Consumer Communications Co., Ltd.
Address: 11 Science & Technology Rd., Shenzhen Hi-tech Industrial Park,
Nanshan District
City: Shenzhen
Country or Region: China
Grantee Code: VQR
Contacted person: Helen.Lin
Tel: 86-755-33308888
Fax: 86-755-26614979
Email: Helen.Lin@sangfei.com

1.4 Manufacturer's details

Company: Shenzhen Sang Fei Consumer Communications Co., Ltd.
Address: 11 Science & Technology Rd., Shenzhen Hi-tech Industrial Park,
Nanshan District
City: Shenzhen
Country or Region: China
Contacted person: Helen.Lin
Tel: 86-755-33308888
Fax: 86-755-26614979
Email: Helen.Lin@sangfei.com

1.5 Application details

Date of reception of test sample: 1st July 2014

Date of test: 1st July 2014 to 25th July 2014

1.6 Reference specification

FCC Part 15B October 1, 2013 (Certification)

1.7 Information of EUT

1.7.1 General information

Name of EUT	GSM/GPRS/EDGE/UMTS Digital Mobile Phone with Bluetooth and WiFi
FCC ID	VQRCTS388
Frequency Range	GSM850/WCDMA Band V: Tx:824~849MHz Rx:869~894MHz PCS1900/WCDMA Band II: Tx:1850~1910MHz Rx:1930~1990MHz
Rated Output Power	GSM850:33.0dBm PCS1900:30.0dBm WCDMA:24.0dBm
E.R.P. & E.I.R.P.	E.R.P.:33.1dBm E.I.R.P.:30.6dBm
Modulation Type	GSM/GPRS:GMSK EDGE: GMSK(Uplink direction) 8PSK(Downlink direction) WCDMA:QPSK
Emission Designator	GSM/GPRS/EDGE:300KGXW WCDMA:4M50F9W
Duplex Mode	FDD
Equipment Class	Class B
Duplex Spacing	GSM850/WCDMA Band V:45MHz PCS1900/WCDMA Band II:80MHz
Antenna Type	Fixed Internal
Power Supply	Battery or Charger
Rated Power Supply Voltage	3.7V
Extreme Temperature	Lowest: -30°C Highest: +50°C
Extreme Voltage	Minimum: 3.5V Maximum: 4.2V
HW Version	TMBKa
SW Version	S388_M6582M_1425_V01A_AM

1.7.2 EUT details

Product Name	Product Model	IMEI
GSM/GPRS/EDGE/UMTS Digital Mobile Phone with Bluetooth and WiFi	Philips S388	864359021775320

1.7.3 Auxiliary equipment details

AE (Auxiliary Equipment) 1#: Charger

Equipment	Charger
Manufacturer	Salcomp (Shenzhen) Co., Ltd
Model Number	3208SF
Input Voltage	100V-240V a.c.
Output Voltage	5.0V d.c.
Frequency	50-60Hz

AE (Auxiliary Equipment) 2#: Battery

Equipment	Battery
Manufacturer	Shenzhen cyclelong power-tech Co., Ltd
Model Number	AB1700AWML
Capacity	1700mAh
Rated Voltage	3.7V d.c.

AE (Auxiliary Equipment) 3#: Headset

Equipment	Headset
Manufacturer	Dongguan Tenji Industrial CO.,LTD
Model Number	TJ-101158



Note:

All the auxiliary equipments have been labeled with number in order to identify the test sample.

2. Test information

2.1 Summary of the test results

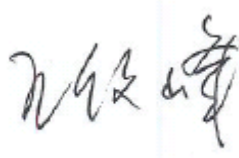
No.	Test case	FCC reference	Verdict
1	Conducted emissions	15.107	Pass
2	Radiated emissions	15.109	Pass

This Test Report Is Issued by: Mr. Song Qizhu Director of the test lab 	Checked by: Mr. Wang Junfeng Deputy director of the test lab 
Tested by: Mr. Dong Qifeng Test engineer 	Issued date: <p style="text-align: center;">2014.07.28</p>

2.2 Test result

2.2.1 Conducted Emissions-FCC Part15.107

Ambient condition:

Temperature	Relative humidity	Pressure
25.2°C	43.5%	100.2kPa

Test Setup:

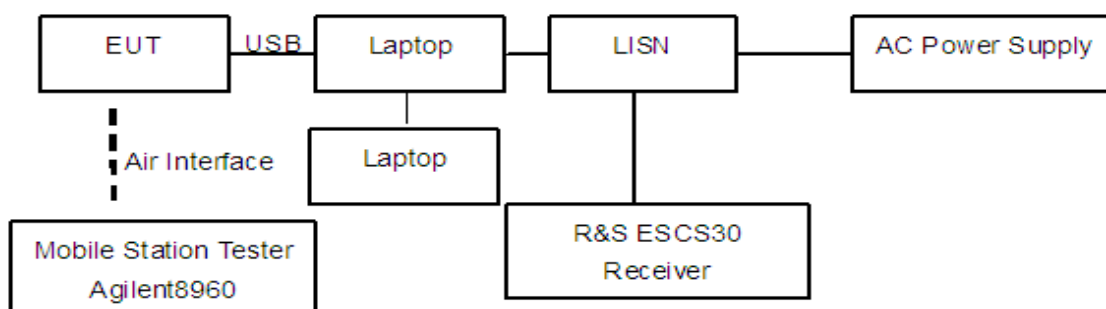

Figure 1

Test Procedure:

The EUT is placed on a non-metallic table 0.4m above the horizontal metal reference ground plane. The EUT connect with a laptop via the USB cable. The accessories of the EUT are connected with the EUT such as headset etc. During the test the data transferring via USB cable between EUT and laptop is maintained. The laptop's LAN port is connected with another laptop via cable. And the data transferring between two laptops is maintained.

The AC main power supply of the laptop is connected to LISN and LISN is connected to the reference ground. The test set-up and the test methods are performed according to ANSI C63.4:2009.

Then start the test software ES-K1. Sweep the whole frequency band through the range from 150 KHz to 30 MHz. The measurement should be done for both L line and N line. During pre-test, the receiver uses both peak detector and average detector. And the final test, the receiver uses both average detector and Quasi-peak detector.

The data of cable loss has been calibrated in full testing frequency range before the testing.

Limit:

Frequency of Emission(MHz)	Limits(dBμV)	
	Quasi-peak	Average
0.15~0.5	66 to 56*	56 to 46*
0.5~5	56	46
5~30	60	50

Note: * Decreases with the logarithm of the frequency

Test result:

Noise Level of The Measuring Instrument

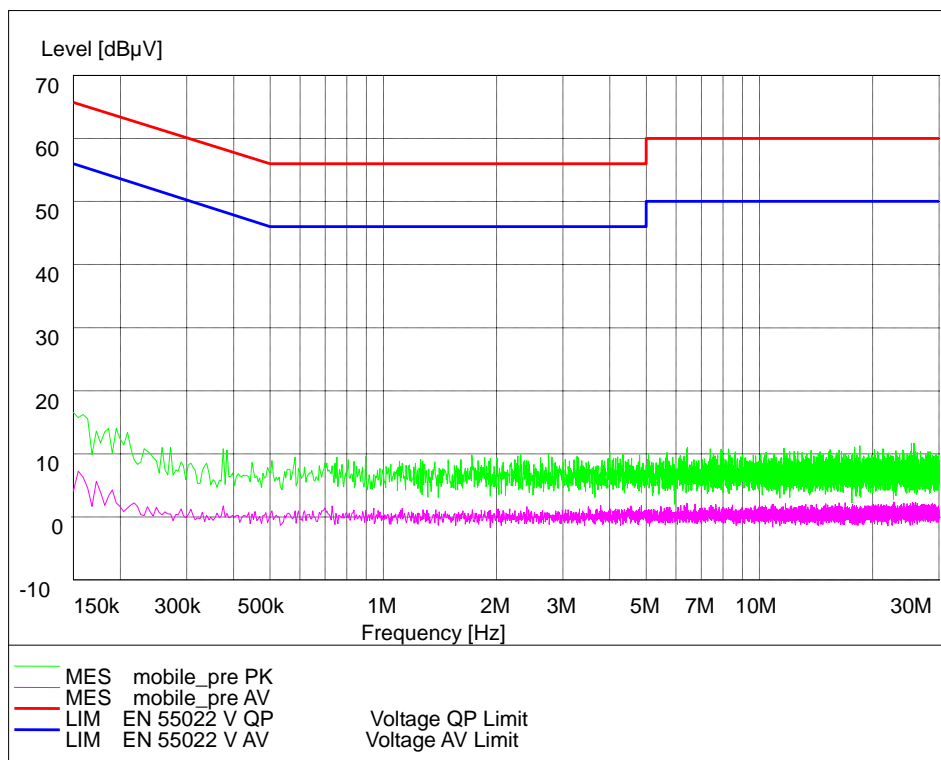

L and N Line

GSM850 Laptop+ AE2#+AE3#

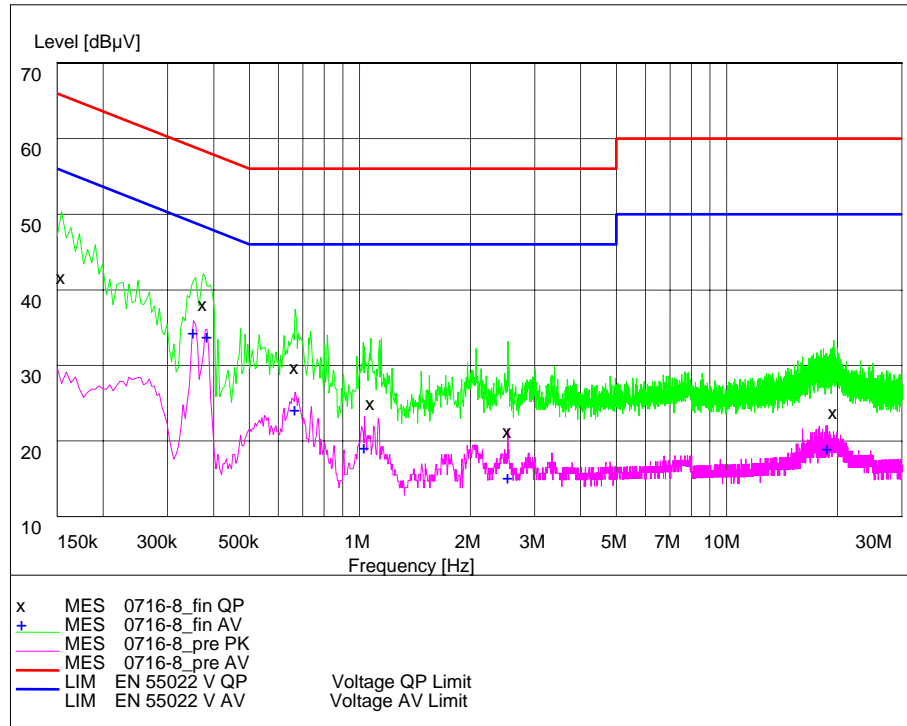

L and N Line

MEASUREMENT RESULT: "MOBILE_fin QP"

Frequency MHz	Level dBμV	Transd dB	Limit dB	Margin dBμV	Line	PE
0.154500	43.10	20.1	66	22.7	L	---
0.375000	39.50	20.3	58	18.9	L	---
0.667500	31.20	20.4	56	24.8	L	---
1.072500	26.50	20.3	56	29.5	L	---
2.535000	22.70	20.3	56	33.3	L	---
19.563000	25.20	21.2	60	34.8	L	---

MEASUREMENT RESULT: "MOBILE_fin AV"

Frequency MHz	Level dBμV	Transd dB	Limit dB	Margin dBμV	Line	PE
0.352500	35.80	20.3	49	13.1	L	---
0.384000	35.30	20.3	48	12.9	L	---
0.667500	25.70	20.4	46	20.3	L	---
1.032000	20.60	20.2	46	25.4	L	---
2.535000	16.70	20.3	46	29.3	L	---
18.816000	20.50	21.2	50	29.5	L	---

PCS 1900 Laptop+ AE2#+AE3#

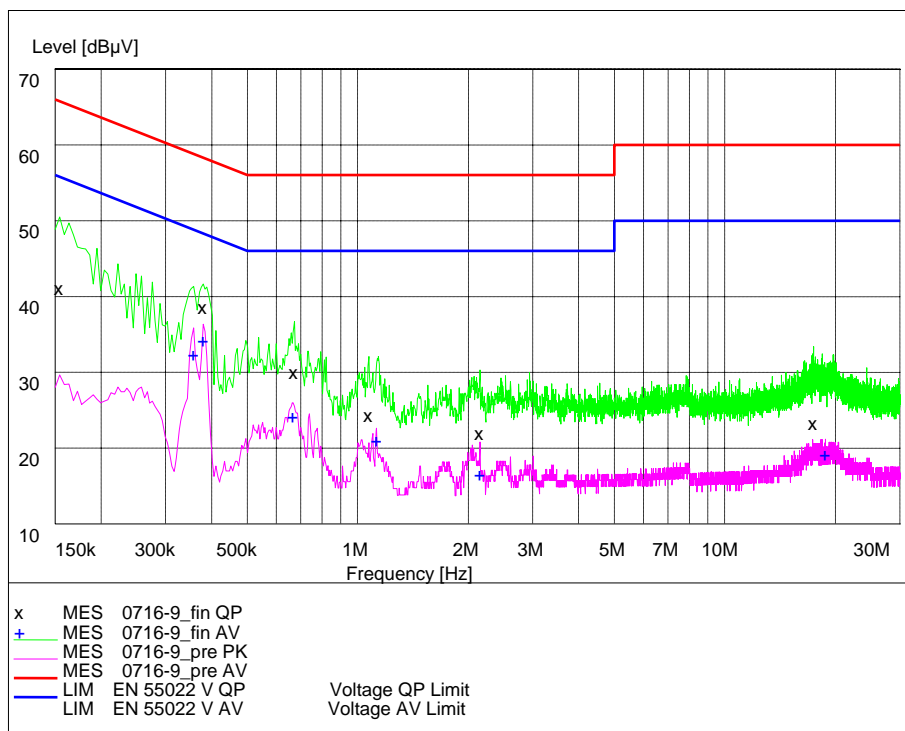

L and N Line

MEASUREMENT RESULT: "MOBILE_fin QP"

Frequency MHz	Level dBμV	Transd	Limit dB	Margin dBμV	Line	PE
0.154500	42.60	20.1	66	23.2	L	---
0.379500	40.00	20.3	58	18.3	L	---
0.672000	31.50	20.4	56	24.5	L	---
1.072500	25.80	20.3	56	30.2	L	---
2.157000	23.40	20.3	56	32.6	L	---
17.443500	24.80	21.1	60	35.2	L	---

MEASUREMENT RESULT: "MOBILE_fin AV"

Frequency MHz	Level dBμV	Transd	Limit dB	Margin dBμV	Line	PE
0.357000	33.80	20.3	49	15.0	L	---
0.379500	35.70	20.3	48	12.6	L	---
0.667500	25.60	20.4	46	20.4	L	---
1.126500	22.50	20.2	46	23.5	L	---
2.157000	18.00	20.3	46	28.0	L	---
18.816000	20.70	21.2	50	29.3	L	---

WCDMA BAND II Laptop+ AE2#+AE3#

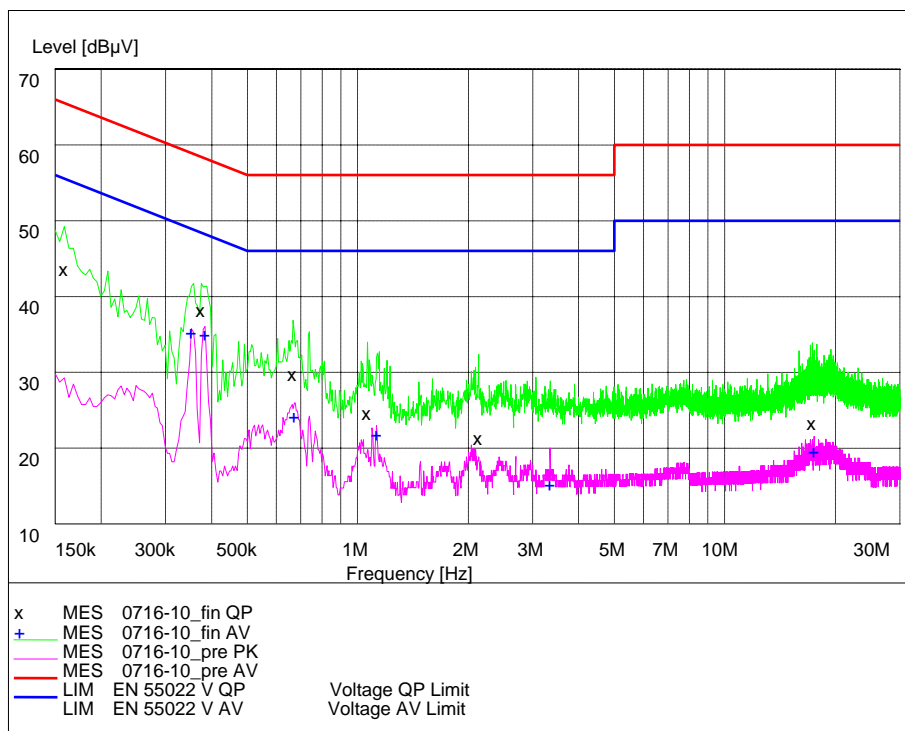

L and N Line

MEASUREMENT RESULT: "MOBILE_fin QP"

Frequency MHz	Level dBμV	Transd	Limit dB	Margin dBμV	Line	PE
0.159000	45.00	20.2	66	20.5	L	---
0.375000	39.60	20.3	58	18.8	L	---
0.667500	31.20	20.4	56	24.8	L	---
1.063500	26.10	20.3	56	29.9	N	---
2.134500	22.70	20.3	56	33.3	L	---
17.322000	24.80	21.1	60	35.2	L	---

MEASUREMENT RESULT: "MOBILE_fin AV"

Frequency MHz	Level dBμV	Transd	Limit dB	Margin dBμV	Line	PE
0.352500	36.70	20.3	49	12.2	L	---
0.384000	36.50	20.3	48	11.7	L	---
0.672000	25.60	20.4	46	20.4	L	---
1.126500	23.30	20.2	46	22.7	L	---
3.340500	16.70	20.5	46	29.3	L	---
17.506500	21.00	21.1	50	29.0	L	---

WCDMA BAND V Laptop+ AE2#+AE3#

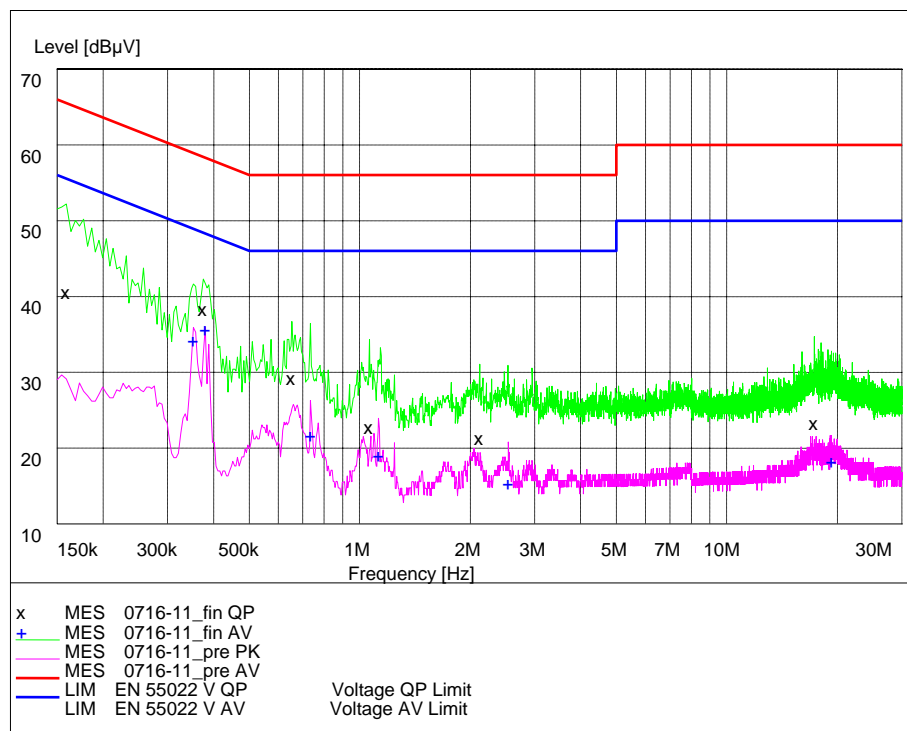

L and N Line

MEASUREMENT RESULT: "MOBILE_fin QP"

Frequency MHz	Level dBμV	Transd	Limit dB	Margin dBμV	Line	PE
0.375000	34.00	20.2	58	24.4	L	---
0.600000	26.30	20.3	56	29.7	L	---
0.618000	28.70	20.3	56	27.3	L	---
1.671000	25.20	20.2	56	30.8	L	---
3.912000	20.10	20.3	56	35.9	L	---
24.045000	20.40	21.0	60	39.6	L	---

MEASUREMENT RESULT: "MOBILE_fin AV"

Frequency MHz	Level dBμV	Transd	Limit dB	Margin dBμV	Line	PE
0.321000	20.30	20.2	50	29.4	L	---
0.375000	23.80	20.2	48	24.6	L	---
0.627000	19.70	20.3	46	26.3	L	---
1.662000	17.80	20.2	46	28.2	L	---
3.912000	15.50	20.3	46	30.5	L	---
10.176000	15.60	20.6	50	34.4	L	---

FM Radio Laptop+ AE2#+AE3#

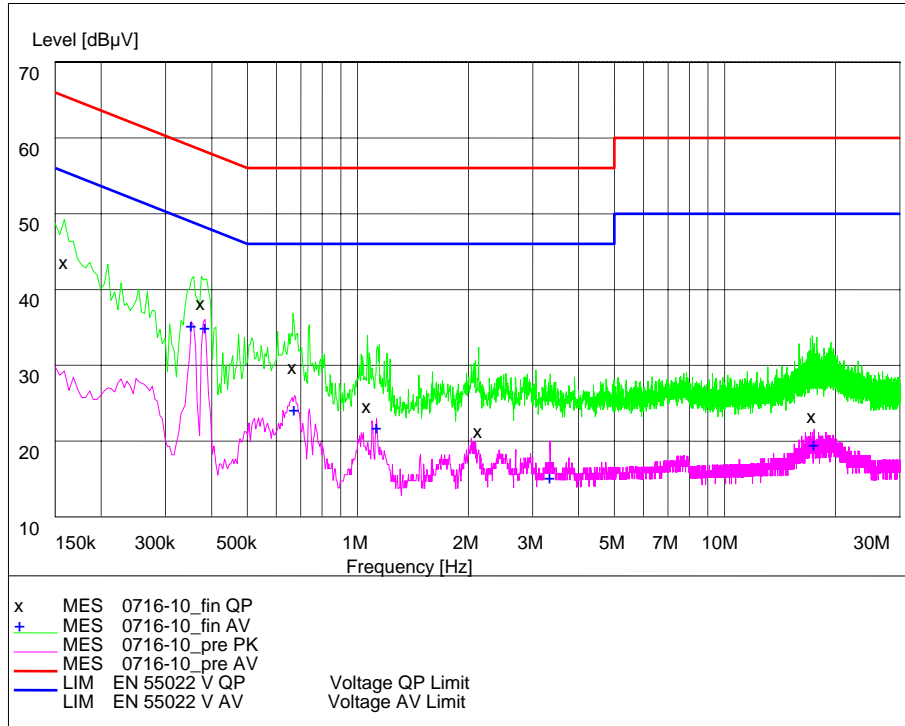

L and N Line

MEASUREMENT RESULT: "MOBILE_fin QP"

Frequency MHz	Level dBμV	Transd	Limit dB	Margin dBμV	Line	PE
0.159000	45.00	20.2	66	20.5	L	---
0.375000	39.60	20.3	58	18.8	L	---
0.667500	31.20	20.4	56	24.8	L	---
1.063500	26.10	20.3	56	29.9	N	---
2.134500	22.70	20.3	56	33.3	L	---
17.322000	24.80	21.1	60	35.2	L	---

MEASUREMENT RESULT: "MOBILE_fin AV"

Frequency MHz	Level dBμV	Transd	Limit dB	Margin dBμV	Line	PE
0.352500	36.70	20.3	49	12.2	L	---
0.384000	36.50	20.3	48	11.7	L	---
0.672000	25.60	20.4	46	20.4	L	---
1.126500	23.30	20.2	46	22.7	L	---
3.340500	16.70	20.5	46	29.3	L	---
17.506500	21.00	21.1	50	29.0	L	---

MP3/MP4 Laptop+ AE2#+AE3#

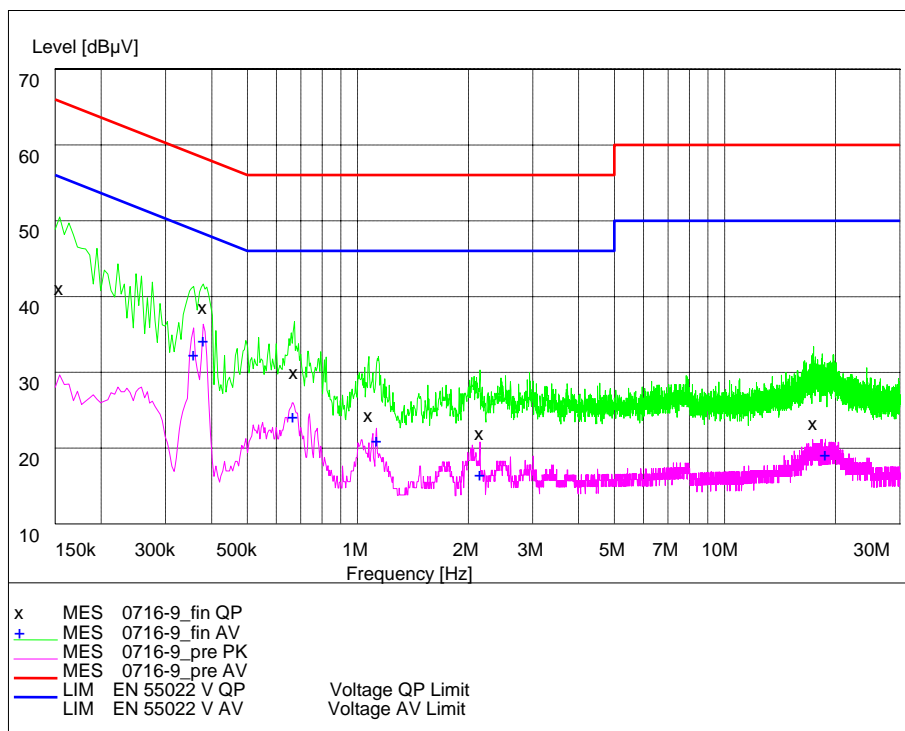

L and N Line

MEASUREMENT RESULT: "MOBILE_fin QP"

Frequency MHz	Level dBμV	Transd	Limit dB	Margin dBμV	Line	PE
0.154500	42.60	20.1	66	23.2	L	---
0.379500	40.00	20.3	58	18.3	L	---
0.672000	31.50	20.4	56	24.5	L	---
1.072500	25.80	20.3	56	30.2	L	---
2.157000	23.40	20.3	56	32.6	L	---
17.443500	24.80	21.1	60	35.2	L	---

MEASUREMENT RESULT: "MOBILE_fin AV"

Frequency MHz	Level dBμV	Transd	Limit dB	Margin dBμV	Line	PE
0.357000	33.80	20.3	49	15.0	L	---
0.379500	35.70	20.3	48	12.6	L	---
0.667500	25.60	20.4	46	20.4	L	---
1.126500	22.50	20.2	46	23.5	L	---
2.157000	18.00	20.3	46	28.0	L	---
18.816000	20.70	21.2	50	29.3	L	---

Camera Laptop+ AE2#+AE3#

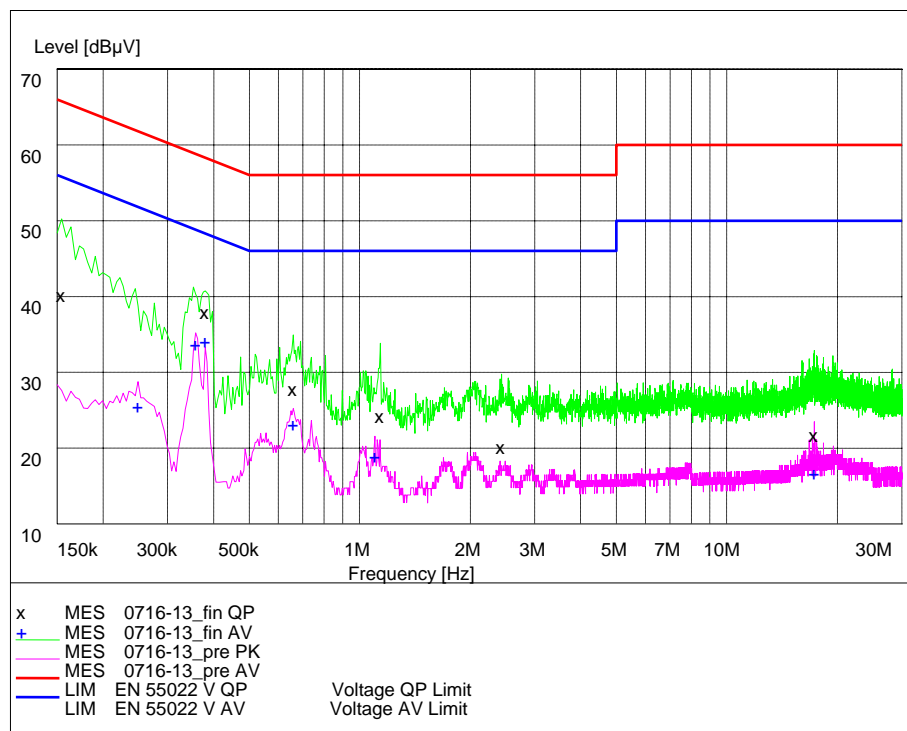

L and N Line

MEASUREMENT RESULT: "MOBILE_fin QP"

Frequency MHz	Level dBμV	Transd	Limit dB	Margin dBμV	Line	PE
0.154500	41.60	20.1	66	24.1	L	---
0.379500	39.30	20.3	58	19.0	L	---
0.658500	29.20	20.4	56	26.8	L	---
1.140000	25.60	20.2	56	30.4	L	---
2.436000	21.60	20.3	56	34.4	L	---
17.295000	23.10	21.1	60	36.9	L	---

MEASUREMENT RESULT: "MOBILE_fin AV"

Frequency MHz	Level dBμV	Transd	Limit dB	Margin dBμV	Line	PE
0.249000	27.00	20.2	52	24.8	L	---
0.357000	35.10	20.3	49	13.7	L	---
0.379500	35.50	20.3	48	12.8	L	---
0.658500	24.60	20.4	46	21.4	L	---
1.099500	20.40	20.3	46	25.6	L	---
17.299500	18.20	21.1	50	31.8	L	---

2.2.2 Radiated Emissions-FCC Part15.109

Ambient condition:

Temperature	Relative humidity	Pressure
25.2°C	43.5%	100.2kPa

Test Setup:

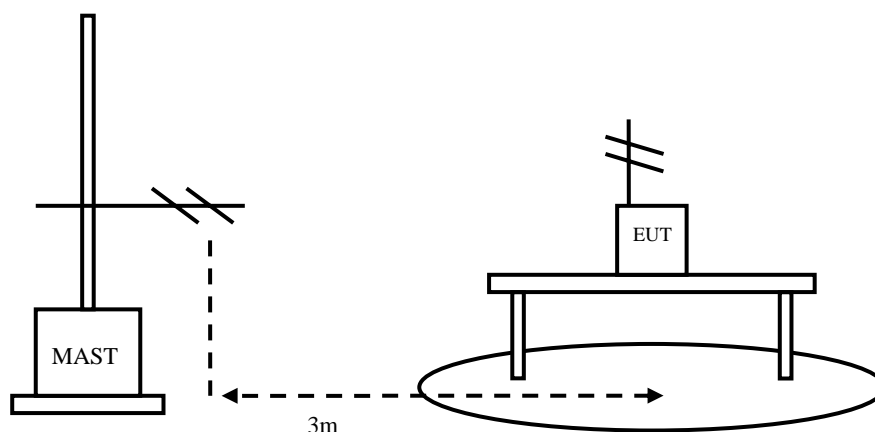

Figure 2

Test Procedure:

The EUT should be placed on a non-metallic table 80cm above the ground plane. The receive antennas shall be moved from 1 to 4 meters. The distance between EUT and receive antenna should be 3 meters.

The EUT should work in idle mode. The accessories of the EUT are connected with the EUT such as headset etc. The test set-up and the test methods are performed according to ANSI C63.4:2009.

Then start the test software ES-K1. Sweep the whole frequency band through the range from 30MHz to 1GHz, using receive log period antenna HL562.

During the test, the height of receive antenna shall be moved from 1 to 4 meters, and the antenna shall be performed under horizontal and vertical polarization. The turn table shall be rotated from 0 to 360 degrees for detecting the maximum of radiated spurious signal level. The measurements shall be repeated with orthogonal polarization of the test antenna. The EUT is laid in two modes as follow:
1. put the EUT in horizontal direction; 2. put the EUT in vertical direction.

The data of cable loss and antenna factor have been calibrated in full testing frequency range before the testing.

A “reference path loss” is established and the A_{Rpl} is the attenuation of “reference path loss”, and including the gain of receive antenna, the gain of the preamplifier, the cable loss.

The measurement results are obtained as described below:

$$\text{Result} = P_{\text{mea}} + A_{Rpl}$$

Limit:

Frequency of Emission(MHz)	Limits	
	Detector	Unit (dB μ V/m)
30~88	Quasi-peak	40
88~216	Quasi-peak	43.5
216~960	Quasi-peak	46
960~1000	Quasi-peak	54
1000~5th harmonic of the highest frequency or 40GHz, whichever is lower	Average	54
	Peak	74

Test result:

GSM850 Mode

Frequency(MHz)	Result(dBuV/m)	A_{Rpl} (dB)	P_{mea} (dBuV/m)	Polarity
30.000000	27.1	15.3	11.8	Vertical
40.280561	24.9	15.8	9.1	Horizontal
479.559118	25.9	18.1	7.8	Vertical
750.300601	21.8	22.7	0.9	Vertical
837.274549	63.5	23.8	39.7	Vertical
876.553106	26.5	24.5	2.0	Vertical

PCS1900 Mode

Frequency(MHz)	Result(dBuV/m)	A_{Rpl} (dB)	P_{mea} (dBuV/m)	Polarity
30.240000	11.6	15.3	-3.7	Vertical
198.220000	13.8	8.2	5.6	Vertical
202.300000	12.0	8.3	3.7	Vertical
213.280000	12.4	8.8	3.6	Vertical
477.760000	16.6	18.0	-1.4	Vertical
906.560000	24.5	25.0	-0.5	Vertical

WCDMA BAND II Mode

Frequency(MHz)	Result(dBuV/m)	A _{Rpl} (dB)	P _{mea} (dBuV/m)	Polarity
31.020000	11.8	15.3	-3.5	Vertical
209.200000	13.6	8.5	5.1	Vertical
219.280000	10.6	9.2	1.4	Horizontal
520.040000	18.7	18.7	0	Vertical
766.700000	22.2	22.9	-0.7	Vertical
940.580000	25.6	25.4	0.2	Vertical

WCDMA BAND V Mode

Frequency(MHz)	Result(dBuV/m)	A _{Rpl} (dB)	P _{mea} (dBuV/m)	Polarity
30.000000	27.9	15.3	12.6	Vertical
39.730000	26.3	16.0	10.3	Horizontal
479.550000	26.0	18.1	7.9	Vertical
826.050000	58.8	23.9	34.9	Vertical
870.940000	39.6	24.3	15.3	Vertical
941.080000	25.2	25.4	-0.2	Vertical

FM Radio Mode

Frequency(MHz)	Result(dBuV/m)	A _{Rpl} (dB)	P _{mea} (dBuV/m)	Polarity
30.420000	11.6	15.3	-3.7	Vertical
192.400000	12.1	8.0	4.1	Vertical
211.480000	13.9	8.7	5.2	Horizontal
550.340000	17.8	19.2	-1.4	Vertical
739.940000	21.8	22.7	-0.9	Vertical
935.540000	25.0	25.4	-0.4	Vertical

MP3/MP4 Mode

Frequency(MHz)	Result(dBuV/m)	A _{Rpl} (dB)	P _{mea} (dBuV/m)	Polarity
30.420000	11.7	15.3	-3.6	Vertical
187.480000	11.5	8.1	3.4	Vertical
216.400000	12.5	9.0	3.5	Vertical
508.100000	17.4	18.5	-1.1	Vertical
740.480000	21.7	22.7	-1.0	Vertical
930.260000	25.0	25.4	-0.4	Vertical

Camera Mode

Frequency(MHz)	Result(dBuV/m)	A _{Rpl} (dB)	P _{mea} (dBuV/m)	Polarity
30.900000	11.7	15.3	-3.6	Vertical
182.740000	10.9	8.4	2.5	Vertical
208.780000	14.6	8.5	6.1	Vertical
558.080000	18.0	19.4	-1.4	Horizontal
761.060000	22.1	22.7	-0.6	Vertical
924.200000	25.1	25.5	-0.4	Vertical

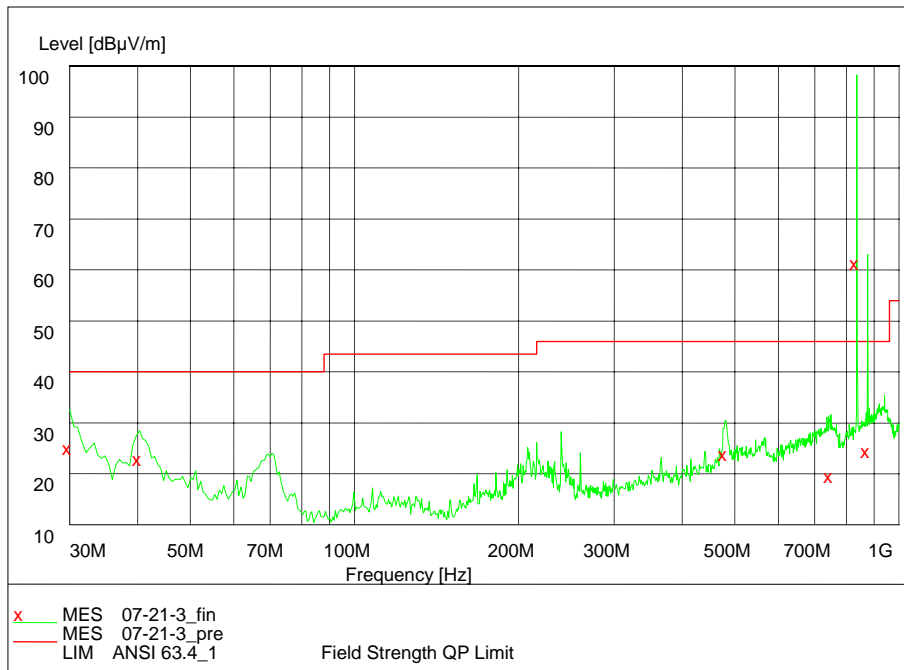

GSM850 (30MHz – 1GHz)

Note: The signal beyond the limit is the base station simulator carrier.

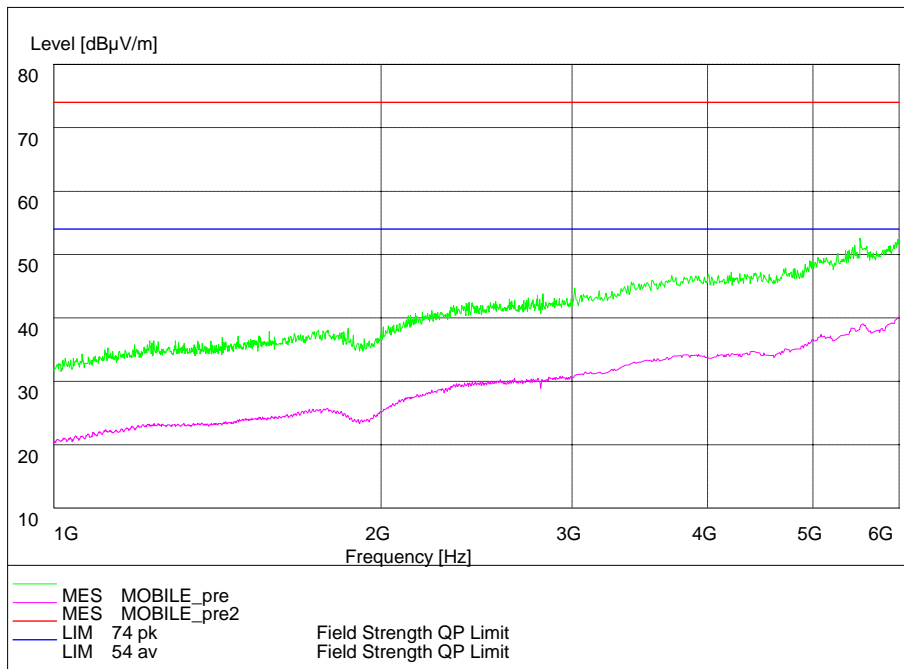

GSM850 (1GHz – 6GHz)

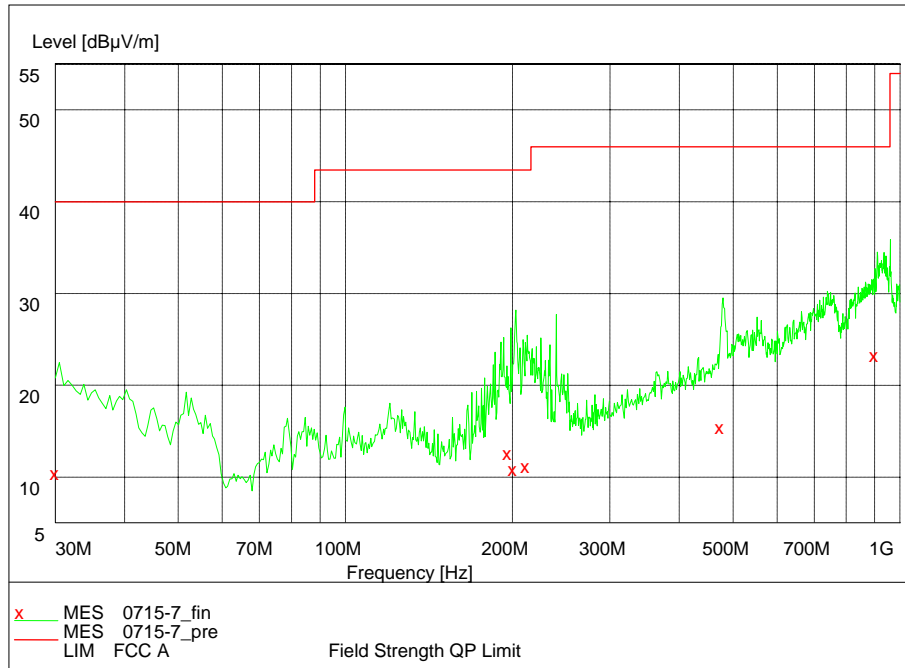

PCS1900 (30MHz – 1GHz)

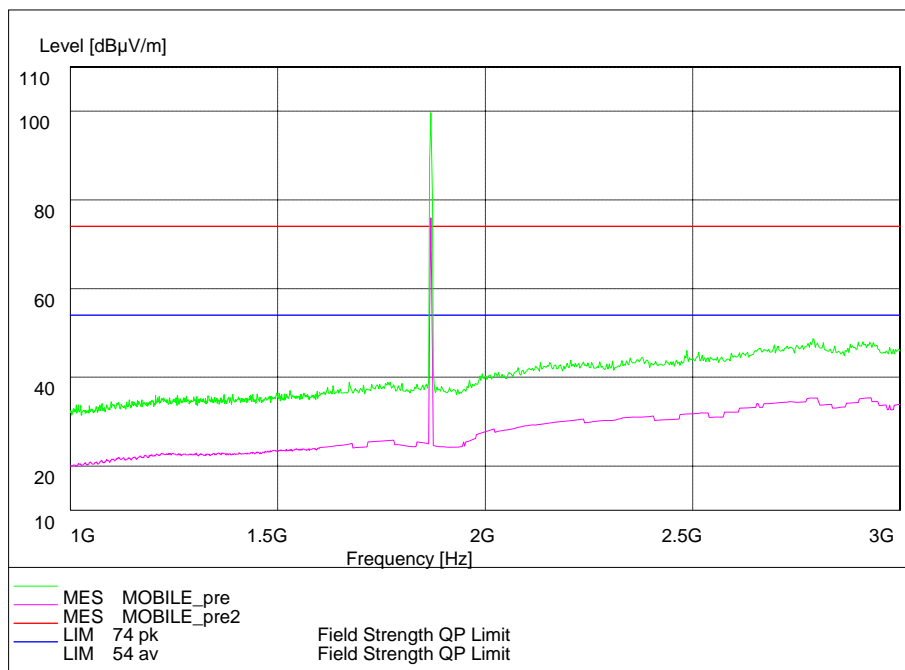

PCS1900 (1GHz – 3GHz)

Note: The signals beyond the limit are the base station and simulator carrier.

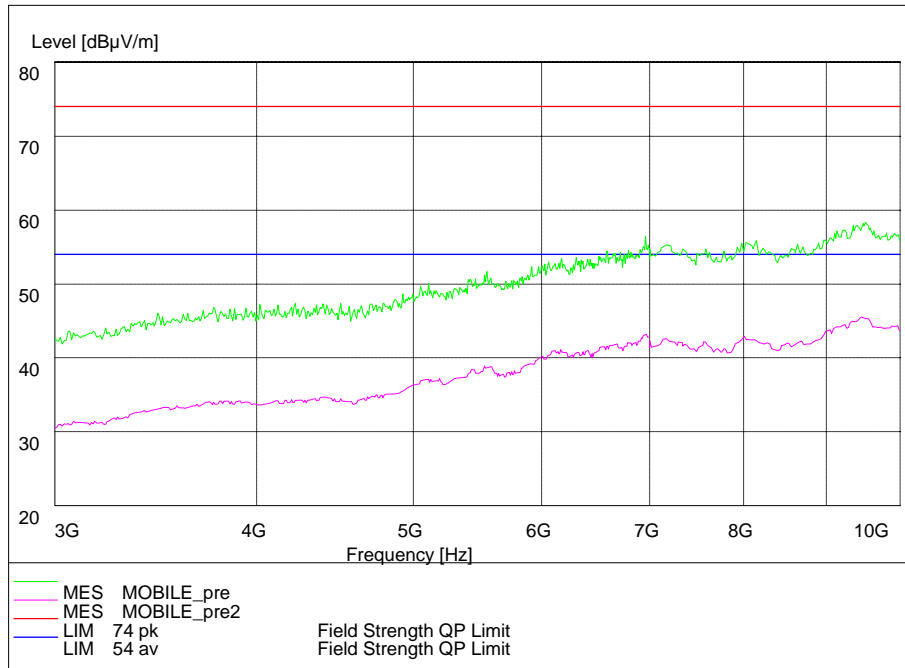

PCS1900 (3GHz – 10GHz)

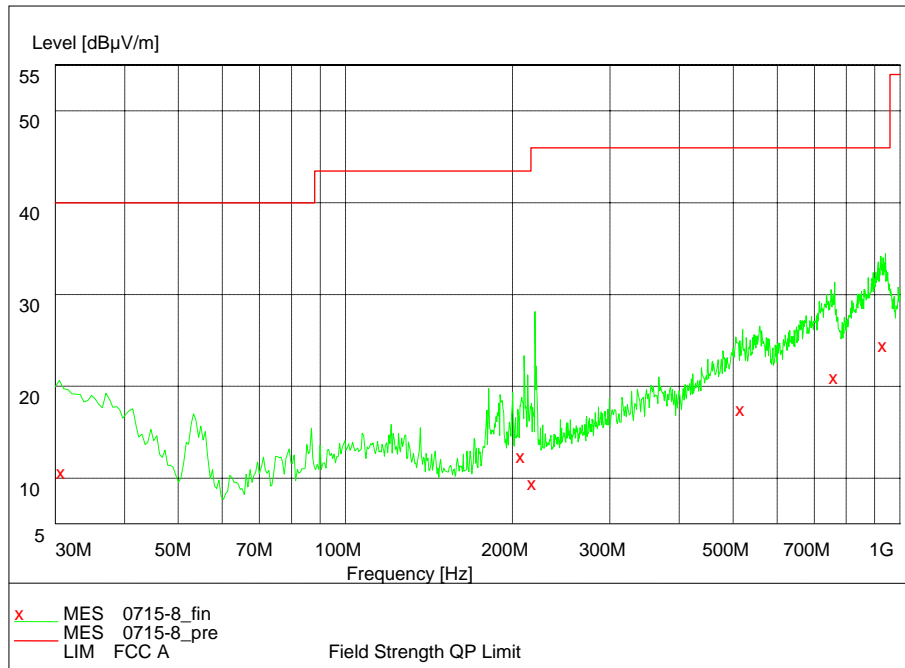

WCDMA BAND II (30MHz – 1GHz)

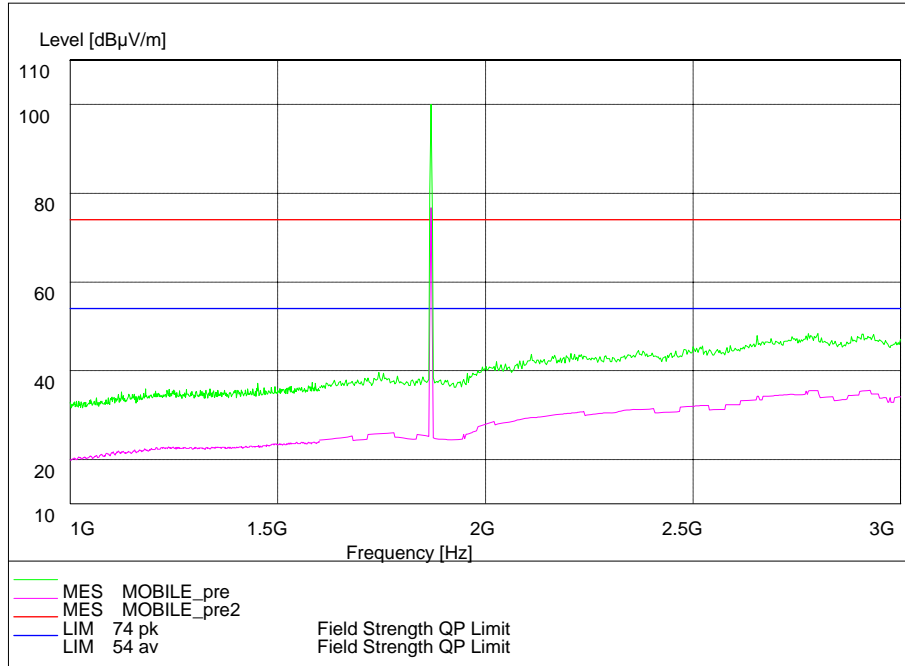

WCDMA BAND II (1GHz – 3GHz)

Note: The signal beyond the limit is the base station simulator carrier.

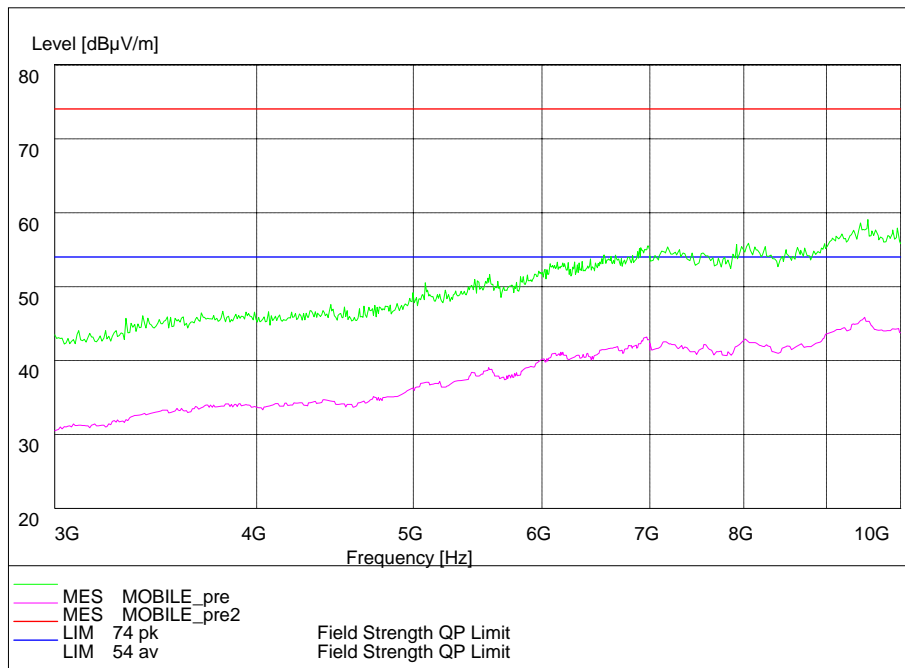

WCDMA BAND II (3GHz – 10GHz)

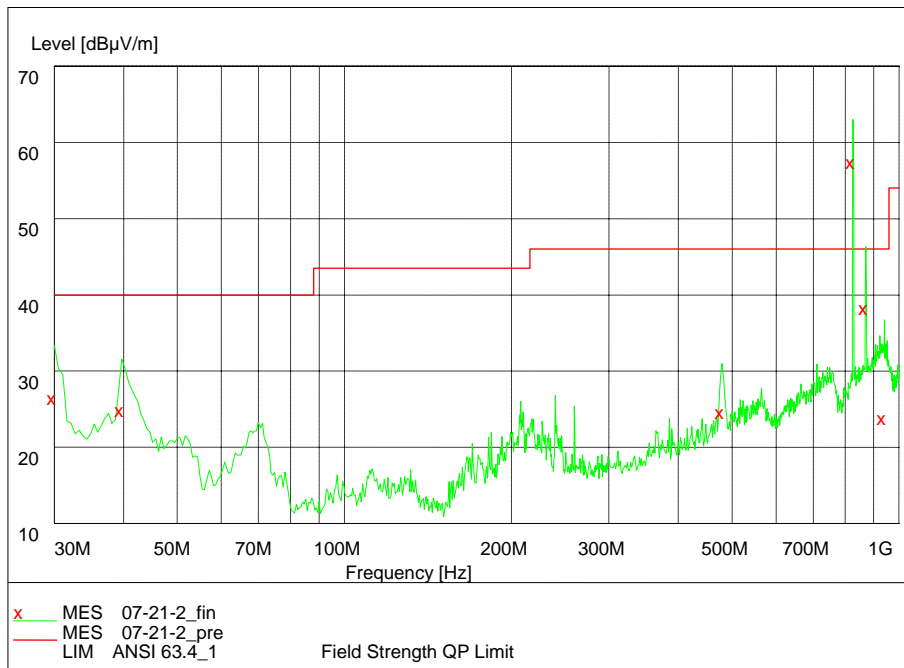

WCDMA BAND V (30MHz – 1GHz)

Note: The signals beyond the limit are the base station and simulator carrier.

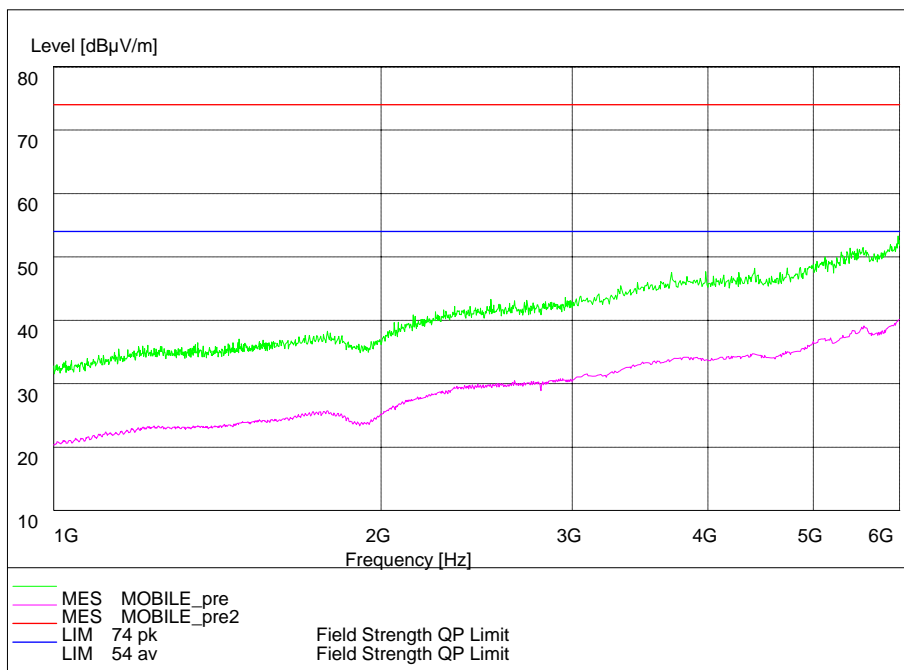

WCDMA BAND V (1GHz – 6GHz)

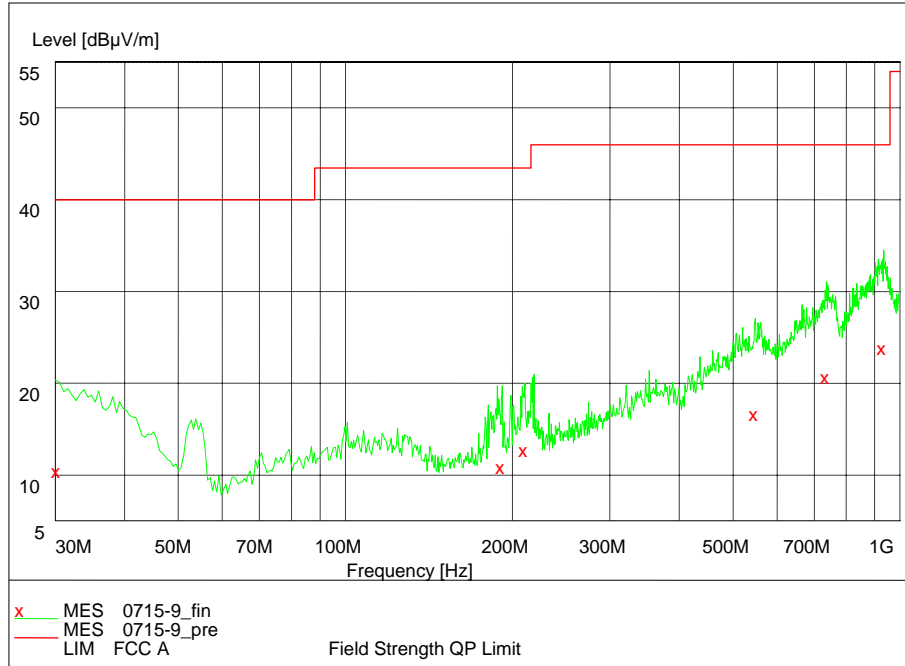

FM Radio (30MHz – 1GHz)

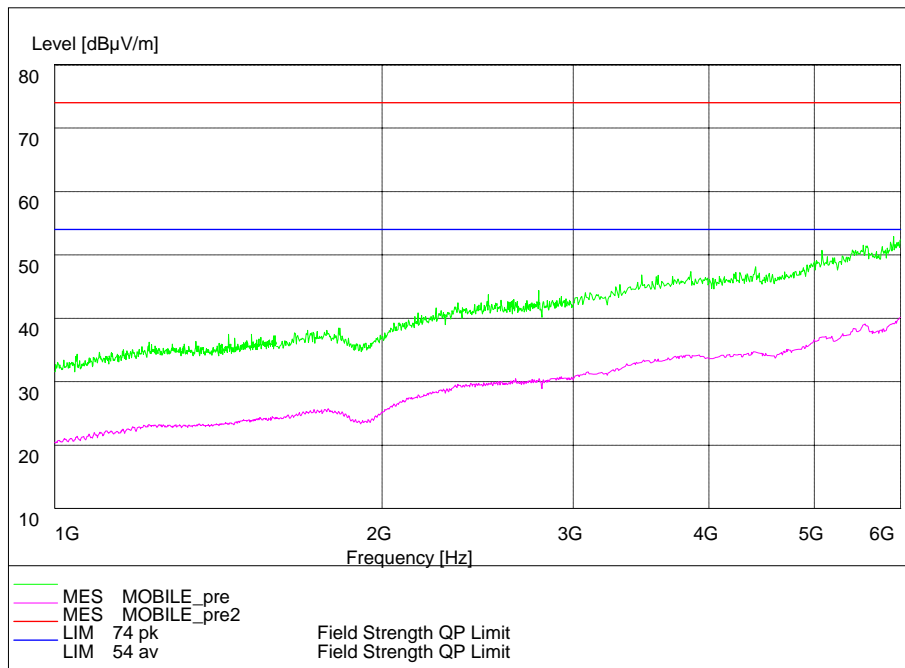

FM Radio (1GHz – 6GHz)

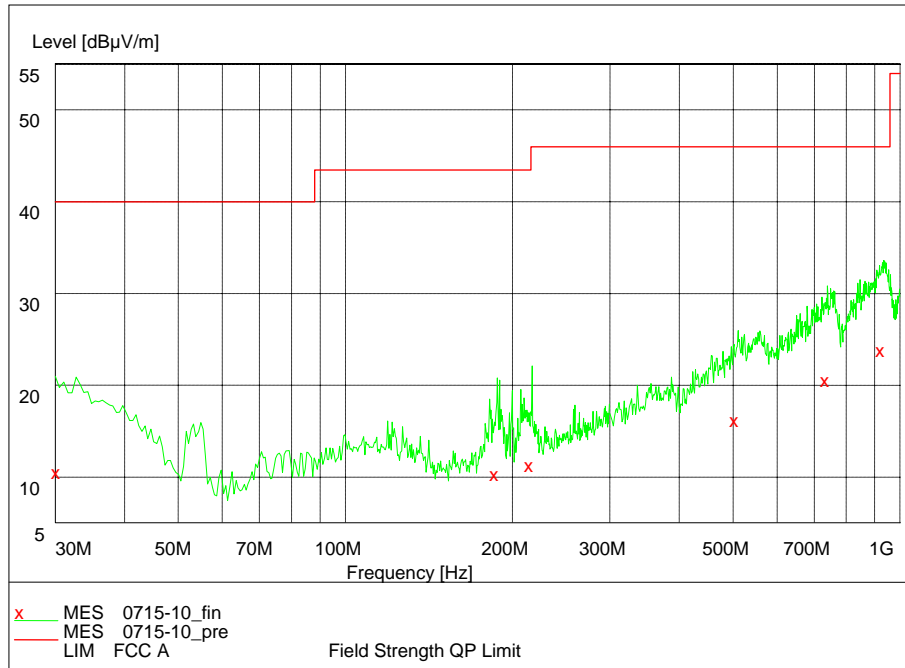

MP3/MP4 (30MHz – 1GHz)

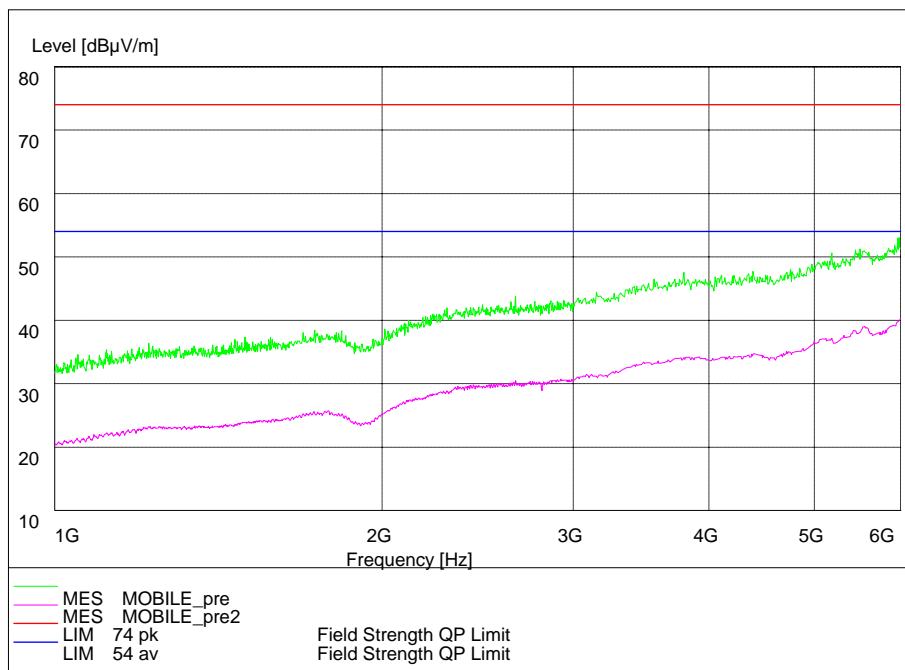

MP3/MP4 (1GHz – 6GHz)

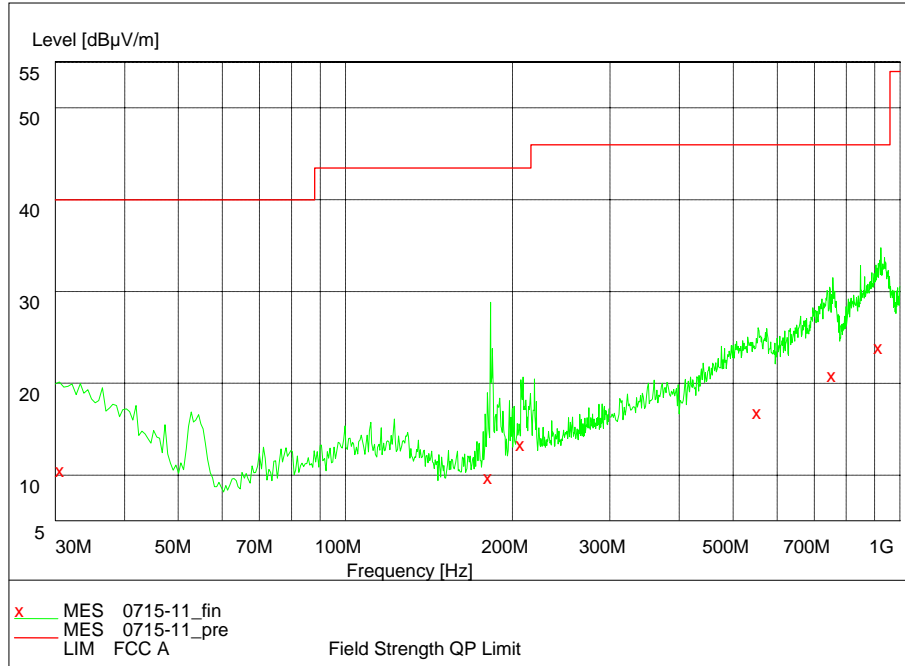

Camera (30MHz – 1GHz)

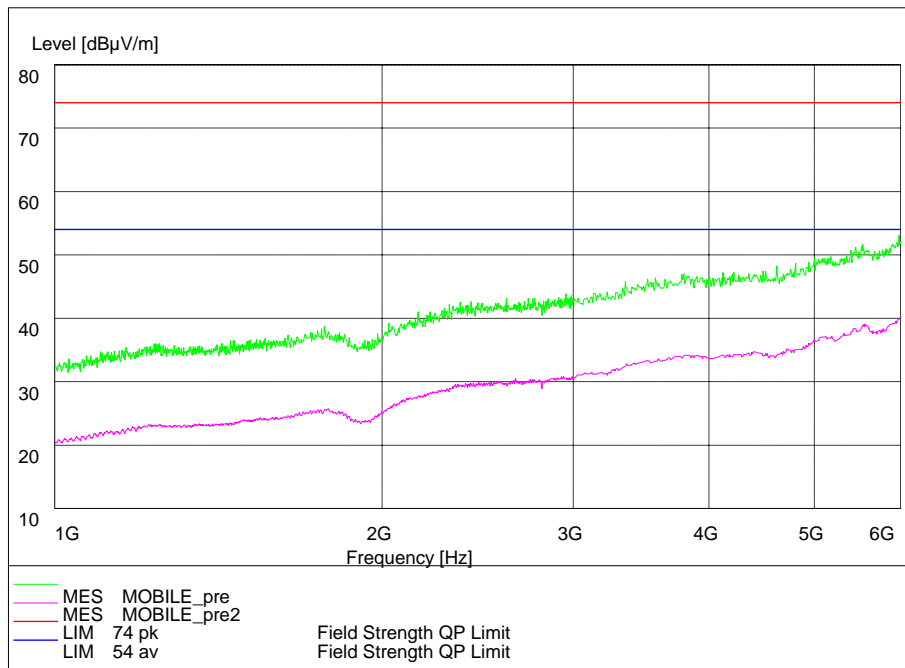

Camera (1GHz – 6GHz)

2.3. List of test equipments

No.	Name/Model	Manufacturer	S/N	Calibration Due Date
1	23.18m×16.88m×9.60m Semi-Anechoic Chamber	FRANKONIA	-----	19 th Aug. 2014
2	ESI 40 EMI test receiver	R&S	100015	19 th Aug. 2014
3	E5515C(8960) Mobile Station Tester	Agilent	GB44050904	19 th Aug. 2014
4	9.080m×5.255m×3.525m Shielding room	FRANKONIA	-----	19 th Aug. 2014
5	ESCS30 EMI test receiver	R&S	100029	19 th Aug. 2014
6	HL562 Ultra log test antenna	R&S	100016	19 th Aug. 2014
7	ESH3-Z2 Pulse limiter	R&S	10002	19 th Aug. 2014
8	ESH3-Z5 Attenuator	R&S	100020	19 th Aug. 2014
9	ESH2Z11 LISN	R&S	50FH-020-10	19 th Aug. 2014
10	HF 906 Double-Ridged Waveguide Horn Antenna	R&S	100030	19 th Aug. 2014
11	HF 906 Double-Ridged Waveguide Horn Antenna	R&S	100029	19 th Aug. 2014
12	PS2000 Turn Table	FRANKONIA	-----	19 th Aug. 2014
13	MA260 Antenna Master	FRANKONIA	-----	19 th Aug. 2014
14	ES-K1EMI test software	R&S	-----	19 th Aug. 2014
15	HL562 Receive antenna	R&S	100167	19 th Aug. 2014

Appendix

Appendix1 Test Setup