

CALIBRATION REPORT

F.1 E-Field Probe



In Collaboration with
s p e a g
CALIBRATION LABORATORY



中国认可
国际互认
校准
CALIBRATION
CNAS L0570

Add: No.51 Xueyuan Road, Haidian District, Beijing, 100191, China
Tel: +86-10-62304633-2218 Fax: +86-10-62304633-2209
E-mail: cttl@chinattl.com [Http://www.chinattl.cn](http://www.chinattl.cn)

Client **baluntek**

Certificate No: Z16-97250

CALIBRATION CERTIFICATE				
Object	EX3DV4 - SN:7340			
Calibration Procedure(s)	FD-Z11-004-01 Calibration Procedures for Dosimetric E-field Probes			
Calibration date:	December 27, 2016			
This calibration Certificate documents the traceability to national standards, which realize the physical units of measurements(SI). The measurements and the uncertainties with confidence probability are given on the following pages and are part of the certificate.				
All calibrations have been conducted in the closed laboratory facility: environment temperature(22±3)°C and humidity<70%.				
Calibration Equipment used (M&TE critical for calibration)				
Primary Standards	ID #	Cal Date(Calibrated by, Certificate No.)		Scheduled Calibration
Power Meter NRP2	101919	27-Jun-16 (CTTL, No.J16X04777)		Jun-17
Power sensor NRP-Z91	101547	27-Jun-16 (CTTL, No.J16X04777)		Jun-17
Power sensor NRP-Z91	101548	27-Jun-16 (CTTL, No.J16X04777)		Jun-17
Reference10dBAttenuator	18N50W-10dB	13-Mar-16(CTTL, No.J16X01547)		Mar-18
Reference20dBAttenuator	18N50W-20dB	13-Mar-16(CTTL, No.J16X01548)		Mar-18
Reference Probe EX3DV4	SN 7433	26-Sep-16(SPEAG, No.EX3-7433_Sep16)		Sep-17
DAE4	SN 1331	21-Jan-16(SPEAG, No.DAE4-1331_Jan16)		Jan -17
Secondary Standards	ID #	Cal Date(Calibrated by, Certificate No.)		Scheduled Calibration
SignalGeneratorMG3700A	6201052605	27-Jun-16 (CTTL, No.J16X04776)		Jun-17
Network Analyzer E5071C	MY46110673	26-Jan-16 (CTTL, No.J16X00894)		Jan -17
Calibrated by:	Name	Function	Signature	
	Zhao Jing	SAR Test Engineer		
Reviewed by:	Qi Dianyuan	SAR Project Leader		
Approved by:	Lu Bingsong	Deputy Director of the laboratory		
Issued: December 31, 2016				
This calibration certificate shall not be reproduced except in full without written approval of the laboratory.				



Add: No.51 Xueyuan Road, Haidian District, Beijing, 100191, China
Tel: +86-10-62304633-2218 Fax: +86-10-62304633-2209
E-mail: cttl@chinattl.com [Http://www.chinattl.cn](http://www.chinattl.cn)

Glossary:

TSL	tissue simulating liquid
NORM _{x,y,z}	sensitivity in free space
ConvF	sensitivity in TSL / NORM _{x,y,z}
DCP	diode compression point
CF	crest factor (1/duty_cycle) of the RF signal
A,B,C,D	modulation dependent linearization parameters
Polarization Φ	Φ rotation around probe axis
Polarization θ	θ rotation around an axis that is in the plane normal to probe axis (at measurement center), i $\theta=0$ is normal to probe axis
Connector Angle	information used in DASY system to align probe sensor X to the robot coordinate system

Calibration is Performed According to the Following Standards:

- IEEE Std 1528-2013, "IEEE Recommended Practice for Determining the Peak Spatial-Averaged Specific Absorption Rate (SAR) in the Human Head from Wireless Communications Devices: Measurement Techniques", June 2013
- IEC 62209-1, "Procedure to measure the Specific Absorption Rate (SAR) for hand-held devices used in close proximity to the ear (frequency range of 300MHz to 3GHz)", February 2005
- IEC 62209-2, "Procedure to determine the Specific Absorption Rate (SAR) for wireless communication devices used in close proximity to the human body (frequency range of 30 MHz to 6 GHz)", March 2010
- KDB 865664, "SAR Measurement Requirements for 100 MHz to 6 GHz"

Methods Applied and Interpretation of Parameters:

- NORM_{x,y,z}:** Assessed for E-field polarization $\theta=0$ ($f \leq 900\text{MHz}$ in TEM-cell; $f > 1800\text{MHz}$: waveguide). NORM_{x,y,z} are only intermediate values, i.e., the uncertainties of NORM_{x,y,z} does not effect the E^2 -field uncertainty inside TSL (see below ConvF).
- NORM(f)_{x,y,z} = NORM_{x,y,z} * frequency_response** (see Frequency Response Chart). This linearization is implemented in DASY4 software versions later than 4.2. The uncertainty of the frequency response is included in the stated uncertainty of ConvF.
- DCP_{x,y,z}:** DCP are numerical linearization parameters assessed based on the data of power sweep (no uncertainty required). DCP does not depend on frequency nor media.
- PAR:** PAR is the Peak to Average Ratio that is not calibrated but determined based on the signal characteristics.
- A_{x,y,z}; B_{x,y,z}; C_{x,y,z}; VR_{x,y,z}:** A,B,C are numerical linearization parameters assessed based on the data of power sweep for specific modulation signal. The parameters do not depend on frequency nor media. VR is the maximum calibration range expressed in RMS voltage across the diode.
- ConvF and Boundary Effect Parameters:** Assessed in flat phantom using E-field (or Temperature Transfer Standard for $f \leq 800\text{MHz}$) and inside waveguide using analytical field distributions based on power measurements for $f > 800\text{MHz}$. The same setups are used for assessment of the parameters applied for boundary compensation (alpha, depth) of which typical uncertainty valued are given. These parameters are used in DASY4 software to improve probe accuracy close to the boundary. The sensitivity in TSL corresponds to NORM_{x,y,z} * ConvF whereby the uncertainty corresponds to that given for ConvF. A frequency dependent ConvF is used in DASY version 4.4 and higher which allows extending the validity from $\pm 50\text{MHz}$ to $\pm 100\text{MHz}$.
- Spherical isotropy (3D deviation from isotropy):** in a field of low gradients realized using a flat phantom exposed by a patch antenna.
- Sensor Offset:** The sensor offset corresponds to the offset of virtual measurement center from the probe tip (on probe axis). No tolerance required.
- Connector Angle:** The angle is assessed using the information gained by determining the NORM_x (no uncertainty required).



Add: No.51 Xueyuan Road, Haidian District, Beijing, 100191, China
Tel: +86-10-62304633-2218 Fax: +86-10-62304633-2209
E-mail: ctl@chinattl.com [Http://www.chinattl.cn](http://www.chinattl.cn)

Probe EX3DV4

SN: 7340

Calibrated: December 27, 2016

Calibrated for DASY/EASY Systems

(Note: non-compatible with DASY2 system!)



Add: No.51 Xueyuan Road, Haidian District, Beijing, 100191, China
 Tel: +86-10-62304633-2218 Fax: +86-10-62304633-2209
 E-mail: cttl@chinattl.com [Http://www.chinattl.cn](http://www.chinattl.cn)

DASY/EASY – Parameters of Probe: EX3DV4 – SN: 7340

Basic Calibration Parameters

	Sensor X	Sensor Y	Sensor Z	Unc (k=2)
Norm($\mu\text{V}/(\text{V}/\text{m})^2$) ^A	0.51	0.49	0.45	±10.8%
DCP(mV) ^B	100.5	101.8	107.8	

Modulation Calibration Parameters

UID	Communication System Name		A dB	B dB· μV	C	D dB	VR mV	Unc ^E (k=2)
0	CW	X	0.0	0.0	1.0	0.00	199.0	±3.0%
		Y	0.0	0.0	1.0		200.6	
		Z	0.0	0.0	1.0		188.4	

The reported uncertainty of measurement is stated as the standard uncertainty of Measurement multiplied by the coverage factor k=2, which for a normal distribution Corresponds to a coverage probability of approximately 95%.

^A The uncertainties of Norm X, Y, Z do not affect the E²-field uncertainty inside TSL (see Page 5 and Page 6).

^B Numerical linearization parameter: uncertainty not required.

^E Uncertainty is determined using the max. deviation from linear response applying rectangular distribution and is expressed for the square of the field value.



Add: No.51 Xueyuan Road, Haidian District, Beijing, 100191, China
 Tel: +86-10-62304633-2218 Fax: +86-10-62304633-2209
 E-mail: cttl@chinattl.com [Http://www.chinattl.cn](http://www.chinattl.cn)

DASY/EASY – Parameters of Probe: EX3DV4 – SN: 7340

Calibration Parameter Determined in Head Tissue Simulating Media

f [MHz] ^C	Relative Permittivity ^F	Conductivity (S/m) ^F	ConvF X	ConvF Y	ConvF Z	Alpha ^G	Depth ^G (mm)	Unct. (k=2)
835	41.5	0.90	9.45	9.45	9.45	0.11	1.59	± 12%
1750	40.1	1.37	8.46	8.46	8.46	0.19	1.26	± 12%
1900	40.0	1.40	8.21	8.21	8.21	0.20	1.19	± 12%
2450	39.2	1.80	7.44	7.44	7.44	0.34	1.09	± 12%
2600	39.0	1.96	7.31	7.31	7.31	0.38	0.97	± 12%
5250	35.9	4.71	5.31	5.31	5.31	0.35	1.45	± 13%
5600	35.5	5.07	4.82	4.82	4.82	0.35	1.65	± 13%
5750	35.4	5.22	4.88	4.88	4.88	0.35	1.90	± 13%

^C Frequency validity above 300 MHz of ±100MHz only applies for DASY v4.4 and higher (Page 2), else it is restricted to ±50MHz. The uncertainty is the RSS of ConvF uncertainty at calibration frequency and the uncertainty for the indicated frequency band. Frequency validity below 300 MHz is ± 10, 25, 40, 50 and 70 MHz for ConvF assessments at 30, 64, 128, 150 and 220 MHz respectively. Above 5 GHz frequency validity can be extended to ± 110 MHz.

^F At frequency below 3 GHz, the validity of tissue parameters (ϵ and σ) can be relaxed to ±10% if liquid compensation formula is applied to measured SAR values. At frequencies above 3 GHz, the validity of tissue parameters (ϵ and σ) is restricted to ±5%. The uncertainty is the RSS of the ConvF uncertainty for indicated target tissue parameters.

^G Alpha/Depth are determined during calibration. SPEAG warrants that the remaining deviation due to the boundary effect after compensation is always less than ± 1% for frequencies below 3 GHz and below ± 2% for the frequencies between 3-6 GHz at any distance larger than half the probe tip diameter from the boundary.

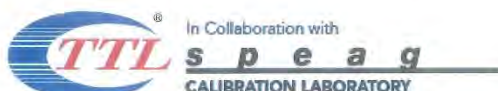

Add: No.51 Xueyuan Road, Haidian District, Beijing, 100191, China
 Tel: +86-10-62304633-2218 Fax: +86-10-62304633-2209
 E-mail: cttl@chinattl.com [Http://www.chinattl.cn](http://www.chinattl.cn)

DASY/EASY – Parameters of Probe: EX3DV4 – SN: 7340

Calibration Parameter Determined in Body Tissue Simulating Media

f [MHz] ^C	Relative Permittivity ^F	Conductivity (S/m) ^F	ConvF X	ConvF Y	ConvF Z	Alpha ^G	Depth ^G (mm)	Unct. (k=2)
835	55.2	0.97	9.91	9.91	9.91	0.16	1.46	± 12%
1750	53.4	1.49	8.25	8.25	8.25	0.17	1.38	± 12%
1900	53.3	1.52	7.96	7.96	7.96	0.16	1.43	± 12%
2450	52.7	1.95	7.71	7.71	7.71	0.46	0.94	± 12%
2600	52.5	2.16	7.48	7.48	7.48	0.44	0.94	± 12%
5250	48.9	5.36	4.82	4.82	4.82	0.45	1.70	± 13%
5600	48.5	5.77	4.12	4.12	4.12	0.50	1.85	± 13%
5750	48.3	5.94	4.56	4.56	4.56	0.50	1.90	± 13%

^C Frequency validity above 300 MHz of ±100MHz only applies for DASY v4.4 and higher (Page 2), else it is restricted to ±50MHz. The uncertainty is the RSS of ConvF uncertainty at calibration frequency and the uncertainty for the indicated frequency band. Frequency validity below 300 MHz is ± 10, 25, 40, 50 and 70 MHz for ConvF assessments at 30, 64, 128, 150 and 220 MHz respectively. Above 5 GHz frequency validity can be extended to ± 110 MHz.

^F At frequency below 3 GHz, the validity of tissue parameters (ϵ and σ) can be relaxed to ±10% if liquid compensation formula is applied to measured SAR values. At frequencies above 3 GHz, the validity of tissue parameters (ϵ and σ) is restricted to ±5%. The uncertainty is the RSS of the ConvF uncertainty for indicated target tissue parameters.

^G Alpha/Depth are determined during calibration. SPEAG warrants that the remaining deviation due to the boundary effect after compensation is always less than ± 1% for frequencies below 3 GHz and below ± 2% for the frequencies between 3-6 GHz at any distance larger than half the probe tip diameter from the boundary.



Add: No.51 Xueyuan Road, Haidian District, Beijing, 100191, China
Tel: +86-10-62304633-2218 Fax: +86-10-62304633-2209
E-mail: cttl@chinattl.com [Http://www.chinattl.cn](http://www.chinattl.cn)

Frequency Response of E-Field (TEM-Cell: ifi110 EXX, Waveguide: R22)

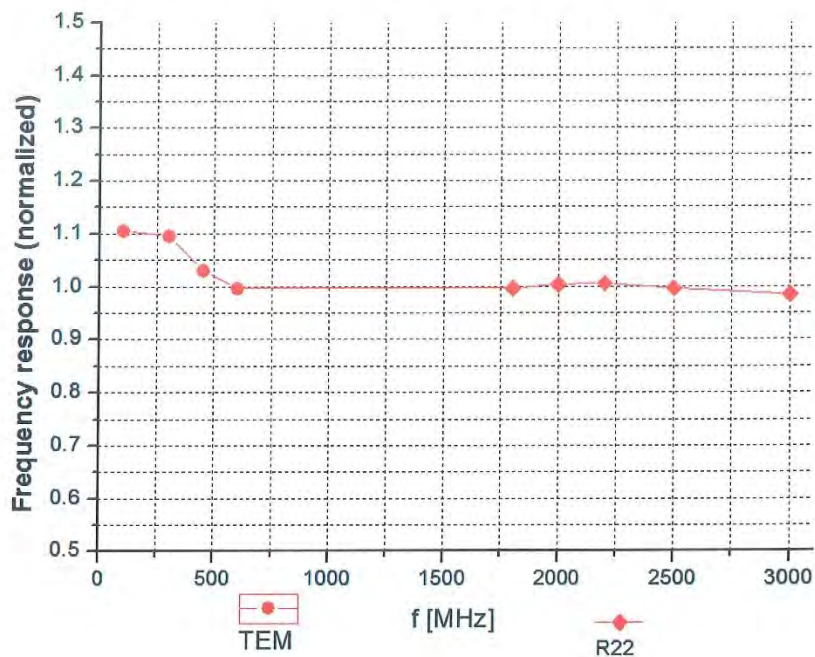

Uncertainty of Frequency Response of E-field: $\pm 7.5\%$ ($k=2$)



Add: No.51 Xueyuan Road, Haidian District, Beijing, 100191, China
 Tel: +86-10-62304633-2218 Fax: +86-10-62304633-2209
 E-mail: cttl@chinattl.com [Http://www.chinattl.cn](http://www.chinattl.cn)

Receiving Pattern (Φ), $\theta=0^\circ$

f=600 MHz, TEM

f=1800 MHz, R22

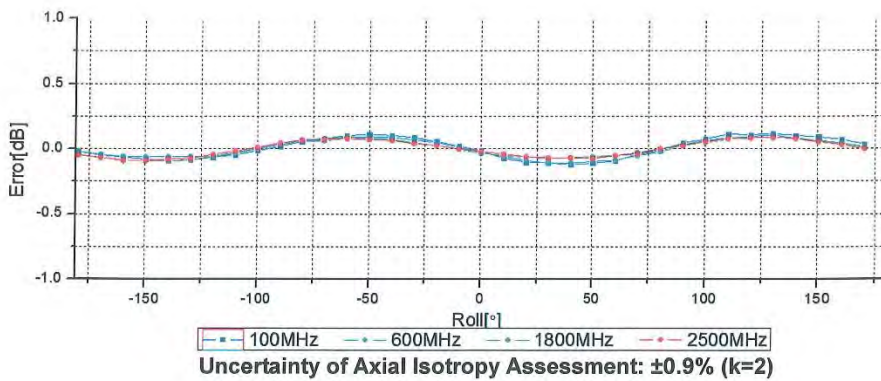
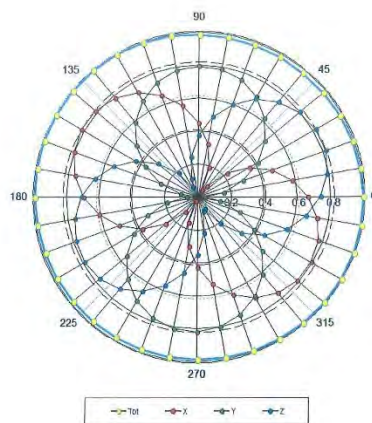
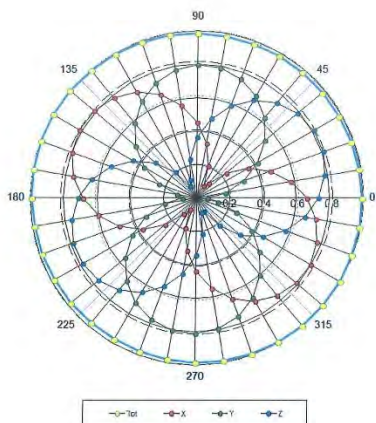



Add: No.51 Xueyuan Road, Haidian District, Beijing, 100191, China
 Tel: +86-10-62304633-2218 Fax: +86-10-62304633-2209
 E-mail: cttl@chinattl.com [Http://www.chinattl.cn](http://www.chinattl.cn)

Dynamic Range f(SAR_{head}) (TEM cell, f = 900 MHz)

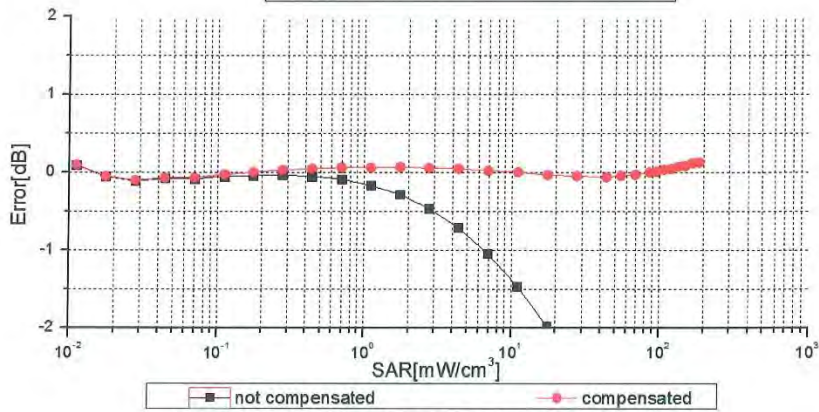
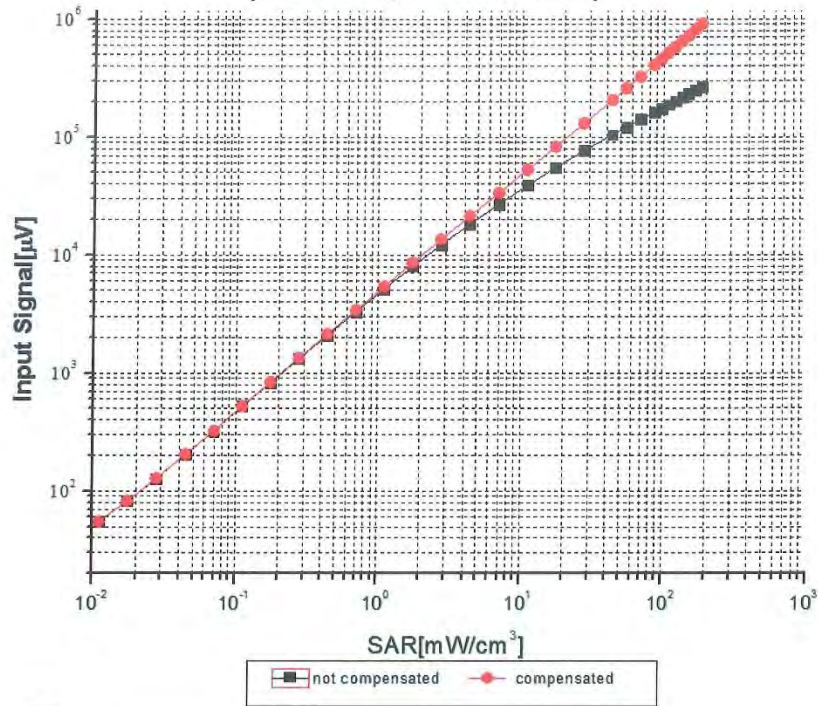

Uncertainty of Linearity Assessment: ±0.9% (k=2)



Add: No.51 Xueyuan Road, Haidian District, Beijing, 100191, China
 Tel: +86-10-62304633-2218 Fax: +86-10-62304633-2209
 E-mail: cttl@chinattl.com [Http://www.chinattl.cn](http://www.chinattl.cn)

Conversion Factor Assessment

f=835 MHz, WGLS R9(H_convF)

f=1750 MHz, WGLS R22(H_convF)

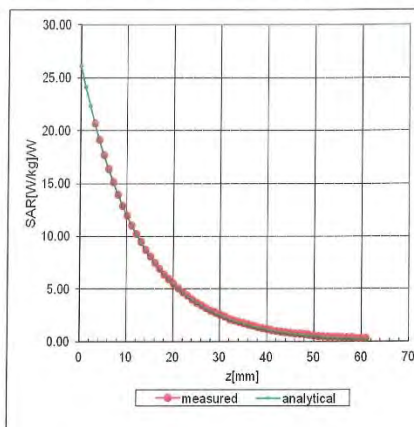
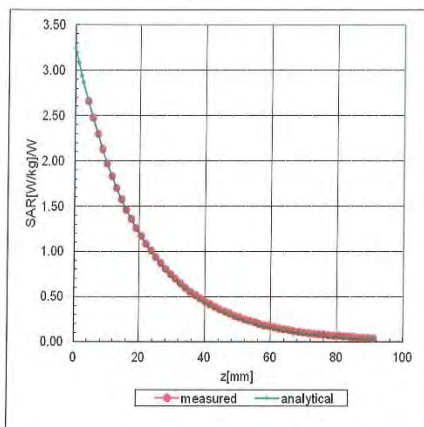

Deviation from Isotropy in Liquid

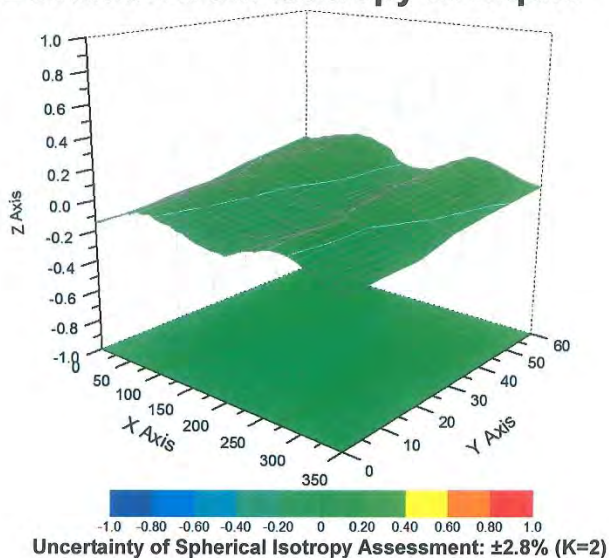



Add: No.51 Xueyuan Road, Haidian District, Beijing, 100191, China
Tel: +86-10-62304633-2218 Fax: +86-10-62304633-2209
E-mail: ctl@chinattl.com [Http://www.chinattl.cn](http://www.chinattl.cn)

DASY/EASY – Parameters of Probe: EX3DV4 – SN: 7340

Other Probe Parameters

Sensor Arrangement	Triangular
Connector Angle (°)	127.9
Mechanical Surface Detection Mode	enabled
Optical Surface Detection Mode	disable
Probe Overall Length	337mm
Probe Body Diameter	10mm
Tip Length	9mm
Tip Diameter	2.5mm
Probe Tip to Sensor X Calibration Point	1mm
Probe Tip to Sensor Y Calibration Point	1mm
Probe Tip to Sensor Z Calibration Point	1mm
Recommended Measurement Distance from Surface	1.4mm

F.2 Data Acquisition Electronics



In Collaboration with
 Add: No.51 Xueyuan Road, Haidian District, Beijing, 100191, China
 Tel: +86-10-62304633-2218 Fax: +86-10-62304633-2209
 E-mail: cttl@chinattl.com [Http://www.chinattl.cn](http://www.chinattl.cn)



中国认可
 国际互认
 校准
 CALIBRATION
 CNAS L0570

Client : **baluntek**

Certificate No: **Z16-97249**

CALIBRATION CERTIFICATE

Object: DAE4 - SN: 1454

Calibration Procedure(s): FD-Z11-002-01
 Calibration Procedure for the Data Acquisition Electronics (DAEx)



Calibration date: December 19, 2016

This calibration Certificate documents the traceability to national standards, which realize the physical units of measurements(SI). The measurements and the uncertainties with confidence probability are given on the following pages and are part of the certificate.

All calibrations have been conducted in the closed laboratory facility: environment temperature(22±3)°C and humidity<70%.

Calibration Equipment used (M&TE critical for calibration)

Primary Standards	ID #	Cal Date(Calibrated by, Certificate No.)	Scheduled Calibration
Process Calibrator 753	1971018	27-June-16 (CTTL, No:J16X04778)	June-17

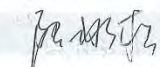
	Name	Function	Signature
Calibrated by:	Yu Zongying	SAR Test Engineer	
Reviewed by:	Qi Dianyuan	SAR Project Leader	
Approved by:	Lu Bingsong	Deputy Director of the laboratory	

Issued: December 20, 2016

This calibration certificate shall not be reproduced except in full without written approval of the laboratory.



Add: No.51 Xueyuan Road, Haidian District, Beijing, 100191, China
Tel: +86-10-62304633-2218 Fax: +86-10-62304633-2209
E-mail: cttl@chinattl.com Http://www.chinattl.cn

Glossary:

DAE data acquisition electronics
Connector angle information used in DASY system to align probe sensor X to the robot coordinate system.

Methods Applied and Interpretation of Parameters:

- *DC Voltage Measurement:* Calibration Factor assessed for use in DASY system by comparison with a calibrated instrument traceable to national standards. The figure given corresponds to the full scale range of the voltmeter in the respective range.
- *Connector angle:* The angle of the connector is assessed measuring the angle mechanically by a tool inserted. Uncertainty is not required.
- The report provide only calibration results for DAE, it does not contain other performance test results.



Add: No.51 Xueyuan Road, Haidian District, Beijing, 100191, China
Tel: +86-10-62304633-2218 Fax: +86-10-62304633-2209
E-mail: cttl@chinattl.com Http://www.chinattl.cn

DC Voltage Measurement

A/D - Converter Resolution nominal

High Range: 1LSB = 6.1 μ V, full range = -100...+300 mV
Low Range: 1LSB = 61nV, full range = -1.....+3mV

DASY measurement parameters: Auto Zero Time: 3 sec; Measuring time: 3 sec

Calibration Factors	X	Y	Z
High Range	404.200 \pm 0.15% (k=2)	403.691 \pm 0.15% (k=2)	403.761 \pm 0.15% (k=2)
Low Range	4.01279 \pm 0.7% (k=2)	3.99157 \pm 0.7% (k=2)	3.99958 \pm 0.7% (k=2)

Connector Angle

Connector Angle to be used in DASY system	316.5 $^{\circ}$ \pm 1 $^{\circ}$
---	-------------------------------------



F.3 Dual Logo-CTTL-SPEAG-certificates

Schmid & Partner Engineering AG

s p e a g

Zeughausstrasse 43, 8004 Zurich, Switzerland
Phone +41 44 245 9700, Fax +41 44 245 9779
info@speag.com, <http://www.speag.com>

Tolan Tu
Shenzhen BALUN Technology Co., Ltd.
Block B, FL 1, Baisha Science and Technology
Park, Shahe Xi Road, Nanshan District,
ShenZhen, GuangDong Province,
P. R. China

Email: tulang@baluntek.com

Zurich, March 4, 2016/ kp

To whom it may concern:

Schmid & Partner Engineering AG (SPEAG), established and reputable manufacturers of dosimetry equipment at Zeughausstrasse 43 CH - 8004 Zurich Switzerland, do hereby certify that below listed calibration certificates have been approved for release under CTTL-SPEAG dual-logo as per QAP4CAL agreement between SPEAG and CTTL Beijing SAR calibration lab.

Certificate No. Z15-97195 (calibration of DAE4 – SN: 1454)
Certificate No. Z15-97196 (calibration of EX3DV4 – SN: 7340)

Yours sincerely,



Schmid & Partner Engineering AG

s p e a g

Schmid & Partner Engineering AG
Zeughausstrasse 43, 8004 Zurich, Switzerland
Phone +41 44 245 9700, Fax +41 44 245 9779
info@speag.com, <http://www.speag.com>

Dr. Katja Pokovic
Director Laboratory & Services

F.4 Dipole Performance Measurement Report

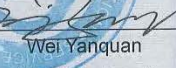
SAR Dipole Performance Measurement Report	ISSUED BY Shenzhen BALUN Technology Co., Ltd. 
	FOR Validation Dipoles
	
Tested by:  Tu Lang (Engineer)	Report No.: LW-SZ16C0109-701
	EUT Type: SAR Validation Dipole
Approved by:  Wei Yanquan (Chief Engineer)	Model Name: D835V2, D1750V2 D1900V2, D2450V2 D2600V2, D5GHzV2
	Brand Name: Speag
	Test Conclusion: Pass
	Test Date: Oct. 22, 2016 ~ Oct. 26, 2016
	Date of Issue: Oct. 29, 2016

NOTE: This test report can be duplicated completely for the legal use with the approval of the applicant; it shall not be reproduced except in full, without the written approval of Shenzhen BALUN Technology Co., Ltd. BALUN Laboratory. Any objections should be raised within thirty days from the date of issue. To validate the report, please contact us.



1 GENERAL INFORMATION

1.1 Introduction

This document contains a summary of the requirements set forth by the IEEE 1528, FCC KDB 865664 D01 for reference dipoles used for SAR measurement system validations. Instead of the typical annual calibration recommended by measurement standards, the reference dipoles were demonstrated that the SAR target, impedance and return loss have remain stable, so the longer calibration interval is acceptable.

1.2 General Description for Equipment under Test (EUT)

EUT Type	DASY 52 Reference Dipoles
Manufacturer	Speag

Parameter	EUT 1	EUT 2	EUT 3	EUT 4	EUT 5	EUT 6
Model	D835V2	D1750V2	D1900V2	D2450V2	D2600V2	D5GHzV2
Frequency	835 MHz	1750 MHz	1900 MHz	2450 MHz	2600 MHz	5GHz-6GHz
Serial Number	SN 4d187	SN 1130	SN 5d193	SN 952	SN 1095	SN 1200
Product Condition (New/Used)	Used	Used	Used	Used	Used	Used
Last Cal. Date	2014/11/26	2014/11/28	2014/11/28	2014/11/27	2014/11/27	2014/12/4
Previous meas. Date	2015/10/25	2015/10/23	2015/10/25	2015/10/24	2015/10/24	2015/10/26
Current meas. Date	2016/10/24	2016/10/25	2016/10/22	2016/10/23	2016/10/23	2016/10/26



1.3 EUT Photos

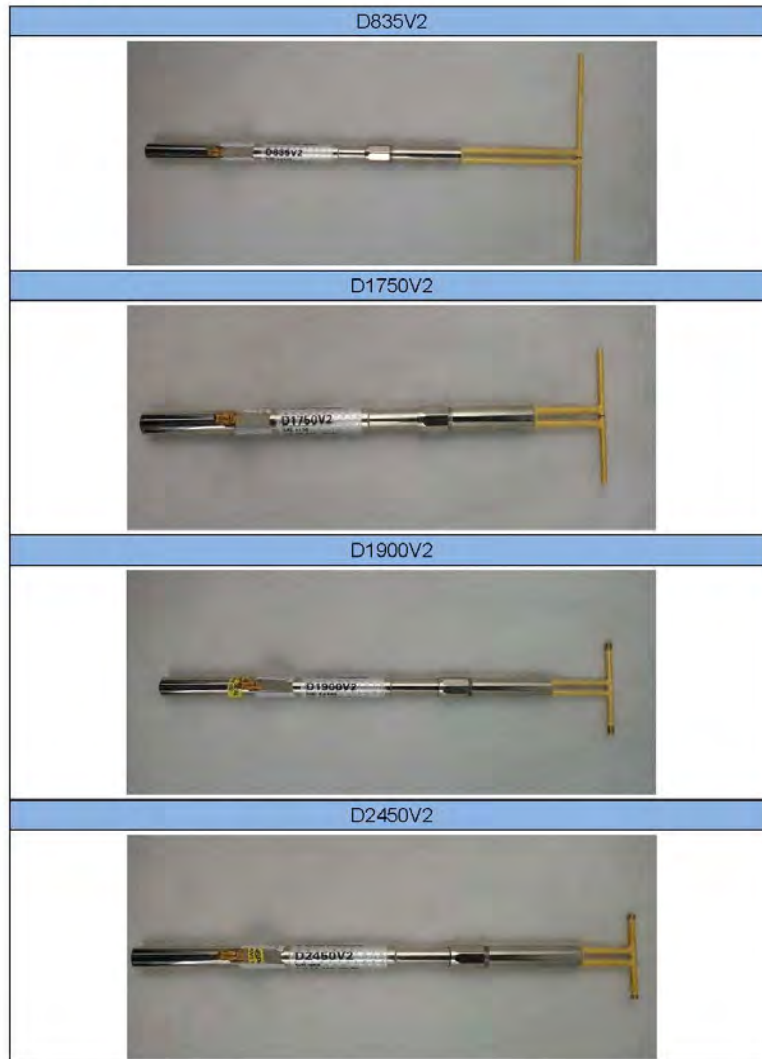





2 SIMULATING LIQUID VERIFICATION

Liquid Type	Freq. (MHz)	Meas. Conductivity (σ) (S/m)	Meas. Permittivity (ϵ)	Target Conductivity (σ) (S/m)	Target Permittivity (ϵ)	Conductivity Tolerance (%)	Permittivity Tolerance (%)
Head	835	0.89	41.31	0.90	41.50	-1.11	-0.46
Body	835	0.96	55.83	0.97	55.20	-1.03	1.14
Head	1750	1.38	39.86	1.37	40.10	0.73	-0.60
Body	1750	1.47	52.80	1.49	53.40	-1.34	-1.12
Head	1900	1.41	39.64	1.40	40.00	0.71	-0.90
Body	1900	1.52	51.41	1.52	53.30	0.00	-3.55
Head	2450	1.85	39.11	1.80	39.20	2.78	-0.23
Body	2450	1.96	51.07	1.95	52.70	0.51	-3.09
Head	2600	1.96	38.73	1.96	39.00	0.00	-0.69
Body	2600	2.18	50.49	2.16	52.50	0.93	-3.83
Head	5200	4.73	36.21	4.66	36.00	1.50	0.61
Body	5200	5.41	48.93	5.30	49.00	2.08	-0.16
Head	5600	4.97	34.83	5.07	35.50	-1.97	-1.97
Body	5600	5.74	47.08	5.77	48.50	-0.52	-2.87
Head	5800	5.39	34.37	5.27	35.30	2.28	-2.63
Body	5800	5.91	46.83	6.00	48.20	-1.50	-2.84



3 DIPOLE IMPEDANCE AND RETURN LOSS

The dipoles are designed to have low return loss when presented against a flat phantom at the specified distance. A Vector Network Analyser was used to perform a return loss measurement on the specific dipole when in the measurement location against the phantom and the distance was specified by the manufacturer with a special, low loss and low relative permittivity spacer.

The impedance was measured at the SMA-connector with the network analyser.

The measurement of verification with return loss should not deviate by more than 20% and minimum of 20 dB of the return loss, and the impedance (real or imaginary parts) should not deviate by more than 5 Ohms from the previous measurement using network analyzer.

Note:

The "Previous Meas." in the following table refer to dipoles or other equivalent RF sources calibration reports.



3.1 D835V2

RETURN LOSS AND IMPEDANCE IN HEAD LIQUID

Meas. Results	Current Meas.	Previous Meas.	Max. Deviation
Return Loss (dB)	-28.709	-30.227	-5.0%
Impedance	46.7 Ω + 0.665 j Ω	48.0 Ω - 0.842 j Ω	1.507 Ω (Imaginary part)

Return Loss

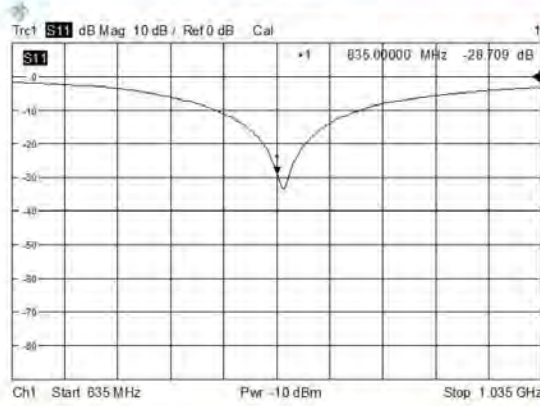

Impedance

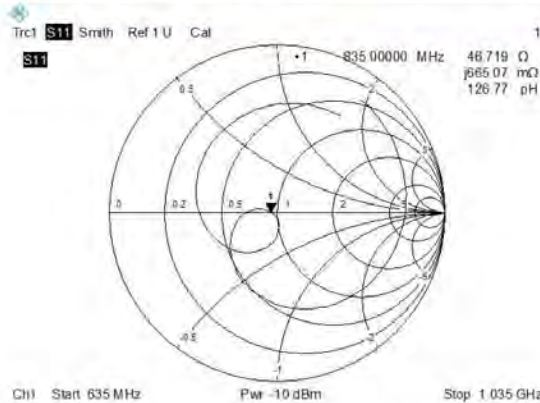



RETURN LOSS AND IMPEDANCE IN BODY LIQUID

Meas. Results	Current Meas.	Previous Meas.	Max. Deviation
Return Loss (dB)	-24.238	-24.404	-0.7%
Impedance	46.5 Ω -0.524 j Ω	46.9 Ω -0.337 j Ω	-0.4 Ω (Real part)

Return Loss

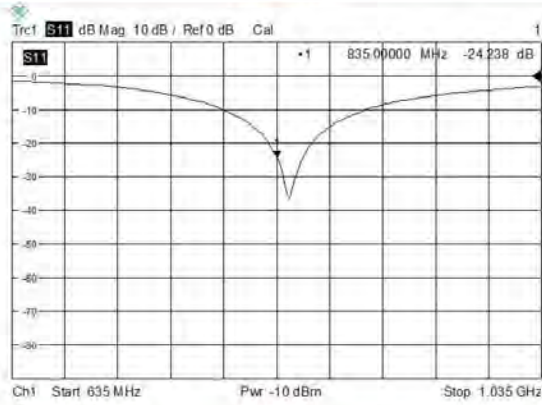

Impedance

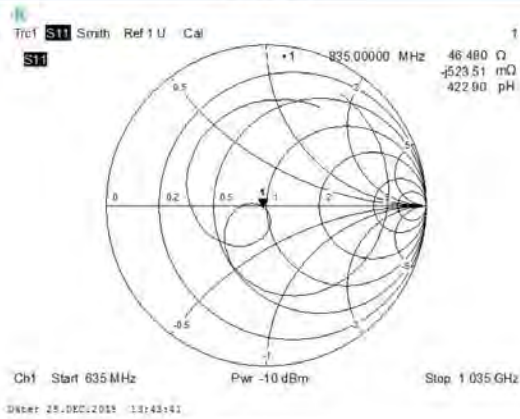



3.2 D1750V2

RETURN LOSS AND IMPEDANCE IN HEAD LIQUID

Meas. Results	Current Meas.	Previous Meas.	Max. Deviation
Return Loss (dB)	-33.854	-37.494	-9.7%
Impedance	48.1 Ω + 0.387 j Ω	48.8 Ω - 0.448 j Ω	0.835 Ω (Imaginary part)

Return Loss

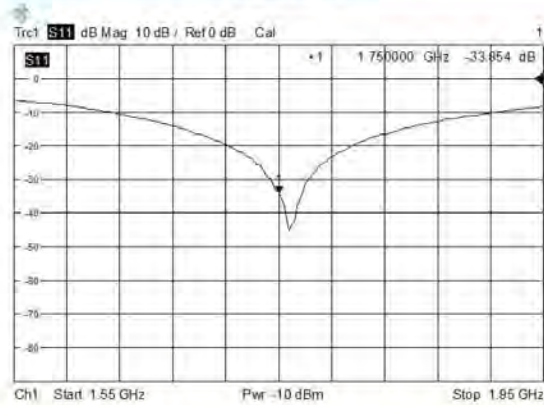

Impedance

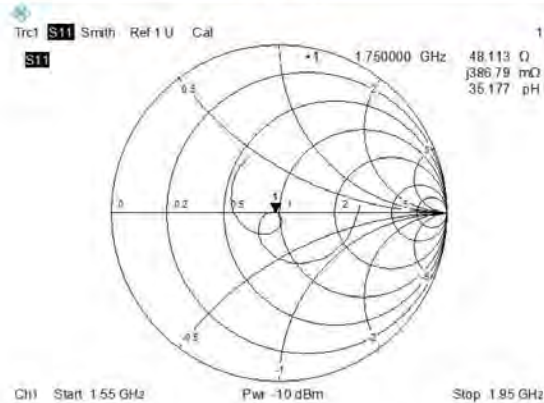



RETURN LOSS AND IMPEDANCE IN BODY LIQUID

Meas. Results	Current Meas.	Previous Meas.	Max. Deviation
Return Loss (dB)	-25.511	-25.849	-1.3%
Impedance	47.1 Ω -0.334 jΩ	48.0 Ω + 4.534 jΩ	-4.868Ω (Imaginary part)

Return Loss

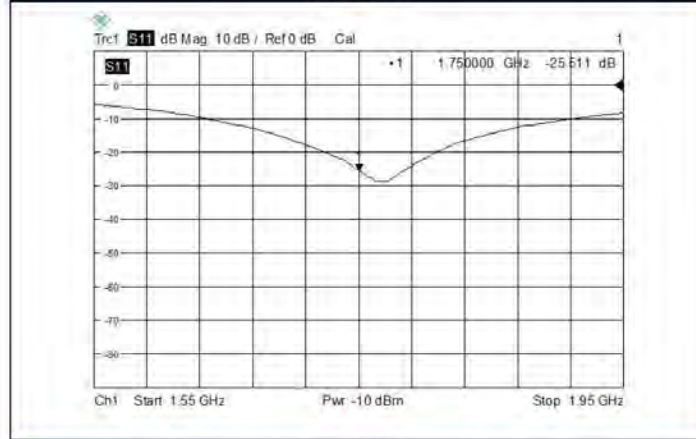

Impedance

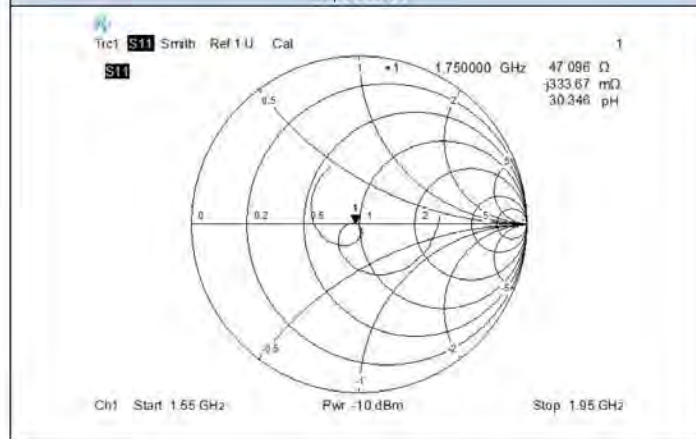



3.3 D1900V2

RETURN LOSS AND IMPEDANCE IN HEAD LIQUID

Meas. Results	Current Meas.	Previous Meas.	Max. Deviation
Return Loss (dB)	-28.816	-26.098	10.4%
Impedance	48.9 Ω +1.191 j Ω	49,520 Ω +2.091 j Ω	-0.900 Ω (Imaginary part)

Return Loss

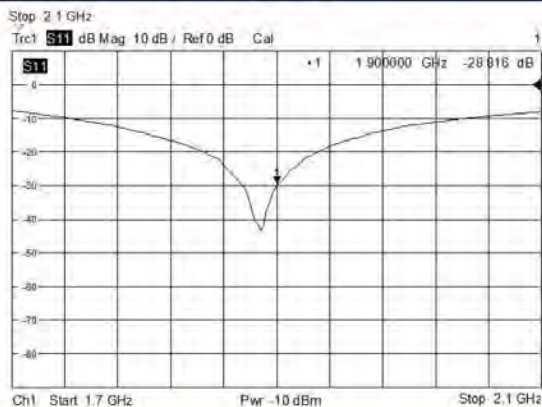

Impedance

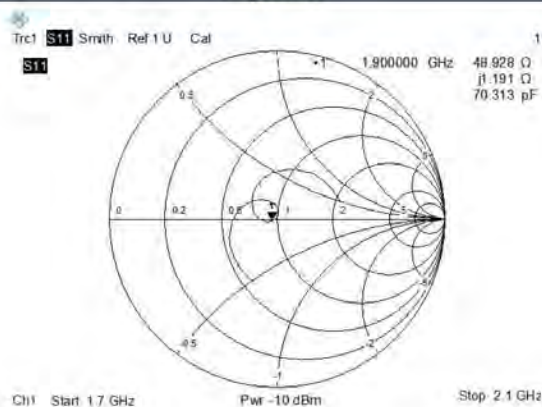

RETURN LOSS AND IMPEDANCE IN BODY LIQUID

Meas. Results	Current Meas.	Previous Meas.	Max. Deviation
Return Loss (dB)	-25.040	-25.957	-3.5%
Impedance	49.1 Ω +2.703 j Ω	48.4 Ω + 2.6 j Ω	0.700 Ω (Real part)

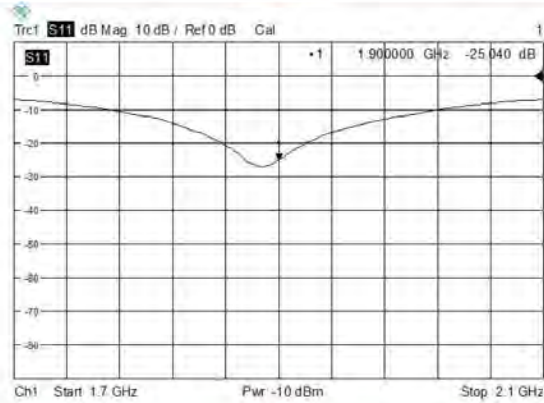
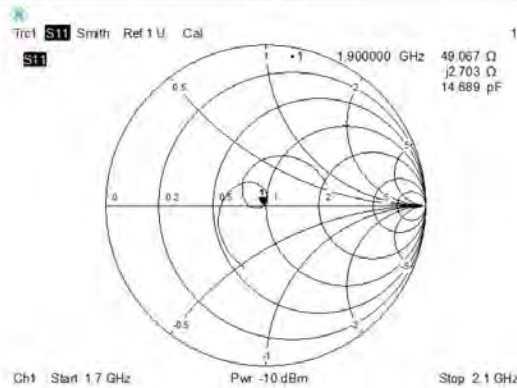
Return Loss

Impedance



3.4 D2450V2

RETURN LOSS AND IMPEDANCE IN HEAD LIQUID

Meas. Results	Current Meas.	Previous Meas.	Max. Deviation
Return Loss (dB)	-28.271	-27.642	2.3%
Impedance	49.7 Ω + 1.669 j Ω	49.5 Ω + 1.998 j Ω	-0.329 Ω (Imaginary part)

Return Loss

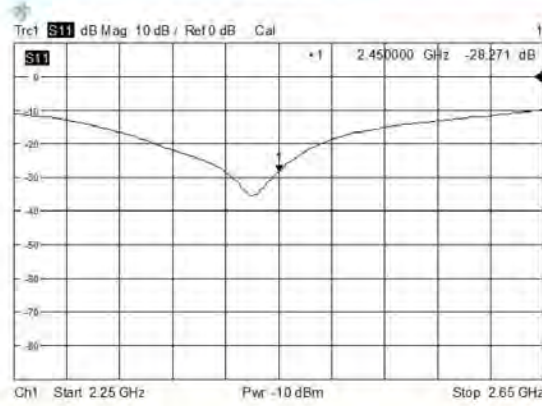

Impedance

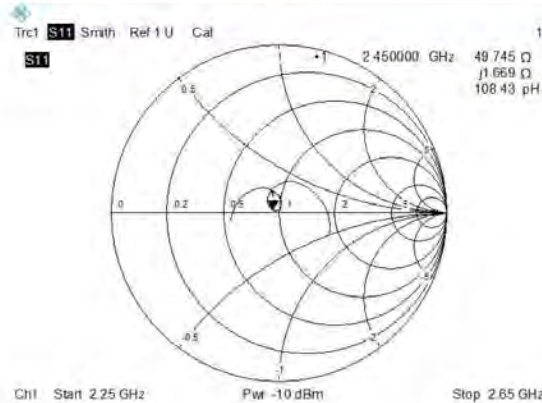



RETURN LOSS AND IMPEDANCE IN BODY LIQUID

Meas. Results	Current Meas.	Previous Meas.	Max. Deviation
Return Loss (dB)	-27.205	-27.494	-1.1%
Impedance	46.3 Ω + 0.500 jΩ	46.8 Ω + 0.699 jΩ	-0.500Ω (Real part)

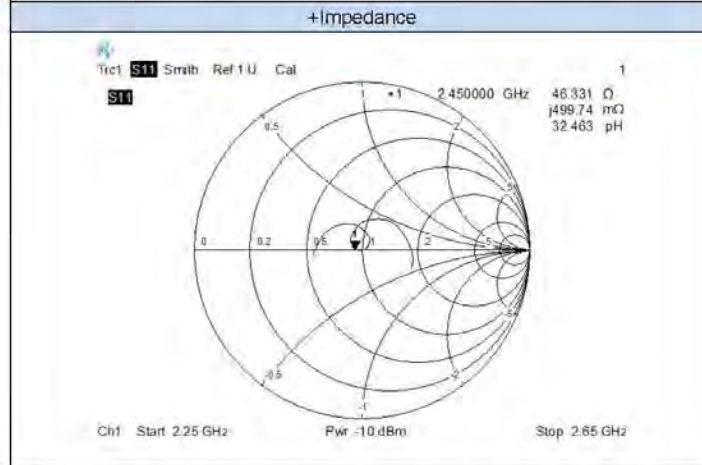
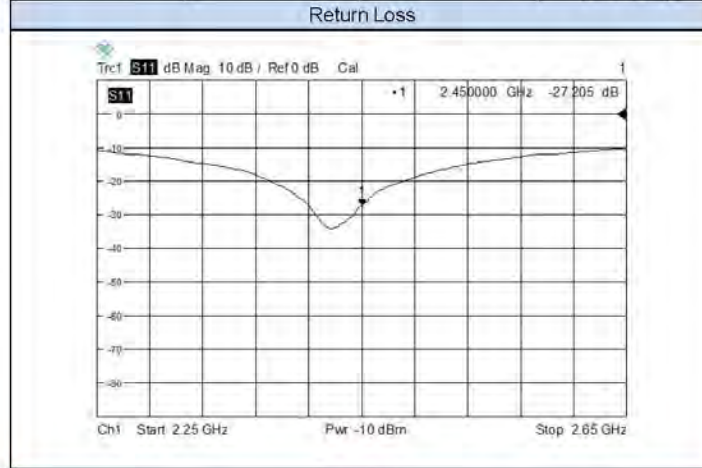



3.5 D2600V2

RETURN LOSS AND IMPEDANCE IN HEAD LIQUID

Meas. Results	Current Meas.	Previous Meas.	Max. Deviation
Return Loss (dB)	-26.786	-27.314	-1.9%
Impedance	52.1 Ω - 6.255 j Ω	53.3 Ω - 3.186 j Ω	-3.069 Ω (Imaginary part)

Return Loss

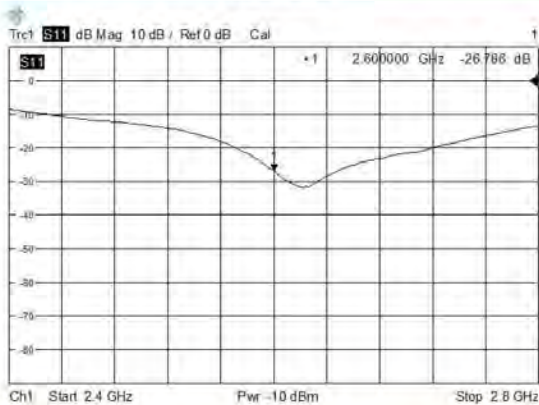

Impedance

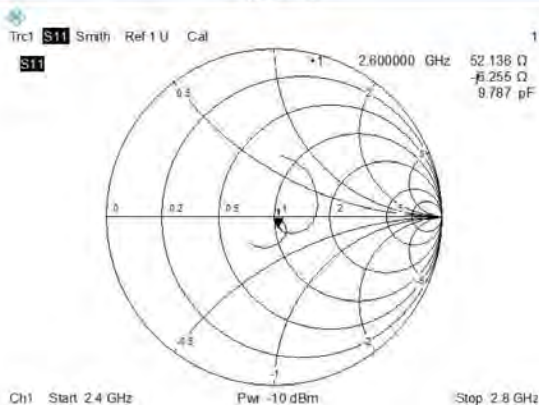



RETURN LOSS AND IMPEDANCE IN BODY LIQUID

Meas. Results	Current Meas.	Previous Meas.	Max. Deviation
Return Loss (dB)	-29.663	-30.161	-1.7%
Impedance	48.8 Ω - 6.554 j Ω	50.6 Ω - 3.015 j Ω	-3.539 Ω (Imaginary part)

Return Loss

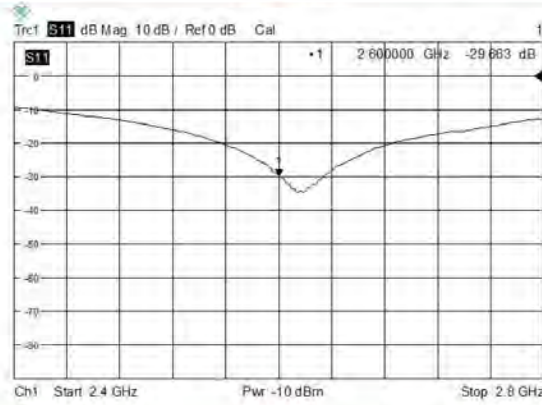

Impedance

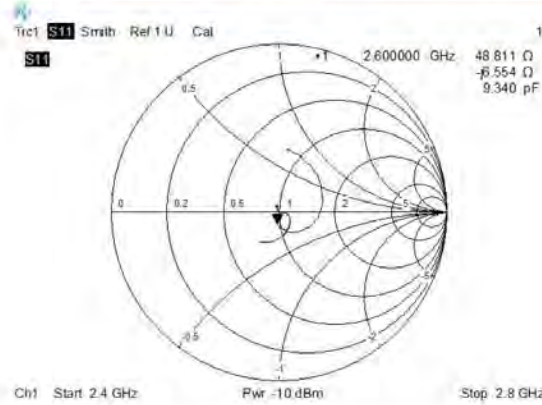



3.6 D5GHzV2

RETURN LOSS AND IMPEDANCE IN HEAD LIQUID

Meas. Results	Current Meas.	Previous Meas.	Max. Deviation
5200 MHz			
Return Loss (dB)	-31.741	-31.668	0.2%
Impedance	49.0 Ω + 3.470 jΩ	47.8 Ω + 1.415 jΩ	2.055Ω (Imaginary part)
5600 MHz			
Return Loss (dB)	-24.538	-22.615	8.5%
Impedance	54.9 Ω + 2.893 jΩ	53.4 Ω + 2.757 jΩ	1.500Ω (Real part)
5800 MHz			
Return Loss (dB)	-31.921	-29.503	8.2%
Impedance	48.3 Ω - 0.066 jΩ	51.1 Ω + 3.189 jΩ	-3.255Ω (Imaginary part)

Return Loss

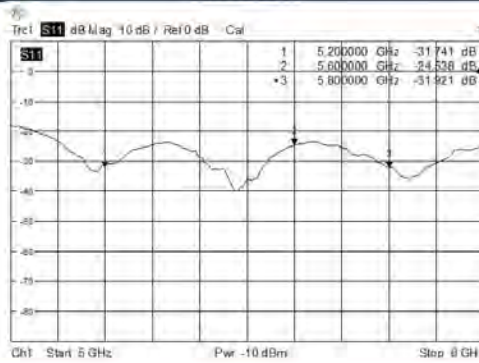

Impedance

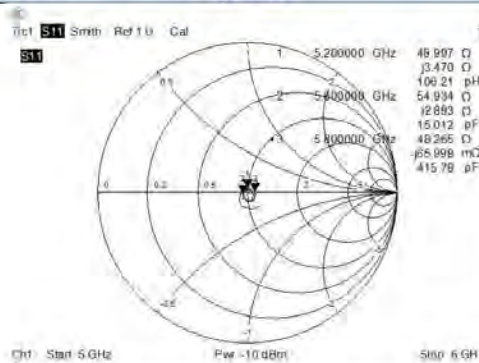



RETURN LOSS AND IMPEDANCE IN BODY LIQUID

Meas. Results	Current Meas.	Previous Meas.	Max. Deviation
5200 MHz			
Return Loss (dB)	-29.128	-30.037	-3.0%
Impedance	50.1 Ω + 3.859 jΩ	47.2 Ω + 1.088 jΩ	2.9Ω (Real part)
5600 MHz			
Return Loss (dB)	-24.714	-21.932	12.7%
Impedance	53.8 Ω + 2.745 jΩ	52.0 Ω + 2.425 jΩ	1.8Ω (Real part)
5800 MHz			
Return Loss (dB)	-30.581	-28.420	7.6%
Impedance	47.2 Ω + 1.171 jΩ	51.6 Ω + 3.436 jΩ	-4.4Ω (Real part)

Return Loss

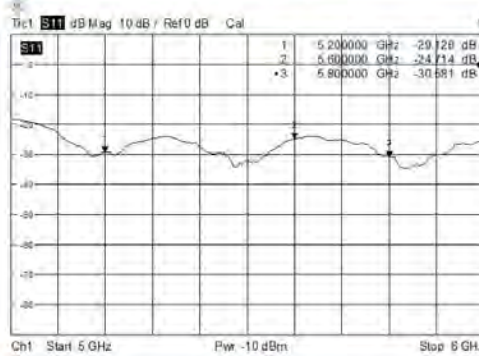

Impedance

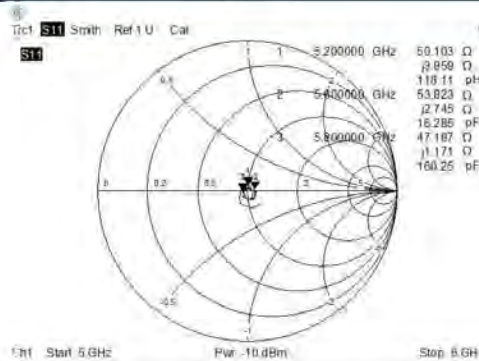



4 VALIDATION MEASUREMENT

The IEEE Std. 1528, FCC KDBs and CEI/IEC 62209 standards state that the system validation measurements must be performed using a reference dipole meeting the fore mentioned return loss and mechanical dimension requirements. The validation measurement must be performed against a liquid filled flat phantom, with the phantom constructed as outlined in the fore mentioned standards. Per the standards, the dipole shall be positioned below the bottom of the phantom, with the dipole length centered and parallel to the longest dimension of the flat phantom, with the top surface of the dipole at the described distance from the bottom surface of the phantom.

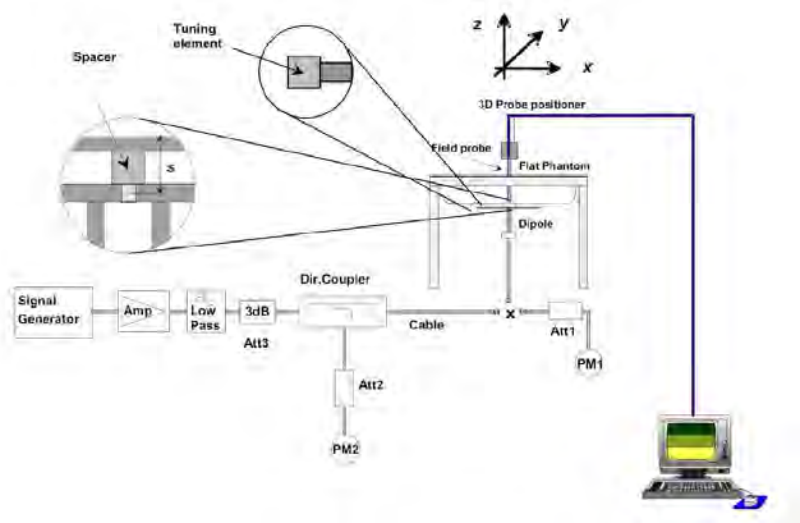



4.1 Dipole SAR Validation Measurement Result

Freq. (MHz)	Liquid Type	Power (mW)	1 g Measured SAR (W/kg)	Normalized SAR (W/kg)	10 g Measured SAR (W/kg)	Normalized SAR (W/kg)	1 g Targeted SAR (W/kg)	Tolerance (%)	10 g Targeted SAR (W/kg)	Tolerance (%)
835	Head	100	0.962	9.62	0.631	6.31	9.56	0.63	6.22	1.45
	Body	100	0.973	9.73	0.656	6.56	9.56	1.78	6.22	5.47
1750	Head	100	3.390	33.90	1.790	17.90	36.40	-6.87	19.30	-7.25
	Body	100	3.470	34.70	1.880	18.80	36.40	-4.67	19.30	-2.59
1900	Head	100	3.930	39.30	1.990	19.90	39.70	-1.01	20.50	-2.93
	Body	100	4.140	41.40	2.170	21.70	39.70	4.28	20.50	5.85
2450	Head	100	5.470	54.70	2.440	24.40	52.40	4.39	24.00	1.67
	Body	100	5.380	53.80	2.410	24.10	52.40	2.67	24.00	0.42
2600	Head	100	5.290	52.90	2.330	23.30	55.30	-4.34	24.60	-5.28
	Body	100	5.270	52.70	2.380	23.80	55.30	-4.70	24.60	-3.25
5200	Head	100	8.030	80.30	2.110	21.10	76.50	4.97	21.60	-2.31
	Body	100	8.140	81.40	2.300	23.00	76.50	6.41	21.60	6.48
5600	Head	100	8.170	81.70	2.230	22.30	83.30	-1.92	23.40	-4.70
	Body	100	8.360	83.60	2.240	22.40	83.30	0.36	23.40	-4.27
5800	Head	100	7.390	73.90	2.090	20.90	78.00	-5.26	21.90	-4.57
	Body	100	8.080	80.80	2.210	22.10	78.00	3.59	21.90	0.91



4.2 D835V2

4.2.1 Dipole 835 MHz Validation Measurement for Head Tissue

Dipole 835 MHz; Type: D835V2; Serial: D835V2-SN: 4d187

Date/Time: 10/24/2016

Communication System Band: D835 (835.0 MHz); Frequency: 835 MHz; Duty Cycle: 1:1

Medium parameters used: $f = 835$ MHz; $\sigma = 0.89$ S/m; $\epsilon_r = 41.31$ $\rho = 1000$ kg/m³

Phantom section: Flat Section

Ambient Temperature: 22.3 Liquid Temperature: 21.2

DASY5 Configuration:

- Probe: EX3DV4 - SN7340; ConvF(9.56, 9.56, 9.56);
- Sensor-Surface: 4mm (Mechanical Surface Detection)
- Electronics: DAE4 Sn1454;
- Phantom: SAM (30deg probe tilt) with CRP v5.0 Right 1857; Type: QD000P40CD; Serial: TP1857
- Measurement SW: DASY52, Version 52.8 (8); SEMCAD X Version 14.6.10 (7331)

Dipole validation measurement for Head Tissue/Pin= 100mW , d=15mm/Zoom

Scan (7x7x7)/Cube 0: Measurement grid: dx=5mm, dy=5mm, dz=5mm

Reference Value = 32.37 V/m; Power Drift = -0.02 dB

Peak SAR (extrapolated) = 1.46 W/kg

SAR(1 g) = 0.962 W/kg; SAR(10 g) = 0.631 W/kg

Maximum value of SAR (measured) = 1.04 W/kg

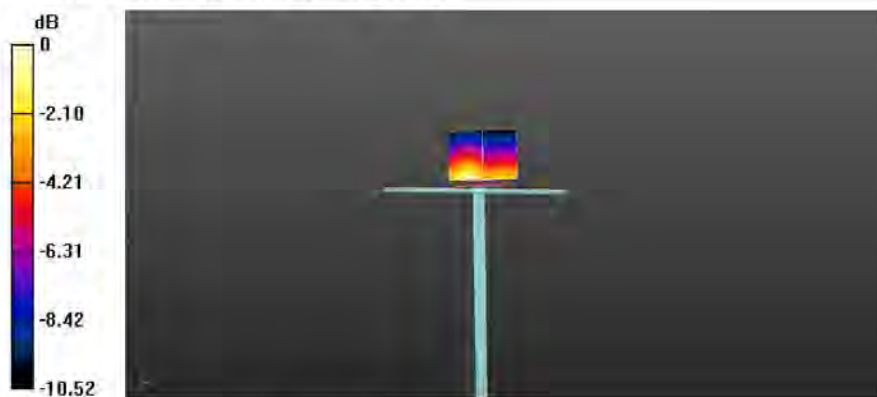

0 dB = 1.04 W/kg = 0.17 dBW/kg



4.2.2 Dipole 835 MHz Validation Measurement for Body Tissue

Dipole 835 MHz; Type: D835V2; Serial: D835V2-SN: 4d187

Date/Time: 10/24/2016

Communication System Band: D835 (835.0 MHz); Frequency: 835 MHz; Duty Cycle: 1:1

Medium parameters used: $f = 835 \text{ MHz}$; $\sigma = 0.96 \text{ S/m}$; $\epsilon_r = 55.83$; $\rho = 1000 \text{ kg/m}^3$

Phantom section: Flat Section

Ambient Temperature: 22.3 Liquid Temperature: 21.2

DASY5 Configuration:

- Probe: EX3DV4 - SN7340; ConvF(9.83, 9.83, 9.83);
- Sensor-Surface: 4mm (Mechanical Surface Detection)
- Electronics: DAE4 Sn1454;
- Phantom: SAM (30deg probe tilt) with CRP v5.0 on Right 1857; Type: QD000P40CD; Serial: TP1857
- Measurement SW: DASY52, Version 52.8 (8); SEMCAD X Version 14.6.10 (7331)

Dipole validation measurement for Body Tissue/Pin= 100mW , d=15mm /Zoom Scan (7x7x7)/Cube 0: Measurement grid: dx=5mm, dy=5mm, dz=5mm

Reference Value = 31.52 V/m; Power Drift = -0.07 dB

Peak SAR (extrapolated) = 1.48 W/kg

SAR(1 g) = 0.973 W/kg; SAR(10 g) = 0.656 W/kg

Maximum value of SAR (measured) = 1.01 W/kg

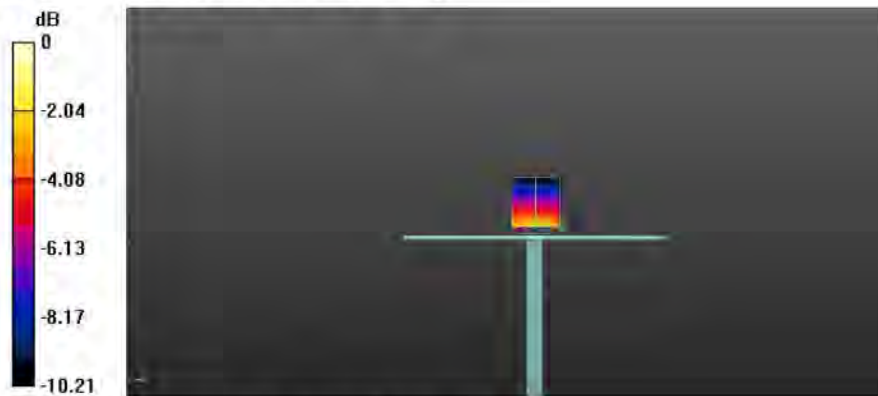

0 dB = 1.01 W/kg = 0.04 dBW/kg



4.3D1750V2

4.3.1 Dipole 1750 MHz Validation Measurement for Head Tissue

Dipole 1750 MHz; Type: D1750V2; Serial: D1750V2-SN: 1130

Date/Time: 10/25/2016

Communication System Band: D1750 (1750.0 MHz); Frequency: 1750 MHz; Duty Cycle: 1:1

Medium parameters used: $f = 1750$ MHz; $\sigma = 1.38$ S/m; $\epsilon_r = 39.86$; $\rho = 1000$ kg/m³

Phantom section: Flat Section

Ambient Temperature: 22.4 Liquid Temperature: 21.2

DASY5 Configuration:

- Probe: EX3DV4 - SN7340; ConvF(8.22,8.22,8.22)
- Sensor-Surface: 4mm (Mechanical Surface Detection)
- Electronics: DAE4 Sn1454;
- Phantom: SAM (30deg probe tilt) with CRP v5.0 on left 1859; Type: QD000P40CD; Serial: TP:1859
- Measurement SW: DASY52, Version 52.8 (8); SEMCAD X Version 14.6.10 (7331)

Dipole validation measurement for Head Tissue/Pin= 100mW ,d=10mm /Zoom

Scan (7x7x7)/Cube 0: Measurement grid: dx=5mm, dy=5mm, dz=5mm

Reference Value = 42.36 V/m; Power Drift = -0.09 dB

Peak SAR (extrapolated) = 6.37 W/kg

SAR(1 g) = 3.39W/kg; SAR(10 g) = 1.79 W/kg

Maximum value of SAR (measured) = 3.79 W/kg

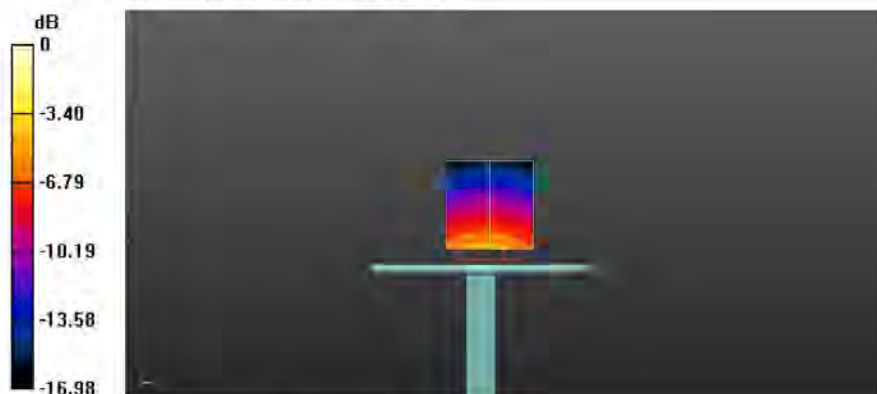

0 dB = 3.79 W/kg = 5.79 dBW/kg



4.3.2 Dipole 1750 MHz Validation Measurement for Body Tissue

Dipole 1750 MHz; Type: D1750V2; Serial: D1750V2-SN: 1130

Date/Time: 10/25/2016

Communication System Band: D1750 (1750.0 MHz); Frequency: 1750 MHz; Duty Cycle: 1:1

Medium parameters used: $f = 1750$ MHz; $\sigma = 1.47$ S/m; $\epsilon_r = 52.80$; $\rho = 1000$ kg/m³

Phantom section: Flat Section

Ambient Temperature: 22.4 Liquid Temperature: 21.2

DASY5 Configuration:

- Probe: EX3DV4 - SN7340; ConvF(7.87, 7.87, 7.87);
- Sensor-Surface: 4mm (Mechanical Surface Detection)
- Electronics: DAE4 Sn1454;
- Phantom: SAM (30deg probe tilt) with CRP v5.0 on left 1859; Type: QD000P40CD; Serial: TP:1859
- Measurement SW: DASY52, Version 52.8 (8); SEMCAD X Version 14.6.10 (7331)

Dipole validation measurement for Body Tissue/Pin= 100mW ,d=10mm /Zoom

Scan (7x7x7)/Cube 0: Measurement grid: dx=5mm, dy=5mm, dz=5mm

Reference Value = 41.31 V/m; Power Drift = -0.10 dB

Peak SAR (extrapolated) = 6.37 W/kg

SAR(1 g) = 3.47 W/kg; SAR(10 g) = 1.88 W/kg

Maximum value of SAR (measured) = 4.06 W/kg

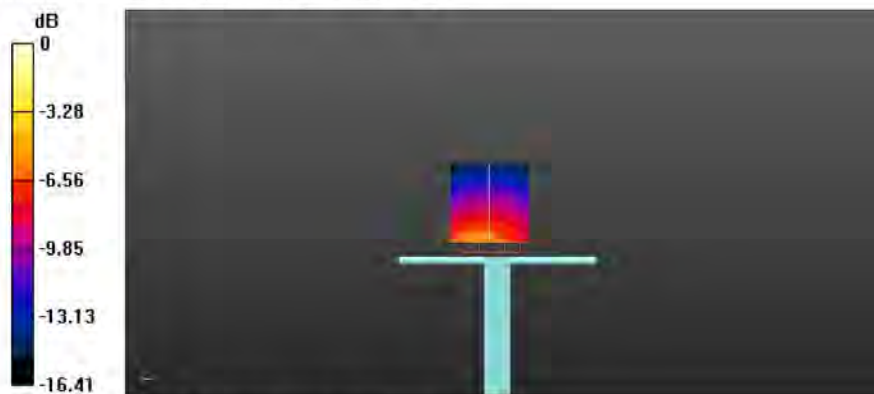

0 dB = 4.06 W/kg = 6.09 dBW/kg



4.4D1900V2

4.4.1 Dipole 1900 MHz Validation Measurement for Head Tissue

Dipole 1900 MHz; Type: D1900V2; Serial: D1900V2-SN: 5d193

Date/Time: 10/22/2016

Communication System Band: D1900 (1900.0 MHz); Frequency: 1900 MHz; Duty Cycle: 1:1

Medium parameters used: $f = 1900$ MHz; $\sigma = 1.41$ S/m; $\epsilon_r = 39.64$; $\rho = 1000$ kg/m³

Phantom section: Flat Section

Ambient Temperature: 22.4 Liquid Temperature: 21.4

DASY5 Configuration:

- Probe: EX3DV4 - SN7340; ConvF(8.15, 8.15, 8.15);
- Sensor-Surface: 4mm (Mechanical Surface Detection)
- Electronics: DAE4 Sn1454;
- Phantom: SAM (30deg probe tilt) with CRP v5.0 on left 1859; Type: QD000P40CD; Serial: TP:1859
- Measurement SW: DASY52, Version 52.8 (8); SEMCAD X Version 14.6.10 (7331)

Dipole validation measurement for Head Tissue/Pin= 100mW ,d=10mm /Zoom

Scan (7x7x7)/Cube 0: Measurement grid: dx=5mm, dy=5mm, dz=5mm

Reference Value = 50.27 V/m; Power Drift = -0.01 dB

Peak SAR (extrapolated) = 6.92 W/kg

SAR(1 g) = 3.93 W/kg; SAR(10 g) = 1.99 W/kg

Maximum value of SAR (measured) = 4.25 W/kg

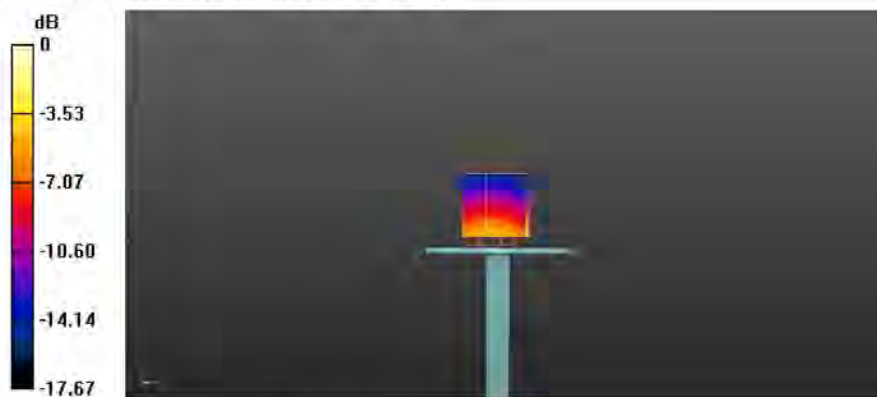

0 dB = 4.25 W/kg = 6.28 dBW/kg