



SAR TEST REPORT

No. I15N00961-SAR

For

Shenzhen Sang Fei Consumer Communications Co.,Ltd

WCMA/GSM digital mobile phone

Model Name: Philips S307

Marketing Name: Philips S307

With

Hardware Version: FS068-MB-V0.2

Software Version: S307_T7731K_1534_V02A_MX

FCC ID: VQRCTS307

Issued Date: 2015-09-10



Note:

The test results in this test report relate only to the devices specified in this report. This report shall not be reproduced except in full without the written approval of CTTL.

Test Laboratory:

CTTL, Telecommunication Technology Labs, Academy of Telecommunication Research, MIIT

No.52, HuayuanNorth Road, Haidian District, Beijing, P. R. China 100191.

Tel:+86(0)10-62304633-2512,Fax:+86(0)10-62304633-2504

Email:ctl_terminals@catr.cn, website:www.chinattl.com



REPORT HISTORY

Report Number	Revision	Issue Date	Description
I15N00961-SAR	Rev.0	2015-09-10	Initial creation of test report

TABLE OF CONTENT

1 TEST LABORATORY	5
1.1 TESTING LOCATION	5
1.2 TESTING ENVIRONMENT.....	5
1.3 PROJECT DATA	5
1.4 SIGNATURE.....	5
2 STATEMENT OF COMPLIANCE	6
3 CLIENT INFORMATION	8
3.1 APPLICANT INFORMATION	8
3.2 MANUFACTURER INFORMATION	8
4 EQUIPMENT UNDER TEST (EUT) AND ANCILLARY EQUIPMENT (AE)	9
4.1 ABOUT EUT	9
4.2 INTERNAL IDENTIFICATION OF EUT USED DURING THE TEST	9
4.3 INTERNAL IDENTIFICATION OF AE USED DURING THE TEST	9
5 TEST METHODOLOGY	10
5.1 APPLICABLE LIMIT REGULATIONS	10
5.2 APPLICABLE MEASUREMENT STANDARDS.....	10
6 SPECIFIC ABSORPTION RATE (SAR).....	11
6.1 INTRODUCTION.....	11
6.2 SAR DEFINITION.....	11
7 TISSUE SIMULATING LIQUIDS	12
7.1 TARGETS FOR TISSUE SIMULATING LIQUID	12
7.2 DIELECTRIC PERFORMANCE	12
8 SYSTEM VERIFICATION	16
8.1 SYSTEM SETUP.....	16
8.2 SYSTEM VERIFICATION.....	17
9 MEASUREMENT PROCEDURES	18
9.1 TESTS TO BE PERFORMED	18
9.2 GENERAL MEASUREMENT PROCEDURE.....	19
9.3 WCDMA MEASUREMENT PROCEDURES FOR SAR	20
9.4 BLUETOOTH & WI-FI MEASUREMENT PROCEDURES FOR SAR	21
9.5 POWER DRIFT.....	21
10 AREA SCAN BASED 1-G SAR.....	22
10.1 REQUIREMENT OF KDB.....	22
10.2 FAST SAR ALGORITHMS	22
11 CONDUCTED OUTPUT POWER.....	23



11.1 MANUFACTURING TOLERANCE	23
11.2 GSM MEASUREMENT RESULT	25
11.3 WCDMA MEASUREMENT RESULT.....	26
11.4 WI-FI AND BT MEASUREMENT RESULT	26
12 SIMULTANEOUS TX SAR CONSIDERATIONS.....	28
12.1 INTRODUCTION.....	28
12.2 TRANSMIT ANTENNA SEPARATION DISTANCES	28
12.3 SAR MEASUREMENT POSITIONS	28
12.4 STANDALONE SAR TEST EXCLUSION CONSIDERATIONS	29
13 EVALUATION OF SIMULTANEOUS.....	30
14 SAR TEST RESULT	31
14.1 SAR RESULTS FOR FAST SAR.....	32
14.2 SAR RESULTS FOR STANDARD PROCEDURE	36
14.3 WLAN EVALUATION	38
15 SAR MEASUREMENT VARIABILITY.....	40
16 MEASUREMENT UNCERTAINTY	41
16.1 MEASUREMENT UNCERTAINTY FOR NORMAL SAR TESTS (300MHZ~3GHZ)	41
16.2 MEASUREMENT UNCERTAINTY FOR FAST SAR TESTS (300MHZ~3GHZ)	42
17 MAIN TEST INSTRUMENTS.....	44
ANNEX A GRAPH RESULTS.....	45
ANNEX B SYSTEM VERIFICATION RESULTS	65
ANNEX C SAR MEASUREMENT SETUP	72
ANNEX D POSITION OF THE WIRELESS DEVICE IN RELATION TO THE PHANTOM	78
ANNEX E EQUIVALENT MEDIA RECIPES	81
ANNEX F SYSTEM VALIDATION	82
ANNEX G PROBE CALIBRATION CERTIFICATE.....	83
ANNEX H DIPOLE CALIBRATION CERTIFICATE	94
ANNEX I ACCREDITATION CERTIFICATE.....	126

1 Test Laboratory

1.1 Testing Location

Company Name:	CTTL(Shouxiang)
Address:	No.51 Shouxiang Science Building, Xueyuan Road, Haidian District, Beijing,P.R.China100191

1.2 Testing Environment

Temperature:	18°C~25 °C,
Relative humidity:	30%~ 70%
Ground system resistance:	< 0.5 Ω
Ambient noise & Reflection:	< 0.012 W/kg

1.3 Project Data

Project Leader:	Qi Dianyuan
Test Engineer:	Lin Xiaojun
Testing Start Date:	September 06, 2015
Testing End Date:	September 10, 2015

1.4 Signature

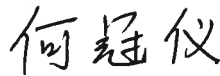

He Guanyi

(Prepared this test report)

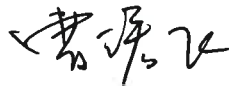

Cao Junfei

(Reviewed this test report)

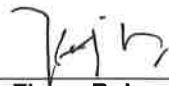

Zhang Bojun

Deputy Director of the laboratory

(Approved this test report)

2 Statement of Compliance

The maximum results of Specific Absorption Rate (SAR) found during testing for Shenzhen Sang Fei Consumer Communications Co.,Ltd WCMA/GSM digital mobile phone Philips S307 are as follows:

Table 2.1: Highest Reported SAR (1g)

Exposure Configuration	Technology Band	Highest Reported SAR 1g (W/Kg)	Equipment Class
Head (Separation Distance 0mm)	GSM 850	0.75	PCE
	PCS 1900	0.48	
	UMTS FDD 5	0.64	
	UMTS FDD 2	0.56	
	WLAN 2.4 GHz	0.47	DTS
Body-worn (Separation Distance 10mm)	GSM 850	1.06	PCE
	PCS 1900	0.37	
	UMTS FDD 5	1.21	
	UMTS FDD 2	0.79	
	WLAN 2.4 GHz	0.06	DTS

The SAR values found for the Mobile Phone are below the maximum recommended levels of 1.6 W/Kg as averaged over any 1g tissue according to the ANSI C95.1-1999.

For body worn operation, this device has been tested and meets FCC RF exposure guidelines when used with any accessory that contains no metal and which provides a minimum separation distance of 10 mm between this device and the body of the user. Use of other accessories may not ensure compliance with FCC RF exposure guidelines.

The EUT battery must be fully charged and checked periodically during the test to ascertain uniform power output.

The measurement together with the test system set-up is described in annex C of this test report. A detailed description of the equipment under test can be found in chapter 4 of this test report.

The highest reported SAR value is obtained at the case of **(Table 2.1)**, and the values are: **1.24W/kg (1g)**.

Table 2.2: The sum of reported SAR values for main antenna and WiFi

	Position	Main antenna	WiFi	Sum
Highest reported SAR value for Head	Left hand, Touch cheek	0.75	0.36	1.11
	Right hand, Touch cheek	0.38	0.47	0.85
Highest reported SAR value for Body	Rear	1.21	0.06	1.27

Table 2.3: The sum of reported SAR values for main antenna and Bluetooth

	Position	Main antenna	BT*	Sum
Highest reported SAR value for Head	Left hand, Touch cheek	0.75	0.08	0.83
	Right hand, Touch cheek	0.38	0.08	0.46
Highest reported SAR value for Body	Rear	1.21	0.04	1.25

BT* - Estimated SAR for Bluetooth (see the table 13.3)

According to the above tables, the highest sum of reported SAR values is **1.30 W/kg (1g)**. The detail for simultaneous transmission consideration is described in chapter 13.

3 Client Information

3.1 Applicant Information

Company Name:	Shenzhen Sang Fei Consumer Communications Co.,Ltd
Address /Post:	11 Science And Technology Road, shenzhen Hi-tech Industrial Park Nanshan District, Shenzhen 518057 PRC
Contact:	Sarah Shi
Email:	sarah.shi@sangfei.com
Telephone:	+86-755-36358392
Fax:	+86-755-26614979

3.2 Manufacturer Information

Company Name:	Shenzhen FortuneShip Technology Co., Ltd
Address /Post:	6-7th Floor, Kingson Building, New energy and innovation industrial park, Chuangsheng Road 1st , Xili town, Nanshan District, Shenzhe
Contact:	Jonas.Li
Email:	lizhong@fortuneship.com
Telephone:	+86-755 2639 7053
Fax:	+86 755 2639 7000

4 Equipment Under Test (EUT) and Ancillary Equipment (AE)

4.1 About EUT

Description:	WCMA/GSM digital mobile phone
Model Name:	Philips S307
Operating mode(s):	GSM 850/1900, WCDMA 850/1900, BT, Wi-Fi
Tested Tx Frequency:	825 – 848.8 MHz (GSM 850)
	1850.2 – 1910 MHz (GSM 1900)
	826.4–846.6 MHz (WCDMA850 Band V)
	1852.4–1907.6 MHz (WCDMA1900 Band II)
	2412 – 2462 MHz (Wi-Fi 2.4G)
GPRS&EGPRS Multislot Class:	12,Downlink only
GPRS capability Class:	12
WCDMA Category:	HSDPA: 14
	HSUPA: 7
Release Version:	GSM: R8
	GPRS: R8
Test device Production information:	Production unit
Device type:	Portable device
Antenna type:	Integrated antenna
Accessories/Body-worn configurations:	Headset
Hotspot mode:	Support simultaneous transmission of hotspot and voice(or data)
Form factor:	126 mm x 64 mm

4.2 Internal Identification of EUT used during the test

EUT ID*	SN or IMEI	HW Version	SW Version
EUT1	866636020007955	FS068-MB-V0.2	S307_T7731K_1534_V02A_MX
EUT2	866636020009258	FS068-MB-V0.2	S307_T7731K_1534_V02A_MX

*EUT ID: is used to identify the test sample in the lab internally.

Note: It is performed to test SAR with the EUT1 and conducted power with the EUT 2

4.3 Internal Identification of AE used during the test

AE ID*	Description	Model	SN	Manufacturer
AE1	Battery	AB1630DWMT	/	Zhongshan TIANMAO Battery Co., Ltd
AE2	Headset	S801	/	Shenzhen Jiayikang Technology Co., Ltd

*AE ID: is used to identify the test sample in the lab internally.



5 TEST METHODOLOGY

5.1 Applicable Limit Regulations

ANSI C95.1–1992: IEEE Standard for Safety Levels with Respect to Human Exposure to Radio Frequency Electromagnetic Fields, 3 kHz to 300 GHz.

It specifies the maximum exposure limit of **1.6 W/kg** as averaged over any 1 gram of tissue for portable devices being used within 20 cm of the user in the uncontrolled environment.

5.2 Applicable Measurement Standards

IEEE 1528–2013: Recommended Practice for Determining the Peak Spatial-Average Specific Absorption Rate (SAR) in the Human Head from Wireless Communications Devices: Experimental Techniques.

KDB 447498 D01: General RF Exposure Guidance v05r02: Mobile and Portable Devices RF Exposure Procedures and Equipment Authorization Policies.

KDB 648474 D04 Handset SAR v01r02: SAR Evaluation Considerations for Wireless Handsets.

KDB 941225 D06 Hotspot Mode SAR v01r01: SAR Evaluation Procedures for Portable Devices with Wireless Router Capabilities

KDB 248227 D01 802.11 Wi-Fi SAR v02r01: SAR Guidance for IEEE 802.11 (Wi-Fi) Transmitters.

KDB 865664 D01 SAR measurement 100 MHz to 6 GHz v01r03: SAR Measurement Requirements for 100 MHz to 6 GHz.

KDB 865664 D02 RF Exposure Reporting v01r01: RF Exposure Compliance Reporting and Documentation Considerations

6 Specific Absorption Rate (SAR)

6.1 Introduction

SAR is related to the rate at which energy is absorbed per unit mass in an object exposed to a radio field. The SAR distribution in a biological body is complicated and is usually carried out by experimental techniques or numerical modeling. The standard recommends limits for two tiers of groups, occupational/controlled and general population/uncontrolled, based on a person's awareness and ability to exercise control over his or her exposure. In general, occupational/controlled exposure limits are higher than the limits for general population/uncontrolled.

6.2 SAR Definition

The SAR definition is the time derivative (rate) of the incremental energy (dW) absorbed by (dissipated in) an incremental mass (dm) contained in a volume element (dv) of a given density (ρ). The equation description is as below:

$$SAR = \frac{d}{dt} \left(\frac{dW}{dm} \right) = \frac{d}{dt} \left(\frac{dW}{\rho dv} \right)$$

SAR is expressed in units of Watts per kilogram (W/kg)

SAR measurement can be either related to the temperature elevation in tissue by

$$SAR = c \left(\frac{\delta T}{\delta t} \right)$$

Where: C is the specific heat capacity, δT is the temperature rise and δt is the exposure duration, or related to the electrical field in the tissue by

$$SAR = \frac{\sigma |E|^2}{\rho}$$

Where: σ is the conductivity of the tissue, ρ is the mass density of tissue and E is the RMS electrical field strength.

However for evaluating SAR of low power transmitter, electrical field measurement is typically applied.

7 Tissue Simulating Liquids

7.1 Targets for tissue simulating liquid

Table 7.1: Targets for tissue simulating liquid

Frequency (MHz)	Liquid Type	Permittivity (ϵ)	$\pm 5\%$ Range	Conductivity (σ)	$\pm 5\%$ Range
835	Head	41.5	39.4~43.6	0.90	0.86~0.95
835	Body	55.2	52.4~58.0	0.97	0.92~1.02
1800	Head	40.0	38.0~42.0	1.40	1.33~1.47
1800	Body	53.3	50.6~56.0	1.52	1.44~1.60
1900	Head	40.0	38.0~42.0	1.40	1.33~1.47
1900	Body	53.3	50.6~56.0	1.52	1.44~1.60
2450	Head	39.2	37.2~41.2	1.80	1.71~1.89
2450	Body	52.7	50.1~55.3	1.95	1.85~2.05

7.2 Dielectric Performance

Table 7.2: Dielectric Performance of Tissue Simulating Liquid

Measurement Date (yyyy-mm-dd)	Type	Frequency	Permittivity ϵ	Drift (%)	Conductivity σ (S/m)	Drift (%)
2015-9-6	Head	835 MHz	41.32	-0.43	0.93	3.33
2015-9-8	Body	835 MHz	53.50	-3.08	0.97	0.00
2015-9-6	Head	1900 MHz	40.85	2.13	1.39	-0.71
2015-9-7	Body	1900 MHz	50.79	-4.71	1.54	1.32
2015-9-10	Head	2450 MHz	38.27	-2.37	1.85	2.78
2015-9-10	Body	2450 MHz	51.28	-2.69	1.98	1.54

Note: The liquid temperature is 22.0 °C

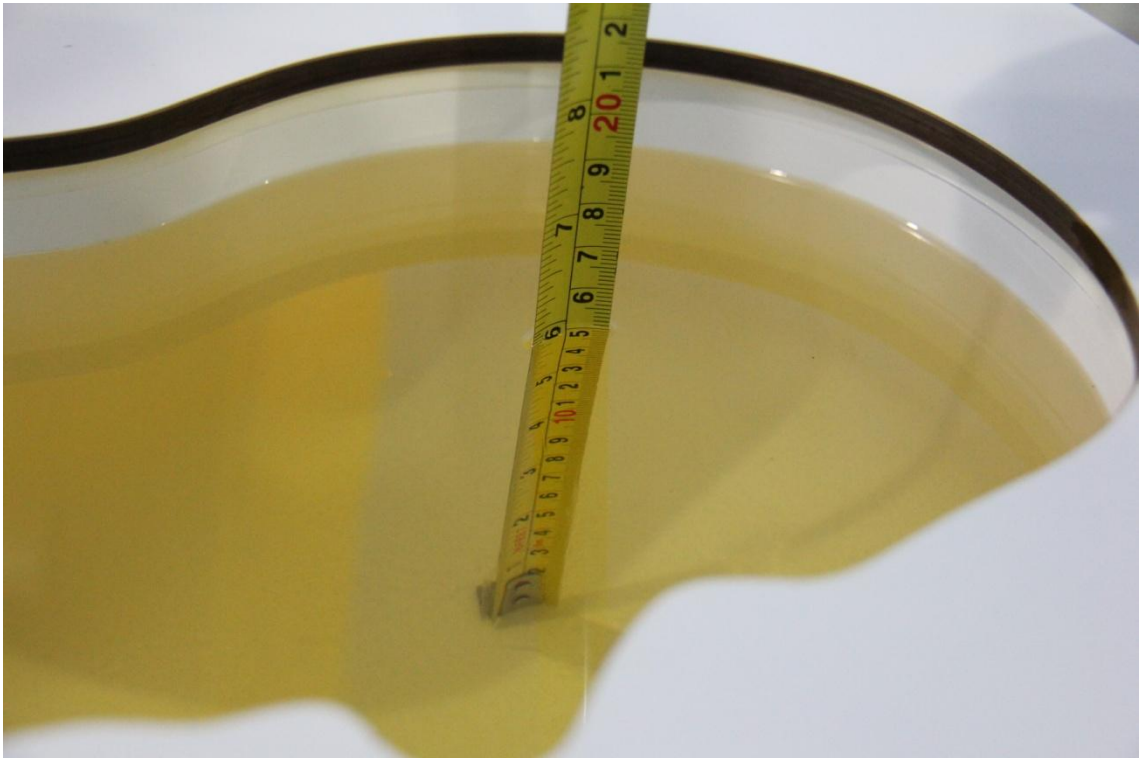

Picture 7-1: Liquid depth in the Head Phantom (835 MHz)

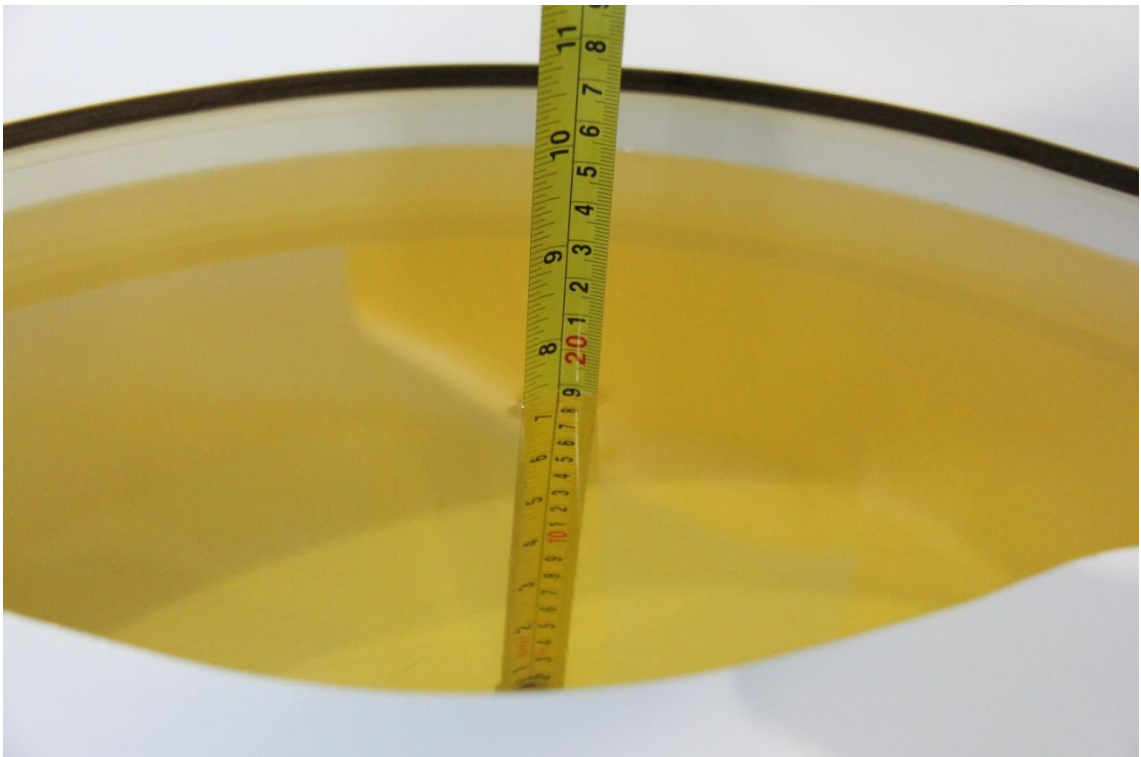

Picture 7-2: Liquid depth in the Flat Phantom (835 MHz)

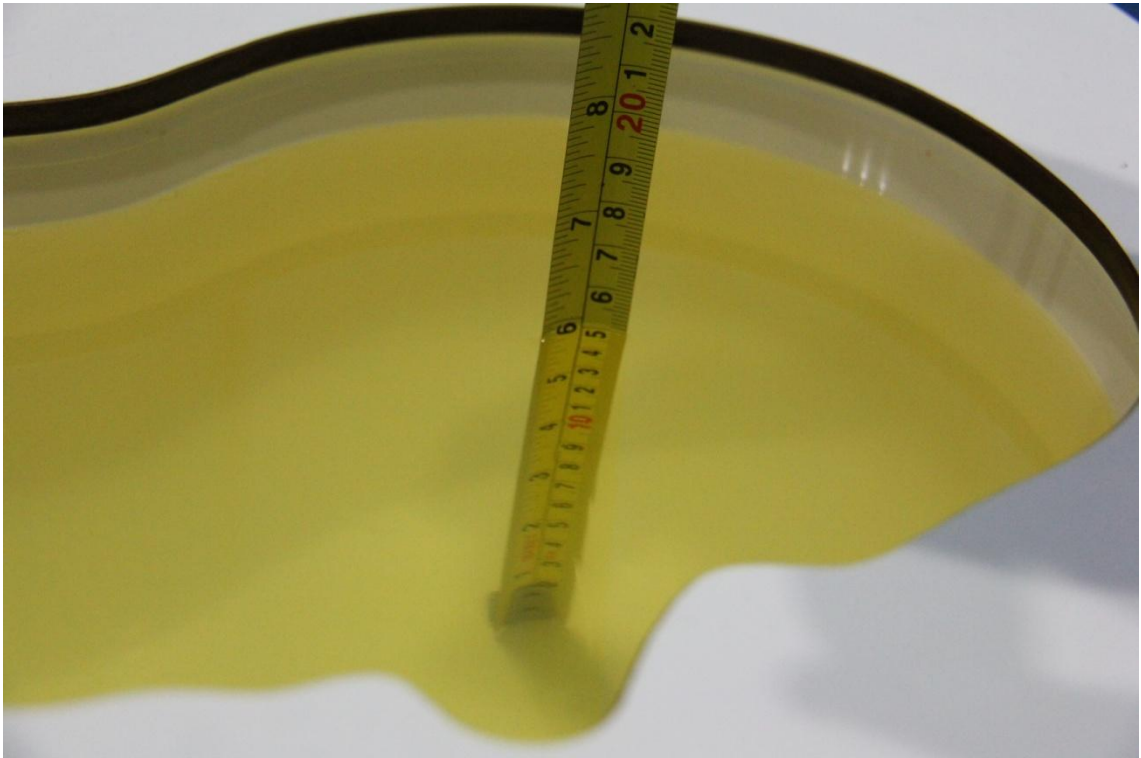

Picture 7-3: Liquid depth in the Head Phantom (1900 MHz)

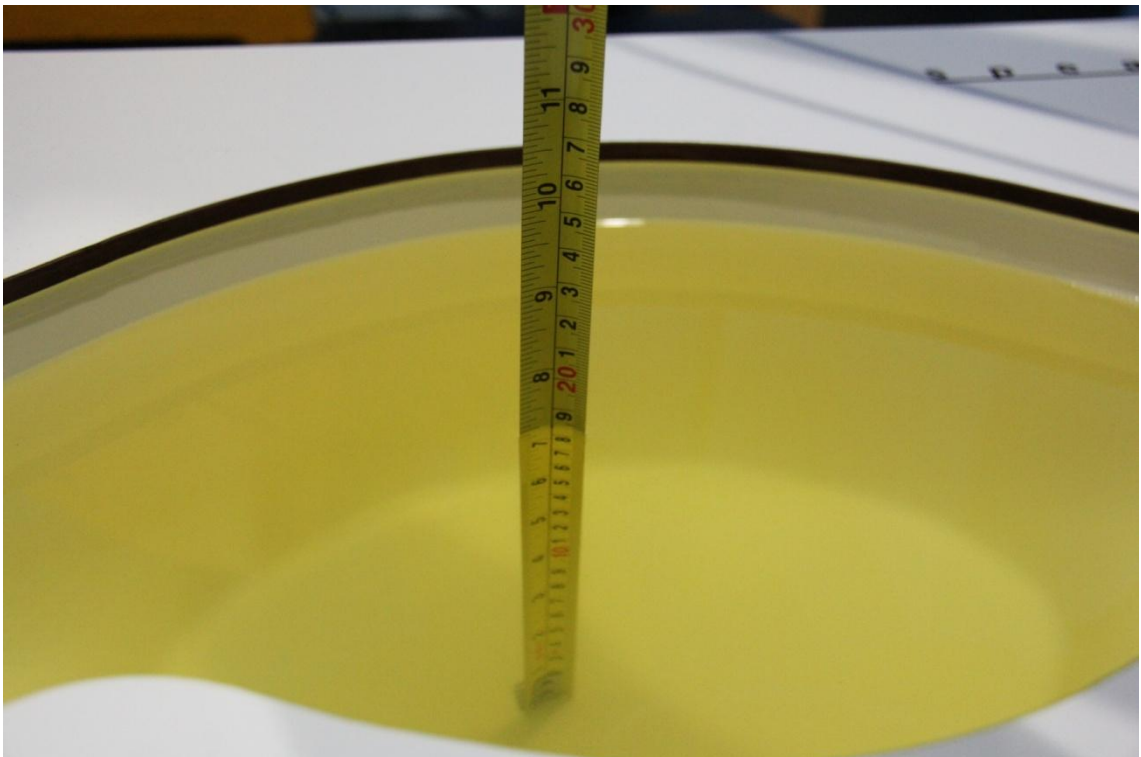

Picture 7-4 Liquid depth in the Flat Phantom (1900MHz)

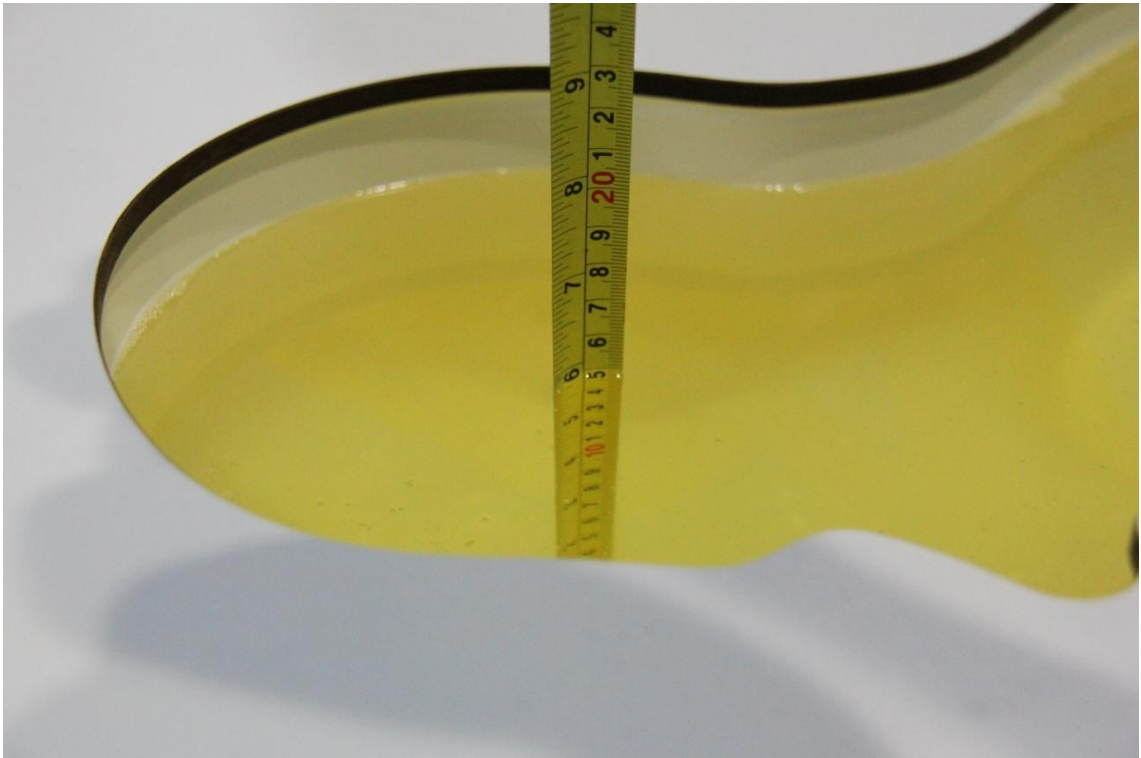

Picture 7-5 Liquid depth in the Head Phantom (2450MHz)

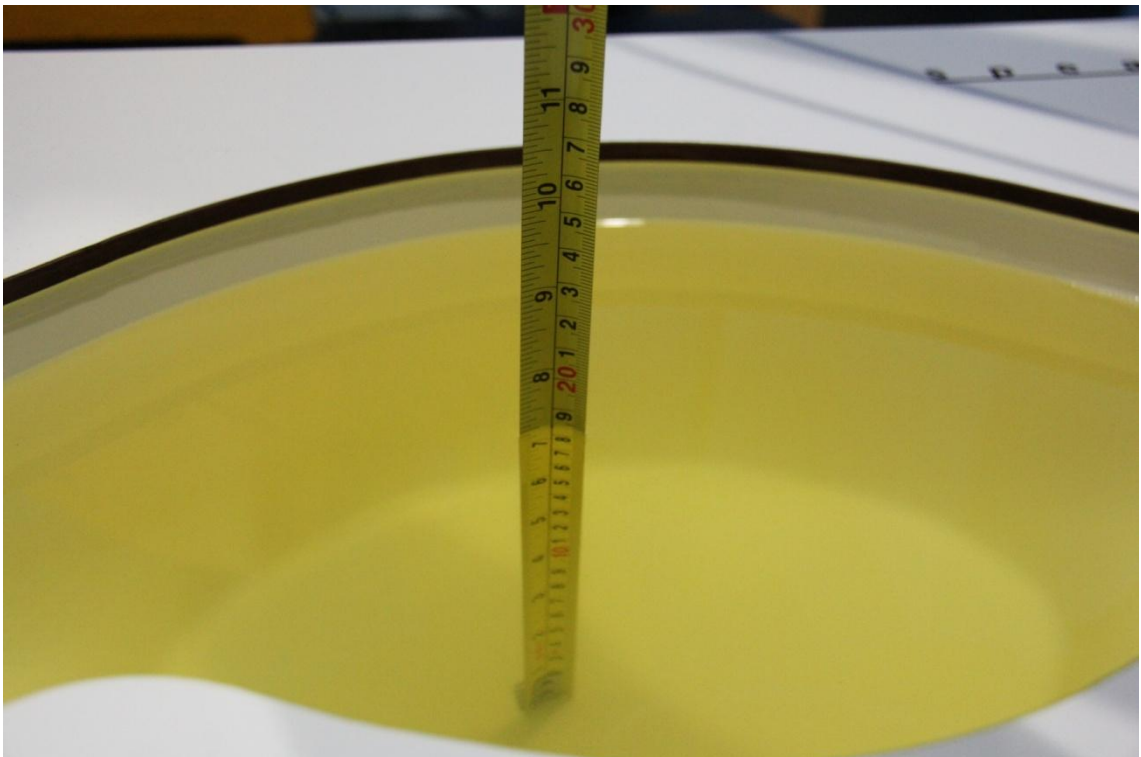

Picture 7-6 Liquid depth in the Flat Phantom (2450MHz)

8 System verification

8.1 System Setup

In the simplified setup for system evaluation, the DUT is replaced by a calibrated dipole and the power source is replaced by a continuous wave that comes from a signal generator. The calibrated dipole must be placed beneath the flat phantom section of the SAM twin phantom with the correct distance holder. The distance holder should touch the phantom surface with a light pressure at the reference marking and be oriented parallel to the long side of the phantom. The equipment setup is shown below:

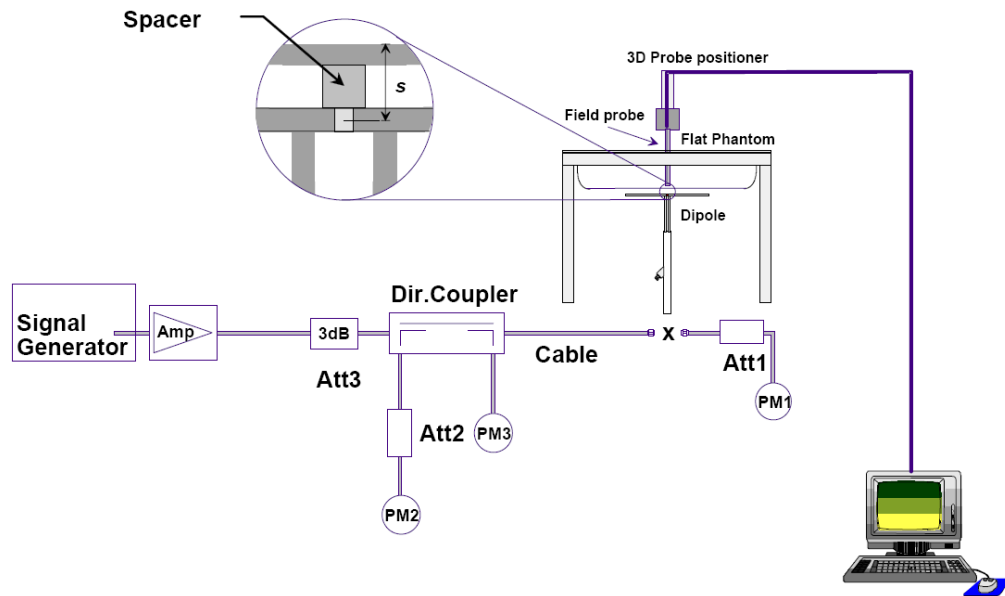

Picture 8.1 System Setup for System Evaluation

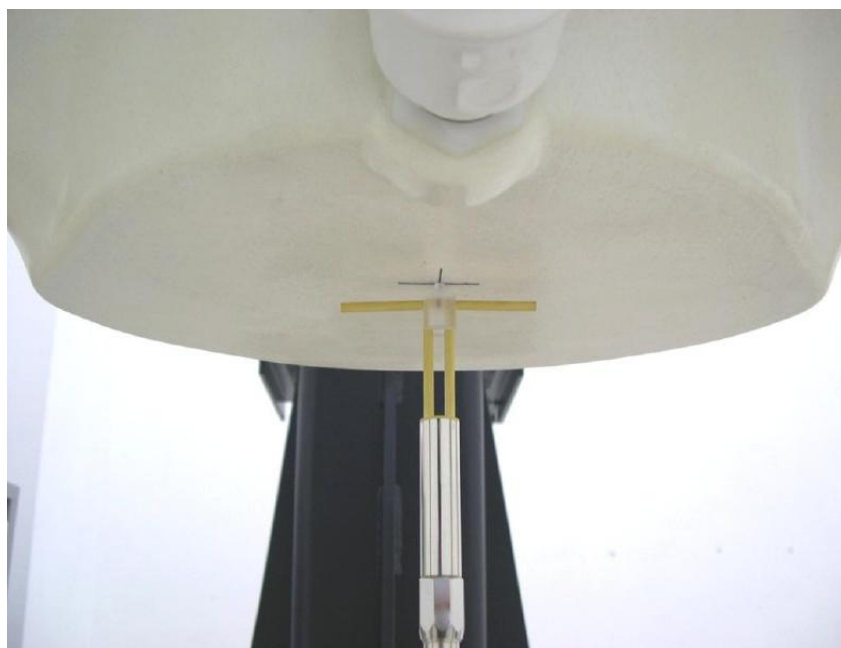

Picture 8.2 Photo of Dipole Setup

8.2 System Verification

SAR system verification is required to confirm measurement accuracy, according to the tissue dielectric media, probe calibration points and other system operating parameters required for measuring the SAR of a test device. The system verification must be performed for each frequency band and within the valid range of each probe calibration point required for testing the device.

The system verification results are required that the area scan estimated 1-g SAR is within 3% of the zoom scan 1-g SAR. The details are presented in annex B.

Table 8.1: System Verification of Head

Measurement Date (yyyy-mm-dd)	Frequency	Target value (W/kg)		Measured value (W/kg)		Deviation	
		10 g Average	1 g Average	10 g Average	1 g Average	10 g Average	1 g Average
2015-9-6	835 MHz	6.2	9.5	6.2	9.76	0.00%	2.74%
2015-9-6	1900 MHz	20.9	40.5	20.4	40.64	-2.39%	0.35%
2015-9-10	2450 MHz	25.3	53.7	25.04	55.12	-1.03%	2.64%

Table 8.2: System Verification of Body

Measurement Date (yyyy-mm-dd)	Frequency	Target value (W/kg)		Measured value (W/kg)		Deviation	
		10 g Average	1 g Average	10 g Average	1 g Average	10 g Average	1 g Average
2015-9-8	835 MHz	6.4	9.5	6.32	9.84	-1.25%	3.58%
2015-9-7	1900 MHz	21.5	41.1	22.16	41.2	3.07%	0.24%
2015-9-10	2450 MHz	24.5	52.0	25.2	53.92	2.86%	3.69%

9 Measurement Procedures

9.1 Tests to be performed

In order to determine the highest value of the peak spatial-average SAR of a handset, all device positions, configurations and operational modes shall be tested for each frequency band according to steps 1 to 3 below. A flowchart of the test process is shown in picture 9.1.

Step 1: The tests described in 9.2 shall be performed at the channel that is closest to the centre of the transmit frequency band (f_c) for:

- a) all device positions (cheek and tilt, for both left and right sides of the SAM phantom, as described in annex D),
- b) all configurations for each device position in a), e.g., antenna extended and retracted, and
- c) all operational modes, e.g., analogue and digital, for each device position in a) and configuration in b) in each frequency band.

If more than three frequencies need to be tested according to 11.1 (i.e., $N_c > 3$), then all frequencies, configurations and modes shall be tested for all of the above test conditions.

Step 2: For the condition providing highest peak spatial-average SAR determined in Step 1, perform all tests described in 9.2 at all other test frequencies, i.e., lowest and highest frequencies. In addition, for all other conditions (device position, configuration and operational mode) where the peak spatial-average SAR value determined in Step 1 is within 3 dB of the applicable SAR limit, it is recommended that all other test frequencies shall be tested as well.

Step 3: Examine all data to determine the highest value of the peak spatial-average SAR found in Steps 1 to 2.

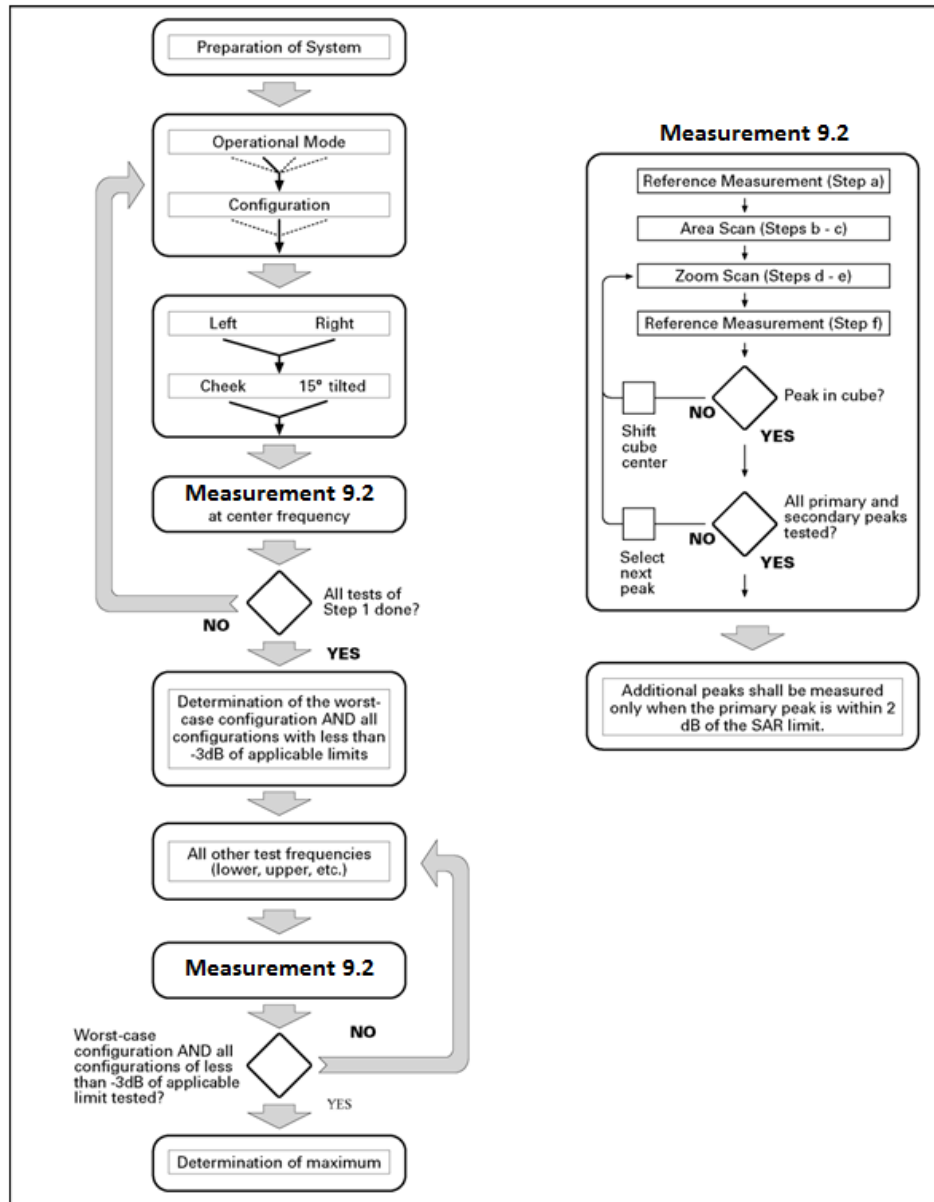

Picture 9.1 Block diagram of the tests to be performed

9.2 General Measurement Procedure

The area and zoom scan resolutions specified in the table below must be applied to the SAR measurements and fully documented in SAR reports to qualify for TCB approval. Probe boundary effect error compensation is required for measurements with the probe tip closer than half a probe tip diameter to the phantom surface. Both the probe tip diameter and sensor offset distance must satisfy measurement protocols; to ensure probe boundary effect errors are minimized and the higher fields closest to the phantom surface can be correctly measured and extrapolated to the phantom surface for computing 1-g SAR. Tolerances of the post-processing algorithms must be verified by the test laboratory for the scan resolutions used in the SAR measurements, according to the reference distribution functions specified in IEEE Std 1528-2003. The results should be documented as part of the system validation records and may be requested to support test results

when all the measurement parameters in the following table are not satisfied.

		≤ 3 GHz	> 3 GHz
Maximum distance from closest measurement point (geometric center of probe sensors) to phantom surface		5 ± 1 mm	$\frac{1}{2} \delta \ln(2) \pm 0.5$ mm
Maximum probe angle from probe axis to phantom surface normal at the measurement location		$30^\circ \pm 1^\circ$	$20^\circ \pm 1^\circ$
Maximum area scan spatial resolution: $\Delta x_{Area}, \Delta y_{Area}$		≤ 2 GHz: ≤ 15 mm 2 – 3 GHz: ≤ 12 mm	3 – 4 GHz: ≤ 12 mm 4 – 6 GHz: ≤ 10 mm
		When the x or y dimension of the test device, in the measurement plane orientation, is smaller than the above, the measurement resolution must be \leq the corresponding x or y dimension of the test device with at least one measurement point on the test device.	
Maximum zoom scan spatial resolution: $\Delta x_{Zoom}, \Delta y_{Zoom}$		≤ 2 GHz: ≤ 8 mm 2 – 3 GHz: ≤ 5 mm*	3 – 4 GHz: ≤ 5 mm* 4 – 6 GHz: ≤ 4 mm*
Maximum zoom scan spatial resolution, normal to phantom surface	uniform grid: $\Delta z_{Zoom}(n)$	≤ 5 mm	3 – 4 GHz: ≤ 4 mm 4 – 5 GHz: ≤ 3 mm 5 – 6 GHz: ≤ 2 mm
	graded grid $\Delta z_{Zoom}(1)$: between 1 st two points closest to phantom surface	≤ 4 mm	3 – 4 GHz: ≤ 3 mm 4 – 5 GHz: ≤ 2.5 mm 5 – 6 GHz: ≤ 2 mm
	$\Delta z_{Zoom}(n>1)$: between subsequent points	$\leq 1.5 \cdot \Delta z_{Zoom}(n-1)$	
Minimum zoom scan volume	x, y, z	≥ 30 mm	3 – 4 GHz: ≥ 28 mm 4 – 5 GHz: ≥ 25 mm 5 – 6 GHz: ≥ 22 mm
Note: δ is the penetration depth of a plane-wave at normal incidence to the tissue medium; see draft standard IEEE P1528-2011 for details. * When zoom scan is required and the <i>reported</i> SAR from the area scan based <i>I-g SAR estimation</i> procedures of KDB 447498 is ≤ 1.4 W/kg, ≤ 8 mm, ≤ 7 mm and ≤ 5 mm zoom scan resolution may be applied, respectively, for 2 GHz to 3 GHz, 3 GHz to 4 GHz and 4 GHz to 6 GHz.			

9.3 WCDMA Measurement Procedures for SAR

The following procedures are applicable to WCDMA handsets operating under 3GPP Release99, Release 5 and Release 6. The default test configuration is to measure SAR with an established radio link between the DUT and a communication test set using a 12.2kbps RMC (reference measurement channel) configured in Test Loop Mode 1. SAR is selectively confirmed for other physical channel configurations (DPCCH & DPDCH_n), HSDPA and HSPA (HSUPA/HSDPA) modes according to output power, exposure conditions and device operating capabilities. Both uplink and downlink should be configured with the same RMC or AMR, when required. SAR for Release 5 HSDPA and Release 6 HSPA are measured using the applicable FRC (fixed reference channel) and E-DCH reference channel configurations. Maximum output power is verified according to applicable versions of 3GPP TS 34.121 and SAR must be measured according to these maximum output conditions. When Maximum Power Reduction (MPR) is not implemented according to Cubic Metric (CM) requirements for Release 6 HSPA, the following procedures do not apply.

For Release 5 HSDPA Data Devices:

Sub-test	β_c	β_d	β_d (SF)	β_c/β_d	β_{hs}	CM/dB
1	2/15	15/15	64	2/15	4/15	0.0
2	12/15	15/15	64	12/15	24/25	1.0
3	15/15	8/15	64	15/8	30/15	1.5
4	15/15	4/15	64	15/4	30/15	1.5

For Release 6 HSPA Data Devices

Sub-test	β_c	β_d	β_d (SF)	β_c/β_d	β_{hs}	β_{ec}	β_{ed}	β_{ed} (SF)	β_{ed} (codes)	CM (dB)	MPR (dB)	AG Index	E-TFCI
1	11/15	15/15	64	11/15	22/15	209/225	1039/225	4	1	1.0	0.0	20	75
2	6/15	15/15	64	6/15	12/15	12/15	12/15	4	1	3.0	2.0	12	67
3	15/15	9/15	64	15/9	30/15	30/15	$\beta_{ed1}:47/15$ $\beta_{ed2}:47/15$	4	2	2.0	1.0	15	92
4	2/15	15/15	64	2/15	4/15	4/15	56/75	4	1	3.0	2.0	17	71
5	15/15	15/15	64	15/15	24/15	30/15	134/15	4	1	1.0	0.0	21	81

9.4 Bluetooth & Wi-Fi Measurement Procedures for SAR

Normal network operating configurations are not suitable for measuring the SAR of 802.11 transmitters in general. Unpredictable fluctuations in network traffic and antenna diversity conditions can introduce undesirable variations in SAR results. The SAR for these devices should be measured using chipset based test mode software to ensure that the results are consistent and reliable.

Chipset based test mode software is hardware dependent and generally varies among manufacturers. The device operating parameters established in a test mode for SAR measurements must be identical to those programmed in production units, including output power levels, amplifier gain settings and other RF performance tuning parameters. The test frequencies should correspond to actual channel frequencies defined for domestic use. SAR for devices with switched diversity should be measured with only one antenna transmitting at a time during each SAR measurement, according to a fixed modulation and data rate. The same data pattern should be used for all measurements.

9.5 Power Drift

To control the output power stability during the SAR test, DASY4 system calculates the power drift by measuring the E-field at the same location at the beginning and at the end of the measurement for each test position. These drift values can be found in Table 14.2 to Table 14.25 labeled as: (Power Drift [dB]). This ensures that the power drift during one measurement is within 5%.

10 Area Scan Based 1-g SAR

10.1 Requirement of KDB

According to the KDB447498 D01 v05, when the implementation is based the specific polynomial fit algorithm as presented at the 29th Bioelectromagnetics Society meeting (2007) and the estimated 1-g SAR is ≤ 1.2 W/kg, a zoom scan measurement is not required provided it is also not needed for any other purpose; for example, if the peak SAR location required for simultaneous transmission SAR test exclusion can be determined accurately by the SAR system or manually to discriminate between distinctive peaks and scattered noisy SAR distributions from area scans.

There must not be any warning or alert messages due to various measurement concerns identified by the SAR system; for example, noise in measurements, peaks too close to scan boundary, peaks are too sharp, spatial resolution and uncertainty issues etc. The SAR system verification must also demonstrate that the area scan estimated 1-g SAR is within 3% of the zoom scan 1-g SAR (See Annex B). When all the SAR results for each exposure condition in a frequency band and wireless mode are based on estimated 1-g SAR, the 1-g SAR for the highest SAR configuration must be determined by a zoom scan.

10.2 Fast SAR Algorithms

The approach is based on the area scan measurement applying a frequency dependent attenuation parameter. This attenuation parameter was empirically determined by analyzing a large number of phones. The MOTOROLA FAST SAR was developed and validated by the MOTOROLA Research Group in Ft. Lauderdale.

In the initial study, an approximation algorithm based on Linear fit was developed. The accuracy of the algorithm has been demonstrated across a broad frequency range (136-2450 MHz) and for both 1- and 10-g averaged SAR using a sample of 264 SAR measurements from 55 wireless handsets. For the sample size studied, the root-mean-squared errors of the algorithm are 1.2% and 5.8% for 1- and 10-g averaged SAR, respectively. The paper describing the algorithm in detail is expected to be published in August 2004 within the Special Issue of Transactions on MTT.

In the second step, the same research group optimized the fitting algorithm to an Polynomial fit whereby the frequency validity was extended to cover the range 30-6000MHz. Details of this study can be found in the BEMS 2007 Proceedings.

Both algorithms are implemented in DASYS software.

11 Conducted Output Power

11.1 Manufacturing tolerance

Table 11.1: GSM Speech

GSM 850			
Channel	Channel 251	Channel 190	Channel 128
Target (dBm)	32	32	32
Tolerance \pm (dB)	1	1	1
GSM 1900			
Channel	Channel 810	Channel 661	Channel 512
Target (dBm)	29	29	29
Tolerance \pm (dB)	1	1	1

Table 11.2: GPRS and EGPRS

GSM 850 GPRS&EGPRS (GMSK)				
Channel		251	190	128
1 Txslot	Target (dBm)	32	32	32
	Tolerance \pm (dB)	1	1	1
2 Txslots	Target (dBm)	30	30	30
	Tolerance \pm (dB)	1	1	1
3Txslots	Target (dBm)	28	28	28
	Tolerance \pm (dB)	1	1	1
4 Txslots	Target (dBm)	26	26	26
	Tolerance \pm (dB)	1	1	1
GSM 1900 GPRS&EGPRS (GMSK)				
Channel		810	661	512
1 Txslot	Target (dBm)	28	28	28
	Tolerance \pm (dB)	1	1	1
2 Txslots	Target (dBm)	26	26	26
	Tolerance \pm (dB)	1	1	1
3Txslots	Target (dBm)	24.5	24.5	24.5
	Tolerance \pm (dB)	1	1	1
4 Txslots	Target (dBm)	22.5	22.5	22.5
	Tolerance \pm (dB)	1	1	1

Table 11.3: WCDMA

UMTS Band V		Conducted Power (dBm)		
		Channel 4233	Channel 4183	Channel 4132
CS	Target (dBm)	22	22	22
	Tolerance \pm (dB)	1	1	1
HSUPA sub-test 1	Target (dBm)	19	19	19
	Tolerance \pm (dB)	1	1	1
HSUPA sub-test 2	Target (dBm)	17	17	17
	Tolerance \pm (dB)	1	1	1
HSUPA sub-test 3-4	Target (dBm)	18.5	18.5	18.5
	Tolerance \pm (dB)	1	1	1
HSUPA sub-test 5	Target (dBm)	19.5	19.5	19.5
	Tolerance \pm (dB)	1	1	1
HSDPA sub-test 1-4	Target (dBm)	22	22	23
	Tolerance \pm (dB)	1	1	1
UMTS Band II		Conducted Power (dBm)		
		Channel 9538	Channel 9400	Channel 9262
CS	Target (dBm)	23	23	23
	Tolerance \pm (dB)	0.5	0.5	0.5
HSUPA sub-test 1	Target (dBm)	19	19	19
	Tolerance \pm (dB)	1	1	1
HSUPA sub-test 2	Target (dBm)	17	17	17
	Tolerance \pm (dB)	1	1	1
HSUPA sub-test 3-4	Target (dBm)	18.5	18.5	18.5
	Tolerance \pm (dB)	1	1	1
HSUPA sub-test 5	Target (dBm)	19.5	19.5	19.5
	Tolerance \pm (dB)	1	1	1
HSDPA sub-test 1-4	Target (dBm)	22	22	22
	Tolerance \pm (dB)	1	1	1

Table 11.4: Bluetooth

Mode	Target (dBm)	Tolerance \pm (dB)
GFSK	0	1
EDR2M-4_DQPSK	1.5	1
EDR3M-8DPSK	2	1

Table 11.5: WiFi

Mode	Channel/Data rate	Target (dBm)	Tolerance \pm (dB)
802.11 b (2.4GHz)	/	12.5	1
802.11 g (2.4GHz)	6-18Mbps	12	1
	24-36Mbps	11.5	1
	48-54Mbps	11	1
802.11 n (2.4GHz HT20)	MCS0-2	9	1
	MCS3-7	8	1

11.2 GSM Measurement result

During the process of testing, the EUT was controlled via Agilent Digital Radio Communication tester (E5515C) to ensure the maximum power transmission and proper modulation. This result contains conducted output power for the EUT. In all cases, the measured peak output power should be greater and within 5% than EMI measurement.

Table 11.6: The conducted power measurement results for GSM850/1900

GSM 850MHz	Conducted Power (dBm)		
	Channel 251(848.8MHz)	Channel 190(836.6MHz)	Channel 128(824.2MHz)
	32.12	32.02	31.91
GSM 1900MHz	Conducted Power (dBm)		
	Channel 810(1909.8MHz)	Channel 661(1880MHz)	Channel 512(1850.2MHz)
	28.67	28.38	28.84

Table 11.7: The conducted power measurement results for GPRS and EGPRS

GSM850		MeasuredPower(dBm)			calculation	AveragedPower(dBm)		
		251	190	128		251	190	128
GPRS (GMSK)	1Txslot	32.12	32.02	31.91	-9.03dB	23.09	22.99	22.88
	2Txslots	30.43	30.31	30.20	-6.02dB	24.41	24.29	24.18
	3Txslots	28.60	28.50	28.40	-4.26dB	24.34	24.24	24.14
	4Txslots	26.58	26.50	26.44	-3.01dB	23.57	23.49	23.43
EGPRS (GMSK)	1Txslot	32.10	32.01	31.90	-9.03dB	23.07	22.98	22.87
	2Txslots	30.41	30.31	30.18	-6.02dB	24.39	24.29	24.16
	3Txslots	28.57	28.49	28.40	-4.26dB	24.31	24.23	24.14
	4Txslots	26.57	26.50	26.43	-3.01dB	23.56	23.49	23.42
PCS1900		MeasuredPower(dBm)			calculation	AveragedPower(dBm)		
		810	661	512		810	661	512
GPRS (GMSK)	1Txslot	28.67	28.38	28.84	-9.03dB	19.64	19.35	19.81
	2Txslots	26.72	26.40	26.34	-6.02dB	20.70	20.38	20.32
	3Txslots	25.18	24.87	24.77	-4.26dB	20.92	20.61	20.51
	4Txslots	23.06	22.70	22.65	-3.01dB	20.05	19.69	19.64
EGPRS (GMSK)	1Txslot	28.66	28.36	28.83	-9.03dB	19.63	19.33	19.80
	2Txslots	26.70	26.39	26.32	-6.02dB	20.68	20.37	20.30
	3Txslots	25.16	24.85	24.75	-4.26dB	20.90	20.59	20.49
	4Txslots	23.05	22.70	22.63	-3.01dB	20.04	19.69	19.62

NOTES:

1) Division Factors

To average the power, the division factor is as follows:

1TX-slot = 1 transmit time slot out of 8 time slots=> conducted power divided by (8/1) => -9.03dB

2TX-slots = 2 transmit time slots out of 8 time slots=> conducted power divided by (8/2) => -6.02dB

3TX-slots = 3 transmit time slots out of 8 time slots=> conducted power divided by (8/3) => -4.26dB

4TX-slots = 4 transmit time slots out of 8 time slots=> conducted power divided by (8/4) => -3.01dB

According to the conducted power as above, the body measurements are performed with 2Txslots for GSM 850 and 3Txslots for GSM 1900.

11.3 WCDMA Measurement result

Table 11.8: The conducted Power for WCDMA850/1900

UMTS Band V		Conducted Power (dBm)		
		Ch 4233 (846.6MHz)	Ch 4183 (836.6MHz)	Ch 4132 (826.6MHz)
RMC	12.2kbps RMC	23.20	23.20	23.11
HSUPA	Sub - Test 1	19.7	19.8	19.5
	Sub - Test 2	17.7	17.9	17.5
	Sub - Test 3	19.0	19.2	18.9
	Sub - Test 4	18.6	18.7	18.4
	Sub - Test 5	20.0	20.3	20.1
HSDPA	Sub - Test 1	22.3	22.4	22.1
	Sub - Test 2	22.5	22.4	22.3
	Sub - Test 3	22.6	22.5	22.5
	Sub - Test 4	22.5	22.5	22.5
UMTS Band II		Conducted Power (dBm)		
		Ch 9538 (1907.6MHz)	Ch 9400 (1880MHz)	Ch 9262 (1852.4MHz)
RMC	12.2kbps RMC	22.3	22.3	22.4
HSUPA	Sub - Test 1	19.6	19.5	19.7
	Sub - Test 2	17.7	17.6	17.8
	Sub - Test 3	18.9	18.9	19.0
	Sub - Test 4	18.4	18.4	18.5
	Sub - Test 5	20.1	20.1	20.1
HSDPA	Sub - Test 1	22.0	22.0	22.1
	Sub - Test 2	21.7	22.0	22.0
	Sub - Test 3	21.7	22.0	21.9
	Sub - Test 4	21.6	22.0	21.9

11.4 Wi-Fi and BT Measurement result

The output power of BT antenna is as following:

Mode	Conducted Power (dBm)		
	Channel 0 (2402MHz)	Channel 39 (2441MHz)	Channel 78 (2480MHz)
GFSK	0.16	0.49	0.10
EDR2M-4_DQPSK	1.22	1.26	2.03
EDR3M-8DPSK	1.67	1.96	2.56



The average conducted power for Wi-Fi is as following:

802.11b (dBm)

Channel\data rate	1Mbps	2Mbps	5.5Mbps	11Mbps
1(2412MHz)	12.26	12.24	12.2	12.21
6(2437MHz)	12.69	12.37	12.24	12.23
11(2462MHz)	13.07	12.84	12.78	11.80

802.11g (dBm)

Channel\data rate	6Mbps	9Mbps	12Mbps	18Mbps	24Mbps	36Mbps	48Mbps	54Mbps
1(2412MHz)	12.02	11.98	12.07	12.1	11.6	11.52	11.52	11.39
6(2437MHz)	12.44	12.42	12.51	12.05	11.91	11.86	11.76	11.76
11(2462Mz)	12.41	12.3	12.42	12.49	12	11.9	11.92	11.85

802.11n (dBm) - HT20 (2.4G)

Channel\data rate	MCS0	MCS1	MCS2	MCS3	MCS4	MCS5	MCS6	MCS7
1(2412MHz)	8.86	8.76	8.92	8.46	8.43	8.51	8.51	8.12
6(2437MHz)	9.11	9.05	9.25	8.74	8.60	8.64	8.62	8.21
11(2462MHz)	9.22	9.21	9.39	8.87	8.75	8.85	8.83	8.47

12 Simultaneous TX SAR Considerations

12.1 Introduction

The following procedures adopted from “FCC SAR Considerations for Cell Phones with Multiple Transmitters” are applicable to handsets with built-in unlicensed transmitters such as 802.11 a/b/g and Bluetooth devices which may simultaneously transmit with the licensed transmitter.

For this device, the BT and Wi-Fi can transmit simultaneous with other transmitters.

12.2 Transmit Antenna Separation Distances

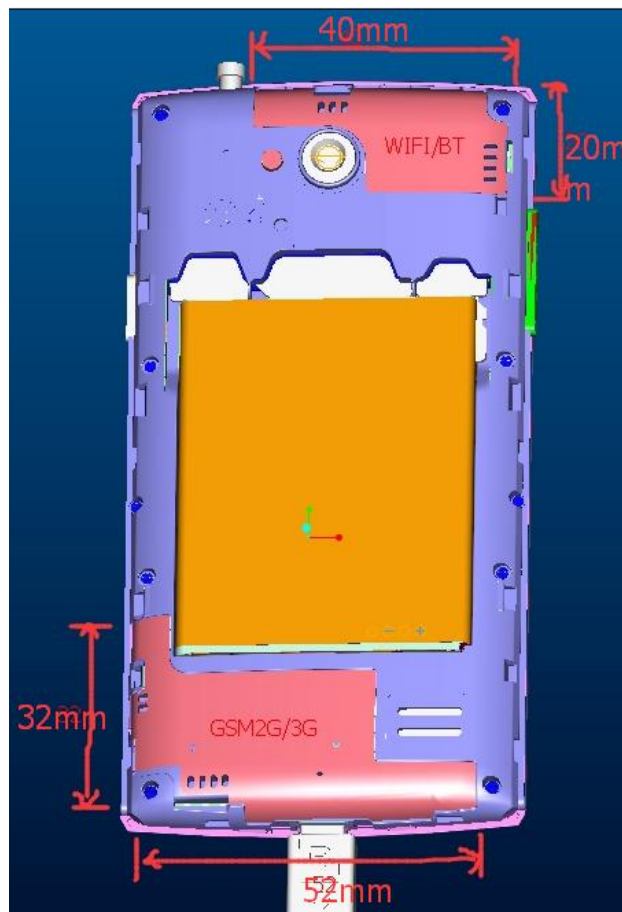

Picture 12.1 Antenna Locations

12.3 SAR Measurement Positions

According to the KDB941225 D06 Hot Spot SAR v01, the edges with less than 2.5 cm distance to the antennas need to be tested for SAR.

SAR measurement positions						
Mode	Front	Rear	Left edge	Right edge	Top edge	Bottom edge
Main antenna	Yes	Yes	Yes	Yes	No	Yes
WLAN	Yes	Yes	Yes	Yes	Yes	No

12.4 Standalone SAR Test Exclusion Considerations

Standalone 1-g head or body SAR evaluation by measurement or numerical simulation is not required when the corresponding SAR Exclusion Threshold condition, listed below, is satisfied. The 1-g SAR test exclusion threshold for 100 MHz to 6 GHz at test separation distances ≤ 50 mm are determined by:

$[(\text{max. power of channel, including tune-up tolerance, mW}) / (\text{min. test separation distance, mm})] \cdot [\sqrt{f(\text{GHz})}] \leq 3.0$ for 1-g SAR, where

- $f(\text{GHz})$ is the RF channel transmit frequency in GHz
- Power and distance are rounded to the nearest mW and mm before calculation
- The result is rounded to one decimal place for comparison

Table 12.1: Standalone SAR test exclusion considerations

Band/Mode	F(GHz)	Position	SAR test exclusion threshold (mW)	RF output power		SAR test exclusion
				dBm	mW	
Bluetooth	2.441	Head	9.60	3	2.00	Yes
		Body	19.20	3	2.00	Yes
2.4GHz WLAN 802.11 b	2.45	Head	9.58	13.5	22.39	No
		Body	19.17	13.5	22.39	No

13 Evaluation of Simultaneous

Table 13.1: The sum of reported SAR values for main antenna and WiFi

	Position	Main antenna	WiFi	Sum
Highest reported SAR value for Head	Left hand, Touch cheek	0.75	0.36	1.11
	Right hand, Touch cheek	0.38	0.47	0.85
Highest reported SAR value for Body	Rear	1.21	0.06	1.27

Table 13.2: The sum of reported SAR values for main antenna and Bluetooth

	Position	Main antenna	BT*	Sum
Highest reported SAR value for Head	Left hand, Touch cheek	0.75	0.08	0.83
	Right hand, Touch cheek	0.38	0.08	0.46
Highest reported SAR value for Body	Rear	1.21	0.04	1.25

BT* - Estimated SAR for Bluetooth (see the table 13.3)

Table 13.3: Estimated SAR for Bluetooth

Position	F (GHz)	Distance (mm)	Upper limit of power *		Estimated _{1g} (W/kg)
			dBm	mW	
Head	2.441	5	3	2.00	0.08
Body	2.441	10	3	2.00	0.04

* - Maximum possible output power declared by manufacturer

When standalone SAR test exclusion applies to an antenna that transmits simultaneously with other antennas, the standalone SAR must be estimated according to following to determine simultaneous transmission SAR test exclusion:

(max. power of channel, including tune-up tolerance, mW)/(min. test separation distance, mm)]·[√f(GHz)/x] W/kg for test separation distances ≤ 50 mm;

where x = 7.5 for 1-g SAR.

When the minimum test separation distance is < 5 mm, a distance of 5 mm is applied to determine SAR test exclusion

Conclusion:

According to the above tables, the sum of reported SAR values is < 1.6W/kg. So the simultaneous transmission SAR with volume scans is not required.

14 SAR Test Result

It is determined by user manual for the distance between the EUT and the phantom bottom.

The distance is 10mm and just applied to the condition of body worn accessory.

It is performed for all SAR measurements with area scan based 1-g SAR estimation (Fast SAR). A zoom scan measurement is added when the estimated 1-g SAR is the highest measured SAR in each exposure configuration, wireless mode and frequency band combination or > 1.2W/kg.

The calculated SAR is obtained by the following formula:

$$\text{Reported SAR} = \text{Measured SAR} \times 10^{(P_{\text{Target}} - P_{\text{Measured}})/10}$$

Where P_{Target} is the power of manufacturing upper limit;

P_{Measured} is the measured power in chapter 11.

Table 14.1: Table 14.1: Duty Cycle

Mode	Duty Cycle
Speech for GSM850/1900	1:8.3
GPRS&EGPRS for GSM850	1:2
GPRS&EGPRS for GSM1900	1:2
WCDMA850/1900 &WiFi	1:1

14.1 SAR results for Fast SAR

Table 14.2: SAR Values (GSM 850 MHz Band - Head)

Frequency		Side	Test Position	Figure No.	Conducted Power (dBm)	Max. tune-up Power (dBm)	Measured SAR(10g) (W/kg)	Reported SAR(10g) (W/kg)	Measured SAR(1g) (W/kg)	Reported SAR(1g) (W/kg)	Power Drift (dB)
MHz	Ch.										
Ambient Temperature: 22.8 °C Liquid Temperature: 23.3 °C											
848.8	251	Left	Touch	Fig.1	32.12	33	0.440	0.54	0.610	0.75	0.01
836.6	190	Left	Touch	/	32.02	33	0.383	0.48	0.558	0.70	-0.04
824.2	128	Left	Touch	/	31.91	33	0.396	0.51	0.576	0.74	-0.26
836.6	190	Left	Tilt	/	32.02	33	0.279	0.35	0.405	0.51	-0.01
836.6	190	Right	Touch	/	32.02	33	0.354	0.44	0.513	0.64	0.18
836.6	190	Right	Tilt	/	32.02	33	0.213	0.27	0.312	0.39	-0.05

Table 14.3: SAR Values (GSM 850 MHz Band - Body) - Hotspot off

Frequency		Test Position	Figure No.	Conducted Power (dBm)	Max. tune-up Power (dBm)	Measured SAR(10g) (W/kg)	Reported SAR(10g) (W/kg)	Measured SAR(1g) (W/kg)	Reported SAR(1g) (W/kg)	Power Drift (dB)
MHz	Ch.									
Ambient Temperature: 22.5 °C Liquid Temperature: 23.0 °C										
836.6	190	Front	/	30.31	31	0.405	0.47	0.586	0.69	0.15
848.8	251	Rear	/	30.43	31	0.582	0.66	0.842	0.96	-0.01
836.6	190	Rear	/	30.31	31	0.607	0.71	0.877	1.03	0.03
824.2	128	Rear	/	30.20	31	0.634	0.76	0.878	1.06	-0.01

Note1: The distance between the EUT and the phantom bottom is 10mm.

Table 14.4: SAR Values (GSM 850 MHz Band - Body) - Hotspot on

Frequency		Test Position	Figure No.	Conducted Power (dBm)	Max. tune-up Power (dBm)	Measured SAR(10g) (W/kg)	Reported SAR(10g) (W/kg)	Measured SAR(1g) (W/kg)	Reported SAR(1g) (W/kg)	Power Drift (dB)
MHz	Ch.									
Ambient Temperature: 22.5 °C Liquid Temperature: 23.0 °C										
836.6	190	Front	/	30.31	31	0.405	0.47	0.586	0.69	0.15
848.8	251	Rear	/	30.43	31	0.582	0.66	0.842	0.96	-0.01
836.6	190	Rear	/	30.31	31	0.607	0.71	0.877	1.03	0.03
824.2	128	Rear	Fig.2	30.20	31	0.634	0.76	0.878	1.06	-0.01
836.6	190	Left	/	30.31	31	0.516	0.60	0.753	0.88	-0.17
836.6	190	Right	/	30.31	31	0.444	0.52	0.652	0.76	0.10
836.6	190	Bottom	/	30.31	31	0.075	0.09	0.116	0.14	-0.02
824.2	128	Rear EGPRS	/	30.18	31	0.623	0.75	0.862	1.04	0.06

Note1: The distance between the EUT and the phantom bottom is 10mm.

Table 14.5: SAR Values (GSM 1900 MHz Band - Head)

Frequency		Side	Test Position	Figure No.	Conducted Power (dBm)	Max. tune-up Power (dBm)	Measured SAR(10g) (W/kg)	Reported SAR(10g) (W/kg)	Measured SAR(1g) (W/kg)	Reported SAR(1g) (W/kg)	Power Drift (dB)
MHz	Ch.										
1880	661	Left	Touch	/	28.38	30	0.130	0.19	0.223	0.32	0.88
1880	661	Left	Tilt	/	28.38	30	0.039	0.06	0.061	0.09	0.22
1909.8	810	Right	Touch	Fig.3	28.67	30	0.197	0.27	0.350	0.48	0.18
1880	661	Right	Touch	/	28.38	30	0.170	0.25	0.295	0.43	0.58
1850.2	512	Right	Touch	/	28.84	30	0.149	0.20	0.257	0.34	0.26
1880	661	Right	Tilt	/	28.38	30	0.066	0.10	0.116	0.17	0.37

Table 14.6: SAR Values (GSM 1900 MHz Band - Body) - Hotspot off

Frequency		Test Position	Figure No.	Conducted Power (dBm)	Max. tune-up Power (dBm)	Measured SAR(10g) (W/kg)	Reported SAR(10g) (W/kg)	Measured SAR(1g) (W/kg)	Reported SAR(1g) (W/kg)	Power Drift (dB)
MHz	Ch.									
1880	661	Front	/	24.87	25.5	0.129	0.15	0.204	0.24	0.56
1909.8	810	Rear	/	25.18	25.5	0.152	0.16	0.265	0.29	0.18
1880	661	Rear	/	24.87	25.5	0.184	0.21	0.317	0.37	0.13
1850.2	512	Rear	/	24.77	25.5	0.146	0.17	0.241	0.29	-0.10

Note1: The distance between the EUT and the phantom bottom is 10mm.

Table 14.7: SAR Values (GSM 1900 MHz Band - Body) - Hotspot on

Frequency		Test Position	Figure No.	Conducted Power (dBm)	Max. tune-up Power (dBm)	Measured SAR(10g) (W/kg)	Reported SAR(10g) (W/kg)	Measured SAR(1g) (W/kg)	Reported SAR(1g) (W/kg)	Power Drift (dB)
MHz	Ch.									
1880	661	Front	/	24.87	25.5	0.129	0.15	0.204	0.24	0.56
1909.8	810	Rear	/	25.18	25.5	0.152	0.16	0.265	0.29	0.18
1880	661	Rear	Fig.4	24.87	25.5	0.184	0.21	0.317	0.37	0.13
1850.2	512	Rear	/	24.77	25.5	0.146	0.17	0.241	0.29	-0.10
1880	661	Left	/	24.87	25.5	0.042	0.05	0.071	0.08	0.16
1880	661	Right	/	24.87	25.5	0.062	0.07	0.106	0.12	0.06
1880	661	Bottom	/	24.87	25.5	0.129	0.15	0.229	0.26	0.06
1880	661	Rear EGPRS	/	24.85	25.5	0.179	0.21	0.309	0.36	0.19

Note1: The distance between the EUT and the phantom bottom is 10mm.

Table 14.8: SAR Values (WCDMA 850 MHz Band - Head)

Frequency		Side	Test Position	Figure No.	Conducted Power (dBm)	Max. tune-up Power (dBm)	Measured SAR(10g) (W/kg)	Reported SAR(10g) (W/kg)	Measured SAR(1g) (W/kg)	Reported SAR(1g) (W/kg)	Power Drift (dB)
MHz	Ch.										
846.6	4233	Left	Touch	/	23.20	23.5	0.310	0.33	0.451	0.48	0.04
836.6	4183	Left	Touch	Fig.5	23.20	23.5	0.439	0.47	0.598	0.64	0.02
826.6	4132	Left	Touch	/	23.11	23.5	0.357	0.39	0.519	0.57	0.16
836.6	4183	Left	Tilt	/	23.20	23.5	0.287	0.31	0.416	0.45	0.14
836.6	4183	Right	Touch	/	23.20	23.5	0.355	0.38	0.517	0.55	0.07
836.6	4183	Right	Tilt	/	23.20	23.5	0.268	0.29	0.388	0.42	0.16

Table 14.9: SAR Values (WCDMA 850 MHz Band - Body) - Hotspot off

Frequency		Test Position	Figure No.	Conducted Power (dBm)	Max. tune-up Power (dBm)	Measured SAR(10g) (W/kg)	Reported SAR(10g) (W/kg)	Measured SAR(1g) (W/kg)	Reported SAR(1g) (W/kg)	Power Drift (dB)
MHz	Ch.									
836.6	4183	Front	/	23.20	23.5	0.523	0.56	0.749	0.80	-0.05
846.6	4233	Rear	/	23.20	23.5	0.747	0.80	1.07	1.15	0.02
836.6	4183	Rear	/	23.20	23.5	0.792	0.85	1.13	1.21	-0.05
826.6	4132	Rear	/	23.11	23.5	0.765	0.84	1.10	1.20	-0.17

Note1: The distance between the EUT and the phantom bottom is 10mm.

Table 14.10: SAR Values (WCDMA 850 MHz Band - Body) - Hotspot on

Frequency		Test Position	Figure No.	Conducted Power (dBm)	Max. tune-up Power (dBm)	Measured SAR(10g) (W/kg)	Reported SAR(10g) (W/kg)	Measured SAR(1g) (W/kg)	Reported SAR(1g) (W/kg)	Power Drift (dB)
MHz	Ch.									
836.6	4183	Front	/	23.20	23.5	0.523	0.56	0.749	0.80	-0.05
846.6	4233	Rear	/	23.20	23.5	0.747	0.80	1.07	1.15	0.02
836.6	4183	Rear	Fig.6	23.20	23.5	0.792	0.85	1.13	1.21	-0.05
826.6	4132	Rear	/	23.11	23.5	0.765	0.84	1.10	1.20	-0.17
836.6	4183	Left	/	23.20	23.5	0.464	0.50	0.681	0.73	0.05
836.6	4183	Right	/	23.20	23.5	0.477	0.51	0.708	0.76	0.06
836.6	4183	Bottom	/	23.20	23.5	0.075	0.08	0.118	0.13	0.10
836.6	4183	Rear headset	/	23.20	23.5	0.768	0.83	1.02	1.09	0.11

Note1: The distance between the EUT and the phantom bottom is 10mm.

Table 14.11: SAR Values (WCDMA 1900 MHz Band - Head)

Frequency		Side	Test Position	Figure No.	Conducted Power (dBm)	Max. tune-up Power (dBm)	Measured SAR(10g) (W/kg)	Reported SAR(10g) (W/kg)	Measured SAR(1g) (W/kg)	Reported SAR(1g) (W/kg)	Power Drift (dB)
MHz	Ch.										
1907.6	9538	Left	Touch	/	22.3	23.5	0.274	0.32	0.462	0.54	0.11
1880	9400	Left	Touch	/	22.3	23.5	0.284	0.33	0.474	0.55	0.07
1852.4	9262	Left	Touch	Fig.7	22.4	23.5	0.289	0.33	0.492	0.56	0.15
1880	9400	Left	Tilt	/	22.3	23.5	0.093	0.11	0.169	0.20	0.12
1880	9400	Right	Touch	/	22.3	23.5	0.281	0.33	0.460	0.54	0.13
1880	9400	Right	Tilt	/	22.3	23.5	0.086	0.10	0.154	0.18	0.12

Table 14.12: SAR Values (WCDMA 1900 MHz Band - Body) - Hotspot off

Frequency		Test Position	Figure No.	Conducted Power (dBm)	Max. tune-up Power (dBm)	Measured SAR(10g) (W/kg)	Reported SAR(10g) (W/kg)	Measured SAR(1g) (W/kg)	Reported SAR(1g) (W/kg)	Power Drift (dB)
MHz	Ch.									
1880	9400	Front	/	22.3	23.5	0.280	0.33	0.452	0.53	0.05
1907.6	9538	Rear	/	22.3	23.5	0.366	0.43	0.653	0.77	-0.07
1880	9400	Rear	/	22.3	23.5	0.369	0.43	0.647	0.76	0.12
1852.4	9262	Rear	/	22.4	23.5	0.420	0.48	0.690	0.79	-0.18

Note1: The distance between the EUT and the phantom bottom is 10mm.

Table 14.13: SAR Values (WCDMA 1900 MHz Band - Body) - Hotspot on

Frequency		Test Position	Figure No.	Conducted Power (dBm)	Max. tune-up Power (dBm)	Measured SAR(10g) (W/kg)	Reported SAR(10g) (W/kg)	Measured SAR(1g) (W/kg)	Reported SAR(1g) (W/kg)	Power Drift (dB)
MHz	Ch.									
1880	9400	Front	/	22.3	23.5	0.280	0.33	0.452	0.53	0.05
1907.6	9538	Rear	/	22.3	23.5	0.366	0.43	0.653	0.77	-0.07
1880	9400	Rear	/	22.3	23.5	0.369	0.43	0.647	0.76	0.12
1852.4	9262	Rear	Fig.8	22.4	23.5	0.420	0.48	0.690	0.79	-0.18
1880	9400	Left	/	22.3	23.5	0.098	0.12	0.172	0.20	-0.17
1880	9400	Right	/	22.3	23.5	0.074	0.09	0.127	0.15	-0.02
1880	9400	Bottom	/	22.3	23.5	0.181	0.21	0.318	0.37	0.12

Note1: The distance between the EUT and the phantom bottom is 10mm.

14.2 SAR results for Standard procedure

There is zoom scan measurement to be added for the highest measured SAR in each exposure configuration/band.

Table 14.14: SAR Values (GSM 850 MHz Band - Head)

Ambient Temperature: 22.8 °C						Liquid Temperature: 23.3 °C					
Frequency		Side	Test Position	Figure No.	Conducted Power (dBm)	Max. tune-up Power (dBm)	Measured SAR(10g) (W/kg)	Reported SAR(10g) (W/kg)	Measured SAR(1g) (W/kg)	Reported SAR(1g) (W/kg)	Power Drift (dB)
MHz	Ch.										
848.8	251	Left	Touch	Fig.1	32.12	33	0.440	0.54	0.610	0.75	0.01

Table 14.15: SAR Values (GSM 850 MHz Band - Body) - Hotspot on

Ambient Temperature: 22.5 °C				Liquid Temperature: 23.0 °C						
Frequency		Test Position	Figure No.	Conducted Power (dBm)	Max. tune-up Power (dBm)	Measured SAR(10g) (W/kg)	Reported SAR(10g) (W/kg)	Measured SAR(1g) (W/kg)	Reported SAR(1g) (W/kg)	Power Drift (dB)
MHz	Ch.									
824.2	128	Rear	Fig.2	30.20	31	0.634	0.76	0.878	1.06	-0.01

Table 14.16: SAR Values (GSM 1900 MHz Band - Head)

Ambient Temperature: 23.0 °C						Liquid Temperature: 23.5 °C					
Frequency		Side	Test Position	Figure No.	Conducted Power (dBm)	Max. tune-up Power (dBm)	Measured SAR(10g) (W/kg)	Reported SAR(10g) (W/kg)	Measured SAR(1g) (W/kg)	Reported SAR(1g) (W/kg)	Power Drift (dB)
MHz	Ch.										
1909.8	810	Right	Touch	Fig.3	28.67	29	0.197	0.21	0.350	0.48	0.18

Table 14.17: SAR Values (GSM 1900 MHz Band - Body) - Hotspot on

Ambient Temperature: 22.5 °C				Liquid Temperature: 23.0 °C						
Frequency		Test Position	Figure No.	Conducted Power (dBm)	Max. tune-up Power (dBm)	Measured SAR(10g) (W/kg)	Reported SAR(10g) (W/kg)	Measured SAR(1g) (W/kg)	Reported SAR(1g) (W/kg)	Power Drift (dB)
MHz	Ch.									
1880	661	Rear	Fig.4	24.87	25.5	0.184	0.21	0.317	0.37	0.10

Table 14.18: AR Values (WCDMA 850 MHz Band - Head)

Ambient Temperature: 23.0 °C						Liquid Temperature: 23.5 °C					
Frequency		Side	Test Position	Figure No.	Conducted Power (dBm)	Max. tune-up Power (dBm)	Measured SAR(10g) (W/kg)	Reported SAR(10g) (W/kg)	Measured SAR(1g) (W/kg)	Reported SAR(1g) (W/kg)	Power Drift (dB)
MHz	Ch.										
836.6	4183	Left	Touch	Fig.5	22.60	23	0.439	0.48	0.598	0.74	0.02

Table 14.19: SAR Values (WCDMA 850 MHz Band - Body) - Hotspot on

Ambient Temperature: 22.5 °C				Liquid Temperature: 23.0 °C						
Frequency		Test Position	Figure No.	Conducted Power (dBm)	Max. tune-up Power (dBm)	Measured SAR(10g) (W/kg)	Reported SAR(10g) (W/kg)	Measured SAR(1g) (W/kg)	Reported SAR(1g) (W/kg)	Power Drift (dB)
MHz	Ch.									
836.6	4183	Rear	Fig.6	22.6	23	0.792	0.87	1.13	1.21	-0.05

Table 14.20: SAR Values (WCDMA 1900 MHz Band - Head)

Frequency		Side	Test Position	Figure No.	Conducted Power (dBm)	Max. tune-up Power (dBm)	Measured SAR(10g) (W/kg)	Reported SAR(10g) (W/kg)	Measured SAR(1g) (W/kg)	Reported SAR(1g) (W/kg)	Power Drift (dB)
MHz	Ch.										
		Ambient Temperature: 23.0°C				Liquid Temperature: 23.5°C					
1852.4	9262	Left	Touch	Fig.7	22.4	23	0.289	0.33	0.492	0.56	0.13

Table 14.21: SAR Values (WCDMA 1900 MHz Band - Body) - Hotspot on

Frequency		Test Position	Figure No.	Conducted Power (dBm)	Max. tune-up Power (dBm)	Measured SAR(10g) (W/kg)	Reported SAR(10g) (W/kg)	Measured SAR(1g) (W/kg)	Reported SAR(1g) (W/kg)	Power Drift (dB)	
MHz	Ch.										
		Ambient Temperature: 22.5°C				Liquid Temperature: 23.0°C					
1852.4	9262	Rear	Fig.8	22.4	23	0.420	0.48	0.690	0.79	-0.18	

14.3 WLAN Evaluation

According to the KDB248227 D01, SAR is measured for 2.4GHz 802.11b DSSS using the initial test position procedure.

Head Evaluation

Table 14.22: SAR Values (Wi-Fi 802.11b Head) – 802.11b 1Mbps (Fast SAR)

Frequency		Side	Test Position	Figure No.	Conducted Power (dBm)	Max. tune-up Power (dBm)	Measured SAR(10g) (W/kg)	Reported SAR(10g) (W/kg)	Measured SAR(1g) (W/kg)	Reported SAR(1g) (W/kg)	Power Drift (dB)
MHz	Ch.										
2462	11	Left	Touch	/	13.07	13.5	0.136	0.15	0.303	0.33	0.11
2462	11	Left	Tilt	/	13.07	13.5	0.068	0.08	0.153	0.17	0.06
2462	11	Right	Touch	/	13.07	13.5	0.176	0.19	0.379	0.42	0.12
2462	11	Right	Tilt	/	13.07	13.5	0.093	0.10	0.214	0.24	0.09

As shown above table, the initial test position for head is “Right Touch”. So the head SAR of WLAN is presented as below:

Table 14.23: SAR Values (WLAN - Head) – 802.11b 1Mbps (Full SAR)

Frequency		Side	Test Position	Figure No.	Conducted Power (dBm)	Max. tune-up Power (dBm)	Measured SAR(10g) (W/kg)	Reported SAR(10g) (W/kg)	Measured SAR(1g) (W/kg)	Reported SAR(1g) (W/kg)	Power Drift (dB)
MHz	Ch.										
2462	11	Right	Touch	Fig.9	13.07	13.5	0.181	0.20	0.398	0.44	0.12
2462	11	Left	Touch	/	13.07	13.5	0.138	0.15	0.306	0.34	0.11

According to the KDB248227 D01, The reported SAR must be scaled to 100% transmission duty factor to determine compliance at the maximum tune-up tolerance limit. A maximum transmission duty factor of 94.5% is achievable for WLAN in this project and the scaled reported SAR is presented as below.

Table 14.24: SAR Values (WLAN - Head) – 802.11b 1Mbps (Scaled Reported SAR)

Frequency		Side	Test Position	Actual duty factor	maximum duty factor	Reported SAR (1g) (W/kg)	Scaled reported SAR (1g) (W/kg)
MHz	Ch.						
2462	11	Right	Touch	94.5%	100%	0.44	0.47
2462	11	Left	Touch	94.5%	100%	0.34	0.36

SAR is not required for OFDM because the 802.11b adjusted SAR \leq 1.2 W/kg.

Body Evaluation

Table 14.25: SAR Values (WLAN - Body) – 802.11b 1Mbps (Fast SAR)

Frequency		Test Position	Figure No.	Ambient Temperature: 23.0 °C		Liquid Temperature: 22.5 °C				Power Drift (dB)
MHz	Ch.			Conducted Power (dBm)	Max. tune-up Power (dBm)	Measured SAR(10g) (W/kg)	Reported SAR(10g) (W/kg)	Measured SAR(1g) (W/kg)	Reported SAR(1g) (W/kg)	
2462	11	Front	/	13.07	13.5	0.028	0.03	0.049	0.05	0.01
2462	11	Rear	/	13.07	13.5	0.029	0.03	0.050	0.06	0.04
2462	11	Left	/	13.07	13.5	0.0231	0.03	0.042	0.05	0.04
2462	11	Right	/	13.07	13.5	0.011	0.01	0.021	0.02	0.04
2462	11	Top	/	13.07	13.5	0.020	0.02	0.039	0.04	0.03

Note1: The distance between the EUT and the phantom bottom is 10mm.

As shown above table, the initial test position for body is “Rear”. So the body SAR of WLAN is presented as below:

Table 14.26: SAR Values (WLAN - Body) – 802.11b 1Mbps (Full SAR)

Frequency		Test Position	Figure No.	Ambient Temperature: 23.0 °C		Liquid Temperature: 22.5 °C				Power Drift (dB)
MHz	Ch.			Conducted Power (dBm)	Max. tune-up Power (dBm)	Measured SAR(10g) (W/kg)	Reported SAR(10g) (W/kg)	Measured SAR(1g) (W/kg)	Reported SAR(1g) (W/kg)	
2462	11	Rear	Fig.10	13.07	13.5	0.030	0.03	0.052	0.06	0.04

According to the KDB248227 D01, The reported SAR must be scaled to 100% transmission duty factor to determine compliance at the maximum tune-up tolerance limit. A maximum transmission duty factor of 94.5% is achievable for WLAN in this project and the scaled reported SAR is presented as below.

Table 14.27: SAR Values (WLAN - Body) – 802.11b 1Mbps (Scaled Reported SAR)

Frequency		Test Position	Ambient Temperature: 22.5 °C		Liquid Temperature: 22.0 °C	
MHz	Ch.		Actual duty factor	maximum duty factor	Reported SAR (1g) (W/kg)	Scaled reported SAR (1g) (W/kg)
2462	11	Rear	94.5%	100%	0.06	0.06

SAR is not required for OFDM because the 802.11b adjusted SAR \leq 1.2 W/kg.

15 SAR Measurement Variability

SAR measurement variability must be assessed for each frequency band, which is determined by the SAR probe calibration point and tissue-equivalent medium used for the device measurements. When both head and body tissue-equivalent media are required for SAR measurements in a frequency band, the variability measurement procedures should be applied to the tissue medium with the highest measured SAR, using the highest measured SAR configuration for that tissue-equivalent medium.

The following procedures are applied to determine if repeated measurements are required.

- 1) Repeated measurement is not required when the original highest measured SAR is < 0.80 W/kg; steps 2) through 4) do not apply.
- 2) When the original highest measured SAR is ≥ 0.80 W/kg, repeat that measurement once.
- 3) Perform a second repeated measurement only if the ratio of largest to smallest SAR for the original and first repeated measurements is > 1.20 or when the original or repeated measurement is ≥ 1.45 W/kg (~ 10% from the 1-g SAR limit).
- 4) Perform a third repeated measurement only if the original, first or second repeated measurement is ≥ 1.5 W/kg and the ratio of largest to smallest SAR for the original, first and second repeated measurements is > 1.20 .

Table 15.1: SAR Measurement Variability for GSM 850 Body With GPRS (1g)

Frequency		Test Position	Spacing (mm)	Original SAR (W/kg)	First Repeated SAR (W/kg)	The Ratio	Second Repeated SAR (W/kg)
MHz	Ch.						
824.2	128	Rear	10	0.878	0.872	1.01	/

Table 15.2: SAR Measurement Variability for WCDMA 850 Body (1g)

Frequency		Test Position	Spacing (mm)	Original SAR (W/kg)	First Repeated SAR (W/kg)	The Ratio	Second Repeated SAR (W/kg)
MHz	Ch.						
836.6	4183	Rear	10	1.13	1.08	1.05	/

16 Measurement Uncertainty

16.1 Measurement Uncertainty for Normal SAR Tests (300MHz~3GHz)

No.	Error Description	Type	Uncertainty value	Probably Distribution	Div.	(Ci) 1g	(Ci) 10g	Std. Unc. (1g)	Std. Unc. (10g)	Degree of freedom
Measurement system										
1	Probe calibration	B	5.5	N	1	1	1	5.4	5.4	∞
2	Isotropy	B	4.7	R	$\sqrt{3}$	1	1	1.6	1.6	∞
3	hemisphere isotropy of the probe	B	2.8	R	$\sqrt{3}$	$\sqrt{0.5}$	$\sqrt{0.5}$	0.85	0.85	∞
4	spatial resolution	B	0	R	$\sqrt{3}$	1	1	0	0	∞
5	Boundary effect	B	1.0	R	$\sqrt{3}$	1	1	6.4	6.4	∞
6	Linearity	B	4.7	R	$\sqrt{3}$	1	1	0.5	0.5	∞
7	Detection limit	B	1.0	N	1	1	1	1	1	∞
8	Readout electronics	B	0.3	R	$\sqrt{3}$	1	1	0.6	0.6	∞
9	Response time	B	0.8	R	$\sqrt{3}$	1	1	0.0	0.0	∞
10	Integration time	B	2.6	R	$\sqrt{3}$	1	1	1.0	1.0	∞
11	RF ambient conditions-noise	B	0	R	$\sqrt{3}$	1	1	1.7	1.7	∞
12	RF ambient conditions-reflection	B	0	R	$\sqrt{3}$	1	1	1.7	1.7	∞
13	Probe positioned mech. restrictions	B	0.4	R	$\sqrt{3}$	1	1	0.2	0.2	∞
14	Probe positioning with respect to phantom shell	B	2.9	R	$\sqrt{3}$	1	1	1.7	1.7	∞
15	Post-processing	B	1.0	R	$\sqrt{3}$	1	1	1.2	1.2	∞
16	Probe modulation response	B	2.3	R	$\sqrt{3}$	1	1	1.21	1.21	∞
Test sample related										
17	Test sample positioning	A	3.3	N	1	1	1	3.3	3.3	5
18	Device holder uncertainty	A	3.4	N	1	1	1	3.4	3.4	5
19	Drift of output power	B	5.0	R	$\sqrt{3}$	1	1	2.9	2.9	∞
Phantom and set-up										
20	Phantom uncertainty	B	4.0	R	$\sqrt{3}$	1	1	2.3	2.3	∞
21	Liquid conductivity (target)	B	5.0	R	$\sqrt{3}$	0.64	0.43	1.8	1.2	∞
22	Liquid conductivity (meas.)	A	2.06	N	1	0.64	0.43	1	0.28	9
23	Liquid permittivity (target)	B	5.0	R	$\sqrt{3}$	0.6	0.49	1.7	1.4	∞
24	Liquid permittivity (meas.)	A	1.6	N	1	0.6	0.49	0.31	0.25	9
25	Algorithm for correcting SAR for deviations in permittivity and	B	1.9	N	1	1	1	1.9	1.9	∞

	conductivity									
Combined standard uncertainty		$u_c = \sqrt{\sum_{i=1}^{21} c_i^2 u_i^2}$						11.1	11.0	323
Expanded uncertainty (confidence interval of 95 %)		$u_e = 2u_c$						22.3	22.1	

16.2 Measurement Uncertainty for Fast SAR Tests (300MHz~3GHz)

No.	Error Description	Type	Uncertainty value	Probably Distribution	Div.	(Ci) 1g	(Ci) 10g	Std. Unc. (1g)	Std. Unc. (10g)	Degree of freedom
Measurement system										
1	Probe calibration	B	10.8	N	1	1	5.4	5.4	1	∞
2	Isotropy	B	2.8	R	1	1	1.6	1.6	1	∞
3	hemisphere isotropy of the probe	B	2.8	R	$\sqrt{3}$	$\sqrt{0.5}$	$\sqrt{0.5}$	0.85	0.85	∞
4	spatial resolution	B	0	R	$\sqrt{3}$	1	1	0	0	∞
5	Boundary effect	B	1.0	R	1	1	0.6	0.6	1	∞
6	Linearity	B	4.7	R	1	1	2.7	2.7	1	∞
7	Detection limit	B	1.0	R	1	1	0.6	0.6	1	∞
8	Readout electronics	B	0.3	R	1	1	0.3	0.3	1	∞
9	Response time	B	0.8	R	1	1	0.5	0.5	1	∞
10	Integration time	B	2.6	R	1	1	1.5	1.5	1	∞
11	RF ambient conditions-noise	B	0	R	1	1	0	0	1	∞
12	RF ambient conditions-reflection	B	0	R	1	1	0	0	1	∞
13	Probe positioned mech. Restrictions	B	0.4	R	1	1	0.2	0.2	1	∞
14	Probe positioning with respect to phantom shell	B	2.9	R	1	1	1.7	1.7	1	∞
15	Post-processing	B	1.0	R	1	1	0.6	0.6	1	∞
16	Fast SAR z-Approximation	B	7.0	R	1	1	4.0	4.0	1	∞
17	Probe modulation response	B	2.3	R	$\sqrt{3}$	1	1	1.21	1.21	∞
Test sample related										
18	Test sample positioning	A	3.3	N	1	1	1	3.3	3.3	71
19	Device holder uncertainty	A	3.4	N	1	1	1	3.4	3.4	5
20	Drift of output power	B	5.0	R	$\sqrt{3}$	1	1	2.9	2.9	∞
Phantom and set-up										
21	Phantom uncertainty	B	4.0	R	$\sqrt{3}$	1	1	2.3	2.3	∞
22	Liquid conductivity (target)	B	5.0	R	$\sqrt{3}$	0.64	0.43	1.8	1.2	∞

23	Liquid conductivity (meas.)	A	2.06	N	1	0.64	0.43	1.32	0.89	43
24	Liquid permittivity (target)	B	5.0	R	$\sqrt{3}$	0.6	0.49	1.7	1.4	∞
25	Liquid permittivity (meas.)	A	1.6	N	1	0.6	0.49	1.0	0.8	211
26	Algorithm for correcting SAR for deviations in permittivity and conductivity	B	1.9	N	1	1	1	1.9	1.9	∞
Combined standard uncertainty		$u_c = \sqrt{\sum_{i=1}^{22} c_i^2 u_i^2}$						13.1	12.4 5	843
Expanded uncertainty (confidence interval of 95 %)		$u_e = 2u_c$						26.2	25.9	

17 MAIN TEST INSTRUMENTS

Table 17.1: List of Main Instruments

No.	Name	Type	Serial Number	Calibration Date	Valid Period
01	Network analyzer	Agilent E5071C	MY46103759	December 17,2014	One year
02	Power meter	NRVD	101253	March 5,2015	One year
03	Power sensor	NRV-Z5	100333		
04	Signal Generator	E4438C	MY45095825	January 13, 2015	One year
05	Amplifier	VTL5400	0404	No Calibration Requested	
06	BTS	E5515C	GB47460133	September 4, 2014	One year
07	E-field Probe	SPEAG EX3DV4	3633	January 30, 2015	One year
08	DAE	SPEAG DAE4	786	November 20, 2014	One year
09	Dipole Validation Kit	SPEAG D900V2	1d054	November 5, 2014	One year
10	Dipole Validation Kit	SPEAG D1800V2	2d147	November 6, 2014	One year
11	Dipole Validation Kit	SPEAG D1900V2	873	November 5, 2014	One year
12	Dipole Validation Kit	SPEAG D2450V2	5d088	November 3, 2014	One year

END OF REPORT BODY

ANNEX A Graph Results

GSM 850 Head Left

Date/Time: 2015/9/6

Electronics: DAE4 Sn786

Medium: Head 900 MHz

Medium parameters used (interpolated): $f = 848.8$ MHz; $\sigma = 0.939$ S/m; $\epsilon_r = 41.723$; $\rho = 1000$ kg/m³

Ambient Temperature:22.0°C Liquid Temperature:21.5°C

Communication System: GSM Frequency: 848.8 MHz Duty Cycle: 1:8.3

Probe: EX3DV4 - SN3633 ConvF(8.95, 8.95, 8.95);

Left Cheek High/Area Scan (61x101x1): Interpolated grid: dx=1.500 mm, dy=1.500 mm

Maximum value of SAR (interpolated) = 0.630 W/kg

Left Cheek High/Zoom Scan (7x7x7)/Cube 0: Measurement grid: dx=5mm, dy=5mm, dz=5mm

Reference Value = 9.629 V/m; Power Drift = 0.01 dB

Peak SAR (extrapolated) = 0.817 W/kg

SAR(1 g) = 0.610 W/kg; SAR(10 g) = 0.440 W/kg

Maximum value of SAR (measured) = 0.639 W/kg

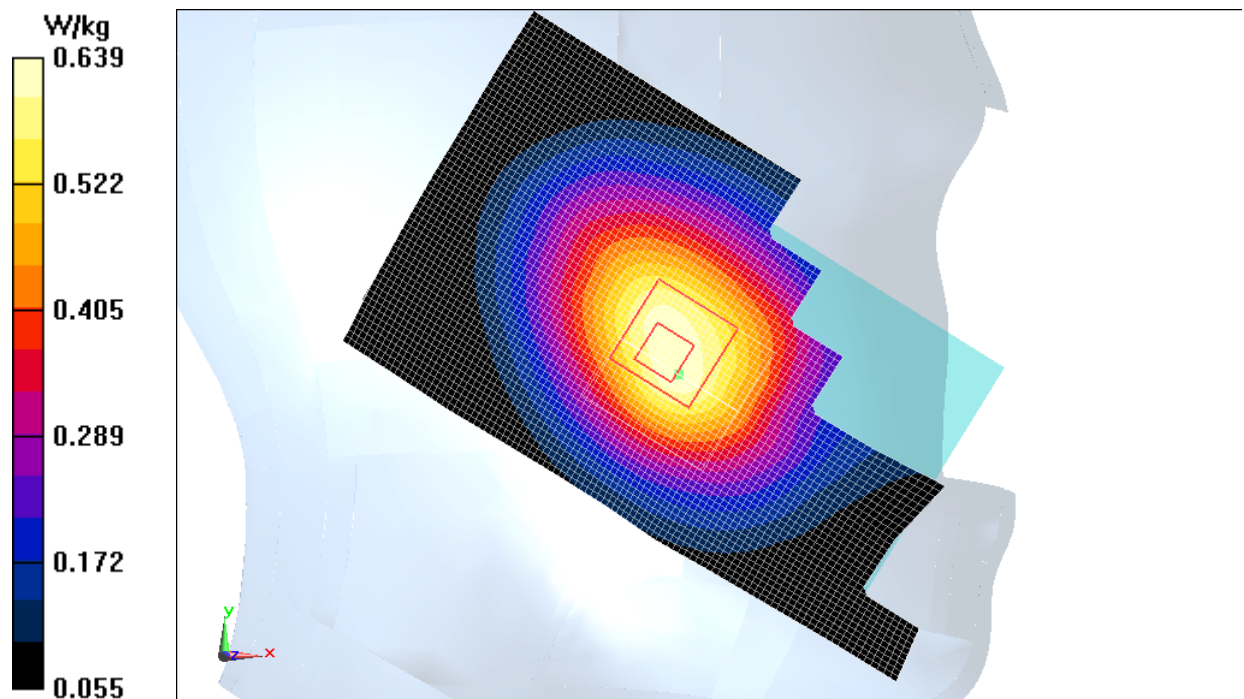

Fig.1 850MHz CH251

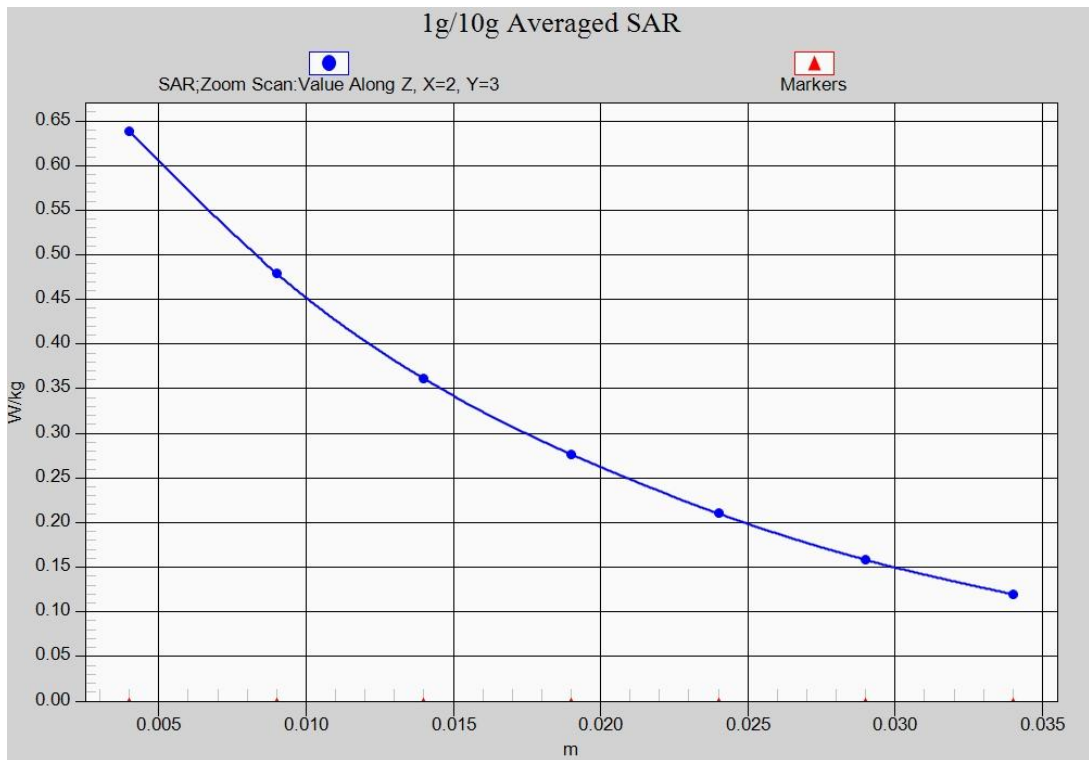

Fig. 1-1 Z-Scan at power reference point (850 MHz CH251)

GSM 850 Body Rear- Hotspot on

Date/Time: 2015/9/8

Electronics: DAE4 Sn786

Medium: Body850 MHz

Medium parameters used (interpolated): $f = 824.2$ MHz; $\sigma = 0.959$ S/m; $\epsilon_r = 53.571$; $\rho = 1000$ kg/m³

Ambient Temperature: 22.0°C Liquid Temperature: 21.5°C

Communication System: 2 slot GPRS Frequency: 824.2 MHz Duty Cycle: 1:4

Probe: EX3DV4 - SN3633 ConvF(9.24, 9.24, 9.24);

Rear side Low/Area Scan (51x91x1): Interpolated grid: dx=1.500 mm, dy=1.500 mm

Maximum value of SAR (interpolated) = 0.930 W/kg

Rear side Low/Zoom Scan (7x7x7)/Cube 0: Measurement grid: dx=5mm, dy=5mm, dz=5mm

Reference Value = 27.832 V/m; Power Drift = -0.01 dB

Peak SAR (extrapolated) = 1.14 W/kg

SAR(1 g) = 0.878 W/kg; SAR(10 g) = 0.634 W/kg

Maximum value of SAR (measured) = 0.937 W/kg

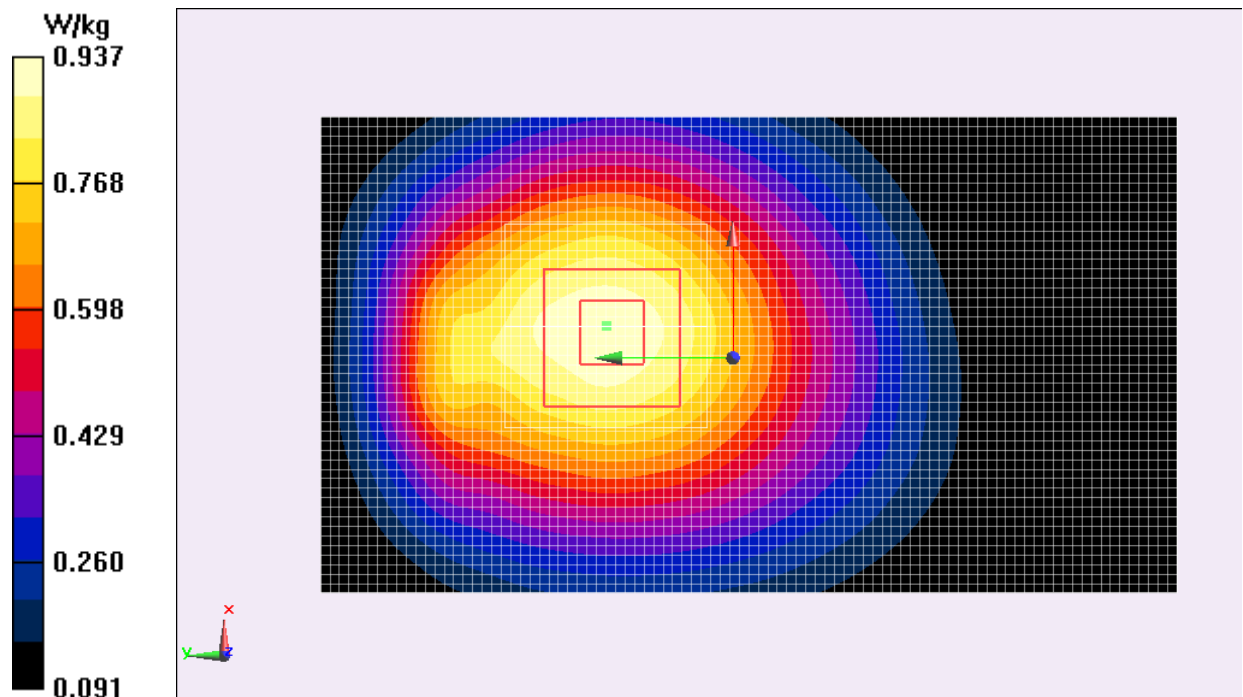

Fig.2 850 MHz CH128

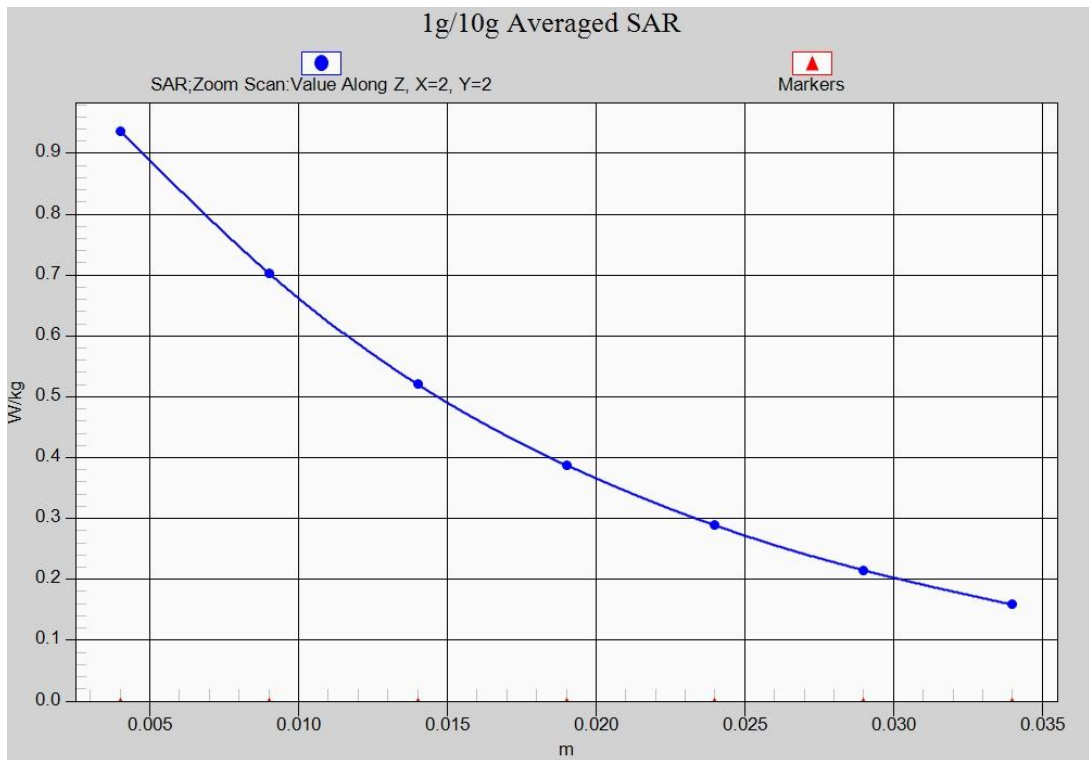

Fig. 2-1 Z-Scan at power reference point (850 MHz CH128)

GSM 1900 Head Right

Date/Time: 2015/9/6

Electronics: DAE4 Sn786

Medium: 1900 Head

Medium parameters used: $f = 1910$ MHz; $\sigma = 1.449$ S/m; $\epsilon_r = 40.418$; $\rho = 1000$ kg/m³

Ambient Temperature: 22.0°C Liquid Temperature: 21.5°C

Communication System: GSM Frequency: 1910 MHz Duty Cycle: 1:8.3

Probe: EX3DV4 - SN3633 ConvF(7.72, 7.72, 7.72);

Right Cheek High/Area Scan (61x101x1): Interpolated grid: dx=1.500 mm, dy=1.500 mm

Maximum value of SAR (interpolated) = 0.390 W/kg

Right Cheek High/Zoom Scan (7x7x7)/Cube 0: Measurement grid: dx=5mm, dy=5mm, dz=5mm

Reference Value = 6.429 V/m; Power Drift = 0.18 dB

Peak SAR (extrapolated) = 0.614 W/kg

SAR(1 g) = 0.350 W/kg; SAR(10 g) = 0.197 W/kg

Maximum value of SAR (measured) = 0.386 W/kg

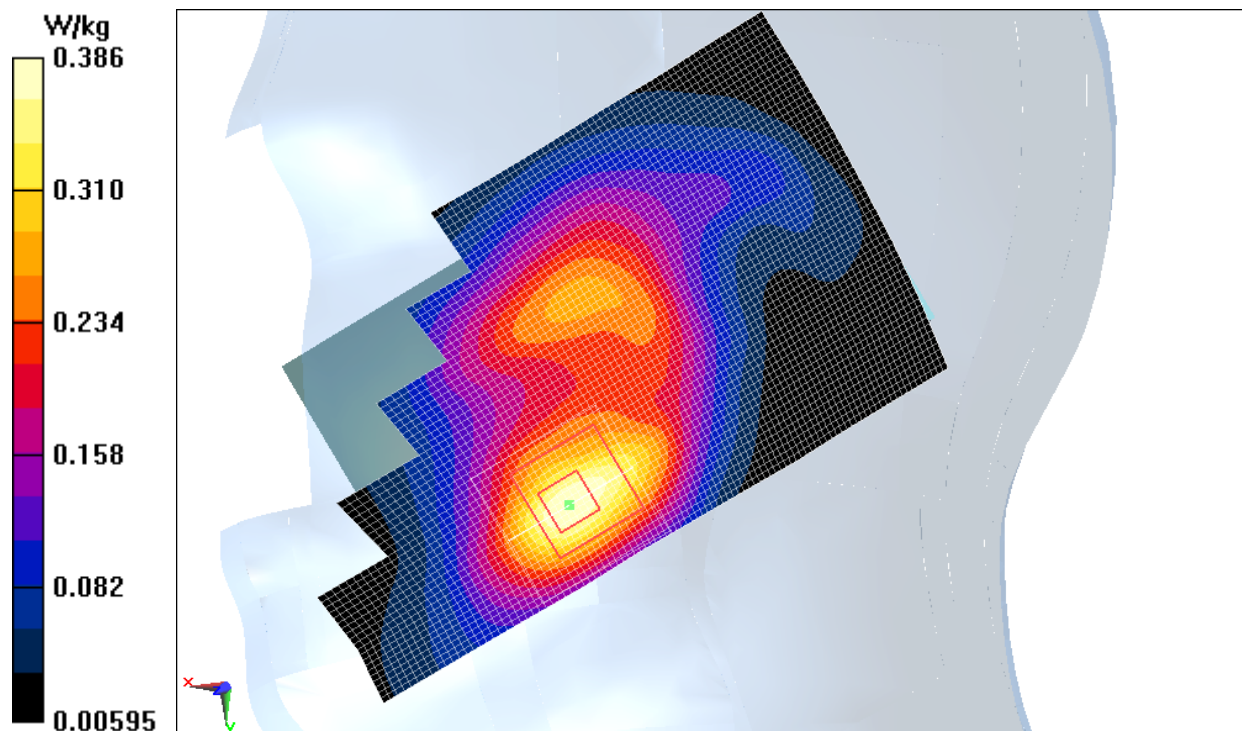

Fig.3 1900 MHz CH810

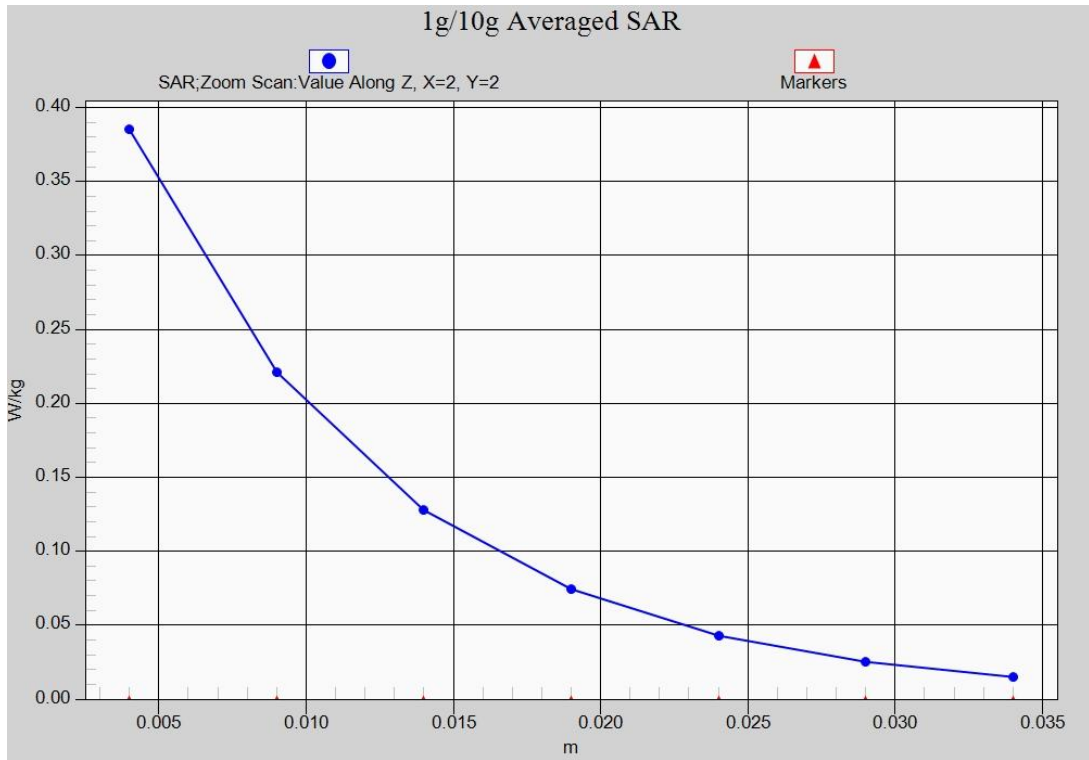

Fig. 3-1 Z-Scan at power reference point (1900 MHz CH512)