

FCC

SAR

TEST REPORT

ISSUED BY  
Shenzhen BALUN Technology Co., Ltd.



FOR  
**Smartphone**

ISSUED TO  
Shenzhen Sang Fei Consumer Communications Co., Ltd

11 Science and Technology Road, Shenzhen Hi-tech Industrial Park  
Nanshan District, Shenzhen city, GuangDong province, 518057, China



Tested by:

*Tu Lang*  
Tu Lang  
(Engineer)

Date

*Dec. 13, 2016*

Approved by:

*Wei Yanquan*  
Wei Yanquan  
(Chief Engineer)

Date

*Dec. 13, 2016*



Report No.: BL-SZ16B0295-701

EUT Type: Smartphone

Model Name: O7

Brand Name: AOC

FCC ID: VQRCT07

Test Standard: FCC 47 CFR Part 2.1093

ANSI C95.1: 1999, IEEE 1528: 2013

Maximum SAR: Head (1 g): 0.388 W/kg

Body-worn (1 g): 0.643 W/kg

Hotspot (1 g): 0.898 W/kg

Test Conclusion: Pass

Test Date: Nov 24, 2016 ~ Nov 28, 2016

Date of Issue: Dec. 13, 2016

*NOTE: This test report can be duplicated completely for the legal use with the approval of the applicant; it shall not be reproduced except in full, without the written approval of Shenzhen BALUN Technology Co., Ltd. BALUN Laboratory. Any objections should be raised within thirty days from the date of issue. To validate the report, please visit BALUN website.*

### Revision History

<u>Version</u>	<u>Issue Date</u>	<u>Revisions Content</u>
<u>Rev. 01</u>	<u>Dec. 13, 2016</u>	<u>Initial Issue</u>

## TABLE OF CONTENTS

1	GENERAL INFORMATION.....	5
1.1	Identification of the Testing Laboratory.....	5
1.2	Identification of the Responsible Testing Location.....	5
1.3	Test Environment Condition.....	5
1.4	Announce.....	6
2	PRODUCT INFORMATION.....	7
2.1	Applicant Information.....	7
2.2	Manufacturer Information.....	7
2.3	Factory Information.....	7
2.4	General Description for Equipment under Test (EUT).....	7
2.5	Ancillary Equipment.....	8
2.6	Technical Information.....	9
3	SUMMARY OF TEST RESULTS.....	10
3.1	Test Standards.....	10
3.2	Device Category and SAR Limit.....	10
3.3	Test Result Summary.....	12
3.4	Test Uncertainty.....	13
4	SAR MEASUREMENT SYSTEM.....	14
4.1	Definition of Specific Absorption Rate (SAR).....	14
4.2	SATIMO SAR System.....	14
5	SYSTEM VERIFICATION.....	23
5.1	Antenna Port Test Requirement.....	23
5.2	Purpose of System Check.....	23
5.3	System Check Setup.....	23
6	EUT TEST POSITION CONFIGURATIONS.....	24
6.1	Head Exposure Conditions.....	24

6.2	Body-worn Position Conditions .....	25
6.3	Hotspot Mode Exposure Position Conditions .....	26
7	SAR MEASUREMENT PROCEDURES.....	27
7.1	SAR Measurement Process Diagram .....	27
7.2	SAR Scan General Requirements .....	28
7.3	SAR Measurement Procedure .....	29
7.4	Area & Zoom Scan Procedures .....	29
8	CONDUCTED RF OUPUT POWER .....	30
8.1	GSM.....	30
8.2	WCDMA .....	31
8.3	LTE.....	32
8.4	WIFI.....	35
8.5	Bluetooth .....	36
9	EUT ANTENNA LOCATION SKETCH .....	37
9.1	SAR Test Exclusion Consider Table.....	38
9.2	10g Extremity Exposure Consider .....	40
10	TEST RESULTS.....	41
10.1	GSM 850 .....	41
10.2	GSM 1900 .....	42
10.3	WCDMA Band 2 .....	43
10.4	WCDMA Band 5 .....	43
10.5	LTE Band 2 (20MHz Bandwidth) .....	44
10.6	LTE Band 4 (20MHz Bandwidth) .....	45
10.7	LTE Band 7 (20MHz Bandwidth) .....	46
10.8	WIFI 2.4GHz.....	46
11	SAR Measurement Variability .....	47
12	SIMULTANEOUS TRANSMISSION.....	48
12.1	Simultaneous Transmission Mode Consider .....	48
12.2	Estimated SAR Calculation.....	49
12.3	Sum SAR of Simultaneous Transmission .....	50
13	TEST EQUIPMENTS LIST .....	52
ANNEX A	SIMULATING LIQUID VERIFICATION RESULT .....	53

ANNEX B SYSTEM CHECK RESULT ..... 54

ANNEX C TEST DATA..... 75

ANNEX D EXTERNAL PHOTOS ..... 91

ANNEX E SAR TEST SETUP PHOTOS ..... 91

ANNEX F CALIBRATION REPORT ..... 92

    F.1 E-Field Probe ..... 92

    F.2 835MHz Dipole ..... 102

    F.3 1800MHz Dipole ..... 113

    F.4 1900MHz Dipole ..... 124

    F.5 2450MHz Dipole ..... 135

    F.6 2600MHz Dipole ..... 146

# 1 GENERAL INFORMATION

## 1.1 Identification of the Testing Laboratory

Company Name	Shenzhen BALUN Technology Co., Ltd.
Address	Block B, 1st FL, Baisha Science and Technology Park, Shahe Xi Road, Nanshan District, Shenzhen, Guangdong Province, P. R. China
Phone Number	+86 755 6685 0100
Fax Number	+86 755 6182 4271

## 1.2 Identification of the Responsible Testing Location

Test Location	Shenzhen BALUN Technology Co., Ltd.
Address	Block B, 1st FL, Baisha Science and Technology Park, Shahe Xi Road, Nanshan District, Shenzhen, Guangdong Province, P. R. China
Accreditation Certificate	<p>The laboratory has been listed by Industry Canada to perform electromagnetic emission measurements. The recognition numbers of test site are 11524A-1.</p> <p>The laboratory has been listed by US Federal Communications Commission to perform electromagnetic emission measurements. The recognition numbers of test site are 832625.</p> <p>The laboratory is a testing organization accredited by China National Accreditation Service for Conformity Assessment (CNAS) according to ISO/IEC 17025. The accreditation certificate number is L6791.</p>
Description	All measurement facilities used to collect the measurement data are located at Block B, FL 1, Baisha Science and Technology Park, Shahe Xi Road, Nanshan District, Shenzhen, Guangdong Province, P. R. China 518055

## 1.3 Test Environment Condition

Ambient Temperature	21 to 23°C
Ambient Relative Humidity	40 to 52%
Ambient Pressure	100 to 102 KPa

## 1.4 Announce

- (1) The test report reference to the report template version v 2.2.
- (2) The test report is invalid if not marked with the signatures of the persons responsible for preparing and approving the test report.
- (3) The test report is invalid if there is any evidence and/or falsification.
- (4) The results documented in this report apply only to the tested sample, under the conditions and modes of operation as described herein.
- (5) This document may not be altered or revised in any way unless done so by BALUN and all revisions are duly noted in the revisions section.
- (6) Content of the test report, in part or in full, cannot be used for publicity and/or promotional purposes without prior written approval from the laboratory.

## 2 PRODUCT INFORMATION

### 2.1 Applicant Information

Applicant	Shenzhen Sang Fei Consumer Communications Co.,Ltd
Address	11 Science and Technology Road, Shenzhen Hi-tech Industrial Park Nanshan District, Shenzhen city, Guangdong province, 518057, China

### 2.2 Manufacturer Information

Manufacturer	Wuhan Admiral Technology Ltd
Address	No. 11, Zhuankou District, Wuhan economic and Technology Development Zone, Hubei, China

### 2.3 Factory Information

Factory	Huizhou Qiaoxing Electronics Technology Co., LTD
Address	Qiaoxing Tech Industrial Park, Tangquan, Huizhou, Guangdong, China

### 2.4 General Description for Equipment under Test (EUT)

EUT Type	Smartphone
Model Name Under Test	O7
Series Model Name	N/A
Description of Model Name Differentiation	N/A
Hardware Version	M7_V1.03
Software Version	AOC_O7_1646_V01_CP
Dimensions (Approx.)	Please refer to the report of BL-SZ16B0295-AW.
Weight (Approx.)	N/A
Network and Wireless connectivity	2G Network GSM 850/1900;GPRS Class 12; EDGE Class 12; 3G Network WCDMA Band 2/5, HSDPA, HSUPA; 4G Network FDD LTE Band 2/4/7; WIFI 802.11b, 802.11g and 802.11n (HT20/40); Bluetooth, GPS

## 2.5 Ancillary Equipment

Ancillary Equipment 1	Battery	
	Brand Name	AOC
	Model No.	O7
	Serial No.	N/A
	Capacitance	4000 mAh
	Rated Voltage	3.8 V
	Limit Charge Voltage	4.35 V
Ancillary Equipment 2	Adapter 1	
	Brand Name	AOC
	Model Name	TPA-59050150VU (EU) <sup>Note</sup>
	Rated Input	100-240 V ~, 50/60 Hz, 300 mA
	Rated Output	5 V =, 1500 mA
Ancillary Equipment 3	Adapter 2	
	Brand Name	AOC
	Model Name	TPA-46050150UU (US Plug) <sup>Note</sup>
	Rated Input	100-240 V ~, 50/60 Hz, 300 mA
	Rated Output	5 V =, 1500 mA
Ancillary Equipment 4	USB Cable	
	Length(Approx.)	100 cm



## 2.6 Technical Information

The requirement for the following technical information of the EUT was tested in this report:

Operating Mode	GSM, WCDMA, FDD-LTE, 2.4G WLAN, Bluetooth		
Frequency Range	GSM 850	TX: 824 MHz ~ 849 MHz	RX: 869 MHz ~ 894 MHz
	GSM 1900	TX: 1850 MHz ~ 1910 MHz	RX: 1930 MHz ~ 1990 MHz
	WCDMA Band 2	TX: 1850 MHz ~ 1910 MHz	RX: 1930 MHz ~ 1990 MHz
	WCDMA Band 5	TX: 824 MHz ~ 849 MHz	RX: 869 MHz ~ 894 MHz
	LTE Band 2	TX: 1850 MHz ~ 1910 MHz	RX: 1930 MHz ~ 1990 MHz
	LTE Band 4	TX: 1710 MHz ~ 1755 MHz	RX: 2110 MHz ~ 2155 MHz
	LTE Band 7	TX: 2500 MHz ~ 2570 MHz	RX: 2620 MHz ~ 2690 MHz
	802.11b/g /n(HT20/HT40)	2400~2483.5 MHz	
	Bluetooth	2400~2483.5 MHz	
Antenna Type	WWAN: PIFA Antenna WLAN/ Bluetooth: PIFA Antenna		
DTM	Not Support		
Hotspot Function	Support		
Power Reduction	Not Support		
Exposure Category	General Population/Uncontrolled exposure		
EUT Stage	Portable Device		
Product	Type		
	<input checked="" type="checkbox"/> Production unit	<input type="checkbox"/> Identical prototype	

### 3 SUMMARY OF TEST RESULTS

#### 3.1 Test Standards

No.	Identity	Document Title
1	47 CFR Part 2	Frequency Allocations and Radio Treaty Matters; General Rules and Regulations
2	ANSI/IEEE Std. C95.1-1999	IEEE Standard for Safety Levels with Respect to Human Exposure to Radio Frequency Electromagnetic Fields, 3 kHz to 300 GHz
3	IEEE Std. 1528-2013	Recommended Practice for Determining the Peak Spatial-Average Specific Absorption Rate (SAR) in the Human Head from Wireless Communications Devices: Measurement Techniques
4	FCC KDB 447498 D01 v06	Mobile and Portable Device RF Exposure Procedures and Equipment Authorization Policies
5	FCC KDB 941225 D01 v03r01	3G SAR MEAUREMENT PROCEDURES
6	FCC KDB 941225 D05 v02r04	SAR Evaluation Considerations for LTE Devices
7	FCC KDB 941225 D06 v02r01	SAR Evaluation Procedures for Portable Devices with Wireless Router Capabilities
8	FCC KDB 865664 D01 v01r04	SAR Measurement 100 MHz to 6 GHz
9	FCC KDB 865664 D02 v01r02	RF Exposure Reporting
10	FCC KDB 648474 D04 v01r03	SAR Evaluation Considerations for Wireless Handsets

#### 3.2 Device Category and SAR Limit

This device belongs to portable device category because its radiating structure is allowed to be used within 20 centimeters of the body of the user. Limit for General Population/Uncontrolled exposure should be applied for this device, it is 1.6 W/kg as averaged over any 1 gram of tissue.

Table of Exposure Limits:

Body Position	SAR Value (W/Kg)	
	General Population/ Uncontrolled Exposure	Occupational/ Controlled Exposure
Whole-Body SAR (averaged over the entire body)	0.08	0.4
Partial-Body SAR (averaged over any 1 gram of tissue)	1.60	8.0
SAR for hands, wrists, feet and ankles (averaged over any 10 grams of tissue)	4.0	20.0

## NOTE:

**General Population/Uncontrolled:** Locations where there is the exposure of individuals who have no knowledge or control of their exposure. General population/uncontrolled exposure limits are applicable to situations in which the general public may be exposed or in which persons who are exposed as a consequence of their employment may not be made fully aware of the potential for exposure or cannot exercise control over their exposure. Members of the general public would come under this category when exposure is not employment-related; for example, in the case of a wireless transmitter that exposes persons in its vicinity.

**Occupational/Controlled:** Locations where there is exposure that may be incurred by persons who are aware of the potential for exposure, In general, occupational/controlled exposure limits are applicable to situations in which persons are exposed as a consequence of their employment, who have been made fully aware of the potential for exposure and can exercise control over their exposure. This exposure category is also applicable when the exposure is of a transient nature due to incidental passage through a location where the exposure levels may be higher than the general population/uncontrolled limits, but the exposed person is fully aware of the potential for exposure and can exercise control over his or her exposure by leaving the area or by some other appropriate means.

### 3.3 Test Result Summary

#### 3.3.1 Highest SAR (1 g Value)

Band	Maximum Scaled SAR (W/kg)			Maximum Report SAR (W/kg)			Limit (W/kg)
	Head	Body-worn	Hotspot	Head	Body-worn	Hotspot	
GSM 850	0.253	0.503	0.503	0.388	0.643	0.898	1.6
GSM 1900	0.183	<b>0.643</b>	<b>0.898</b>				
WCDMA Band 2	0.346	0.582	0.869				
WCDMA Band 5	0.305	0.368	0.368				
LTE Band 2	0.282	0.504	0.578				
LTE Band 4	0.325	0.508	0.508				
LTE Band 7	<b>0.388</b>	0.314	0.731				
2.4G WLAN	0.419	0.110	0.110				
Verdict	Pass						

#### 3.3.2 Highest Simultaneous SAR

Position	Simultaneous Configuration	Simultaneous SAR (W/kg)	Limit (W/kg)	Verdict
Head	LTE QPSK + 2.4G WLAN	0.807	1.6	Pass
Body-worn	GSM Voice + Bluetooth	0.789	1.6	Pass
Hotspot Mode	GSM DATA + Bluetooth	1.044	1.6	Pass

### 3.4 Test Uncertainty

According to KDB 865664 D01, when the highest measured 1 g SAR within a frequency band is  $< 1.5$  W/kg, the extensive SAR measurement uncertainty analysis is not required in SAR reports submitted for equipment approval.

The maximum 1 g SAR for the EUT in this report is 0.898 W/kg, which is lower than 1.5 W/kg, so the the extensive SAR measurement uncertainty analysis is not required in this report.

## 4 SAR MEASUREMENT SYSTEM

### 4.1 Definition of Specific Absorption Rate (SAR)

SAR is related to the rate at which energy is absorbed per unit mass in an object exposed to a radio field. The SAR distribution in a biological body is complicated and is usually carried out by experimental techniques or numerical modeling. The standard recommends limits for two tiers of groups, occupational/controlled and general population/uncontrolled, based on a person's awareness and ability to exercise control over his or her exposure. In general, occupational / controlled exposure limits are higher than the limits for general population /uncontrolled.

The SAR definition is the time derivative (rate) of the incremental energy ( $dW$ ) absorbed by (dissipated in) an incremental mass ( $dm$ ) contained in a volume element ( $dv$ ) of a given density ( $\rho$ ). The equation description is as below:

$$\text{SAR} = \frac{d}{dt} \left( \frac{dW}{dm} \right) = \frac{d}{dt} \left( \frac{dW}{\rho dv} \right)$$

SAR is expressed in units of Watts per kilogram (W/kg) SAR measurement can be related to the electrical field in the tissue by

$$\text{SAR} = \frac{\sigma E^2}{\rho}$$

Where:  $\sigma$  is the conductivity of the tissue,

$\rho$  is the mass density of the tissue and  $E$  is the RMS electrical field strength.

### 4.2 SATIMO SAR System

#### 4.2.1 SATIMO SAR System Diagram

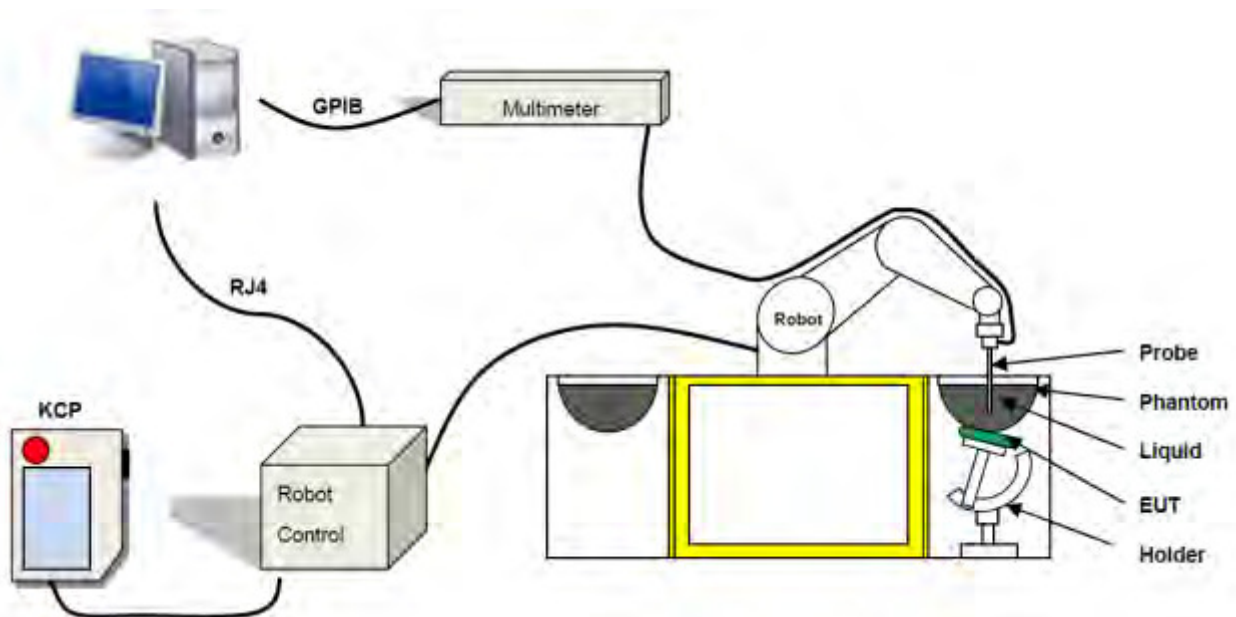

These measurements were performed with the automated near-field scanning system OPENSAR from SATIMO. The system is based on a high precision robot (working range: 850 mm), which positions the probes with a positional repeatability of better than  $\pm 0.02$  mm. Special E- and H-field probes have been developed for measurements close to material discontinuity, the sensors of which are directly loaded with a Schottky diode and connected via highly resistive lines to the data acquisition unit.

The SAR measurements were conducted with dosimetric probe (manufactured by SATIMO), designed in the classical triangular configuration and optimized for dosimetric evaluation. The probe has been calibrated according to the procedure described in SAR standard with accuracy of better than  $\pm 10\%$ . The spherical isotropy was evaluated with the procedure described in SAR standard and found to be better than  $\pm 0.25$  dB. The phantom used was the SAM Phantom as described in FCC supplement C, IEEE P1528.

#### 4.2.2 Robot

The SATIMO SAR system uses the high precision robots from KUKA. For the 6-axis controller system, the robot controller version (KUKA) from KUKA is used. The KUKA robot series have many features that are important for our application:



- High precision (repeatability  $\pm 0.035$  mm)
- High reliability (industrial design)
- Jerk-free straight movements
- Low ELF interference (the closed metallic construction shields against motor control fields)

#### 4.2.3 E-Field Probe

For the measurements the Specific Dosimetric E-Field Probe SN 34/15 EPGO 265 with following specifications is used

- Dynamic range: 0.01-100 W/kg
- Tip Diameter : 2.5 mm
- Lower detection limit : 7 mW/kg  
(repeatability better than  $\pm 1$ mm)
- Probe linearity:  $\pm 0.07$  dB
- Calibration range: 450 MHz to 5800 MHz for head & body simulating liquid.

Angle between probe axis (evaluation axis) and surface normal line: less than 30°



**E-Field Probe Calibration Process**

Probe calibration is realized, in compliance with CENELEC EN 62209-1/-2 and IEEE 1528 std, with CALISAR, Antennessa proprietary calibration system. The calibration is performed with the IEC62209-1/2 annexe technique using reference guide at the five frequencies.

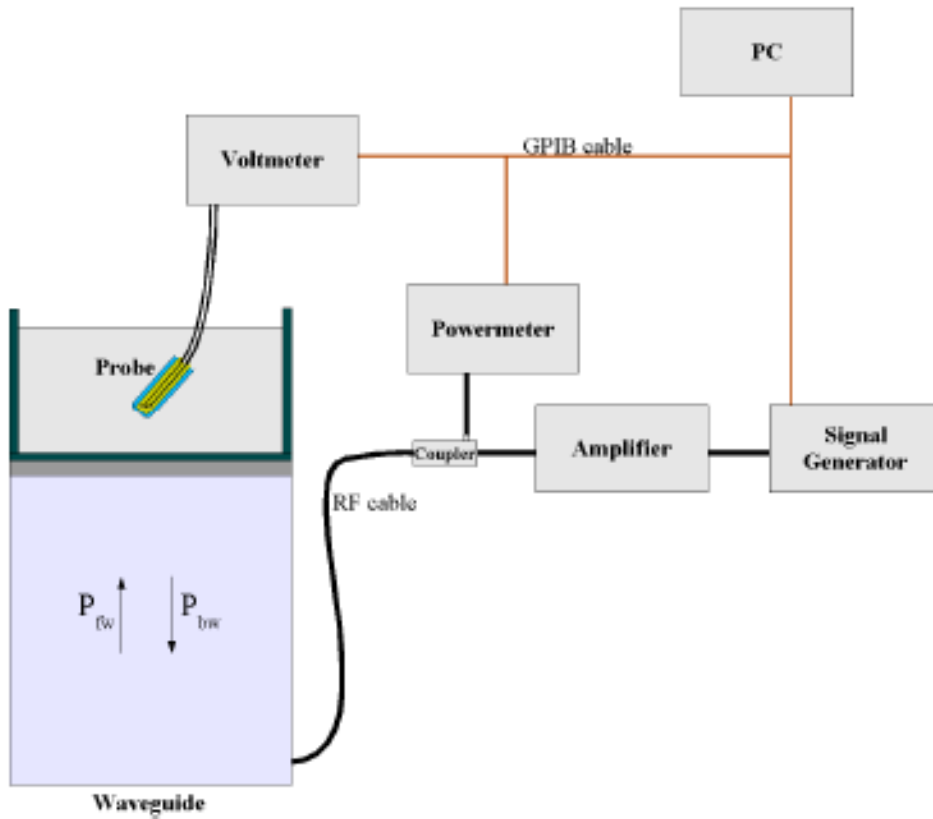

$$SAR = \frac{4(P_{fw} - P_{bw})}{ab\sigma} \cos^2 \left( \pi \frac{y}{a} \right) c^{(2\pi/\sigma)}$$

Where :

- P<sub>fw</sub> = Forward Power
- P<sub>bw</sub> = Backward Power
- a and b = Waveguide Dimensions
- l = Skin Depth

**Keithley configuration**

Rate = Medium; Filter =ON; RDGS=10; FILTER TYPE =MOVING AVERAGE; RANGE AUTO After each calibration, a SAR measurement is performed on a validation dipole and compared with a NPL calibrated probe, to verify it.



The calibration factors, CF(N), for the 3 sensors corresponding to dipole 1, dipole 2 and dipole 3 are:

$$CF(N)=SAR(N)/V_{lin}(N) \quad (N=1,2,3)$$

The linearised output voltage  $V_{lin}(N)$  is obtained from the displayed output voltage  $V(N)$  using

$$V_{lin}(N)=V(N)*(1+V(N)/DCP(N)) \quad (N=1,2,3)$$

Where the DCP is the diode compression point in mV.

#### 4.2.4 Phantoms

For the measurements the Specific Anthropomorphic Mannequin (SAM) defined by the IEEE SCC-34/SC2 group is used. The phantom is a polyurethane shell integrated in a wooden table. The thickness of the phantom amounts to 2mm +/- 0.2mm. It enables the dosimetric evaluation of left and right phone usage and includes an additional flat phantom part for the simplified performance check. The phantom set-up includes a cover, which prevents the evaporation of the liquid.

Photo of Phantom SN 30/13 SAM103



Photo of Phantom SN 30/13 SAM104



Serial Number	Positionner Material	Permittivity	Loss Tangent
SN 30/13 SAM103	Gelcoat with fiberglass	3.4	0.02
SN 30/13 SAM104	Gelcoat with fiberglass	3.4	0.02



#### 4.2.5 Device Holder

The SAR in the phantom is approximately inversely proportional to the square of the distance between the source and the liquid surface. For a source at 5 mm distance, a positioning uncertainty of  $\pm 0.5$  mm would produce a SAR uncertainty of  $\pm 20$  %. Accurate device positioning is therefore crucial for accurate and repeatable measurements. The positions in which the devices must be measured are defined by the standards.



Serial Number	Holder Material	Permittivity	Loss Tangent
SN 25/13 MSH87	Deirin	3.7	0.005
SN 25/13 MSH88	Deirin	3.7	0.005

The positioning system allows obtaining cheek and tilting position with a very good accuracy. In compliance with CENELEC, the tilt angle uncertainty is lower than  $1^\circ$ .

#### 4.2.6 Simulating Liquid

For SAR measurement of the field distribution inside the phantom, the phantom must be filled with homogeneous tissue simulating liquid to a depth of at least 15 cm. For head SAR testing, the liquid height from the ear reference point (ERP) of the phantom to the liquid top surface is larger than 15 cm. For body SAR testing, the liquid height from the center of the flat phantom to the liquid top surface is larger than 15 cm. The nominal dielectric values of the tissue simulating liquids in the phantom and the tolerance of 5%.

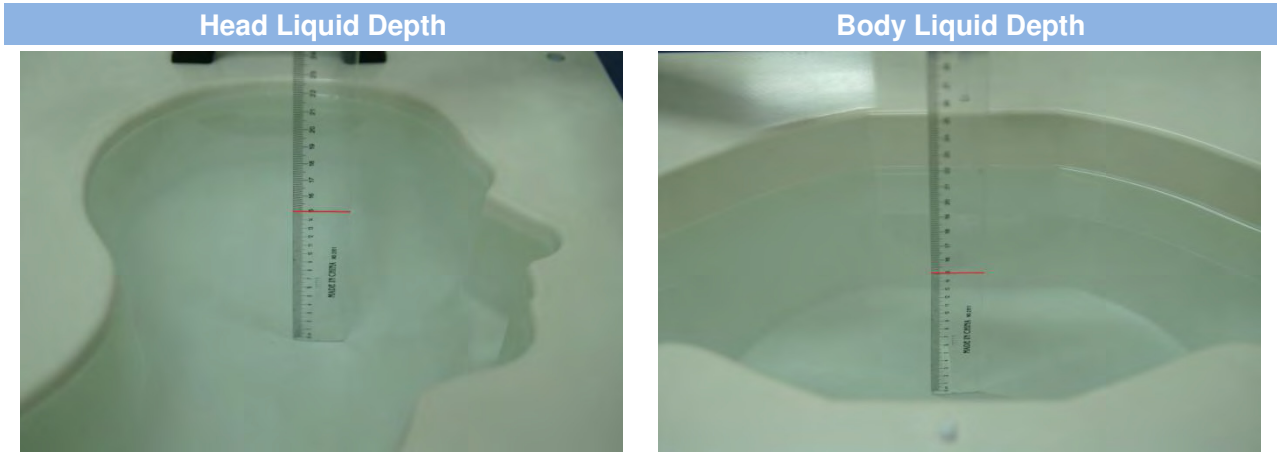

The following table gives the recipes for tissue simulating liquid and the theoretical Conductivity/Permittivity.

Head (Reference IEEE1528)								
Frequency (MHz)	Water (%)	Sugar (%)	Cellulose (%)	Salt (%)	Preventol (%)	DGBE (%)	Conductivity $\sigma$ (S/m)	Permittivity $\epsilon$
750	41.1	57.0	0.2	1.4	0.2	0	0.89	41.9
835	40.3	57.9	0.2	1.4	0.2	0	0.90	41.5
900	40.3	57.9	0.2	1.4	0.2	0	0.97	41.5
1800, 1900, 2000	55.2	0	0	0.3	0	44.5	1.4	40.0
2450	55.0	0	0	0.1	0	44.9	1.80	39.2
2600	54.9	0	0	0.1	0	45.0	1.96	39.0
Frequency(MHz)	Water (%)	Hexyl Carbitol (%)			Triton X-100 (%)		Conductivity $\sigma$ (S/m)	Permittivity $\epsilon$
5200	62.52	17.24			17.24		4.66	36.0
5800	62.52	17.24			17.24		5.27	35.3
Body (From instrument manufacturer)								
Frequency (MHz)	Water (%)	Sugar (%)	Cellulose (%)	Salt (%)	Preventol (%)	DGBE (%)	Conductivity $\sigma$ (S/m)	Permittivity $\epsilon$
750	51.7	47.2	0	0.9	0.1	0	0.96	55.5
835	50.8	48.2	0	0.9	0.1	0	0.97	55.2
900	50.8	48.2	0	0.9	0.1	0	1.05	55.0
1800, 1900, 2000	70.2	0	0	0.4	0	29.4	1.52	53.3
2450	68.6	0	0	0.1	0	31.3	1.95	52.7
2600	68.2	0	0	0.1	0	31.7	2.16	52.5

Frequency(MHz)	Water	DGBE (%)	Salt (%)	Conductivity $\sigma$ (S/m)	Permittivity $\epsilon$
5200	78.60	21.40	/	5.54	47.86
5800	78.50	21.40	0.1	6.0	48.20

## 5 SYSTEM VERIFICATION

### 5.1 Antenna Port Test Requirement

The SATIMO SAR system is equipped with one or more system validation kits. These units together with the predefined measurement procedures within the SATIMO software enable the user to conduct the system performance check and system validation. System validation kit includes a dipole, tripod holder to fix it underneath the flat phantom and a corresponding distance holder.

### 5.2 Purpose of System Check

The system performance check verifies that the system operates within its specifications. System and operator errors can be detected and corrected. It is recommended that the system performance check be performed prior to any usage of the system in order to guarantee reproducible results. The system performance check uses normal SAR measurements in a simplified setup with a well characterized source. This setup was selected to give a high sensitivity to all parameters that might fail or vary over time. The system check does not intend to replace the calibration of the components, but indicates situations where the system uncertainty is exceeded due to drift or failure.

### 5.3 System Check Setup

In the simplified setup for system evaluation, the EUT is replaced by a calibrated dipole and the power source is replaced by a continuous wave that comes from a signal generator. The calibrated dipole must be placed beneath the flat phantom section of the SAM twin phantom with the correct distance holder. The distance holder should touch the phantom surface with a light pressure at the reference marking and be oriented parallel to the long side of the phantom. The equipment setup is shown below:

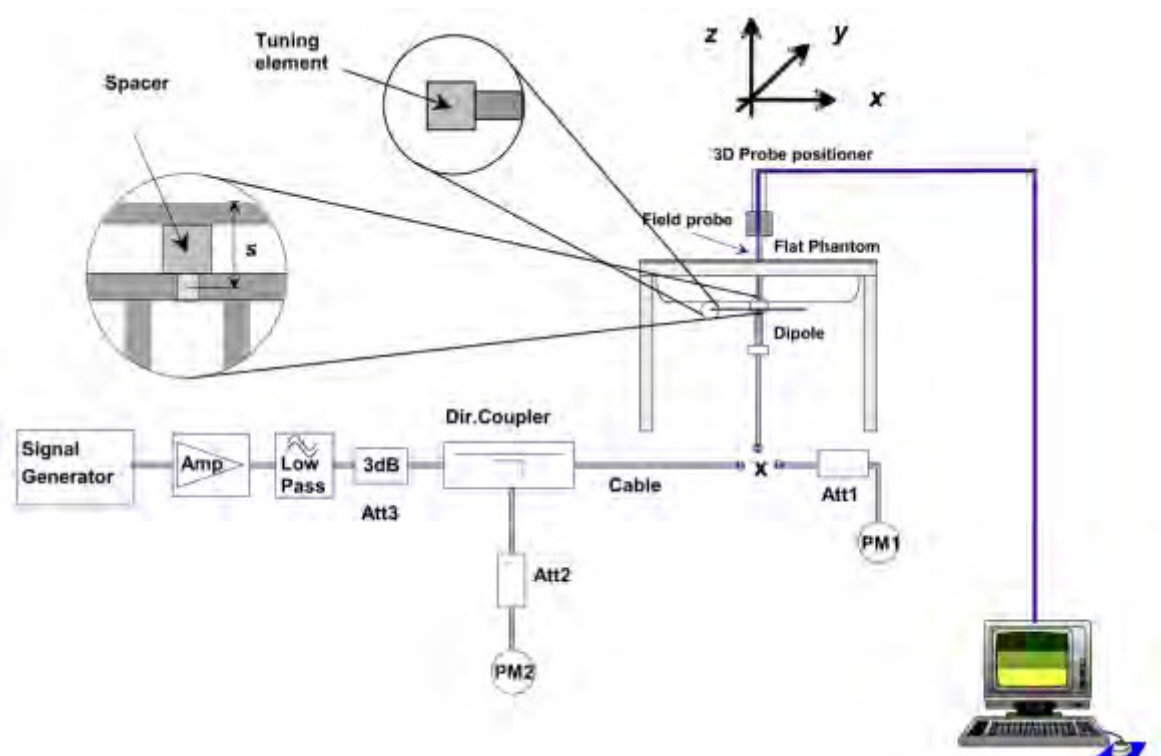

## 6 EUT TEST POSITION CONFIGURATIONS

According to KDB 648474 D04 Handset, handsets are tested for SAR compliance in head, body-worn accessory and other use configurations described in the following subsections.

### 6.1 Head Exposure Conditions

Head exposure is limited to next to the ear voice mode operations. Head SAR compliance is tested according to the test positions defined in IEEE Std 1528-2013 using the SAM phantom illustrated as below.

#### 6.1.1 Define two imaginary lines on the handset

- (a) The vertical center line passes through two points on the front side of the handset - the midpoint of the width  $w_t$  of the handset at the level of the acoustic output, and the midpoint of the width  $w_b$  of the bottom of the handset.
- (b) The horizontal line is perpendicular to the vertical centerline and passes through the center of the acoustic output. The horizontal line is also tangential to the face of the handset at point A.
- (c) The two lines intersect at point A. Note that for many handsets, point A coincides with the center of the acoustic output; however, the acoustic output may be located elsewhere on the horizontal line. Also note that the vertical centerline is not necessarily parallel to the front face of the handset, especially for clamshell handsets, handsets with flip covers, and other irregularly shaped handsets.

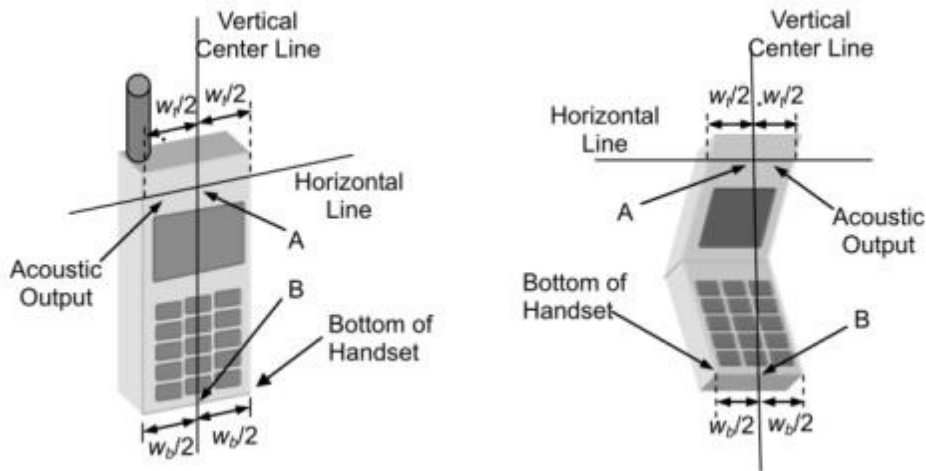

#### 6.1.2 Cheek Position

- (a) To position the device with the vertical center line of the body of the device and the horizontal line crossing the center piece in a plane parallel to the sagittal plane of the phantom. While maintaining the device in this plane, align the vertical center line with the reference plane containing the three ear and mouth reference point (M: Mouth, RE: Right Ear, and LE: Left Ear) and align the center of the ear piece with the line RE-LE.
- (b) To move the device towards the phantom with the ear piece aligned with the line LE-RE until the phone touched the ear. While maintaining the device in the reference plane and maintaining the phone contact with the ear, move the bottom of the phone until any point on the front side is in contact with the cheek of the phantom or until contact with the ear is lost.





### 6.1.3 Tilted Position

- (a) To position the device in the “cheek” position described above.
- (b) While maintaining the device the reference plane described above and pivoting against the ear, moves it outward away from the mouth by an angle of 15 degrees or until contact with the ear is lost.



## 6.2 Body-worn Position Conditions

Body-worn accessory exposure is typically related to voice mode operations when handsets are carried in body-worn accessories. The body-worn accessory procedures in KDB 447498 are used to test for body-worn accessory SAR compliance, without a headset connected to it. This enables the test results for such configuration to be compatible with that required for hotspot mode when the body-worn accessory test separation distance is greater than or equal to that required for hotspot mode. When the reported SAR for a body-worn accessory, measured without a headset connected to the handset, is  $> 1.2$  W/kg, the highest reported SAR configuration for that wireless mode and frequency band should be repeated for that body-worn accessory with a headset attached to the handset.

Body-worn accessories that do not contain metallic or conductive components may be tested according to worst-case exposure configurations, typically according to the smallest test separation distance required for the group of body-worn accessories with similar operating and exposure characteristics. All body-worn accessories containing metallic components are tested in conjunction with the host device.

Body-worn accessory SAR compliance is based on a single minimum test separation distance for all wireless and operating modes applicable to each body-worn accessory used by the host, and according to the relevant voice and/or data mode transmissions and operations. If a body-worn accessory supports voice only operations in its normal and expected use conditions, testing of data mode for body-worn compliance is not required. A conservative minimum test separation distance for supporting off-the-shelf body-worn accessories that may be

acquired by users of consumer handsets is used to test for body-worn accessory SAR compliance. This distance is determined by the handset manufacturer, according to the requirements of Supplement C 01-01. Devices that are designed to operate on the body of users using lanyards and straps, or without requiring additional body-worn accessories, will be tested using a conservative minimum test separation distance  $\leq 5$  mm to support compliance.

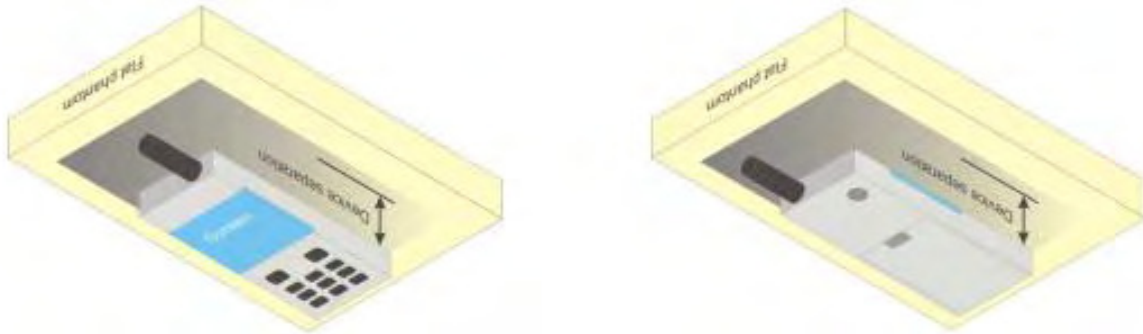

### 6.3 Hotspot Mode Exposure Position Conditions

For handsets that support hotspot mode operations, with wireless router capabilities and various web browsing functions, the relevant hand and body exposure conditions are tested according to the hotspot SAR procedures in KDB 941225. A test separation distance of 10 mm is required between the phantom and all surfaces and edges with a transmitting antenna located within 25 mm from that surface or edge. When the form factor of a handset is smaller than 9 cm x 5 cm, a test separation distance of 5 mm (instead of 10 mm) is required for testing hotspot mode. When the separation distance required for body-worn accessory testing is larger than or equal to that tested for hotspot mode, in the same wireless mode and for the same surface of the phone, the hotspot mode SAR data may be used to support body-worn accessory SAR compliance for that particular configuration (surface).

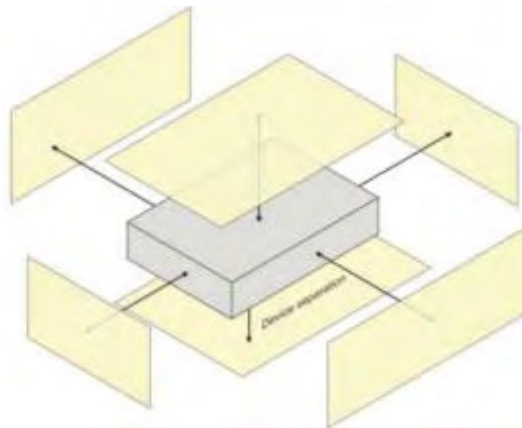

## 7 SAR MEASUREMENT PROCEDURES

### 7.1 SAR Measurement Process Diagram

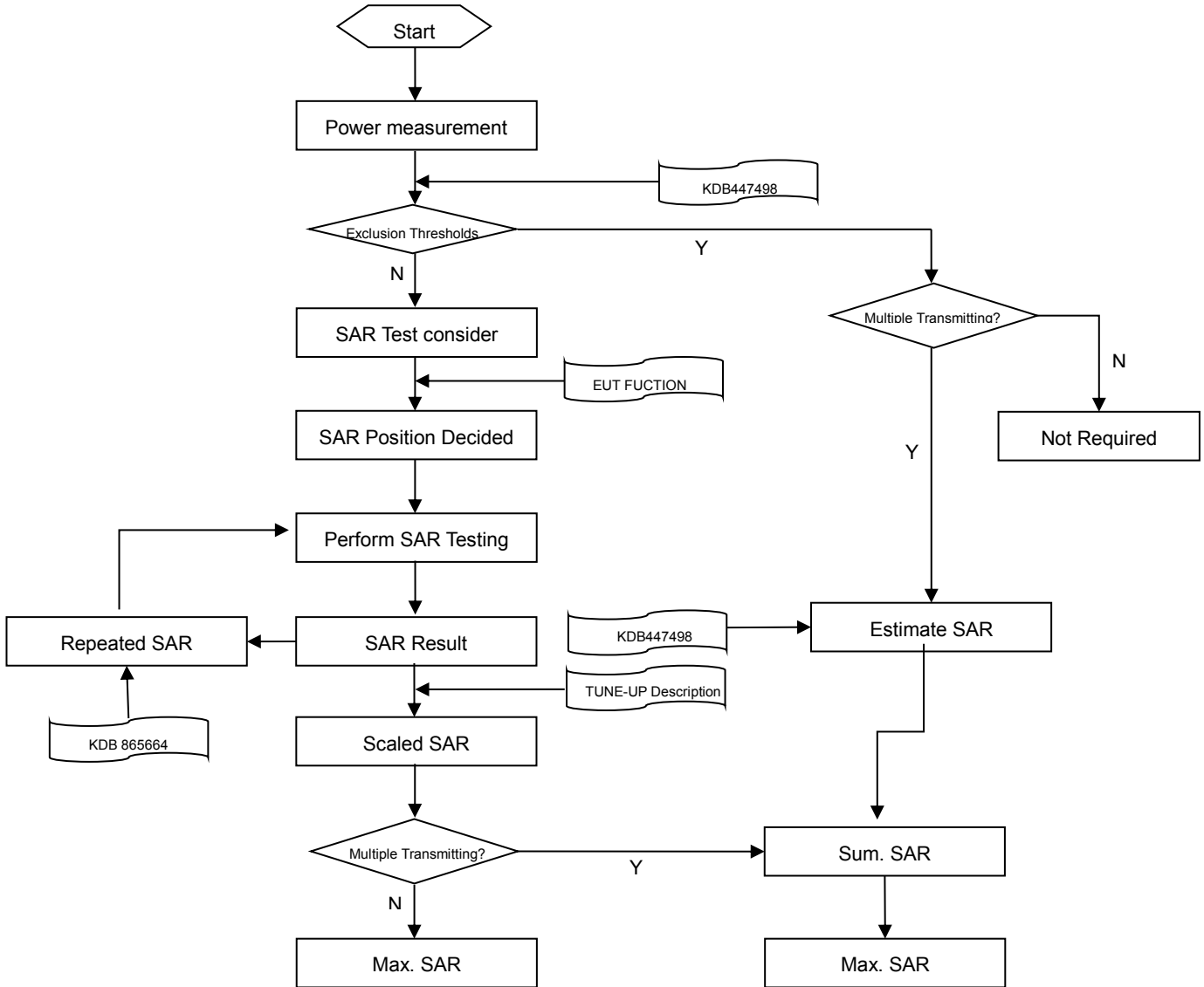

## 7.2 SAR Scan General Requirements

Probe boundary effect error compensation is required for measurements with the probe tip closer than half a probe tip diameter to the phantom surface. Both the probe tip diameter and sensor offset distance must satisfy measurement protocols; to ensure probe boundary effect errors are minimized and the higher fields closest to the phantom surface can be correctly measured and extrapolated to the phantom surface for computing 1-g SAR. Tolerances of the post-processing algorithms must be verified by the test laboratory for the scan resolutions used in the SAR measurements, according to the reference distribution functions specified in IEEE Std 1528-2013.

		≤3GHz	>3GHz
Maximum distance from closest measurement point (geometric center of probe sensors) to phantom surface		5±1 mm	$\frac{1}{2} \cdot \delta \cdot \ln(2) \pm 0.5$ mm
Maximum probe angle from probe axis to phantom surface normal at the measurement location		30°±1°	20°±1°
Maximum area scan spatial resolution: $\Delta x$ Area , $\Delta y$ Area		≤ 2 GHz: ≤ 15 mm 2 – 3 GHz: ≤ 12 mm	3–4 GHz: ≤ 12 mm 4 – 6 GHz: ≤ 10 mm
		When the x or y dimension of the test device, in the measurement plane orientation, is smaller than the above, the measurement resolution must be ≤ the corresponding x or y dimension of the test device with at least one measurement point on the test device.	
Maximum zoom scan spatial resolution: $\Delta x$ Zoom , $\Delta y$ Zoom		≤ 2 GHz: ≤ 8 mm 2 – 3 GHz: ≤ 5 mm*	3–4 GHz: ≤ 5 mm* 4 – 6 GHz: ≤ 4 mm*
Maximum zoom scan spatial resolution, normal to phantom surface	uniform grid: $\Delta z$ Zoom (n)	≤ 5 mm	3–4 GHz: ≤ 4 mm
			4–5 GHz: ≤ 3 mm
			5–6 GHz: ≤ 2 mm
	graded grid	$\Delta z$ Zoom (1): between 1st two points closest to phantom surface  $\Delta z$ Zoom (n>1): between subsequent points	≤ 4 mm
4–5 GHz: ≤ 2.5 mm			
		≤ 1.5 · $\Delta z$ Zoom (n-1)	
Minimum zoom scan volume	x, y, z	≥30 mm	3–4 GHz: ≥ 28 mm
			4–5 GHz: ≥ 25 mm
			5–6 GHz: ≥ 22 mm
<b>Note:</b> 1. $\delta$ is the penetration depth of a plane-wave at normal incidence to the tissue medium; see draft standard IEEE P1528-2011 for details. 2. * When zoom scan is required and the reported SAR from the area scan based 1-g SAR estimation procedures of KDB 447498 is ≤ 1.4 W/kg, ≤ 8 mm, ≤ 7 mm and ≤ 5 mm zoom scan resolution may be applied, respectively, for 2 GHz to 3GHz, 3 GHz to 4 GHz and 4 GHz to 6 GHz.			

### 7.3 SAR Measurement Procedure

The following steps are used for each test position

- Establish a call with the maximum output power with a base station simulator. The connection between the mobile and the base station simulator is established via air interface
- Measurement of the local E-field value at a fixed location. This value serves as a reference value for calculating a possible power drift.
- Measurement of the SAR distribution with a grid of 8 to 16mm \* 8 to 16 mm and a constant distance to the inner surface of the phantom. Since the sensors cannot directly measure at the inner phantom surface, the values between the sensors and the inner phantom surface are extrapolated. With these values the area of the maximum SAR is calculated by an interpolation scheme.
- Around this point, a cube of 30 \* 30 \* 30 mm or 32 \* 32 \* 32 mm is assessed by measuring 5 or 8 \* 5 or 8\*4 or 5 mm. With these data, the peak spatial-average SAR value can be calculated.

### 7.4 Area & Zoom Scan Procedures

First Area Scan is used to locate the approximate location(s) of the local peak SAR value(s). The measurement grid within an Area Scan is defined by the grid extent, grid step size and grid offset. Next, in order to determine the EM field distribution in a three-dimensional spatial extension, Zoom Scan is required. The Zoom Scan is performed around the highest E-field value to determine the averaged SAR-distribution over 10 g. Area scan and zoom scan resolution setting follows KDB 865664 D01 quoted below.

When the 1-g SAR of the highest peak is within 2 dB of the SAR limit, additional zoom scans are required for other peaks within 2 dB of the highest peak that have not been included in any zoom scan to ensure there is no increase in SAR.

## 8 CONDUCTED RF OUTPUT POWER

### 8.1 GSM

GSM 850 Band	Burst Average Power(dBm)			Frame-averaged power(dBm)		
Channel	128	190	251	128	190	251
GSM (GMSK, 1-Slot)	31.82	31.79	31.78	<b>22.82</b>	22.79	22.78
GPRS (GMSK, 1-Slot)	32.34	32.43	32.46	23.34	23.43	23.46
GPRS (GMSK, 2-Slots)	31.90	31.95	31.97	25.90	25.95	25.97
GPRS (GMSK, 3-Slots)	30.38	30.46	30.46	26.12	26.20	26.20
GPRS (GMSK, 4-Slots)	29.33	29.36	29.40	26.33	26.36	<b>26.40</b>
EGPRS (8PSK, 1-Slot)	30.30	30.36	30.61	21.30	21.36	21.61
EGPRS (8PSK, 2-Slots)	29.19	29.34	29.43	23.19	23.34	<b>23.43</b>
EGPRS (8PSK, 3-Slots)	26.09	27.32	27.29	21.83	23.06	23.03
EGPRS (8PSK, 4-Slots)	25.93	26.02	26.24	22.93	23.02	23.24
GSM 1900 Band	Burst Average Power(dBm)			Frame-averaged power(dBm)		
Channel	512	661	810	512	661	810
GSM (GMSK, 1-Slot)	28.51	28.59	28.63	19.51	19.59	<b>19.63</b>
GPRS (GMSK, 1-Slot)	29.59	29.61	29.46	20.59	20.61	20.46
GPRS (GMSK, 2-Slots)	29.09	29.12	28.96	23.09	23.12	22.96
GPRS (GMSK, 3-Slots)	27.60	27.67	27.49	23.34	23.41	23.23
GPRS (GMSK, 4-Slots)	26.50	26.58	26.41	23.50	<b>23.58</b>	23.41
EGPRS (8PSK, 1-Slot)	29.57	29.69	29.33	20.57	20.69	20.33
EGPRS (8PSK, 2-Slots)	28.20	28.26	28.28	22.20	22.26	<b>22.28</b>
EGPRS (8PSK, 3-Slots)	25.91	26.22	25.93	21.65	21.96	21.67
EGPRS (8PSK, 4-Slots)	24.63	25.13	24.55	21.63	22.13	21.55

Note:

- SAR testing was performed on the maximum frame-Peaked power mode.
- The frame-averaged power is linearly proportion to the slot number configured and it is linearly scaled the maximum burst-averaged power based on time slots. The calculated method is shown as below:

Frame-averaged power = Burst averaged power (1 Tx Slot) - 9 dB

Frame-averaged power = Burst averaged power (2 Tx Slots) - 6 dB

Frame-averaged power = Burst averaged power (3 Tx Slots) - 4.26 dB

Frame-averaged power = Burst averaged power (4 Tx Slots) - 3 dB

## 8.2 WCDMA

WCDMA Band	Band 2			Band 5		
Channel	9262	9400	9538	4132	4183	4233
RMC 12.2Kbps	<b>22.68</b>	22.45	22.58	22.39	22.41	<b>22.50</b>
HSDPA Subtest-1	21.55	21.46	21.61	21.29	21.31	21.40
HSDPA Subtest-2	21.61	21.43	21.61	21.35	21.37	21.44
HSDPA Subtest-3	21.14	20.98	21.14	20.87	20.89	20.96
HSDPA Subtest-4	21.10	20.98	21.13	20.85	20.86	20.94
HSUPA Subtest-1	20.00	19.79	19.68	19.55	19.56	19.62
HSUPA Subtest-2	19.84	19.69	19.70	19.54	19.46	19.61
HSUPA Subtest-3	20.84	20.67	20.69	20.57	20.54	20.54
HSUPA Subtest-4	19.37	19.09	19.18	18.97	18.97	19.03
HSUPA Subtest-5	21.83	21.31	21.67	21.48	21.75	21.53

### 8.3 LTE

FDD LTE Band 2							
Bandwidth (MHz)	RB Set	Power (dBm)					
		QPSK			16QAM		
	Channel	18700	18900	19100	18700	18900	19100
20MHz	1 (RB_Pos:0)	<b>21.77</b>	21.74	21.67	21.19	21.15	20.97
	1 (RB_Pos:50)	21.71	21.72	21.56	21.16	21.13	20.88
	1 (RB_Pos:99)	21.72	21.66	21.66	21.19	21.03	20.90
	50 (RB_Pos:0)	20.67	20.69	20.55	19.68	19.72	19.54
	50 (RB_Pos:25)	20.65	20.66	20.50	19.68	19.69	19.51
	50 (RB_Pos:50)	<b>20.70</b>	20.64	20.55	19.70	19.68	19.54
	100 (RB_Pos:0)	20.66	20.63	20.54	19.68	19.67	19.54
Bandwidth (MHz)	RB Set	Power (dBm)					
		QPSK			16QAM		
	Channel	18675	18900	19125	18675	18900	19125
15MHz	1 (RB_Pos:0)	21.75	21.76	21.70	20.59	21.04	20.92
	1 (RB_Pos:38)	21.70	21.71	21.58	20.57	21.02	20.91
	1 (RB_Pos:74)	21.69	21.66	21.69	20.58	20.94	20.85
	36 (RB_Pos:0)	20.76	20.72	20.62	19.68	19.74	19.56
	36 (RB_Pos:20)	20.76	20.72	20.63	19.69	19.73	19.57
	36 (RB_Pos:39)	20.77	20.70	20.63	19.69	19.71	19.57
	75 (RB_Pos:0)	20.76	20.71	20.65	19.70	19.71	19.60
Bandwidth (MHz)	RB Set	Power (dBm)					
		QPSK			16QAM		
	Channel	18650	18900	19150	18650	18900	19150
10MHz	1 (RB_Pos:0)	21.70	21.73	21.55	20.57	21.01	20.56
	1 (RB_Pos:25)	21.70	21.70	21.57	20.56	21.00	20.60
	1 (RB_Pos:49)	21.71	21.69	21.63	20.59	21.00	20.55
	25 (RB_Pos:0)	20.64	20.67	20.55	19.66	19.71	19.67
	25 (RB_Pos:12)	20.64	20.64	20.56	19.66	19.70	19.67
	25 (RB_Pos:25)	20.66	20.64	20.58	19.66	19.69	19.67
	50 (RB_Pos:0)	20.64	20.65	20.58	19.63	19.69	19.64
Bandwidth (MHz)	RB Set	Power (dBm)					
		QPSK			16QAM		
	Channel	18625	18900	19175	18625	18900	19175
5MHz	1 (RB_Pos:0)	21.79	21.67	21.70	20.79	21.15	20.74
	1 (RB_Pos:13)	21.79	21.69	21.72	20.82	21.17	20.71
	1 (RB_Pos:24)	21.76	21.67	21.71	20.81	21.13	20.69
	12 (RB_Pos:0)	20.71	20.69	20.67	19.76	19.82	19.73
	12 (RB_Pos:6)	20.68	20.66	20.66	19.73	19.82	19.72
	12 (RB_Pos:13)	20.70	20.68	20.66	19.77	19.83	19.70
	25 (RB_Pos:0)	20.66	20.63	20.61	19.66	19.69	19.56
Bandwidth (MHz)	RB Set	Power (dBm)					
		QPSK			16QAM		



	Channel	18615	18900	19185	18615	18900	19185
3.0MHz	1 (RB_Pos:0)	21.67	21.62	21.57	20.47	20.91	20.58
	1 (RB_Pos:8)	21.73	21.69	21.66	20.54	21.00	20.62
	1 (RB_Pos:14)	21.67	21.61	21.62	20.46	20.94	20.52
	8 (RB_Pos:0)	20.69	20.69	20.69	19.76	19.74	19.68
	8 (RB_Pos:3)	20.72	20.70	20.71	19.78	19.74	19.71
	8 (RB_Pos:7)	20.69	20.68	20.69	19.74	19.76	19.67
	15 (RB_Pos:0)	20.67	20.62	20.64	19.66	19.66	19.58
Bandwidth (MHz)	RB Set	Power (dBm)					
		QPSK			16QAM		
	Channel	18607	18900	19193	18607	18900	19193
1.4MHz	1 (RB_Pos:0)	21.67	21.64	21.59	20.65	20.97	20.56
	1 (RB_Pos:3)	21.74	21.72	21.72	20.71	21.00	20.63
	1 (RB_Pos:5)	21.68	21.64	21.64	20.66	20.98	20.58
	3 (RB_Pos:0)	21.66	21.71	21.66	20.64	20.87	20.79
	3 (RB_Pos:1)	21.65	21.70	21.66	20.62	20.79	20.79
	3 (RB_Pos:3)	21.64	21.72	21.68	20.65	20.86	20.77
	6 (RB_Pos:0)	20.64	20.60	20.69	19.73	19.54	19.76

LTE Band 4							
Bandwidth (MHz)	RB Set	Power (dBm)					
		QPSK			16QAM		
	Channel	20050	20175	20300	20050	20175	20300
20 MHz	1 (RB_Pos:0)	21.56	21.61	<b>21.67</b>	20.99	20.86	20.98
	1 (RB_Pos:50)	21.53	21.56	21.52	20.88	20.92	20.80
	1 (RB_Pos:99)	21.53	21.50	21.35	20.91	20.86	20.52
	50 (RB_Pos:0)	20.45	20.53	<b>20.56</b>	19.47	19.53	19.55
	50 (RB_Pos:25)	20.42	20.47	20.46	19.41	19.50	19.42
	50 (RB_Pos:50)	20.41	20.49	20.33	19.41	19.51	19.27
	100 (RB_Pos:0)	20.40	20.48	20.44	19.43	19.48	19.44
15 MHz	Channel	20025	20175	20325	20025	20175	20325
	1 (RB_Pos:0)	21.50	21.62	21.62	20.37	20.83	20.92
	1 (RB_Pos:38)	21.48	21.55	21.47	20.30	20.82	20.65
	1 (RB_Pos:74)	21.46	21.50	21.34	20.26	20.77	20.45
	36 (RB_Pos:0)	20.49	20.57	20.52	19.45	19.58	19.45
	36 (RB_Pos:20)	20.52	20.54	20.46	19.47	19.57	19.38
	36 (RB_Pos:39)	20.51	20.50	20.39	19.43	19.55	19.28
75 (RB_Pos:0)	20.50	20.55	20.47	19.46	19.55	19.41	
10 MHz	Channel	20000	20175	20350	20000	20175	20350
	1 (RB_Pos:0)	21.44	21.58	21.40	20.39	20.81	20.36
	1 (RB_Pos:25)	21.51	21.54	21.28	20.33	20.80	20.20
	1 (RB_Pos:49)	21.51	21.54	21.21	20.30	20.81	20.08
	25 (RB_Pos:0)	20.47	20.46	20.30	19.48	19.49	19.38
	25 (RB_Pos:12)	20.45	20.45	20.22	19.47	19.50	19.28

	25 (RB_Pos:25)	20.42	20.46	20.17	19.42	19.49	19.24
	50 (RB_Pos:0)	20.43	20.46	20.24	19.43	19.47	19.26
5 MHz	Channel	19975	20175	20375	19975	20175	20375
	1 (RB_Pos:0)	21.59	21.52	21.34	20.63	20.94	20.30
	1 (RB_Pos:13)	21.61	21.53	21.31	20.64	20.98	20.25
	1 (RB_Pos:24)	21.59	21.51	21.25	20.63	20.95	20.22
	12 (RB_Pos:0)	20.50	20.51	20.27	19.60	19.64	19.27
	12 (RB_Pos:6)	20.50	20.51	20.25	19.58	19.64	19.24
	12 (RB_Pos:13)	20.51	20.51	20.21	19.58	19.64	19.22
	25 (RB_Pos:0)	20.46	20.45	20.17	19.49	19.50	19.09
	3 MHz	Channel	19965	20175	20385	19965	20175
1 (RB_Pos:0)		21.39	21.49	21.16	20.30	20.75	20.08
1 (RB_Pos:8)		21.51	21.53	21.19	20.38	20.80	20.09
1 (RB_Pos:14)		21.43	21.45	21.10	20.26	20.74	20.02
8 (RB_Pos:0)		20.49	20.51	20.24	19.62	19.57	19.22
8 (RB_Pos:3)		20.53	20.51	20.24	19.62	19.58	19.23
8 (RB_Pos:7)		20.50	20.51	20.23	19.58	19.57	19.19
15 (RB_Pos:0)		20.46	20.44	20.18	19.51	19.49	19.09
1.4 MHz	Channel	19957	20175	20393	19957	20175	20393
	1 (RB_Pos:0)	21.48	21.50	21.14	20.52	20.79	20.08
	1 (RB_Pos:3)	21.56	21.56	21.23	20.60	20.85	20.13
	1 (RB_Pos:5)	21.49	21.50	21.15	20.53	20.78	20.09
	3 (RB_Pos:0)	21.46	21.56	21.17	20.51	20.71	20.27
	3 (RB_Pos:1)	21.48	21.52	21.19	20.50	20.65	20.26
	3 (RB_Pos:3)	21.50	21.53	21.19	20.53	20.72	20.27
	6 (RB_Pos:0)	20.44	20.48	20.21	19.56	19.38	19.30

LTE Band 7							
Bandwidth (MHz)	RB Set	Power (dBm)					
		QPSK			16QAM		
20 MHz	Channel	20850	21100	21350	20850	21100	21350
	1 (RB_Pos:0)	21.16	20.83	<b>21.61</b>	20.46	20.05	20.93
	1 (RB_Pos:50)	21.20	20.49	20.59	20.76	19.94	20.01
	1 (RB_Pos:99)	21.32	21.39	21.14	20.84	20.84	20.50
	50 (RB_Pos:0)	20.26	19.52	20.11	19.32	18.60	19.14
	50 (RB_Pos:25)	20.26	19.56	19.72	19.33	18.71	18.82
	50 (RB_Pos:50)	<b>20.31</b>	19.91	19.69	19.35	19.13	18.87
	100 (RB_Pos:0)	20.27	19.70	19.92	19.32	18.86	19.09
15 MHz	Channel	20825	21100	21375	20825	21100	21375
	1 (RB_Pos:0)	21.22	20.86	21.19	19.93	20.00	20.41
	1 (RB_Pos:38)	21.24	20.63	20.51	20.18	19.98	19.88
	1 (RB_Pos:74)	21.30	21.27	21.10	20.23	20.62	20.42
	36 (RB_Pos:0)	20.27	19.67	19.79	19.24	18.76	18.82
	36 (RB_Pos:20)	20.28	19.69	19.61	19.24	18.86	18.70

	36 (RB_Pos:39)	20.31	19.92	19.70	19.28	19.14	18.87
	75 (RB_Pos:0)	20.32	19.74	19.71	19.29	18.93	18.86
10 MHz	Channel	20800	21100	21400	20800	21100	21400
	1 (RB_Pos:0)	21.26	21.02	20.97	20.04	20.15	19.83
	1 (RB_Pos:25)	21.26	20.91	20.81	20.15	20.25	19.81
	1 (RB_Pos:49)	21.29	21.09	21.11	20.18	20.43	20.16
	25 (RB_Pos:0)	20.21	19.95	19.86	19.26	19.02	19.07
	25 (RB_Pos:12)	20.21	19.98	19.86	19.29	19.17	19.10
	25 (RB_Pos:25)	20.27	20.06	19.99	19.34	19.26	19.24
	50 (RB_Pos:0)	20.27	19.98	19.91	19.28	19.13	19.12
5 MHz	Channel	20775	21100	21425	20775	21100	21425
	1 (RB_Pos:0)	21.17	21.43	21.55	20.67	20.46	20.58
	1 (RB_Pos:13)	21.19	21.34	21.33	20.72	20.31	20.33
	1 (RB_Pos:24)	21.20	21.42	21.52	20.72	20.46	20.54
	12 (RB_Pos:0)	20.23	20.41	20.26	19.40	19.52	19.43
	12 (RB_Pos:6)	20.22	20.33	20.23	19.40	19.40	19.42
	12 (RB_Pos:13)	20.24	20.41	20.43	19.43	19.52	19.57
	25 (RB_Pos:0)	20.21	20.34	20.29	19.31	19.39	19.46

## 8.4 WIFI

### 8.4.1 2.4GWIFI

Band (GHz)	Mode	Channel	Freq. (MHz)	Peak Power (dBm)	SAR Test Require.
2.4 (2.4~2.4835)	802.11b	1	2412	15.06	No
		6	2437	15.43	No
		11	2462	<b>15.65</b>	Yes
	802.11g	1	2412	19.30	No
		6	2437	19.66	No
		11	2462	19.92	No
	802.11n(HT20)	1	2412	18.33	No
		6	2437	18.69	No
		11	2462	19.03	No
	802.11n(HT40)	3	2422	18.57	No
		6	2437	19.07	No
		9	2452	19.18	No

## 8.5 Bluetooth

Mode	GFSK			$\pi/4$ -DQPSK		
Channel	0	39	78	0	39	78
Frequency (MHz)	2402	2441	2480	2402	2441	2480
Peak Power (dBm)	3.55	<b>8.33</b>	3.81	2.92	7.72	3.18
Mode	8-DPSK			BLE		
Channel	0	39	78	0	19	39
Frequency (MHz)	2402	2441	2480	2402	2440	2480
Peak Power (dBm)	3.05	7.86	3.30	-1.87	-1.37	-2.78

### 9 EUT ANTENNA LOCATION SKETCH

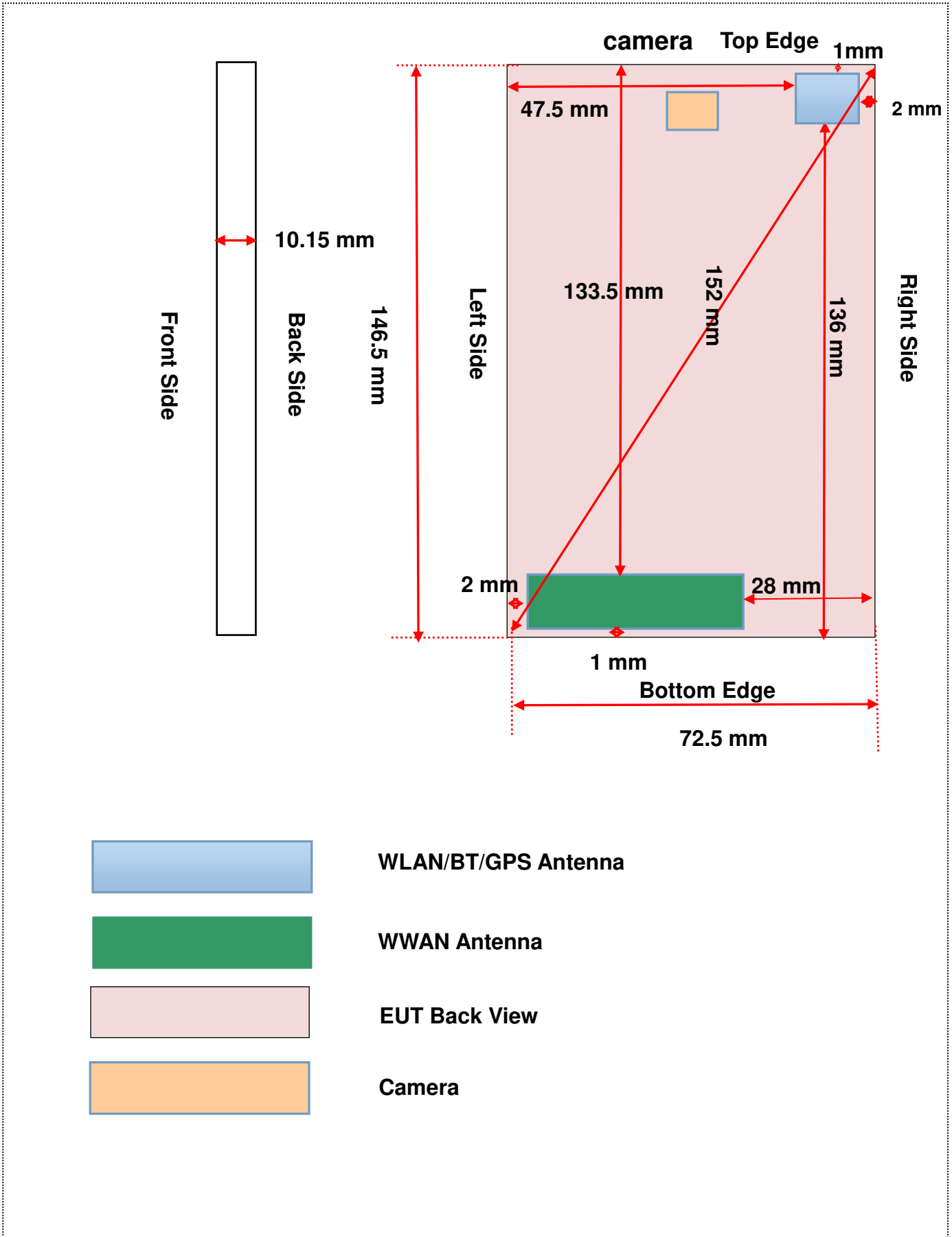

## 9.1 SAR Test Exclusion Consider Table

According with FCC KDB 447498 D01, Appendix A, <SAR Test Exclusion Thresholds for 100 MHz - 6 GHz and  $\leq 50$  mm> Table, this Device SAR test configurations consider as following :

Band	Mode	Max. Peak Power		Test Position Configurations					
		dBm	mW	Head	Front/ Back	Left Edge	Right Edge	Top Edge	Bottom Edge
GSM 850	Distance to User		<5mm	<5 mm	<5 mm	28 mm	133.5 mm	<5mm	
	Voice	31.95	1566.75	Yes	Yes	Yes	Yes	No	Yes
	Data	32.55	1798.87	Yes	Yes	Yes	Yes	No	Yes
GSM 1900	Distance to User		<5mm	<5 mm	<5 mm	28 mm	133.5 mm	<5mm	
	Voice	28.75	749.89	Yes	Yes	Yes	Yes	No	Yes
	Data	29.70	933.25	Yes	Yes	Yes	Yes	No	Yes
WCDMA Band 2	Distance to User		<5mm	<5 mm	<5 mm	28 mm	133.5 mm	<5mm	
	RMC	22.80	190.55	Yes	Yes	Yes	Yes	No	Yes
WCDMA Band 5	Distance to User		<5mm	<5 mm	<5 mm	28 mm	133.5 mm	<5mm	
	RMC	22.60	181.97	Yes	Yes	Yes	Yes	No	Yes
LTE Band 2	Distance to User		<5mm	<5 mm	<5 mm	28 mm	133.5 mm	<5mm	
	QPSK	21.85	153.11	Yes	Yes	No	Yes	No	Yes
LTE Band 4	Distance to User		<5mm	<5 mm	<5 mm	28 mm	133.5 mm	<5mm	
	QPSK	21.75	149.62	Yes	Yes	Yes	Yes	No	Yes
LTE Band 7	Distance to User		<5mm	<5 mm	<5 mm	28 mm	133.5 mm	<5mm	
	QPSK	21.70	147.91	Yes	Yes	Yes	Yes	No	Yes
WLAN 2.4 G	Distance to User		<5mm	<5mm	47.5mm	<5mm	<5mm	136 mm	
	802.11b	15.75	37.58	Yes	Yes	No	Yes	Yes	No
	802.11g	20.05	101.16	No	No	No	No	No	No
	802.11n (HT20)	19.15	82.22	No	No	No	No	No	No
	802.11n (HT40)	19.30	85.11	No	No	No	No	No	No
Bluetooth	Distance to User		<5mm	<5mm	47.5mm	<5mm	<5mm	136 mm	
	Bluetooth BR/EDR	8.45	7.00	No	No	No	No	No	No
	Bluetooth BLE	-1.25	0.75	No	No	No	No	No	No

Note:

- Maximum power is the source-based time-average power and represents the maximum RF output power among production units.
- Per KDB 447498 D01, for larger devices, the test separation distance of adjacent edge configuration is determined by the closest separation between the antenna and the user.
- Per KDB 447498 D01, standalone SAR test exclusion threshold is applied; If the distance of the antenna to the user is < 5mm, 5mm is used to determine SAR exclusion threshold
- Per KDB 447498 D01, the 1-g and 10-g SAR test exclusion thresholds for 100 MHz to 6 GHz at test separation distances  $\leq 50$  mm are determined by:

$$\left[ \frac{\text{(max. power of channel, including tune-up tolerance, mW)}}{\text{(min. test separation distance, mm)}} \right] \cdot \sqrt{f(\text{GHz})} \leq 3.0 \text{ for 1-g SAR}$$
 and  $\leq 7.5$  for 10-g extremity SAR

- f(GHz) is the RF channel transmit frequency in GHz
- Power and distance are rounded to the nearest mW and mm before calculation

- c. The result is rounded to one decimal place for comparison
  - d. For < 50 mm distance, we just calculate mW of the exclusion threshold value (3.0) to do compare.  
This formula is  $[3.0] / [\sqrt{f(\text{GHz})}] \cdot [(\text{min. test separation distance, mm})] = \text{exclusion threshold of mW}$ .
5. Per KDB 447498 D01, at 100 MHz to 6 GHz and for test separation distances > 50 mm, the SAR test exclusion threshold is determined according to the following:
    - a. [Threshold at 50 mm in step 1) + (test separation distance - 50 mm) · ( f(MHz)/150)] mW, at 100 MHz to 1500 MHz
    - b. [Threshold at 50 mm in step 1) + (test separation distance - 50 mm) · 10] mW at > 1500 MHz and ≤ 6 GHz
  6. Per KDB 941225 D01, RMC 12.2kbps setting is used to evaluate SAR. If HSDPA /HSUPA /DC-HSDPA output power is < 0.25dB higher than RMC12.2Kbps, or reported SAR with RMC 12.2kbps setting is ≤ 1.2W/kg, HSDPA/HSUPA/DC-HSDPA SAR evaluation can be excluded.
  7. Per KDB 248227 D01, choose the highest output power channel to test SAR and determine further SAR exclusion.8. For each frequency band, testing at higher data rates and higher order modulations is not required when the maximum average output power for each of these configurations is less than 1/4dB higher than those measured at the lowest data rate
  8. Per KDB 248227 D01 SAR is not required for the following 2.4 GHz OFDM conditions.
    - a. When KDB Publication 447498 D01 SAR test exclusion applies to the OFDM configuration.
    - b. When the highest reported SAR for DSSS is adjusted by the ratio of OFDM to DSSS specified maximum output power and the adjusted SAR is ≤ 1.2 W/kg.
  9. Per KDB 248227 D01 SAR is not required for the following U-NII-1 and U-NII-2A bands conditions.
    - a. When the same maximum output power is specified for both bands, begin SAR measurement in U-NII-2A band by applying the OFDM SAR requirements. If the highest reported SAR for a test configuration is ≤ 1.2 W/kg, SAR is not required for U-NII-1 band for that configuration (802.11 mode and exposure condition); otherwise, each band is tested independently for SAR.
    - b. When different maximum output power is specified for the bands, begin SAR measurement in the band with higher specified maximum output power. The highest reported SAR for the tested configuration is adjusted by the ratio of lower to higher specified maximum output power for the two bands. When the adjusted SAR is ≤ 1.2 W/kg, SAR is not required for the band with lower maximum output power in that test configuration; otherwise, each band is tested independently for SAR.

## 9.2 10g Extremity Exposure Consider

According with FCC KDB 648474 D04, for smart phones with a display diagonal dimension > 15.0 cm or an overall diagonal dimension > 16.0 cm that provide similar mobile web access and multimedia support found in mini-tablets or UMPC mini-tablets that support voice calls next to the ear, unless it is confirmed otherwise through KDB inquiries, the following phablet procedures should be applied to evaluate SAR compliance for each applicable wireless modes and frequency band. Devices marketed as phablets, regardless of form factors and operating characteristics must be tested as a phablet to determine SAR compliance;

The UMPC mini-tablet procedures must also be applied to test the SAR of all surfaces and edges with an antenna located at  $\leq 25$  mm from that surface or edge, in direct contact with a flat phantom, for 10-g extremity SAR according to the body-equivalent tissue dielectric parameters in KDB 865664 to address interactive hand use exposure conditions. The UMPC mini-tablet 1-g SAR at 5 mm is not required. When hotspot mode applies, 10-g extremity SAR is required only for the surfaces and edges with hotspot mode 1-g reported SAR > 1.2 W/kg.

### **Conclusion:**

The EUT hotspot mode 1-g reported SAR is 0.898 W/Kg, which is less than 1.2W/Kg, 10-g extremity SAR is not required.



# 10 TEST RESULTS

## 10.1 GSM 850

Mode	Position	Dist. (mm)	Ch.	Freq. (MHz)	Power Drift (%)	1 g Meas. SAR (W/Kg)	Meas. Power (dBm)	Max. tune-up Power(dBm)	Scaling Factor	1 g Scaled SAR (W/Kg)	Meas. No.
<b>Head</b>											
Voice	Left Cheek	0	128	824.2	1.33	0.206	31.82	31.95	1.03	0.212	/
	Left Tilt	0	128	824.2	-2.56	0.153	31.82	31.95	1.03	0.158	/
	Right Cheek	0	128	824.2	-3.30	0.246	31.82	31.95	1.03	<b>0.253</b>	<b>1#</b>
	Right Tilt	0	128	824.2	-3.83	0.186	31.82	31.95	1.03	0.192	/
<b>Body-worn Accessory &amp;Hotspot</b>											
Voice	Front Side	10	128	824.2	3.74	0.325	31.82	31.95	1.03	0.335	/
	Back Side	10	128	824.2	1.10	0.409	31.82	31.95	1.03	0.421	/
GPRS 4 slots	Front Side	10	251	848.8	1.57	0.377	29.40	29.50	1.02	0.386	/
	Back Side	10	251	848.8	0.04	0.492	29.40	29.50	1.02	<b>0.503</b>	<b>2#</b>
	Left Edge	10	251	848.8	2.26	0.287	29.40	29.50	1.02	0.294	/
	Right Edge	10	251	848.8	-3.38	0.305	29.40	29.50	1.02	0.312	/
	Bottom Edge	10	251	848.8	1.92	0.077	29.40	29.50	1.02	0.079	/
Note: SAR is not required for EGPRS (8PSK) mode because its output power is less than that of GPRS Mode.											

**10.2GSM 1900**

Mode	Position	Dist. (mm)	Ch.	Freq. (MHz)	Power Drift (%)	1 g Meas. SAR (W/Kg)	Meas. Power (dBm)	Max. tune-up Power(dBm)	Scaling Factor	1 g Scaled SAR (W/Kg)	Meas. No.
<b>Head</b>											
Voice	Left Cheek	0	810	1909.80	-1.74	0.147	28.63	28.75	1.03	0.151	/
	Left Tilt	0	810	1909.80	3.42	0.051	28.63	28.75	1.03	0.052	/
	Right Cheek	0	810	1909.80	-1.35	0.178	28.63	28.75	1.03	<b>0.183</b>	<b>3#</b>
	Right Tilt	0	810	1909.80	0.42	0.081	28.63	28.75	1.03	0.083	/
<b>Body-worn Accessory &amp;Hotspot</b>											
Voice	Front Side	10	810	1909.8	2.60	0.474	28.63	28.75	1.03	0.487	/
	Back Side	10	810	1909.8	-2.15	0.466	28.63	28.75	1.03	0.479	/
GPRS 4 slots	Front Side	10	661	1880.0	0.10	0.625	26.58	26.70	1.03	0.643	/
	Back Side	10	661	1880.0	-1.70	0.624	26.58	26.70	1.03	0.641	/
	Left Edge	10	661	1880.0	-3.77	0.352	26.58	26.70	1.03	0.362	/
	Right Edge	10	661	1880.0	4.85	0.165	26.58	26.70	1.03	0.170	/
	Bottom Edge	10	661	1880.0	-2.37	0.874	26.58	26.70	1.03	<b>0.898</b>	<b>4#</b>
			512	1850.2	0.09	0.748	26.50	26.70	1.05	0.783	/
810			1909.8	-2.55	0.785	26.41	26.70	1.07	0.839	/	
Note: SAR is not required for EGPRS (8PSK) mode because its output power is less than that of GPRS Mode.											

## 10.3WCDMA Band 2

Mode	Position	Dist. (mm)	Ch.	Freq. (MHz)	Power Drift (%)	1 g Meas. SAR (W/Kg)	Meas. Power (dBm)	Max. tune-up Power(dBm)	Scaling Factor	1 g Scaled SAR (W/Kg)	Meas. No.
<b>Head</b>											
RMC	Left Cheek	0	9262	1852.4	0.32	0.238	22.68	22.80	1.03	0.245	/
	Left Tilt	0	9262	1852.4	3.88	0.093	22.68	22.80	1.03	0.096	/
	Right Cheek	0	9262	1852.4	-1.14	0.337	22.68	22.80	1.03	<b>0.346</b>	5#
	Right Tilt	0	9262	1852.4	3.77	0.126	22.68	22.80	1.03	0.130	/
<b>Body-worn Accessory &amp; Hotspot</b>											
RMC	Front Side	10	9262	1852.4	-1.57	0.566	22.68	22.80	1.03	0.582	/
	Back Side	10	9262	1852.4	-1.26	0.555	22.68	22.80	1.03	0.571	/
	Left Edge	10	9262	1852.4	1.51	0.168	22.68	22.80	1.03	0.173	/
	Right Edge	10	9262	1852.4	-4.15	0.088	22.68	22.80	1.03	0.090	/
	Bottom Edge	10	9262	1852.4	-0.37	0.845	22.68	22.80	1.03	<b>0.869</b>	6#
		10	9400	1880.0	-1.43	0.729	22.45	22.80	1.08	0.790	/
10		9538	1907.6	-1.63	0.752	22.58	22.80	1.05	0.791	/	

## 10.4WCDMA Band 5

Mode	Position	Dist. (mm)	Ch.	Freq. (MHz)	Power Drift (%)	1 g Meas. SAR (W/Kg)	Meas. Power (dBm)	Max. tune-up Power(dBm)	Scaling Factor	1 g Scaled SAR (W/Kg)	Meas. No.
<b>Head</b>											
RMC	Left Cheek	0	4233	846.60	-3.14	0.238	22.50	22.60	1.02	0.244	/
	Left Tilt	0	4233	846.60	3.11	0.172	22.50	22.60	1.02	0.176	/
	Right Cheek	0	4233	846.60	-3.05	0.298	22.50	22.60	1.02	<b>0.305</b>	7#
	Right Tilt	0	4233	846.60	-2.64	0.191	22.50	22.60	1.02	0.195	/
<b>Body-worn Accessory &amp; Hotspot</b>											
RMC	Front Side	10	4233	846.60	1.62	0.303	22.50	22.60	1.02	0.310	/
	Back Side	10	4233	846.60	-0.32	0.360	22.50	22.60	1.02	<b>0.368</b>	8#
	Left Edge	10	4233	846.60	1.33	0.155	22.50	22.60	1.02	0.159	/
	Right Edge	10	4233	846.60	0.82	0.163	22.50	22.60	1.02	0.167	/
	Bottom Edge	10	4233	846.60	3.32	0.071	22.50	22.60	1.02	0.073	/

## 10.5LTE Band 2 (20MHz Bandwidth)

Mode	Position	Dist. (mm)	Ch.	Freq. (MHz)	RB Numb.	RB Start	Power Drift (%)	1 g Meas. SAR (W/Kg)	Meas. Power (dBm)	Max. tune-up Power (dBm)	Scaling Factor	1 g Scaled SAR (W/Kg)	Meas. No.
<b>Head</b>													
QPSK	Left Cheek	0	18700	1860	1	Low	-0.08	0.244	21.77	21.85	1.02	0.249	/
			18700	1860	50	High	-1.47	0.199	20.70	20.80	1.02	0.204	/
	Left Tilt	0	18700	1860	1	Low	-0.12	0.088	21.77	21.85	1.02	0.090	/
			18700	1860	50	High	1.39	0.071	20.70	20.80	1.02	0.073	/
	Right Cheek	0	18700	1860	1	Low	-2.71	0.277	21.77	21.85	1.02	<b>0.282</b>	9#
			18700	1860	50	High	2.15	0.226	20.70	20.80	1.02	0.232	/
	Right Tilt	0	18700	1860	1	Low	-4.21	0.112	21.77	21.85	1.02	0.114	/
			18700	1860	50	High	-4.90	0.091	20.70	20.80	1.02	0.093	/
<b>Body-worn Accessory &amp; Hotspot</b>													
QPSK	Front Side	10	18700	1860	1	Low	-1.21	0.484	21.77	21.85	1.02	0.493	/
			18700	1860	50	High	-0.24	0.395	20.70	20.80	1.02	0.405	/
	Back Side	10	18700	1880	1	Low	-1.56	0.495	21.77	21.85	1.02	0.504	/
			18700	1860	50	High	-4.60	0.404	20.70	20.80	1.02	0.414	/
	Left Edge	10	18700	1860	1	Low	-0.71	0.256	21.77	21.85	1.02	0.261	/
			18700	1860	50	High	1.80	0.209	20.70	20.80	1.02	0.214	/
	Right Edge	10	18700	1860	1	Low	-0.42	0.134	21.77	21.85	1.02	0.136	/
			18700	1860	50	High	2.23	0.109	20.70	20.80	1.02	0.112	/
	Bottom Edge	10	18700	1860	1	Low	-1.77	0.567	21.77	21.85	1.02	<b>0.578</b>	10#
			18700	1860	50	High	1.56	0.462	20.70	20.80	1.02	0.474	/

## 10.6LTE Band 4 (20MHz Bandwidth)

Mode	Position	Dist. (mm)	Ch.	Freq. (MHz)	RB Numb.	RB Start	Power Drift (%)	1 g Meas. SAR (W/Kg)	Meas. Power (dBm)	Max. tune-up Power (dBm)	Scaling Factor	1 g Scaled SAR (W/Kg)	Meas. No.
<b>Head</b>													
QPSK	Left Cheek	0	20300	1745	1	Low	2.86	0.210	21.67	21.75	1.02	0.214	/
			20300	1745	50	Low	-1.68	0.171	20.56	20.65	1.02	0.175	/
	Left Tilt	0	20300	1745	1	Low	3.97	0.104	21.67	21.75	1.02	0.106	/
			20300	1745	50	Low	1.97	0.085	20.56	20.65	1.02	0.087	/
	Right Cheek	0	20300	1745	1	Low	-3.46	0.319	21.67	21.75	1.02	<b>0.325</b>	11#
			20300	1745	50	Low	-3.95	0.264	20.56	20.65	1.02	0.270	/
	Right Tilt	0	20300	1745	1	Low	-2.89	0.133	21.67	21.75	1.02	0.135	/
			20300	1745	50	Low	3.14	0.110	20.56	20.65	1.02	0.112	/
<b>Body-worn Accessory &amp; Hotspot</b>													
QPSK	Front Side	10	20300	1745	1	Low	-2.55	0.364	21.67	21.75	1.02	0.371	/
			20300	1745	50	Low	3.26	0.296	20.56	20.65	1.02	0.302	/
	Back Side	10	20300	1745	1	Low	-2.19	0.499	21.67	21.75	1.02	<b>0.508</b>	12#
			20300	1745	50	Low	-2.21	0.410	20.56	20.65	1.02	0.419	/
	Left Edge	10	20300	1745	1	Low	1.83	0.216	21.67	21.75	1.02	0.220	/
			20300	1745	50	Low	-3.27	0.177	20.56	20.65	1.02	0.181	/
	Right Edge	10	20300	1745	1	Low	0.24	0.106	21.67	21.75	1.02	0.108	/
			20300	1745	50	Low	2.12	0.089	20.56	20.65	1.02	0.091	/
	Bottom Edge	10	20300	1745	1	Low	-0.92	0.398	21.67	21.75	1.02	0.405	/
			20300	1745	50	Low	2.56	0.318	20.56	20.65	1.02	0.325	/

## 10.7LTE Band 7 (20MHz Bandwidth)

Mode	Position	Dist. (mm)	Ch.	Freq. (MHz)	RB Numb.	RB Start	Power Drift (%)	1 g Meas. SAR (W/Kg)	Meas. Power (dBm)	Max. tune-up Power (dBm)	Scaling Factor	1 g Scaled SAR (W/Kg)	Meas. No.
<b>Head</b>													
QPSK	Left Cheek	0	21350	2560	1	Low	-2.74	0.172	21.61	21.70	1.02	0.176	/
			20850	2510	50	High	-0.84	0.149	20.31	20.40	1.02	0.152	/
	Left Tilt	0	21350	2560	1	Low	2.21	0.126	21.61	21.70	1.02	0.129	/
			20850	2510	50	High	1.39	0.086	20.31	20.40	1.02	0.088	/
	Right Cheek	0	21350	2560	1	Low	-2.68	0.380	21.61	21.70	1.02	<b>0.388</b>	13#
			20850	2510	50	High	-0.25	0.306	20.31	20.40	1.02	0.313	/
	Right Tilt	0	21350	2560	1	Low	1.98	0.163	21.61	21.70	1.02	0.166	/
			20850	2510	50	High	2.41	0.122	20.31	20.40	1.02	0.125	/
<b>Body-worn Accessory &amp; Hotspot</b>													
QPSK	Front Side	10	21350	2560	1	Low	-2.92	0.308	21.61	21.70	1.02	0.314	/
			20850	2510	50	High	-0.05	0.251	20.31	20.40	1.02	0.257	/
	Back Side	10	21350	2560	1	Low	-0.57	0.271	21.61	21.70	1.02	0.277	/
			20850	2510	50	High	-3.14	0.223	20.31	20.40	1.02	0.228	/
	Left Edge	10	21350	2560	1	Low	-3.49	0.126	21.61	21.70	1.02	0.129	/
			20850	2510	50	High	4.64	0.103	20.31	20.40	1.02	0.105	/
	Right Edge	10	21350	2560	1	Low	-3.12	0.021	21.61	21.70	1.02	0.021	/
			20850	2510	50	High	-1.92	0.016	20.31	20.40	1.02	0.016	/
	Bottom Edge	10	21350	2560	1	Low	-2.84	0.716	21.61	21.70	1.02	<b>0.731</b>	14#
			20850	2510	50	High	3.21	0.629	20.31	20.40	1.02	0.644	/

## 10.8WIFI 2.4GHz

Mode	Position	Dist. (mm)	Ch.	Freq. (MHz)	Power Drift (%)	1 g Meas. SAR (W/Kg)	Meas. Power (dBm)	Max. tune-up Power (dBm)	Scaling Factor	1 g Scaled SAR (W/Kg)	Meas. No.
<b>Head</b>											
802.11 b	Left Cheek	0	11	2462	4.35	0.160	19.92	20.05	1.03	0.165	/
	Left Tilt	0	11	2462	1.12	0.085	19.92	20.05	1.03	0.088	/
	Right Cheek	0	11	2462	-2.20	0.407	19.92	20.05	1.03	<b>0.419</b>	15#
	Right Tilt	0	11	2462	-2.53	0.155	19.92	20.05	1.03	0.160	/
<b>Body-worn Accessory &amp; Hotspot</b>											
802.11 b	Front Side	10	11	2462	-2.07	0.103	19.92	20.05	1.03	0.106	/
	Back Side	10	11	2462	-3.66	0.107	19.92	20.05	1.03	<b>0.110</b>	16#
	Right Edge	10	11	2462	-1.48	0.090	19.92	20.05	1.03	0.093	/
	Top Edge	10	11	2462	-0.23	0.046	19.92	20.05	1.03	0.47	/

Note According KDB 248227 D01 SAR is not required for the following 2.4 GHz OFDM conditions. When the highest reported SAR for DSSS is adjusted by the ratio of OFDM to DSSS specified maximum output power and the adjusted SAR is  $\leq 1.2$  W/kg.

## 11 SAR Measurement Variability

According to KDB 865664 D01, SAR measurement variability was assessed for each frequency band, which is determined by the SAR probe calibration point and tissue-equivalent medium used for the device measurements. When both head and body tissue-equivalent media are required for SAR measurements in a frequency band, the variability measurement procedures should be applied to the tissue medium with the highest measured SAR, using the highest measured SAR configuration for that tissue-equivalent medium. Alternatively, if the highest measured SAR for both head and body tissue-equivalent media are  $\leq 1.45$  W/kg and the ratio of these highest SAR values, i.e., largest divided by smallest value, is  $\leq 1.10$ , the highest SAR configuration for either head or body tissue-equivalent medium may be used to perform the repeated measurement. These additional measurements are repeated after the completion of all measurements requiring the same head or body tissue-equivalent medium in a frequency band. The test device should be returned to ambient conditions (normal room temperature) with the battery fully charged before it is re-mounted on the device holder for the repeated measurement(s) to minimize any unexpected variations in the repeated results.

SAR repeated measurement procedure:

1. When the highest measured SAR is  $< 0.80$  W/kg, repeated measurement is not required.
2. When the highest measured SAR is  $\geq 0.80$  W/kg, repeat that measurement once.
3. If the ratio of largest to smallest SAR for the original and first repeated measurements is  $> 1.20$ , or when the original or repeated measurement is  $\geq 1.45$  W/kg, perform a second repeated measurement.
4. If the ratio of largest to smallest SAR for the original, first and second repeated measurements is  $> 1.20$ , and the original, first or second repeated measurement is  $\geq 1.5$  W/kg, perform a third repeated measurement.

Frequency Band (MHz)	Wireless Band	RF Exposure Conditions	Test Position	Highest Measured SAR (W/kg)	Repeated SAR (Yes/No)	Highest Measured SAR (W/kg)	Largest to Smallest SAR Ratio
1900	GSM 1900	Hotspot	Bottom Edge	0.874	Yes	0.863	1.02
	WCDMA Band2	Hotspot	Bottom Edge	0.845	Yes	0.838	1.01

**Note:** The ratio of largest to smallest SAR for the original and first repeated measurements is  $< 1.20$ , the second repeated measurement is not required.

## 12 SIMULTANEOUS TRANSMISSION

Simultaneous transmission SAR test exclusion is determined for each operating configuration and exposure condition according to the reported standalone SAR of each applicable simultaneous transmitting antenna. When the sum of SAR 1g of all simultaneously transmitting antennas in an operating mode and exposure condition combination is within the SAR limit (SAR 1g 1.6 W/kg), the simultaneous transmission SAR is not required. When the sum of SAR 1g is greater than the SAR limit (SAR 1g 1.6 W/kg), SAR test exclusion is determined by the SAR to Peak Location Ratio (SPLSR).

### 12.1 Simultaneous Transmission Mode Consider

NO.	Mode	2.4G WLAN		
		Head	Body-worn	Hotspot
1	GSM (Voice)	+ 2.4G WLAN	+ 2.4G WLAN	--
2	GSM(Data)	--	--	+ 2.4G WLAN
3	WCDMA RMC	+ 2.4G WLAN	+ 2.4G WLAN	+ 2.4G WLAN
4	LTE	+ 2.4G WLAN	+ 2.4G WLAN	+ 2.4G WLAN

Note:

- 2G&3G&4G share the same antenna and can't transmit simultaneously.
- The Bluetooth and 2.4G WLAN share the same antenna, can't transmitting together.
- 2.4G WLAN supports hotspot mode.



## 12.2 Estimated SAR Calculation

According to KDB 447498 D01 when standalone SAR test exclusion applies to an antenna that transmits simultaneously with other antennas, the standalone SAR was estimated according to following formula to result in substantially conservative SAR values of  $\leq 0.4$  W/kg to determine simultaneous transmission SAR test exclusion.

$$\text{Estimated SAR} = \frac{\text{Max. Tune Up Power (mw)}}{\text{Min Test Separation Distance}} * \frac{\sqrt{f_{\text{GHz}}}}{x} \quad (\text{where } x = 7.5 \text{ for 1-g SAR})$$

If the minimum test separation distance is  $< 5$  mm, a distance of 5 mm is used for estimated SAR calculation. When the test separation distance is  $> 50$  mm, the 0.4 W/kg is used for SAR-1g.

Band	Mode	Position	Antenna To user (mm)	SAR Testing	Max. Tune-up Power (dBm)	Max. Tune-up Power (mW)	Frequency (GHz)	Calculation Distance/Gap (mm)	Estimated SAR (W/kg)
Bluetooth	GFSK	Right Cheek	5	NO	8.45	7.00	2.441	5	0.292
		Left Cheek	5	NO	8.45	7.00	2.441	5	0.292
		Front Side	10	NO	8.45	7.00	2.441	10	0.146
		Back Side	10	NO	8.45	7.00	2.441	10	0.146
		Left Edge	10	NO	8.45	7.00	2.441	10	0.146
		Right Edge	10	NO	8.45	7.00	2.441	10	0.146
		Top Edge	10	NO	8.45	7.00	2.441	10	0.146

## 12.3 Sum SAR of Simultaneous Transmission

### 12.3.1 Sum Head SAR of Simultaneous Transmission

Simultaneous Mode	Mode	Max. 1g SAR (W/kg)	1g Sum SAR (W/kg)	SPLSR (Yes/No)
GSM Voice + 2.4G WLAN	GSM Voice	0.253	0.672	No
	2.4G WLAN	0.419		
GSM Voice + Bluetooth	GSM Voice	0.253	0.545	No
	Bluetooth	0.292		
WCDMA RMC +2.4G WLAN	WCDMA RMC	0.346	0.765	No
	2.4G WLAN	0.419		
WCDMA RMC + Bluetooth	WCDMA RMC	0.346	0.638	No
	Bluetooth	0.292		
LTE QPSK + 2.4G WLAN	LTE QPSK	0.388	<b>0.807</b>	No
	2.4G WLAN	0.419		
LTE QPSK + Bluetooth	LTE QPSK	0.388	0.680	No
	Bluetooth	0.292		

### 12.3.2 Sum Body-worn SAR of Simultaneous Transmission

Simultaneous Mode	Mode	Max. 1g SAR (W/kg)	1g Sum SAR (W/kg)	SPLSR (Yes/No)
GSM Voice + 2.4G WLAN	GSM Voice	0.643	0.753	No
	2.4G WLAN	0.110		
GSM Voice + Bluetooth	GSM Voice	0.643	<b>0.789</b>	No
	Bluetooth	0.146		
WCDMA RMC +2.4G WLAN	WCDMA RMC	0.582	0.692	No
	2.4G WLAN	0.110		
WCDMA RMC + Bluetooth	WCDMA RMC	0.582	0.728	No
	Bluetooth	0.146		
LTE QPSK + 2.4G WLAN	LTE QPSK	0.508	0.618	No
	2.4G WLAN	0.110		
LTE QPSK + Bluetooth	LTE QPSK	0.508	0.645	No
	Bluetooth	0.146		

## 12.3.3 Sum Hotspot mode SAR of Simultaneous Transmission

Simultaneous Mode	Mode	Max. 1g SAR (W/kg)	1g Sum SAR (W/kg)	SPLSR (Yes/No)
GSM DATA + 2.4G WLAN	GSM DATA	0.898	1.008	No
	2.4G WLAN	0.110		
GSM DATA + Bluetooth	GSM DATA	0.898	<b>1.044</b>	No
	Bluetooth	0.146		
WCDMA RMC +2.4G WLAN	WCDMA RMC	0.869	0.979	No
	2.4G WLAN	0.110		
WCDMA RMC + Bluetooth	WCDMA RMC	0.869	1.015	No
	Bluetooth	0.146		
LTE QPSK + 2.4G WLAN	LTE QPSK	0.731	0.841	No
	2.4G WLAN	0.110		
LTE QPSK + Bluetooth	LTE QPSK	0.731	0.877	No
	Bluetooth	0.146		

## 13 TEST EQUIPMENTS LIST

Description	Manufacturer	Model	Serial No.	Cal. Date	Cal. Due
PC	Dell	N/A	N/A	N/A	N/A
835MHz Dipole	SATIMO	SID 835	S/N 25/13 DIP 0G835-246	2015/03/16	2018/03/15
1800MHz Dipole	SATIMO	SID 1800	S/N 25/13 DIP 1G800-248	2015/03/16	2018/03/15
1900MHz Dipole	SATIMO	SID 1900	S/N 25/13 DIP 1G900-249	2015/03/16	2018/03/15
2450MHz Dipole	SATIMO	SID 2450	S/N 25/13 DIP 2G450-251	2015/03/16	2018/03/15
2600MHz Dipole	SATIMO	SID 2600	SN 25/13 DIP 2G600-254	2015/03/16	2018/03/15
E-Field Probe	MVG	SSE2	S/N 34/15 EPGO 265	2016/09/15	2017/09/14
Antenna	SATIMO	ANTA3	SN 17/13 ZNTA45	N/A	N/A
Phantom1	SATIMO	SAM	SN 30/13 SAM103	N/A	N/A
Phantom2	SATIMO	SAM	SN 30/13 SAM104	N/A	N/A
Dielectric Probe Kit	SATIMO	SCLMP	SN 25/13 OCPG56	2016/07/13	2017/07/12
MultiMeter	Keithley	MultiMeter 2000	4024022	2016/07/13	2017/07/12
Signal Generator	R&S	SMF100A	1167.0000k02/104260	2016/07/13	2017/07/12
Power Meter	Agilent	E4419B	GB40201833	2016/07/13	2017/07/12
Power Sensor	R&S	NRP-Z21	103971	2016/07/13	2017/07/12
Power Amplifier	SATIMO	6552B	22374	N/A	N/A
Wireless Communication Test Set	R&S	CMW 500	138884	2016/07/13	2017/07/12
Network Analyzer	R&S	ZVL-6	101380	2016/07/13	2017/07/12
Attenuator	COM-MW	ZA-S1-31	1305003187	N/A	N/A
Directional coupler	AA-MCS	AAMCS-UDC	000272	N/A	N/A

Note: Per KDB 865664 Dipole SAR Validation Verification, BALUN LAB has adopted 3 years calibration intervals. On annual basis, every measurement dipole has been evaluated and is in compliance with the following criteria:

1. There is no physical damage on the dipole;
2. System validation with specific dipole is within 10% of calibrated value;
3. Return-loss in within 20% of calibrated measurement.

## ANNEX A SIMULATING LIQUID VERIFICATION RESULT

The dielectric parameters of the liquids were verified prior to the SAR evaluation using an SCLMP Dielectric Probe Kit.

Date	Liquid Type	Fre. (MHz)	Temp. (°C)	Meas. Conductivity ( $\sigma$ ) (S/m)	Meas. Permittivity ( $\epsilon$ )	Target Conductivity ( $\sigma$ ) (S/m)	Target Permittivity ( $\epsilon$ )	Conductivity Tolerance (%)	Permittivity Tolerance (%)
2016.11.24	Head	835	21.1	0.89	41.99	0.90	41.50	-1.11	1.18
2016.11.24	Body	835	21.1	0.96	53.63	0.97	55.20	-1.03	-2.84
2016.11.26	Head	1800	20.9	1.41	39.60	1.40	40.00	0.71	-1.00
2016.11.26	Body	1800	20.9	1.49	53.16	1.52	53.30	-1.97	-0.26
2016.11.28	Head	1900	20.6	1.43	40.33	1.40	40.00	2.14	0.82
2016.11.25	Body	1900	20.6	1.54	51.29	1.52	53.30	1.32	-3.77
2016.11.27	Head	2450	20.4	1.86	38.58	1.80	39.20	3.33	-1.58
2016.11.27	Body	2450	20.4	1.99	52.27	1.95	52.70	2.05	-0.82
2016.11.27	Head	2600	20.4	1.99	37.22	1.96	39.00	1.53	-4.56
2016.11.27	Body	2600	20.4	2.08	51.47	2.16	52.50	-3.70	-1.96

Note: The tolerance limit of Conductivity and Permittivity is  $\pm 5\%$ .

## ANNEX B SYSTEM CHECK RESULT

Comparing to the original SAR value provided by SATIMO, the validation data should be within its specification of 10%(for 1 g).

Date	Liquid Type	Freq. (MHz)	Power (mW)	Measured SAR (W/kg)	Normalized SAR (W/kg)	Dipole SAR (W/kg)	Tolerance (%)	Targeted SAR(W/kg)	Tolerance (%)
2016.11.24	Head	835	100	0.927	9.27	9.81	-5.50	9.56	-3.03
2016.11.24	Body	835	100	1.016	10.16	10.53	-3.51	9.56	6.28
2016.11.26	Head	1800	100	3.932	39.32	38.72	1.55	38.40	2.40
2016.11.26	Body	1800	100	4.011	40.11	40.42	-0.77	38.40	4.45
2016.11.28	Head	1900	100	3.950	39.50	40.75	-3.07	39.70	-0.50
2016.11.25	Body	1900	100	4.117	41.17	42.06	-2.12	39.70	3.70
2016.11.27	Head	2450	100	5.355	53.55	54.29	-1.36	52.40	2.19
2016.11.27	Body	2450	100	5.464	54.64	54.70	-0.11	52.40	4.27
2016.11.27	Head	2600	100	5.361	53.61	57.37	-6.55	55.30	-3.06
2016.11.27	Body	2600	100	5.518	55.18	57.62	-4.23	55.30	-0.22

Note: The tolerance limit of System validation is  $\pm 10\%$ .

# System Performance Check Data(835MHz Head)

Type: Phone measurement (Complete)  
 E-Field Probe: SN 34/15 SSE2 EPGO265  
 Area scan resolution: dx=8mm,dy=8mm  
 Zoom scan resolution: dx=8mm, dy=8mm, dz=5mm  
 Date of measurement: 2016.11.24  
 Measurement duration: 13 minutes 29 seconds

## Experimental conditions.

<b>Phantom File</b>	surf_sam_plan.txt
<b>Phantom</b>	Validation plane
<b>Band</b>	835MHz
<b>Signal</b>	CW
<b>Frequency (MHz)</b>	835.000000
<b>Relative permittivity (real part)</b>	41.993475
<b>Conductivity (S/m)</b>	0.886358
<b>Power drift (%)</b>	-0.100000
<b>Ambient Temperature:</b>	22.6C
<b>Liquid Temperature:</b>	21.1C
<b>ConvF:</b>	2.04
<b>Crest factor:</b>	1:1

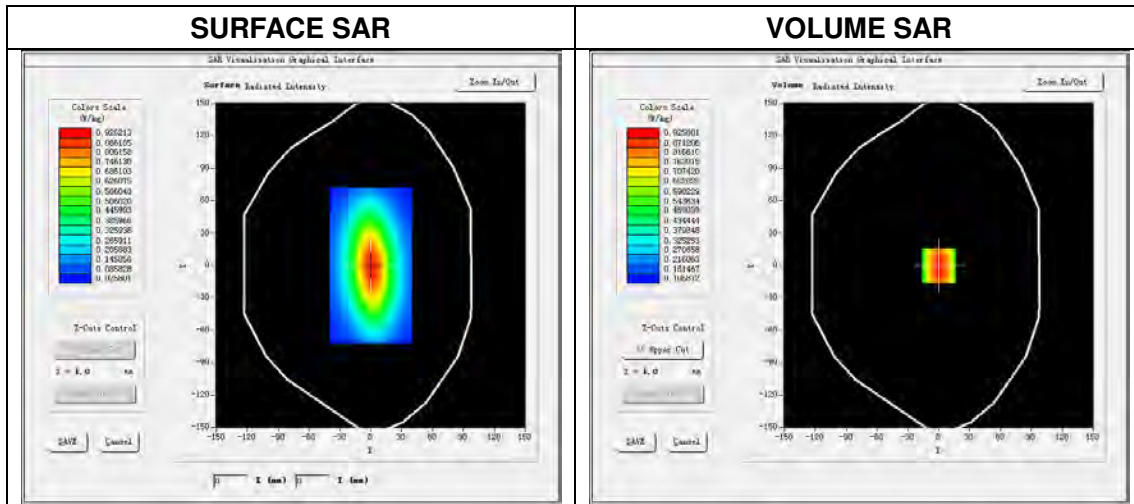

Maximum location: X=0.00, Y=0.00  
 SAR Peak: 1.26 W/kg

SAR 10 g (W/Kg)	0.593251
SAR 1g (W/Kg)	0.927158

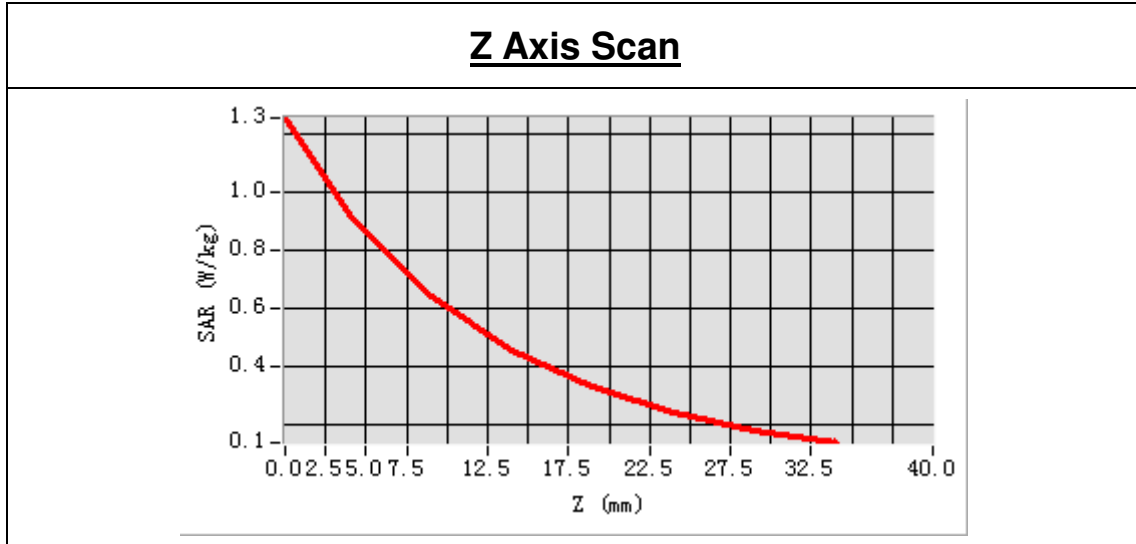

<b>3D screen shot</b>	<b>Hot spot position</b>



# System Performance Check Data(835MHz Body)

Type: Phone measurement (Complete)  
 E-Field Probe: SN 34/15 SSE2 EPGO265  
 Area scan resolution: dx=8mm,dy=8mm  
 Zoom scan resolution: dx=8mm, dy=8mm, dz=5mm  
 Date of measurement: 2016.11.24  
 Measurement duration: 14 minutes 46 seconds

## Experimental conditions.

<b>Phantom File</b>	surf_sam_plan.txt
<b>Phantom</b>	Validation plane
<b>Band</b>	835MHz
<b>Signal</b>	CW
<b>Frequency (MHz)</b>	835.000000
<b>Relative permittivity (real part)</b>	53.625165
<b>Conductivity (S/m)</b>	0.961278
<b>Power drift (%)</b>	0.390000
<b>Ambient Temperature:</b>	22.6C
<b>Liquid Temperature:</b>	21.1C
<b>ConvF:</b>	2.12
<b>Crest factor:</b>	1:1

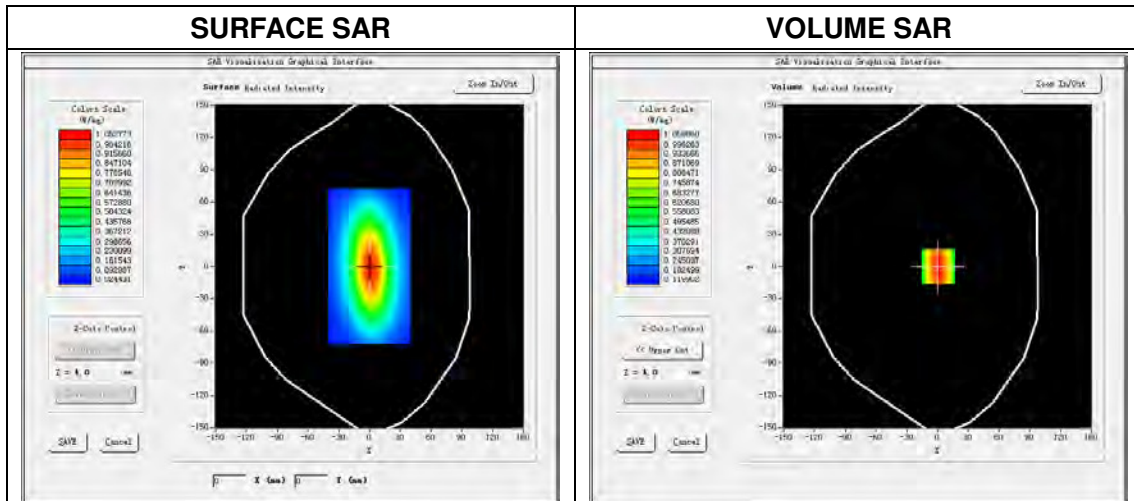

Maximum location: X=1.00, Y=0.00  
 SAR Peak: 1.40 W/kg

SAR 10 g (W/Kg)	0.638124
SAR 1g (W/Kg)	1.016258

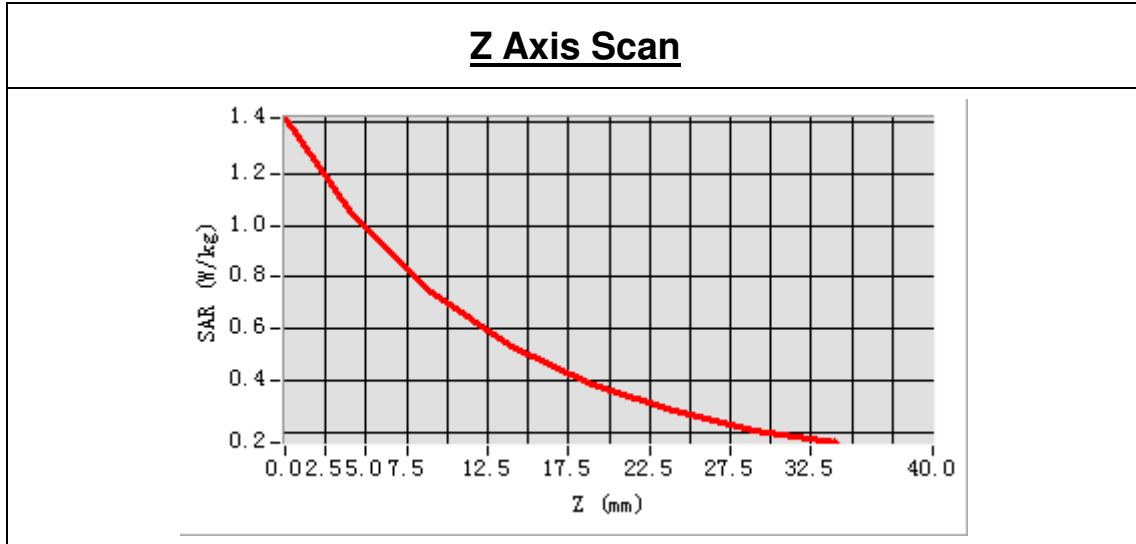

3D screen shot	Hot spot position

# System Performance Check Data(1800MHz Head)

Type: Phone measurement (Complete)  
 E-Field Probe: SN 34/15 SSE2 EPGO265  
 Area scan resolution: dx=8mm,dy=8mm  
 Zoom scan resolution: dx=8mm, dy=8mm, dz=5mm  
 Date of measurement: 2016.11.26  
 Measurement duration: 13 minutes 49 seconds

## Experimental conditions.

<b>Phantom File</b>	surf_sam_plan.txt
<b>Phantom</b>	Validation plane
<b>Band</b>	1800MHz
<b>Signal</b>	CW
<b>Frequency (MHz)</b>	1800.000000
<b>Relative permittivity (real part)</b>	39.602581
<b>Conductivity (S/m)</b>	1.406951
<b>Power drift (%)</b>	0.260000
<b>Ambient Temperature:</b>	22.3C
<b>Liquid Temperature:</b>	20.9C
<b>ConvF:</b>	2.04
<b>Crest factor:</b>	1:1

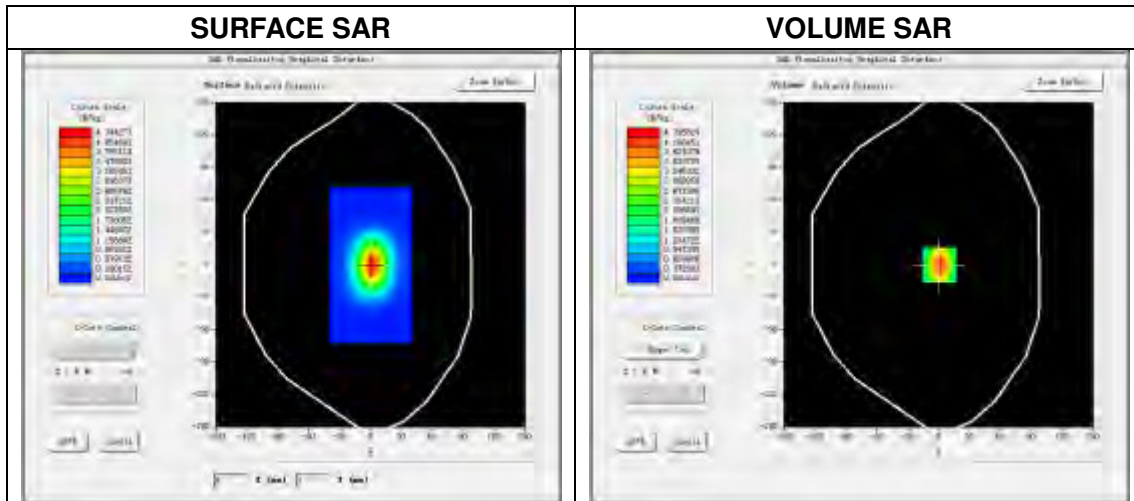

Maximum location: X=0.00, Y=0.00  
 SAR Peak: 6.43 W/kg

SAR 10 g (W/Kg)	2.035162
SAR 1g (W/Kg)	3.932445

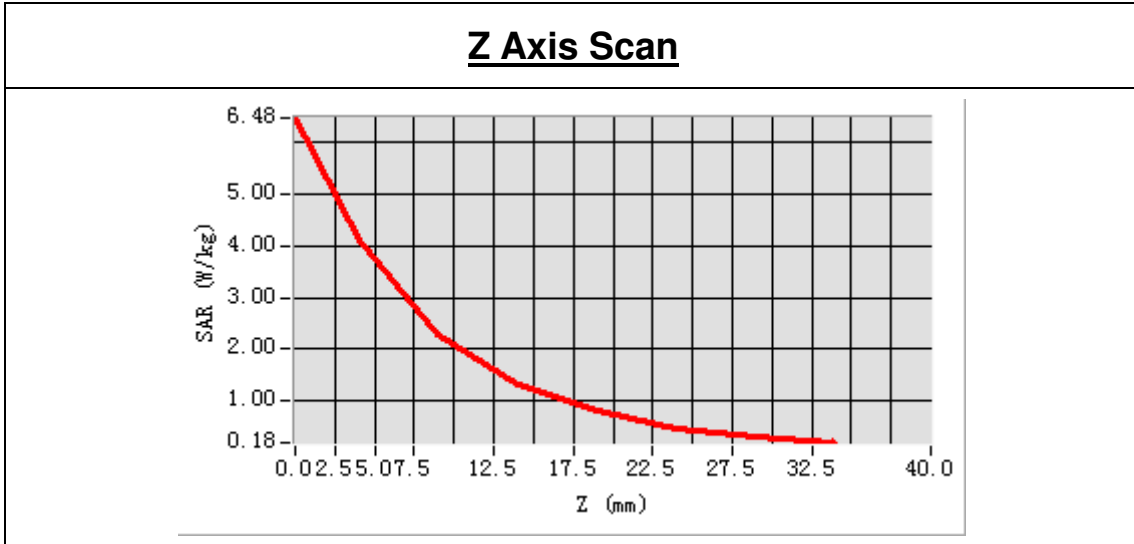

3D screen shot	Hot spot position

# System Performance Check Data(1800MHz Body)

Type: Phone measurement (Complete)  
 E-Field Probe: SN 34/15 SSE2 EPGO265  
 Area scan resolution: dx=8mm,dy=8mm  
 Zoom scan resolution: dx=8mm, dy=8mm, dz=5mm  
 Date of measurement: 2016.11.26  
 Measurement duration: 13 minutes 45 seconds

## Experimental conditions.

<b>Phantom File</b>	surf_sam_plan.txt
<b>Phantom</b>	Validation plane
<b>Band</b>	1800MHz
<b>Signal</b>	CW
<b>Frequency (MHz)</b>	1800.000000
<b>Relative permittivity (real part)</b>	53.158522
<b>Conductivity (S/m)</b>	1.493525
<b>Power drift (%)</b>	0.390000
<b>Ambient Temperature:</b>	22.3C
<b>Liquid Temperature:</b>	20.9C
<b>ConvF:</b>	2.08
<b>Crest factor:</b>	1:1

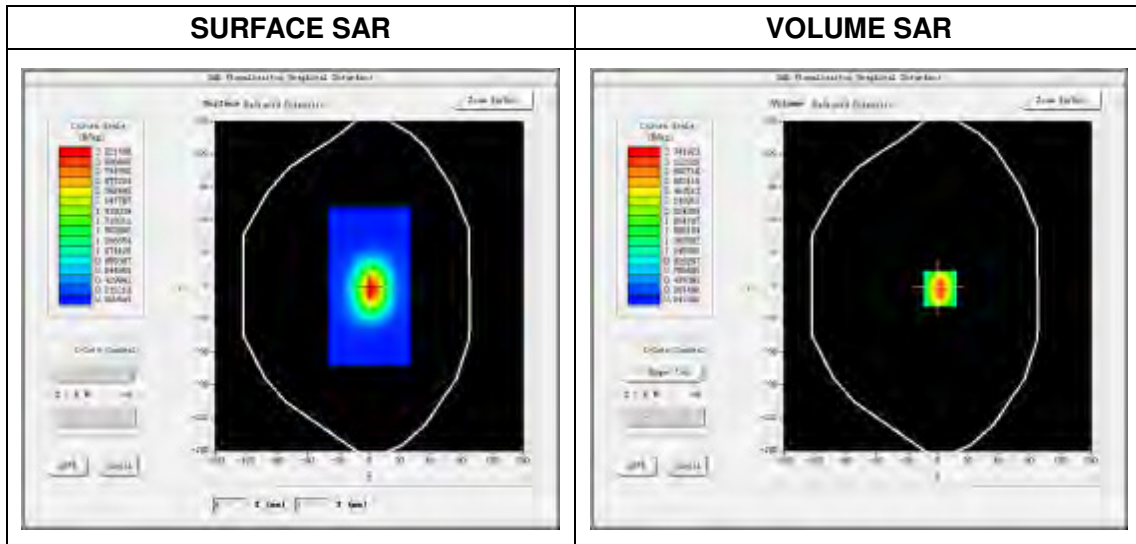

Maximum location: X=2.00, Y=2.00  
 SAR Peak: 6.87 W/kg

SAR 10 g (W/Kg)	2.087725
SAR 1g (W/Kg)	4.011486

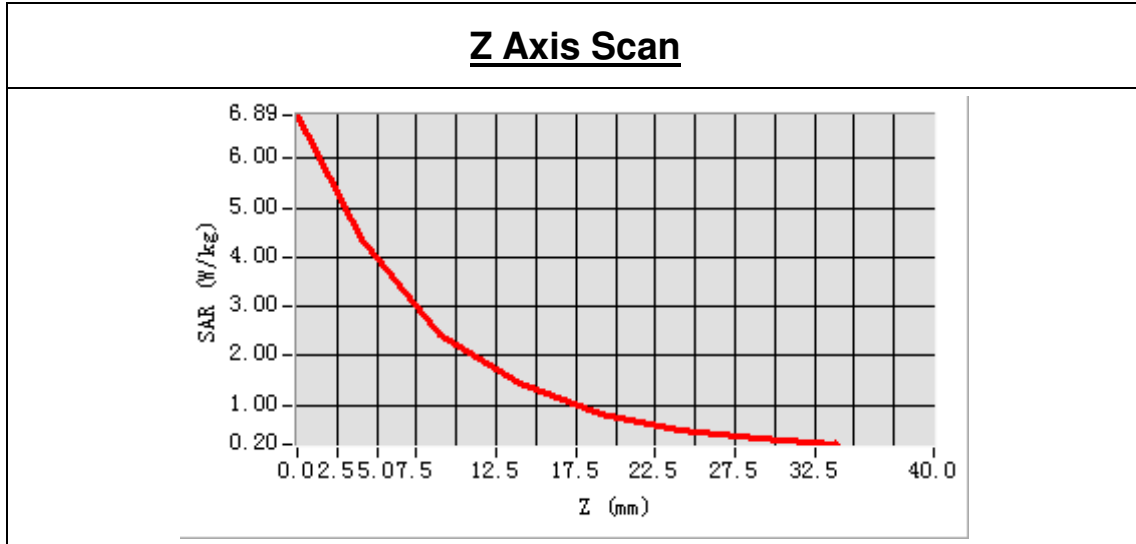

3D screen shot	Hot spot position

# System Performance Check Data(1900MHz Head)

Type: Phone measurement (Complete)  
 E-Field Probe: SN 34/15 SSE2 EPGO265  
 Area scan resolution: dx=8mm,dy=8mm  
 Zoom scan resolution: dx=8mm, dy=8mm, dz=5mm  
 Date of measurement: 2016.11.28  
 Measurement duration: 13 minutes 29 seconds

## Experimental conditions.

<b>Phantom File</b>	surf_sam_plan.txt
<b>Phantom</b>	Validation plane
<b>Band</b>	1900MHz
<b>Signal</b>	CW
<b>Frequency (MHz)</b>	1900.000000
<b>Relative permittivity (real part)</b>	40.331547
<b>Conductivity (S/m)</b>	1.434125
<b>Power drift (%)</b>	0.150000
<b>Ambient Temperature:</b>	21.8C
<b>Liquid Temperature:</b>	20.6C
<b>ConvF:</b>	2.35
<b>Crest factor:</b>	1:1

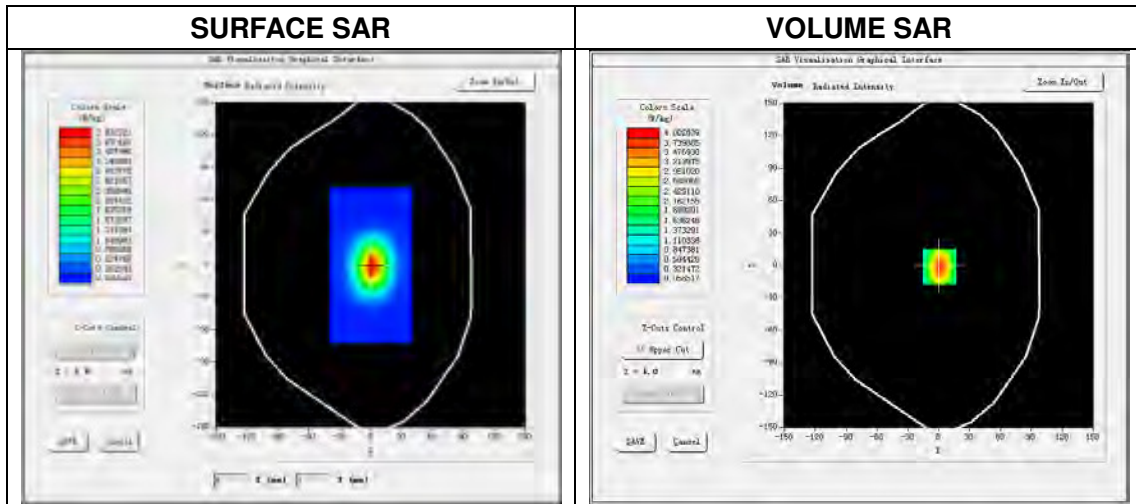

Maximum location: X=1.00, Y=0.00  
 SAR Peak: 6.58W/kg

SAR 10g (W/Kg)	1.974124
SAR 1g (W/Kg)	3.950074

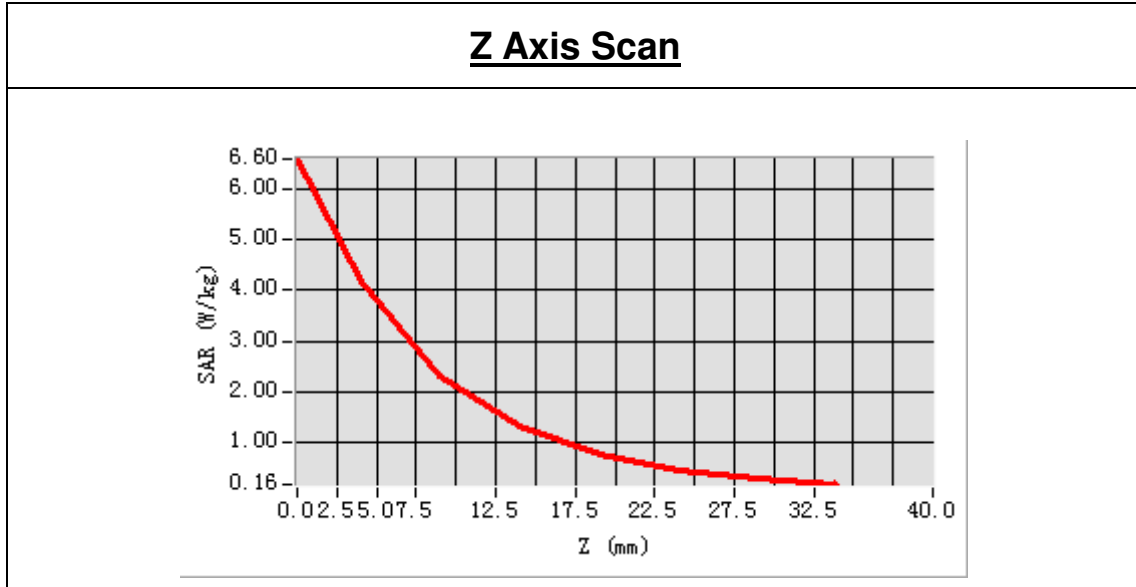

3D screen shot	Hot spot position



# System Performance Check Data(1900MHz Body)

Type: Phone measurement (Complete)  
 E-Field Probe: SN 34/15 SSE2 EPGO265  
 Area scan resolution: dx=8mm,dy=8mm  
 Zoom scan resolution: dx=8mm, dy=8mm, dz=5mm  
 Date of measurement: 2016.11.25  
 Measurement duration: 13 minutes 32 seconds

## Experimental conditions.

Phantom File	surf_sam_plan.txt
Phantom	Validation plane
Band	1900MHz
Signal	CW
Frequency (MHz)	1900.000000
Relative permittivity (real part)	51.293651
Conductivity (S/m)	1.540223
Power drift (%)	0.310000
Ambient Temperature:	21.9C
Liquid Temperature:	20.6C
ConvF:	2.42
Crest factor:	1:1

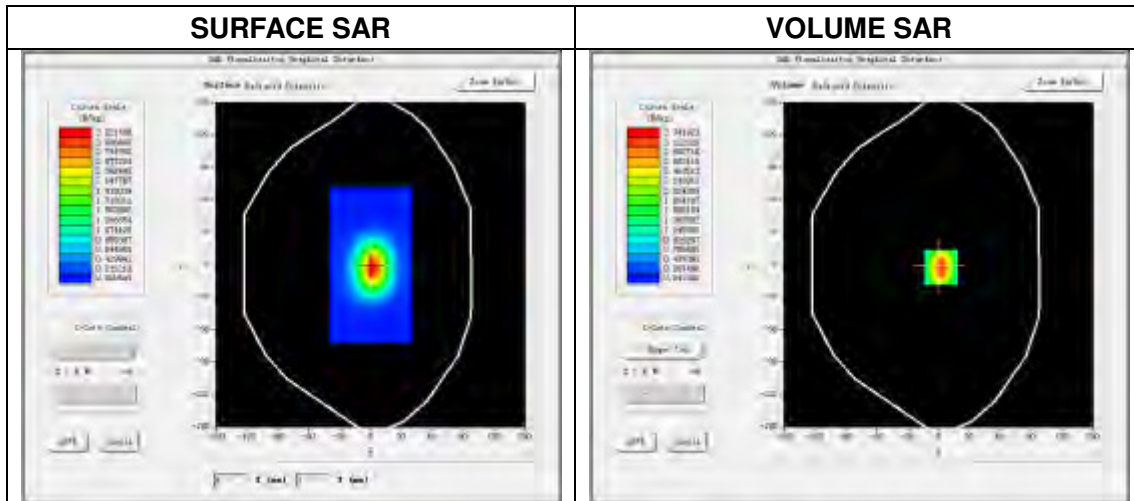

Maximum location: X=2.00, Y=-2.00  
 SAR Peak: 6.95W/kg

SAR 10g (W/Kg)	1.986528
SAR 1g (W/Kg)	4.117212

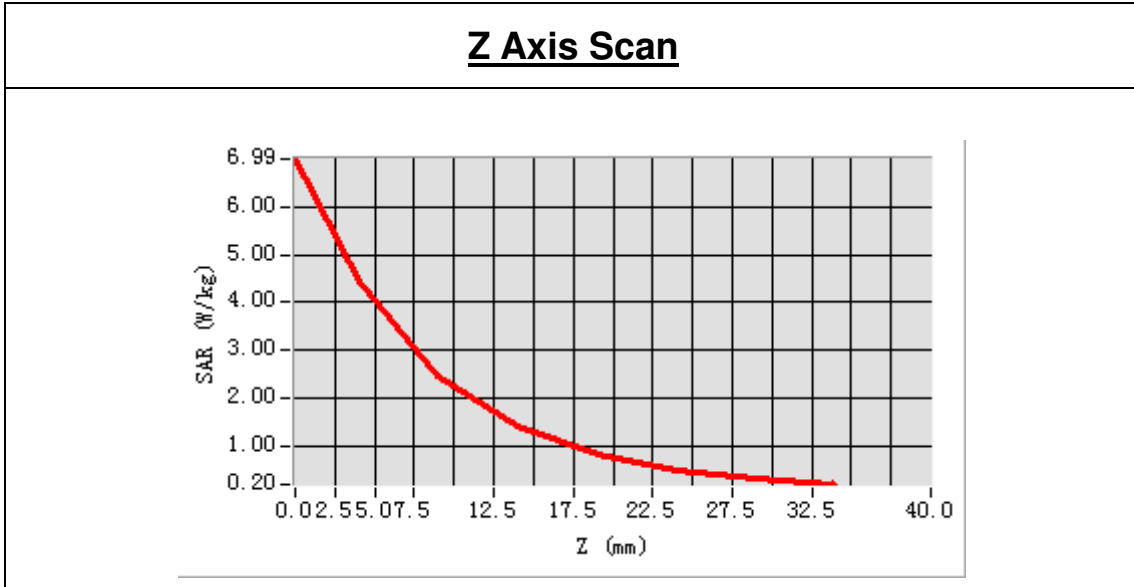

3D screen shot	Hot spot position

# System Performance Check Data(2450MHz Head)

Type: Phone measurement (Complete)  
 E-Field Probe: SN 34/15 SSE2 EPGO265  
 Area scan resolution: dx=8mm,dy=8mm  
 Zoom scan resolution: dx=5mm, dy=5mm, dz=5mm  
 Date of measurement: 2016.11.27  
 Measurement duration: 18 minutes 58 seconds

## Experimental conditions.

Phantom File	surf_sam_plan.txt
Phantom	Validation plane
Band	2450MHz
Signal	CW
Frequency (MHz)	2450.000000
Relative permittivity (real part)	38.581751
Conductivity (S/m)	1.858692
Power drift (%)	-1.200000
Ambient Temperature:	21.8C
Liquid Temperature:	20.4C
ConvF:	2.47
Crest factor:	1:1

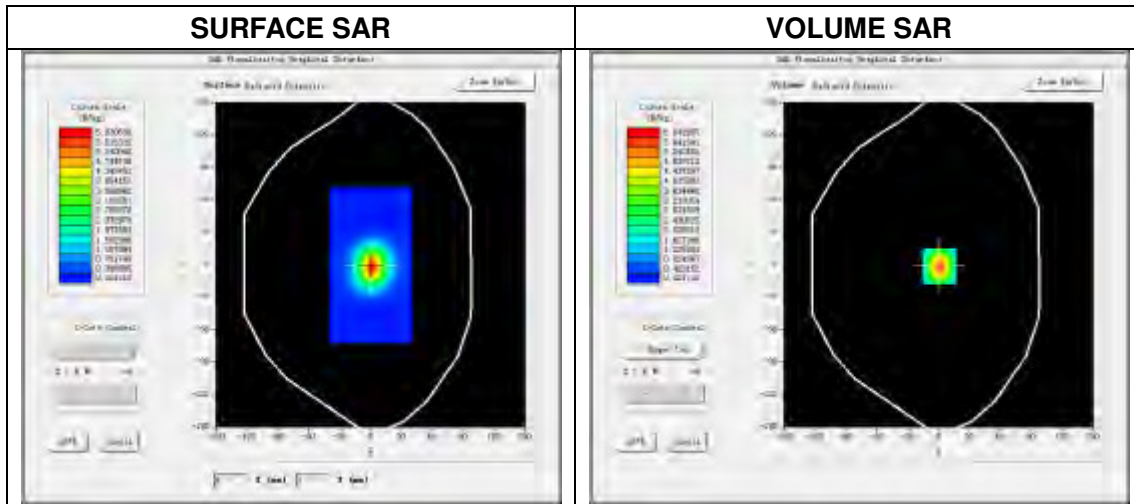

Maximum location: X=1.00, Y=-1.00  
 SAR Peak: 9.56W/kg

SAR 10g (W/Kg)	2.287265
SAR 1g (W/Kg)	5.355232

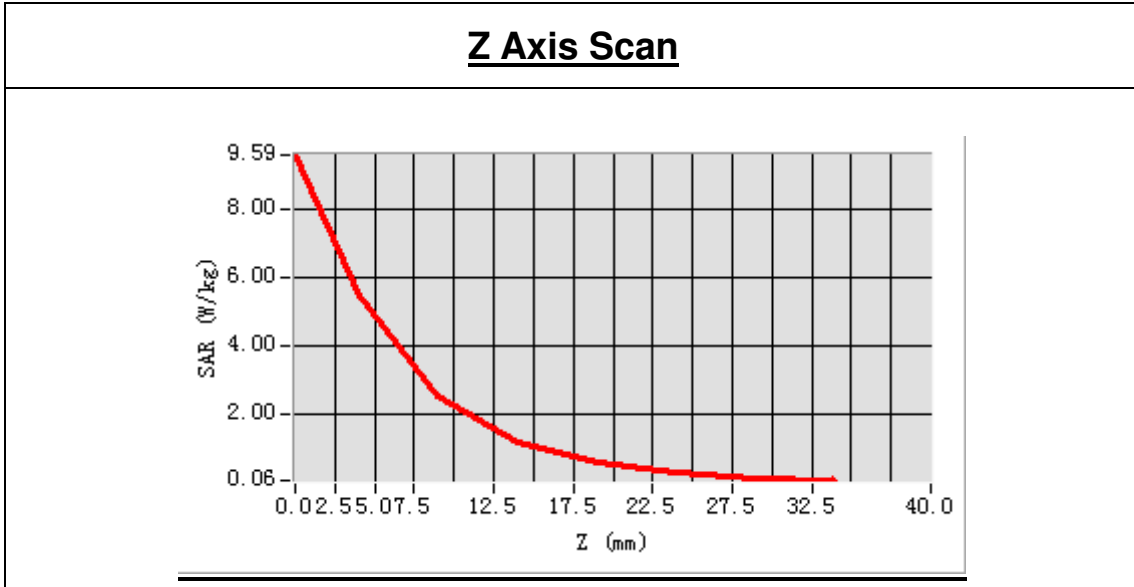

3D screen shot	Hot spot position

# System Performance Check Data(2450MHz Body)

Type: Phone measurement (Complete)  
 E-Field Probe: SN 34/15 SSE2 EPGO265  
 Area scan resolution: dx=8mm,dy=8mm  
 Zoom scan resolution: dx=5mm, dy=5mm, dz=5mm  
 Date of measurement: 2016.11.27  
 Measurement duration: 18 minutes 52 seconds

## Experimental conditions.

<b>Phantom File</b>	surf_sam_plan.txt
<b>Phantom</b>	Validation plane
<b>Band</b>	2450MHz
<b>Signal</b>	CW
<b>Frequency (MHz)</b>	2450.000000
<b>Relative permittivity (real part)</b>	52.271254
<b>Conductivity (S/m)</b>	1.989652
<b>Power drift (%)</b>	0.200000
<b>Ambient Temperature:</b>	21.8C
<b>Liquid Temperature:</b>	20.4C
<b>ConvF:</b>	2.55
<b>Crest factor:</b>	1:1

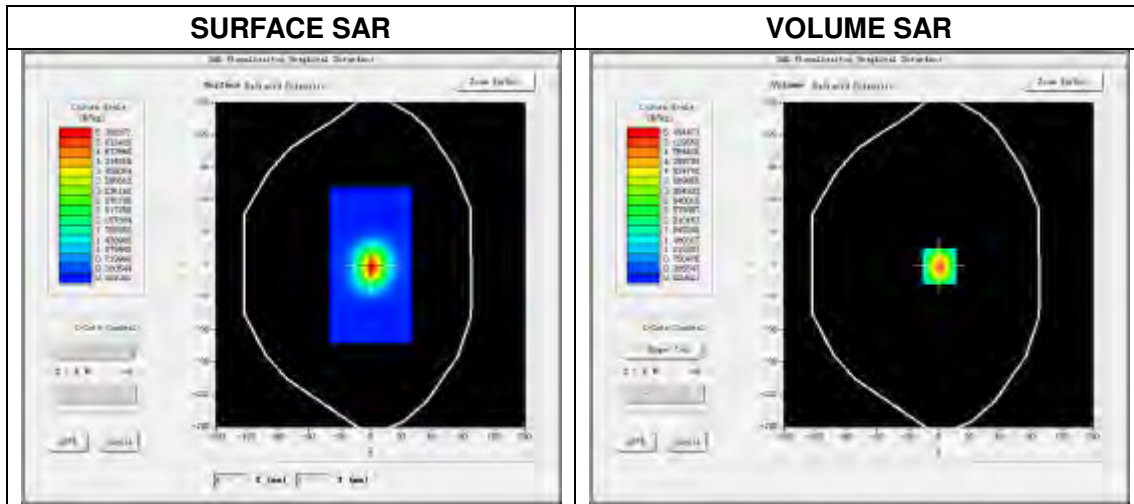

Maximum location: X=1.00, Y=-1.00  
 SAR Peak: 9.71W/kg

SAR 10g (W/Kg)	2.318924
SAR 1g (W/Kg)	5.463569

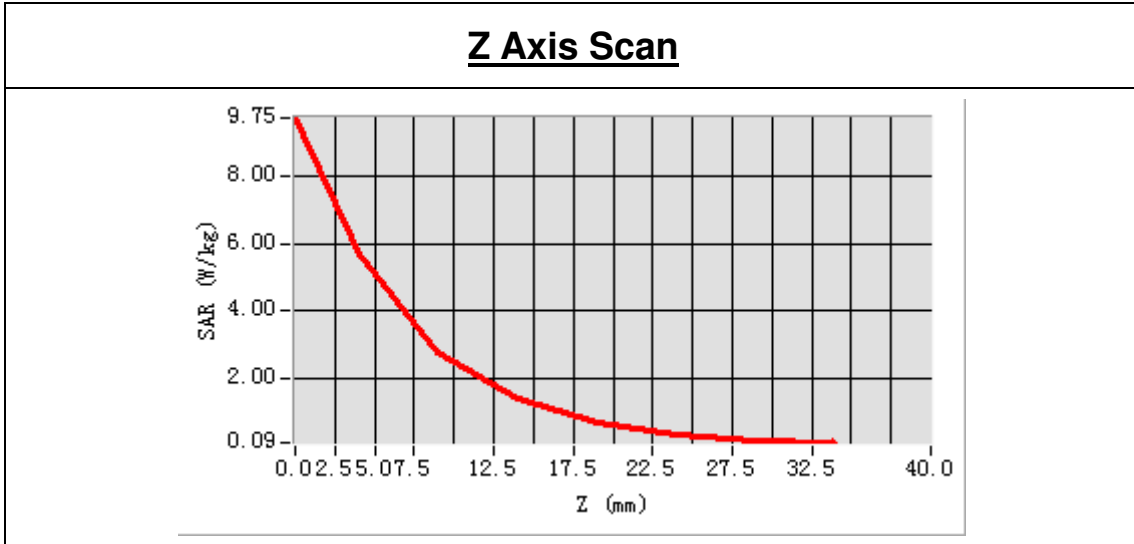

3D screen shot	Hot spot position

# System Performance Check Data(2600MHz Head)

Type: Phone measurement (Complete)  
 E-Field Probe: SN 34/15 SSE2 EPGO265  
 Area scan resolution: dx=8mm,dy=8mm  
 Zoom scan resolution: dx=5mm, dy=5mm, dz=5mm  
 Date of measurement: 2016.11.27  
 Measurement duration: 18 minutes 52 seconds

## Experimental conditions.

<b>Phantom File</b>	surf_sam_plan.txt
<b>Phantom</b>	Validation plane
<b>Band</b>	2600MHz
<b>Signal</b>	CW
<b>Frequency (MHz)</b>	2600.000000
<b>Relative permittivity (real part)</b>	37.223556
<b>Conductivity (S/m)</b>	1.991238
<b>Power drift (%)</b>	0.250000
<b>Ambient Temperature:</b>	21.8C
<b>Liquid Temperature:</b>	20.4C
<b>ConvF:</b>	2.36
<b>Crest factor:</b>	1:1

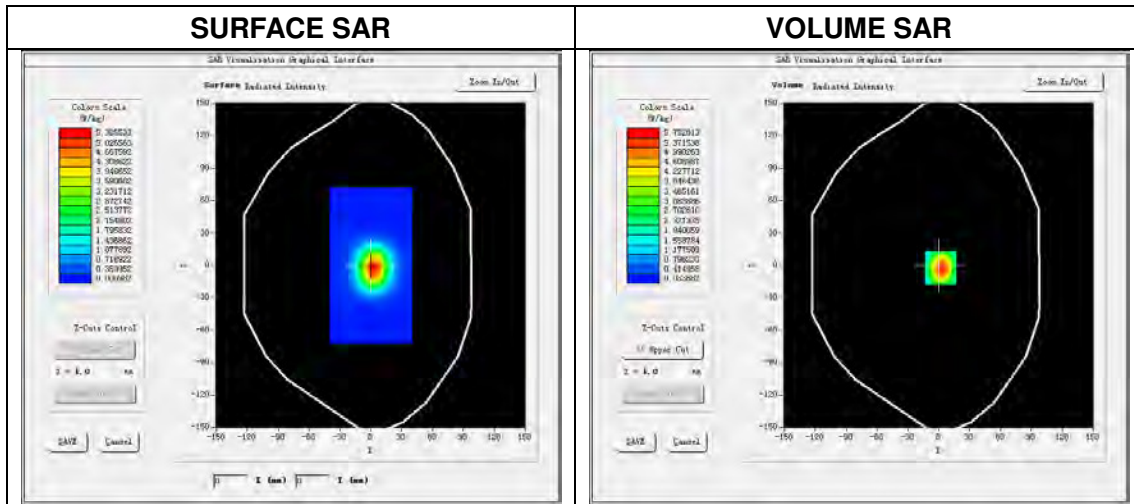

Maximum location: X=3.00, Y=1.00  
 SAR Peak: 9.48W/kg

SAR 10g (W/Kg)	2.293244
SAR 1g (W/Kg)	5.361480

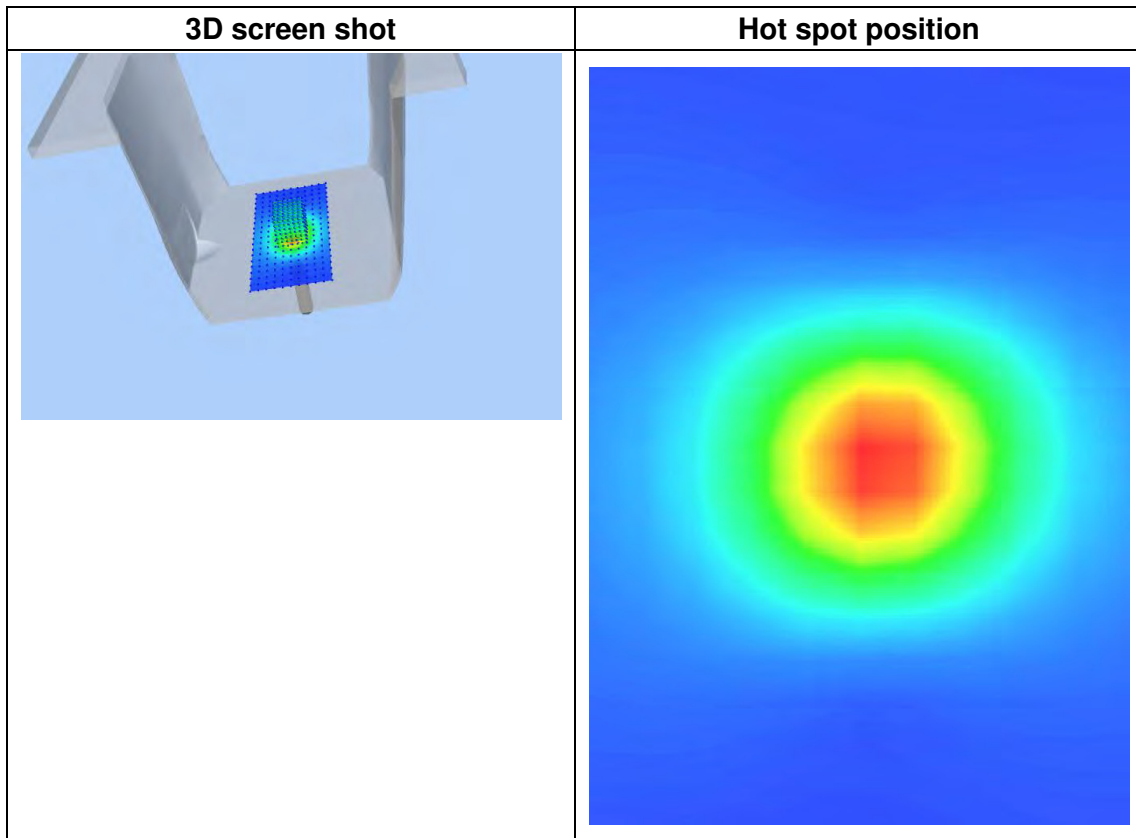
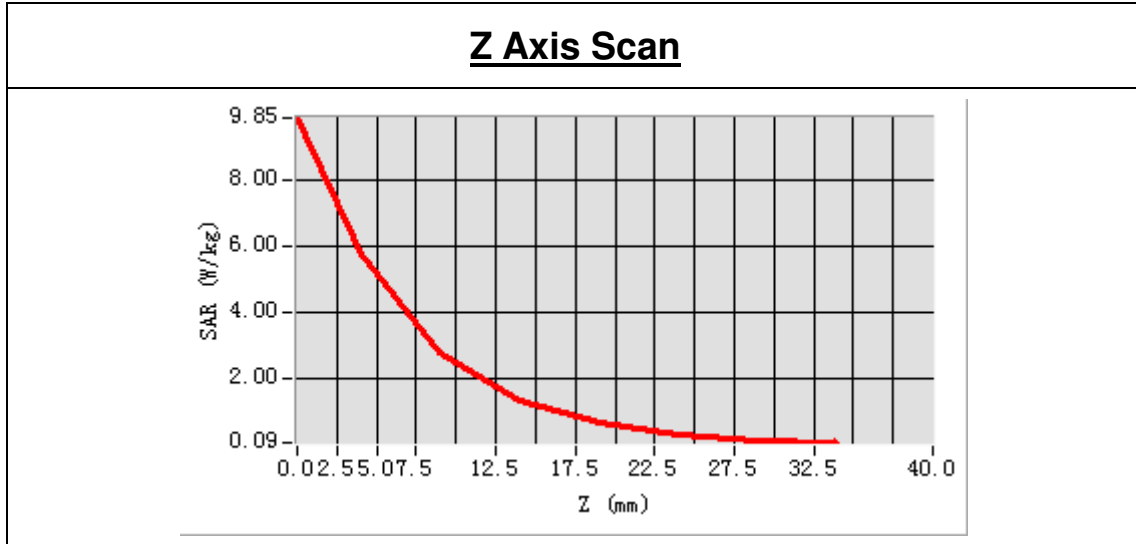



# System Performance Check Data(2600MHz Body)

Type: Phone measurement (Complete)  
 E-Field Probe: SN 34/15 SSE2 EPGO265  
 Area scan resolution: dx=8mm,dy=8mm  
 Zoom scan resolution: dx=5mm, dy=5mm, dz=5mm  
 Date of measurement: 2016.11.27  
 Measurement duration: 18 minutes 43 seconds

## Experimental conditions.

Phantom File	surf_sam_plan.txt
Phantom	Validation plane
Band	2600MHz
Signal	CW
Frequency (MHz)	2600.000000
Relative permittivity (real part)	51.468572
Conductivity (S/m)	2.082159
Power drift (%)	-0.210000
Ambient Temperature:	21.8C
Liquid Temperature:	20.4C
ConvF:	2.43
Crest factor:	1:1

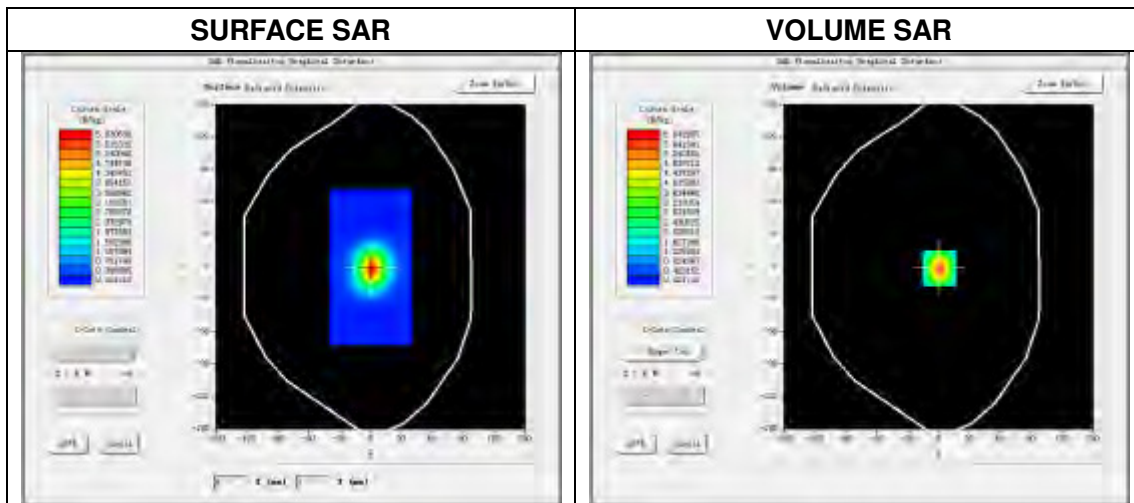

Maximum location: X=1.00, Y=-1.00  
 SAR Peak: 10.29W/kg

SAR 10g (W/Kg)	2.419457
SAR 1g (W/Kg)	5.517554

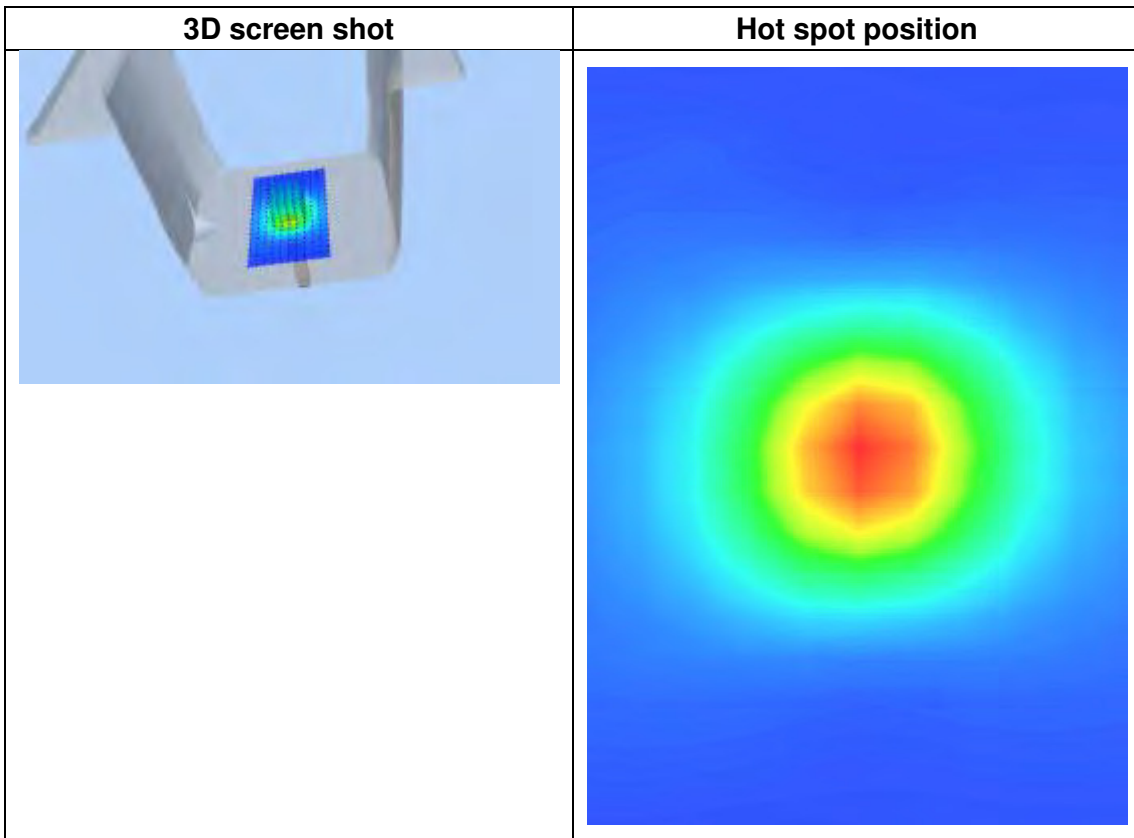
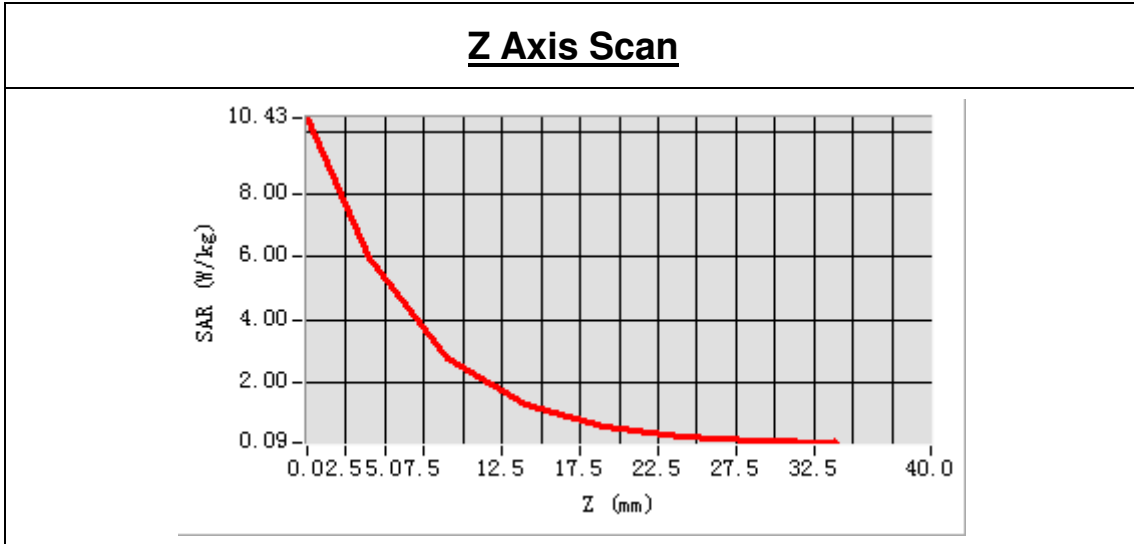

## ANNEX C TEST DATA

### MEAS. 1 Right Head with Cheek on Low Channel in GSM 850 mode

**Test Date:** 24/11/2016  
**Measurement duration:** 10 minutes 5 seconds  
**Signal:** GSM, f=824.2 MHz, Duty Cycle: 1:8.3  
**Liquid Parameters:** Permittivity: 41.79; Conductivity: 0.88 S/m  
**Test condition:** Ambient Temperature: 22.6°C, Liquid Temperature: 21.1°C  
**Probe:** SN 34/15 SSE2 EPGO265, ConvF: 2.04  
**Area Scan:** sam\_direct\_droit2\_surf12mm.txt, h= 5.00 mm  
**Zoom Scan:** 5x5x7,dx=8mm, dy=8mm, dz=5mm,Complete  
**Maximum location:** X=-48.000000, Y=-36.000000  
**SAR 10g (W/Kg):** 0.176240  
**SAR 1g (W/Kg):** 0.246177  
**Power drift (%):** -3.30  
**3D screen shot**

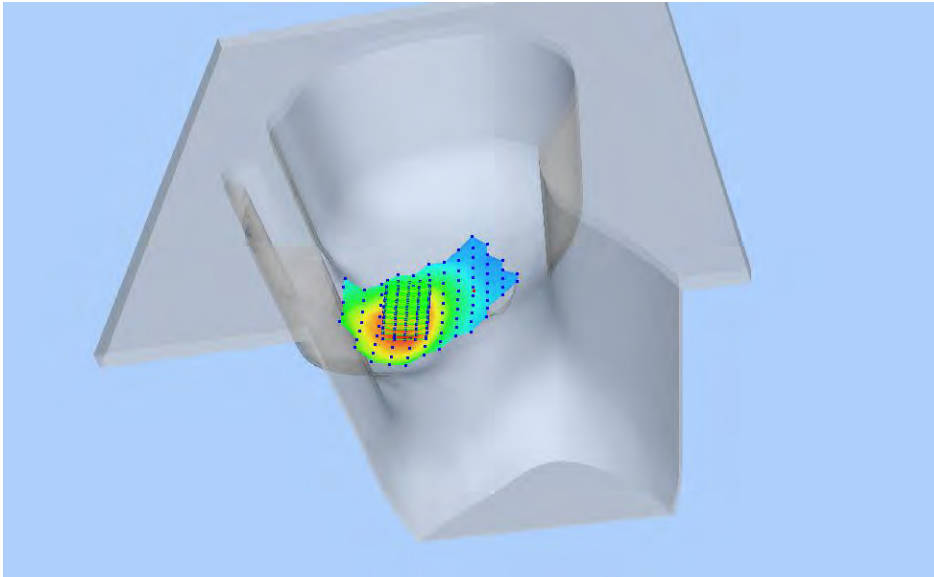

#### Z Axis Scan

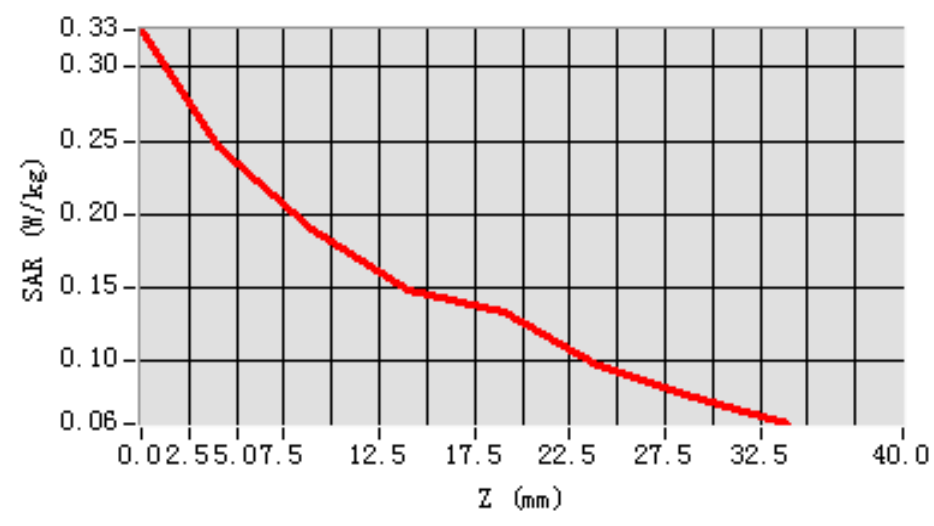

## MEAS. 2 Body Plane with Back Side on High Channel in GPRS850-4slots

### mode

**Test Date:** 24/11/2016  
**Measurement duration:** 12 minutes 29 seconds  
**Signal:** GSM, f=848.8 MHz, Duty Cycle: 1:2.0  
**Liquid Parameters:** Permittivity: 52.82; Conductivity: 0.98 S/m  
**Test condition:** Ambient Temperature: 22.6°C, Liquid Temperature: 21.1°C  
**Probe:** SN 34/15 SSE2 EPGO265, ConvF: 2.12  
**Area Scan:** sam\_direct\_droit2\_surf12mm.txt, h= 5.00 mm  
**Zoom Scan:** 5x5x7,dx=8mm, dy=8mm, dz=5mm,Complete  
**Maximum location:** X=8.000000, Y=0.000000  
**SAR 10g (W/Kg):** 0.365653  
**SAR 1g (W/Kg):** 0.491854  
**Power drift (%):** 0.04  
**3D screen shot**

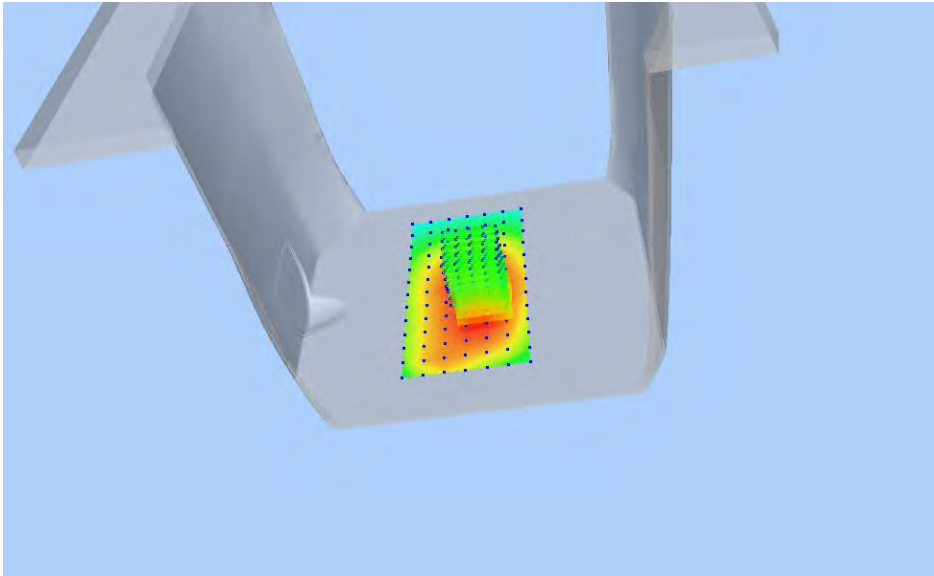

### Z Axis Scan

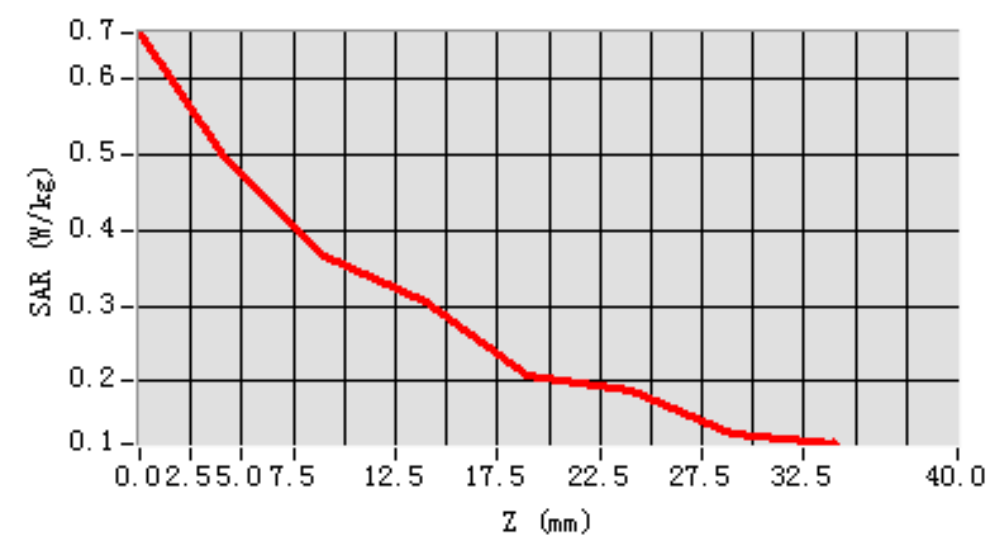

### MEAS. 3 Right Head with Cheek on High Channel in GSM 1900 mode

**Test Date:** 28/11/2016  
**Measurement duration:** 10 minutes 38 seconds  
**Signal:** GSM, f=1909.8 MHz, Duty Cycle: 1:8.3  
**Liquid Parameters:** Permittivity: 40.21; Conductivity: 1.44 S/m  
**Test condition:** Ambient Temperature: 21.8°C, Liquid Temperature: 20.6°C  
**Probe:** SN 34/15 SSE2 EPGO265, ConvF: 2.35  
**Area Scan:** sam\_direct\_droit2\_surf12mm.txt, h= 5.00 mm  
**Zoom Scan:** 5x5x7,dx=8mm, dy=8mm, dz=5mm,Complete  
**Maximum location:** X=-48.000000, Y=-60.000000  
**SAR 10g (W/Kg):** 0.106318  
**SAR 1g (W/Kg):** 0.177944  
**Power drift (%):** -1.35  
**3D screen shot**

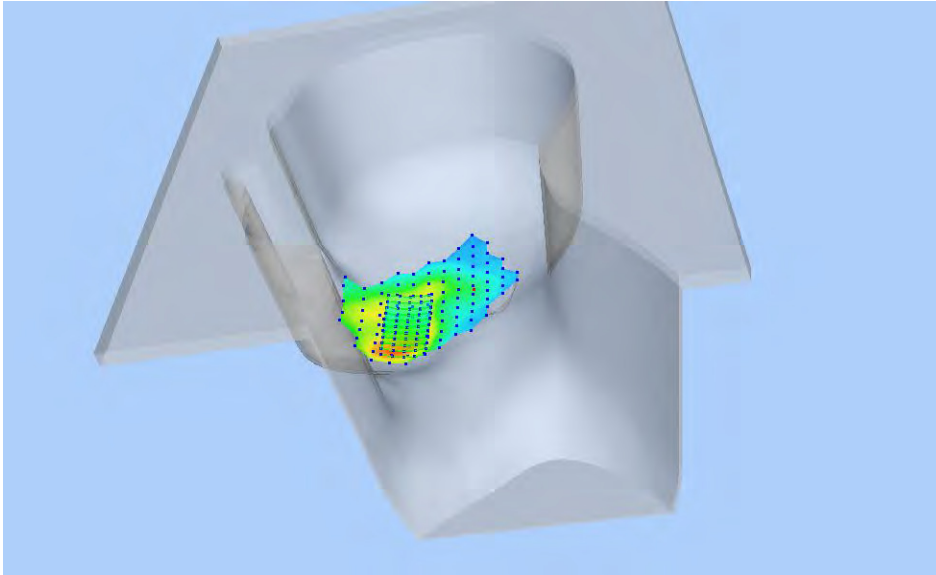

#### Z Axis Scan

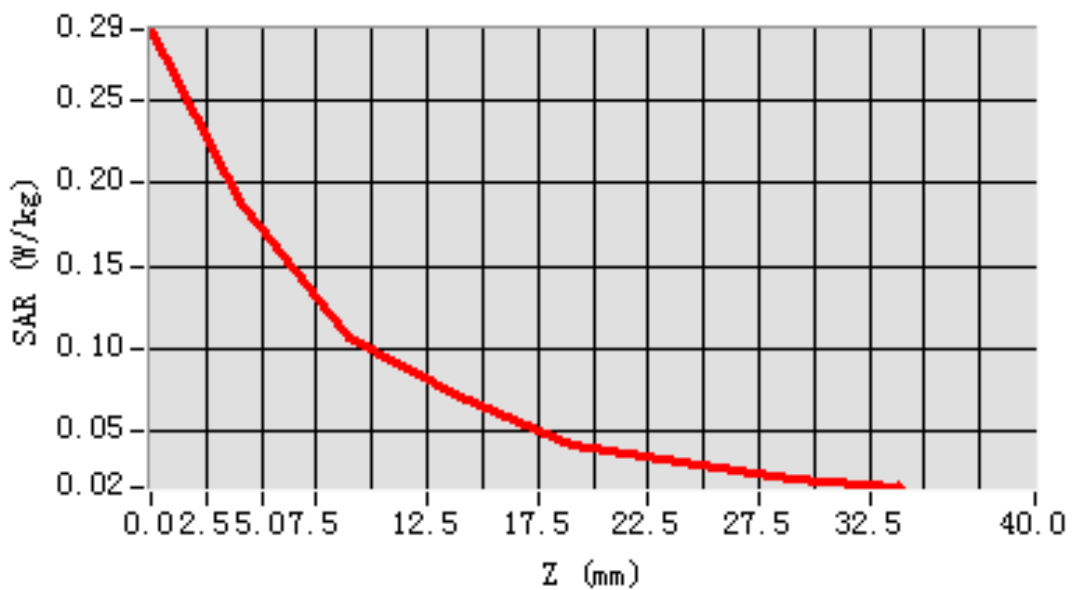

## MEAS. 4 Body Plane with Bottom Edge on Middle Channel in

### GPRS1900-4slots mode

**Test Date:** 25/11/2016  
**Measurement duration:** 11 minutes 54 seconds  
**Signal:** GSM, f=1880.0 MHz, Duty Cycle: 1:2.0  
**Liquid Parameters:** Permittivity: 51.56; Conductivity: 1.53 S/m  
**Test condition:** Ambient Temperature: 21.9°C, Liquid Temperature: 20.6°C  
**Probe:** SN 34/15 SSE2 EPGO265, ConvF: 2.42  
**Area Scan:** sam\_direct\_droit2\_surf12mm.txt, h= 5.00 mm  
**Zoom Scan:** 5x5x7,dx=8mm, dy=8mm, dz=5mm,Complete  
**Maximum location:** X=8.000000, Y=0.000000  
**SAR 10g (W/Kg):** 0.461074  
**SAR 1g (W/Kg):** 0.874168  
**Power drift (%):** -2.37  
**3D screen shot**

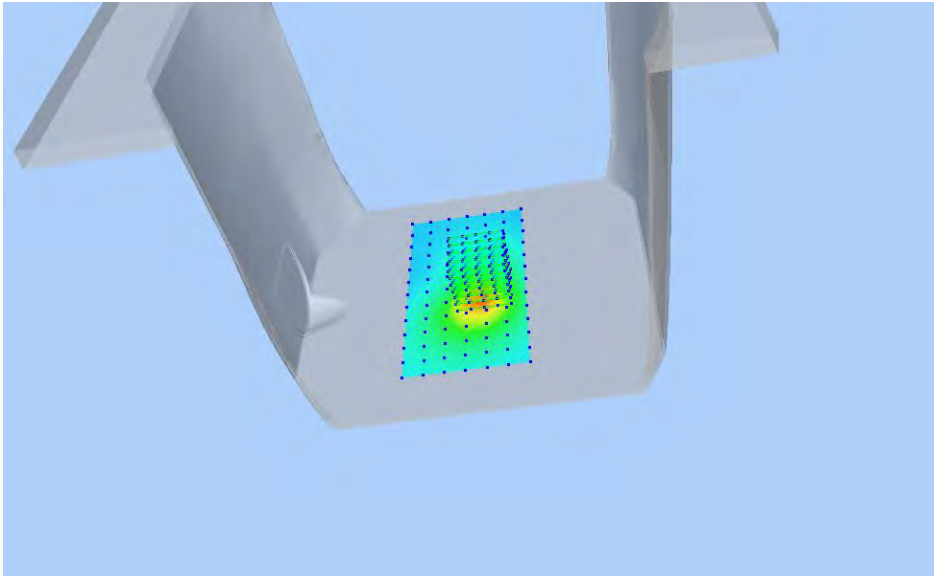

### Z Axis Scan

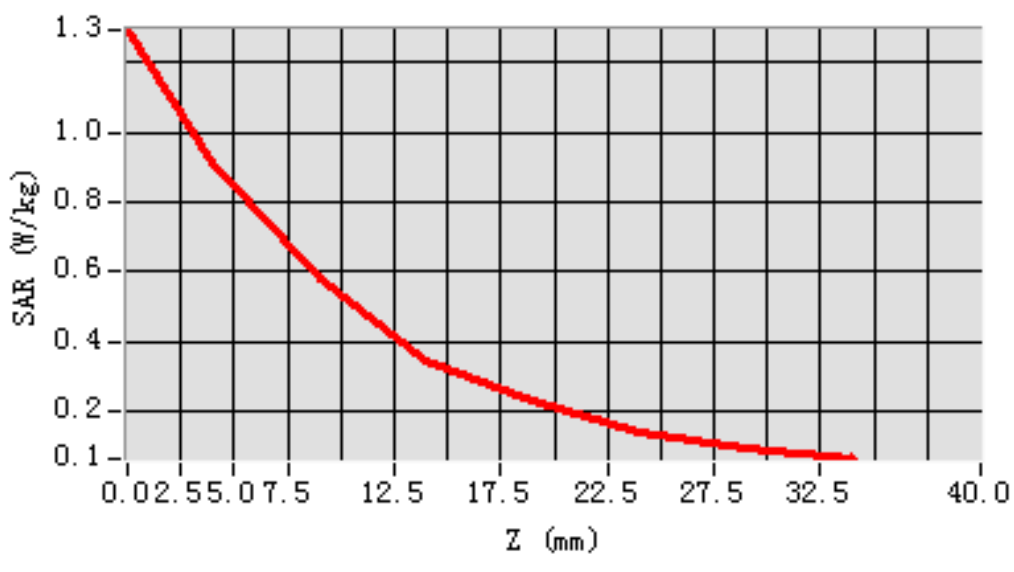

## MEAS. 5 Right Head with Cheek on Low Channel in WCDMA Band2 mode

**Test Date:** 28/11/2016  
**Measurement duration:** 11 minutes 19 seconds  
**Signal:** WCDMA, f=1852.4 MHz, Duty Cycle: 1:1.0  
**Liquid Parameters:** Permittivity: 40.68; Conductivity: 1.39 S/m  
**Test condition:** Ambient Temperature: 21.8°C, Liquid Temperature: 20.6°C  
**Probe:** SN 34/15 SSE2 EPGO265, ConvF: 2.35  
**Area Scan:** sam\_direct\_droit2\_surf12mm.txt, h= 5.00 mm  
**Zoom Scan:** 5x5x7,dx=8mm, dy=8mm, dz=5mm,Complete  
**Maximum location:** X=-60.000000, Y=-60.000000  
**SAR 10g (W/Kg):** 0.201696  
**SAR 1g (W/Kg):** 0.336865  
**Power drift (%):** -1.14  
**3D screen shot**

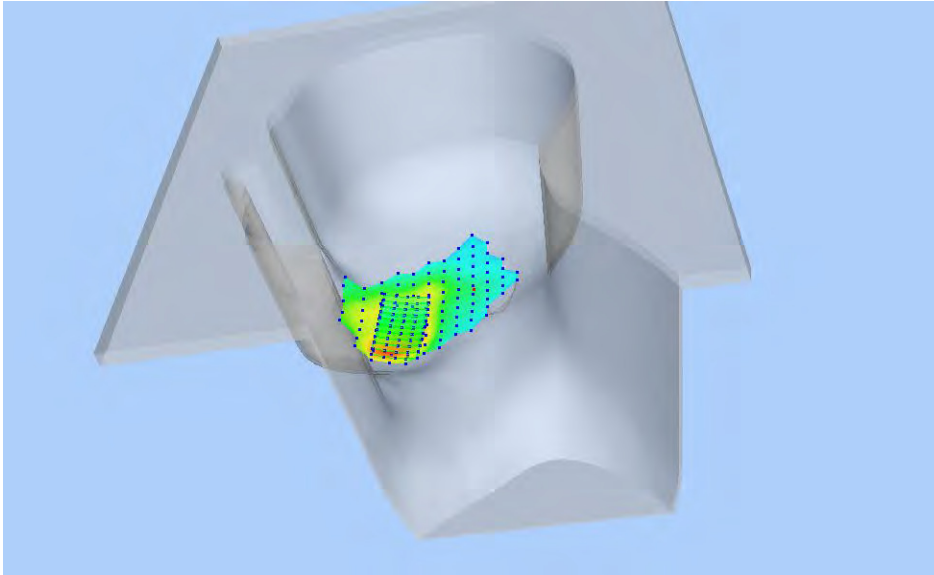

### Z Axis Scan

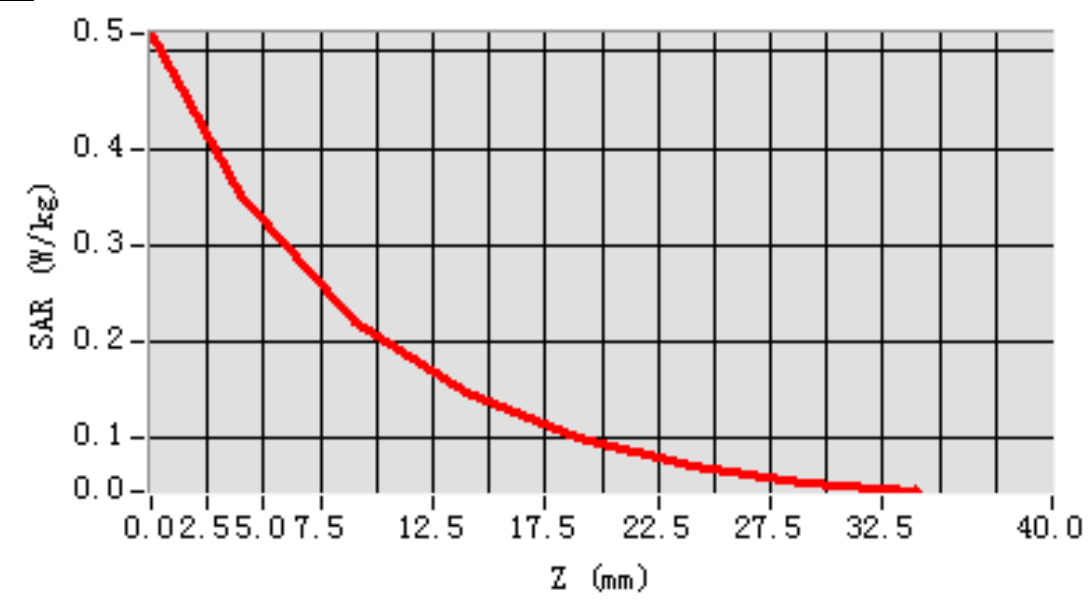

## MEAS. 6 Body Plane with Bottom Edge on Low Channel in WCDMA Band2

### mode

**Test Date:** 25/11/2016  
**Measurement duration:** 11 minutes 47 seconds  
**Signal:** WCDMA, f=1852.4 MHz, Duty Cycle: 1:1.0  
**Liquid Parameters:** Permittivity: 52.92; Conductivity: 1.51 S/m  
**Test condition:** Ambient Temperature: 21.9°C, Liquid Temperature: 20.6°C  
**Probe:** SN 34/15 SSE2 EPGO265, ConvF: 2.42  
**Area Scan:** sam\_direct\_droit2\_surf12mm.txt, h= 5.00 mm  
**Zoom Scan:** 5x5x7,dx=8mm, dy=8mm, dz=5mm,Complete  
**Maximum location:** X=8.000000, Y=-12.000000  
**SAR 10g (W/Kg):** 0.454856  
**SAR 1g (W/Kg):** 0.844701  
**Power drift (%):** -0.37  
**3D screen shot**

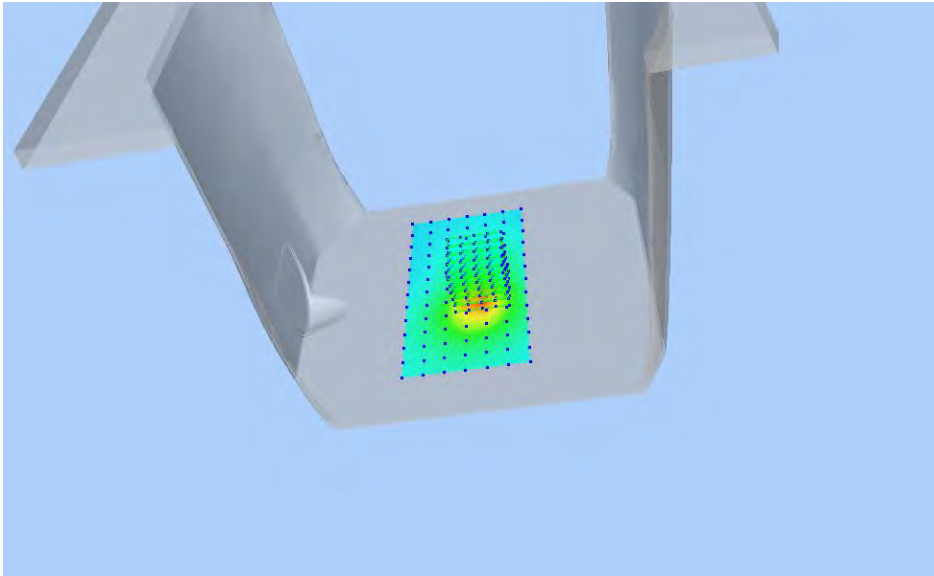

### Z Axis Scan

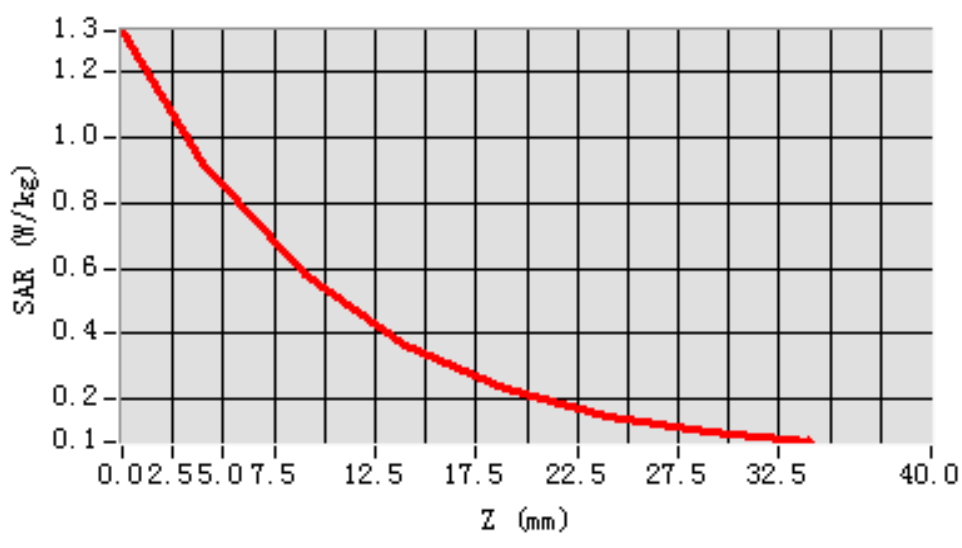



## MEAS. 7 Right Head with Cheek on High Channel in WCDMA Band5 mode

**Test Date:** 24/11/2016  
**Measurement duration:** 10 minutes 12 seconds  
**Signal:** WCDMA, f=846.6 MHz, Duty Cycle: 1:1.0  
**Liquid Parameters:** Permittivity: 41.34; Conductivity: 0.89 S/m  
**Test condition:** Ambient Temperature: 22.6°C, Liquid Temperature: 21.1°C  
**Probe:** SN 34/15 SSE2 EPGO265, ConvF: 2.04  
**Area Scan:** sam\_direct\_droit2\_surf12mm.txt, h= 5.00 mm  
**Zoom Scan:** 5x5x7,dx=8mm, dy=8mm, dz=5mm,Complete  
**Maximum location:** X=-48.000000, Y=-36.000000  
**SAR 10g (W/Kg):** 0.230490  
**SAR 1g (W/Kg):** 0.297567  
**Power drift (%):** -3.05  
**3D screen shot**

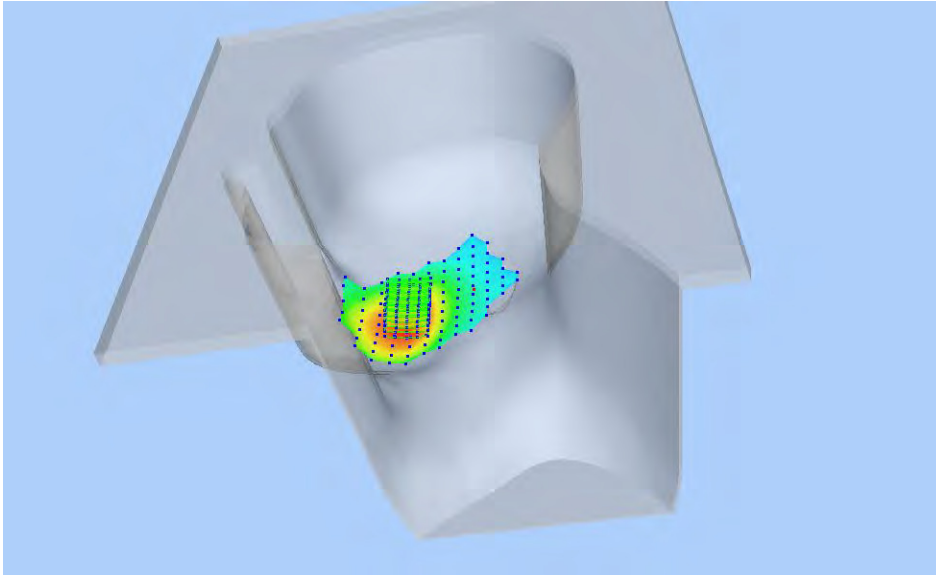

### Z Axis Scan

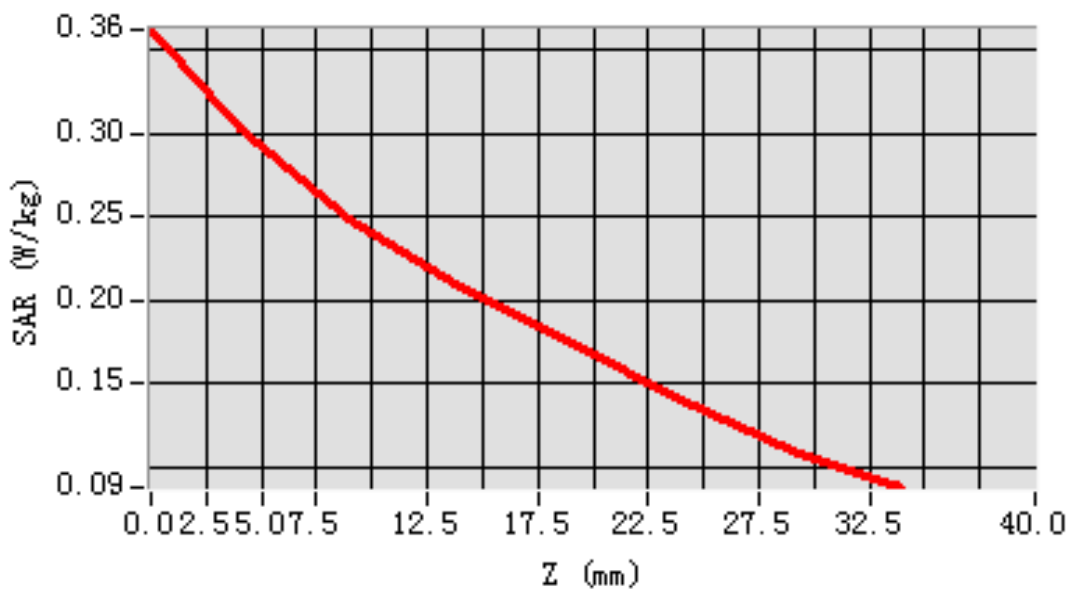

## MEAS. 8 Body Plane with Back Side on High Channel in WCDMA Band5 mode

**Test Date:** 24/11/2016  
**Measurement duration:** 11 minutes 38 seconds  
**Signal:** WCDMA, f=846.6 MHz, Duty Cycle: 1:1.0  
**Liquid Parameters:** Permittivity: 52.99; Conductivity: 0.97 S/m  
**Test condition:** Ambient Temperature: 22.6°C, Liquid Temperature: 21.1°C  
**Probe:** SN 34/15 SSE2 EPGO265, ConvF: 2.12  
**Area Scan:** sam\_direct\_droit2\_surf12mm.txt, h= 5.00 mm  
**Zoom Scan:** 5x5x7,dx=8mm, dy=8mm, dz=5mm,Complete  
**Maximum location:** X=8.000000, Y=0.000000  
**SAR 10g (W/Kg):** 0.274753  
**SAR 1g (W/Kg):** 0.360405  
**Power drift (%):** -0.32  
**3D screen shot**

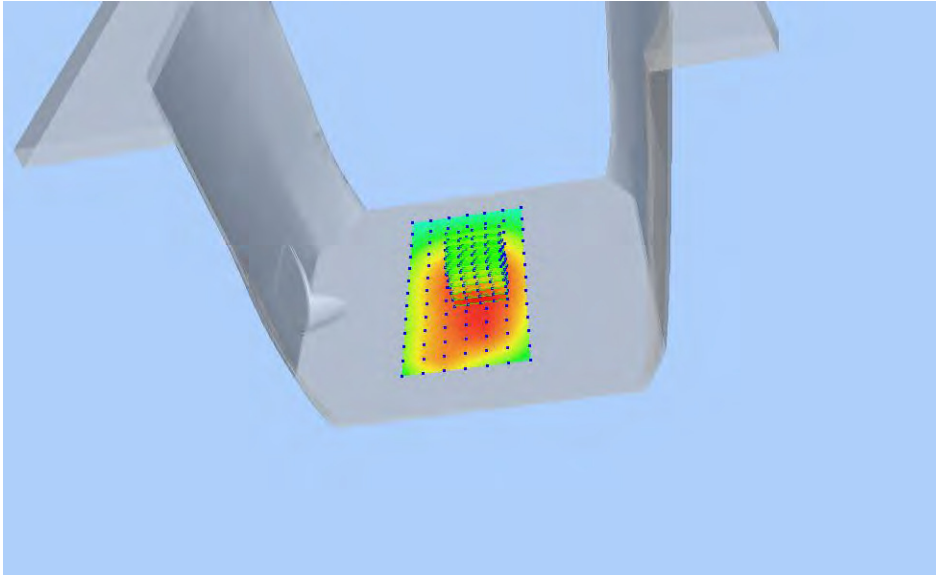

### Z Axis Scan

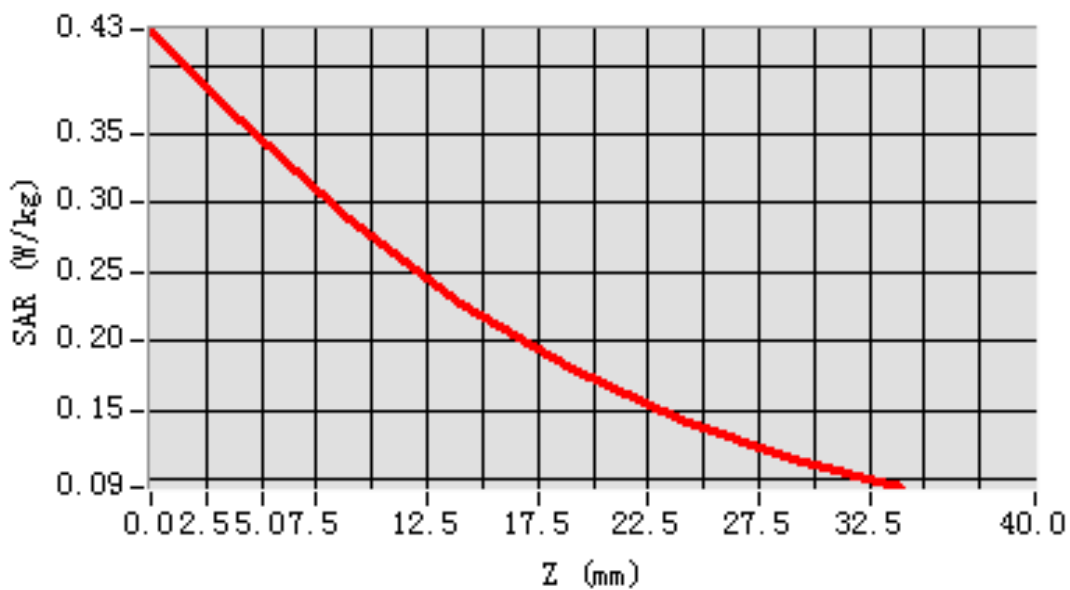

## MEAS. 9 Right Head with Cheek on Low Channel in LTE Band2 mode

**Test Date:** 28/11/2016  
**Measurement duration:** 11 minutes 29 seconds  
**Signal:** LTE, f=1860.0 MHz, Duty Cycle: 1:1.0  
**Liquid Parameters:** Permittivity: 40.53; Conductivity: 1.40 S/m  
**Test condition:** Ambient Temperature: 21.8°C, Liquid Temperature: 20.6°C  
**Probe:** SN 34/15 SSE2 EPGO265, ConvF: 2.35  
**Area Scan:** sam\_direct\_droit2\_surf12mm.txt, h= 5.00 mm  
**Zoom Scan:** 5x5x7,dx=8mm, dy=8mm, dz=5mm,Complete  
**Maximum location:** X=-60.000000, Y=-60.000000  
**SAR 10g (W/Kg):** 0.168421  
**SAR 1g (W/Kg):** 0.277496  
**Power drift (%):** -2.71  
**3D screen shot**

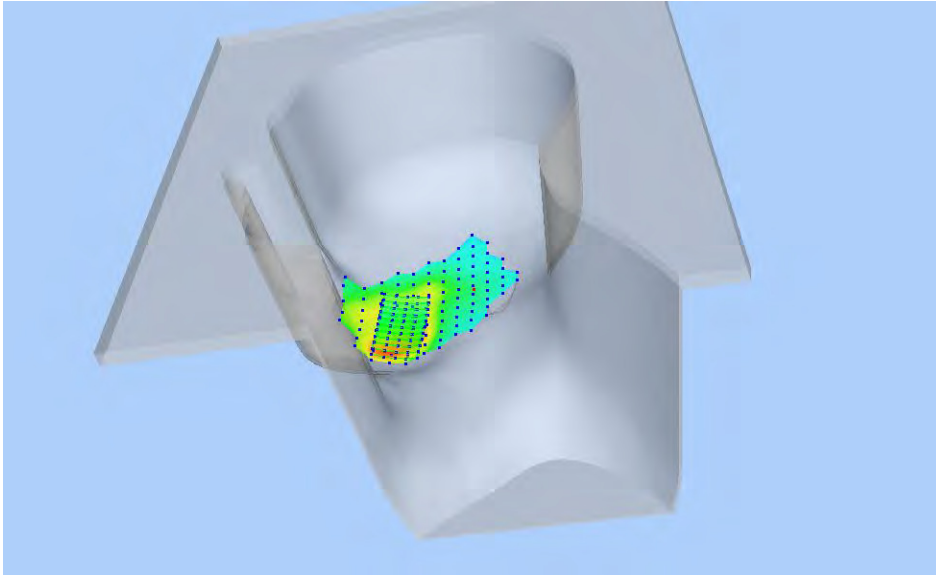

### Z Axis Scan

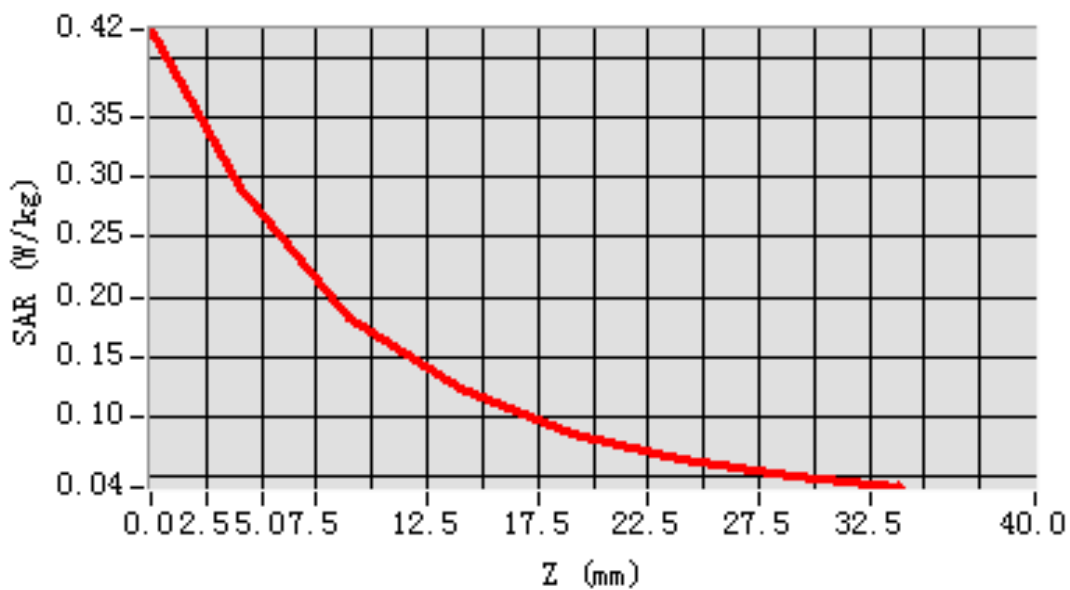

## MEAS. 10 Body Plane with Bottom Edge on Low Channel in LTE Band2 mode

**Test Date:** 25/11/2016  
**Measurement duration:** 12 minutes 23 seconds  
**Signal:** LTE, f=1860.0 MHz, Duty Cycle: 1:1.0  
**Liquid Parameters:** Permittivity: 52.66; Conductivity: 1.52 S/m  
**Test condition:** Ambient Temperature: 21.9°C, Liquid Temperature: 20.6°C  
**Probe:** SN 34/15 SSE2 EPGO265, ConvF: 2.42  
**Area Scan:** sam\_direct\_droit2\_surf12mm.txt, h= 5.00 mm  
**Zoom Scan:** 5x5x7,dx=8mm, dy=8mm, dz=5mm,Complete  
**Maximum location:** X=8.000000, Y=-12.000000  
**SAR 10g (W/Kg):** 0.311846  
**SAR 1g (W/Kg):** 0.566698  
**Power drift (%):** -1.77  
**3D screen shot**

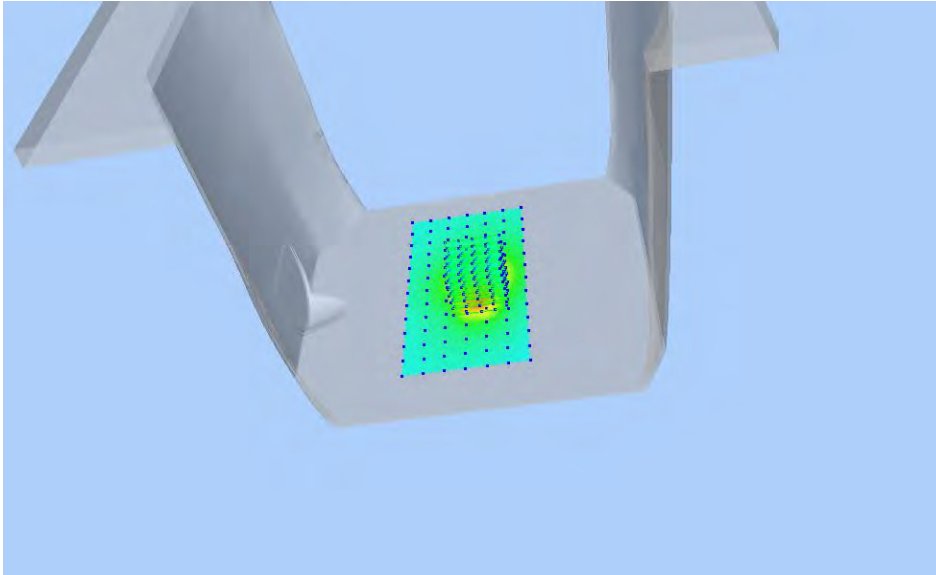

### Z Axis Scan

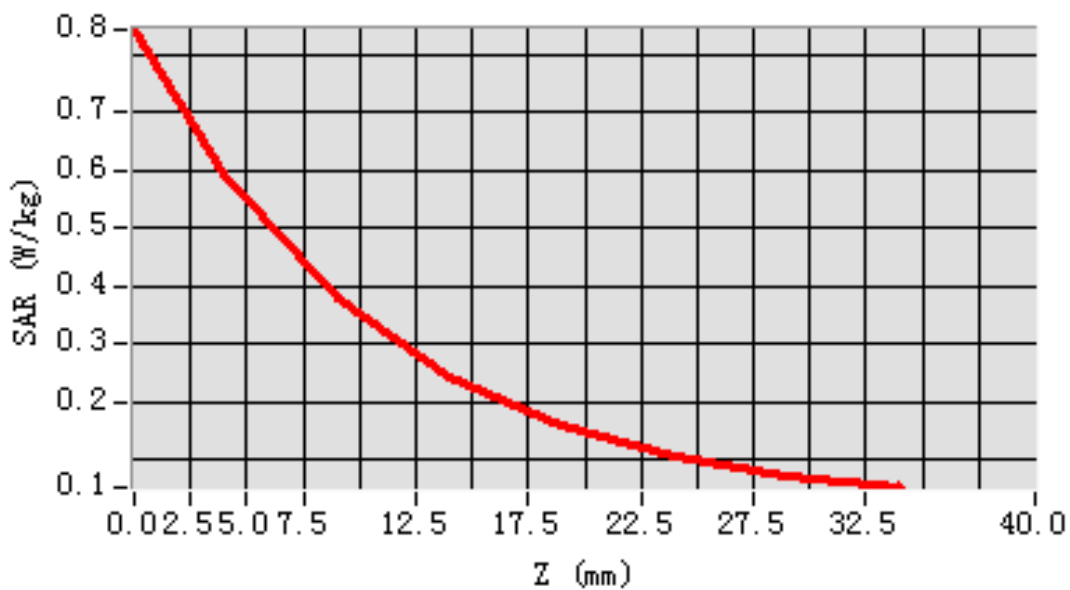

## MEAS. 11 Right Head with Cheek on High Channel in LTE Band4 mode

**Test Date:** 26/11/2016  
**Measurement duration:** 11 minutes 19 seconds  
**Signal:** LTE, f=1745.0 MHz, Duty Cycle: 1:1.0  
**Liquid Parameters:** Permittivity: 39.93; Conductivity: 1.39 S/m  
**Test condition:** Ambient Temperature: 22.3°C, Liquid Temperature: 20.9°C  
**Probe:** SN 34/15 SSE2 EPGO265, ConvF: 2.04  
**Area Scan:** sam\_direct\_droit2\_surf12mm.txt, h= 5.00 mm  
**Zoom Scan:** 5x5x7,dx=8mm, dy=8mm, dz=5mm,Complete  
**Maximum location:** X=-60.000000, Y=-60.000000  
**SAR 10g (W/Kg):** 0.197068  
**SAR 1g (W/Kg):** 0.318646  
**Power drift (%):** -3.46  
**3D screen shot**

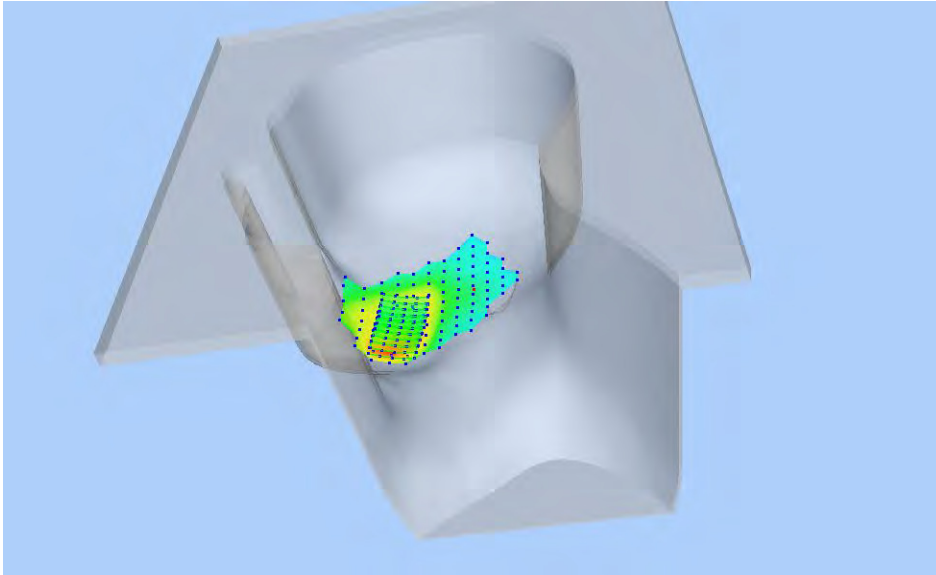

### Z Axis Scan

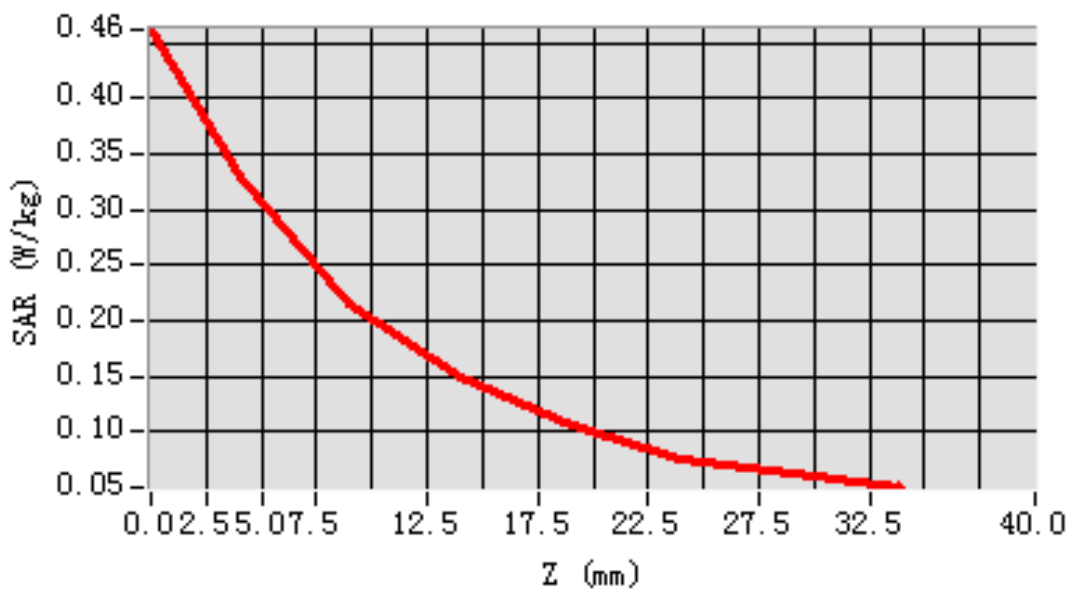

## MEAS. 12 Body Plane with Back Side on High Channel in LTE Band4 mode

**Test Date:** 26/11/2016  
**Measurement duration:** 12 minutes 11 seconds  
**Signal:** LTE, f=1745 MHz, Duty Cycle: 1:1.0  
**Liquid Parameters:** Permittivity: 53.55; Conductivity: 1.47 S/m  
**Test condition:** Ambient Temperature: 22.3°C, Liquid Temperature: 20.9°C  
**Probe:** SN 34/15 SSE2 EPGO265, ConvF: 2.08  
**Area Scan:** sam\_direct\_droit2\_surf12mm.txt, h= 5.00 mm  
**Zoom Scan:** 5x5x7,dx=8mm, dy=8mm, dz=5mm,Complete  
**Maximum location:** X=-16.000000, Y=12.000000  
**SAR 10g (W/Kg):** 0.296444  
**SAR 1g (W/Kg):** 0.498813  
**Power drift (%):** -2.19  
**3D screen shot**

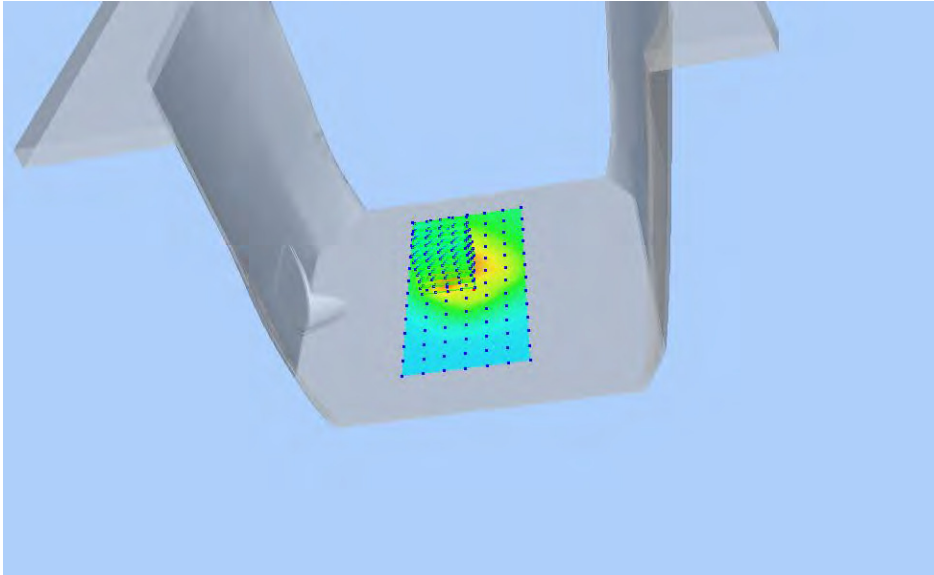

### Z Axis Scan

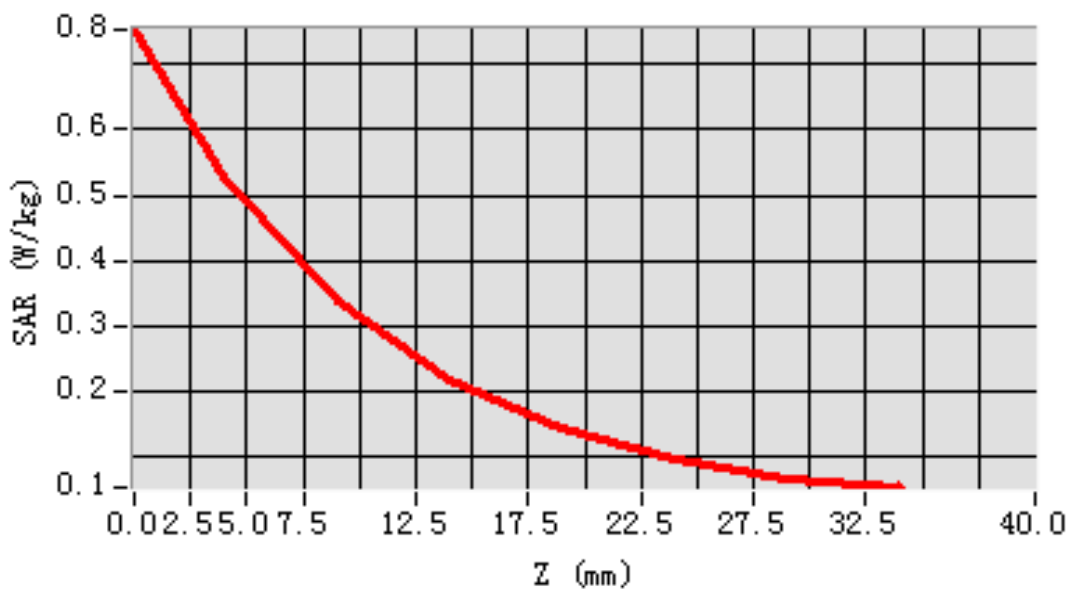

## MEAS. 13 Right Head with Cheek on High Channel in LTE Band7 mode

**Test Date:** 27/11/2016  
**Measurement duration:** 14 minutes 49 seconds  
**Signal:** LTE, f=2560.0 MHz, Duty Cycle: 1:1.0  
**Liquid Parameters:** Permittivity: 37.69; Conductivity: 1.97 S/m  
**Test condition:** Ambient Temperature: 21.8°C, Liquid Temperature: 20.4°C  
**Probe:** SN 34/15 SSE2 EPGO265, ConvF: 2.36  
**Area Scan:** sam\_direct\_droit2\_surf12mm.txt, h= 5.00 mm  
**Zoom Scan:** 7x7x7,dx=5mm, dy=5mm, dz=5mm,Complete  
**Maximum location:** X=-48.000000, Y=-48.000000  
**SAR 10g (W/Kg):** 0.204382  
**SAR 1g (W/Kg):** 0.380308  
**Power drift (%):** -2.68  
**3D screen shot**

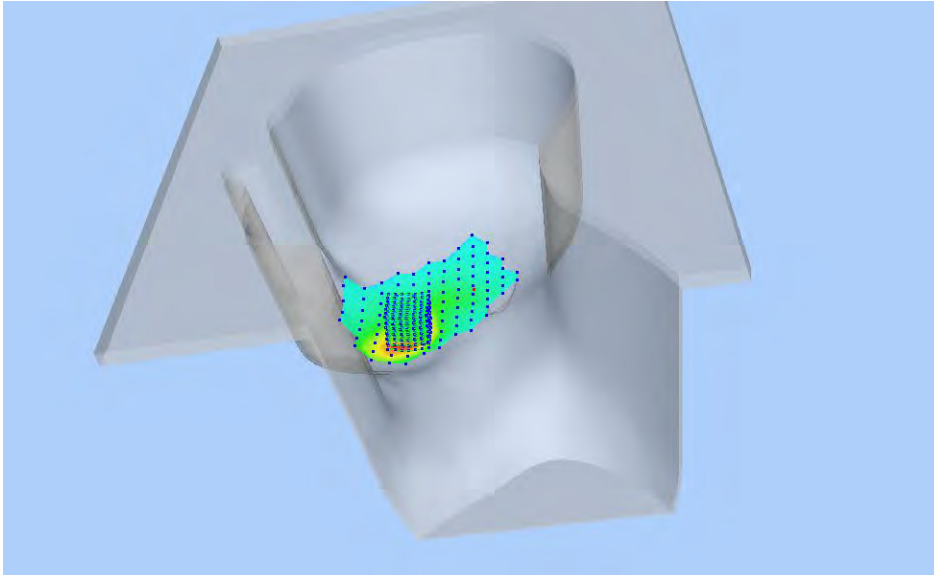

### Z Axis Scan

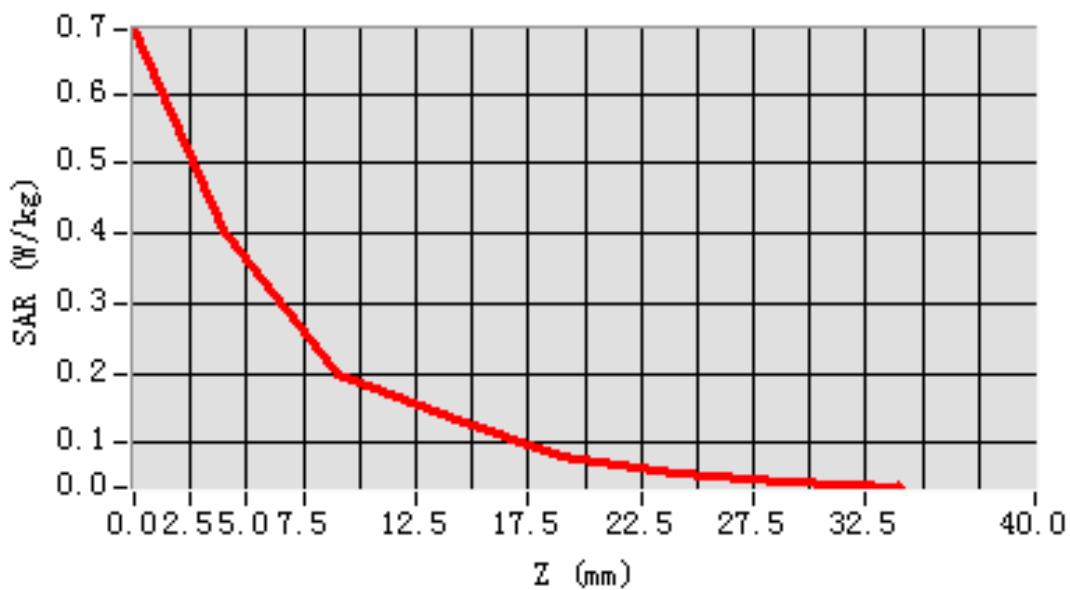

## MEAS. 14 Body Plane with Bottom Edge on High Channel in LTE Band7 mode

**Test Date:** 27/11/2016  
**Measurement duration:** 15 minutes 33 seconds  
**Signal:** LTE, f=2560.0 MHz, Duty Cycle: 1:1.0  
**Liquid Parameters:** Permittivity: 51.93; Conductivity: 2.03 S/m  
**Test condition:** Ambient Temperature: 21.8°C, Liquid Temperature: 20.4°C  
**Probe:** SN 34/15 SSE2 EPGO265, ConvF: 2.43  
**Area Scan:** sam\_direct\_droit2\_surf12mm.txt, h= 5.00 mm  
**Zoom Scan:** 7x7x7,dx=5mm, dy=5mm, dz=5mm,Complete  
**Maximum location:** X=8.000000, Y=12.000000  
**SAR 10g (W/Kg):** 0.351248  
**SAR 1g (W/Kg):** 0.713889  
**Power drift (%):** -2.84  
**3D screen shot**

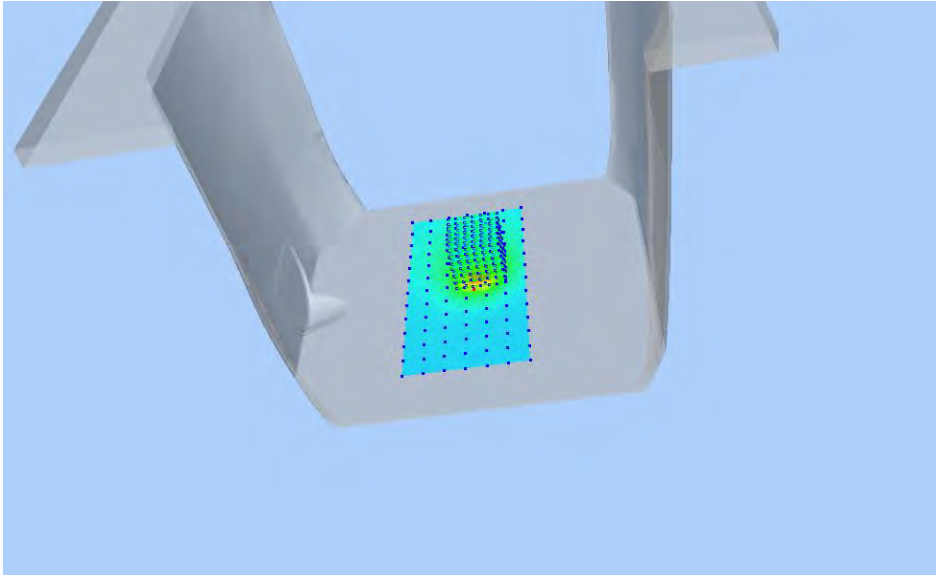

### Z Axis Scan

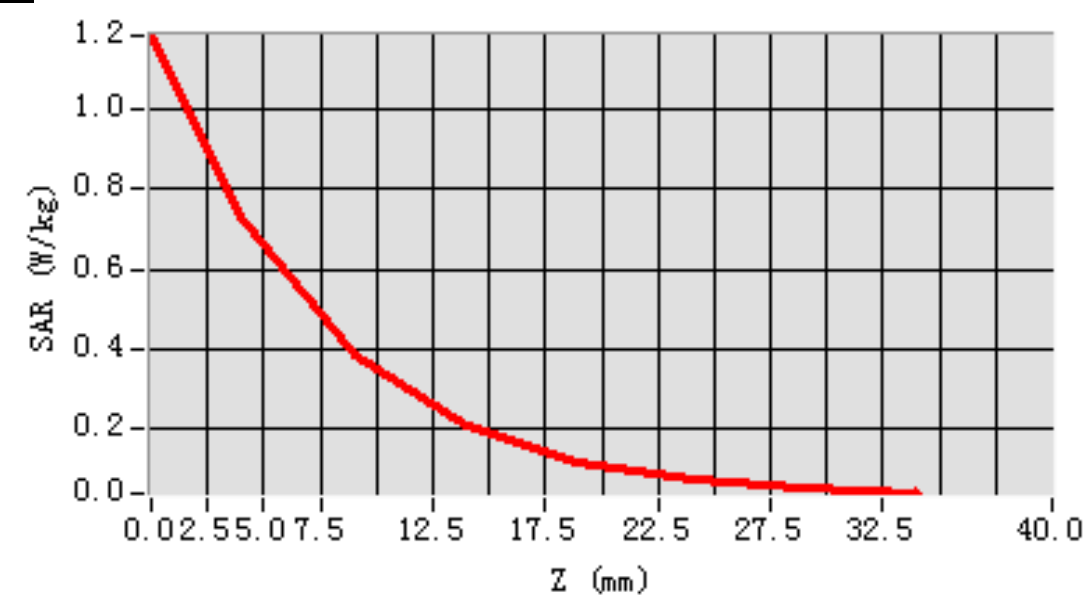



## MEAS. 15 Right Head with Cheek on High Channel in IEEE 802.b mode

**Test Date:** 27/11/2016  
**Measurement duration:** 14 minutes 6 seconds  
**Signal:** WLAN, f=2462.0 MHz, Duty Cycle: 1:1.0  
**Liquid Parameters:** Permittivity: 38.34; Conductivity: 1.87 S/m  
**Test condition:** Ambient Temperature: 21.8°C, Liquid Temperature: 20.4°C  
**Probe:** SN 34/15 SSE2 EPGO265, ConvF: 2.47  
**Area Scan:** sam\_direct\_droit2\_surf12mm.txt, h= 5.00 mm  
**Zoom Scan:** 7x7x7,dx=5mm, dy=5mm, dz=5mm,Complete  
**Maximum location:** X=-24.000000, Y=24.000000  
**SAR 10g (W/Kg):** 0.198782  
**SAR 1g (W/Kg):** 0.406571  
**Power drift (%):** -2.20  
**3D screen shot**

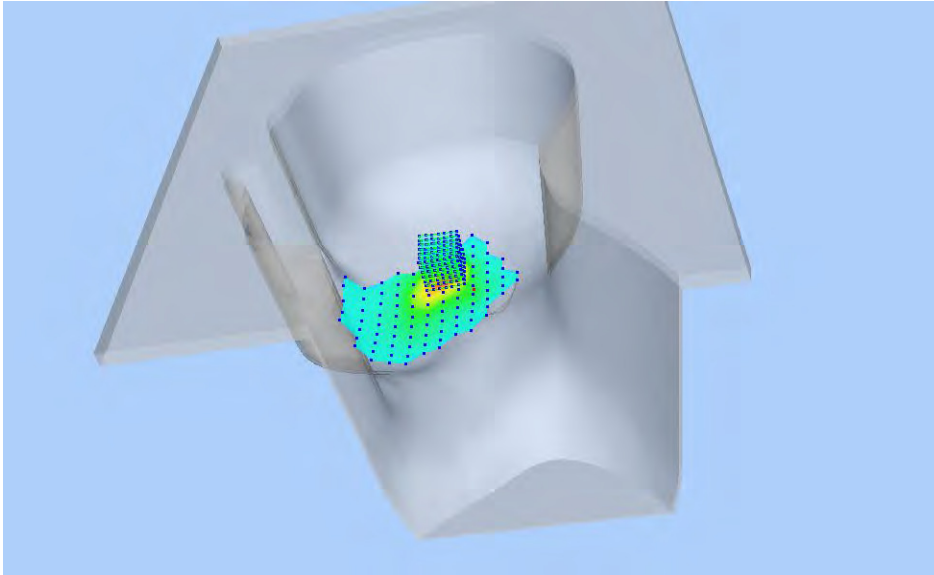

### Z Axis Scan

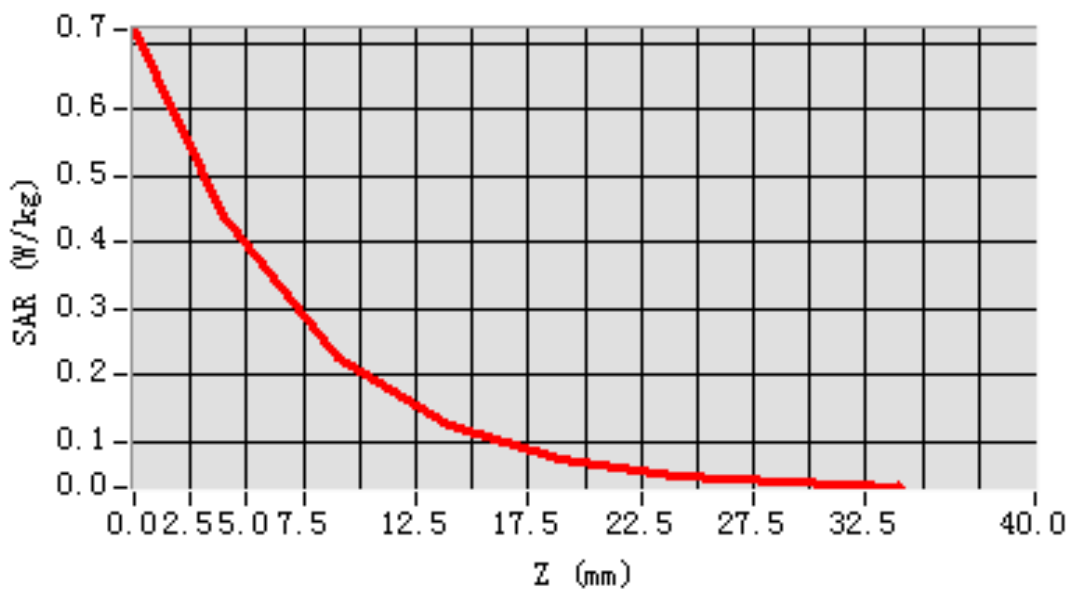

## MEAS. 16 Body Plane with Back Side on High Channel in IEEE 802.b mode

**Test Date:** 27/11/2016  
**Measurement duration:** 16 minutes 19 seconds  
**Signal:** WLAN, f=2462.0 MHz, Duty Cycle: 1:1.0  
**Liquid Parameters:** Permittivity: 52.08; Conductivity: 2.00 S/m  
**Test condition:** Ambient Temperature: 21.8°C, Liquid Temperature: 20.4°C  
**Probe:** SN 34/15 SSE2 EPGO265, ConvF: 2.55  
**Area Scan:** sam\_direct\_droit2\_surf12mm.txt, h= 5.00 mm  
**Zoom Scan:** 7x7x7,dx=5mm, dy=5mm, dz=5mm,Complete  
**Maximum location:** X=-4.000000, Y=12.000000  
**SAR 10g (W/Kg):** 0.066237  
**SAR 1g (W/Kg):** 0.107490  
**Power drift (%):** -3.66  
**3D screen shot**

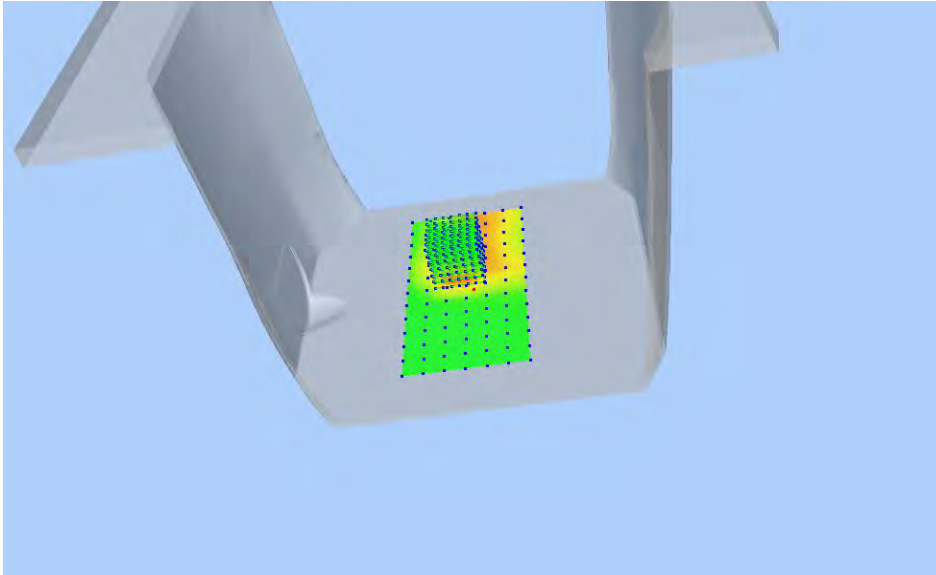

### Z Axis Scan

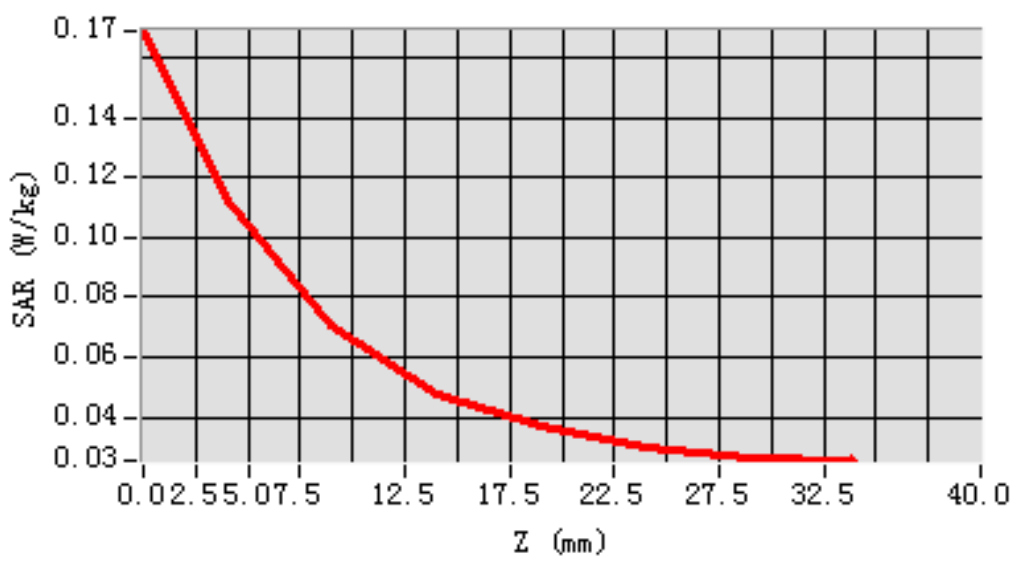

## **ANNEX D EXTERNAL PHOTOS**

Please refer the document "BL-SZ16B0295-AW.pdf".

## **ANNEX E SAR TEST SETUP PHOTOS**

Please refer the document "BL-SZ16B0295-AS.pdf".

## ANNEX F CALIBRATION REPORT

### F.1 E-Field Probe



### COMOSAR E-Field Probe Calibration Report

Ref : ACR.294.1.16.SATU.A

**SHENZHEN BALUN TECHNOLOGY CO.,LTD.**  
**BLOCK B, FL 1, BAISHA SCIENCE AND TECHNOLOGY**  
**PARK, SHAHE XI ROAD,**  
**NANSHAN DISTRICT, SHENZHEN, GUANGDONG**  
**PROVINCE, P.R. CHINA 518055**  
**MVG COMOSAR DOSIMETRIC E-FIELD PROBE**  
**SERIAL NO.: SN 34/15 EPGO265**

**Calibrated at MVG US**  
**2105 Barrett Park Dr. - Kennesaw, GA 30144**



**Calibration Date: 09/15/2016**

*Summary:*

This document presents the method and results from an accredited COMOSAR Dosimetric E-Field Probe calibration performed in MVG USA using the CALISAR / CALIBAIR test bench, for use with a COMOSAR system only. All calibration results are traceable to national metrology institutions.



COMOSAR E-FIELD PROBE CALIBRATION REPORT

Ref: ACR.294.1.16.SATU.A

	<i>Name</i>	<i>Function</i>	<i>Date</i>	<i>Signature</i>
<i>Prepared by :</i>	Jérôme LUC	Product Manager	9/24/2016	<i>JS</i>
<i>Checked by :</i>	Jérôme LUC	Product Manager	9/24/2016	<i>JS</i>
<i>Approved by :</i>	Kim RUTKOWSKI	Quality Manager	9/24/2016	<i>Kim Rutkowski</i>

	<i>Customer Name</i>
<i>Distribution :</i>	SHENZHEN BALUN TECHNOLOGY Co.,Ltd.

<i>Issue</i>	<i>Date</i>	<i>Modifications</i>
A	9/24/2016	Initial release

*This document shall not be reproduced, except in full or in part, without the written approval of MVG.  
The information contained herein is to be used only for the purpose for which it is submitted and is not to be released in whole or part without written approval of MVG.*



TABLE OF CONTENTS

1	Device Under Test .....	4
2	Product Description .....	4
2.1	General Information .....	4
3	Measurement Method .....	4
3.1	Linearity .....	4
3.2	Sensitivity .....	5
3.3	Lower Detection Limit .....	5
3.4	Isotropy .....	5
3.5	Boundary Effect .....	5
4	Measurement Uncertainty .....	5
5	Calibration Measurement Results .....	6
5.1	Sensitivity in air .....	6
5.2	Linearity .....	7
5.3	Sensitivity in liquid .....	7
5.4	Isotropy .....	8
6	List of Equipment .....	10



**1 DEVICE UNDER TEST**

Device Under Test	
Device Type	COMOSAR DOSIMETRIC E FIELD PROBE
Manufacturer	MVG
Model	SSE2
Serial Number	SN 34/15 EPGO265
Product Condition (new / used)	New
Frequency Range of Probe	0.45 GHz-6GHz
Resistance of Three Dipoles at Connector	Dipole 1: R1=0.192 MΩ Dipole 2: R2=0.230 MΩ Dipole 3: R3=0.205 MΩ

A yearly calibration interval is recommended.

**2 PRODUCT DESCRIPTION**

**2.1 GENERAL INFORMATION**

MVG's COMOSAR E field Probes are built in accordance to the IEEE 1528, OET 65 Bulletin C and CEI/IEC 62209 standards.



**Figure 1 – MVG COMOSAR Dosimetric E field Dipole**

Probe Length	330 mm
Length of Individual Dipoles	2 mm
Maximum external diameter	8 mm
Probe Tip External Diameter	2.5 mm
Distance between dipoles / probe extremity	1 mm

**3 MEASUREMENT METHOD**

The IEEE 1528, OET 65 Bulletin C, CENELEC EN50361 and CEI/IEC 62209 standards provide recommended practices for the probe calibrations, including the performance characteristics of interest and methods by which to assess their affect. All calibrations / measurements performed meet the fore mentioned standards.

**3.1 LINEARITY**

The evaluation of the linearity was done in free space using the waveguide, performing a power sweep to cover the SAR range 0.01W/kg to 100W/kg.



**3.2 SENSITIVITY**

The sensitivity factors of the three dipoles were determined using a two step calibration method (air and tissue simulating liquid) using waveguides as outlined in the standards.

**3.3 LOWER DETECTION LIMIT**

The lower detection limit was assessed using the same measurement set up as used for the linearity measurement. The required lower detection limit is 10 mW/kg.

**3.4 ISOTROPY**

The axial isotropy was evaluated by exposing the probe to a reference wave from a standard dipole with the dipole mounted under the flat phantom in the test configuration suggested for system validations and checks. The probe was rotated along its main axis from 0 - 360 degrees in 15 degree steps. The hemispherical isotropy is determined by inserting the probe in a thin plastic box filled with tissue-equivalent liquid, with the plastic box illuminated with the fields from a half wave dipole. The dipole is rotated about its axis (0°–180°) in 15° increments. At each step the probe is rotated about its axis (0°–360°).

**3.5 BOUNDARY EFFECT**

The boundary effect is defined as the deviation between the SAR measured data and the expected exponential decay in the liquid when the probe is oriented normal to the interface. To evaluate this effect, the liquid filled flat phantom is exposed to fields from either a reference dipole or waveguide. With the probe normal to the phantom surface, the peak spatial average SAR is measured and compared to the analytical value at the surface.

**4 MEASUREMENT UNCERTAINTY**

The guidelines outlined in the IEEE 1528, OET 65 Bulletin C, CENELEC EN50361 and CEI/IEC 62209 standards were followed to generate the measurement uncertainty associated with an E-field probe calibration using the waveguide technique. All uncertainties listed below represent an expanded uncertainty expressed at approximately the 95% confidence level using a coverage factor of k=2, traceable to the Internationally Accepted Guides to Measurement Uncertainty.

Uncertainty analysis of the probe calibration in waveguide					
ERROR SOURCES	Uncertainty value (%)	Probability Distribution	Divisor	ci	Standard Uncertainty (%)
Incident or forward power	3.00%	Rectangular	$\sqrt{3}$	1	1.732%
Reflected power	3.00%	Rectangular	$\sqrt{3}$		1.732%
Liquid conductivity	5.00%	Rectangular	$\sqrt{3}$		2.887%
Liquid permittivity	4.00%	Rectangular	$\sqrt{3}$		2.309%
Field homogeneity	3.00%	Rectangular	$\sqrt{3}$		1.732%
Field probe positioning	5.00%	Rectangular	$\sqrt{3}$		2.887%





COMOSAR E-FIELD PROBE CALIBRATION REPORT

Ref: ACR.294.1.16.SATU.A

Field probe linearity	3.00%	Rectangular	$\sqrt{3}$	1	1.732%
<b>Combined standard uncertainty</b>					5.831%
<b>Expanded uncertainty</b> 95 % confidence level k = 2					12.0%

5 CALIBRATION MEASUREMENT RESULTS

Calibration Parameters	
Liquid Temperature	21 °C
Lab Temperature	21 °C
Lab Humidity	45 %

5.1 SENSITIVITY IN AIR

Normx dipole 1 ( $\mu\text{V}/(\text{V}/\text{m}^2)$ )	Normy dipole 2 ( $\mu\text{V}/(\text{V}/\text{m}^2)$ )	Normz dipole 3 ( $\mu\text{V}/(\text{V}/\text{m}^2)$ )
0.72	0.81	0.85

DCP dipole 1 (mV)	DCP dipole 2 (mV)	DCP dipole 3 (mV)
92	90	95

Calibration curves  $e_i=f(V)$  ( $i=1,2,3$ ) allow to obtain E-field value using the formula:

$$E = \sqrt{E_1^2 + E_2^2 + E_3^2}$$

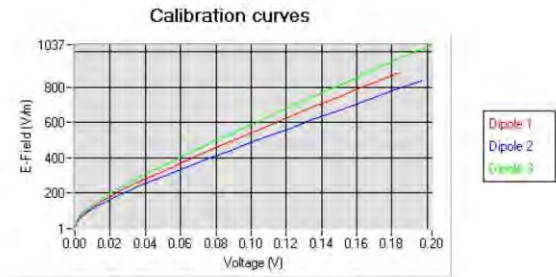

*This document shall not be reproduced, except in full or in part, without the written approval of MVG. The information contained herein is to be used only for the purpose for which it is submitted and is not to be released in whole or part without written approval of MVG.*



COMOSAR E-FIELD PROBE CALIBRATION REPORT

Ref: ACR.294.1.16.SATU.A

5.2 LINEARITY

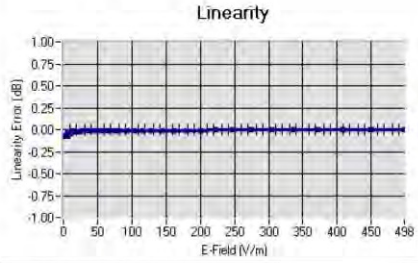

Linearity:  $\pm 1.61\%$  ( $\pm 0.07\text{dB}$ )

5.3 SENSITIVITY IN LIQUID

Liquid	Frequency (MHz +/- 100MHz)	Permittivity	Epsilon (S/m)	ConvF
HL450	450	44.12	0.88	1.85
BL450	450	58.92	1.00	1.90
HL750	750	42.24	0.90	1.81
BL750	750	56.85	0.99	1.88
HL850	835	43.02	0.90	2.04
BL850	835	53.72	0.98	2.12
HL900	900	42.47	0.99	1.86
BL900	900	56.97	1.09	1.92
HL1800	1800	42.24	1.40	2.04
BL1800	1800	53.53	1.53	2.08
HL1900	1900	40.79	1.42	2.35
BL1900	1900	54.47	1.57	2.42
HL2000	2000	40.52	1.44	2.23
BL2000	2000	54.18	1.56	2.32
HL2450	2450	38.73	1.81	2.47
BL2450	2450	53.23	1.96	2.55
HL2600	2600	38.54	1.95	2.36
BL2600	2600	52.07	2.23	2.43
HL5200	5200	36.80	4.84	1.81
BL5200	5200	51.21	5.16	1.85
HL5400	5400	36.35	4.96	2.04
BL5400	5400	50.51	5.70	2.11
HL5600	5600	35.57	5.23	2.08
BL5600	5600	49.83	5.91	2.15
HL5800	5800	35.30	5.47	1.88
BL5800	5800	49.03	6.28	1.93

LOWER DETECTION LIMIT: 7mW/kg

Page: 7/10

*This document shall not be reproduced, except in full or in part, without the written approval of MVG. The information contained herein is to be used only for the purpose for which it is submitted and is not to be released in whole or part without written approval of MVG.*



5.4 ISOTROPY

**HL900 MHz**

- Axial isotropy: 0.04 dB
- Hemispherical isotropy: 0.06 dB

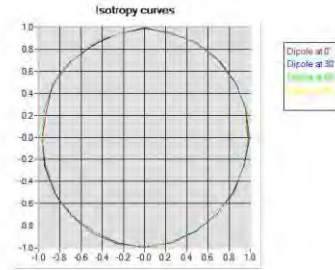

**HL1800 MHz**

- Axial isotropy: 0.04 dB
- Hemispherical isotropy: 0.06 dB

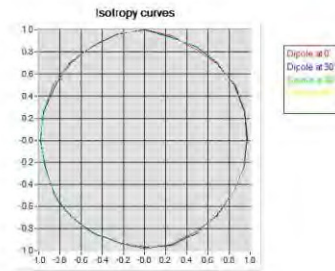



COMOSAR E-FIELD PROBE CALIBRATION REPORT

Ref: ACR.294.1.16.SATU.A

**HL 5600 MHz**

- Axial isotropy: 0.06 dB
- Hemispherical isotropy: 0.09 dB

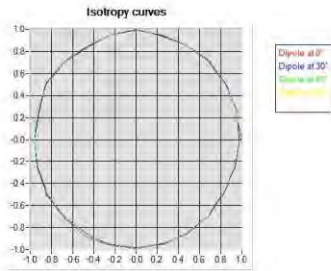

Page: 9/10

*This document shall not be reproduced, except in full or in part, without the written approval of MVG.  
The information contained herein is to be used only for the purpose for which it is submitted and is not to be released in whole or part without written approval of MVG.*



6 LIST OF EQUIPMENT

Equipment Summary Sheet				
Equipment Description	Manufacturer / Model	Identification No.	Current Calibration Date	Next Calibration Date
Flat Phantom	MVG	SN-20/09-SAM71	Validated. No cal required.	Validated. No cal required.
COMOSAR Test Bench	Version 3	NA	Validated. No cal required.	Validated. No cal required.
Network Analyzer	Rhode & Schwarz ZVA	SN100132	10/2013	10/2016
Reference Probe	MVG	EP 94 SN 37/08	12/2015	12/2016
Multimeter	Keithley 2000	1188656	12/2013	12/2016
Signal Generator	Agilent E4438C	MY49070581	12/2013	12/2016
Amplifier	Aethercomm	SN 046	Characterized prior to test. No cal required.	Characterized prior to test. No cal required.
Power Meter	HP E4418A	US38261498	12/2013	12/2016
Power Sensor	HP ECP-E26A	US37181460	12/2013	12/2016
Directional Coupler	Narda 4216-20	01386	Characterized prior to test. No cal required.	Characterized prior to test. No cal required.
Waveguide	Mega Industries	069Y7-158-13-712	Validated. No cal required.	Validated. No cal required.
Waveguide Transition	Mega Industries	069Y7-158-13-701	Validated. No cal required.	Validated. No cal required.
Waveguide Termination	Mega Industries	069Y7-158-13-701	Validated. No cal required.	Validated. No cal required.



## SAR Reference Dipole Calibration Report

Ref: ACR.75.8.15.SATU.A

**SHENZHEN BALUN TECHNOLOGY CO.,LTD.**  
**BLOCK B, FL 1, BAISHA SCIENCE AND TECHNOLOGY**  
**PARK, SHAHE XI ROAD,**  
**NANSHAN DISTRICT, SHENZHEN, GUANGDONG**  
**PROVINCE, P.R. CHINA 518055**  
**MVG COMOSAR REFERENCE DIPOLE**  
**FREQUENCY: 835 MHZ**  
**SERIAL NO.: SN 25/13 DIP 0G835-246**

**Calibrated at MVG US**  
**2105 Barrett Park Dr. - Kennesaw, GA 30144**



**03/16/2015**

### *Summary:*

This document presents the method and results from an accredited SAR reference dipole calibration performed in MVG USA using the COMOSAR test bench. All calibration results are traceable to national metrology institutions.



SAR REFERENCE DIPOLE CALIBRATION REPORT

REF: AGL 75.8.15 SAR11 A

	<i>Name</i>	<i>Function</i>	<i>Date</i>	<i>Signature</i>
<i>Prepared by :</i>	Jérôme LUC	Product Manager	3/16/2015	<i>JS</i>
<i>Checked by :</i>	Jérôme LUC	Product Manager	3/16/2015	<i>JS</i>
<i>Approved by :</i>	Kim RUTKOWSKI	Quality Manager	3/16/2015	<i>Kim Rutkowski</i>

	<i>Customer Name</i>
<i>Distribution :</i>	SHENZHEN BALUN TECHNOLOGY Co.,Ltd.

<i>Issue</i>	<i>Date</i>	<i>Modifications</i>
A	3/16/2015	Initial release

**TABLE OF CONTENTS**

1	Introduction.....	4
2	Device Under Test .....	4
3	Product Description .....	4
3.1	General Information .....	4
4	Measurement Method .....	5
4.1	Return Loss Requirements .....	5
4.2	Mechanical Requirements .....	5
5	Measurement Uncertainty.....	5
5.1	Return Loss .....	5
5.2	Dimension Measurement .....	5
5.3	Validation Measurement .....	5
6	Calibration Measurement Results.....	6
6.1	Return Loss and Impedance In Head Liquid .....	6
6.2	Return Loss and Impedance In Body Liquid .....	6
6.3	Mechanical Dimensions .....	6
7	Validation measurement .....	7
7.1	Head Liquid Measurement .....	7
7.2	SAR Measurement Result With Head Liquid .....	8
7.3	Body Liquid Measurement .....	9
7.4	SAR Measurement Result With Body Liquid .....	10
8	List of Equipment .....	11

Page: 3/11

*This document shall not be reproduced, except in full or in part, without the written approval of MVG.  
The information contained herein is to be used only for the purpose for which it is submitted and is not to be released in whole or part without written approval of MVG.*





**1 INTRODUCTION**

This document contains a summary of the requirements set forth by the IEEE 1528, FCC KDBs and CEI/IEC 62209 standards for reference dipoles used for SAR measurement system validations and the measurements that were performed to verify that the product complies with the fore mentioned standards.

**2 DEVICE UNDER TEST**

Device Under Test	
Device Type	COMOSAR 835 MHz REFERENCE DIPOLE
Manufacturer	MVG
Model	SID835
Serial Number	SN 25/13 DIP 0G835-246
Product Condition (new / used)	Used

A yearly calibration interval is recommended.

**3 PRODUCT DESCRIPTION**

**3.1 GENERAL INFORMATION**

MVG's COMOSAR Validation Dipoles are built in accordance to the IEEE 1528, FCC KDBs and CEI/IEC 62209 standards. The product is designed for use with the COMOSAR test bench only.



**Figure 1** – MVG COMOSAR Validation Dipole

Page: 4/11

*This document shall not be reproduced, except in full or in part, without the written approval of MVG. The information contained herein is to be used only for the purpose for which it is submitted and is not to be released in whole or part without written approval of MVG.*

**4 MEASUREMENT METHOD**

The IEEE 1528, FCC KDBs and CEI/IEC 62209 standards provide requirements for reference dipoles used for system validation measurements. The following measurements were performed to verify that the product complies with the fore mentioned standards.

**4.1 RETURN LOSS REQUIREMENTS**

The dipole used for SAR system validation measurements and checks must have a return loss of -20 dB or better. The return loss measurement shall be performed against a liquid filled flat phantom with the phantom constructed as outlined in the fore mentioned standards.

**4.2 MECHANICAL REQUIREMENTS**

The IEEE Std. 1528 and CEI/IEC 62209 standards specify the mechanical components and dimensions of the validation dipoles, with the dimensions frequency and phantom shell thickness dependent. The COMOSAR test bench employs a 2 mm phantom shell thickness therefore the dipoles sold for use with the COMOSAR test bench comply with the requirements set forth for a 2 mm phantom shell thickness.

**5 MEASUREMENT UNCERTAINTY**

All uncertainties listed below represent an expanded uncertainty expressed at approximately the 95% confidence level using a coverage factor of k=2, traceable to the Internationally Accepted Guides to Measurement Uncertainty.

**5.1 RETURN LOSS**

The following uncertainties apply to the return loss measurement:

Frequency band	Expanded Uncertainty on Return Loss
400-6000MHz	0.1 dB

**5.2 DIMENSION MEASUREMENT**

The following uncertainties apply to the dimension measurements:

Length (mm)	Expanded Uncertainty on Length
3 - 300	0.05 mm

**5.3 VALIDATION MEASUREMENT**

The guidelines outlined in the IEEE 1528, FCC KDBs, CENELEC EN50361 and CEI/IEC 62209 standards were followed to generate the measurement uncertainty for validation measurements.

Scan Volume	Expanded Uncertainty
1 g	20.3 %



10 g	20.1 %
------	--------

**6 CALIBRATION MEASUREMENT RESULTS**

**6.1 RETURN LOSS AND IMPEDANCE IN HEAD LIQUID**

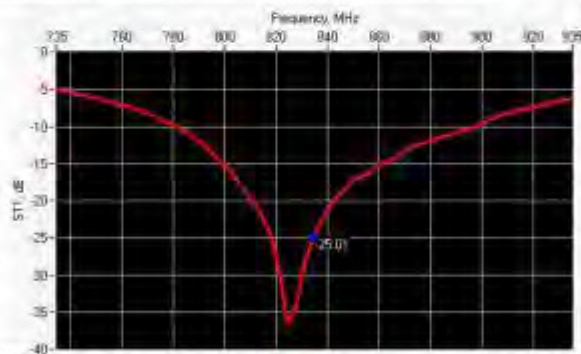

Frequency (MHz)	Return Loss (dB)	Requirement (dB)	Impedance
835	-25.01	-20	55.9 Ω + 0.9 jΩ

**6.2 RETURN LOSS AND IMPEDANCE IN BODY LIQUID**

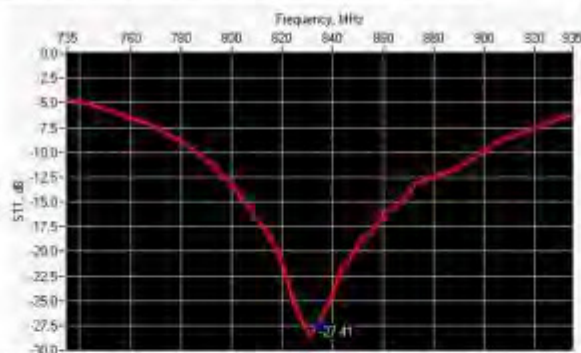

Frequency (MHz)	Return Loss (dB)	Requirement (dB)	Impedance
835	-27.41	-20	52.1 Ω + 3.8 jΩ

**6.3 MECHANICAL DIMENSIONS**

Frequency MHz	L mm		h mm		d mm	
	required	measured	required	measured	required	measured
300	420.0 ±1 %		250.0 ±1 %		6.35 ±1 %	

Page: 6/11

*This document shall not be reproduced, except in full or in part, without the written approval of MVG. The information contained herein is to be used only for the purpose for which it is submitted and is not to be released in whole or part without written approval of MVG.*



## SAR REFERENCE DIPOLE CALIBRATION REPORT

Rd/ A/C/L 75.8.15.S&amp;T/ A

450	290.0 ±1 %		166.7 ±1 %		6.35 ±1 %	
750	176.0 ±1 %		100.0 ±1 %		6.35 ±1 %	
835	161.0 ±1 %	PASS	89.8 ±1 %	PASS	3.6 ±1 %	PASS
900	149.0 ±1 %		83.3 ±1 %		3.6 ±1 %	
1450	89.1 ±1 %		51.7 ±1 %		3.6 ±1 %	
1500	80.5 ±1 %		50.0 ±1 %		3.6 ±1 %	
1640	79.0 ±1 %		45.7 ±1 %		3.6 ±1 %	
1750	75.2 ±1 %		42.8 ±1 %		3.6 ±1 %	
1800	72.0 ±1 %		41.7 ±1 %		3.6 ±1 %	
1900	68.0 ±1 %		39.5 ±1 %		3.6 ±1 %	
1950	66.3 ±1 %		38.5 ±1 %		3.6 ±1 %	
2000	64.5 ±1 %		37.5 ±1 %		3.6 ±1 %	
2100	61.0 ±1 %		35.7 ±1 %		3.6 ±1 %	
2300	55.5 ±1 %		32.6 ±1 %		3.6 ±1 %	
2450	51.5 ±1 %		30.4 ±1 %		3.6 ±1 %	
2600	48.5 ±1 %		28.8 ±1 %		3.6 ±1 %	
3000	41.5 ±1 %		25.0 ±1 %		3.6 ±1 %	
3500	37.0 ±1 %		26.4 ±1 %		3.6 ±1 %	
3700	34.7 ±1 %		26.4 ±1 %		3.6 ±1 %	

## 7 VALIDATION MEASUREMENT

The IEEE Std. 1528, FCC KDBs and CEI/IEC 62209 standards state that the system validation measurements must be performed using a reference dipole meeting the fore mentioned return loss and mechanical dimension requirements. The validation measurement must be performed against a liquid filled flat phantom, with the phantom constructed as outlined in the fore mentioned standards. Per the standards, the dipole shall be positioned below the bottom of the phantom, with the dipole length centered and parallel to the longest dimension of the flat phantom, with the top surface of the dipole at the described distance from the bottom surface of the phantom.

### 7.1 HEAD LIQUID MEASUREMENT

Frequency MHz	Relative permittivity (ε <sub>r</sub> )		Conductivity (σ) S/m	
	required	measured	required	measured
300	45.3 ±5 %		0.87 ±5 %	
450	43.5 ±5 %		0.87 ±5 %	
750	41.9 ±5 %		0.88 ±5 %	
835	41.5 ±5 %	PASS	0.90 ±5 %	PASS
900	41.5 ±5 %		0.97 ±5 %	
1450	40.5 ±5 %		1.20 ±5 %	
1500	40.4 ±5 %		1.23 ±5 %	
1640	40.2 ±5 %		1.31 ±5 %	
1750	40.1 ±5 %		1.37 ±5 %	

Page: 7/11

*This document shall not be reproduced, copied in full or in part, without the written approval of MVG.  
The information contained herein is to be used only for the purpose for which it is submitted and is not to be released in whole or part without written approval of MVG.*



SAR REFERENCE DIPOLE CALIBRATION REPORT

Ref: AGL 75.8.15.SATU.A

1800	40.0 ±5 %		1.40 ±5 %	
1900	40.0 ±5 %		1.40 ±5 %	
1950	40.0 ±5 %		1.40 ±5 %	
2000	40.0 ±5 %		1.40 ±5 %	
2100	39.8 ±5 %		1.49 ±5 %	
2300	39.5 ±5 %		1.67 ±5 %	
2450	39.2 ±5 %		1.80 ±5 %	
2600	39.0 ±5 %		1.96 ±5 %	
3000	38.5 ±5 %		2.40 ±5 %	
3500	37.9 ±5 %		2.92 ±5 %	

7.2 SAR MEASUREMENT RESULT WITH HEAD LIQUID

The IEEE Std. 1528 and CEI/IEC 62209 standards state that the system validation measurements should produce the SAR values shown below (for phantom thickness of 2 mm), within the uncertainty for the system validation. All SAR values are normalized to 1 W forward power. In bracket, the measured SAR is given with the used input power.

Software	OPENSAR V4
Phantom	SN 2009 SAM71
Probe	SN 18711 BPG122
Liquid	Head Liquid Values: eps = 42.1 sigma = 0.92
Distance between dipole center and liquid	15.0 mm
Area scan resolution	dx=8mm /dy=8mm
Zoon Scan Resolution	dx=8mm/dy=8m/dz=5mm
Frequency	835 MHz
Input power	20 dBm
Liquid Temperature	21 °C
Lab Temperature	21 °C
Lab Humidity	45 %

Frequency MHz	1 g SAR (W/kg/W)		10 g SAR (W/kg/W)	
	required	measured	required	measured
300	2.85		1.94	
450	4.58		3.06	
750	8.49		5.55	
835	9.56	9.61 (0.98)	6.22	6.34 (0.83)
900	10.9		6.98	
1450	29		16	
1500	30.5		16.8	
1640	34.2		18.4	
1750	36.4		19.3	
1800	38.4		20.3	

Page: 8/11

*This document shall not be reproduced, except in full or in part, without the written approval of MVG. The information contained herein is to be used only for the purpose for which it is submitted and is not to be released in whole or part without written approval of MVG.*



SAR REFERENCE DIPOLE CALIBRATION REPORT

Ref: ACR 75.8.15.S&TJ.A

1900	39.7		20.5	
1950	40.5		20.9	
2000	41.1		21.1	
2100	43.6		21.9	
2300	48.7		23.3	
2450	52.4		24	
2600	55.3		24.6	
3000	63.8		25.7	
3500	67.1		25	

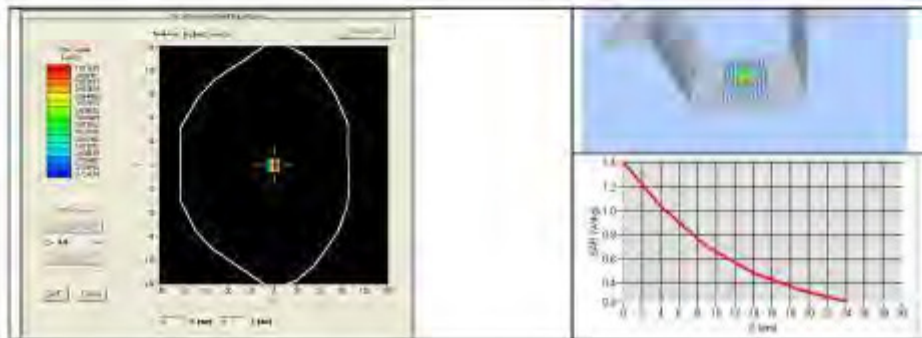

7.3 BODY LIQUID MEASUREMENT

Frequency MHz	Relative permittivity ( $\epsilon_r$ )		Conductivity ( $\sigma$ ) S/m	
	required	measured	required	measured
150	61.9 ±5 %		0.80 ±5 %	
300	58.2 ±5 %		0.92 ±5 %	
450	56.7 ±5 %		0.94 ±5 %	
750	55.5 ±5 %		0.96 ±5 %	
835	55.2 ±5 %	PASS	0.97 ±5 %	PASS
900	55.0 ±5 %		1.05 ±5 %	
915	55.0 ±5 %		1.06 ±5 %	
1450	54.0 ±5 %		1.30 ±5 %	
1610	53.8 ±5 %		1.40 ±5 %	
1800	53.3 ±5 %		1.52 ±5 %	
1900	53.3 ±5 %		1.52 ±5 %	
2000	53.3 ±5 %		1.52 ±5 %	
2100	53.2 ±5 %		1.62 ±5 %	
2450	52.7 ±5 %		1.85 ±5 %	

Page: 9/11

*This document shall not be reproduced, except in full or in part, without the written approval of MVG. The information contained herein is to be used only for the purpose for which it is submitted and is not to be released in whole or part without written approval of MVG.*



SAR REFERENCE DIPOLE CALIBRATION REPORT

Ref: ACL75.8.15.S&T/A

2600	52.5 ±5 %		2.16 ±5 %	
3000	52.0 ±5 %		2.73 ±5 %	
3500	51.3 ±5 %		3.31 ±5 %	
5200	49.0 ±10 %		5.30 ±10 %	
5300	48.9 ±10 %		5.42 ±10 %	
5400	48.7 ±10 %		5.53 ±10 %	
5500	48.6 ±10 %		5.65 ±10 %	
5600	48.5 ±10 %		5.77 ±10 %	
5800	48.2 ±10 %		6.00 ±10 %	

7.4 SAR MEASUREMENT RESULT WITH BODY LIQUID

Software	OPENSAR V4
Phantom	SN 20/09 SAM71
Probe	SN 18/11 EPG122
Liquid	Body Liquid Values: eps = 53.8 sigma = 0.98
Distance between dipole center and liquid	15.0 mm
Area scan resolution	dx=8mm/dy=8mm
Zoon Scan Resolution	dx=8mm/dy=8m/dz=5mm
Frequency	835 MHz
Input power	20 dBm
Liquid Temperature	21 °C
Lab Temperature	21 °C
Lab Humidity	45 %

Frequency MHz	1 g SAR (W/kg/W)	10 g SAR (W/kg/W)
	measured	measured
835	10.53 (1.05)	6.89 (0.69)

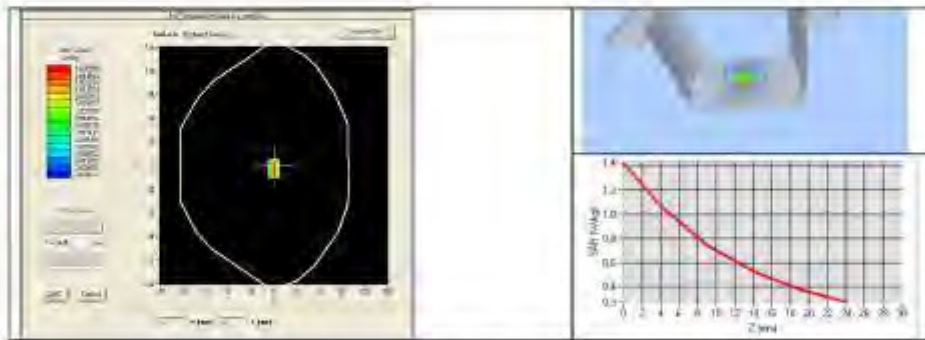

Page: 10/11

*This document shall not be reproduced, stored in full or in part, without the written approval of MVG. The information contained herein is to be used only for the purpose for which it is submitted and is not to be released in whole or part without written approval of MVG.*



**8 LIST OF EQUIPMENT**

Equipment Summary Sheet				
Equipment Description	Manufacturer / Model	Identification No.	Current Calibration Date	Next Calibration Date
SAM Phantom	MVG	SN-20/09-SAM71	Validated. No cal required.	Validated. No cal required.
COMOSAR Test Bench	Version 3	NA	Validated. No cal required.	Validated. No cal required.
Network Analyzer	Rhode & Schwarz ZVA	SN100132	02/2013	02/2016
Calipers	Carrera	CALIPER-01	12/2013	12/2016
Reference Probe	MVG	EPG122 SN 18/11	10/2014	10/2015
Multimeter	Keithley 2000	1188656	12/2013	12/2016
Signal Generator	Agilent E4438C	MY48070581	12/2013	12/2016
Amplifier	Aethercomm	SN 046	Characterized prior to test. No cal required.	Characterized prior to test. No cal required.
Power Meter	HP E4418A	US38261498	12/2013	12/2016
Power Sensor	HP ECP-E26A	US37181480	12/2013	12/2016
Directional Coupler	Narda 4216-20	01386	Characterized prior to test. No cal required.	Characterized prior to test. No cal required.
Temperature and Humidity Sensor	Control Company	11-661-9	8/2012	8/2015



F.3 1800MHz Dipole



**SAR Reference Dipole Calibration Report**

Ref: ACR.75.10.15.SATU.A

**SHENZHEN BALUN TECHNOLOGY CO.,LTD.**  
**BLOCK B, FL 1, BAISHA SCIENCE AND TECHNOLOGY**  
**PARK, SHAHE XI ROAD,**  
**NANSHAN DISTRICT, SHENZHEN, GUANGDONG**  
**PROVINCE, P.R. CHINA 518055**  
**MVG COMOSAR REFERENCE DIPOLE**  
**FREQUENCY: 1800 MHZ**  
**SERIAL NO.: SN 25/13 DIP 1G800-248**

**Calibrated at MVG US**  
**2105 Barrett Park Dr. - Kennesaw, GA 30144**



**03/16/2015**

*Summary:*

This document presents the method and results from an accredited SAR reference dipole calibration performed in MVG USA using the COMOSAR test bench. All calibration results are traceable to national metrology institutions.



SAR REFERENCE DIPOLE CALIBRATION REPORT

Ref: ACS-75-10-15-S&IT/A

	<i>Name</i>	<i>Function</i>	<i>Date</i>	<i>Signature</i>
<i>Prepared by :</i>	Jérôme LUC	Product Manager	3/16/2015	<i>JS</i>
<i>Checked by :</i>	Jerôme LUC	Product Manager	3/16/2015	<i>JS</i>
<i>Approved by :</i>	Kim RUTKOWSKI	Quality Manager	3/16/2015	<i>Kim Rutkowski</i>

	<i>Customer Name</i>
<i>Distribution :</i>	SHENZHEN BALUN TECHNOLOGY Co.,Ltd.

<i>Issue</i>	<i>Date</i>	<i>Modifications</i>
A	3/16/2015	Initial release

Page: 2/11

This document shall not be reproduced, stored in full or in part, without the written approval of MVG.  
The information contained herein is to be used only for the purpose for which it is submitted and is not to be released in whole or part without written approval of MVG.

**TABLE OF CONTENTS**

1	Introduction.....	4
2	Device Under Test .....	4
3	Product Description .....	4
3.1	General Information .....	4
4	Measurement Method .....	5
4.1	Return Loss Requirements .....	5
4.2	Mechanical Requirements .....	5
5	Measurement Uncertainty.....	5
5.1	Return Loss .....	5
5.2	Dimension Measurement .....	5
5.3	Validation Measurement .....	5
6	Calibration Measurement Results.....	6
6.1	Return Loss and Impedance In Head Liquid .....	6
6.2	Return Loss and Impedance In Body Liquid .....	6
6.3	Mechanical Dimensions .....	6
7	Validation measurement .....	7
7.1	Head Liquid Measurement .....	7
7.2	SAR Measurement Result With Head Liquid .....	8
7.3	Body Liquid Measurement .....	9
7.4	SAR Measurement Result With Body Liquid .....	10
8	List of Equipment .....	11

Page: 3/11

*This document shall not be reproduced, stored in full or in part, without the written approval of MVG.  
The information contained herein is to be used only for the purpose for which it is submitted and is not to  
be released in whole or part without written approval of MVG.*



**1 INTRODUCTION**

This document contains a summary of the requirements set forth by the IEEE 1528, FCC KDBs and CEI/IEC 62209 standards for reference dipoles used for SAR measurement system validations and the measurements that were performed to verify that the product complies with the fore mentioned standards.

**2 DEVICE UNDER TEST**

Device Under Test	
Device Type	COMOSAR 1800 MHz REFERENCE DIPOLE
Manufacturer	MVG
Model	SID1800
Serial Number	SN 25/13 DIP 1G800-248
Product Condition (new / used)	Used

A yearly calibration interval is recommended.

**3 PRODUCT DESCRIPTION**

**3.1 GENERAL INFORMATION**

MVG's COMOSAR Validation Dipoles are built in accordance to the IEEE 1528, FCC KDBs and CEI/IEC 62209 standards. The product is designed for use with the COMOSAR test bench only.



**Figure 1 – MVG COMOSAR Validation Dipole**

Page: 4/11

*This document shall not be reproduced, stored in full or in part, without the written approval of MVG. The information contained herein is to be used only for the purpose for which it is submitted and is not to be released in whole or part without written approval of MVG.*



**4 MEASUREMENT METHOD**

The IEEE 1528, FCC KDBs and CEI/IEC 62209 standards provide requirements for reference dipoles used for system validation measurements. The following measurements were performed to verify that the product complies with the fore mentioned standards.

**4.1 RETURN LOSS REQUIREMENTS**

The dipole used for SAR system validation measurements and checks must have a return loss of -20 dB or better. The return loss measurement shall be performed against a liquid filled flat phantom with the phantom constructed as outlined in the fore mentioned standards.

**4.2 MECHANICAL REQUIREMENTS**

The IEEE Std. 1528 and CEI/IEC 62209 standards specify the mechanical components and dimensions of the validation dipoles, with the dimensions frequency and phantom shell thickness dependent. The COMOSAR test bench employs a 2 mm phantom shell thickness therefore the dipoles sold for use with the COMOSAR test bench comply with the requirements set forth for a 2 mm phantom shell thickness.

**5 MEASUREMENT UNCERTAINTY**

All uncertainties listed below represent an expanded uncertainty expressed at approximately the 95% confidence level using a coverage factor of k=2, traceable to the Internationally Accepted Guides to Measurement Uncertainty.

**5.1 RETURN LOSS**

The following uncertainties apply to the return loss measurement.

Frequency band	Expanded Uncertainty on Return Loss
400-6000MHz	0.1 dB

**5.2 DIMENSION MEASUREMENT**

The following uncertainties apply to the dimension measurements:

Length (mm)	Expanded Uncertainty on Length
3 - 300	0.05 mm

**5.3 VALIDATION MEASUREMENT**

The guidelines outlined in the IEEE 1528, FCC KDBs, CENELEC EN50361 and CEI/IEC 62209 standards were followed to generate the measurement uncertainty for validation measurements.

Scan Volume	Expanded Uncertainty
1 g	20.3 %

Page: 5/11

*This document shall not be reproduced, copied in full or in part, without the written approval of MTV.  
The information contained herein is to be used only for the purpose for which it is submitted and is not to be released in whole or part without written approval of MTV.*



10 g	20.1 %
------	--------

**6 CALIBRATION MEASUREMENT RESULTS**

**6.1 RETURN LOSS AND IMPEDANCE IN HEAD LIQUID**

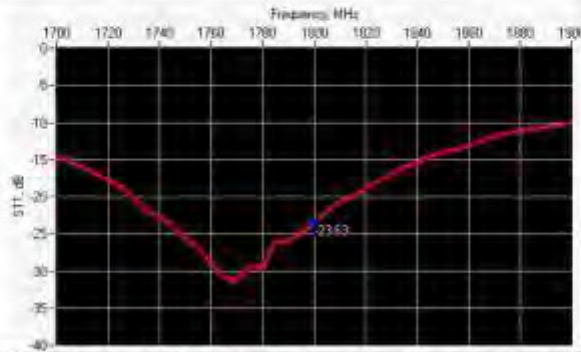

Frequency (MHz)	Return Loss (dB)	Requirement (dB)	Impedance
1800	-23.63	-20	45.1 Ω + 4.0 jΩ

**6.2 RETURN LOSS AND IMPEDANCE IN BODY LIQUID**

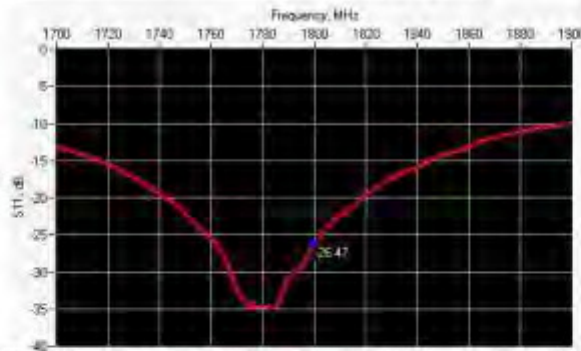

Frequency (MHz)	Return Loss (dB)	Requirement (dB)	Impedance
1800	-26.47	-20	45.5 Ω - 0.3 jΩ

**6.3 MECHANICAL DIMENSIONS**

Frequency MHz	L mm		h mm		d mm	
	required	measured	required	measured	required	measured
300	420.0 ± 1 %		250.0 ± 1 %		6.35 ± 1 %	

Page: 6/11

*This document shall not be reproduced, except in full or in part, without the written approval of MVG. The information contained herein is to be used only for the purpose for which it is submitted and is not to be released in whole or part without written approval of MVG.*



SAR REFERENCE DIPOLE CALIBRATION REPORT

Ref: ACS-75-10-03-S&T/A

450	290.0 ±1 %		166.7 ±1 %		6.35 ±1 %	
750	176.0 ±1 %		100.0 ±1 %		6.35 ±1 %	
835	161.0 ±1 %		89.8 ±1 %		3.6 ±1 %	
900	149.0 ±1 %		83.3 ±1 %		3.6 ±1 %	
1450	89.1 ±1 %		51.7 ±1 %		3.6 ±1 %	
1500	80.5 ±1 %		50.0 ±1 %		3.6 ±1 %	
1640	79.0 ±1 %		45.7 ±1 %		3.6 ±1 %	
1750	75.2 ±1 %		42.8 ±1 %		3.6 ±1 %	
1800	72.0 ±1 %	PASS	41.7 ±1 %	PASS	3.6 ±1 %	PASS
1900	68.0 ±1 %		39.5 ±1 %		3.6 ±1 %	
1950	66.3 ±1 %		38.5 ±1 %		3.6 ±1 %	
2000	64.5 ±1 %		37.5 ±1 %		3.6 ±1 %	
2100	61.0 ±1 %		36.7 ±1 %		3.6 ±1 %	
2300	55.5 ±1 %		32.6 ±1 %		3.6 ±1 %	
2450	51.5 ±1 %		30.4 ±1 %		3.6 ±1 %	
2600	48.5 ±1 %		28.8 ±1 %		3.6 ±1 %	
3000	41.5 ±1 %		25.0 ±1 %		3.6 ±1 %	
3500	37.0 ±1 %		26.4 ±1 %		3.6 ±1 %	
3700	34.7 ±1 %		26.4 ±1 %		3.6 ±1 %	

7 VALIDATION MEASUREMENT

The IEEE Std. 1528, FCC KDBs and CEI/IEC 62209 standards state that the system validation measurements must be performed using a reference dipole meeting the fore mentioned return loss and mechanical dimension requirements. The validation measurement must be performed against a liquid filled flat phantom, with the phantom constructed as outlined in the fore mentioned standards. Per the standards, the dipole shall be positioned below the bottom of the phantom, with the dipole length centered and parallel to the longest dimension of the flat phantom, with the top surface of the dipole at the described distance from the bottom surface of the phantom.

7.1 HEAD LIQUID MEASUREMENT

Frequency MHz	Relative permittivity (ε <sub>r</sub> )		Conductivity (σ) S/m	
	required	measured	required	measured
300	45.3 ±5 %		0.87 ±5 %	
450	43.5 ±5 %		0.87 ±5 %	
750	41.9 ±5 %		0.89 ±5 %	
835	41.5 ±5 %		0.90 ±5 %	
900	41.5 ±5 %		0.97 ±5 %	
1450	40.5 ±5 %		1.20 ±5 %	
1500	40.4 ±5 %		1.23 ±5 %	
1640	40.2 ±5 %		1.31 ±5 %	
1750	40.1 ±5 %		1.37 ±5 %	

Page: 7/11

*This document shall not be reproduced, stored in full or in part, without the written approval of MVG.  
The information contained herein is to be used only for the purpose for which it is submitted and is not to be released in whole or part without written approval of MVG.*



SAR REFERENCE DIPOLE CALIBRATION REPORT

Rev: ACB.75.10.03.S&T/A

1800	40.0 ±5 %	PASS	1.40 ±5 %	PASS
1900	40.0 ±5 %		1.40 ±5 %	
1950	40.0 ±5 %		1.40 ±5 %	
2000	40.0 ±5 %		1.40 ±5 %	
2100	39.8 ±5 %		1.49 ±5 %	
2300	39.5 ±5 %		1.67 ±5 %	
2450	39.2 ±5 %		1.80 ±5 %	
2600	39.0 ±5 %		1.96 ±5 %	
3000	38.5 ±5 %		2.40 ±5 %	
3500	37.9 ±5 %		2.95 ±5 %	

7.2 SAR MEASUREMENT RESULT WITH HEAD LIQUID

The IEEE Std. 1528 and CEI/IEC 62209 standards state that the system validation measurements should produce the SAR values shown below (for phantom thickness of 2 mm), within the uncertainty for the system validation. All SAR values are normalized to 1 W forward power. In bracket, the measured SAR is given with the used input power.

Software	OPENSAR V4
Phantom	SN 20/09 SAM71
Probe	SN 18/11 EPG122
Liquid	Head Liquid Values: eps = 41.1 sigma = 1.39
Distance between dipole center and liquid	10.0 mm
Area scan resolution	dx=8mm/dy=8mm
Zoon Scan Resolution	dz=8mm/dy=8m/dx=5mm
Frequency	1800 MHz
Input power	20 dBm
Liquid Temperature	21 °C
Lab Temperature	21 °C
Lab Humidity	45 %

Frequency MHz	1 g SAR (W/kg/W)		10 g SAR (W/kg/W)	
	required	measured	required	measured
300	2.85		1.94	
450	4.58		3.06	
750	8.49		5.55	
835	9.56		6.22	
900	10.9		6.99	
1450	29		16	
1500	30.5		16.8	
1640	34.2		18.4	
1750	36.4		19.3	
1800	38.4	38.72 (3.87)	20.1	20.37 (2.04)

Page: 8/11

*This document shall not be reproduced, stored in full or in part, without the written approval of MVG. The information contained herein is to be used only for the purpose for which it is submitted and is not to be released in whole or part without written approval of MVG.*





SAR REFERENCE DIPOLE CALIBRATION REPORT

Ref: ACR.75.10.15.S&T1.A

1900	39.7		20.5	
1950	40.5		20.9	
2000	41.1		21.1	
2100	43.6		21.9	
2300	48.7		23.3	
2450	52.4		24	
2600	55.3		24.6	
3000	63.8		25.7	
3500	67.1		25	

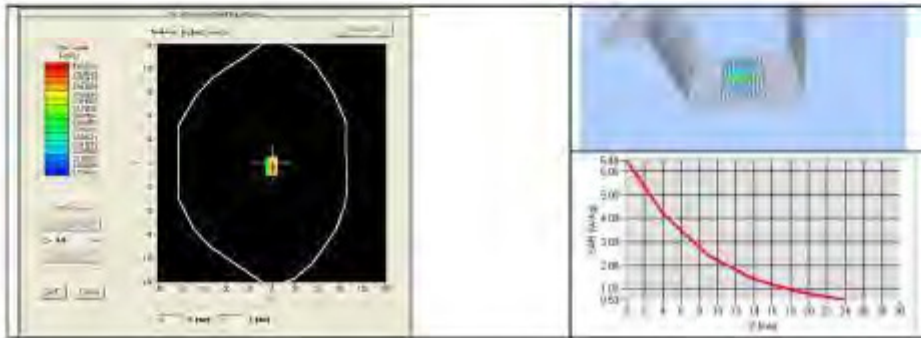

7.3 BODY LIQUID MEASUREMENT

Frequency MHz	Relative permittivity (ε <sub>r</sub> )		Conductivity (σ) S/m	
	required	measured	required	measured
150	61.9 ±5 %		0.80 ±5 %	
300	58.2 ±5 %		0.92 ±5 %	
450	56.7 ±5 %		0.94 ±5 %	
750	55.5 ±5 %		0.96 ±5 %	
835	55.2 ±5 %		0.97 ±5 %	
900	55.0 ±5 %		1.05 ±5 %	
915	55.0 ±5 %		1.06 ±5 %	
1450	54.0 ±5 %		1.30 ±5 %	
1610	53.8 ±5 %		1.40 ±5 %	
1800	53.3 ±5 %	PASS	1.52 ±5 %	PASS
1900	53.3 ±5 %		1.52 ±5 %	
2000	53.3 ±5 %		1.52 ±5 %	
2100	53.2 ±5 %		1.62 ±5 %	
2450	52.7 ±5 %		1.85 ±5 %	

Page: 9/11

*This document shall not be reproduced, stored in full or in part, without the written approval of MVG. The information contained herein is to be used only for the purpose for which it is submitted and is not to be released in whole or part without written approval of MVG.*



SAR REFERENCE DIPOLE CALIBRATION REPORT

Rev: ACR-15-10-15-S&T/A

2600	52.5 ±5 %		2.16 ±5 %	
3000	52.0 ±5 %		2.73 ±5 %	
3500	51.3 ±5 %		3.31 ±5 %	
5200	49.0 ±10 %		5.30 ±10 %	
5300	48.9 ±10 %		5.42 ±10 %	
5400	48.7 ±10 %		5.53 ±10 %	
5500	48.6 ±10 %		5.65 ±10 %	
5600	48.5 ±10 %		5.77 ±10 %	
5800	48.2 ±10 %		6.00 ±10 %	

7.4 SAR MEASUREMENT RESULT WITH BODY LIQUID

Software	OPENSAR V4
Phantom	SN 20/09 SAM71
Probe	SN 18/11 EPG122
Liquid	Body Liquid Values: eps = 53.0 sigma = 1.52
Distance between dipole center and liquid	10.0 mm
Area scan resolution	dx=8mm/dy=8mm
Zoon Scan Resolution	dx=8mm/dy=8m/dz=5mm
Frequency	1800 MHz
Input power	20 dBm
Liquid Temperature	21 °C
Lab Temperature	21 °C
Lab Humidity	45 %

Frequency MHz	1 g SAR (W/kg/W)	10 g SAR (W/kg/W)
	measured	measured
1800	40.42 (4.04)	21.53 (2.15)

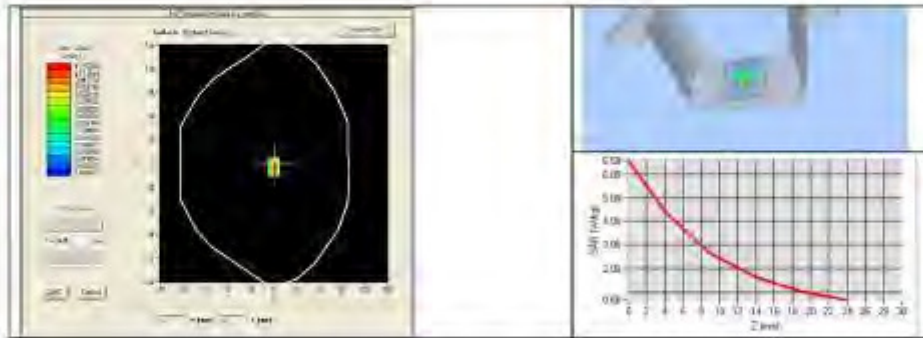

Page: 10/11

*This document shall not be reproduced, stored in full or in part, without the written approval of MVG. The information contained herein is to be used only for the purpose for which it is submitted and is not to be released in whole or part without written approval of MVG.*



8 LIST OF EQUIPMENT

Equipment Summary Sheet				
Equipment Description	Manufacturer / Model	Identification No.	Current Calibration Date	Next Calibration Date
SAM Phantom	MVG	SN-20/09-SAM71	Validated. No cal required.	Validated. No cal required.
COMOSAR Test Bench	Version 3	NA	Validated. No cal required.	Validated. No cal required.
Network Analyzer	Rhode & Schwarz ZVA	SN100132	02/2013	02/2016
Calipers	Carrera	CALIPER-01	12/2013	12/2016
Reference Probe	MVG	EPG122 SN 18/11	10/2014	10/2015
Multimeter	Keithley 2000	1188656	12/2013	12/2016
Signal Generator	Agilent E4438C	MY48070581	12/2013	12/2016
Amplifier	Aethercomm	SN 046	Characterized prior to test. No cal required.	Characterized prior to test. No cal required.
Power Meter	HP E4418A	US38261498	12/2013	12/2016
Power Sensor	HP ECP-E26A	US37181480	12/2013	12/2016
Directional Coupler	Narda 4216-20	01386	Characterized prior to test. No cal required.	Characterized prior to test. No cal required.
Temperature and Humidity Sensor	Control Company	11-661-9	8/2012	8/2015

Page: 11/11

*This document shall not be reproduced, stored in full or in part, without the written approval of MVG.  
The information contained herein is to be used only for the purpose for which it is submitted and is not to be released in whole or part without written approval of MVG.*

F.4 1900MHz Dipole



**SAR Reference Dipole Calibration Report**

Ref: ACR.75.11.15.SATII.A

**SHENZHEN BALUN TECHNOLOGY CO.,LTD.**  
**BLOCK B, FL 1, BAISHA SCIENCE AND TECHNOLOGY**  
**PARK, SHAHE XI ROAD,**  
**NANSHAN DISTRICT, SHENZHEN, GUANGDONG**  
**PROVINCE, P.R. CHINA 518055**  
**MVG COMOSAR REFERENCE DIPOLE**  
**FREQUENCY: 1900 MHZ**  
**SERIAL NO.: SN 25/13 DIP 1G900-249**

**Calibrated at MVG US**  
**2105 Barrett Park Dr. - Kennesaw, GA 30144**



**03/16/2015**

*Summary:*

This document presents the method and results from an accredited SAR reference dipole calibration performed in MVG USA using the COMOSAR test bench. All calibration results are traceable to national metrology institutions.



SAR REFERENCE DIPOLE CALIBRATION REPORT

Ref: ACR-75.11.15.B&TU.A

	<i>Name</i>	<i>Function</i>	<i>Date</i>	<i>Signature</i>
<i>Prepared by :</i>	Jérôme LUC	Product Manager	3/16/2015	<i>JS</i>
<i>Checked by :</i>	Jérôme LUC	Product Manager	3/16/2015	<i>JS</i>
<i>Approved by :</i>	Kim RUTKOWSKI	Quality Manager	3/16/2015	<i>Kim Rutkowski</i>

	<i>Customer Name</i>
<i>Distribution :</i>	SHENZHEN BALUN TECHNOLOGY Co.,Ltd.

<i>Issue</i>	<i>Date</i>	<i>Modifications</i>
A	3/16/2015	Initial release

**TABLE OF CONTENTS**

1	Introduction.....	4
2	Device Under Test .....	4
3	Product Description .....	4
3.1	General Information .....	4
4	Measurement Method .....	5
4.1	Return Loss Requirements .....	5
4.2	Mechanical Requirements .....	5
5	Measurement Uncertainty.....	5
5.1	Return Loss .....	5
5.2	Dimension Measurement .....	5
5.3	Validation Measurement .....	5
6	Calibration Measurement Results.....	6
6.1	Return Loss and Impedance In Head Liquid .....	6
6.2	Return Loss and Impedance In Body Liquid .....	6
6.3	Mechanical Dimensions .....	6
7	Validation measurement .....	7
7.1	Head Liquid Measurement .....	7
7.2	SAR Measurement Result With Head Liquid .....	8
7.3	Body Liquid Measurement .....	9
7.4	SAR Measurement Result With Body Liquid .....	10
8	List of Equipment .....	11

Page: 3/11

*This document shall not be reproduced, except in full or in part, without the written approval of MVG.  
The information contained herein is to be used only for the purpose for which it is submitted and is not to be released in whole or part without written approval of MVG.*



**1 INTRODUCTION**

This document contains a summary of the requirements set forth by the IEEE 1528, FCC KDBs and CE/IEC 62209 standards for reference dipoles used for SAR measurement system validations and the measurements that were performed to verify that the product complies with the fore mentioned standards.

**2 DEVICE UNDER TEST**

Device Under Test	
Device Type	COMOSAR 1900 MHz REFERENCE DIPOLE
Manufacturer	MVG
Model	SID1900
Serial Number	SN 25/13 DIP 1G900-249
Product Condition (new / used)	Used

A yearly calibration interval is recommended.

**3 PRODUCT DESCRIPTION**

**3.1 GENERAL INFORMATION**

MVG's COMOSAR Validation Dipoles are built in accordance to the IEEE 1528, FCC KDBs and CE/IEC 62209 standards. The product is designed for use with the COMOSAR test bench only.



**Figure 1 – MVG COMOSAR Validation Dipole**

#### 4 MEASUREMENT METHOD

The IEEE 1528, FCC KDBs and CEI/IEC 62209 standards provide requirements for reference dipoles used for system validation measurements. The following measurements were performed to verify that the product complies with the fore mentioned standards.

##### 4.1 RETURN LOSS REQUIREMENTS

The dipole used for SAR system validation measurements and checks must have a return loss of -20 dB or better. The return loss measurement shall be performed against a liquid filled flat phantom with the phantom constructed as outlined in the fore mentioned standards.

##### 4.2 MECHANICAL REQUIREMENTS

The IEEE Std. 1528 and CEI/IEC 62209 standards specify the mechanical components and dimensions of the validation dipoles, with the dimensions frequency and phantom shell thickness dependent. The COMOSAR test bench employs a 2 mm phantom shell thickness therefore the dipoles sold for use with the COMOSAR test bench comply with the requirements set forth for a 2 mm phantom shell thickness.

#### 5 MEASUREMENT UNCERTAINTY

All uncertainties listed below represent an expanded uncertainty expressed at approximately the 95% confidence level using a coverage factor of k=2, traceable to the Internationally Accepted Guides to Measurement Uncertainty.

##### 5.1 RETURN LOSS

The following uncertainties apply to the return loss measurement:

Frequency band	Expanded Uncertainty on Return Loss
400-6000MHz	0.1 dB

##### 5.2 DIMENSION MEASUREMENT

The following uncertainties apply to the dimension measurements:

Length (mm)	Expanded Uncertainty on Length
3 - 300	0.05 mm

##### 5.3 VALIDATION MEASUREMENT

The guidelines outlined in the IEEE 1528, FCC KDBs, CENELEC EN50361 and CEI/IEC 62209 standards were followed to generate the measurement uncertainty for validation measurements.

Scan Volume	Expanded Uncertainty
1 g	20.3 %

Page: 5/11

*This document shall not be reproduced, copied in full or in part, without the written approval of MVG.  
The information contained herein is to be used only for the purpose for which it is submitted and is not to be released in whole or part without written approval of MVG.*





10 g	20.1 %
------	--------

**6 CALIBRATION MEASUREMENT RESULTS**

**6.1 RETURN LOSS AND IMPEDANCE IN HEAD LIQUID**

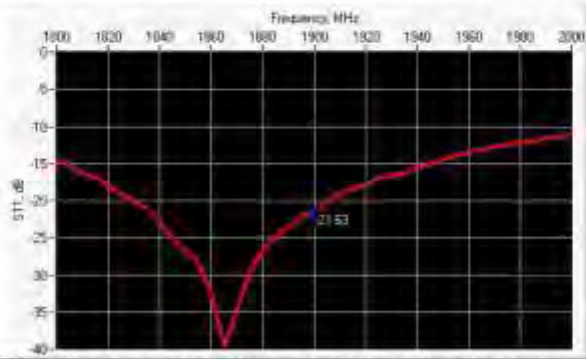

Frequency (MHz)	Return Loss (dB)	Requirement (dB)	Impedance
1900	-21.63	-20	53.9 Ω + 7.7 jΩ

**6.2 RETURN LOSS AND IMPEDANCE IN BODY LIQUID**

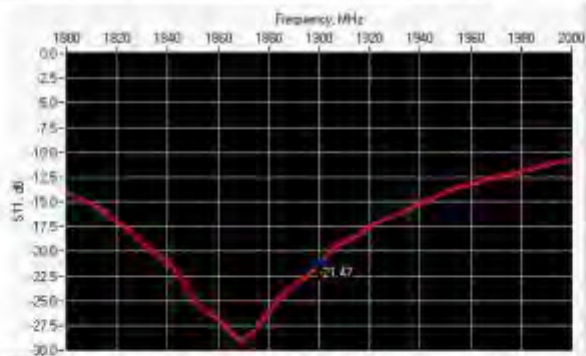

Frequency (MHz)	Return Loss (dB)	Requirement (dB)	Impedance
1900	-21.47	-20	48.9 Ω + 8.4 jΩ

**6.3 MECHANICAL DIMENSIONS**

Frequency MHz	L mm		h mm		d mm	
	required	measured	required	measured	required	measured
300	420.0 ±1 %		250.0 ±1 %		6.35 ±1 %	

Page: 6/11

*This document shall not be reproduced, except in full or in part, without the written approval of MVG. The information contained herein is to be used only for the purpose for which it is submitted and is not to be released in whole or part without written approval of MVG.*

450	290.0 ±1 %		166.7 ±1 %		6.35 ±1 %
750	176.0 ±1 %		100.0 ±1 %		6.35 ±1 %
835	161.0 ±1 %		89.8 ±1 %		3.6 ±1 %
900	149.0 ±1 %		83.3 ±1 %		3.6 ±1 %
1450	89.1 ±1 %		51.7 ±1 %		3.6 ±1 %
1500	80.5 ±1 %		50.0 ±1 %		3.6 ±1 %
1640	79.0 ±1 %		45.7 ±1 %		3.6 ±1 %
1750	75.2 ±1 %		42.8 ±1 %		3.6 ±1 %
1800	72.0 ±1 %		41.7 ±1 %		3.6 ±1 %
1900	68.0 ±1 %	PASS	39.5 ±1 %	PASS	3.6 ±1 %
1950	66.3 ±1 %		38.5 ±1 %		3.6 ±1 %
2000	64.5 ±1 %		37.5 ±1 %		3.6 ±1 %
2100	61.0 ±1 %		35.7 ±1 %		3.6 ±1 %
2300	55.5 ±1 %		32.6 ±1 %		3.6 ±1 %
2450	51.5 ±1 %		30.4 ±1 %		3.6 ±1 %
2600	48.5 ±1 %		28.8 ±1 %		3.6 ±1 %
3000	41.5 ±1 %		25.0 ±1 %		3.6 ±1 %
3500	37.0 ±1 %		26.4 ±1 %		3.6 ±1 %
3700	34.7 ±1 %		26.4 ±1 %		3.6 ±1 %

## 7 VALIDATION MEASUREMENT

The IEEE Std. 1528, FCC KDBs and CEI/IEC 62209 standards state that the system validation measurements must be performed using a reference dipole meeting the fore mentioned return loss and mechanical dimension requirements. The validation measurement must be performed against a liquid filled flat phantom, with the phantom constructed as outlined in the fore mentioned standards. Per the standards, the dipole shall be positioned below the bottom of the phantom, with the dipole length centered and parallel to the longest dimension of the flat phantom, with the top surface of the dipole at the described distance from the bottom surface of the phantom.

### 7.1 HEAD LIQUID MEASUREMENT

Frequency MHz	Relative permittivity (ε <sub>r</sub> )		Conductivity (σ) S/m	
	required	measured	required	measured
300	45.3 ±5 %		0.87 ±5 %	
450	43.5 ±5 %		0.87 ±5 %	
750	41.9 ±5 %		0.88 ±5 %	
835	41.5 ±5 %		0.90 ±5 %	
900	41.5 ±5 %		0.97 ±5 %	
1450	40.5 ±5 %		1.20 ±5 %	
1500	40.4 ±5 %		1.23 ±5 %	
1640	40.2 ±5 %		1.31 ±5 %	
1750	40.1 ±5 %		1.37 ±5 %	

Page: 7/11

*This document shall not be reproduced, copied in full or in part, without the written approval of MVG.  
The information contained herein is to be used only for the purpose for which it is submitted and is not to be released in whole or part without written approval of MVG.*



SAR REFERENCE DIPOLE CALIBRATION REPORT

Ref: ACR-75.11.15.S&TU.A

1800	40.0 ±5 %		1.40 ±5 %	
1900	40.0 ±5 %	PASS	1.40 ±5 %	PASS
1950	40.0 ±5 %		1.40 ±5 %	
2000	40.0 ±5 %		1.40 ±5 %	
2100	39.8 ±5 %		1.49 ±5 %	
2300	39.5 ±5 %		1.67 ±5 %	
2450	39.2 ±5 %		1.80 ±5 %	
2600	39.0 ±5 %		1.96 ±5 %	
3000	38.5 ±5 %		2.40 ±5 %	
3500	37.9 ±5 %		2.92 ±5 %	

7.2 SAR MEASUREMENT RESULT WITH HEAD LIQUID

The IEEE Std. 1528 and CEI/IEC 62209 standards state that the system validation measurements should produce the SAR values shown below (for phantom thickness of 2 mm), within the uncertainty for the system validation. All SAR values are normalized to 1 W forward power. In bracket, the measured SAR is given with the used input power.

Software	OPENSAR V4
Phantom	SN 2009 SAM71
Probe	SN 18/11 BPG122
Liquid	Head Liquid Values: eps = 40.9 sigma = 1.43
Distance between dipole center and liquid	10.0 mm
Area scan resolution	dx=8mm /dy=8mm
Zoon Scan Resolution	dx=8mm /dy=8m /dz=5mm
Frequency	1500 MHz
Input power	20 dBm
Liquid Temperature	21 °C
Lab Temperature	21 °C
Lab Humidity	45 %

Frequency MHz	1 g SAR (W/kg/W)		10 g SAR (W/kg/W)	
	required	measured	required	measured
300	2.85		1.94	
450	4.58		3.06	
750	8.49		5.55	
835	9.56		6.22	
900	10.9		6.99	
1450	29		16	
1500	30.5		16.8	
1640	34.2		18.4	
1750	36.4		19.3	
1800	38.4		20.3	

Page: 8/11

*This document shall not be reproduced, copied in full or in part, without the written approval of MVG. The information contained herein is to be used only for the purpose for which it is submitted and is not to be released in whole or part without written approval of MVG.*



SAR REFERENCE DIPOLE CALIBRATION REPORT

Ref: ACR-75.1.15.S&TJ.A

1900	39.7	40.75 (4.08)	20.5	20.82 (2.08)
1950	40.5		20.9	
2000	41.1		21.1	
2100	43.6		21.9	
2300	48.7		23.3	
2450	52.4		24	
2600	55.3		24.6	
3000	63.8		25.7	
3500	67.1		25	

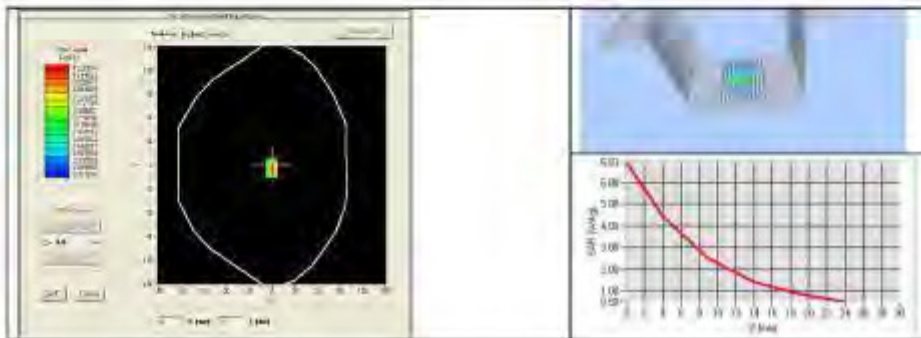

7.3 BODY LIQUID MEASUREMENT

Frequency MHz	Relative permittivity ( $\epsilon_r$ )		Conductivity ( $\sigma$ ) S/m	
	required	measured	required	measured
150	61.9 ±5 %		0.80 ±5 %	
300	58.2 ±5 %		0.92 ±5 %	
450	56.7 ±5 %		0.94 ±5 %	
750	55.5 ±5 %		0.96 ±5 %	
835	55.2 ±5 %		0.97 ±5 %	
900	55.0 ±5 %		1.05 ±5 %	
915	55.0 ±5 %		1.06 ±5 %	
1450	54.0 ±5 %		1.30 ±5 %	
1610	53.8 ±5 %		1.40 ±5 %	
1800	53.3 ±5 %		1.52 ±5 %	
1900	53.3 ±5 %	PASS	1.52 ±5 %	PASS
2000	53.3 ±5 %		1.52 ±5 %	
2100	53.2 ±5 %		1.62 ±5 %	
2450	52.7 ±5 %		1.85 ±5 %	

Page: 9/11

*This document shall not be reproduced, except in full or in part, without the written approval of MVG. The information contained herein is to be used only for the purpose for which it is submitted and is not to be released in whole or part without written approval of MVG.*



SAR REFERENCE DIPOLE CALIBRATION REPORT

Rev: ACR-75.11.15 S&TU A

2600	52.5 ±5 %		2.16 ±5 %	
3000	52.0 ±5 %		2.73 ±5 %	
3500	51.3 ±5 %		3.31 ±5 %	
5200	49.0 ±10 %		5.30 ±10 %	
5300	48.9 ±10 %		5.42 ±10 %	
5400	48.7 ±10 %		5.53 ±10 %	
5500	48.6 ±10 %		5.65 ±10 %	
5600	48.5 ±10 %		5.77 ±10 %	
5800	48.2 ±10 %		6.00 ±10 %	

7.4 SAR MEASUREMENT RESULT WITH BODY LIQUID

Software	OPENSAR V4
Phantom	SN 20/09 SAM71
Probe	SN 18/11 EPG122
Liquid	Body Liquid Values: eps = 53.9 sigma = 1.55
Distance between dipole center and liquid	10.0 mm
Area scan resolution	dx=8mm/dy=8mm
Zoon Scan Resolution	dx=8mm/dy=8m/dz=5mm
Frequency	1900 MHz
Input power	20 dBm
Liquid Temperature	21 °C
Lab Temperature	21 °C
Lab Humidity	45 %

Frequency MHz	1 g SAR (W/kg/W)	10 g SAR (W/kg/W)
	measured	measured
1900	12.05 (4.21)	21.87 (2.19)

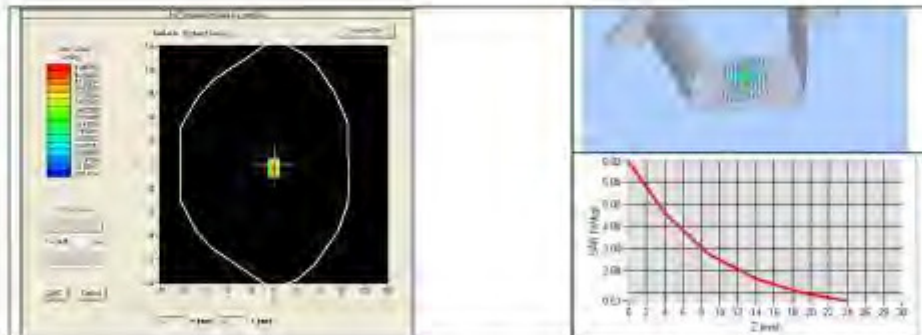

Page: 10/11

*This document shall not be reproduced, except in full or in part, without the written approval of MVG. The information contained herein is to be used only for the purpose for which it is submitted and is not to be released in whole or part without written approval of MVG.*



**8 LIST OF EQUIPMENT**

Equipment Summary Sheet				
Equipment Description	Manufacturer / Model	Identification No.	Current Calibration Date	Next Calibration Date
SAM Phantom	MVG	SN-20/09-SAM71	Validated. No cal required.	Validated. No cal required.
COMOSAR Test Bench	Version 3	NA	Validated. No cal required.	Validated. No cal required.
Network Analyzer	Rhode & Schwarz ZVA	SN100132	02/2013	02/2016
Calipers	Carrera	CALIPER-01	12/2013	12/2016
Reference Probe	MVG	EPG122 SN 18/11	10/2014	10/2015
Multimeter	Keithley 2000	1188656	12/2013	12/2016
Signal Generator	Agilent E4438C	MY49070581	12/2013	12/2016
Amplifier	Aethercomm	SN 046	Characterized prior to test. No cal required.	Characterized prior to test. No cal required.
Power Meter	HP E4418A	US38261498	12/2013	12/2016
Power Sensor	HP ECP-E26A	US37181480	12/2013	12/2016
Directional Coupler	Narda 4216-20	01386	Characterized prior to test. No cal required.	Characterized prior to test. No cal required.
Temperature and Humidity Sensor	Control Company	11-661-9	8/2012	8/2015



## SAR Reference Dipole Calibration Report

Ref: ACR.75.13.15.SATU.A

**SHENZHEN BALUN TECHNOLOGY CO.,LTD.**  
**BLOCK B, FL 1, BAISHA SCIENCE AND TECHNOLOGY**  
**PARK, SHAHE XI ROAD,**  
**NANSHAN DISTRICT, SHENZHEN, GUANGDONG**  
**PROVINCE, P.R. CHINA 518055**  
**MVG COMOSAR REFERENCE DIPOLE**  
**FREQUENCY: 2450 MHZ**  
**SERIAL NO.: SN 25/13 DIP 2G450-251**

**Calibrated at MVG US**  
**2105 Barrett Park Dr. - Kennesaw, GA 30144**



**03/16/2015**

### *Summary:*

This document presents the method and results from an accredited SAR reference dipole calibration performed in MVG USA using the COMOSAR test bench. All calibration results are traceable to national metrology institutions.



SAR REFERENCE DIPOLE CALIBRATION REPORT

Ref: ACR-70.13.03 SAR11.A

	<i>Name</i>	<i>Function</i>	<i>Date</i>	<i>Signature</i>
<i>Prepared by :</i>	Jérôme LUC	Product Manager	3/16/2015	<i>JS</i>
<i>Checked by :</i>	Jérôme LUC	Product Manager	3/16/2015	<i>JS</i>
<i>Approved by :</i>	Kim RUTKOWSKI	Quality Manager	3/16/2015	<i>Kim Rutkowski</i>

	<i>Customer Name</i>
<i>Distribution :</i>	SHENZHEN BALUN TECHNOLOGY Co.,Ltd.

<i>Issue</i>	<i>Date</i>	<i>Modifications</i>
A	3/16/2015	Initial release





## TABLE OF CONTENTS

1	Introduction.....	4
2	Device Under Test .....	4
3	Product Description .....	4
3.1	General Information .....	4
4	Measurement Method .....	5
4.1	Return Loss Requirements .....	5
4.2	Mechanical Requirements .....	5
5	Measurement Uncertainty.....	5
5.1	Return Loss .....	5
5.2	Dimension Measurement .....	5
5.3	Validation Measurement .....	5
6	Calibration Measurement Results.....	6
6.1	Return Loss and Impedance In Head Liquid .....	6
6.2	Return Loss and Impedance In Body Liquid .....	6
6.3	Mechanical Dimensions .....	6
7	Validation measurement .....	7
7.1	Head Liquid Measurement .....	7
7.2	SAR Measurement Result With Head Liquid .....	8
7.3	Body Liquid Measurement .....	9
7.4	SAR Measurement Result With Body Liquid .....	10
8	List of Equipment .....	11

Page: 3/11

*This document shall not be reproduced, stored in full or in part, without the written approval of MVG.  
The information contained herein is to be used only for the purpose for which it is submitted and is not to  
be released in whole or part without written approval of MVG.*



**1 INTRODUCTION**

This document contains a summary of the requirements set forth by the IEEE 1528, FCC KDBs and CE/IEC 62209 standards for reference dipoles used for SAR measurement system validations and the measurements that were performed to verify that the product complies with the fore mentioned standards.

**2 DEVICE UNDER TEST**

Device Under Test	
Device Type	COMOSAR 2450 MHz REFERENCE DIPOLE
Manufacturer	MVG
Model	SID2450
Serial Number	SN 25/13 DIP 2G450-251
Product Condition (new / used)	Used

A yearly calibration interval is recommended.

**3 PRODUCT DESCRIPTION**

**3.1 GENERAL INFORMATION**

MVG's COMOSAR Validation Dipoles are built in accordance to the IEEE 1528, FCC KDBs and CE/IEC 62209 standards. The product is designed for use with the COMOSAR test bench only.



**Figure 1 – MVG COMOSAR Validation Dipole**

**4 MEASUREMENT METHOD**

The IEEE 1528, FCC KDBs and CEI/IEC 62209 standards provide requirements for reference dipoles used for system validation measurements. The following measurements were performed to verify that the product complies with the fore mentioned standards.

**4.1 RETURN LOSS REQUIREMENTS**

The dipole used for SAR system validation measurements and checks must have a return loss of -20 dB or better. The return loss measurement shall be performed against a liquid filled flat phantom with the phantom constructed as outlined in the fore mentioned standards.

**4.2 MECHANICAL REQUIREMENTS**

The IEEE Std. 1528 and CEI/IEC 62209 standards specify the mechanical components and dimensions of the validation dipoles, with the dimensions frequency and phantom shell thickness dependent. The COMOSAR test bench employs a 2 mm phantom shell thickness therefore the dipoles sold for use with the COMOSAR test bench comply with the requirements set forth for a 2 mm phantom shell thickness.

**5 MEASUREMENT UNCERTAINTY**

All uncertainties listed below represent an expanded uncertainty expressed at approximately the 95% confidence level using a coverage factor of k=2, traceable to the Internationally Accepted Guides to Measurement Uncertainty.

**5.1 RETURN LOSS**

The following uncertainties apply to the return loss measurement:

Frequency band	Expanded Uncertainty on Return Loss
400-6000MHz	0.1 dB

**5.2 DIMENSION MEASUREMENT**

The following uncertainties apply to the dimension measurements:

Length (mm)	Expanded Uncertainty on Length
3 - 300	0.05 mm

**5.3 VALIDATION MEASUREMENT**

The guidelines outlined in the IEEE 1528, FCC KDBs, CENELEC EN50361 and CEI/IEC 62209 standards were followed to generate the measurement uncertainty for validation measurements.

Scan Volume	Expanded Uncertainty
1 g	20.3 %



10 g	20.1 %
------	--------

## 6 CALIBRATION MEASUREMENT RESULTS

### 6.1 RETURN LOSS AND IMPEDANCE IN HEAD LIQUID

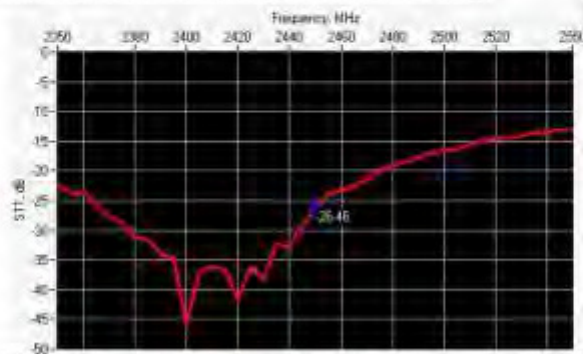

Frequency (MHz)	Return Loss (dB)	Requirement (dB)	Impedance
2450	-26.46	-20	49.3 $\Omega$ - 4.7 j $\Omega$

### 6.2 RETURN LOSS AND IMPEDANCE IN BODY LIQUID

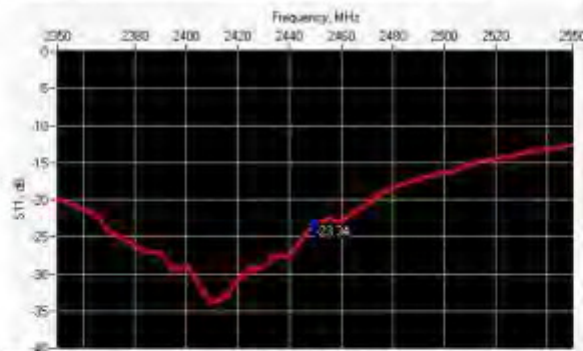

Frequency (MHz)	Return Loss (dB)	Requirement (dB)	Impedance
2450	-23.34	-20	53.4 $\Omega$ - 6.2 j $\Omega$

### 6.3 MECHANICAL DIMENSIONS

Frequency MHz	L mm		h mm		d mm	
	required	measured	required	measured	required	measured
300	420.0 $\pm$ 1 %		250.0 $\pm$ 1 %		6.35 $\pm$ 1 %	

Page: 6/11

*This document shall not be reproduced, except in full or in part, without the written approval of MVG. The information contained herein is to be used only for the purpose for which it is submitted and is not to be released in whole or part without written approval of MVG.*



SAR REFERENCE DIPOLE CALIBRATION REPORT

Ref: ACR-2015-54071-A

450	290.0 ±1 %		166.7 ±1 %		6.35 ±1 %	
750	176.0 ±1 %		100.0 ±1 %		6.35 ±1 %	
835	161.0 ±1 %		89.8 ±1 %		3.6 ±1 %	
900	149.0 ±1 %		83.3 ±1 %		3.6 ±1 %	
1450	89.1 ±1 %		51.7 ±1 %		3.6 ±1 %	
1500	80.5 ±1 %		50.0 ±1 %		3.6 ±1 %	
1640	79.0 ±1 %		45.7 ±1 %		3.6 ±1 %	
1750	75.2 ±1 %		42.8 ±1 %		3.6 ±1 %	
1800	72.0 ±1 %		41.7 ±1 %		3.6 ±1 %	
1900	68.0 ±1 %		39.5 ±1 %		3.6 ±1 %	
1950	66.3 ±1 %		38.5 ±1 %		3.6 ±1 %	
2000	64.5 ±1 %		37.5 ±1 %		3.6 ±1 %	
2100	61.0 ±1 %		35.7 ±1 %		3.6 ±1 %	
2300	55.5 ±1 %		32.6 ±1 %		3.6 ±1 %	
2450	51.5 ±1 %	PASS	30.4 ±1 %	PASS	3.6 ±1 %	PASS
2600	48.5 ±1 %		28.8 ±1 %		3.6 ±1 %	
3000	41.5 ±1 %		25.0 ±1 %		3.6 ±1 %	
3500	37.0 ±1 %		26.4 ±1 %		3.6 ±1 %	
3700	34.7 ±1 %		26.4 ±1 %		3.6 ±1 %	

7 VALIDATION MEASUREMENT

The IEEE Std. 1528, FCC KDBs and CEI/IEC 62209 standards state that the system validation measurements must be performed using a reference dipole meeting the fore mentioned return loss and mechanical dimension requirements. The validation measurement must be performed against a liquid filled flat phantom, with the phantom constructed as outlined in the fore mentioned standards. Per the standards, the dipole shall be positioned below the bottom of the phantom, with the dipole length centered and parallel to the longest dimension of the flat phantom, with the top surface of the dipole at the described distance from the bottom surface of the phantom.

7.1 HEAD LIQUID MEASUREMENT

Frequency (MHz)	Relative permittivity (ε <sub>r</sub> )		Conductivity (σ) S/m	
	required	measured	required	measured
300	45.3 ±5 %		0.87 ±5 %	
450	43.5 ±5 %		0.87 ±5 %	
750	41.9 ±5 %		0.88 ±5 %	
835	41.5 ±5 %		0.90 ±5 %	
900	41.5 ±5 %		0.97 ±5 %	
1450	40.5 ±5 %		1.20 ±5 %	
1500	40.4 ±5 %		1.23 ±5 %	
1640	40.2 ±5 %		1.31 ±5 %	
1750	40.1 ±5 %		1.37 ±5 %	

Page: 7/11

*This document shall not be reproduced, copied in full or in part, without the written approval of MVG. The information contained herein is to be used only for the purpose for which it is submitted and is not to be released in whole or part without written approval of MVG.*



SAR REFERENCE DIPOLE CALIBRATION REPORT

Ref: ACR-72.13.03 SAR(U) A

1800	40.0 ±5 %		1.40 ±5 %	
1900	40.0 ±5 %		1.40 ±5 %	
1950	40.0 ±5 %		1.40 ±5 %	
2000	40.0 ±5 %		1.40 ±5 %	
2100	39.8 ±5 %		1.49 ±5 %	
2300	39.5 ±5 %		1.67 ±5 %	
2450	39.2 ±5 %	PASS	1.80 ±5 %	PASS
2600	39.0 ±5 %		1.86 ±5 %	
3000	38.5 ±5 %		2.40 ±5 %	
3500	37.9 ±5 %		2.92 ±5 %	

7.2 SAR MEASUREMENT RESULT WITH HEAD LIQUID

The IEEE Std. 1528 and CEI/IEC 62209 standards state that the system validation measurements should produce the SAR values shown below (for phantom thickness of 2 mm), within the uncertainty for the system validation. All SAR values are normalized to 1 W forward power. In bracket, the measured SAR is given with the used input power.

Software	OPENSAR V4
Phantom	SN 2009 SAM71
Probe	SN 18711 BPG122
Liquid	Head Liquid Values: eps = 38.9 sigma = 1.79
Distance between dipole center and liquid	10.0 mm
Area scan resolution	dx=8mm dy=8mm
Zoon Scan Resolution	dz= 5mm/dy=5m/dx=5mm
Frequency	2450 MHz
Input power	20 dBm
Liquid Temperature	21 °C
Lab Temperature	21 °C
Lab Humidity	45 %

Frequency MHz	1 g SAR (W/kg/W)		10 g SAR (W/kg/W)	
	required	measured	required	measured
300	2.85		1.94	
450	4.58		3.06	
750	8.49		5.55	
835	9.56		6.22	
900	10.9		6.99	
1450	29		16	
1500	30.5		16.8	
1640	34.2		18.4	
1750	36.4		19.3	
1800	38.4		20.3	

Page: 8/11

*This document shall not be reproduced, copied in full or in part, without the written approval of MVG. The information contained herein is to be used only for the purpose for which it is submitted and is not to be released in whole or part without written approval of MVG.*



SAR REFERENCE DIPOLE CALIBRATION REPORT

Ref: ACR-75.13.15.S&TJ.A

1900	39.7		20.5	
1950	40.5		20.9	
2000	41.1		21.1	
2100	43.6		21.9	
2300	48.7		23.3	
2450	52.4	54.29 (5.43)	24	24.20 (2.42)
2600	55.3		24.6	
3000	63.8		25.7	
3500	67.1		25	

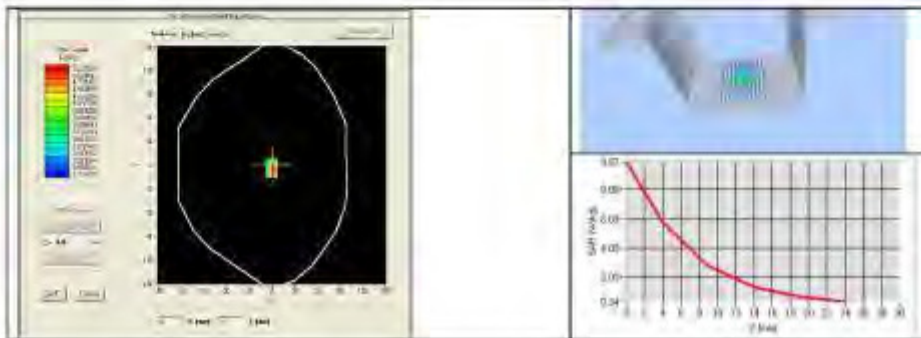

7.3 BODY LIQUID MEASUREMENT

Frequency MHz	Relative permittivity ( $\epsilon_r$ )		Conductivity ( $\sigma$ ) S/m	
	required	measured	required	measured
150	61.9 ±5 %		0.80 ±5 %	
300	58.2 ±5 %		0.92 ±5 %	
450	56.7 ±5 %		0.94 ±5 %	
750	55.5 ±5 %		0.96 ±5 %	
835	55.2 ±5 %		0.97 ±5 %	
900	55.0 ±5 %		1.05 ±5 %	
915	55.0 ±5 %		1.06 ±5 %	
1450	54.0 ±5 %		1.30 ±5 %	
1610	53.8 ±5 %		1.40 ±5 %	
1800	53.3 ±5 %		1.52 ±5 %	
1900	53.3 ±5 %		1.52 ±5 %	
2000	53.3 ±5 %		1.52 ±5 %	
2100	53.2 ±5 %		1.62 ±5 %	
2450	52.7 ±5 %	PASS	1.95 ±5 %	PASS

Page: 9/11

*This document shall not be reproduced, except in full or in part, without the written approval of MVG. The information contained herein is to be used only for the purpose for which it is submitted and is not to be released in whole or part without written approval of MVG.*



SAR REFERENCE DIPOLE CALIBRATION REPORT

Ref: ACR-75.13.15.SAR11.A

2600	52.5 ±5 %		2.16 ±5 %	
3000	52.0 ±5 %		2.73 ±5 %	
3500	51.3 ±5 %		3.31 ±5 %	
5200	49.0 ±10 %		5.30 ±10 %	
5300	48.9 ±10 %		5.42 ±10 %	
5400	48.7 ±10 %		5.53 ±10 %	
5500	48.6 ±10 %		5.65 ±10 %	
5600	48.5 ±10 %		5.77 ±10 %	
5800	48.2 ±10 %		6.00 ±10 %	

7.4 SAR MEASUREMENT RESULT WITH BODY LIQUID

Software	OPENSAR V4
Phantom	SN 20/09 SAM71
Probe	SN 18/11 EPG122
Liquid	Body Liquid Values: eps = 52.7 sigma : 1.94
Distance between dipole center and liquid	10.0 mm
Area scan resolution	dx=8mm/dy=8mm
Zoon Scan Resolution	dx=5mm/dy=5m/dz=5mm
Frequency	2450 MHz
Input power	20 dBm
Liquid Temperature	21 °C
Lab Temperature	21 °C
Lab Humidity	45 %

Frequency MHz	1 g SAR (W/kg/W)	10 g SAR (W/kg/W)
	measured	measured
2450	54.70 (5.47)	24.86 (2.49)

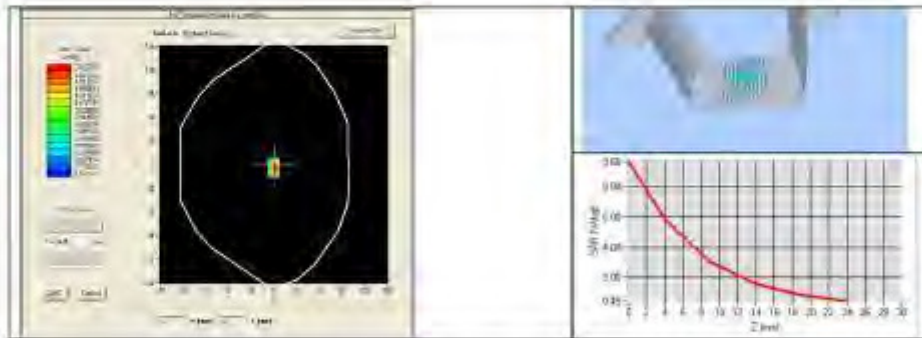

Page: 10/11

*This document shall not be reproduced, except in full or in part, without the written approval of MTVG. The information contained herein is to be used only for the purpose for which it is submitted and is not to be released in whole or part without written approval of MTVG.*



**8 LIST OF EQUIPMENT**

Equipment Summary Sheet				
Equipment Description	Manufacturer / Model	Identification No.	Current Calibration Date	Next Calibration Date
SAM Phantom	MVG	SN-20/09-SAM71	Validated. No cal required.	Validated. No cal required.
CCMOSAR Test Bench	Version 3	NA	Validated. No cal required.	Validated. No cal required.
Network Analyzer	Rhode & Schwarz ZVA	SN100132	02/2013	02/2016
Calipers	Carrera	CALIPER-01	12/2013	12/2016
Reference Probe	MVG	EPG122 SN 18/11	10/2014	10/2015
Multimeter	Kelthley 2000	1188656	12/2013	12/2016
Signal Generator	Agilent E4438C	MY49070581	12/2013	12/2016
Amplifier	Aethercomm	SN 046	Characterized prior to test. No cal required.	Characterized prior to test. No cal required.
Power Meter	HP E4418A	US38261498	12/2013	12/2016
Power Sensor	HP ECP-E26A	US37181460	12/2013	12/2016
Directional Coupler	Narda 4216-20	01386	Characterized prior to test. No cal required.	Characterized prior to test. No cal required.
Temperature and Humidity Sensor	Control Company	11-661-9	8/2012	8/2015

Page: 11/11

*This document shall not be reproduced, except in full or in part, without the written approval of MVG.  
The information contained herein is to be used only for the purpose for which it is submitted and is not to be released in whole or part without written approval of MVG.*



### SAR Reference Dipole Calibration Report

Ref: ACR.75.14.15.SATU.A

**SHENZHEN BALUN TECHNOLOGY CO.,LTD.**  
**BLOCK B, FL 1, BAISHA SCIENCE AND TECHNOLOGY**  
**PARK, SHAHE XI ROAD,**  
**NANSHAN DISTRICT, SHENZHEN, GUANGDONG**  
**PROVINCE, P.R. CHINA 518055**  
**MVG COMOSAR REFERENCE DIPOLE**  
**FREQUENCY: 2600 MHZ**  
**SERIAL NO.: SN 25/13 DIP 2G600-254**

**Calibrated at MVG US**  
**2105 Barrett Park Dr. - Kennesaw, GA 30144**



**03/16/2015**

*Summary:*

This document presents the method and results from an accredited SAR reference dipole calibration performed in MVG USA using the COMOSAR test bench. All calibration results are traceable to national metrology institutions.



SAR REFERENCE DIPOLE CALIBRATION REPORT

Ref: ACS.75.14.13.5&IT1.A

	<i>Name</i>	<i>Function</i>	<i>Date</i>	<i>Signature</i>
<i>Prepared by :</i>	Jérôme LUC	Product Manager	3/16/2015	<i>JS</i>
<i>Checked by :</i>	Jerôme LUC	Product Manager	3/16/2015	<i>JS</i>
<i>Approved by :</i>	Kim RUTKOWSKI	Quality Manager	3/16/2015	<i>Kim Rutkowski</i>

	<i>Customer Name</i>
<i>Distribution :</i>	SHENZHEN BALUN TECHNOLOGY Co.,Ltd.

<i>Issue</i>	<i>Date</i>	<i>Modifications</i>
A	3/16/2015	Initial release

Page: 2/11

This document shall not be reproduced, stored in full or in part, without the written approval of MVG.  
The information contained herein is to be used only for the purpose for which it is submitted and is not to be released in whole or part without written approval of MVG.

**TABLE OF CONTENTS**

1	Introduction.....	4
2	Device Under Test .....	4
3	Product Description .....	4
3.1	General Information .....	4
4	Measurement Method .....	5
4.1	Return Loss Requirements .....	5
4.2	Mechanical Requirements .....	5
5	Measurement Uncertainty.....	5
5.1	Return Loss .....	5
5.2	Dimension Measurement .....	5
5.3	Validation Measurement .....	5
6	Calibration Measurement Results.....	6
6.1	Return Loss and Impedance In Head Liquid .....	6
6.2	Return Loss and Impedance In Body Liquid .....	6
6.3	Mechanical Dimensions .....	6
7	Validation measurement .....	7
7.1	Head Liquid Measurement .....	7
7.2	SAR Measurement Result With Head Liquid .....	8
7.3	Body Liquid Measurement .....	9
7.4	SAR Measurement Result With Body Liquid .....	10
8	List of Equipment .....	11

Page: 3/11

*This document shall not be reproduced, stored in full or in part, without the written approval of MVG.  
The information contained herein is to be used only for the purpose for which it is submitted and is not to be released in whole or part without written approval of MVG.*



**1 INTRODUCTION**

This document contains a summary of the requirements set forth by the IEEE 1528, FCC KDBs and CEI/IEC 62209 standards for reference dipoles used for SAR measurement system validations and the measurements that were performed to verify that the product complies with the fore mentioned standards.

**2 DEVICE UNDER TEST**

Device Under Test	
Device Type	COMOSAR 2600 MHz REFERENCE DIPOLE
Manufacturer	MVG
Model	SID2600
Serial Number	SN 25/13 DIP 2G600-254
Product Condition (new / used)	Used

A yearly calibration interval is recommended.

**3 PRODUCT DESCRIPTION**

**3.1 GENERAL INFORMATION**

MVG's COMOSAR Validation Dipoles are built in accordance to the IEEE 1528, FCC KDBs and CEI/IEC 62209 standards. The product is designed for use with the COMOSAR test bench only.



**Figure 1 – MVG COMOSAR Validation Dipole**

Page: 4/11

*This document shall not be reproduced, stored in full or in part, without the written approval of MVG. The information contained herein is to be used only for the purpose for which it is submitted and is not to be released in whole or part without written approval of MVG.*



**4 MEASUREMENT METHOD**

The IEEE 1528, FCC KDBs and CEI/IEC 62209 standards provide requirements for reference dipoles used for system validation measurements. The following measurements were performed to verify that the product complies with the fore mentioned standards.

**4.1 RETURN LOSS REQUIREMENTS**

The dipole used for SAR system validation measurements and checks must have a return loss of -20 dB or better. The return loss measurement shall be performed against a liquid filled flat phantom with the phantom constructed as outlined in the fore mentioned standards.

**4.2 MECHANICAL REQUIREMENTS**

The IEEE Std. 1528 and CEI/IEC 62209 standards specify the mechanical components and dimensions of the validation dipoles, with the dimensions frequency and phantom shell thickness dependent. The COMOSAR test bench employs a 2 mm phantom shell thickness therefore the dipoles sold for use with the COMOSAR test bench comply with the requirements set forth for a 2 mm phantom shell thickness.

**5 MEASUREMENT UNCERTAINTY**

All uncertainties listed below represent an expanded uncertainty expressed at approximately the 95% confidence level using a coverage factor of k=2, traceable to the Internationally Accepted Guides to Measurement Uncertainty.

**5.1 RETURN LOSS**

The following uncertainties apply to the return loss measurement.

Frequency band	Expanded Uncertainty on Return Loss
400-6000MHz	0.1 dB

**5.2 DIMENSION MEASUREMENT**

The following uncertainties apply to the dimension measurements:

Length (mm)	Expanded Uncertainty on Length
3 - 300	0.05 mm

**5.3 VALIDATION MEASUREMENT**

The guidelines outlined in the IEEE 1528, FCC KDBs, CENELEC EN50361 and CEI/IEC 62209 standards were followed to generate the measurement uncertainty for validation measurements.

Scan Volume	Expanded Uncertainty
1 g	20.3 %

Page: 5/11

*This document shall not be reproduced, copied in full or in part, without the written approval of MVG.  
The information contained herein is to be used only for the purpose for which it is submitted and is not to be released in whole or part without written approval of MVG.*



## SAR REFERENCE DIPOLE CALIBRATION REPORT

Ref: ACR.75.14.15.SATT.A

10 g	20.1 %
------	--------

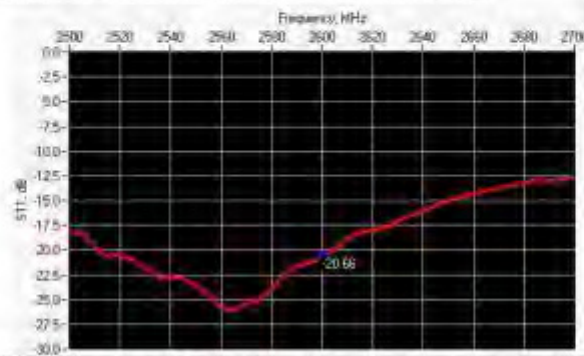
**6 CALIBRATION MEASUREMENT RESULTS**
**6.1 RETURN LOSS AND IMPEDANCE IN HEAD LIQUID**

Frequency (MHz)	Return Loss (dB)	Requirement (dB)	Impedance
2600	-20.66	-20	$51.0 \Omega + 9.4 j\Omega$

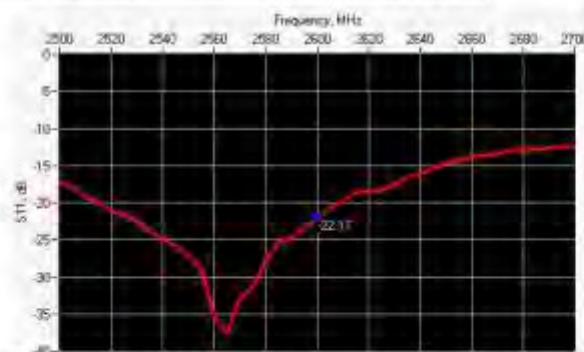
**6.2 RETURN LOSS AND IMPEDANCE IN BODY LIQUID**

Frequency (MHz)	Return Loss (dB)	Requirement (dB)	Impedance
2600	-22.17	-20	$47.9 \Omega + 7.5 j\Omega$

**6.3 MECHANICAL DIMENSIONS**

Frequency MHz	L mm		h mm		d mm	
	required	measured	required	measured	required	measured
300	$420.0 \pm 1 \%$		$250.0 \pm 1 \%$		$6.35 \pm 1 \%$	

Page: 6/11

*This document shall not be reproduced, except in full or in part, without the written approval of MVG. The information contained herein is to be used only for the purpose for which it is submitted and is not to be released in whole or part without written approval of MVG.*



SAR REFERENCE DIPOLE CALIBRATION REPORT

Rev: ACS.75.14.03.5.011/A

450	290.0 ±1 %		166.7 ±1 %		6.35 ±1 %	
750	176.0 ±1 %		100.0 ±1 %		6.35 ±1 %	
835	161.0 ±1 %		89.8 ±1 %		3.6 ±1 %	
900	149.0 ±1 %		83.3 ±1 %		3.6 ±1 %	
1450	89.1 ±1 %		51.7 ±1 %		3.6 ±1 %	
1500	80.5 ±1 %		50.0 ±1 %		3.6 ±1 %	
1640	79.0 ±1 %		45.7 ±1 %		3.6 ±1 %	
1750	75.2 ±1 %		42.8 ±1 %		3.6 ±1 %	
1800	72.0 ±1 %		41.7 ±1 %		3.6 ±1 %	
1900	68.0 ±1 %		39.5 ±1 %		3.6 ±1 %	
1950	66.3 ±1 %		38.5 ±1 %		3.6 ±1 %	
2000	64.5 ±1 %		37.5 ±1 %		3.6 ±1 %	
2100	61.0 ±1 %		36.7 ±1 %		3.6 ±1 %	
2300	55.5 ±1 %		32.6 ±1 %		3.6 ±1 %	
2450	51.5 ±1 %		30.4 ±1 %		3.6 ±1 %	
2600	48.5 ±1 %	PASS	28.8 ±1 %	PASS	3.6 ±1 %	PASS
3000	41.5 ±1 %		25.0 ±1 %		3.6 ±1 %	
3500	37.0 ±1 %		26.4 ±1 %		3.6 ±1 %	
3700	34.7 ±1 %		26.4 ±1 %		3.6 ±1 %	

7 VALIDATION MEASUREMENT

The IEEE Std. 1528, FCC KDBs and CEI/IEC 62209 standards state that the system validation measurements must be performed using a reference dipole meeting the fore mentioned return loss and mechanical dimension requirements. The validation measurement must be performed against a liquid filled flat phantom, with the phantom constructed as outlined in the fore mentioned standards. Per the standards, the dipole shall be positioned below the bottom of the phantom, with the dipole length centered and parallel to the longest dimension of the flat phantom, with the top surface of the dipole at the described distance from the bottom surface of the phantom.

7.1 HEAD LIQUID MEASUREMENT

Frequency MHz	Relative permittivity (ε <sub>r</sub> )		Conductivity (σ) S/m	
	required	measured	required	measured
300	45.3 ±5 %		0.87 ±5 %	
450	43.5 ±5 %		0.87 ±5 %	
750	41.9 ±5 %		0.89 ±5 %	
835	41.5 ±5 %		0.90 ±5 %	
900	41.5 ±5 %		0.97 ±5 %	
1450	40.5 ±5 %		1.20 ±5 %	
1500	40.4 ±5 %		1.23 ±5 %	
1640	40.2 ±5 %		1.31 ±5 %	
1750	40.1 ±5 %		1.37 ±5 %	

Page: 7/11

*This document shall not be reproduced, stored in full or in part, without the written approval of MVG.  
The information contained herein is to be used only for the purpose for which it is submitted and shall not be released in whole or part without written approval of MVG.*





SAR REFERENCE DIPOLE CALIBRATION REPORT

Ref: ACS.75.14.03 SAR/1/A

1800	40.0 ±5 %		1.40 ±5 %	
1900	40.0 ±5 %		1.40 ±5 %	
1950	40.0 ±5 %		1.40 ±5 %	
2000	40.0 ±5 %		1.40 ±5 %	
2100	39.8 ±5 %		1.49 ±5 %	
2300	39.5 ±5 %		1.67 ±5 %	
2450	39.2 ±5 %		1.80 ±5 %	
2600	39.0 ±5 %	PASS	1.96 ±5 %	PASS
3000	38.5 ±5 %		2.40 ±5 %	
3500	37.9 ±5 %		2.95 ±5 %	

7.2 SAR MEASUREMENT RESULT WITH HEAD LIQUID

The IEEE Std. 1528 and CEI/IEC 62209 standards state that the system validation measurements should produce the SAR values shown below (for phantom thickness of 2 mm), within the uncertainty for the system validation. All SAR values are normalized to 1 W forward power. In bracket, the measured SAR is given with the used input power.

Software	OPENSAR V4
Phantom	SN 2009 SAM71
Probe	SN 18/11 EPG122
Liquid	Head Liquid Values: eps = 38.2 sigma = 1.93
Distance between dipole center and liquid	10.0 mm
Area scan resolution	dx=8mm/dy=8mm
Zoon Scan Resolution	dx= 5mm/dy=5mm/dz= 5mm
Frequency	2600 MHz
Input power	20 dBm
Liquid Temperature	21 °C
Lab Temperature	21 °C
Lab Humidity	45 %

Frequency MHz	1 g SAR (W/kg/W)		10 g SAR (W/kg/W)	
	required	measured	required	measured
300	2.85		1.94	
450	4.58		3.06	
750	8.49		5.55	
835	9.56		6.22	
900	10.9		6.99	
1450	29		16	
1500	30.5		16.8	
1640	34.2		18.4	
1750	36.4		19.3	
1800	38.4		20.1	

Page: 8/11

*This document shall not be reproduced, stored in full or in part, without the written approval of MVG. The information contained herein is to be used only for the purpose for which it is submitted and is not to be released in whole or part without written approval of MVG.*



SAR REFERENCE DIPOLE CALIBRATION REPORT

Ref: ACR.75.14.15.S&T1.A

1900	39.7		20.5	
1950	40.5		20.9	
2000	41.1		21.1	
2100	43.6		21.9	
2300	48.7		23.3	
2450	52.4		24	
2600	55.3	57.37 (5.74)	24.6	24.68 (2.47)
3000	63.8		25.7	
3500	67.1		25	

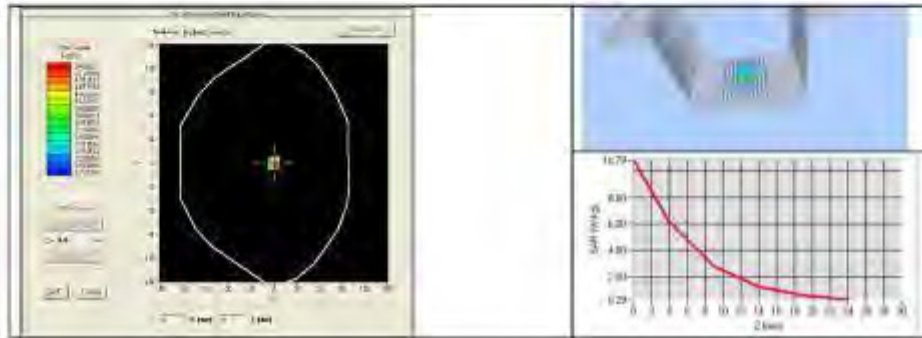

7.3 BODY LIQUID MEASUREMENT

Frequency MHz	Relative permittivity ( $\epsilon_r$ )		Conductivity ( $\sigma$ ) S/m	
	required	measured	required	measured
150	61.9 ±5 %		0.80 ±5 %	
300	58.2 ±5 %		0.92 ±5 %	
450	56.7 ±5 %		0.94 ±5 %	
750	55.5 ±5 %		0.96 ±5 %	
835	55.2 ±5 %		0.97 ±5 %	
900	55.0 ±5 %		1.05 ±5 %	
915	55.0 ±5 %		1.06 ±5 %	
1450	54.0 ±5 %		1.30 ±5 %	
1610	53.8 ±5 %		1.40 ±5 %	
1800	53.3 ±5 %		1.52 ±5 %	
1900	53.3 ±5 %		1.52 ±5 %	
2000	53.3 ±5 %		1.52 ±5 %	
2100	53.2 ±5 %		1.62 ±5 %	
2450	52.7 ±5 %		1.95 ±5 %	

Page: 9/11

*This document shall not be reproduced, stored in full or in part, without the written approval of MVG. The information contained herein is to be used only for the purpose for which it is submitted and is not to be released in whole or part without written approval of MVG.*



SAR REFERENCE DIPOLE CALIBRATION REPORT

Ref: ACR.75.14.15.BATTA

2600	52.5 ±5 %	PASS	2.16 ±5 %	PASS
3000	52.0 ±5 %		2.73 ±5 %	
3500	51.3 ±5 %		3.31 ±5 %	
5200	49.0 ±10 %		5.30 ±10 %	
5300	48.9 ±10 %		5.42 ±10 %	
5400	48.7 ±10 %		5.53 ±10 %	
5500	48.6 ±10 %		5.65 ±10 %	
5600	48.5 ±10 %		5.77 ±10 %	
5800	48.2 ±10 %		6.00 ±10 %	

7.4 SAR MEASUREMENT RESULT WITH BODY LIQUID

Software	OPENSAR V4
Phantom	SN 20/09 SAM71
Probe	SN 18/11 EPG122
Liquid	Body Liquid Values: eps = 51.6 sigma = 2.21
Distance between dipole center and liquid	10.0 mm
Area scan resolution	dx=3mm/dy=3mm
Zoom Scan Resolution	dx=5mm/dy=5mm/dz=5mm
Frequency	2600 MHz
Input power	20 dBm
Liquid Temperature	21 °C
Lab Temperature	21 °C
Lab Humidity	45 %

Frequency MHz	1 g SAR (W/kg/W)	10 g SAR (W/kg/W)
	measured	measured
2600	57.62 (5.76)	25.39 (2.54)

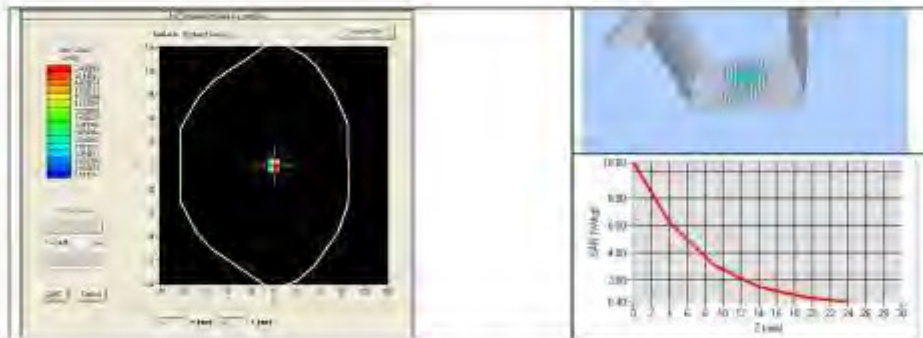

Page: 10/11

*This document shall not be reproduced, except in full or in part, without the written approval of MTG. The information contained herein is to be used only for the purpose for which it is submitted and is not to be released in whole or part without written approval of MTG.*

**8 LIST OF EQUIPMENT**

Equipment Summary Sheet				
Equipment Description	Manufacturer / Model	Identification No.	Current Calibration Date	Next Calibration Date
SAM Phantom	MVG	SN-20109-SAM71	Validated. No cal required.	Validated. No cal required.
COMOSAR Test Bench	Version 3	NA	Validated. No cal required.	Validated. No cal required.
Network Analyzer	Rhode & Schwarz ZVA	SN100132	02/2013	02/2016
Calipers	Carrera	CALIPER-01	12/2013	12/2016
Reference Probe	MVG	EPG122 SN 16/11	10/2014	10/2015
Multimeter	Keithley 2000	1188656	12/2013	12/2016
Signal Generator	Agilent E4438C	MY49070681	12/2013	12/2016
Amplifier	Aethercomm	SN 046	Characterized prior to test. No cal required.	Characterized prior to test. No cal required.
Power Meter	HP E4418A	US38261498	12/2013	12/2016
Power Sensor	HP ECP-E26A	US37181480	12/2013	12/2016
Directional Coupler	Narda 4216-20	01386	Characterized prior to test. No cal required.	Characterized prior to test. No cal required.
Temperature and Humidity Sensor	Control Company	11-661-9	8/2012	8/2015

Page: 11/11

*This document shall not be reproduced, copied in full or in part, without the written approval of MVG.  
The information contained herein is to be used only for the purpose for which it is submitted and is not to be released in whole or part without written approval of MVG.*