



TEST REPORT

Report No.: SRTC2014-H024-E0034

Product Name: GSM/GPRS/EDGE/UMTS

Digital Mobile Phone with Bluetooth and WiFi

Product Model: Philips I928

Applicant: Shenzhen Sang Fei Consumer Communications
Co., Ltd.

Manufacturer: Shenzhen Sang Fei Consumer Communications
Co., Ltd.

Specification: FCC Part15B (Certification)
(October 1, 2009 edition)

FCC ID: VQRCTI928

The State Radio_monitoring_center Testing Center (SRTC)

No.80 Beilishi Road Xicheng District Beijing, China

Tel: 86-10-68009202 Fax: 86-10-68009205

CONTENTS

1. General information	3
1.1 Notes of the test report	3
1.2 Information about the testing laboratory	3
1.3 Applicant's details	3
1.4 Manufacturer's details	3
1.5 Application details	4
1.6 Reference specification	4
1.7 Information of EUT	4
1.7.1 General information	4
1.7.2 EUT details	5
1.7.3 Auxiliary equipment details	5
2. Test information	6
2.1 Summary of the test results	6
2.2 Test result	7
2.2.1 Conducted Emissions-FCC Part15.107	7
2.2.2 Radiated Emissions-FCC Part15.109	16
2.3. List of test equipments	27
Appendix	28

1. General information

1.1 Notes of the test report

The test report may only be reproduced or published in full. Reproduction or publication of extracts from the report requires the prior written permission of The State Radio_monitoring_center Testing Center (SRTC).

The test results relate only to individual items of the samples which have been tested.

1.2 Information about the testing laboratory

Company: The State Radio_monitoring_center Testing Center (SRTC)
Address: No.80 Beilishi Road, Xicheng District, Beijing China
City: Beijing
Country or Region: China
Contacted person: Wang Junfeng
Tel: +86 10 68009181 +86 10 68009202
Fax: +86 10 68009195 +86 10 68009205
Email: wangjf@srrc.org.cn / wangjunfeng@srtc.org.cn

1.3 Applicant's details

Company: Shenzhen Sang Fei Consumer Communications Co., Ltd.
Address: 11 Science & Technology Rd., Shenzhen Hi-tech Industrial Park,
Nanshan District
City: Shenzhen
Country or Region: China
Grantee Code: VQR
Contacted person: Helen.Lin
Tel: 86-755-33308888
Fax: 86-755-26614979
Email: Helen.Lin@sangfei.com

1.4 Manufacturer's details

Company: Shenzhen Sang Fei Consumer Communications Co., Ltd.
Address: 11 Science & Technology Rd., Shenzhen Hi-tech Industrial Park,
Nanshan District
City: Shenzhen
Country or Region: China
Contacted person: Helen.Lin
Tel: 86-755-33308888
Fax: 86-755-26614979
Email: Helen.Lin@sangfei.com

1.5 Application details

Date of reception of test sample: 1st July 2014

Date of test: 1st July 2014 to 7th July 2014

1.6 Reference specification

FCC Part 15B October 1, 2009 (Certification)

1.7 Information of EUT

1.7.1 General information

Name of EUT	GSM/GPRS/EDGE/UMTS Digital Mobile Phone with Bluetooth and WiFi
FCC ID	VQRCTI928
Frequency Range	GSM850/WCDMA Band V: Tx:824~849MHz Rx:869~894MHz PCS1900/WCDMA Band II: Tx:1850~1910MHz Rx:1930~1990MHz
Rated Output Power	GSM850:33.0dBm PCS1900:30.0dBm WCDMA:24.0dBm
E.R.P. & E.I.R.P.	E.R.P.:33.32dBm E.I.R.P.:30.65dBm
Modulation Type	GSM/GPRS:GMSK EDGE: GMSK(Uplink direction) 8PSK(Downlink direction) WCDMA:QPSK
Emission Designator	GSM/GPRS:300KGXW EDGE:300KG7W WCDMA:4M50F9W
Duplex Mode	FDD
Equipment Class	Class B
Duplex Spacing	GSM850/WCDMA Band V:45MHz PCS1900/WCDMA Band II:80MHz
Antenna Type	Fixed Internal
Power Supply	Battery or Charger
Rated Power Supply Voltage	3.8V
Extreme Temperature	Lowest: -30°C Highest: +50°C
Extreme Voltage	Minimum: 3.5V Maximum: 4.2V
HW Version	TMBHb
SW Version	I928_M6592_1418_00_V01A_T01_AG

1.7.2 EUT details

Product Name	Product Model	IMEI
GSM/GPRS/EDGE/UMTS Digital Mobile Phone with Bluetooth and WiFi	Philips I928	864359020040064

1.7.3 Auxiliary equipment details

AE (Auxiliary Equipment) 1#: Charger

Equipment	Charger
Manufacturer	Salcomp (Shenzhen) Co., Ltd
Model Number	S14B08
Input Voltage	100V-240V a.c.
Output Voltage	5.0V d.c.
Frequency	50/60Hz

AE (Auxiliary Equipment) 2#: Battery

Equipment	Battery
Manufacturer	harbin coslight powerco.,ltd
Model Number	AB3000BWMC
Capacity	3000mAh
Rated Voltage	3.8V d.c.

AE (Auxiliary Equipment) 3#: Headset

Equipment	Headset
Manufacturer	Shenzhen TENJI Industrial Co., Ltd.
Model Number	TJ-101100



Note:

All the auxiliary equipments have been labeled with number in order to identify the test sample.

2. Test information

2.1 Summary of the test results

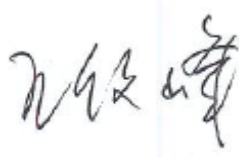
No.	Test case	FCC reference	Verdict
1	Conducted emissions	15.107	Pass
2	Radiated emissions	15.109	Pass

This Test Report Is Issued by: Mr. Song Qizhu Director of the test lab 	Checked by: Mr. Wang Junfeng Deputy director of the test lab 
Tested by: Mr. Dong Qifeng Test engineer 	Issued date: <p style="text-align: center;">2014.07.11</p>

2.2 Test result

2.2.1 Conducted Emissions-FCC Part15.107

Ambient condition:

Temperature	Relative humidity	Pressure
241.2°C	43.5%	100.9kPa

Test Setup:

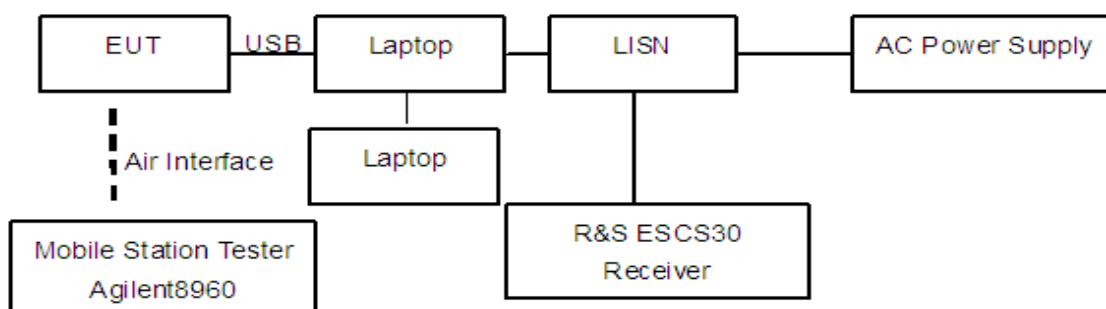

Figure 1

Test Procedure:

The EUT is placed on a non-metallic table 0.4m above the horizontal metal reference ground plane. The EUT connect with a laptop via the USB cable. The accessories of the EUT are connected with the EUT such as headset etc. During the test the data transferring via USB cable between EUT and laptop is maintained. The laptop's LAN port is connected with another laptop via cable. And the data transferring between two laptops is maintained.

The AC main power supply of the laptop is connected to LISN and LISN is connected to the reference ground. The test set-up and the test methods are performed according to ANSI C63.4:2009.

Then start the test software ES-K1. Sweep the whole frequency band through the range from 150 KHz to 30 MHz. The measurement should be done for both L line and N line. During pre-test, the receiver uses both peak detector and average detector. And the final test, the receiver uses both average detector and Quasi-peak detector.

The data of cable loss has been calibrated in full testing frequency range before the testing.

Limit:

Frequency of Emission(MHz)	Limits(dBμV)	
	Quasi-peak	Average
0.15~0.5	66 to 56*	56 to 46*
0.5~5	56	46
5~30	60	50

Note: * Decreases with the logarithm of the frequency

Test result:

Noise Level of The Measuring Instrument

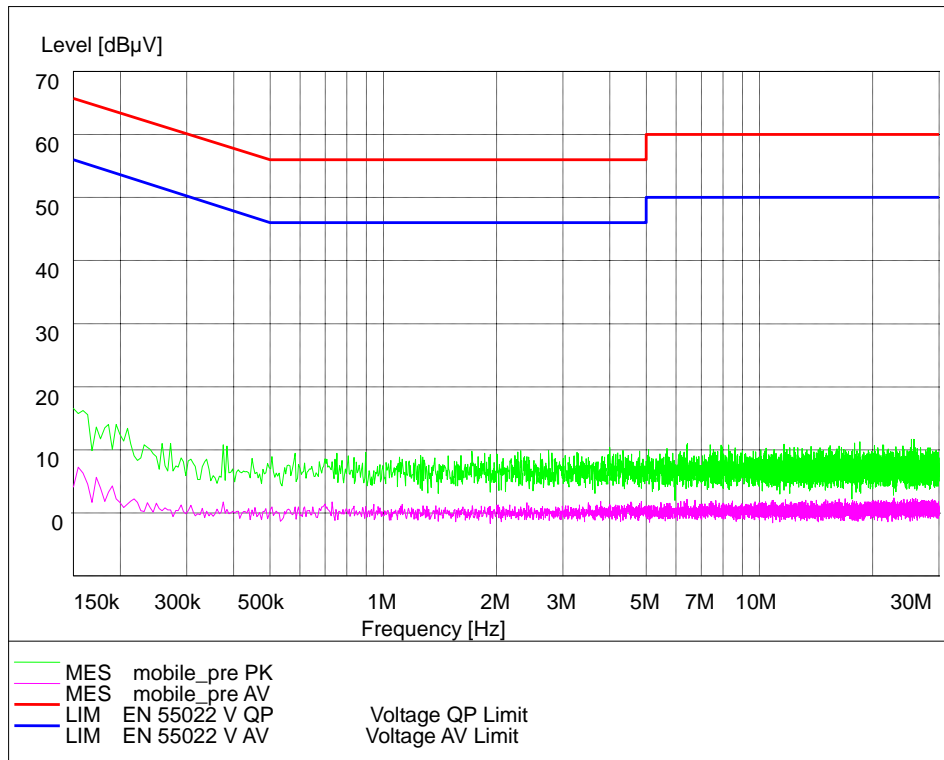

L and N Line

GSM850 Laptop+AE2#+AE3#

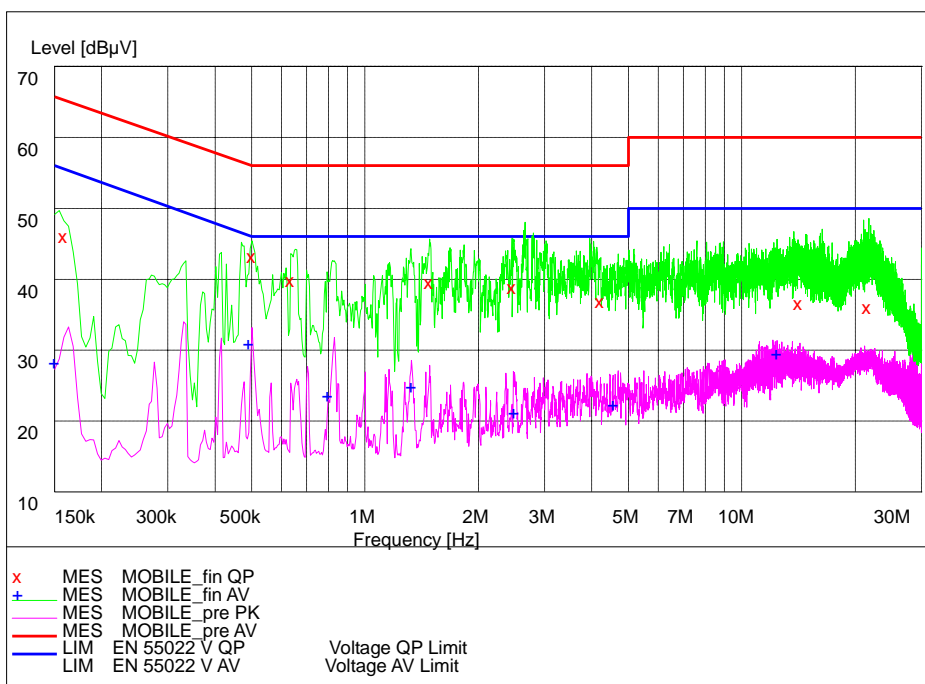

L and N Line

MEASUREMENT RESULT: "MOBILE_fin QP"

Frequency MHz	Level dBμV	Transd	Limit dB	Margin dBμV	Line	PE
0.159000	47.70	20.1	65	17.6	L1	GND
0.501000	44.80	20.3	56	11.2	L1	GND
0.636000	41.50	20.3	56	14.5	L1	GND
1.482000	41.20	20.2	56	14.8	N	GND
2.463000	40.50	20.3	56	15.5	L1	GND
4.218000	38.50	20.4	56	17.5	L1	GND

MEASUREMENT RESULT: "MOBILE_fin AV"

Frequency MHz	Level dBμV	Transd	Limit dB	Margin dBμV	Line	PE
0.492000	32.70	20.3	46	13.4	L1	GND
0.798000	25.30	20.3	46	20.7	L1	GND
1.329000	26.50	20.2	46	19.5	L1	GND
2.490000	22.90	20.3	46	23.1	N	GND
4.569000	24.00	20.4	46	22.0	L1	GND
12.399000	31.20	20.7	50	18.8	L1	GND

PCS1900 Laptop+AE2#+AE3#

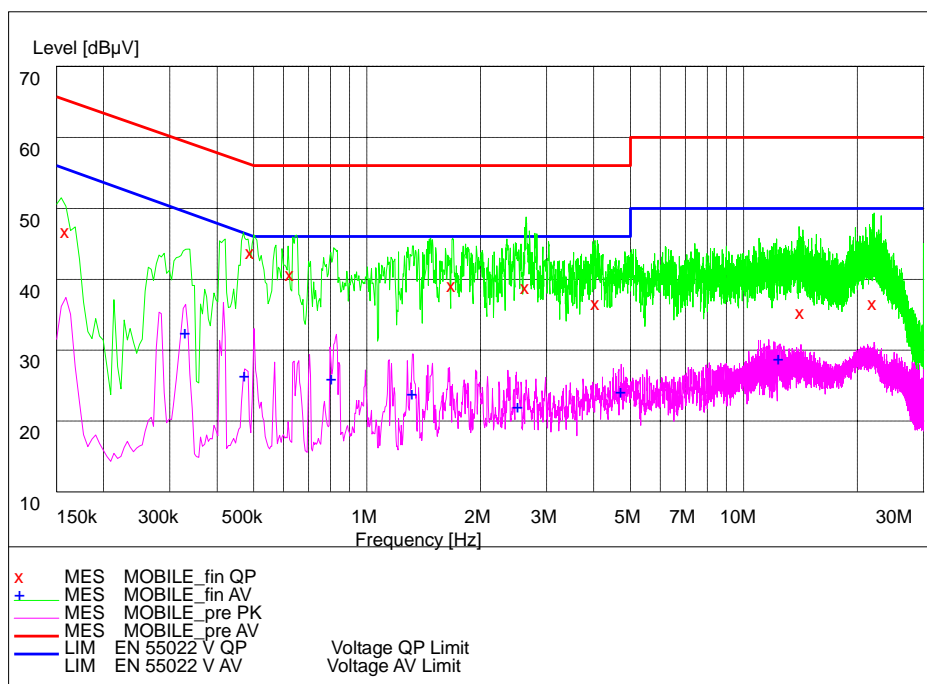

L and N Line

MEASUREMENT RESULT: "MOBILE_fin QP"

Frequency MHz	Level dBμV	Transd	Limit dB	Margin dBμV	Line	PE
0.159000	48.40	20.1	65	16.9	L1	GND
0.492000	45.40	20.3	56	10.8	N	GND
0.627000	42.30	20.3	56	13.7	L1	GND
1.680000	40.80	20.2	56	15.2	L1	GND
2.634000	40.60	20.3	56	15.4	L1	GND
4.065000	38.20	20.3	56	17.8	L1	GND

MEASUREMENT RESULT: "MOBILE_fin AV"

Frequency MHz	Level dBμV	Transd	Limit dB	Margin dBμV	Line	PE
0.330000	34.10	20.2	50	15.3	L1	GND
0.474000	28.10	20.3	46	18.3	L1	GND
0.807000	27.70	20.3	46	18.3	L1	GND
1.320000	25.60	20.2	46	20.4	N	GND
4.731000	25.80	20.4	46	20.2	L1	GND
12.399000	30.50	20.7	50	19.5	L1	GND

WCDMA BAND II Laptop+AE2#+AE3#

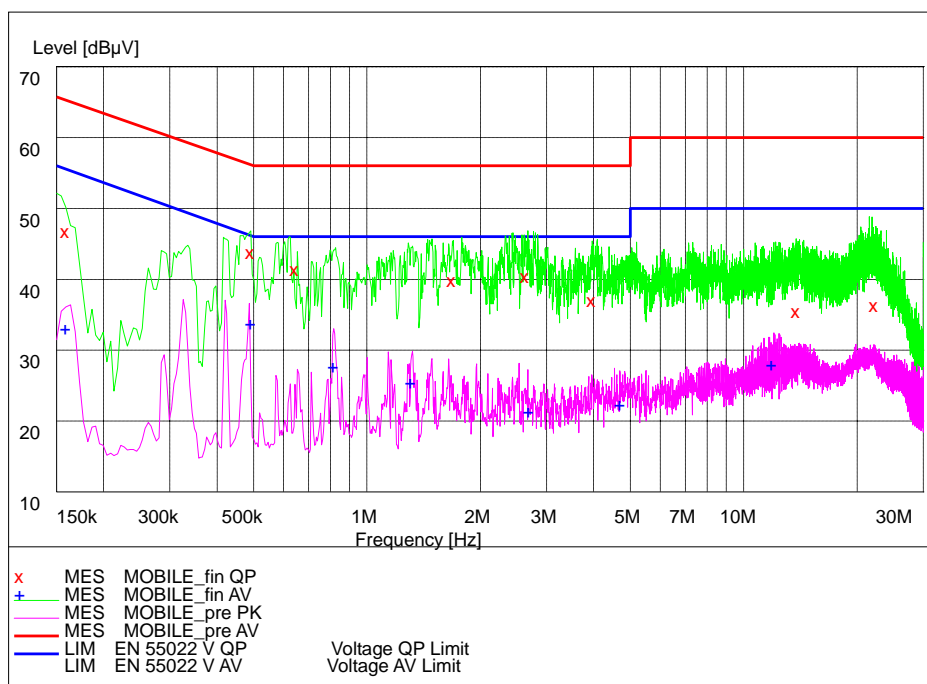

L and N Line

MEASUREMENT RESULT: "MOBILE_fin QP"

Frequency MHz	Level dBμV	Transd	Limit dB	Margin dBμV	Line dB	PE
0.159000	48.40	20.1	65	16.9	L1	GND
0.492000	45.50	20.3	56	10.6	L1	GND
0.645000	43.10	20.3	56	12.9	L1	GND
1.680000	41.50	20.2	56	14.5	N	GND
2.634000	42.10	20.3	56	13.9	L1	GND
3.966000	38.70	20.3	56	17.3	L1	GND

MEASUREMENT RESULT: "MOBILE_fin AV"

Frequency MHz	Level dBμV	Transd	Limit dB	Margin dBμV	Line dB	PE
0.159000	34.70	20.1	56	20.9	L1	GND
0.492000	35.40	20.3	46	10.7	L1	GND
0.816000	29.40	20.3	46	16.6	L1	GND
1.311000	27.10	20.2	46	18.9	N	GND
4.704000	24.00	20.4	46	22.0	L1	GND
11.904000	29.60	20.7	50	20.4	L1	GND

WCDMA BAND V Laptop+AE2#+AE3#

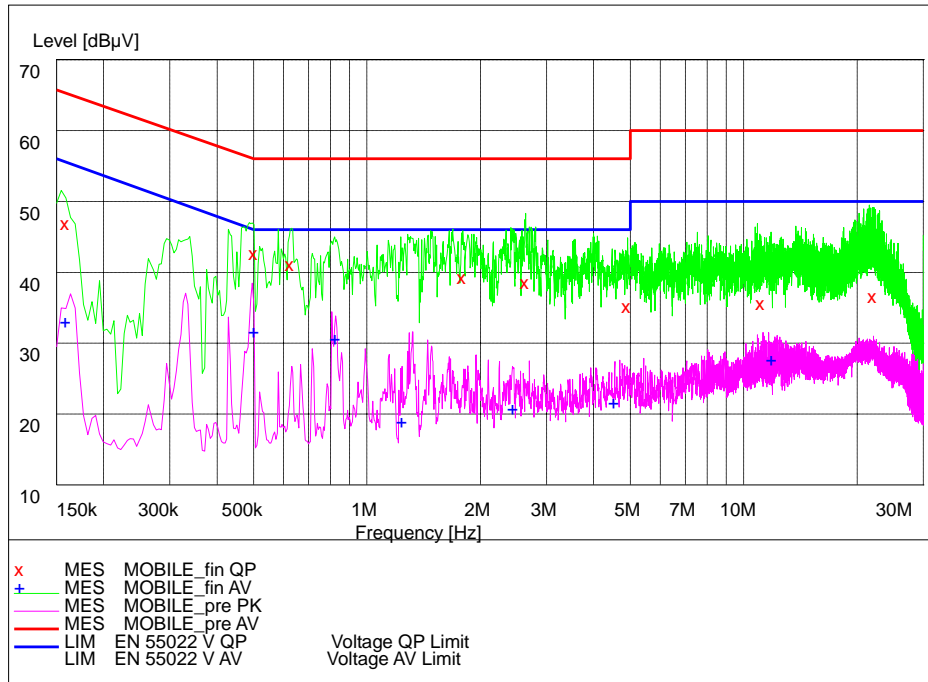

L and N Line

MEASUREMENT RESULT: "MOBILE_fin QP"

Frequency MHz	Level dBμV	Transd	Limit dB	Margin dBμV	Line	PE
0.159000	48.60	20.1	65	16.7	L1	GND
0.501000	44.30	20.3	56	11.7	L1	GND
0.627000	42.80	20.3	56	13.2	L1	GND
1.797000	41.00	20.2	56	15.0	N	GND
2.634000	40.20	20.3	56	15.8	L1	GND
4.902000	36.80	20.4	56	19.2	L1	GND

MEASUREMENT RESULT: "MOBILE_fin AV"

Frequency MHz	Level dBμV	Transd	Limit dB	Margin dBμV	Line	PE
0.159000	34.70	20.1	56	20.9	L1	GND
0.501000	33.40	20.3	46	12.6	L1	GND
0.825000	32.40	20.3	46	13.6	N	GND
2.445000	22.40	20.3	46	23.6	L1	GND
4.524000	23.30	20.4	46	22.7	L1	GND
11.904000	29.40	20.7	50	20.6	L1	GND

FM Radio Laptop+AE2#+AE3#

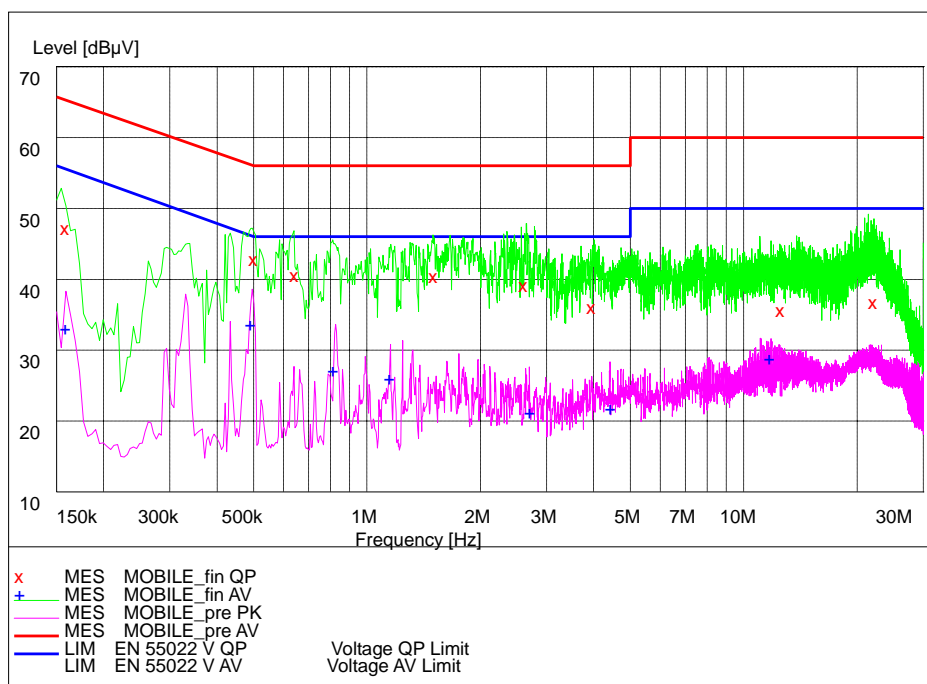

L and N Line

MEASUREMENT RESULT: "MOBILE_fin QP"

Frequency MHz	Level dBμV	Transd	Limit dB	Margin dBμV	Line	PE
0.159000	48.80	20.1	65	16.5	L1	GND
0.501000	44.40	20.3	56	11.6	L1	GND
0.645000	42.30	20.3	56	13.7	N	GND
1.509000	42.10	20.2	56	13.9	L1	GND
2.616000	40.80	20.3	56	15.2	L1	GND
3.966000	37.70	20.3	56	18.3	L1	GND

MEASUREMENT RESULT: "MOBILE_fin AV"

Frequency MHz	Level dBμV	Transd	Limit dB	Margin dBμV	Line	PE
0.159000	34.70	20.1	56	20.8	L1	GND
0.492000	35.30	20.3	46	10.8	N	GND
0.816000	28.80	20.3	46	17.2	L1	GND
1.149000	27.60	20.2	46	18.4	N	GND
4.443000	23.40	20.4	46	22.6	L1	GND
11.715000	30.50	20.7	50	19.5	N	GND

MP3/MP4 Laptop+AE2#+AE3#

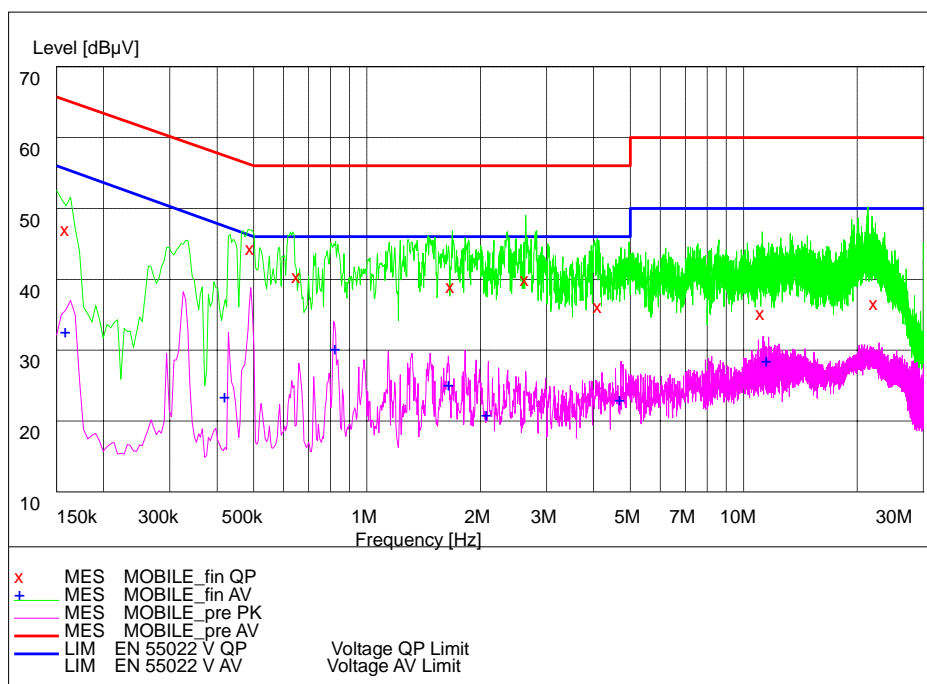

L and N Line

MEASUREMENT RESULT: "MOBILE_fin QP"

Frequency MHz	Level dBμV	Transd	Limit dB	Margin dBμV	Line	PE
0.159000	48.70	20.1	65	16.5	L1	GND
0.492000	46.00	20.3	56	10.2	L1	GND
0.654000	42.10	20.3	56	13.9	N	GND
1.671000	40.60	20.2	56	15.4	L1	GND
2.634000	41.70	20.3	56	14.3	L1	GND
4.119000	37.90	20.4	56	18.1	N	GND

MEASUREMENT RESULT: "MOBILE_fin AV"

Frequency MHz	Level dBμV	Transd	Limit dB	Margin dBμV	Line	PE
0.159000	34.30	20.1	56	21.2	N	GND
0.420000	25.10	20.3	47	22.3	N	GND
0.825000	31.90	20.3	46	14.1	L1	GND
1.653000	26.80	20.2	46	19.2	L1	GND
4.704000	24.70	20.4	46	21.3	L1	GND
11.526000	30.20	20.7	50	19.8	L1	GND

Camera Laptop+AE2#+AE3#

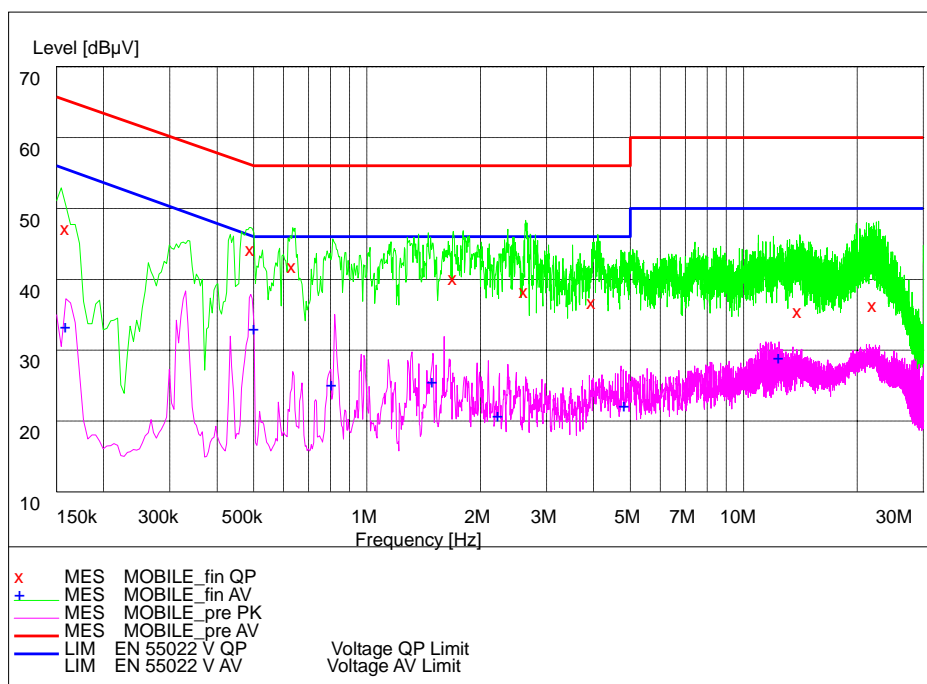

L and N Line

MEASUREMENT RESULT: "MOBILE_fin QP"

Frequency MHz	Level dBμV	Transd	Limit dB	Margin dBμV	Line	PE
0.159000	48.90	20.1	65	16.3	L1	GND
0.492000	45.80	20.3	56	10.3	N	GND
0.636000	43.40	20.3	56	12.6	L1	GND
1.698000	41.80	20.2	56	14.2	L1	GND
2.625000	39.90	20.3	56	16.1	L1	GND
3.966000	38.30	20.3	56	17.7	L1	GND

MEASUREMENT RESULT: "MOBILE_fin AV"

Frequency MHz	Level dBμV	Transd	Limit dB	Margin dBμV	Line	PE
0.159000	35.00	20.1	56	20.5	L1	GND
0.501000	34.70	20.3	46	11.3	L1	GND
0.807000	26.80	20.3	46	19.2	L1	GND
1.491000	27.30	20.2	46	18.7	N	GND
4.821000	23.90	20.4	46	22.1	L1	GND
12.399000	30.60	20.7	50	19.4	L1	GND

2.2.2 Radiated Emissions-FCC Part15.109

Ambient condition:

Temperature	Relative humidity	Pressure
24.2°C	43.5%	100.9kPa

Test Setup:

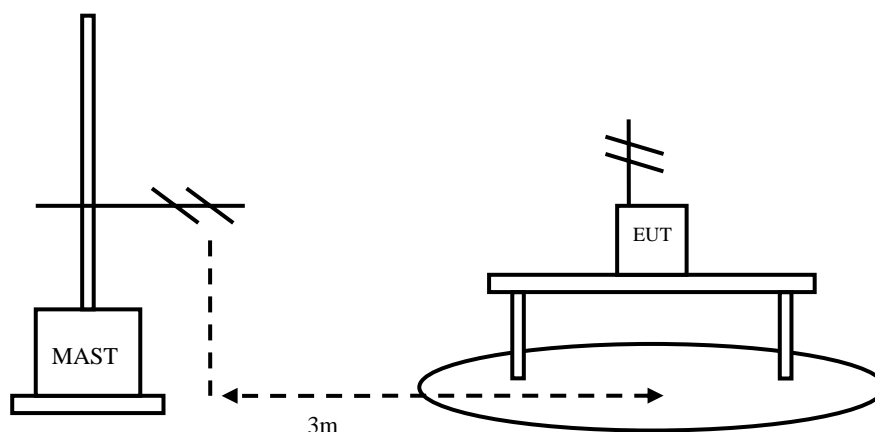

Figure 2

Test Procedure:

The EUT should be placed on a non-metallic table 80cm above the ground plane. The receive antennas shall be moved from 1 to 4 meters. The distance between EUT and receive antenna should be 3 meters.

The EUT should work in idle mode. The accessories of the EUT are connected with the EUT such as headset etc. The test set-up and the test methods are performed according to ANSI C63.4:2009.

Then start the test software ES-K1. Sweep the whole frequency band through the range from 30MHz to 1GHz, using receive log period antenna HL562.

During the test, the height of receive antenna shall be moved from 1 to 4 meters, and the antenna shall be performed under horizontal and vertical polarization. The turn table shall be rotated from 0 to 360 degrees for detecting the maximum of radiated spurious signal level. The measurements shall be repeated with orthogonal polarization of the test antenna. The EUT is laid in two modes as follow:
1. put the EUT in horizontal direction; 2. put the EUT in vertical direction.

The data of cable loss and antenna factor have been calibrated in full testing frequency range before the testing.

A “reference path loss” is established and the A_{Rpl} is the attenuation of “reference path loss”, and including the gain of receive antenna, the gain of the preamplifier, the cable loss.

The measurement results are obtained as described below:

$$\text{Result} = P_{\text{mea}} + A_{Rpl}$$

Limit:

Frequency of Emission(MHz)	Limits	
	Detector	Unit (dB μ V/m)
30~88	Quasi-peak	40
88~216	Quasi-peak	43.5
216~960	Quasi-peak	46
960~1000	Quasi-peak	54
1000~5th harmonic of the highest frequency or 40GHz, whichever is lower	Average	54
	Peak	74

Test result:

GSM850 Mode

Frequency(MHz)	Result(dBuV/m)	A_{Rpl} (dB)	P_{mea} (dBuV/m)	Polarity
30.00	33.18	15.20	17.98	Vertical
92.28	27.58	8.40	19.18	Vertical
138.48	29.15	8.10	21.05	Horizontal
269.94	33.03	10.90	22.13	Vertical
625.25	36.27	19.60	16.67	Vertical
675.35	34.71	20.50	14.21	Vertical

PCS1900 Mode

Frequency(MHz)	Result(dBuV/m)	A_{Rpl} (dB)	P_{mea} (dBuV/m)	Polarity
30.00	31.39	15.20	16.19	Vertical
137.68	29.63	8.10	21.53	Horizontal
184.17	27.83	7.90	19.93	Vertical
269.94	33.76	10.90	22.86	Vertical
625.25	36.45	19.60	16.85	Vertical
675.35	35.47	20.50	14.97	Vertical

WCDMA Band II Mode

Frequency(MHz)	Result(dBuV/m)	A _{Rpl} (dB)	P _{mea} (dBuV/m)	Polarity
30.00	32.51	15.20	17.31	Vertical
137.68	29.51	8.10	21.41	Vertical
184.97	27.47	7.90	19.57	Vertical
269.94	34.35	10.90	23.45	Vertical
625.25	35.87	19.60	16.27	Vertical
675.35	35.16	20.50	14.66	Vertical

WCDMA Band V Mode

Frequency(MHz)	Result(dBuV/m)	A _{Rpl} (dB)	P _{mea} (dBuV/m)	Polarity
30.00	32.30	15.20	17.10	Vertical
138.48	29.09	8.10	20.99	Horizontal
184.17	28.01	7.90	20.11	Vertical
269.94	32.90	10.90	22.00	Vertical
625.25	36.10	19.60	16.50	Vertical
675.35	34.33	20.50	13.83	Vertical

FM Radio Mode

Frequency(MHz)	Result(dBuV/m)	A _{Rpl} (dB)	P _{mea} (dBuV/m)	Polarity
30.00	33.08	15.20	17.88	Vertical
138.48	29.92	8.10	21.82	Vertical
231.46	30.44	9.50	20.94	Vertical
269.94	33.65	10.90	22.75	Vertical
625.25	35.87	19.60	16.27	Vertical
675.35	35.42	20.50	14.92	Vertical

MP3/MP4 Mode

Frequency(MHz)	Result(dBuV/m)	A _{Rpl} (dB)	P _{mea} (dBuV/m)	Polarity
30.00	34.06	15.20	18.86	Vertical
137.68	30.11	8.10	22.01	Horizontal
184.17	26.82	7.90	18.92	Vertical
269.94	33.77	10.90	22.87	Vertical
625.25	35.86	19.60	16.26	Vertical
675.35	35.16	20.50	14.66	Vertical

Camera Mode

Frequency(MHz)	Result(dBuV/m)	A _{Rpl} (dB)	P _{mea} (dBuV/m)	Polarity
30.00	33.82	15.20	18.62	Vertical
137.68	28.78	8.10	20.68	Horizontal
184.97	28.54	7.90	20.64	Vertical
269.94	33.60	10.90	22.70	Vertical
625.25	35.74	19.60	16.14	Vertical
675.35	35.11	20.50	14.61	Vertical

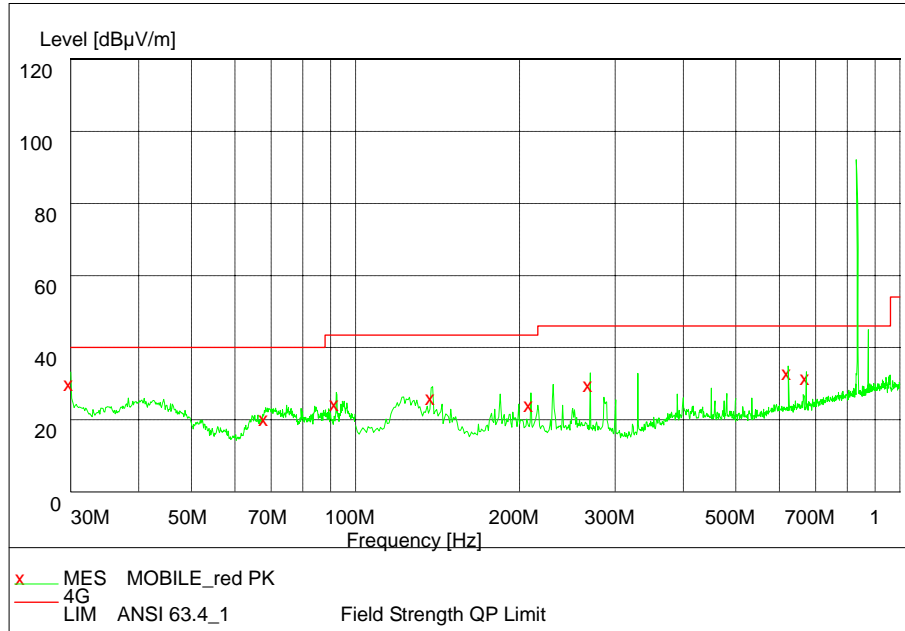

GSM850 (30MHz – 1GHz)

Note: The signal beyond the limit is the base station simulator carrier.

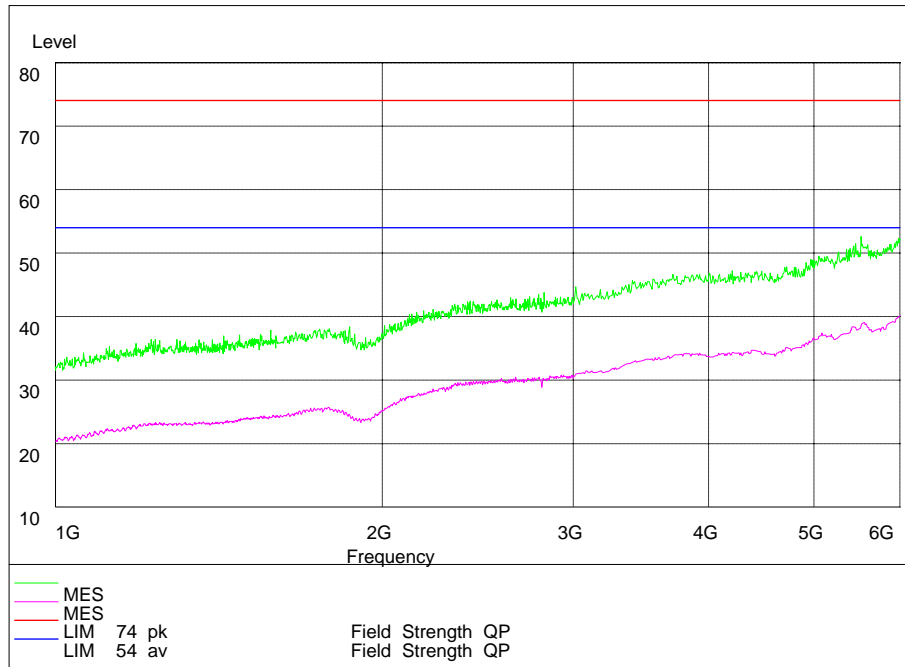

GSM850 (1GHz – 6GHz)

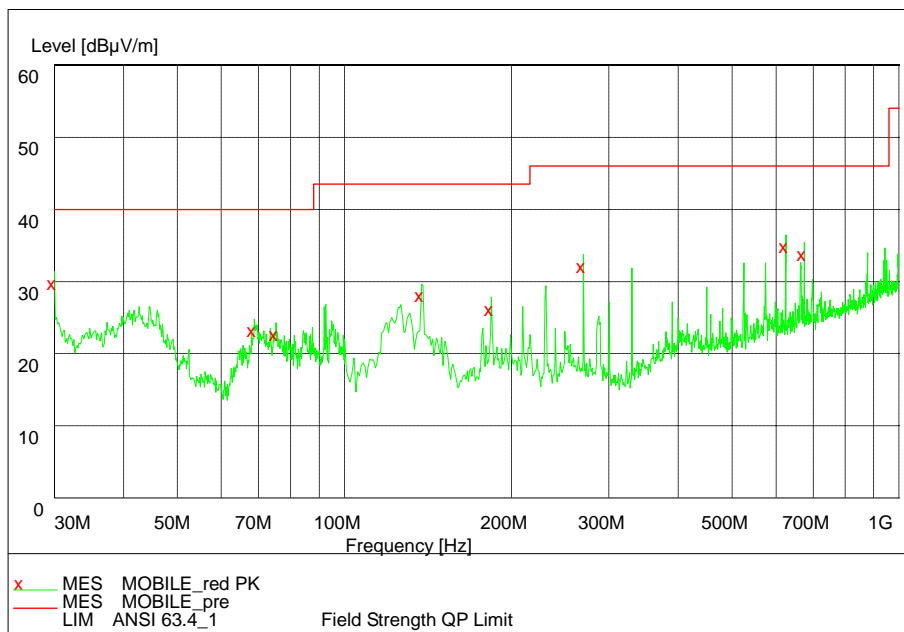

PCS1900 (30MHz – 1GHz)

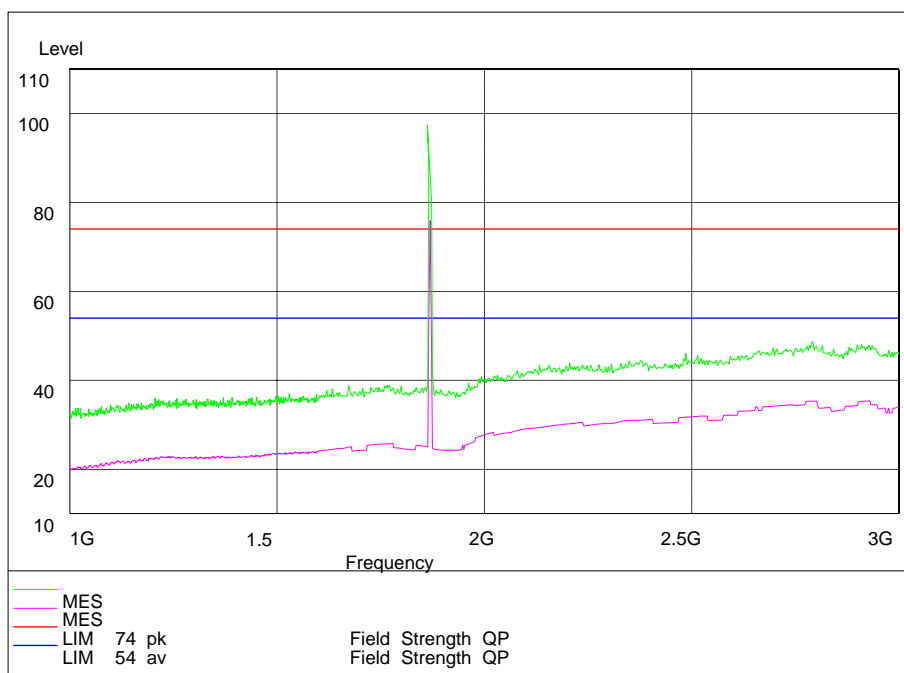

PCS1900 (1GHz – 3GHz)

Note: The signals beyond the limit are the base station and simulator carrier.

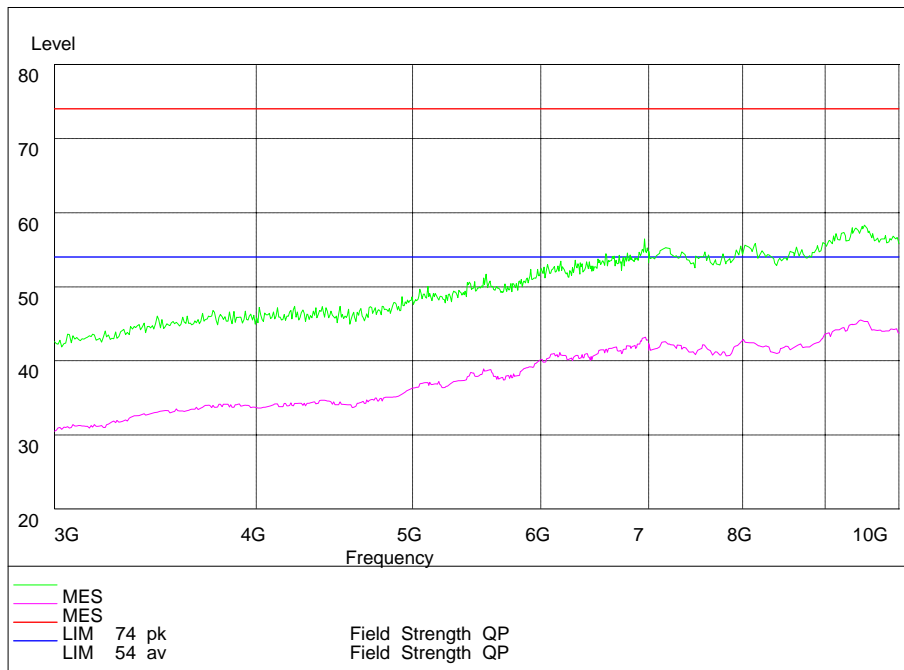

PCS1900 (3GHz – 10GHz)

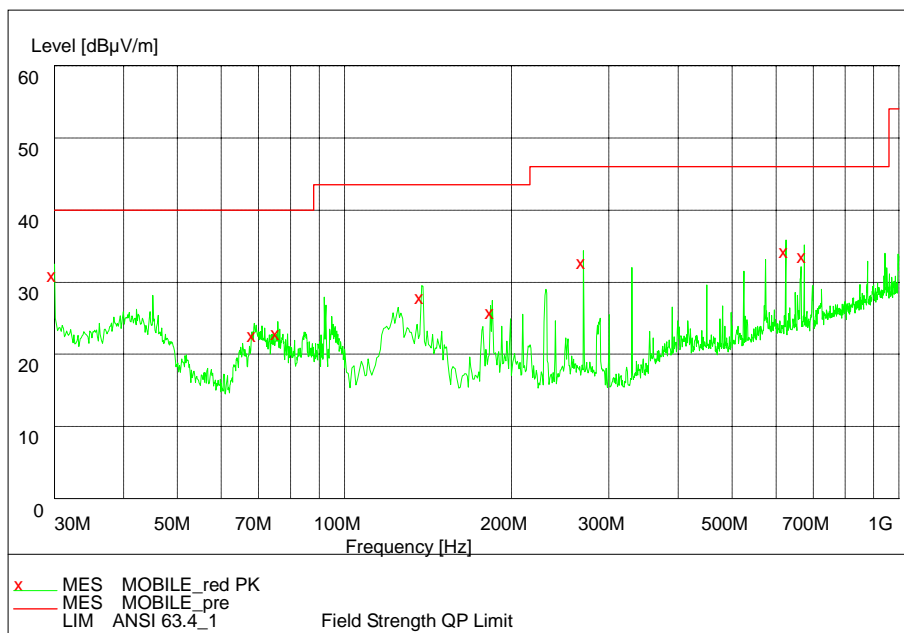

WCDMA BAND II (30MHz – 1GHz)

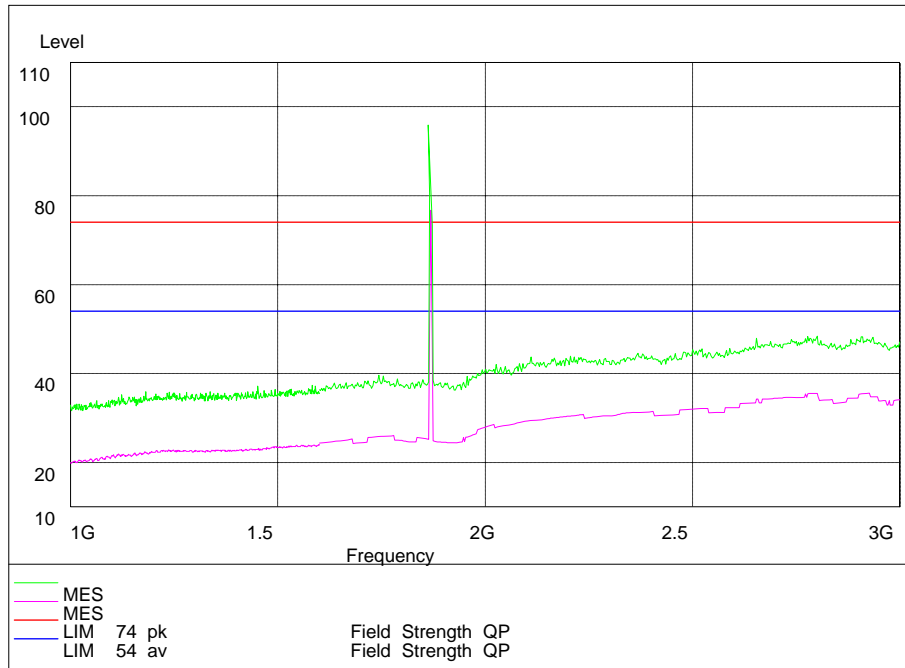

WCDMA BAND II (1GHz – 3GHz)

Note: The signal beyond the limit is the base station simulator carrier.

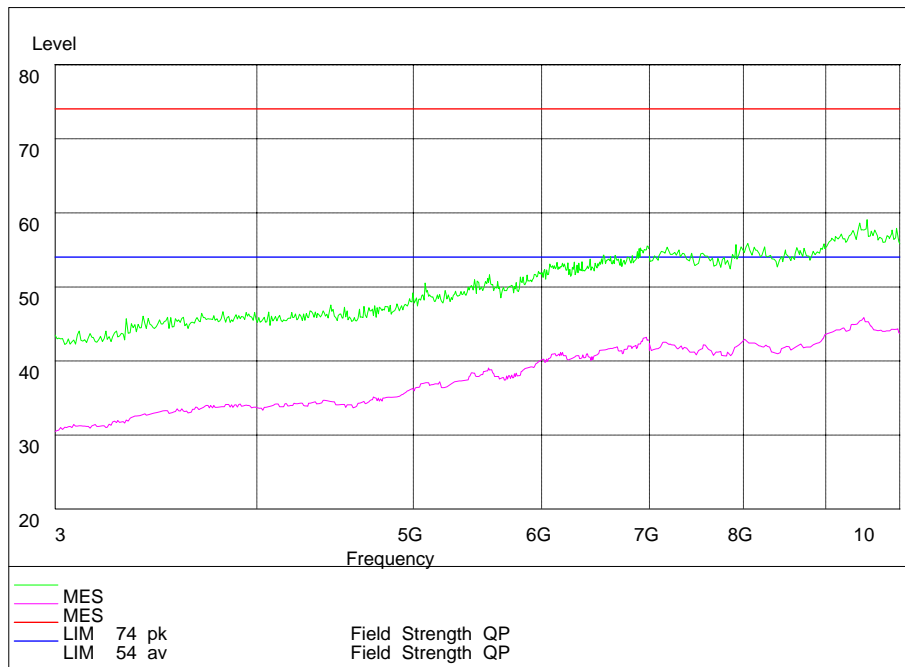

WCDMA BAND II (3GHz – 10GHz)

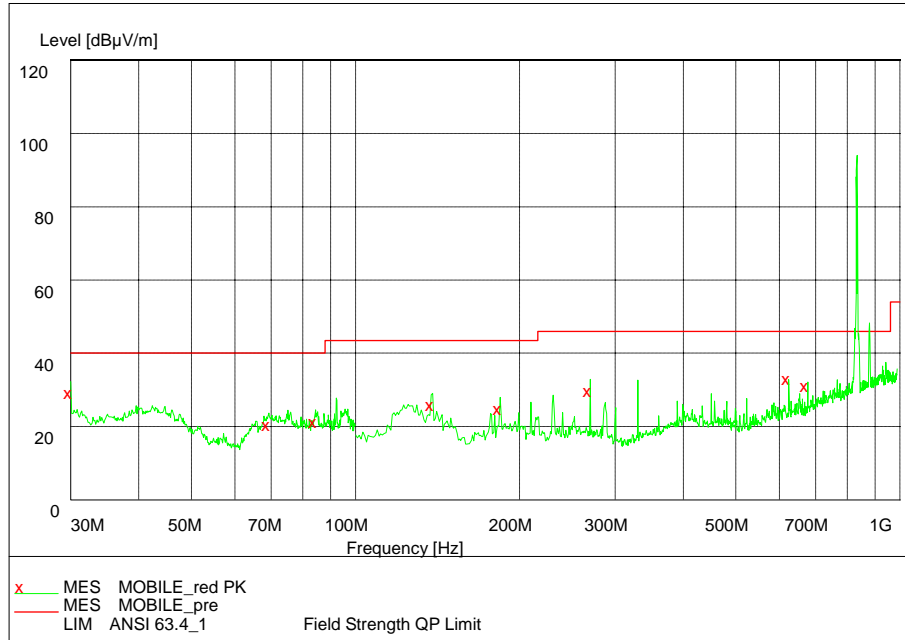

WCDMA BAND V (30MHz – 1GHz)

Note: The signals beyond the limit are the base station and simulator carrier.

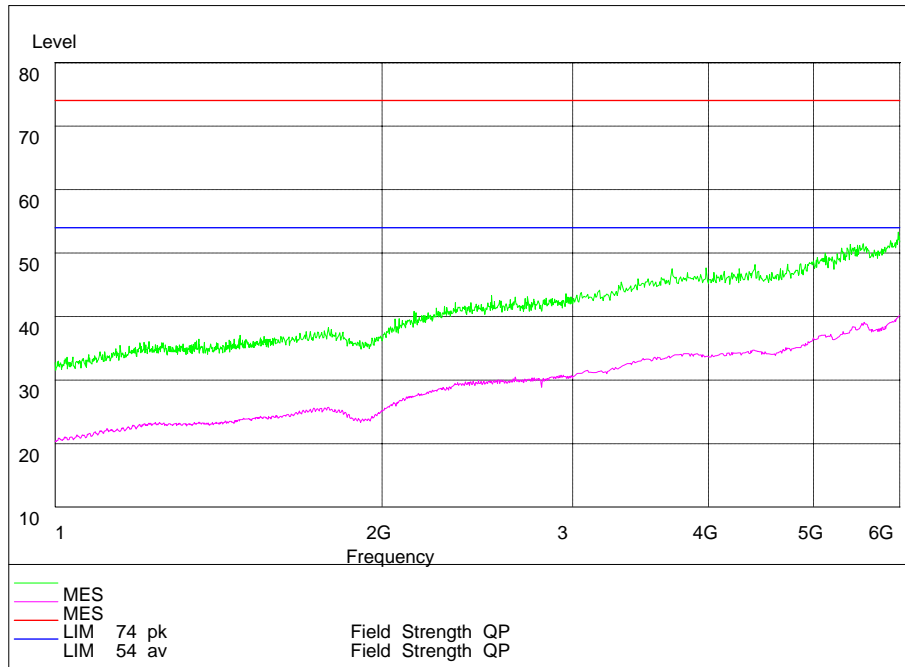

WCDMA BAND V (1GHz – 6GHz)

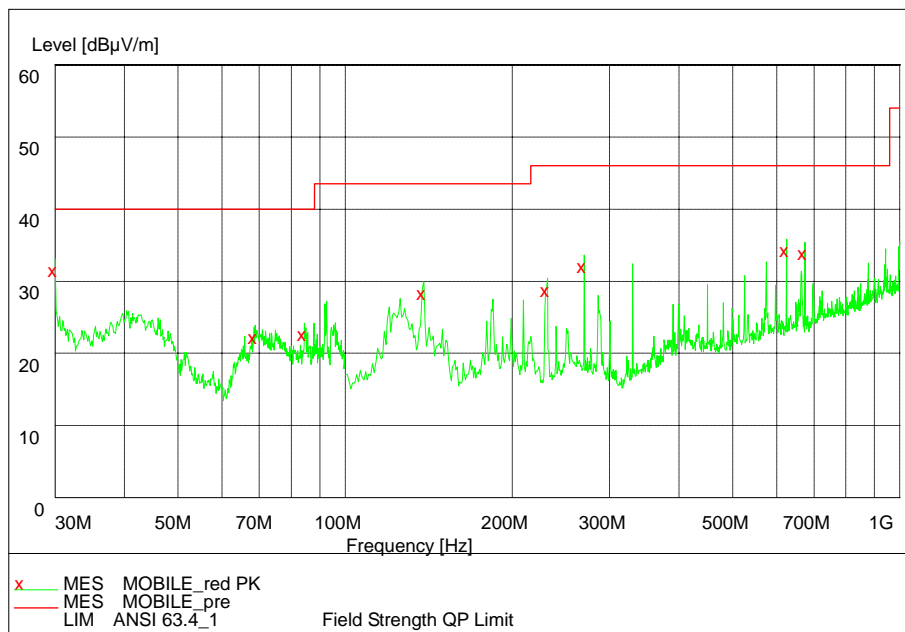

FM Radio (30MHz – 1GHz)

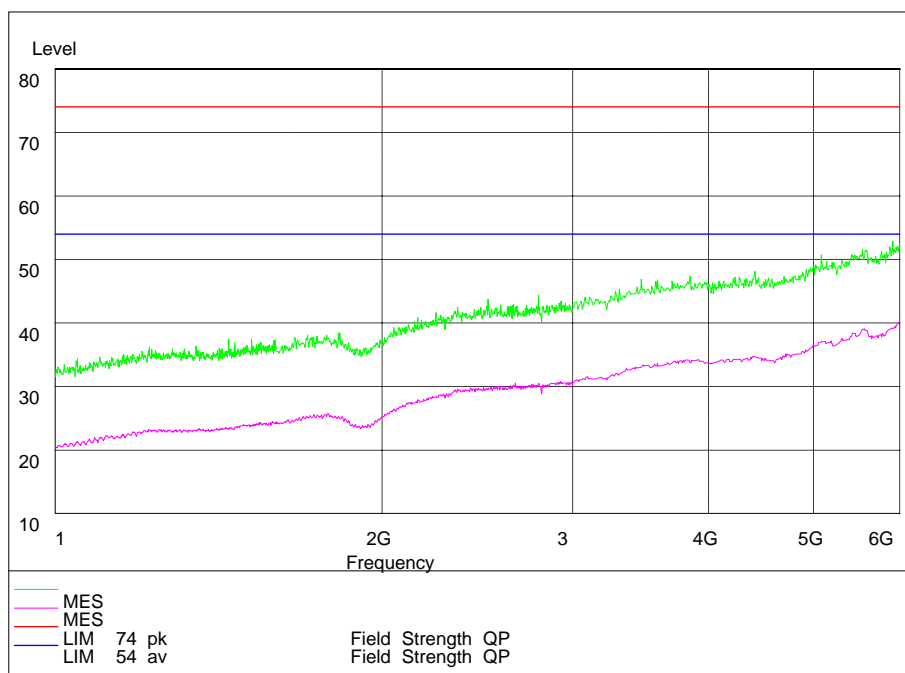

FM Radio (1GHz – 6GHz)

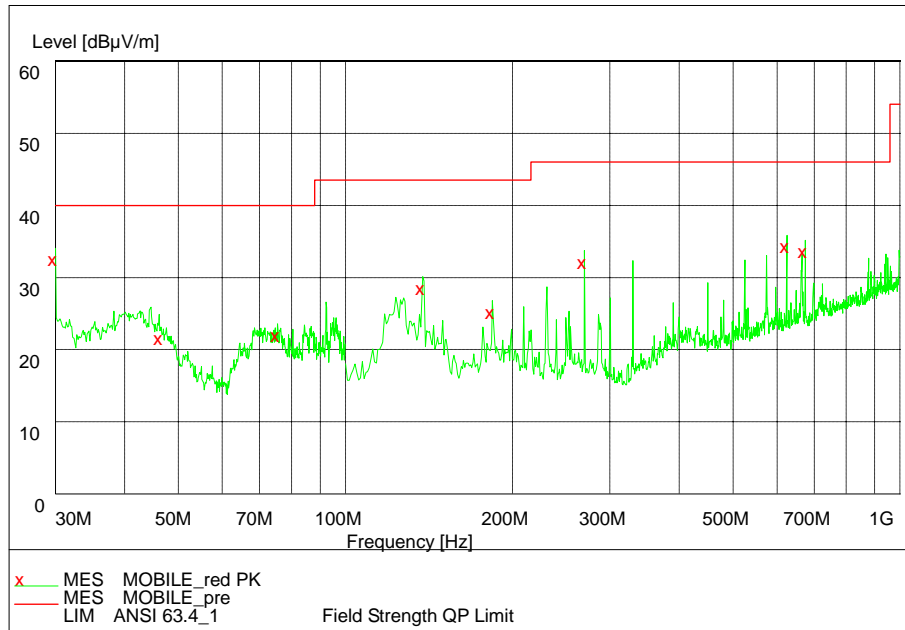

MP3/MP4 (30MHz – 1GHz)

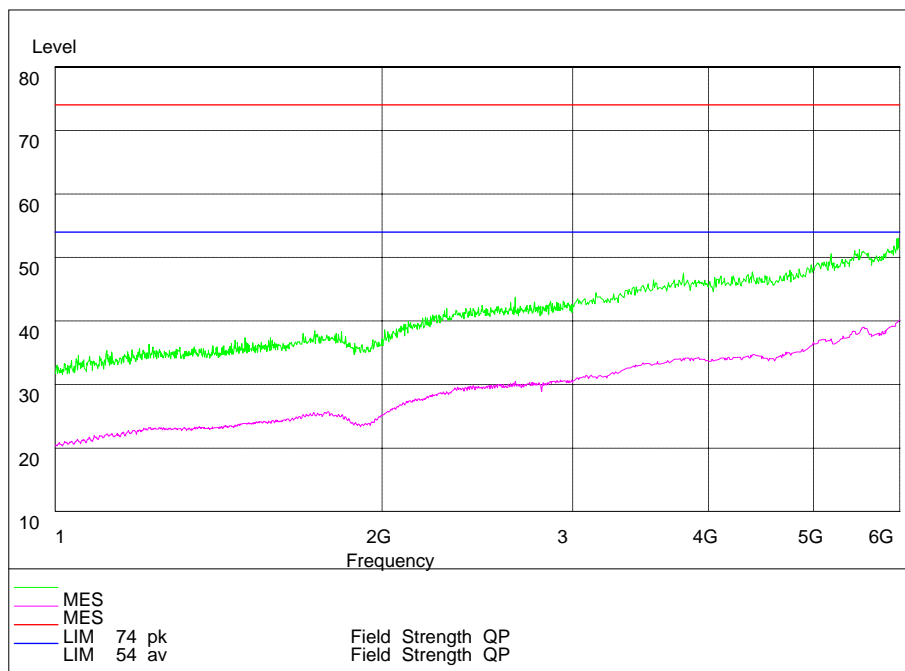

MP3/MP4 (1GHz – 6GHz)

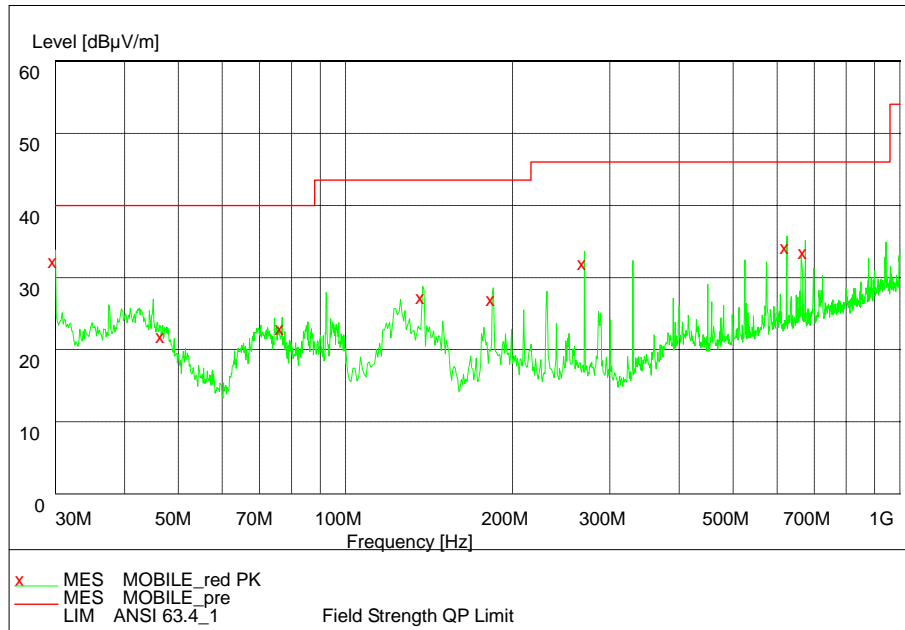

Camera (30MHz – 1GHz)

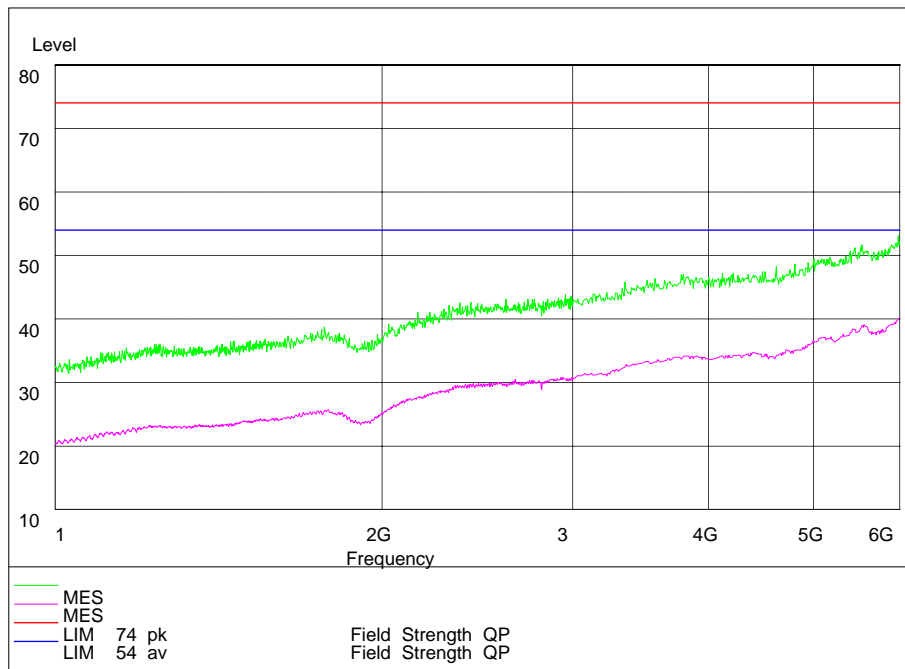

Camera (1GHz – 6GHz)

2.3. List of test equipments

No.	Name/Model	Manufacturer	S/N	Calibration Due Date
1	23.18m×16.88m×9.60m Semi-Anechoic Chamber	FRANKONIA	-----	19 th Aug. 2014
2	ESI 40 EMI test receiver	R&S	100015	19 th Aug. 2014
3	E5515C(8960) Mobile Station Tester	Agilent	GB44050904	19 th Aug. 2014
4	9.080m×5.255m×3.525m Shielding room	FRANKONIA	-----	19 th Aug. 2014
5	ESCS30 EMI test receiver	R&S	100029	19 th Aug. 2014
6	HL562 Ultra log test antenna	R&S	100016	19 th Aug. 2014
7	ESH3-Z2 Pulse limiter	R&S	10002	19 th Aug. 2014
8	ESH3-Z5 Attenuator	R&S	100020	19 th Aug. 2014
9	ESH2Z11 LISN	R&S	50FH-020-10	19 th Aug. 2014
10	HF 906 Double-Ridged Waveguide Horn Antenna	R&S	100030	19 th Aug. 2014
11	HF 906 Double-Ridged Waveguide Horn Antenna	R&S	100029	19 th Aug. 2014
12	PS2000 Turn Table	FRANKONIA	-----	19 th Aug. 2014
13	MA260 Antenna Master	FRANKONIA	-----	19 th Aug. 2014
14	ES-K1EMI test software	R&S	-----	19 th Aug. 2014
15	HL562 Receive antenna	R&S	100167	19 th Aug. 2014

Appendix

Appendix1 Test Setup