



# SAR TEST REPORT

**No.I14N00835-SAR**

**for**

**ShenZhen Sang Fei Consumer Communications Co.,Ltd.**

**GSM dual band mobile phone**

**Philips E130**

**with**

**Hardware Version: A327-MB-V1.0**

**Software Version: E130\_T6531D\_1428\_01\_V01A\_MX**

**FCC ID: VQRCTE130**

**Issued Date: 2014-08-12**

**Note:**

The test results in this test report relate only to the devices specified in this report. This report shall not be reproduced except in full without the written approval of TMC Beijing.

**Test Laboratory:**

TMC Beijing, Telecommunication Metrology Center of MIIT

No. 52, Huayuan Bei Road, Haidian District, Beijing, P. R. China 100191.

Tel:+86(0)10-62304633-2079, Fax:+86(0)10-62304633 Email:welcom@emcite.com. [www.emcite.com](http://www.emcite.com)



### Revision Version

<b>Report Number</b>	<b>Revision</b>	<b>Date</b>	<b>Memo</b>
I14N00635-SAR	00	2014-08-12	Initial creation of test report

## TABLE OF CONTENT

<b>1 TEST LABORATORY .....</b>	<b>5</b>
1.1 TESTING LOCATION .....	5
1.2 TESTING ENVIRONMENT.....	5
1.3 PROJECT DATA .....	5
1.4 SIGNATURE.....	5
<b>2 STATEMENT OF COMPLIANCE .....</b>	<b>6</b>
<b>3 CLIENT INFORMATION .....</b>	<b>7</b>
3.1 APPLICANT INFORMATION .....	7
3.2 MANUFACTURER INFORMATION .....	7
<b>4 EQUIPMENT UNDER TEST (EUT) AND ANCILLARY EQUIPMENT (AE) .....</b>	<b>8</b>
4.1 ABOUT EUT .....	8
4.2 INTERNAL IDENTIFICATION OF EUT USED DURING THE TEST .....	8
4.3 INTERNAL IDENTIFICATION OF AE USED DURING THE TEST .....	8
<b>5 TEST METHODOLOGY .....</b>	<b>9</b>
5.1 APPLICABLE LIMIT REGULATIONS .....	9
5.2 APPLICABLE MEASUREMENT STANDARDS.....	9
<b>6 SPECIFIC ABSORPTION RATE (SAR).....</b>	<b>10</b>
6.1 INTRODUCTION.....	10
6.2 SAR DEFINITION.....	10
<b>7 TISSUE SIMULATING LIQUIDS .....</b>	<b>11</b>
7.1 TARGETS FOR TISSUE SIMULATING LIQUID .....	11
7.2 DIELECTRIC PERFORMANCE .....	11
<b>8 SYSTEM VERIFICATION .....</b>	<b>14</b>
8.1 SYSTEM SETUP.....	14
8.2 SYSTEM VERIFICATION.....	15
8.3 JUSTIFICATION FOR EXTENDED SAR DIPOLE CALIBRATIONS .....	15
<b>9 MEASUREMENT PROCEDURES .....</b>	<b>16</b>
9.1 TESTS TO BE PERFORMED .....	16
9.2 GENERAL MEASUREMENT PROCEDURE.....	17
9.3 BLUETOOTH MEASUREMENT PROCEDURES FOR SAR .....	18
9.4 POWER DRIFT.....	19
<b>10 CONDUCTED OUTPUT POWER.....</b>	<b>19</b>
10.1 MANUFACTURING TOLERANCE .....	19
10.2 GSM MEASUREMENT RESULT .....	20
. 10.4 BT MEASUREMENT RESULT .....	21
<b>11 SIMULTANEOUS TX SAR CONSIDERATIONS.....</b>	<b>22</b>

11.1 INTRODUCTION.....	22
11.2 TRANSMIT ANTENNA SEPARATION DISTANCES .....	22
11.3 STANDALONE SAR TEST EXCLUSION CONSIDERATIONS .....	23
<b>12 EVALUATION OF SIMULTANEOUS.....</b>	<b>23</b>
<b>13 SAR TEST RESULT .....</b>	<b>25</b>
13.1 SAR TEST RESULT .....	25
<b>14 SAR MEASUREMENT VARIABILITY.....</b>	<b>27</b>
<b>15 MEASUREMENT UNCERTAINTY .....</b>	<b>28</b>
15.1 MEASUREMENT UNCERTAINTY FOR NORMAL SAR TESTS (300MHZ-3000MHZ) .....	28
<b>16 MAIN TEST INSTRUMENTS.....</b>	<b>29</b>
<b>ANNEX A GRAPH RESULTS.....</b>	<b>30</b>
<b>ANNEX B SYSTEM VERIFICATION RESULTS .....</b>	<b>62</b>
<b>ANNEX C SAR MEASUREMENT SETUP .....</b>	<b>66</b>
C.1 MEASUREMENT SET-UP .....	66
C.2 DASY4 OR DASY5 E-FIELD PROBE SYSTEM .....	67
C.3 E-FIELD PROBE CALIBRATION .....	67
C.4 OTHER TEST EQUIPMENT.....	68
C.4.1 DATA ACQUISITION ELECTRONICS(DAE) .....	68
C.4.2 ROBOT.....	69
C.4.3 MEASUREMENT SERVER.....	69
C.4.4 DEVICE HOLDER FOR PHANTOM.....	70
C.4.5 PHANTOM.....	70
<b>ANNEX D POSITION OF THE WIRELESS DEVICE IN RELATION TO THE PHANTOM .....</b>	<b>72</b>
D.1 GENERAL CONSIDERATIONS .....	72
D.2 BODY-WORN DEVICE .....	73
D.3 DESKBOTTOM DEVICE .....	73
D.4 DUT SETUP PHOTOS.....	74
<b>ANNEX E EQUIVALENT MEDIA RECIPES.....</b>	<b>75</b>
<b>ANNEX F SYSTEM VALIDATION.....</b>	<b>76</b>
<b>ANNEX H DIPOLE CALIBRATION CERTIFICATE .....</b>	<b>90</b>
<b>ANNEX E ACCREDITATION CERTIFICATE .....</b>	<b>106</b>

## 1 Test Laboratory

### 1.1 Testing Location

Company Name: TMC Shenzhen, Telecommunication Metrology Center of MIIT  
Address: No. 12building, Shangsha Innovation and Technology Park, Futian District, Shenzhen, P. R. China  
Postal Code: 518048  
Telephone: +86-755-33322000  
Fax: +86-755-33322001

### 1.2 Testing Environment

Temperature: 18°C~25 °C,  
Relative humidity: 30%~ 70%  
Ground system resistance: < 0.5 Ω  
Ambient noise & Reflection: < 0.012 W/kg

### 1.3 Project Data

Project Leader: Zhang Bojun  
Test Engineer: Cao Junfei  
Testing Start Date: August 6<sup>th</sup>, 2014  
Testing End Date: August 8<sup>th</sup>, 2014

### 1.4 Signature

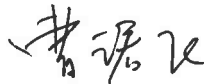

---

Cao Junfei

(Prepared this test report)



---

Zhang Bojun

(Reviewed this test report)



---

Lu Minniu

Director of the laboratory  
(Approved this test report)

## 2 Statement of Compliance

The maximum results of Specific Absorption Rate (SAR) found during testing for ShenZhen Sang Fei Consumer Communications Co.,Ltd. GSM dual band mobile phone Philips E130 are as follows:

**Table 2.1: Max. Reported SAR (1g)**

Band	Configuration	Position	Reported SAR 1g (W/Kg)
GSM 850	Head	Right、 Touch	<b>1.391</b>
	Body	Rear Side	1.346
GSM 1900	Head	Right、 Touch	0.439
	Body	Rear Side	0.839

All the tests are carried out with a fully charged battery.

The SAR values found for the Mobile Phone are below the maximum recommended levels of 1.6 W/Kg as averaged over any 1g tissue according to the ANSI C95.1-1999.

For body worn operation, this device has been tested and meets FCC RF exposure guidelines when used with any accessory that contains no metal and which provides a minimum separation distance of 10 mm between this device and the body of the user. Use of other accessories may not ensure compliance with FCC RF exposure guidelines.

It is determined by user manual for the distance between the EUT and the phantom bottom.

The distance is 10mm and just applied to the condition of body worn accessory

The measurement together with the test system set-up is described in annex C of this test report. A detailed description of the equipment under test can be found in chapter 4 of this test report.

The maximum reported SAR value is obtained at the case of **(Table 2.1)**, and the values are: **1.391W/kg (1g)**.

**Table 2.2: The sum of reported SAR values**

	Position	GSM	BT	Sum
<b>Maximum reported SAR value for Head</b>	Right hand, Touch	1.391	0.058	<b>1.449</b>
<b>Maximum reported SAR value for Body</b>	Rear Side	1.346	0.029	<b>1.375</b>

According to the above table, the maximum sum of reported SAR values for GSM and BT is **1.449W/kg (1g)**. The detail for simultaneous transmission consideration is described in chapter 13

### 3 Client Information

#### 3.1 Applicant Information

Company Name:	ShenZhen Sang Fei Consumer Communications Co.,Ltd.
Address /Post:	11 Science and Technology Road, Shenzhen Hi-tech industrial Park Nanshan District, Shenzhen 518057,PRC
City:	Shenzhen
Postal Code:	518057
Country:	PRC
Contact:	Helen Lin
Email:	Helen.Lin@sangfei.com
Telephone:	0755-26633217
Fax:	0755-26635272

#### 3.2 Manufacturer Information

Company Name:	ShenZhen Sang Fei Consumer Communications Co.,Ltd.
Address /Post:	11 Science and Technology Road, Shenzhen Hi-tech industrial Park Nanshan District, Shenzhen 518057,PRC
City:	Shenzhen
Postal Code:	518057
Country:	PRC
Contact:	Helen Lin
Email:	Helen.Lin@sangfei.com
Telephone:	0755-26633217
Fax:	0755-26635272

## 4 Equipment Under Test (EUT) and Ancillary Equipment (AE)

### 4.1 About EUT

Description:	GSM dual band mobile phone
Model name:	Philips E130
Marketing name:	Philips E130
Operating mode(s):	GSM 850/1900, BT
Tested Tx Frequency:	824.2 – 848.8 MHz (GSM 850)
	1850.2 – 1909.8 MHz (GSM 1900)
Test Modulation	(GSM)GMSK
GPRS class	12
GPRS capability Class:	B
EGPRS Multislot Class:	/
Power class:	GSM850: tested with power level 5
	GSM1900: tested with power level 0
Test device Production information:	Production unit
Device type:	Portable device
Antenna type:	Integrated antenna
Accessories/Body-worn configurations:	/
Hotspot mode:	/
Form factor:	10.6cm × 4.4cm

### 4.2 Internal Identification of EUT used during the test

EUT ID*	SN or IMEI	HW Version	SW Version
EUT1	IMEI: 862334026549840	A327-MB-V1.0	E130_T6531D_1428_01_V01A_MX

\*EUT ID: is used to identify the test sample in the lab internally.

### 4.3 Internal Identification of AE used during the test

AE ID*	Description	Model	SN	Manufacturer
AE1	Battery	E130	/	SHENZHEN CYLELONG POWER-TECH Co.,Ltd

\*AE ID: is used to identify the test sample in the lab internally.



## 5 TEST METHODOLOGY

### 5.1 Applicable Limit Regulations

**ANSI C95.1–1999:** IEEE Standard for Safety Levels with Respect to Human Exposure to Radio Frequency Electromagnetic Fields, 3 kHz to 300 GHz.

It specifies the maximum exposure limit of **1.6 W/kg** as averaged over any 1 gram of tissue for portable devices being used within 20 cm of the user in the uncontrolled environment.

### 5.2 Applicable Measurement Standards

**IEEE 1528–2013:** Recommended Practice for Determining the Peak Spatial-Average Specific Absorption Rate (SAR) in the Human Head from Wireless Communications Devices: Measurement Techniques.

**KDB447498 D01: General RF Exposure Guidance v05:** Mobile and Portable Devices RF Exposure Procedures and Equipment Authorization Policies.

**KDB 648474 D04 Handset SAR v01:** SAR Evaluation Considerations for Wireless Handsets.

**865664 D01 SAR measurement 100 MHz to 6 GHz v01:** SAR Measurement Requirements for 100 MHz to 6 GHz

**KDB248227 D01:** SAR Measurement Procedures for 802.11a/b/g transmitters.

**KDB941225 D06:** SAR Evaluation Procedures for Portable Devices with Wireless Router Capabilities.

**865664 D02 SAR Reporting v01:** RF Exposure Compliance Reporting and Documentation Considerations

## 6 Specific Absorption Rate (SAR)

### 6.1 Introduction

SAR is related to the rate at which energy is absorbed per unit mass in an object exposed to a radio field. The SAR distribution in a biological body is complicated and is usually carried out by experimental techniques or numerical modeling. The standard recommends limits for two tiers of groups, occupational/controlled and general population/uncontrolled, based on a person's awareness and ability to exercise control over his or her exposure. In general, occupational/controlled exposure limits are higher than the limits for general population/uncontrolled.

### 6.2 SAR Definition

The SAR definition is the time derivative (rate) of the incremental energy ( $dW$ ) absorbed by (dissipated in) an incremental mass ( $dm$ ) contained in a volume element ( $dv$ ) of a given density ( $\rho$ ). The equation description is as below:

$$SAR = \frac{d}{dt} \left( \frac{dW}{dm} \right) = \frac{d}{dt} \left( \frac{dW}{\rho dv} \right)$$

SAR is expressed in units of Watts per kilogram (W/kg)

SAR measurement can be either related to the temperature elevation in tissue by

$$SAR = c \left( \frac{\delta T}{\delta t} \right)$$

Where:  $C$  is the specific heat capacity,  $\delta T$  is the temperature rise and  $\delta t$  is the exposure duration, or related to the electrical field in the tissue by

$$SAR = \frac{\sigma |E|^2}{\rho}$$

Where:  $\sigma$  is the conductivity of the tissue,  $\rho$  is the mass density of tissue and  $E$  is the RMS electrical field strength.

However for evaluating SAR of low power transmitter, electrical field measurement is typically applied.

## 7 Tissue Simulating Liquids

### 7.1 Targets for tissue simulating liquid

**Table 7.1: Targets for tissue simulating liquid**

Frequency (MHz)	Liquid Type	Conductivity ( $\sigma$ )	$\pm 5\%$ Range	Permittivity ( $\epsilon$ )	$\pm 5\%$ Range
835	Head	0.90	0.86~0.95	41.5	39.4~43.6
835	Body	0.97	0.92~1.02	55.2	52.4~58.0
1900	Head	1.40	1.33~1.47	40.0	38.0~42.0
1900	Body	1.52	1.44~1.60	53.3	50.6~56.0

### 7.2 Dielectric Performance

**Table 7.2: Dielectric Performance of Tissue Simulating Liquid**

Measurement Date (yyyy-mm-dd)	Type	Frequency	Permittivity $\epsilon$	Drift	Conductivity $\sigma$ (S/m)	Drift
2014-08-06	Head	835 MHz	42.13	1.52%	0.88	-2.22%
2014-08-07	Body	835 MHz	55.71	0.92%	0.98	1.03%
2014-08-06	Head	1900 MHz	39.16	-2.10%	1.46	4.29%
2014-08-07	Body	1900 MHz	52.61	-1.29%	1.51	-0.66%

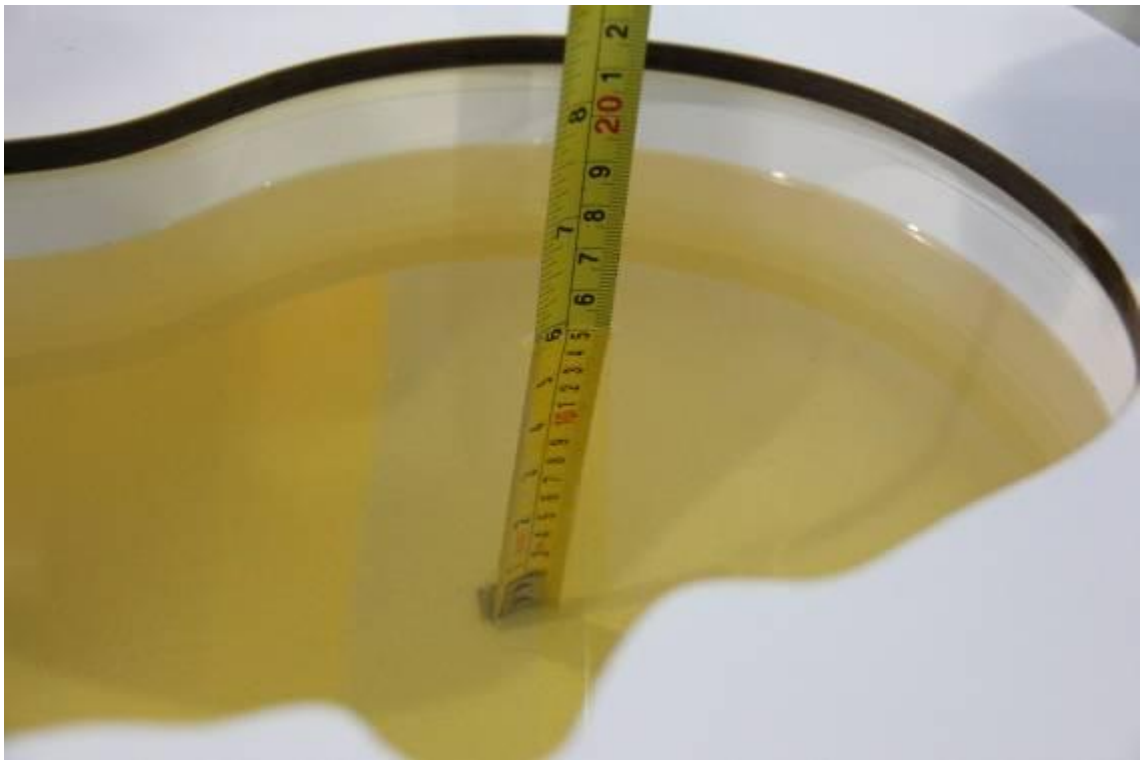

**Picture 7-1: Liquid depth in the Head Phantom (835 MHz) (depth=15.6cm)**



**Picture 7-2: Liquid depth in the Flat Phantom (835 MHz) (depth=17.6cm)**

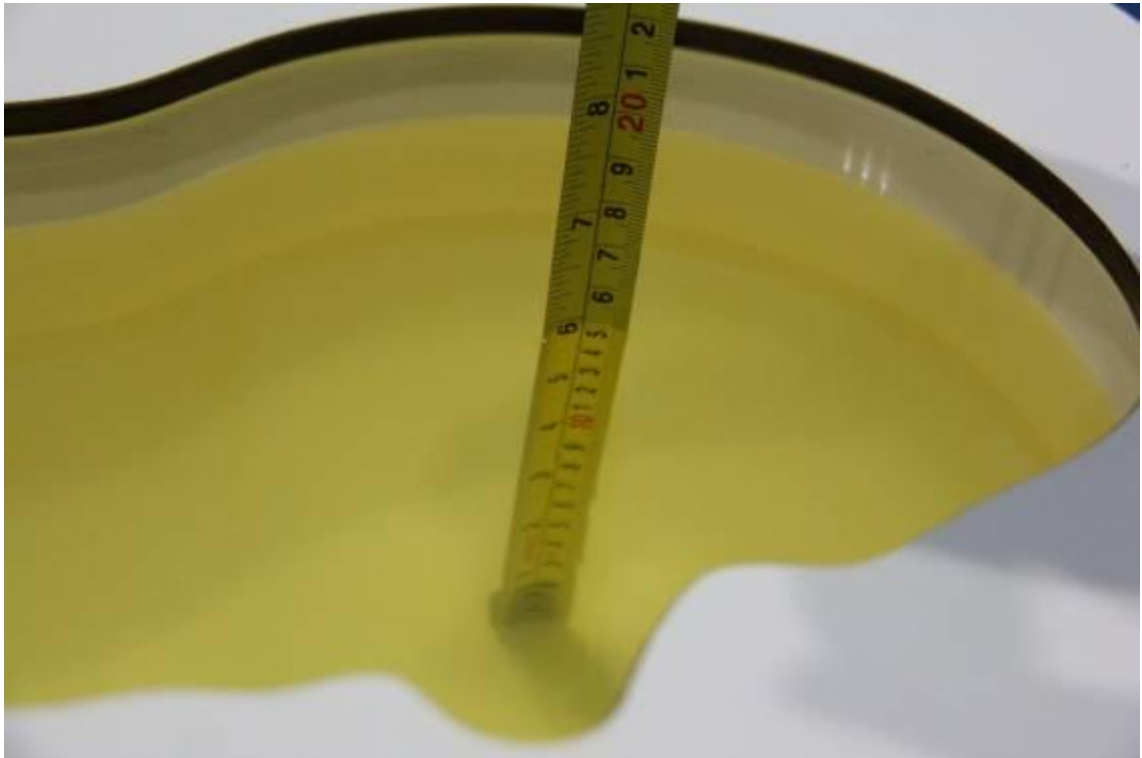

**Picture 7-3: Liquid depth in the Head Phantom (1900 MHz) (depth=15.3cm)**

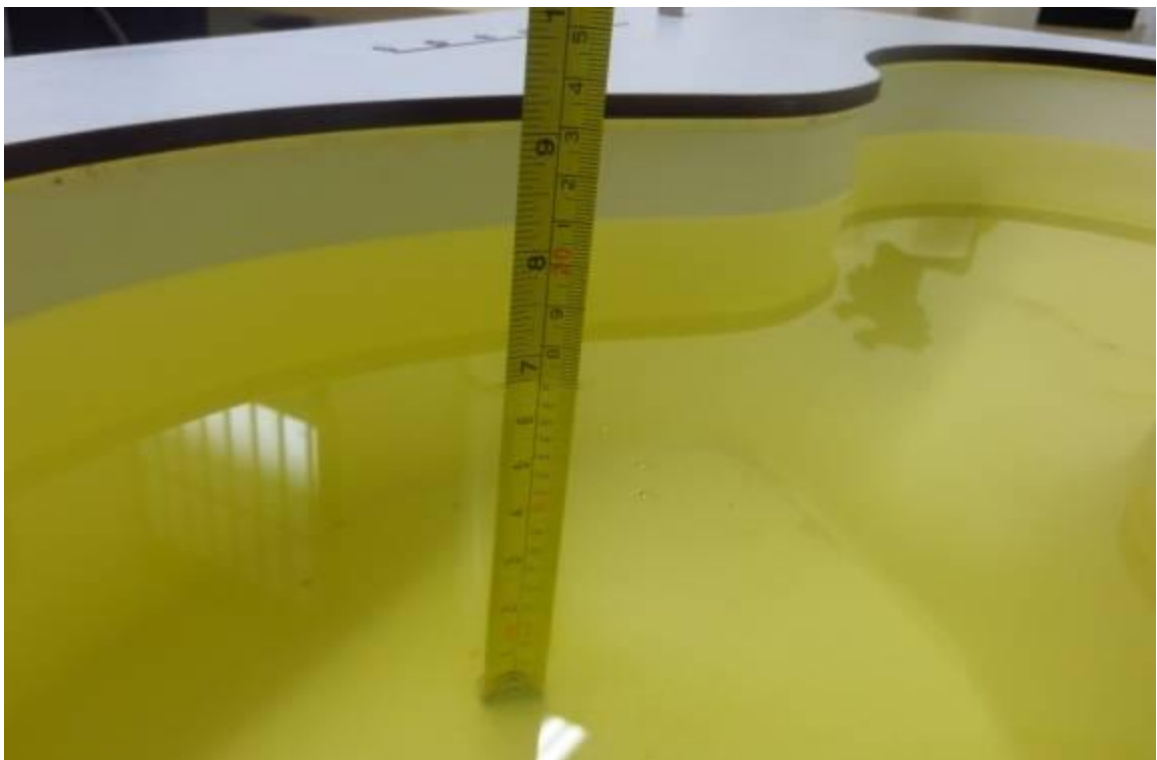

**Picture 7-4 Liquid depth in the Flat Phantom (1900MHz) (depth=17.4cm)**

## 8 System verification

### 8.1 System Setup

In the simplified setup for system evaluation, the DUT is replaced by a calibrated dipole and the power source is replaced by a continuous wave that comes from a signal generator. The calibrated dipole must be placed beneath the flat phantom section of the SAM twin phantom with the correct distance holder. The distance holder should touch the phantom surface with a light pressure at the reference marking and be oriented parallel to the long side of the phantom. The equipment setup is shown below:

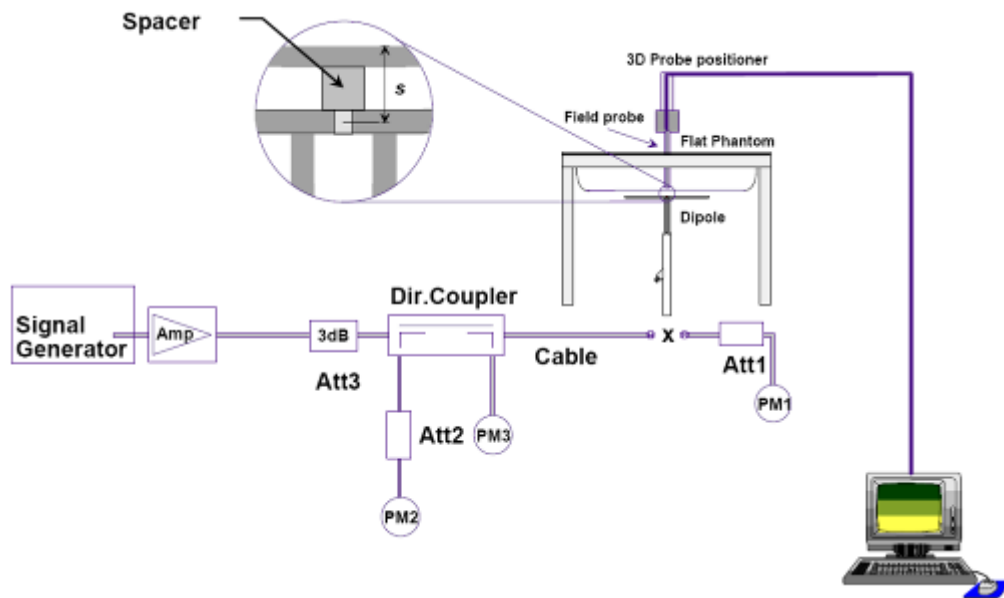

Picture 8.1 System Setup for System Evaluation



Picture 8.2 Photo of Dipole Setup

## 8.2 System Verification

SAR system verification is required to confirm measurement accuracy, according to the tissue dielectric media, probe calibration points and other system operating parameters required for measuring the SAR of a test device. The system verification must be performed for each frequency band and within the valid range of each probe calibration point required for testing the device.

The system verification results are required that the area scan estimated 1-g SAR is within 3% of the zoom scan 1-g SAR. The details are presented in annex B. The measured value of annex B is tested with the output power of 250mW, so the measured value of Table 8.1&8.2 is 4 times as big as annex B.

**Table 8.1: System Verification of Head (1W)**

Measurement Date (yyyy-mm-dd)	Frequency	Target value (W/kg)		Measured value (W/kg)		Deviation	
		10 g Average	1 g Average	10 g Average	1 g Average	10 g Average	1 g Average
2014-08-06	835 MHz	6.32	9.62	6.44	9.84	1.90%	2.29%
2014-08-06	1900 MHz	20.9	40.0	20.72	40.4	-0.86%	-1.00%

**Table 8.2: System Verification of Body (1W)**

Measurement Date (yyyy-mm-dd)	Frequency	Target value (W/kg)		Measured value (W/kg)		Deviation	
		10 g Average	1 g Average	10 g Average	1 g Average	10 g Average	1 g Average
2014-08-07	835 MHz	6.26	9.52	6.48	9.84	3.51%	3.36%
2014-08-07	1900 MHz	21.4	40.3	21.92	41.6	2.43%	3.23%

## 8.3 Justification for Extended SAR Dipole Calibrations

Usage of SAR dipoles calibrated less than 2 years ago but more than 1 year ago were confirmed in maintaining return loss (< - 20 dB, within 20% of prior calibration) and impedance (within 5 ohm from prior calibration) requirements per extended calibrations in KDB 865664 D01:

Dipole D835V2 SN: 4d057				
Head Liquid				
Date of Measurement	Return Loss(dB)	$\Delta$ %	Impedance ( $\Omega$ )	$\Delta\Omega$
10/24/2012	-29.5	/	52.1	/
10/23/2013	-28.4	3.7	50.3	1.8
Body Liquid				
Date of Measurement	Return Loss(dB)	$\Delta$ %	Impedance ( $\Omega$ )	$\Delta\Omega$
10/24/2012	-26.2	/	48.1	/
10/23/2013	-25.8	1.5	46.7	1.4 $\Omega$
Dipole D1900V2 SN: 5d088				
Head Liquid				

Date of Measurement	Return Loss(dB)	$\Delta$ %	Impedance ( $\Omega$ )	$\Delta\Omega$
10/17/2012	-24.3	/	52.0	/
10/16/2013	-23.3	4.1	50.3	1.7
Body Liquid				
Date of Measurement	Return Loss(dB)	$\Delta$ %	Impedance ( $\Omega$ )	$\Delta\Omega$
10/17/2012	-24.0	/	48.9	/
10/16/2013	-23.2	3.3	47.6	1.3

## 9 Measurement Procedures

### 9.1 Tests to be performed

In order to determine the highest value of the peak spatial-average SAR of a handset, all device positions, configurations and operational modes shall be tested for each frequency band according to steps 1 to 3 below. A flowchart of the test process is shown in Picture 11.1.

**Step 1:** The tests described in 11.2 shall be performed at the channel that is closest to the centre of the transmit frequency band ( $f_c$ ) for:

- a) all device positions (cheek and tilt, for both left and right sides of the SAM phantom, as described in Chapter 8),
- b) all configurations for each device position in a), e.g., antenna extended and retracted, and
- c) all operational modes, e.g., analogue and digital, for each device position in a) and configuration in b) in each frequency band.

If more than three frequencies need to be tested according to 11.1 (i.e.,  $N_c > 3$ ), then all frequencies, configurations and modes shall be tested for all of the above test conditions.

**Step 2:** For the condition providing highest peak spatial-average SAR determined in Step 1, perform all tests described in 11.2 at all other test frequencies, i.e., lowest and highest frequencies. In addition, for all other conditions (device position, configuration and operational mode) where the peak spatial-average SAR value determined in Step 1 is within 3 dB of the applicable SAR limit, it is recommended that all other test frequencies shall be tested as well.

**Step 3:** Examine all data to determine the highest value of the peak spatial-average SAR found in Steps 1 to 2.



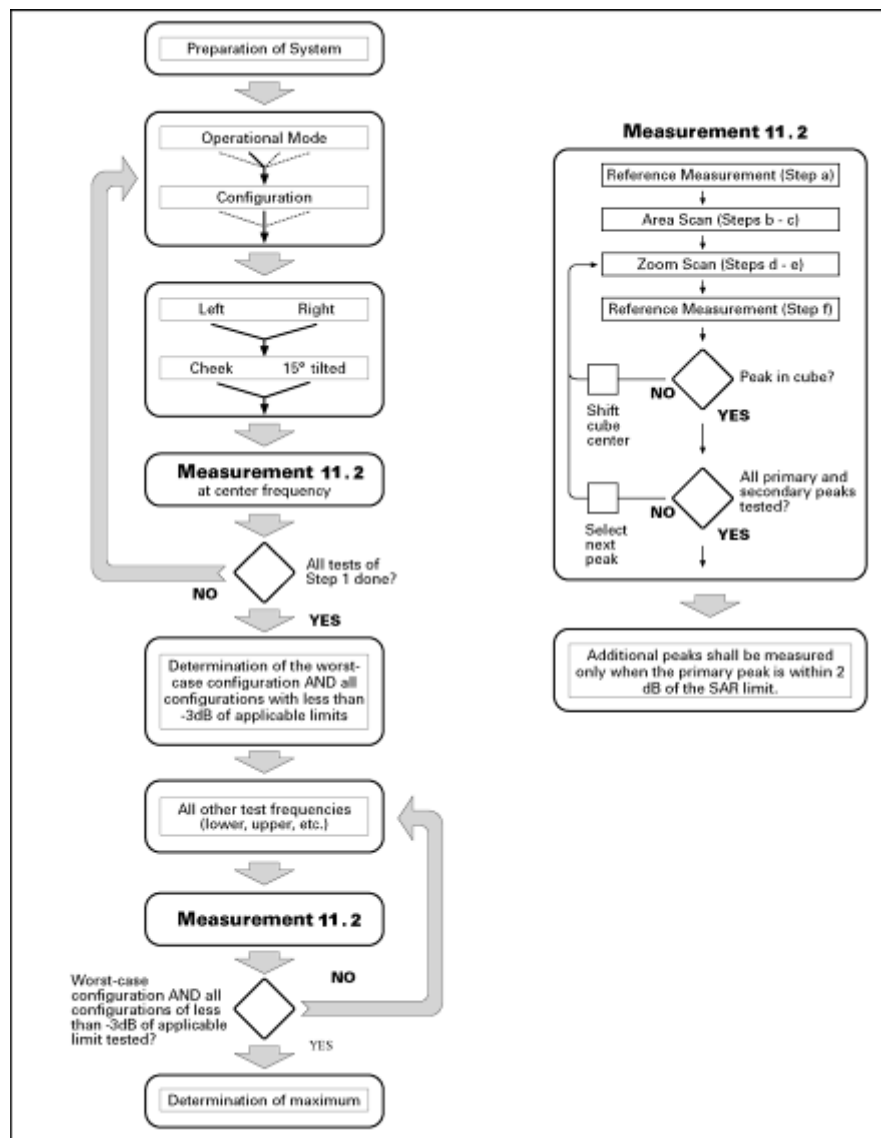

Picture 9.1 Block diagram of the tests to be performed

## 9.2 General Measurement Procedure

The area and zoom scan resolutions specified in the table below must be applied to the SAR measurements and fully documented in SAR reports to qualify for TCB approval. Probe boundary effect error compensation is required for measurements with the probe tip closer than half a probe tip diameter to the phantom surface. Both the probe tip diameter and sensor offset distance must satisfy measurement protocols; to ensure probe boundary effect errors are minimized and the higher fields closest to the phantom surface can be correctly measured and extrapolated to the phantom surface for computing 1-g SAR. Tolerances of the post-processing algorithms must be verified by the test laboratory for the scan resolutions used in the SAR measurements, according to the reference distribution functions specified in IEEE Std 1528-2003. The results should be documented as part of the system validation records and may be requested to support test results when all the measurement parameters in the following table are not satisfied.

		$\leq 3$ GHz	$> 3$ GHz	
Maximum distance from closest measurement point (geometric center of probe sensors) to phantom surface		$5 \pm 1$ mm	$\frac{1}{2} \cdot \delta \cdot \ln(2) \pm 0.5$ mm	
Maximum probe angle from probe axis to phantom surface normal at the measurement location		$30^\circ \pm 1^\circ$	$20^\circ \pm 1^\circ$	
Maximum area scan spatial resolution: $\Delta x_{Area}, \Delta y_{Area}$		$\leq 2$ GHz: $\leq 15$ mm 2 – 3 GHz: $\leq 12$ mm	3 – 4 GHz: $\leq 12$ mm 4 – 6 GHz: $\leq 10$ mm	
		When the x or y dimension of the test device, in the measurement plane orientation, is smaller than the above, the measurement resolution must be $\leq$ the corresponding x or y dimension of the test device with at least one measurement point on the test device.		
Maximum zoom scan spatial resolution: $\Delta x_{Zoom}, \Delta y_{Zoom}$		$\leq 2$ GHz: $\leq 8$ mm 2 – 3 GHz: $\leq 5$ mm*	3 – 4 GHz: $\leq 5$ mm* 4 – 6 GHz: $\leq 4$ mm*	
Maximum zoom scan spatial resolution, normal to phantom surface	uniform grid: $\Delta z_{Zoom}(n)$	$\leq 5$ mm	3 – 4 GHz: $\leq 4$ mm 4 – 5 GHz: $\leq 3$ mm 5 – 6 GHz: $\leq 2$ mm	
	graded grid	$\Delta z_{Zoom}(1)$ : between 1 <sup>st</sup> two points closest to phantom surface	$\leq 4$ mm	3 – 4 GHz: $\leq 3$ mm 4 – 5 GHz: $\leq 2.5$ mm 5 – 6 GHz: $\leq 2$ mm
		$\Delta z_{Zoom}(n>1)$ : between subsequent points	$\leq 1.5 \cdot \Delta z_{Zoom}(n-1)$	
Minimum zoom scan volume	x, y, z	$\geq 30$ mm	3 – 4 GHz: $\geq 28$ mm 4 – 5 GHz: $\geq 25$ mm 5 – 6 GHz: $\geq 22$ mm	
<p>Note: <math>\delta</math> is the penetration depth of a plane-wave at normal incidence to the tissue medium; see draft standard IEEE P1528-2011 for details.</p> <p>* When zoom scan is required and the <i>reported</i> SAR from the area scan based <i>I-g SAR estimation</i> procedures of KDB 447498 is <math>\leq 1.4</math> W/kg, <math>\leq 8</math> mm, <math>\leq 7</math> mm and <math>\leq 5</math> mm zoom scan resolution may be applied, respectively, for 2 GHz to 3 GHz, 3 GHz to 4 GHz and 4 GHz to 6 GHz.</p>				

### 9.3 Bluetooth Measurement Procedures for SAR

Normal network operating configurations are not suitable for measuring the SAR of 802.11 transmitters in general. Unpredictable fluctuations in network traffic and antenna diversity conditions can introduce undesirable variations in SAR results. The SAR for these devices should be measured using chipset based test mode software to ensure that the results are consistent and reliable.

Chipset based test mode software is hardware dependent and generally varies among manufacturers. The device operating parameters established in a test mode for SAR measurements must be identical to those programmed in production units, including output power levels, amplifier gain settings and other RF performance tuning parameters. The test frequencies should correspond to actual channel frequencies defined for domestic use. SAR for devices with switched diversity should be measured with only one antenna transmitting at a time during each SAR measurement, according to a fixed modulation and data rate. The same data pattern should be used for all measurements.

## 9.4 Power Drift

To control the output power stability during the SAR test, DASY5 system calculates the power drift by measuring the E-field at the same location at the beginning and at the end of the measurement for each test position. These drift values can be found in Table 14.1 to Table 14.11 labeled as: (Power Drift [dB]). This ensures that the power drift during one measurement is within 5%.

## 10 Conducted Output Power

### 10.1 Manufacturing tolerance

**Table 10.1: GSM Speech**

GSM 850			
Channel	Channel 251	Channel 190	Channel 128
Target (dBm)	32	32	32
Tolerance $\pm$ (dB)	1	1	1
GSM 1900			
Channel	Channel 810	Channel 661	Channel 512
Target (dBm)	28	28	28
Tolerance $\pm$ (dB)	1	1	1

**Table 10.2: GPRS(GMSK Modulation)**

GSM 850 GPRS				
Channel		251	190	128
1 Txslot	Target (dBm)	31.5	31.5	31.5
	Tolerance $\pm$ (dB)	1	1	1
2 Txslots	Target (dBm)	30	30	30
	Tolerance $\pm$ (dB)	1	1	1
3Txslots	Target (dBm)	28	28	28
	Tolerance $\pm$ (dB)	1	1	1
4 Txslots	Target (dBm)	26	26	26
	Tolerance $\pm$ (dB)	1	1	1
GSM 1900 GPRS				
Channel		810	661	512
1 Txslot	Target (dBm)	29	29	29
	Tolerance $\pm$ (dB)	1	1	1
2 Txslots	Target (dBm)	27	27	27
	Tolerance $\pm$ (dB)	1	1	1
3Txslots	Target (dBm)	25	25	25
	Tolerance $\pm$ (dB)	1	1	1
4 Txslots	Target (dBm)	23	23	23
	Tolerance $\pm$ (dB)	1	1	1

**Table 10.5: BT**

Channel	Channel 0	Channel 39	Channel 78
Target (dBm)	-0.5	-0.2	0.8
Tolerance ±(dB)	1	1	1

## 10.2 GSM Measurement result

During the process of testing, the EUT was controlled via Agilent Digital Radio Communication tester (E5515C) to ensure the maximum power transmission and proper modulation. This result contains conducted output power for the EUT. In all cases, the measured peak output power should be greater and within 5% than EMI measurement.

**Table 10.6: The conducted power measurement results for GSM850/1900**

GSM 850MHz	Conducted Power (dBm)		
	Channel 251(848.8MHz)	Channel 190(836.6MHz)	Channel 128(824.2MHz)
	32.22	32.25	32.54
GSM 1900MHz	Conducted Power (dBm)		
	Channel 810(1909.8MHz)	Channel 661(1880MHz)	Channel 512(1850.2MHz)
	28.25	28.85	28.96

**Table 10.7: The conducted power measurement results for GPRS**

GSM 850 GPRS (GMSK)	Measured Power (dBm)			calculation	Averaged Power (dBm)		
	251	190	128		251	190	128
1 Txslot	32.2	32.4	32.4	-9.03dB	23.17	23.37	23.37
2 Txslots	30.5	30.5	30.6	-6.02dB	24.48	24.48	24.58
3Txslots	28.6	28.6	28.6	-4.26dB	24.34	24.34	24.34
<b>4 Txslots</b>	26.6	26.6	26.5	-3.01dB	23.59	23.59	23.49
PCS1900 GPRS (GMSK)	Measured Power (dBm)			calculation	Averaged Power (dBm)		
	810	661	512		810	661	512
1 Txslot	29.6	29.6	29.3	-9.03dB	20.57	20.57	20.27
2 Txslots	27.5	27.4	27.3	-6.02dB	21.48	21.38	21.28
3Txslots	25.9	25.8	25.7	-4.26dB	21.64	21.54	21.44
<b>4 Txslots</b>	23.7	23.7	23.5	-3.01dB	20.69	20.69	20.49

NOTES:

1) Division Factors

To average the power, the division factor is as follows:

1TX-slot = 1 transmit time slot out of 8 time slots=> conducted power divided by (8/1) => -9.03dB

2TX-slots = 2 transmit time slots out of 8 time slots=> conducted power divided by (8/2) => -6.02dB

3TX-slots = 3 transmit time slots out of 8 time slots=> conducted power divided by (8/3) => -4.26dB

4TX-slots = 4 transmit time slots out of 8 time slots=> conducted power divided by (8/4) => -3.01dB

**According to the conducted power as above, the body measurements are performed with 2Txslots for GSM850 and 3Txslots for PCS1900.**

**. 10.4 BT Measurement result**

**The conducted Power for BT**

model\Channel	Measured Power (dBm)		
	Ch 0 2402 MHz	Ch 39 2441 MHz	Ch 78 2480 MHz
GFSK	-1.40	-0.94	-0.09
$\pi/4$ DQPSK	0.29	0.73	1.48
8DPSK	0.11	0.68	1.31

## 11 Simultaneous TX SAR Considerations

### 11.1 Introduction

The following procedures adopted from “FCC SAR Considerations for Cell Phones with Multiple Transmitters” are applicable to handsets with built-in unlicensed transmitters such as Bluetooth devices which may simultaneously transmit with the licensed transmitter.

For this device, the BT can transmit simultaneous with other transmitters.

### 11.2 Transmit Antenna Separation Distances

Frequency Range:	GSM850 824 ~ 894 MHz PCS1900: 1880~1900MHz Bluetooth: 2402 ~ 2480 MHz
Connector Type/ Maximum Gain	GSM850: -1.2dbi PCS1900: 0.3dbi Bluetooth: 1.4dBi
Antenna Type/ Pattern:	PIFA(GSM) PIFA(BT)



Picture 11.1 Antenna Locations

### 11.3 Standalone SAR Test Exclusion Considerations

Standalone 1-g head or body SAR evaluation by measurement or numerical simulation is not required when the corresponding SAR Exclusion Threshold condition, listed below, is satisfied. The 1-g SAR test exclusion threshold for 100 MHz to 6 GHz at test separation distances  $\leq 50$  mm are determined by:

$[(\text{max. power of channel, including tune-up tolerance, mW}) / (\text{min. test separation distance, mm})] \cdot [\sqrt{f(\text{GHz})}] \leq 3.0$  for 1-g SAR, where

- $f(\text{GHz})$  is the RF channel transmit frequency in GHz
- Power and distance are rounded to the nearest mW and mm before calculation
- The result is rounded to one decimal place for comparison

According to the KDB447498 appendix A, the SAR test exclusion threshold for 2450MHz at 10m test separation distances is 19mW.

#### Appendix A

#### SAR Test Exclusion Thresholds for 100 MHz – 6 GHz and $\leq 50$ mm

Approximate SAR Test Exclusion Power Thresholds at Selected Frequencies and Test Separation Distances are illustrated in the following Table.

MHz	5	10	15	20	25	mm
150	39	77	116	155	194	SAR Test Exclusion Threshold (mW)
300	27	55	82	110	137	
450	22	45	67	89	112	
835	16	33	49	66	82	
900	16	32	47	63	79	
1500	12	24	37	49	61	
1900	11	22	33	44	54	
2450	10	19	29	38	48	
3600	8	16	24	32	40	
5200	7	13	20	26	33	
5400	6	13	19	26	32	
5800	6	12	19	25	31	

Picture 11.3 Power Thresholds

## 12 Evaluation of Simultaneous

Table 12.1: Summary of Transmitters

Band/Mode	F(GHz)	SAR test exclusion threshold (mW)	RF output power (mW)
Bluetooth	2.480	10	1.41

According to the conducted power measurement result, we can draw the conclusion that: Stand-alone SAR for BT must be estimated according to following to determine simultaneous transmission SAR, and the result is **0.058W/kg** (1g average) for head SAR, **0.029W/kg** (1g average) for body SAR.

$(\text{max. power of channel, including tune-up tolerance, mW}) / (\text{min. test separation distance, mm}) \cdot [\sqrt{f_{\text{(GHz)}}/x}] \text{ W/kg}$  for test separation distances  $\leq 50 \text{ mm}$ ;

where  $x = 7.5$  for 1-g SAR, and  $x = 18.75$  for 10-g SAR.

**Table 12.2: The sum of reported SAR values**

	<b>Position</b>	<b>GSM</b>	<b>BT</b>	<b>Sum</b>
<b>Maximum reported SAR value for Head</b>	Right hand, Touch	1.391	0.058	<b>1.449</b>
<b>Maximum reported SAR value for Body</b>	Rear Side	1.346	0.029	<b>1.375</b>

According to the above table, the sum of reported SAR values for GSM and BT  $< 1.6 \text{ W/kg}$ . So the simultaneous transmission SAR is not required for BT transmitter.



### 13 SAR Test Result

It is determined by user manual for the distance between the EUT and the phantom bottom.

The distance is 10mm and just applied to the condition of body worn accessory.

It is performed for all SAR measurements with area scan and zoom scan based 1-g SAR estimation.

In this report, measured SAR results are scaled to the maximum tune-up tolerance limit according the power applied to the individual channels, and the results are shown in the column “reported SAR”.

#### 13.1 SAR Test Result

**Table 13.1: Duty Cycle**

	Duty Cycle
Speech for GSM850/1900	1:8.3
GPRS for GSM850	1:4
GPRS for GSM1900	1:2.67

**Table 13.2: SAR Values (GSM 850 MHz Band - Head)**

Frequency		Side	Test Position	Conducted Power (dBm)	Max Power (dBm)	Measured SAR(1g) (W/kg)	Reported SAR(1g) (W/kg)	Power Drift (dB)
MHz	Ch.							
836.6	190	Left	Touch	32.25	33	1.080	1.284	0.05
836.6	190	Left	Tilt	32.25	33	0.610	0.725	-0.02
836.6	190	Right	Touch	32.25	33	1.170	<b>1.391</b>	0.02
836.6	190	Right	Tilt	32.25	33	0.650	0.773	0.00
848.8	251	Left	Touch	32.22	33	0.918	1.099	-0.06
824.2	128	Left	Touch	32.54	33	0.741	0.824	0.01
848.8	251	Right	Touch	32.22	33	1.010	1.209	0.04
824.2	128	Right	Touch	32.54	33	1.090	1.212	-0.18
<b>Worst Case Position of Head (1st Repeated SAR)</b>								
836.6	190	Right	Touch	32.25	33	1.080	1.284	-0.09

**Table 13.3: SAR Values (GSM 850 MHz Band - Body)**

Frequency		Mode	Test Position	Conducted Power (dBm)	Max Power (dBm)	Measured SAR(1g) (W/kg)	Reported SAR(1g) (W/kg)	Power Drift (dB)
MHz	Ch.							
836.6	190	GPRS (2Slots)	Front	30.5	31	0.950	1.066	-0.16
836.6	190	GPRS (2Slots)	Rear	30.5	31	1.200	<b>1.346</b>	-0.04
848.8	251	GPRS (2Slots)	Front	30.5	31	0.749	0.840	0.03
824.2	128	GPRS (2Slots)	Front	30.6	31	0.883	0.968	-0.04
848.8	251	GPRS (2Slots)	Rear	30.5	31	1.150	1.290	0.03
824.2	128	GPRS (2Slots)	Rear	30.6	31	1.010	1.107	-0.02
836.6	190	SPEECH	Rear	32.25	33	0.873	1.038	0.02
<b>Worst Case Position of Body (1st Repeated SAR)</b>								

836.6	190	GPRS (2Slots)	Rear	30.5	31	1.18	1.324	0.04
-------	-----	---------------	------	------	----	------	-------	------

Note: The distance between the EUT and the phantom bottom is 10mm.

**Table 13.4: SAR Values (GSM 1900 MHz Band - Head)**

Frequency		Side	Test Position	Conducted Power (dBm)	Max Power (dBm)	Measured SAR(1g) (W/kg)	Reported SAR(1g) (W/kg)	Power Drift (dB)
MHz	Ch.							
1880	661	Left	Touch	28.85	29	0.244	0.253	-0.13
1880	661	Left	Tilt	28.85	29	0.067	0.069	-0.13
1880	661	Right	Touch	28.85	29	0.336	0.348	0.13
1880	661	Right	Tilt	28.85	29	0.112	0.116	0.13
1909.8	810	Right	Touch	28.25	29	0.369	<b>0.439</b>	0.15
1850.2	512	Right	Touch	28.96	29	0.298	0.301	-0.01

**Table 13.5: SAR Values (GSM 1900 MHz Band - Body)**

Frequency		Mode	Test Position	Conducted Power (dBm)	Max Power (dBm)	Measured SAR(1g) (W/kg)	Reported SAR(1g) (W/kg)	Power Drift (dB)
MHz	Ch.							
1880	661	GPRS (3Slots)	Front	25.8	26	0.129	0.135	0.11
1880	661	GPRS (3Slots)	Rear	25.8	26	0.414	0.434	-0.14
1909.8	810	GPRS (3Slots)	Rear	25.9	26	0.349	0.357	0.13
1850.2	512	GPRS (3Slots)	Rear	25.7	26	0.783	<b>0.839</b>	0.13
1850.2	512	SPEECH	Rear	28.96	29	0.137	0.138	0.13

Note: The distance between the EUT and the phantom bottom is 10mm.

## 14 SAR Measurement Variability

SAR measurement variability must be assessed for each frequency band, which is determined by the SAR probe calibration point and tissue-equivalent medium used for the device measurements. When both head and body tissue-equivalent media are required for SAR measurements in a frequency band, the variability measurement procedures should be applied to the tissue medium with the highest measured SAR, using the highest measured SAR configuration for that tissue-equivalent medium.

The following procedures are applied to determine if repeated measurements are required.

- 1) Repeated measurement is not required when the original highest measured SAR is  $< 0.80$  W/kg; steps 2) through 4) do not apply.
- 2) When the original highest measured SAR is  $\geq 0.80$  W/kg, repeat that measurement once.
- 3) Perform a second repeated measurement only if the ratio of largest to smallest SAR for the original and first repeated measurements is  $> 1.20$  or when the original or repeated measurement is  $\geq 1.45$  W/kg (~ 10% from the 1-g SAR limit).
- 4) Perform a third repeated measurement only if the original, first or second repeated measurement is  $\geq 1.5$  W/kg and the ratio of largest to smallest SAR for the original, first and second repeated measurements is  $> 1.20$ .

**Table 14.1: SAR Measurement Variability for Head GSM 850 (1g)**

Frequency		Test Position	Original SAR (W/kg)	First Repeated SAR (W/kg)	The Ratio	Second Repeated SAR (W/kg)
MHz	Ch.					
836.6	190	Right/Touch	1.170	1.080	1.16	/

**Table 14.2: SAR Measurement Variability for Body GSM 850 (1g)**

Frequency		Test Position	Spacing (mm)	Original SAR (W/kg)	First Repeated SAR (W/kg)	The Ratio	Second Repeated SAR (W/kg)
MHz	Ch.						
836.6	190	Rear	10	1.200	1.18	1.02	/

## 15 Measurement Uncertainty

### 15.1 Measurement Uncertainty for Normal SAR Tests (300MHz-3000MHz)

No.	Error Description	Type	Uncertainty value	Probably Distribution	Div.	(Ci) 1g	(Ci) 10g	Std. Unc. (1g)	Std. Unc. (10g)	Degree of freedom
<b>Measurement system</b>										
1	Probe calibration	B	5.5	N	1	1	1	5.5	5.5	∞
2	Isotropy	B	4.7	R	$\sqrt{3}$	0.7	0.7	1.9	1.9	∞
3	Boundary effect	B	1.0	R	$\sqrt{3}$	1	1	0.6	0.6	∞
4	Linearity	B	4.7	R	$\sqrt{3}$	1	1	2.7	2.7	∞
5	Detection limit	B	1.0	N	1	1	1	0.6	0.6	∞
6	Readout electronics	B	0.3	R	$\sqrt{3}$	1	1	0.3	0.3	∞
7	Response time	B	0.8	R	$\sqrt{3}$	1	1	0.5	0.5	∞
8	Integration time	B	2.6	R	$\sqrt{3}$	1	1	1.5	1.5	∞
9	RF ambient conditions-noise	B	0	R	$\sqrt{3}$	1	1	0	0	∞
10	RF ambient conditions-reflection	B	0	R	$\sqrt{3}$	1	1	0	0	∞
11	Probe positioned mech. restrictions	B	0.4	R	$\sqrt{3}$	1	1	0.2	0.2	∞
12	Probe positioning with respect to phantom shell	B	2.9	R	$\sqrt{3}$	1	1	1.7	1.7	∞
13	Post-processing	B	1.0	R	$\sqrt{3}$	1	1	0.6	0.6	∞
<b>Test sample related</b>										
14	Test sample positioning	A	3.3	N	1	1	1	3.3	3.3	71
15	Device holder uncertainty	A	3.4	N	1	1	1	3.4	3.4	5
16	Drift of output power	B	5.0	R	$\sqrt{3}$	1	1	2.9	2.9	∞
<b>Phantom and set-up</b>										
17	Phantom uncertainty	B	4.0	R	$\sqrt{3}$	1	1	2.3	2.3	∞
18	Liquid conductivity (target)	B	5.0	R	$\sqrt{3}$	0.64	0.43	1.8	1.2	∞
19	Liquid conductivity (meas.)	A	2.06	N	1	0.64	0.43	1.32	0.89	43
20	Liquid permittivity (target)	B	5.0	R	$\sqrt{3}$	0.6	0.49	1.7	1.4	∞
21	Liquid permittivity (meas.)	A	1.6	N	1	0.6	0.49	1.0	0.8	521

Combined standard uncertainty	$u_c = \sqrt{\sum_{i=1}^{21} c_i^2 u_i^2}$					9.25	9.12	257
Expanded uncertainty (confidence interval of 95 %)	$u_e = 2u_c$					18.5	18.2	

## 16 MAIN TEST INSTRUMENTS

**Table 16.1: List of Main Instruments**

No.	Name	Type	Serial Number	Calibration Date	Valid Period
01	Network analyzer	Agilent E5071C	MY46103759	December 27,2013	One year
02	Power meter	NRVD	101253	March 6,2014	One year
03	Power sensor	NRV-Z5	100333		
04	Signal Generator	E4438C	MY45095825	January 14, 2014	One year
05	Amplifier	VTL5400	0404	No Calibration Requested	
06	BTS	E5515C	GB47460133	September 5, 2013	One year
07	E-field Probe	SPEAG EX3DV4	3633	October 31, 2013	One year
08	DAE	SPEAG DAE4	786	November 25, 2013	One year
09	Dipole Validation Kit	SPEAG D835V2	4d057	October 24,2012	Two year
10	Dipole Validation Kit	SPEAG D1900V2	5d088	October 17,2012	Two year

\*\*\*END OF REPORT BODY\*\*\*

## ANNEX A GRAPH RESULTS

# GSM850 Head

Date/Time: 8/6/2014 10:17:48 AM

Electronics: DAE4 Sn786

Medium: 900head

Medium parameters used (interpolated):  $f = 836.6$  MHz;  $\sigma = 0.883$  S/m;  $\epsilon_r = 42.124$ ;  $\rho = 1000$  kg/m<sup>3</sup>

Ambient Temperature: 24.3°C      Liquid Temperature: 23.8°C

Communication System: GSM850 Frequency: 836.6 MHz Duty Cycle: 1:8.3

Probe: EX3DV4 - SN3633 ConvF(6.13, 6.13, 6.13); Calibrated: 10/31/2013

**Left Cheek Middle/Area Scan (61x101x1):** Interpolated grid: dx=1.500 mm, dy=1.500 mm

Reference Value = 13.745 V/m; Power Drift = 0.05 dB

Maximum value of SAR (interpolated) = 1.16 W/kg

**Left Cheek Middle/Zoom Scan (5x5x7)/Cube 0:** Measurement grid: dx=8mm, dy=8mm, dz=5mm

Reference Value = 13.745 V/m; Power Drift = 0.05 dB

Peak SAR (extrapolated) = 1.43 W/kg

**SAR(1 g) = 1.08 W/kg; SAR(10 g) = 0.752 W/kg**

Maximum value of SAR (measured) = 1.16 W/kg

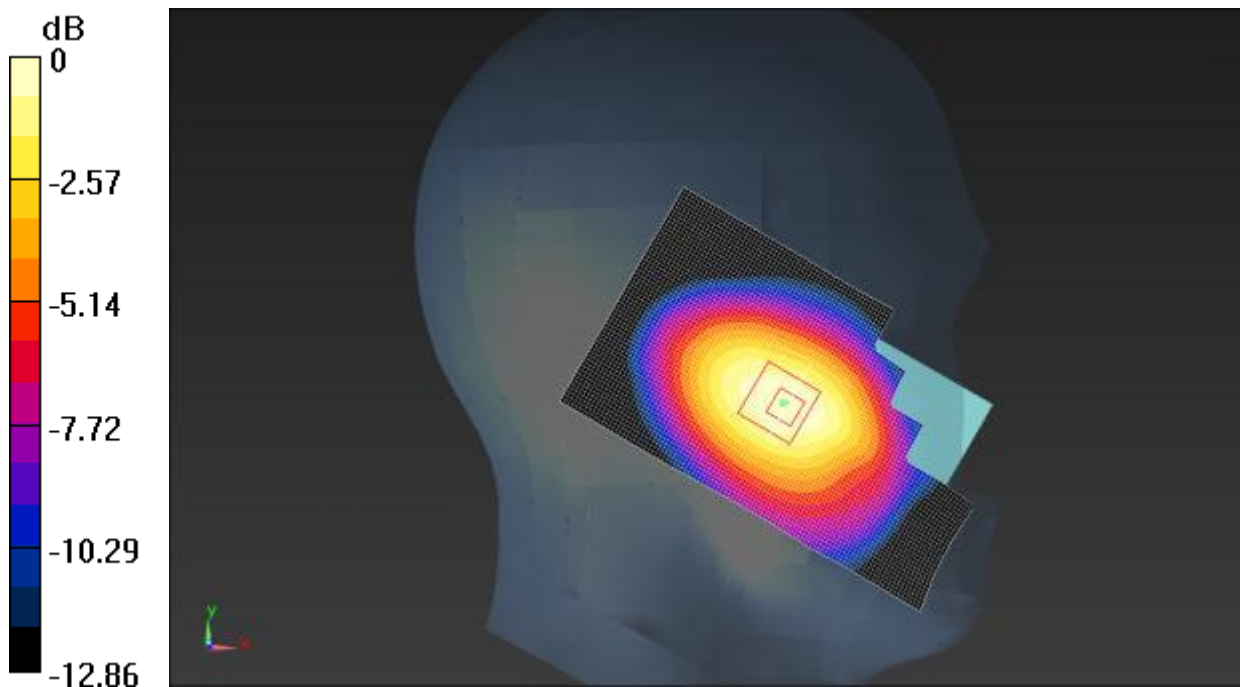

0 dB = 1.16 W/kg = 0.64 dBW/kg

Fig. 1 GSM 850MHz CH190

# GSM850 Head

Date/Time: 8/6/2014 10:34:13 AM

Electronics: DAE4 Sn786

Medium: 900head

Medium parameters used (interpolated):  $f = 836.6$  MHz;  $\sigma = 0.883$  S/m;  $\epsilon_r = 42.124$ ;  $\rho = 1000$  kg/m<sup>3</sup>

Ambient Temperature: 24.3°C      Liquid Temperature: 23.8°C

Communication System: GSM850 Frequency: 836.6 MHz Duty Cycle: 1:8.3

Probe: EX3DV4 - SN3633 ConvF(6.13, 6.13, 6.13); Calibrated: 10/31/2013

**Left Tilt Middle/Area Scan (61x101x1):** Interpolated grid: dx=1.500 mm, dy=1.500 mm

Reference Value = 17.817 V/m; Power Drift = -0.02 dB

Maximum value of SAR (interpolated) = 0.640 W/kg

**Left Tilt Middle/Zoom Scan (5x5x7)/Cube 0:** Measurement grid: dx=8mm, dy=8mm, dz=5mm

Reference Value = 17.817 V/m; Power Drift = -0.02 dB

Peak SAR (extrapolated) = 0.798 W/kg

**SAR(1 g) = 0.610 W/kg; SAR(10 g) = 0.433 W/kg**

Maximum value of SAR (measured) = 0.648 W/kg

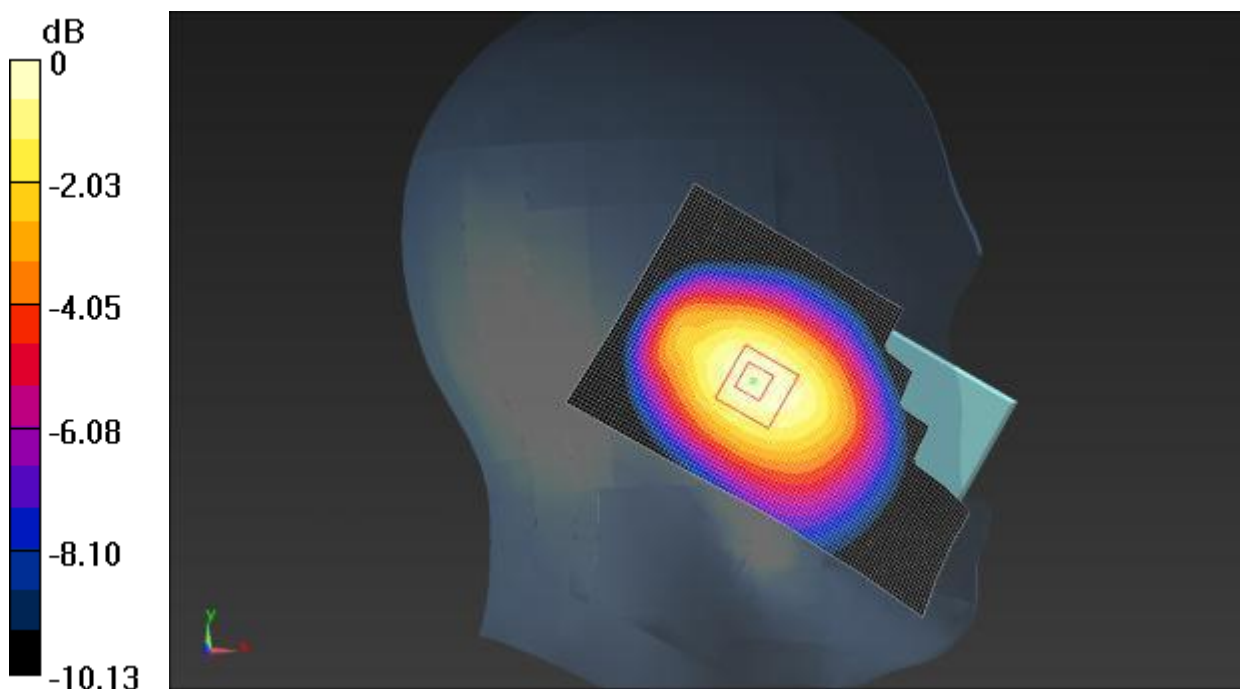

0 dB = 0.648 W/kg = -1.88 dBW/kg

Fig. 2 GSM 850MHz CH190

# GSM850 Head

Date/Time: 8/6/2014 10:59:47 AM

Electronics: DAE4 Sn786

Medium: 900head

Medium parameters used (interpolated):  $f = 836.6$  MHz;  $\sigma = 0.883$  S/m;  $\epsilon_r = 42.124$ ;  $\rho = 1000$  kg/m<sup>3</sup>

Ambient Temperature: 24.3°C      Liquid Temperature: 23.8°C

Communication System: GSM850 Frequency: 836.6 MHz Duty Cycle: 1:8.3

Probe: EX3DV4 - SN3633 ConvF(6.13, 6.13, 6.13); Calibrated: 10/31/2013

**Right Cheek Middle/Area Scan (61x101x1):** Interpolated grid: dx=1.500 mm, dy=1.500 mm

Reference Value = 15.247 V/m; Power Drift = 0.12 dB

Maximum value of SAR (interpolated) = 1.26 W/kg

**Right Cheek Middle/Zoom Scan (5x5x7)/Cube 0:** Measurement grid: dx=8mm, dy=8mm, dz=5mm

Reference Value = 15.247 V/m; Power Drift = 0.12 dB

Peak SAR (extrapolated) = 1.58 W/kg

**SAR(1 g) = 1.17 W/kg; SAR(10 g) = 0.818 W/kg**

Maximum value of SAR (measured) = 1.24 W/kg

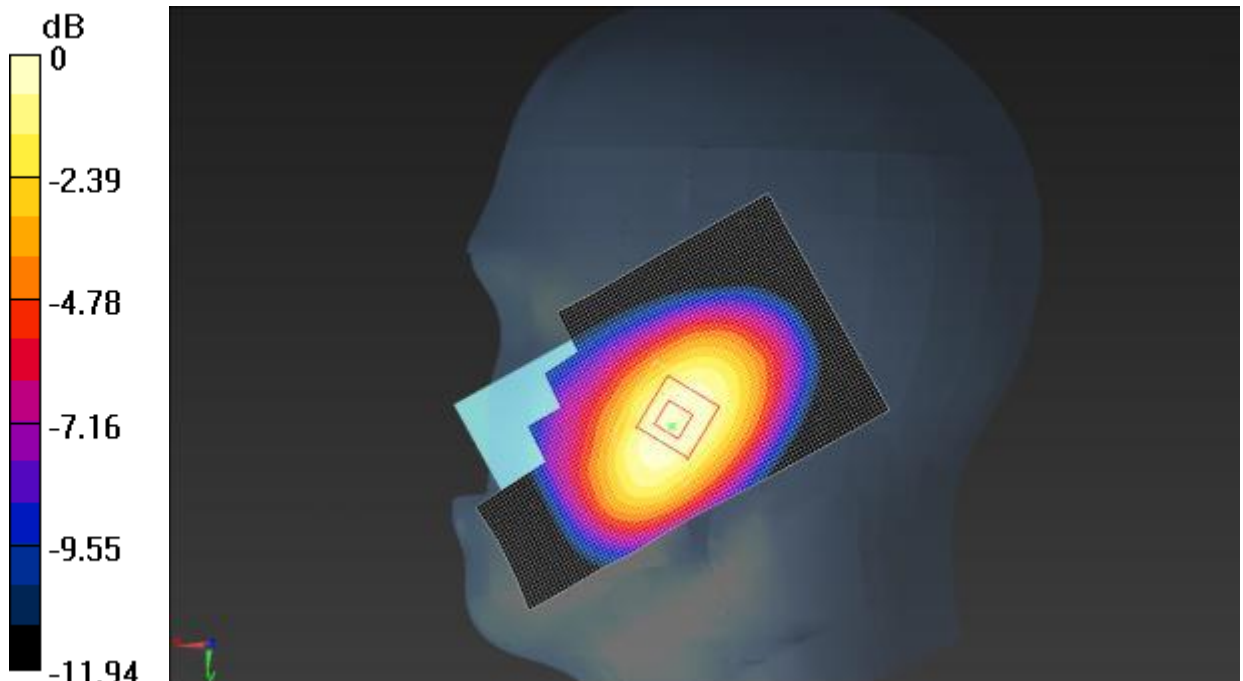

0 dB = 1.24 W/kg = 0.93 dBW/kg

**Fig. 3 GSM 850MHz CH190**



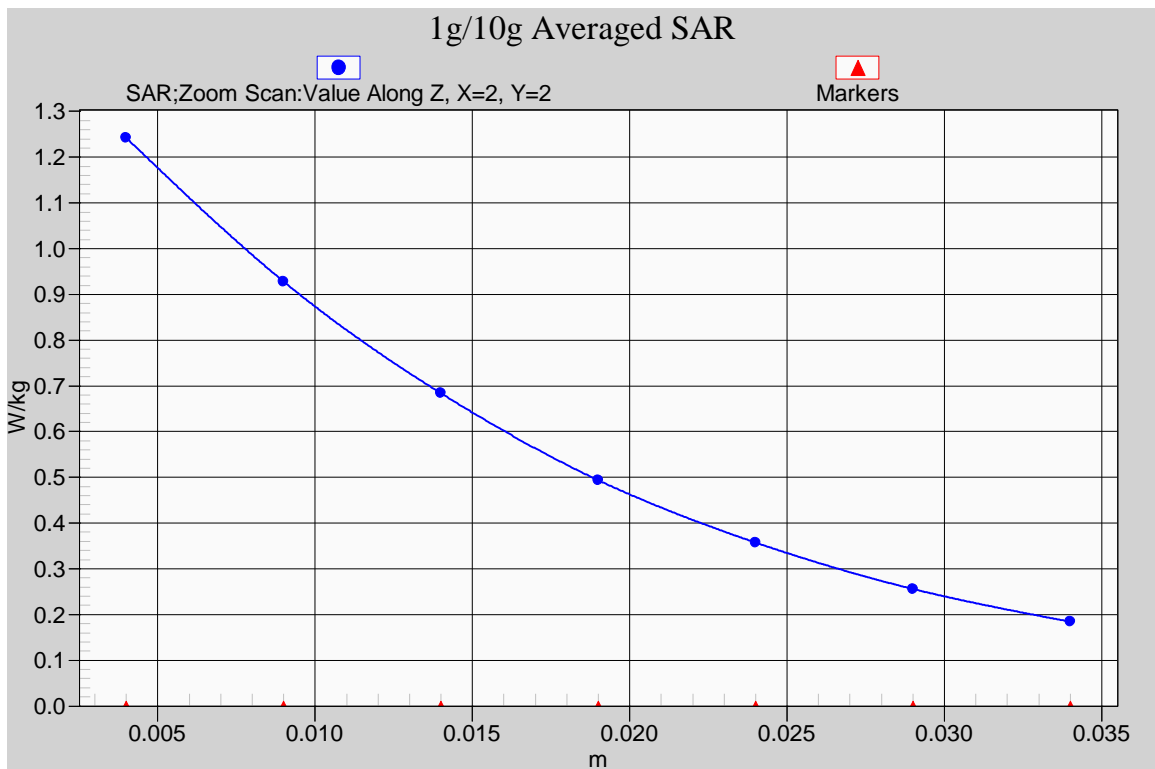

**Fig. 3-1 Z-Scan at power reference point (850MHz CH190)**

# GSM850 Head

Date/Time: 8/6/2014 2:36:18 PM

Electronics: DAE4 Sn786

Medium: 900head

Medium parameters used (interpolated):  $f = 836.6$  MHz;  $\sigma = 0.883$  S/m;  $\epsilon_r = 42.124$ ;  $\rho = 1000$  kg/m<sup>3</sup>

Ambient Temperature: 24.3°C      Liquid Temperature: 23.8°C

Communication System: GSM850 Frequency: 836.6 MHz Duty Cycle: 1:8.3

Probe: EX3DV4 - SN3633 ConvF(6.13, 6.13, 6.13); Calibrated: 10/31/2013

**Right Tilt Middle/Area Scan (61x101x1):** Interpolated grid: dx=1.500 mm, dy=1.500 mm

Reference Value = 20.022 V/m; Power Drift = 0.00 dB

Maximum value of SAR (interpolated) = 0.687 W/kg

**Right Tilt Middle/Zoom Scan (5x5x7)/Cube 0:** Measurement grid: dx=8mm, dy=8mm, dz=5mm

Reference Value = 20.022 V/m; Power Drift = 0.00 dB

Peak SAR (extrapolated) = 0.851 W/kg

**SAR(1 g) = 0.650 W/kg; SAR(10 g) = 0.460 W/kg**

Maximum value of SAR (measured) = 0.689 W/kg

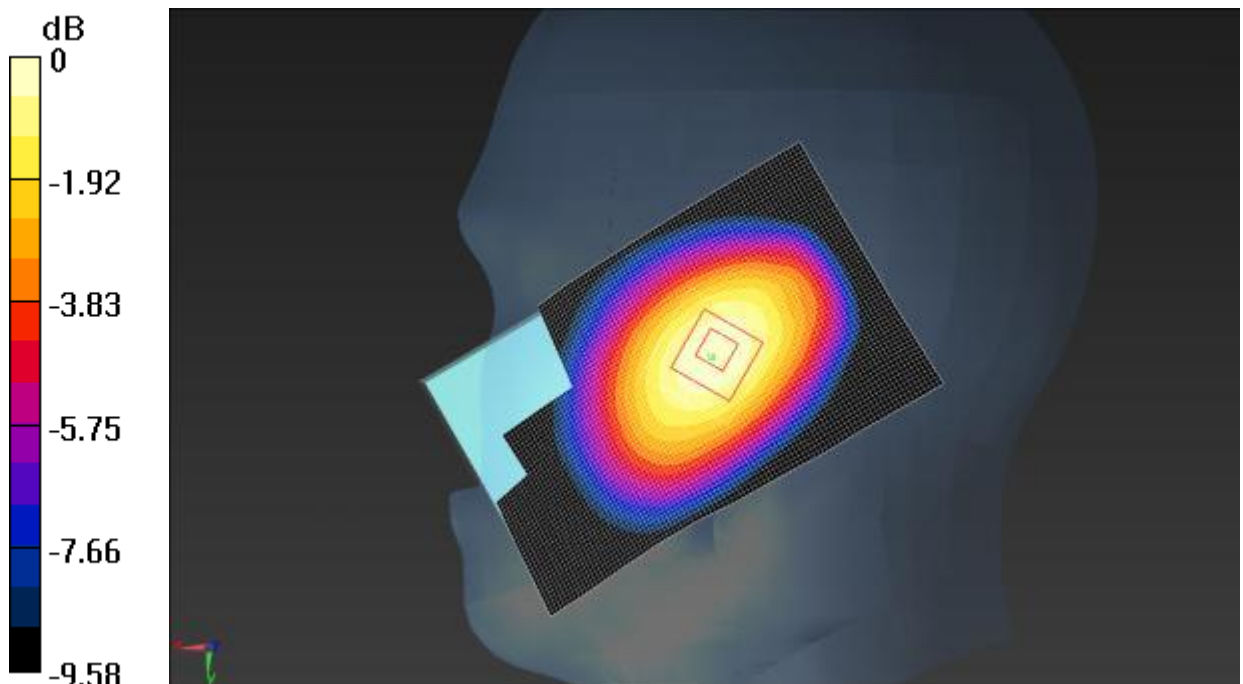

0 dB = 0.689 W/kg = -1.62 dBW/kg

**Fig. 4 GSM 850MHz CH190**

# GSM850 Head

Date/Time: 8/6/2014 10:03:35 AM

Electronics: DAE4 Sn786

Medium: 900head

Medium parameters used (interpolated):  $f = 848.8$  MHz;  $\sigma = 0.895$  S/m;  $\epsilon_r = 41.961$ ;  $\rho = 1000$  kg/m<sup>3</sup>

Ambient Temperature: 24.3°C      Liquid Temperature: 23.8°C

Communication System: GSM850 Frequency: 848.8 MHz Duty Cycle: 1:8.3

Probe: EX3DV4 - SN3633 ConvF(6.13, 6.13, 6.13); Calibrated: 10/31/2013

**Left Cheek high/Area Scan (61x101x1):** Interpolated grid: dx=1.500 mm, dy=1.500 mm

Reference Value = 12.741 V/m; Power Drift = -0.06 dB

Maximum value of SAR (interpolated) = 0.979 W/kg

**Left Cheek high/Zoom Scan (5x5x7)/Cube 0:** Measurement grid: dx=8mm, dy=8mm, dz=5mm

Reference Value = 12.741 V/m; Power Drift = -0.06 dB

Peak SAR (extrapolated) = 1.22 W/kg

**SAR(1 g) = 0.918 W/kg; SAR(10 g) = 0.638 W/kg**

Maximum value of SAR (measured) = 0.974 W/kg

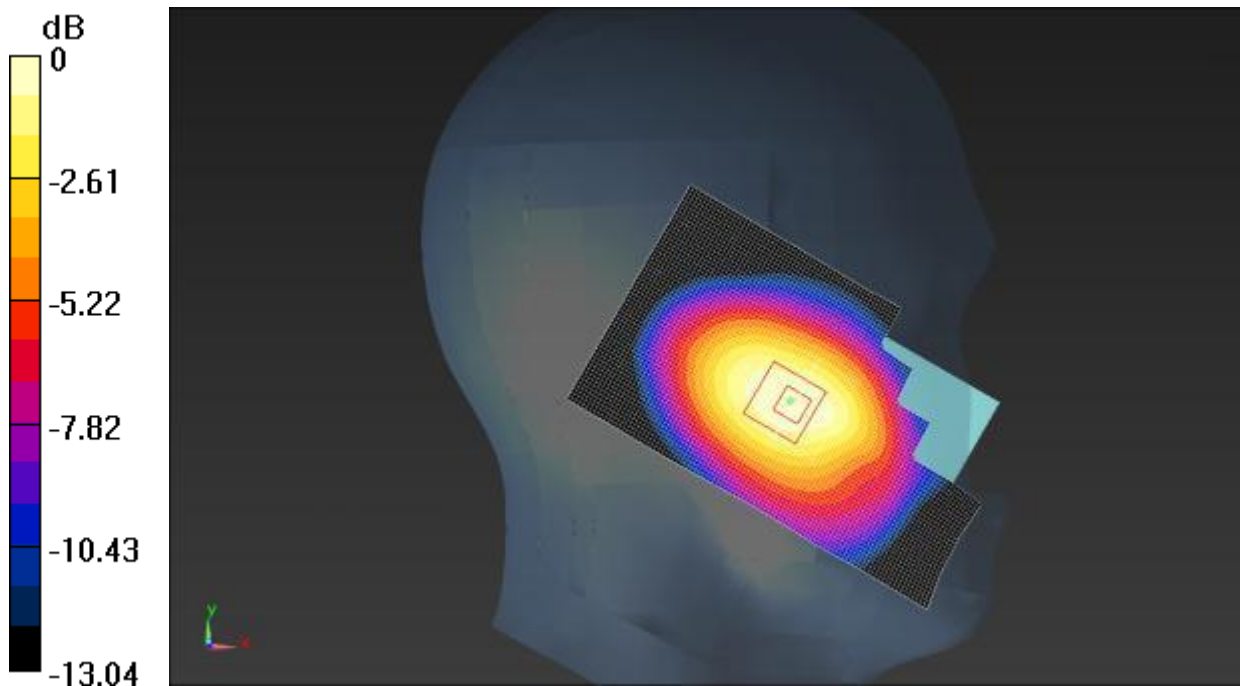

0 dB = 0.974 W/kg = -0.11 dBW/kg

Fig. 5 GSM 850MHz CH251

# GSM850 Head

Date/Time: 8/6/2014 9:16:01 AM

Electronics: DAE4 Sn786

Medium: 900head

Medium parameters used (interpolated):  $f = 824.2$  MHz;  $\sigma = 0.873$  S/m;  $\epsilon_r = 42.308$ ;  $\rho = 1000$  kg/m<sup>3</sup>

Ambient Temperature: 24.3°C      Liquid Temperature: 23.8°C

Communication System: GSM850 Frequency: 824.2 MHz Duty Cycle: 1:8.3

Probe: EX3DV4 - SN3633 ConvF(6.13, 6.13, 6.13); Calibrated: 10/31/2013

**Left Cheek Low/Area Scan (61x101x1):** Interpolated grid: dx=1.500 mm, dy=1.500 mm

Reference Value = 13.125 V/m; Power Drift = 0.01 dB

Maximum value of SAR (interpolated) = 0.799 W/kg

**Left Cheek Low/Zoom Scan (5x5x7)/Cube 0:** Measurement grid: dx=8mm, dy=8mm, dz=5mm

Reference Value = 13.125 V/m; Power Drift = 0.01 dB

Peak SAR (extrapolated) = 0.968 W/kg

**SAR(1 g) = 0.741 W/kg; SAR(10 g) = 0.521 W/kg**

Maximum value of SAR (measured) = 0.784 W/kg

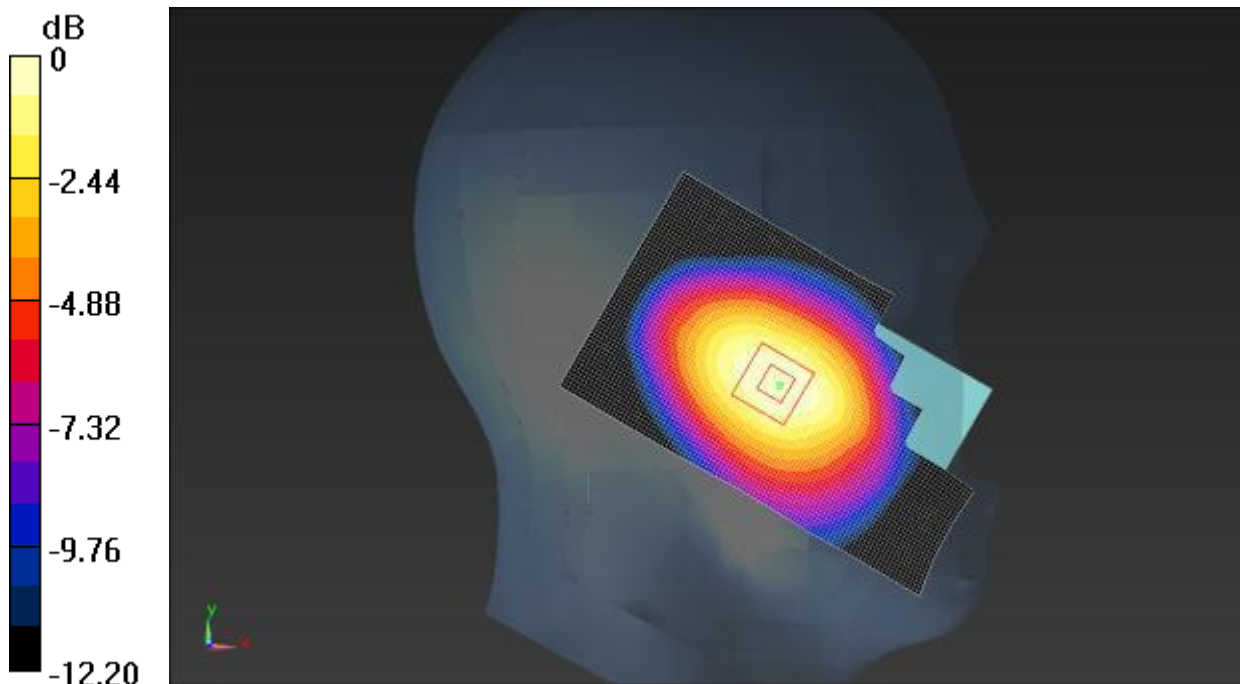

0 dB = 0.784 W/kg = -1.06 dBW/kg

**Fig. 6 GSM 850MHz CH128**

# GSM850 Head

Date/Time: 8/6/2014 11:13:43 AM

Electronics: DAE4 Sn786

Medium: 900head

Medium parameters used (interpolated):  $f = 848.8$  MHz;  $\sigma = 0.895$  S/m;  $\epsilon_r = 41.961$ ;  $\rho = 1000$  kg/m<sup>3</sup>

Ambient Temperature: 24.3°C      Liquid Temperature: 23.8°C

Communication System: GSM850 Frequency: 848.8 MHz Duty Cycle: 1:8.3

Probe: EX3DV4 - SN3633 ConvF(6.13, 6.13, 6.13); Calibrated: 10/31/2013

**Right Cheek High/Area Scan (61x101x1):** Interpolated grid: dx=1.500 mm, dy=1.500 mm

Reference Value = 14.082 V/m; Power Drift = 0.04 dB

Maximum value of SAR (interpolated) = 1.10 W/kg

**Right Cheek High/Zoom Scan (5x5x7)/Cube 0:** Measurement grid: dx=8mm, dy=8mm, dz=5mm

Reference Value = 14.082 V/m; Power Drift = 0.04 dB

Peak SAR (extrapolated) = 1.35 W/kg

**SAR(1 g) = 1.01 W/kg; SAR(10 g) = 0.694 W/kg**

Maximum value of SAR (measured) = 1.08 W/kg

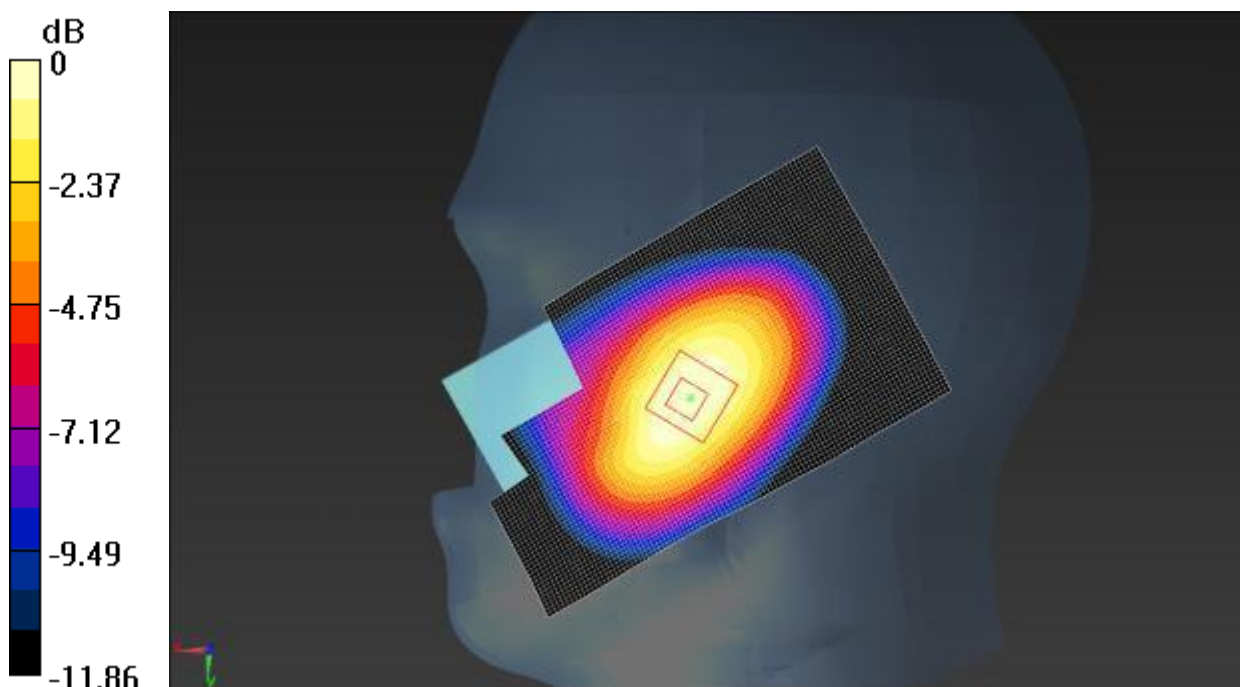

0 dB = 1.08 W/kg = 0.33 dBW/kg

**Fig. 7 GSM 850MHz CH251**

# GSM850 Head

Date/Time: 8/6/2014 2:05:35 PM

Electronics: DAE4 Sn786

Medium: 900head

Medium parameters used (interpolated):  $f = 824.2$  MHz;  $\sigma = 0.873$  S/m;  $\epsilon_r = 42.308$ ;  $\rho = 1000$  kg/m<sup>3</sup>

Ambient Temperature: 24.3°C      Liquid Temperature: 23.8°C

Communication System: GSM850 Frequency: 824.2 MHz Duty Cycle: 1:8.3

Probe: EX3DV4 - SN3633 ConvF(6.13, 6.13, 6.13); Calibrated: 10/31/2013

**Right Cheek Low/Area Scan (61x101x1):** Interpolated grid: dx=1.500 mm, dy=1.500 mm

Reference Value = 16.064 V/m; Power Drift = -0.18 dB

Maximum value of SAR (interpolated) = 1.22 W/kg

**Right Cheek Low/Zoom Scan (5x5x7)/Cube 0:** Measurement grid: dx=8mm, dy=8mm, dz=5mm

Reference Value = 16.064 V/m; Power Drift = -0.18 dB

Peak SAR (extrapolated) = 1.46 W/kg

**SAR(1 g) = 1.09 W/kg; SAR(10 g) = 0.753 W/kg**

Maximum value of SAR (measured) = 1.16 W/kg

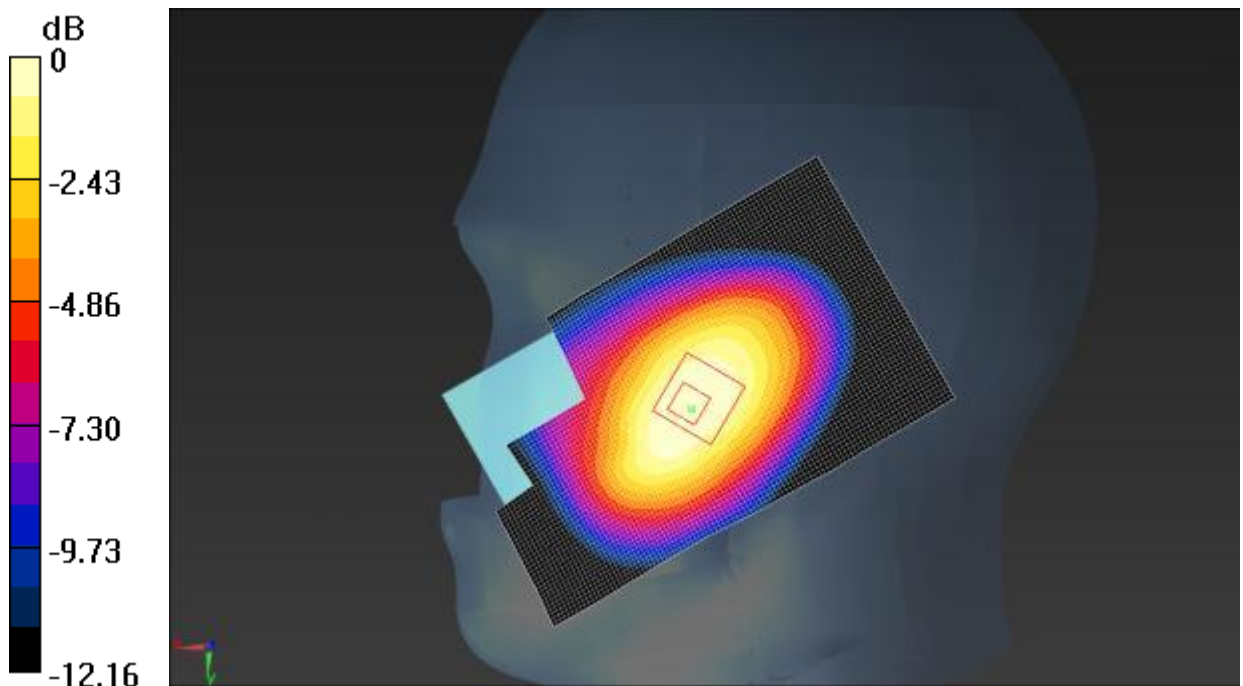

0 dB = 1.16 W/kg = 0.64 dBW/kg

**Fig. 8 GSM 850MHz CH128**

# GSM850 Head

Date/Time: 8/6/2014 2:22:09 PM

Electronics: DAE4 Sn786

Medium: 900head

Medium parameters used (interpolated):  $f = 836.6$  MHz;  $\sigma = 0.883$  S/m;  $\epsilon_r = 42.124$ ;  $\rho = 1000$  kg/m<sup>3</sup>

Ambient Temperature: 24.3°C      Liquid Temperature: 23.8°C

Communication System: GSM850 Frequency: 836.6 MHz Duty Cycle: 1:8.3

Probe: EX3DV4 - SN3633 ConvF(6.13, 6.13, 6.13); Calibrated: 10/31/2013

**Right Cheek Middle Repeat/Area Scan (61x101x1):** Interpolated grid: dx=1.500 mm, dy=1.500 mm

Reference Value = 15.877 V/m; Power Drift = -0.09 dB

Maximum value of SAR (interpolated) = 1.16 W/kg

**Right Cheek Middle Repeat/Zoom Scan (5x5x7)/Cube 0:** Measurement grid: dx=8mm, dy=8mm, dz=5mm

Reference Value = 15.877 V/m; Power Drift = -0.09 dB

Peak SAR (extrapolated) = 1.47 W/kg

**SAR(1 g) = 1.08 W/kg; SAR(10 g) = 0.742 W/kg**

Maximum value of SAR (measured) = 1.15 W/kg

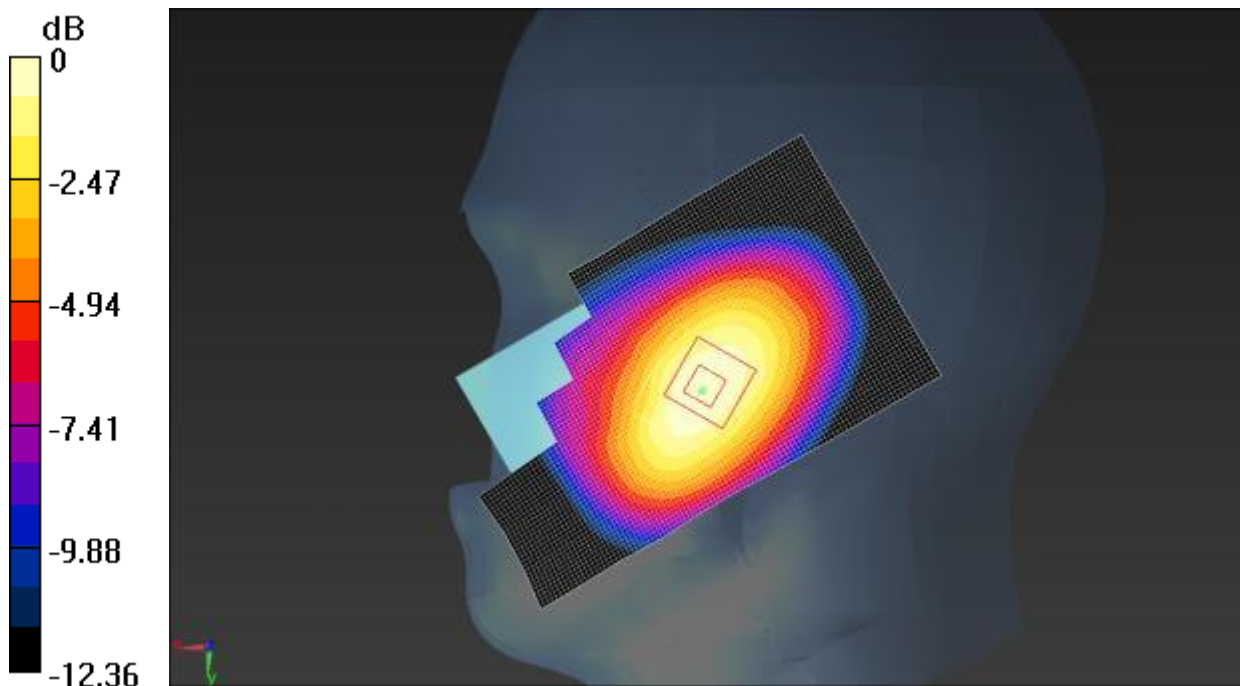

0 dB = 1.15 W/kg = 0.61 dBW/kg

**Fig. 9 GSM 850MHz CH190**

# GSM850 Body

Date/Time: 8/7/2014 11:10:55 AM

Electronics: DAE4 Sn786

Medium: Body 900

Medium parameters used (interpolated):  $f = 836.6$  MHz;  $\sigma = 0.995$  S/m;  $\epsilon_r = 55.704$ ;  $\rho = 1000$  kg/m<sup>3</sup>

Ambient Temperature: 23.5°C      Liquid Temperature: 23.0°C

Communication System: GPRS850 class 12 Frequency: 836.6 MHz Duty Cycle: 1:4

Probe: EX3DV4 - SN3633 ConvF(6.1, 6.1, 6.1); Calibrated: 10/31/2013

**Front Middle/Area Scan (61x101x1):** Interpolated grid: dx=1.500 mm, dy=1.500 mm

Reference Value = 30.332 V/m; Power Drift = -0.16 dB

Maximum value of SAR (interpolated) = 1.02 W/kg

**Front Middle/Zoom Scan (5x5x7)/Cube 0:** Measurement grid: dx=8mm, dy=8mm, dz=5mm

Reference Value = 30.332 V/m; Power Drift = -0.16 dB

Peak SAR (extrapolated) = 1.28 W/kg

**SAR(1 g) = 0.950 W/kg; SAR(10 g) = 0.656 W/kg**

Maximum value of SAR (measured) = 1.02 W/kg

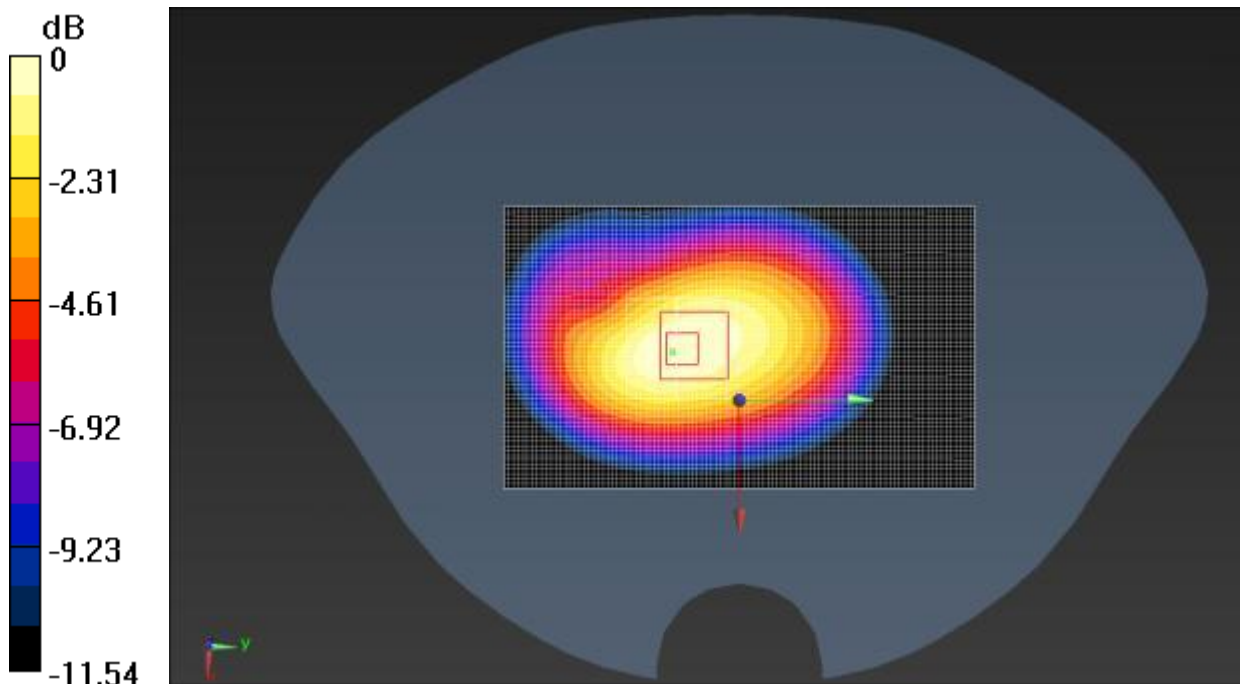

0 dB = 1.02 W/kg = 0.09 dBW/kg

**Fig. 10 GSM 850MHz CH190**



# GSM850 Body

Date/Time: 8/7/2014 2:21:03 PM

Electronics: DAE4 Sn786

Medium: Body 900

Medium parameters used (interpolated):  $f = 836.6$  MHz;  $\sigma = 0.995$  S/m;  $\epsilon_r = 55.704$ ;  $\rho = 1000$  kg/m<sup>3</sup>

Ambient Temperature: 23.5°C      Liquid Temperature: 23.0°C

Communication System: GPRS850 class 12 Frequency: 836.6 MHz Duty Cycle: 1:4

Probe: EX3DV4 - SN3633 ConvF(6.1, 6.1, 6.1); Calibrated: 10/31/2013

**Rear Middle/Area Scan (61x101x1):** Interpolated grid: dx=1.500 mm, dy=1.500 mm

Reference Value = 34.185 V/m; Power Drift = -0.04 dB

Maximum value of SAR (interpolated) = 1.31 W/kg

**Rear Middle/Zoom Scan (5x5x7)/Cube 0:** Measurement grid: dx=8mm, dy=8mm, dz=5mm

Reference Value = 34.185 V/m; Power Drift = -0.04 dB

Peak SAR (extrapolated) = 1.63 W/kg

**SAR(1 g) = 1.2 W/kg; SAR(10 g) = 0.830 W/kg**

Maximum value of SAR (measured) = 1.28 W/kg

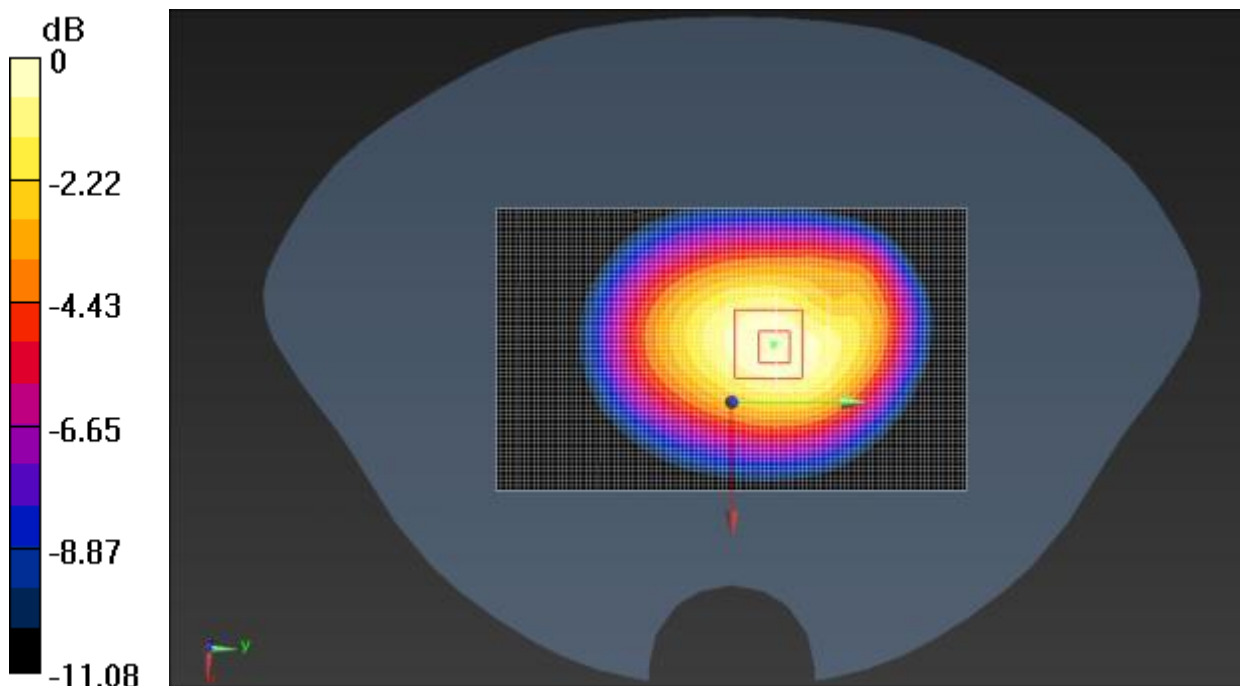

0 dB = 1.28 W/kg = 1.07 dBW/kg

**Fig. 11 GSM 850MHz CH190**

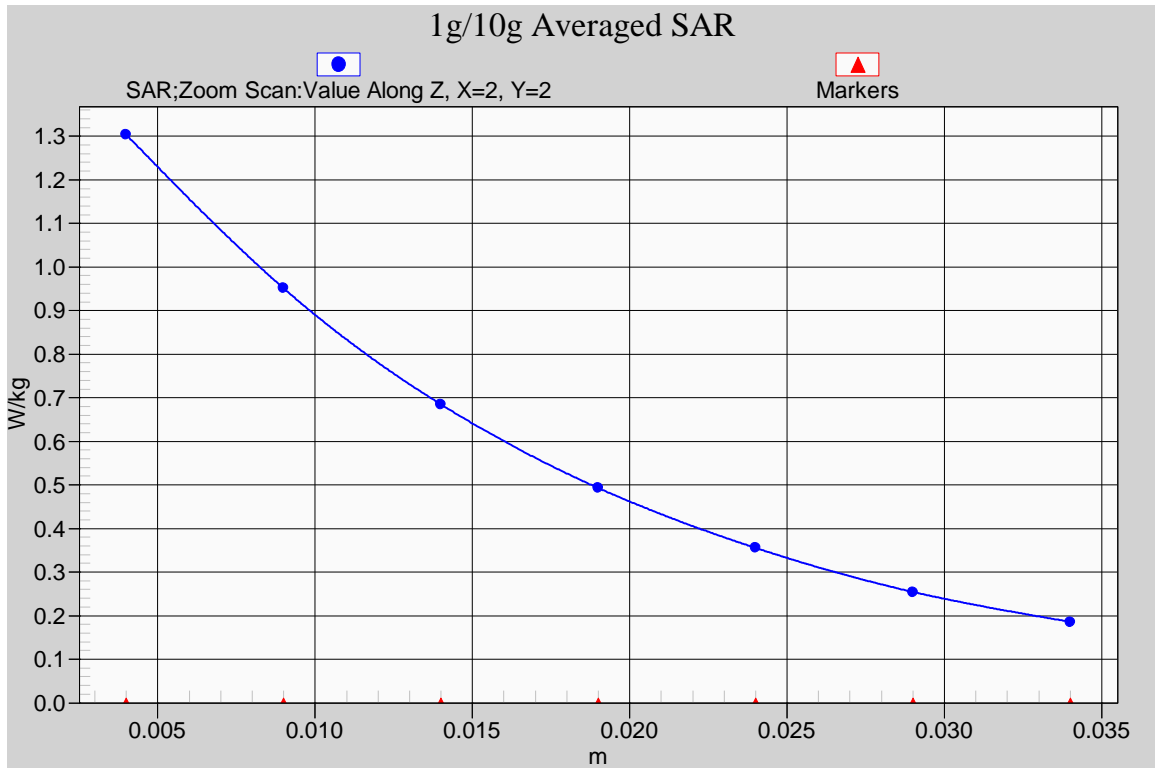

**Fig. 11-1 Z-Scan at power reference point (850MHz CH190)**

# GSM850 Body

Date/Time: 8/7/2014 11:25:32 AM

Electronics: DAE4 Sn786

Medium: Body 900

Medium parameters used (interpolated):  $f = 848.8$  MHz;  $\sigma = 1.01$  S/m;  $\epsilon_r = 55.686$ ;  $\rho = 1000$  kg/m<sup>3</sup>

Ambient Temperature: 23.5°C      Liquid Temperature: 23.0°C

Communication System: GPRS850 class 12 Frequency: 848.8 MHz Duty Cycle: 1:4

Probe: EX3DV4 - SN3633 ConvF(6.1, 6.1, 6.1); Calibrated: 10/31/2013

**Front High/Area Scan (61x101x1):** Interpolated grid: dx=1.500 mm, dy=1.500 mm

Reference Value = 26.405 V/m; Power Drift = 0.03 dB

Maximum value of SAR (interpolated) = 0.798 W/kg

**Front High/Zoom Scan (5x5x7)/Cube 0:** Measurement grid: dx=8mm, dy=8mm, dz=5mm

Reference Value = 26.405 V/m; Power Drift = 0.03 dB

Peak SAR (extrapolated) = 1.01 W/kg

**SAR(1 g) = 0.749 W/kg; SAR(10 g) = 0.517 W/kg**

Maximum value of SAR (measured) = 0.802 W/kg

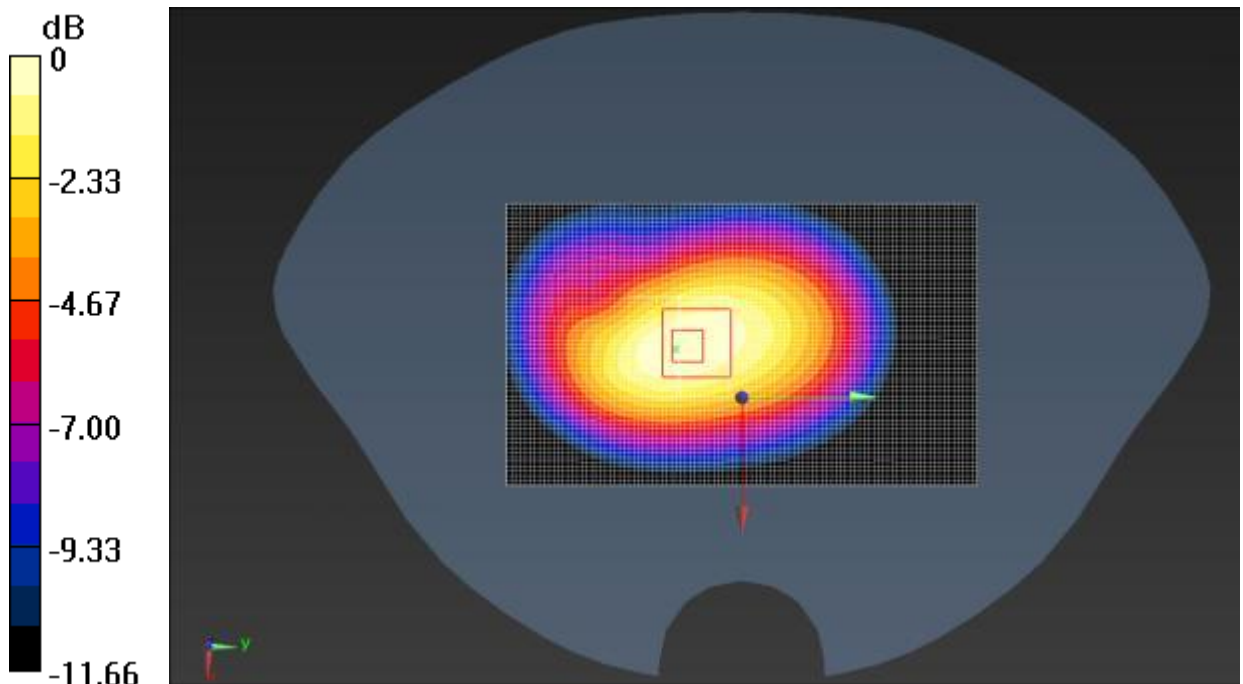

0 dB = 0.802 W/kg = -0.96 dBW/kg

**Fig. 12 GSM 850MHz CH251**

# GSM850 Body

Date/Time: 8/7/2014 11:39:55 AM

Electronics: DAE4 Sn786

Medium: Body 900

Medium parameters used (interpolated):  $f = 824.2$  MHz;  $\sigma = 0.977$  S/m;  $\epsilon_r = 55.768$ ;  $\rho = 1000$  kg/m<sup>3</sup>

Ambient Temperature: 23.5°C      Liquid Temperature: 23.0°C

Communication System: GPRS850 class 12 Frequency: 824.2 MHz Duty Cycle: 1:4

Probe: EX3DV4 - SN3633 ConvF(6.1, 6.1, 6.1); Calibrated: 10/31/2013

**Front Low/Area Scan (61x101x1):** Interpolated grid: dx=1.500 mm, dy=1.500 mm

Reference Value = 29.094 V/m; Power Drift = -0.04 dB

Maximum value of SAR (interpolated) = 0.942 W/kg

**Front Low/Zoom Scan (5x5x7)/Cube 0:** Measurement grid: dx=8mm, dy=8mm, dz=5mm

Reference Value = 29.094 V/m; Power Drift = -0.04 dB

Peak SAR (extrapolated) = 1.19 W/kg

**SAR(1 g) = 0.883 W/kg; SAR(10 g) = 0.611 W/kg**

Maximum value of SAR (measured) = 0.949 W/kg

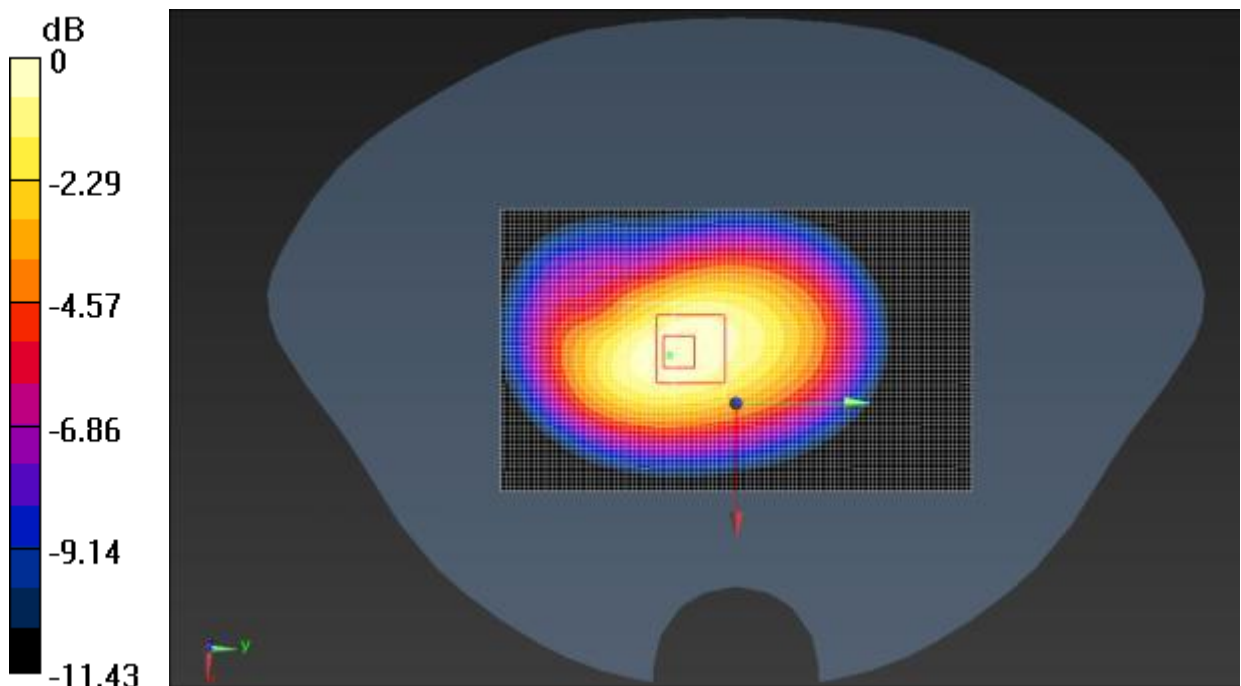

0 dB = 0.949 W/kg = -0.23 dBW/kg

**Fig. 13 GSM 850MHz CH128**

# GSM850 Body

Date/Time: 8/7/2014 2:34:57 PM

Electronics: DAE4 Sn786

Medium: Body 900

Medium parameters used (interpolated):  $f = 848.8$  MHz;  $\sigma = 1.01$  S/m;  $\epsilon_r = 55.686$ ;  $\rho = 1000$  kg/m<sup>3</sup>

Ambient Temperature: 23.5°C      Liquid Temperature: 23.0°C

Communication System: GPRS850 class 12 Frequency: 848.8 MHz Duty Cycle: 1:4

Probe: EX3DV4 - SN3633 ConvF(6.1, 6.1, 6.1); Calibrated: 10/31/2013

**Rear High/Area Scan (61x101x1):** Interpolated grid: dx=1.500 mm, dy=1.500 mm

Reference Value = 32.786 V/m; Power Drift = 0.03 dB

Maximum value of SAR (interpolated) = 1.22 W/kg

**Rear High/Zoom Scan (5x5x7)/Cube 0:** Measurement grid: dx=8mm, dy=8mm, dz=5mm

Reference Value = 32.786 V/m; Power Drift = 0.03 dB

Peak SAR (extrapolated) = 1.57 W/kg

**SAR(1 g) = 1.15 W/kg; SAR(10 g) = 0.785 W/kg**

Maximum value of SAR (measured) = 1.23 W/kg

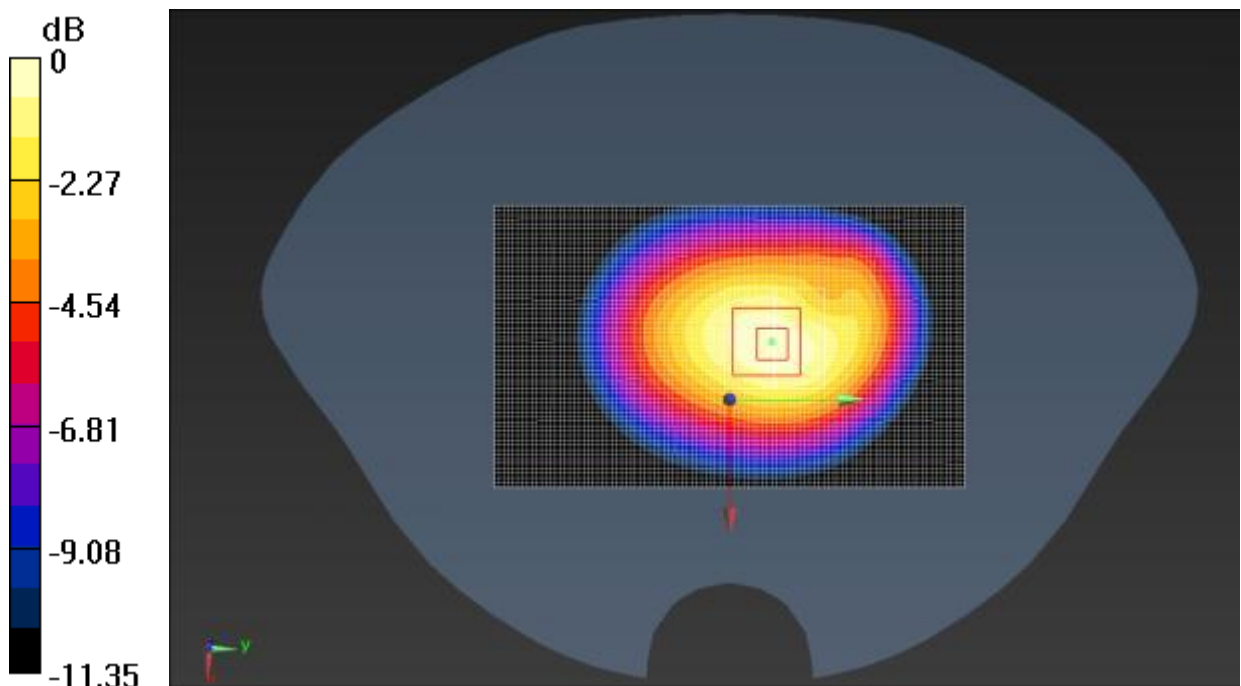

0 dB = 1.23 W/kg = 0.90 dBW/kg

**Fig. 14 GSM 850MHz CH251**

# GSM850 Body

Date/Time: 8/7/2014 2:48:44 PM

Electronics: DAE4 Sn786

Medium: Body 900

Medium parameters used (interpolated):  $f = 824.2$  MHz;  $\sigma = 0.977$  S/m;  $\epsilon_r = 55.768$ ;  $\rho = 1000$  kg/m<sup>3</sup>

Ambient Temperature: 23.5°C      Liquid Temperature: 23.0°C

Communication System: GPRS850 class 12 Frequency: 824.2 MHz Duty Cycle: 1:4

Probe: EX3DV4 - SN3633 ConvF(6.1, 6.1, 6.1); Calibrated: 10/31/2013

**Rear Low/Area Scan (61x101x1):** Interpolated grid: dx=1.500 mm, dy=1.500 mm

Reference Value = 31.606 V/m; Power Drift = -0.02 dB

Maximum value of SAR (interpolated) = 1.10 W/kg

**Rear Low/Zoom Scan (5x5x7)/Cube 0:** Measurement grid: dx=8mm, dy=8mm, dz=5mm

Reference Value = 31.606 V/m; Power Drift = -0.02 dB

Peak SAR (extrapolated) = 1.38 W/kg

**SAR(1 g) = 1.01 W/kg; SAR(10 g) = 0.703 W/kg**

Maximum value of SAR (measured) = 1.08 W/kg

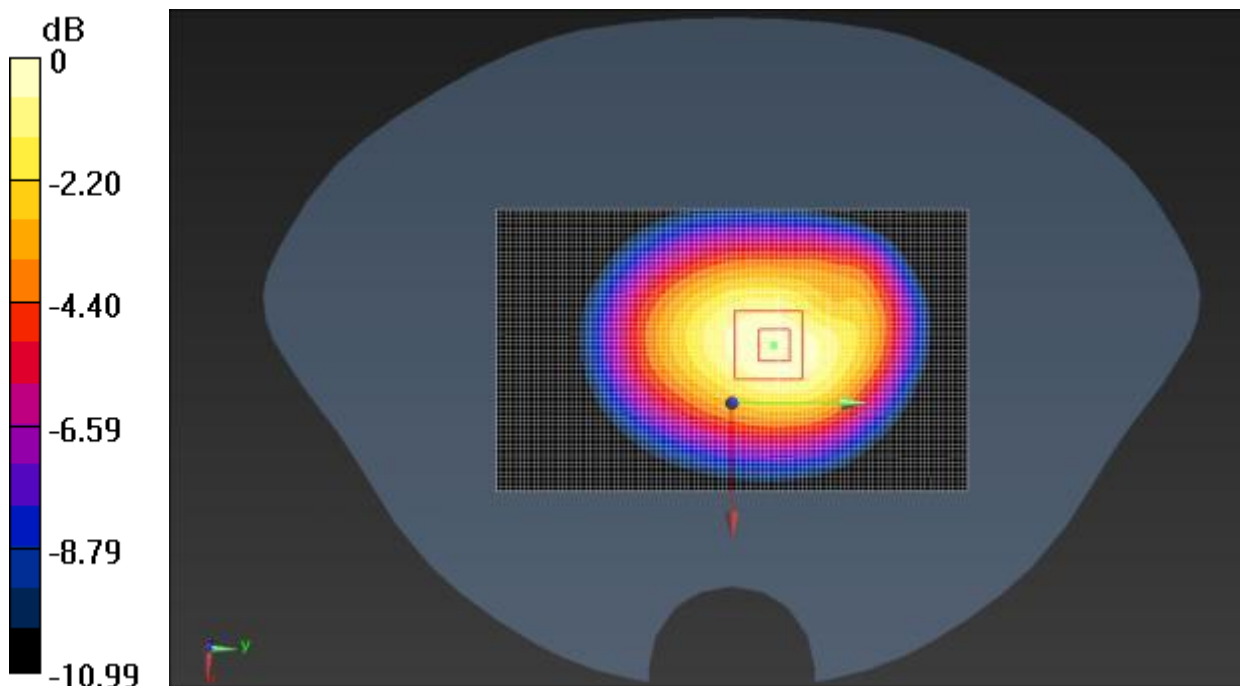

0 dB = 1.08 W/kg = 0.33 dBW/kg

**Fig. 15 GSM 850MHz CH128**

# GSM 850 body

Date/Time: 8/7/2014 11:02:23 AM

Electronics: DAE4 Sn786

Medium: Body 900

Medium parameters used (interpolated):  $f = 836.6$  MHz;  $\sigma = 0.995$  S/m;  $\epsilon_r = 55.704$ ;  $\rho = 1000$  kg/m<sup>3</sup>

Ambient Temperature: 23.5°C      Liquid Temperature: 23.0°C

Communication System: GSM Frequency: 836.6 MHz Duty Cycle: 1:8.30042

Probe: EX3DV4 - SN3633 ConvF(9.52, 9.52, 9.52); Calibrated: 10/24/2013

**Rear side Middle/Area Scan (41x81x1):** Interpolated grid: dx=1.500 mm, dy=1.500 mm

Reference Value = 27.955 V/m; Power Drift = 0.02 dB

Maximum value of SAR (interpolated) = 0.923 W/kg

**Rear side Middle/Zoom Scan (5x5x7)/Cube 0:** Measurement grid: dx=8mm, dy=8mm, dz=5mm

Reference Value = 27.955 V/m; Power Drift = 0.02 dB

Peak SAR (extrapolated) = 1.17 W/kg

**SAR(1 g) = 0.873 W/kg; SAR(10 g) = 0.615 W/kg**

Maximum value of SAR (measured) = 0.930 W/kg

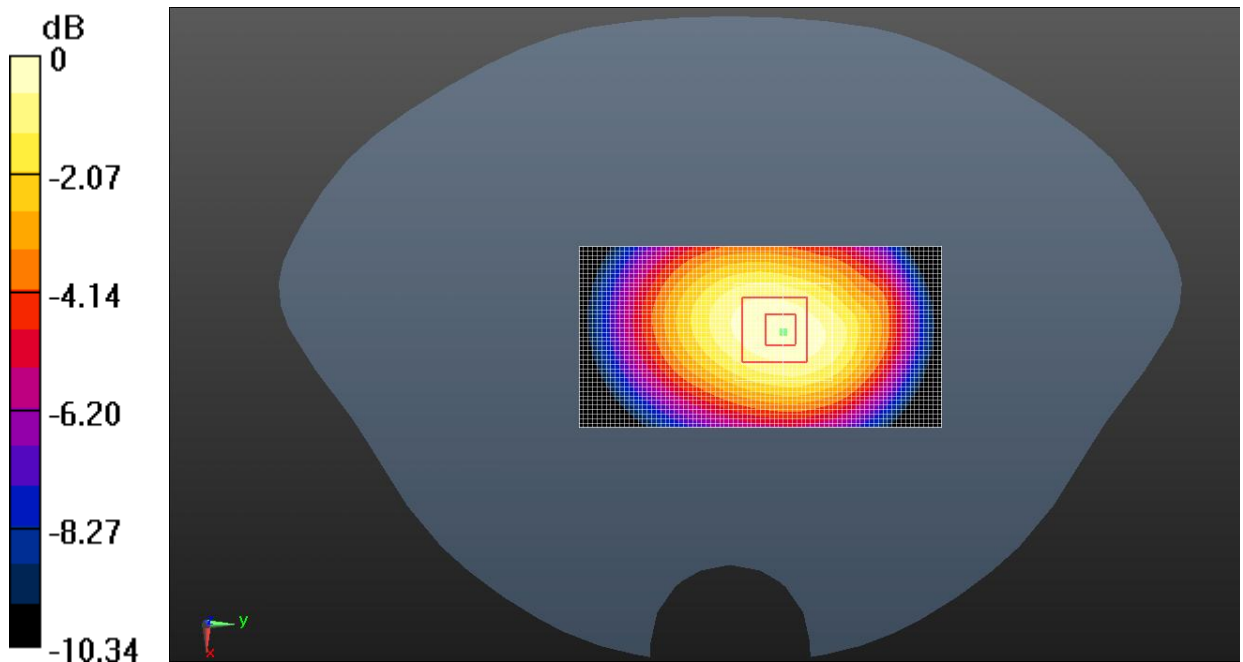

0 dB = 0.930 W/kg = -0.32 dBW/kg

Fig. 16 GSM 850MHz CH190

# GSM850 Body

Date/Time: 8/7/2014 3:02:54 PM

Electronics: DAE4 Sn786

Medium: Body 900

Medium parameters used (interpolated):  $f = 836.6$  MHz;  $\sigma = 0.995$  S/m;  $\epsilon_r = 55.704$ ;  $\rho = 1000$  kg/m<sup>3</sup>

Ambient Temperature: 23.5°C      Liquid Temperature: 23.0°C

Communication System: GPRS850 class 12 Frequency: 836.6 MHz Duty Cycle: 1:4

Probe: EX3DV4 - SN3633 ConvF(6.1, 6.1, 6.1); Calibrated: 10/31/2013

**Rear Middle Repeat /Area Scan (61x101x1):** Interpolated grid: dx=1.500 mm, dy=1.500 mm

Reference Value = 33.879 V/m; Power Drift = 0.04 dB

Maximum value of SAR (interpolated) = 1.31 W/kg

**Rear Middle Repeat/Zoom Scan (5x5x7)/Cube 0:** Measurement grid: dx=8mm, dy=8mm, dz=5mm

Reference Value = 33.879 V/m; Power Drift = 0.04 dB

Peak SAR (extrapolated) = 1.65 W/kg

**SAR(1 g) = 1.18 W/kg; SAR(10 g) = 0.838 W/kg**

Maximum value of SAR (measured) = 1.30 W/kg

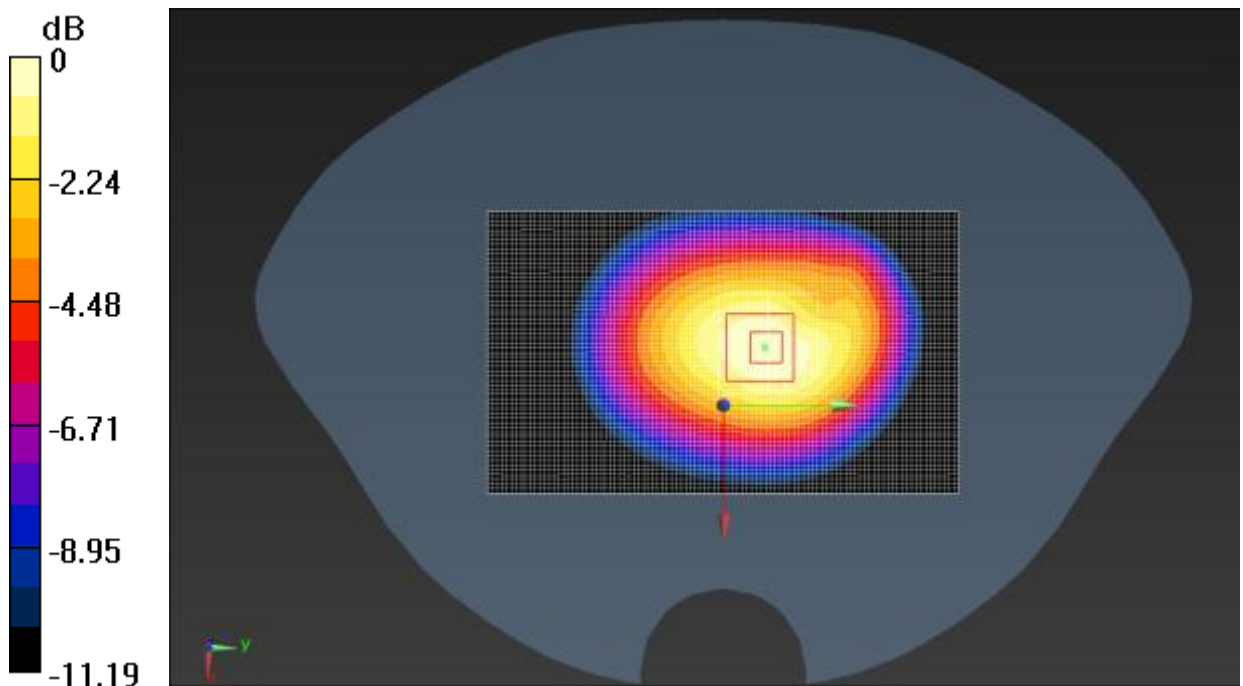

0 dB = 1.30 W/kg = 1.14 dBW/kg

Fig. 17 GSM 850MHz CH190



# GSM1900 Head

Date/Time: 8/6/2014 4:38:16 PM

Electronics: DAE4 Sn786

Medium: 1900head

Medium parameters used:  $f = 1880$  MHz;  $\sigma = 1.454$  S/m;  $\epsilon_r = 39.355$ ;  $\rho = 1000$  kg/m<sup>3</sup>

Ambient Temperature: 24.3°C      Liquid Temperature: 23.8°C

Communication System: PCS 1900 Frequency: 1880 MHz Duty Cycle: 1:8.3

Probe: EX3DV4 - SN3633 ConvF(4.99, 4.99, 4.99); Calibrated: 10/31/2013

**Left Cheek Middle/Area Scan (61x101x1):** Interpolated grid: dx=1.500 mm, dy=1.500 mm

Reference Value = 5.502 V/m; Power Drift = -0.13 dB

Maximum value of SAR (interpolated) = 0.275 W/kg

**Left Cheek Middle/Zoom Scan (5x5x7)/Cube 0:** Measurement grid: dx=8mm, dy=8mm, dz=5mm

Reference Value = 5.502 V/m; Power Drift = -0.13 dB

Peak SAR (extrapolated) = 0.339 W/kg

**SAR(1 g) = 0.244 W/kg; SAR(10 g) = 0.158 W/kg**

Maximum value of SAR (measured) = 0.259 W/kg

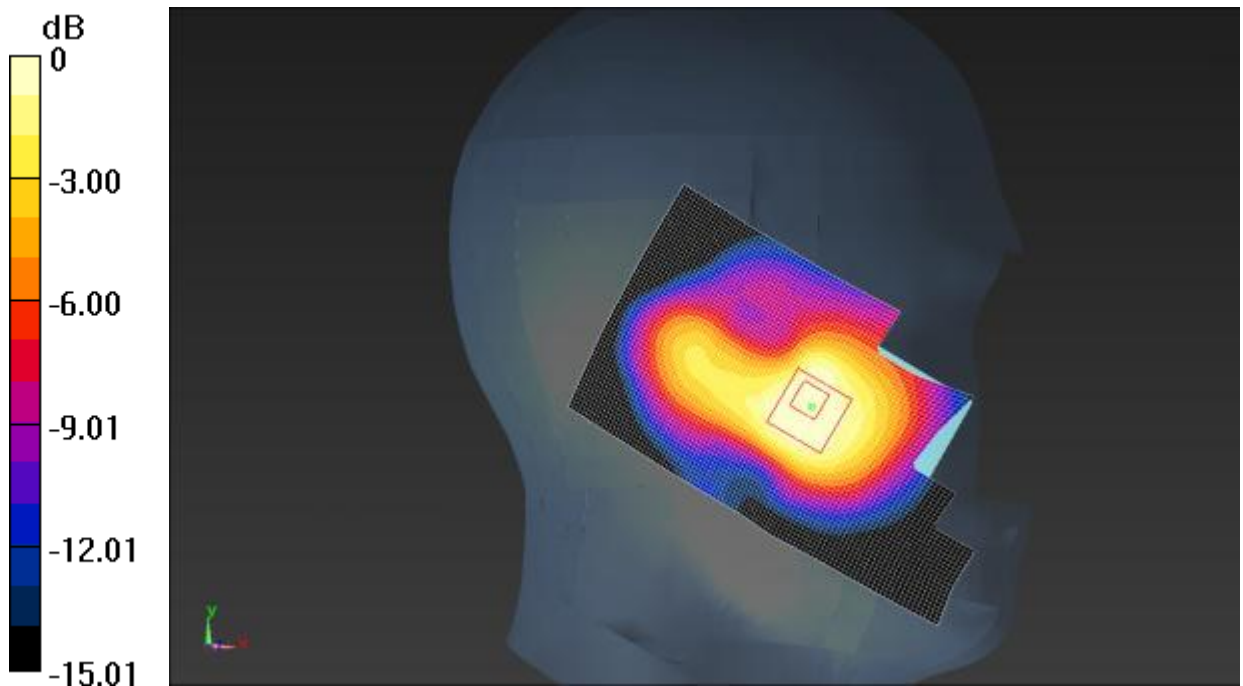

0 dB = 0.259 W/kg = -5.87 dBW/kg

**Fig. 18 GSM 1900MHz CH661**

# GSM1900 Head

Date/Time: 8/6/2014 4:55:11 PM

Electronics: DAE4 Sn786

Medium: 1900head

Medium parameters used:  $f = 1880$  MHz;  $\sigma = 1.454$  S/m;  $\epsilon_r = 39.355$ ;  $\rho = 1000$  kg/m<sup>3</sup>

Ambient Temperature: 24.3°C      Liquid Temperature: 23.8°C

Communication System: PCS 1900 Frequency: 1880 MHz Duty Cycle: 1:8.3

Probe: EX3DV4 - SN3633 ConvF(4.99, 4.99, 4.99); Calibrated: 10/31/2013

**Left Tilt Middle/Area Scan (61x101x1):** Interpolated grid: dx=1.500 mm, dy=1.500 mm

Reference Value = 5.831 V/m; Power Drift = -0.13 dB

Maximum value of SAR (interpolated) = 0.0793 W/kg

**Left Tilt Middle/Zoom Scan (5x5x7)/Cube 0:** Measurement grid: dx=8mm, dy=8mm, dz=5mm

Reference Value = 5.831 V/m; Power Drift = -0.13dB

Peak SAR (extrapolated) = 0.0950 W/kg

**SAR(1 g) = 0.067 W/kg; SAR(10 g) = 0.042 W/kg**

Maximum value of SAR (measured) = 0.0730 W/kg

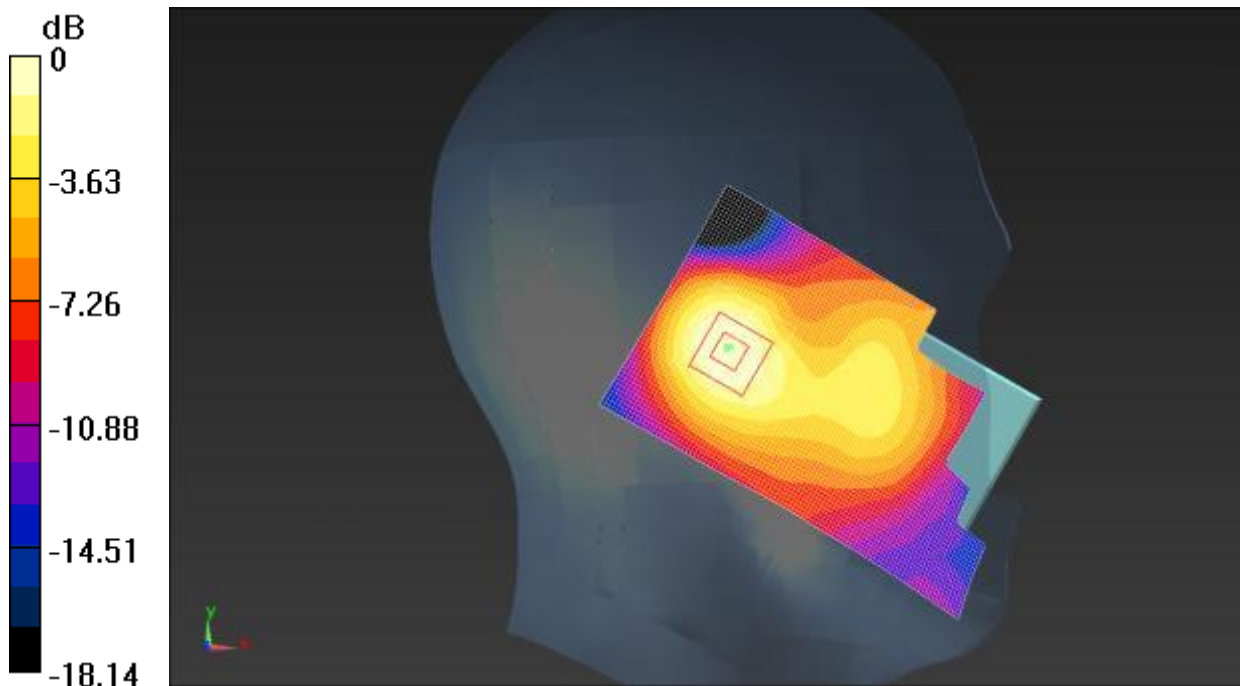

0 dB = 0.0730 W/kg = -11.37 dBW/kg

**Fig. 19 GSM 1900MHz CH661**

# GSM1900 Head

Date/Time: 8/6/2014 5:13:46 PM

Electronics: DAE4 Sn786

Medium: 1900head

Medium parameters used:  $f = 1880$  MHz;  $\sigma = 1.454$  S/m;  $\epsilon_r = 39.355$ ;  $\rho = 1000$  kg/m<sup>3</sup>

Ambient Temperature: 24.3°C      Liquid Temperature: 23.8°C

Communication System: PCS 1900 Frequency: 1880 MHz Duty Cycle: 1:8.3

Probe: EX3DV4 - SN3633 ConvF(4.99, 4.99, 4.99); Calibrated: 10/31/2013

**Right Cheek Middle/Area Scan (61x101x1):** Interpolated grid: dx=1.500 mm, dy=1.500 mm

Reference Value = 7.231 V/m; Power Drift = 0.13 dB

Maximum value of SAR (interpolated) = 0.389 W/kg

**Right Cheek Middle/Zoom Scan (5x5x7)/Cube 0:** Measurement grid: dx=8mm, dy=8mm, dz=5mm

Reference Value = 7.231 V/m; Power Drift = 0.13 dB

Peak SAR (extrapolated) = 0.496 W/kg

**SAR(1 g) = 0.336 W/kg; SAR(10 g) = 0.202 W/kg**

Maximum value of SAR (measured) = 0.358 W/kg

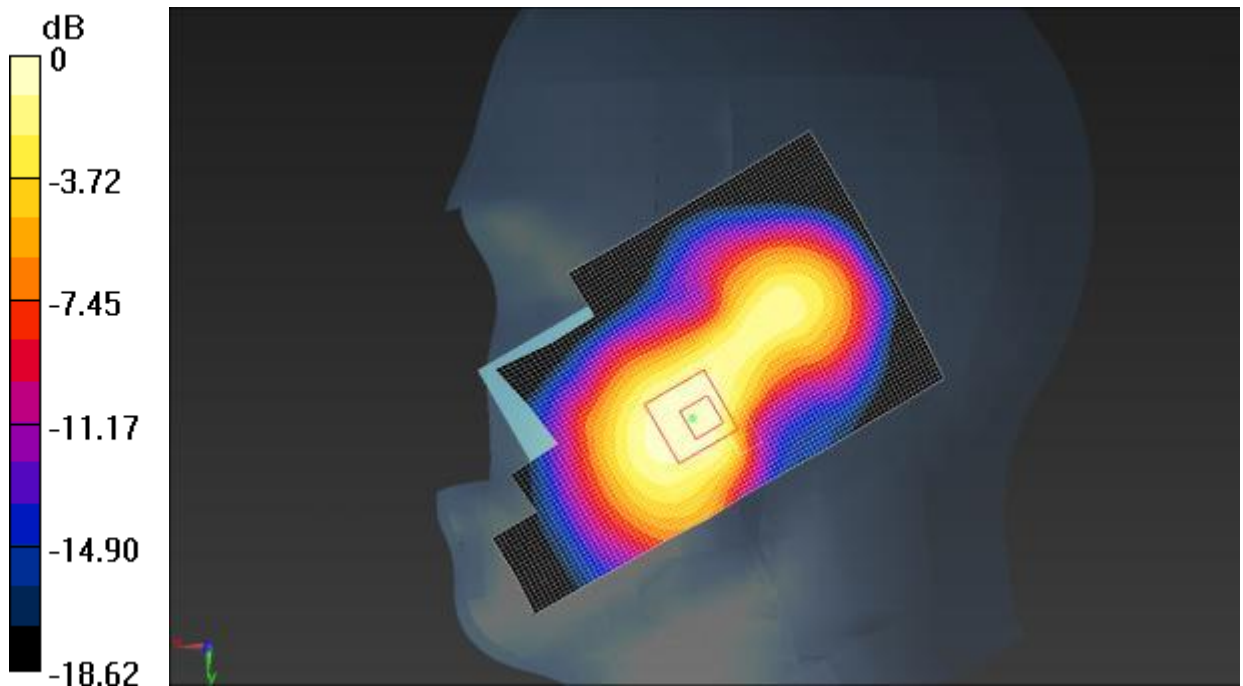

0 dB = 0.358 W/kg = -4.46 dBW/kg

Fig. 20 GSM 1900MHz CH661

# GSM1900 Head

Date/Time: 8/6/2014 5:56:33 PM

Electronics: DAE4 Sn786

Medium: 1900head

Medium parameters used:  $f = 1880$  MHz;  $\sigma = 1.454$  S/m;  $\epsilon_r = 39.355$ ;  $\rho = 1000$  kg/m<sup>3</sup>

Ambient Temperature: 24.3°C      Liquid Temperature: 23.8°C

Communication System: PCS 1900 Frequency: 1880 MHz Duty Cycle: 1:8.3

Probe: EX3DV4 - SN3633 ConvF(4.99, 4.99, 4.99); Calibrated: 10/31/2013

**Right Tilt Middle/Area Scan (61x101x1):** Interpolated grid: dx=1.500 mm, dy=1.500 mm

Reference Value = 7.756 V/m; Power Drift = 0.13 dB

Maximum value of SAR (interpolated) = 0.122 W/kg

**Right Tilt Middle/Zoom Scan (5x5x7)/Cube 0:** Measurement grid: dx=8mm, dy=8mm, dz=5mm

Reference Value = 7.756 V/m; Power Drift = 0.13 dB

Peak SAR (extrapolated) = 0.160 W/kg

**SAR(1 g) = 0.112 W/kg; SAR(10 g) = 0.067 W/kg**

Maximum value of SAR (measured) = 0.116 W/kg

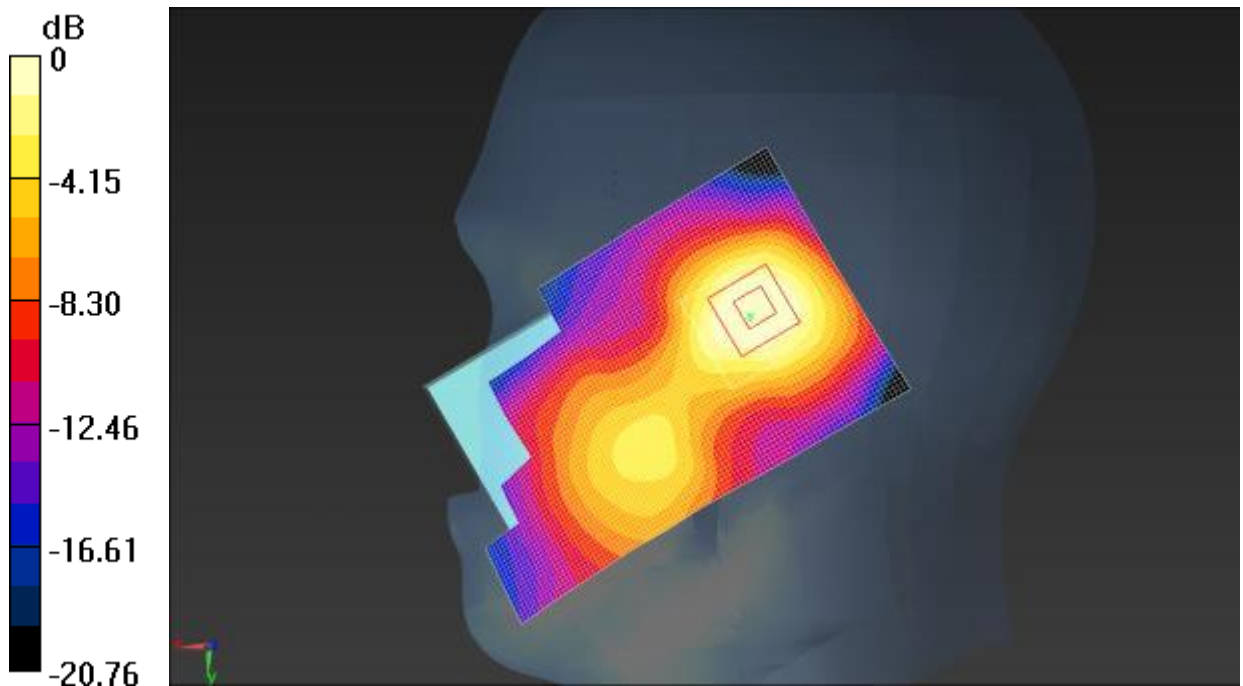

0 dB = 0.116 W/kg = -9.36 dBW/kg

**Fig. 21 GSM 1900MHz CH661**

# GSM1900 Head

Date/Time: 8/6/2014 5:28:00 PM

Electronics: DAE4 Sn786

Medium: 1900head

Medium parameters used:  $f = 1910$  MHz;  $\sigma = 1.472$  S/m;  $\epsilon_r = 39.043$ ;  $\rho = 1000$  kg/m<sup>3</sup>

Ambient Temperature: 24.3°C      Liquid Temperature: 23.8°C

Communication System: PCS 1900 Frequency: 1909.8 MHz Duty Cycle: 1:8.3

Probe: EX3DV4 - SN3633 ConvF(4.99, 4.99, 4.99); Calibrated: 10/31/2013

**Right Cheek High/Area Scan (61x101x1):** Interpolated grid: dx=1.500 mm, dy=1.500 mm

Reference Value = 8.319 V/m; Power Drift = 0.15 dB

Maximum value of SAR (interpolated) = 0.430 W/kg

**Right Cheek High/Zoom Scan (5x5x7)/Cube 0:** Measurement grid: dx=8mm, dy=8mm, dz=5mm

Reference Value = 8.319 V/m; Power Drift = 0.15 dB

Peak SAR (extrapolated) = 0.557 W/kg

**SAR(1 g) = 0.369 W/kg; SAR(10 g) = 0.221 W/kg**

Maximum value of SAR (measured) = 0.396 W/kg

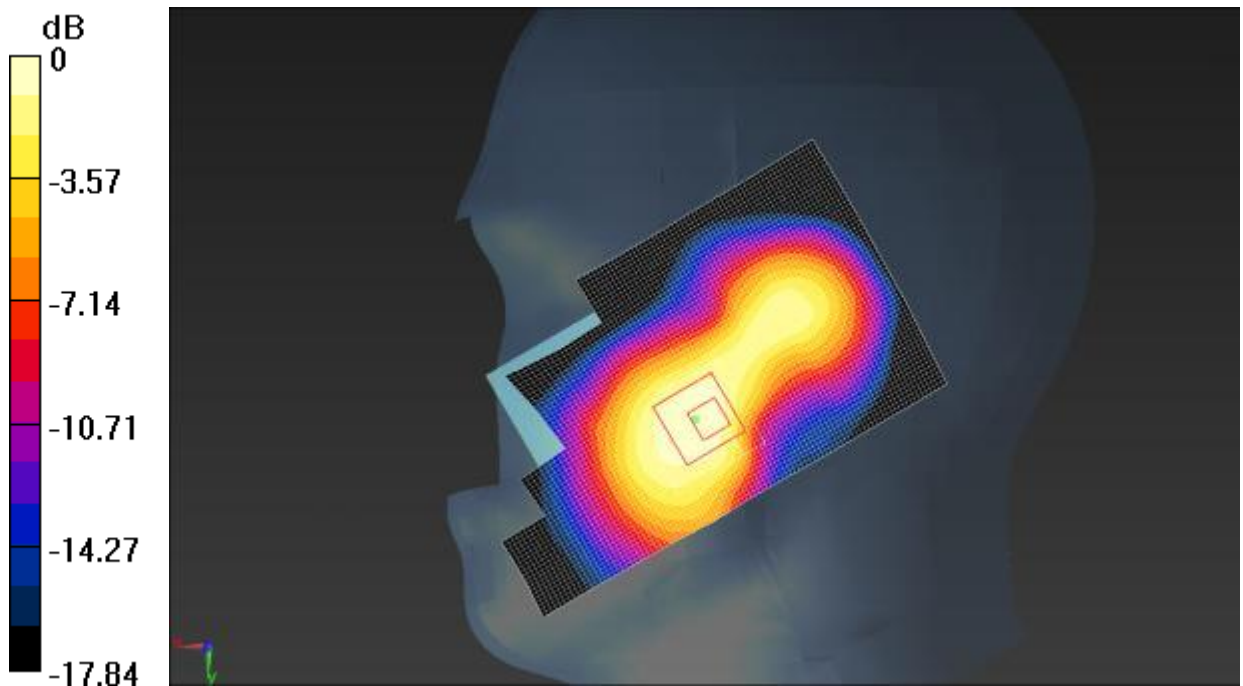

0 dB = 0.396 W/kg = -4.02 dBW/kg

Fig. 22 GSM 1900MHz CH810

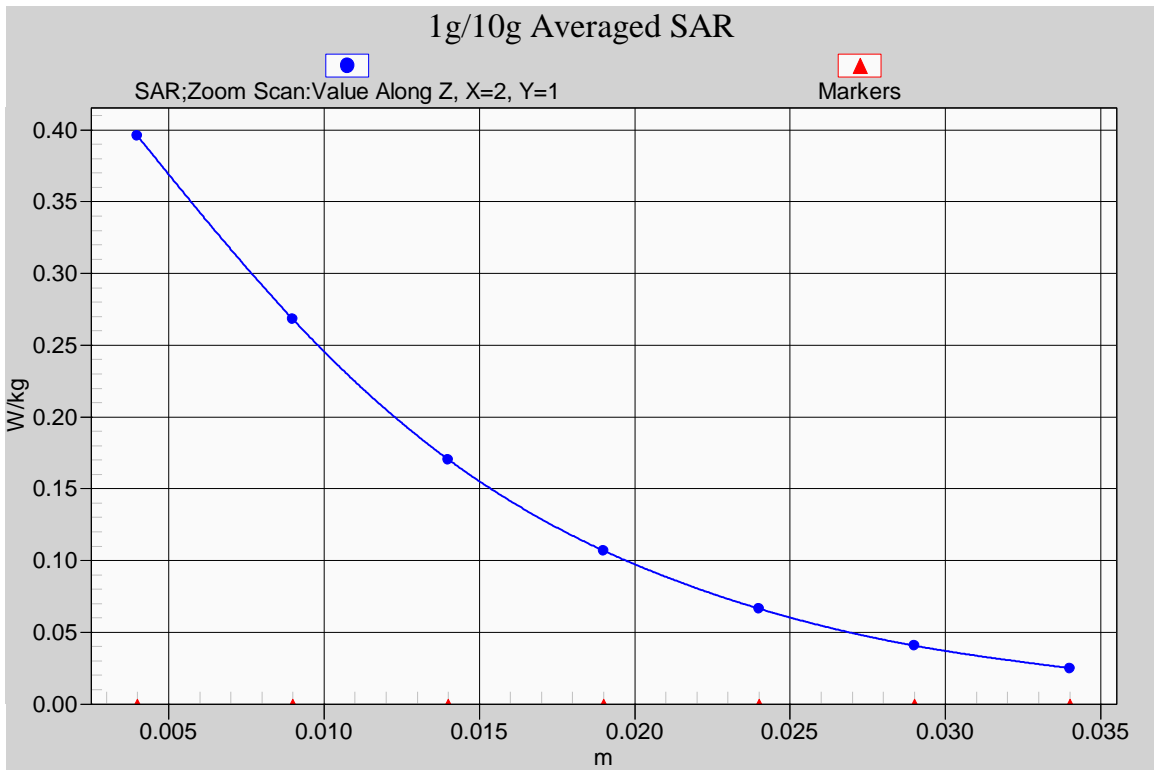

Fig. 22-1 Z-Scan at power reference point (1900MHz CH810)

# GSM1900 Head

Date/Time: 8/6/2014 5:42:18 PM

Electronics: DAE4 Sn786

Medium: 1900head

Medium parameters used (interpolated):  $f = 1850.2$  MHz;  $\sigma = 1.432$  S/m;  $\epsilon_r = 39.252$ ;  $\rho = 1000$  kg/m<sup>3</sup>

Ambient Temperature: 24.3°C      Liquid Temperature: 23.8°C

Communication System: PCS 1900 Frequency: 1850.2 MHz Duty Cycle: 1:8.3

Probe: ES3DV3 - SN3151 ConvF(5.21, 5.21, 5.21); Calibrated: 7/31/2013

**Right Cheek Low/Area Scan (61x101x1):** Interpolated grid: dx=1.500 mm, dy=1.500 mm

Reference Value = 6.706 V/m; Power Drift = -0.01 dB

Maximum value of SAR (interpolated) = 0.340 W/kg

**Right Cheek Low/Zoom Scan (5x5x7)/Cube 0:** Measurement grid: dx=8mm, dy=8mm, dz=5mm

Reference Value = 6.706 V/m; Power Drift = -0.01 dB

Peak SAR (extrapolated) = 0.441 W/kg

**SAR(1 g) = 0.298 W/kg; SAR(10 g) = 0.176 W/kg**

Maximum value of SAR (measured) = 0.322 W/kg

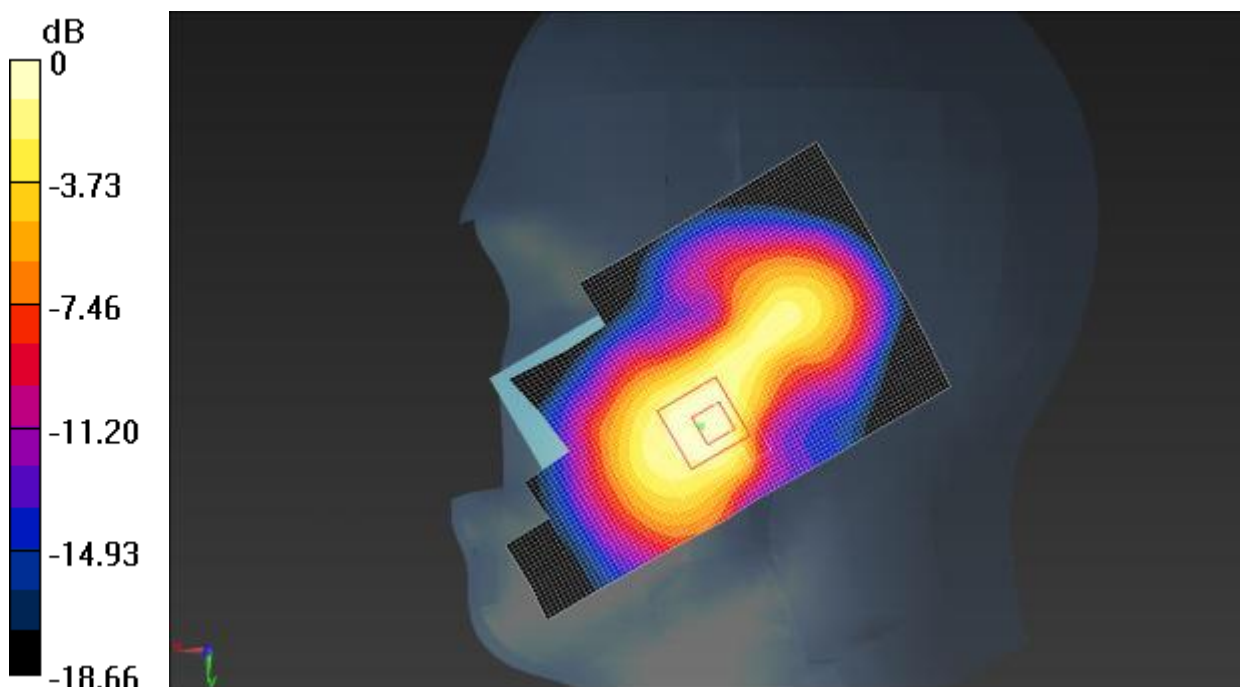

0 dB = 0.322 W/kg = -4.92 dBW/kg

Fig. 23 GSM 1900MHz CH512

# GSM1900 Body

Date/Time: 8/7/2014 9:57:20 AM

Electronics: DAE4 Sn786

Medium: Body 1900MHz

Medium parameters used:  $f = 1880$  MHz;  $\sigma = 1.494$  S/m;  $\epsilon_r = 52.663$ ;  $\rho = 1000$  kg/m<sup>3</sup>

Ambient Temperature: 24.2°C      Liquid Temperature: 23.7°C

Communication System: GPRS 1900 class 12 Frequency: 1880 MHz Duty Cycle: 1:2.67

Probe: EX3DV4 - SN3633 ConvF(4.83, 4.83, 4.83); Calibrated: 10/31/2013

**Front Middle/Area Scan (61x101x1):** Interpolated grid: dx=1.500 mm, dy=1.500 mm

Reference Value = 5.822 V/m; Power Drift = 0.11 dB

Maximum value of SAR (interpolated) = 0.143 W/kg

**Front Middle/Zoom Scan (5x5x7)/Cube 0:** Measurement grid: dx=8mm, dy=8mm, dz=5mm

Reference Value = 5.822 V/m; Power Drift = 0.11 dB

Peak SAR (extrapolated) = 0.203 W/kg

**SAR(1 g) = 0.129 W/kg; SAR(10 g) = 0.077 W/kg**

Maximum value of SAR (measured) = 0.141 W/kg

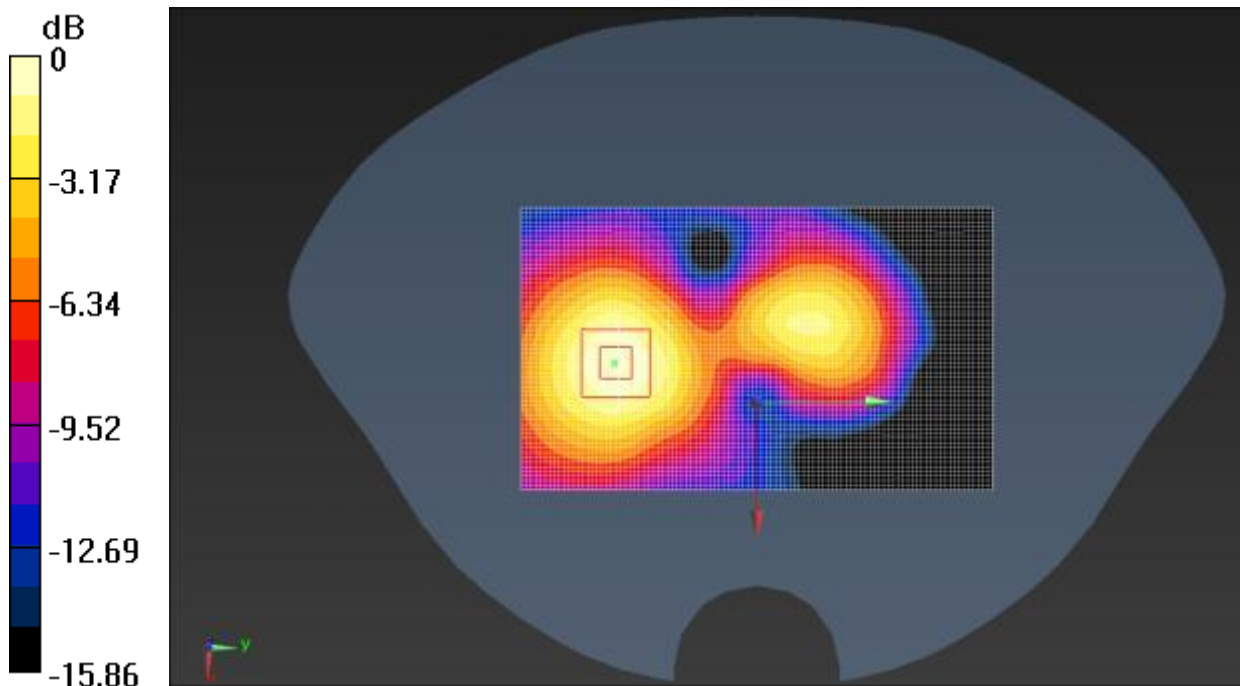

0 dB = 0.141 W/kg = -8.51 dBW/kg

Fig. 24 GSM 1900MHz CH661



# GSM1900 Body

Date/Time: 8/7/2014 10:11:25 AM

Electronics: DAE4 Sn786

Medium: Body 1900MHz

Medium parameters used:  $f = 1880$  MHz;  $\sigma = 1.494$  S/m;  $\epsilon_r = 52.663$ ;  $\rho = 1000$  kg/m<sup>3</sup>

Ambient Temperature: 24.2°C      Liquid Temperature: 23.7°C

Communication System: GPRS 1900 class 12 Frequency: 1880 MHz Duty Cycle: 1:2.67

Probe: EX3DV4 - SN3633 ConvF(4.83, 4.83, 4.83); Calibrated: 10/31/2013

**Rear Middle/Area Scan (61x101x1):** Interpolated grid: dx=1.500 mm, dy=1.500 mm

Reference Value = 15.413 V/m; Power Drift = -0.14 dB

Maximum value of SAR (interpolated) = 0.471 W/kg

**Rear Middle/Zoom Scan (5x5x7)/Cube 0:** Measurement grid: dx=8mm, dy=8mm, dz=5mm

Reference Value = 15.413 V/m; Power Drift = -0.14 dB

Peak SAR (extrapolated) = 0.629 W/kg

**SAR(1 g) = 0.414 W/kg; SAR(10 g) = 0.246 W/kg**

Maximum value of SAR (measured) = 0.432 W/kg

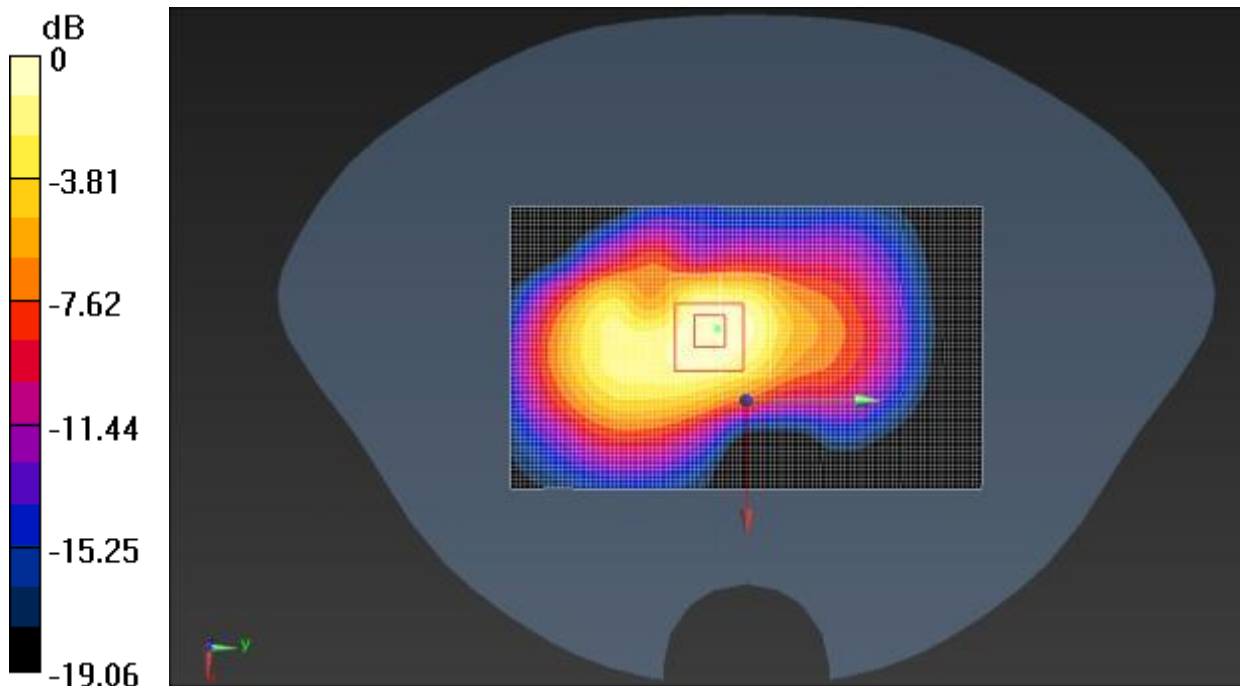

0 dB = 0.432 W/kg = -3.65 dBW/kg

Fig. 25 GSM 1900MHz CH661

# GSM1900 Body

Date/Time: 8/7/2014 10:25:42 AM

Electronics: DAE4 Sn786

Medium: Body 1900MHz

Medium parameters used:  $f = 1910$  MHz;  $\sigma = 1.522$  S/m;  $\epsilon_r = 52.593$ ;  $\rho = 1000$  kg/m<sup>3</sup>

Ambient Temperature: 24.2°C      Liquid Temperature: 23.7°C

Communication System: GPRS 1900 class 12 Frequency: 1909.8 MHz Duty Cycle: 1:2.67

Probe: EX3DV4 - SN3633 ConvF(4.83, 4.83, 4.83); Calibrated: 10/31/2013

**Rear High/Area Scan (61x101x1):** Interpolated grid: dx=1.500 mm, dy=1.500 mm

Reference Value = 10.993 V/m; Power Drift = 0.13 dB

Maximum value of SAR (interpolated) = 0.398 W/kg

**Rear High/Zoom Scan (5x5x7)/Cube 0:** Measurement grid: dx=8mm, dy=8mm, dz=5mm

Reference Value = 10.993 V/m; Power Drift = 0.13 dB

Peak SAR (extrapolated) = 0.539 W/kg

**SAR(1 g) = 0.349 W/kg; SAR(10 g) = 0.216 W/kg**

Maximum value of SAR (measured) = 0.395 W/kg

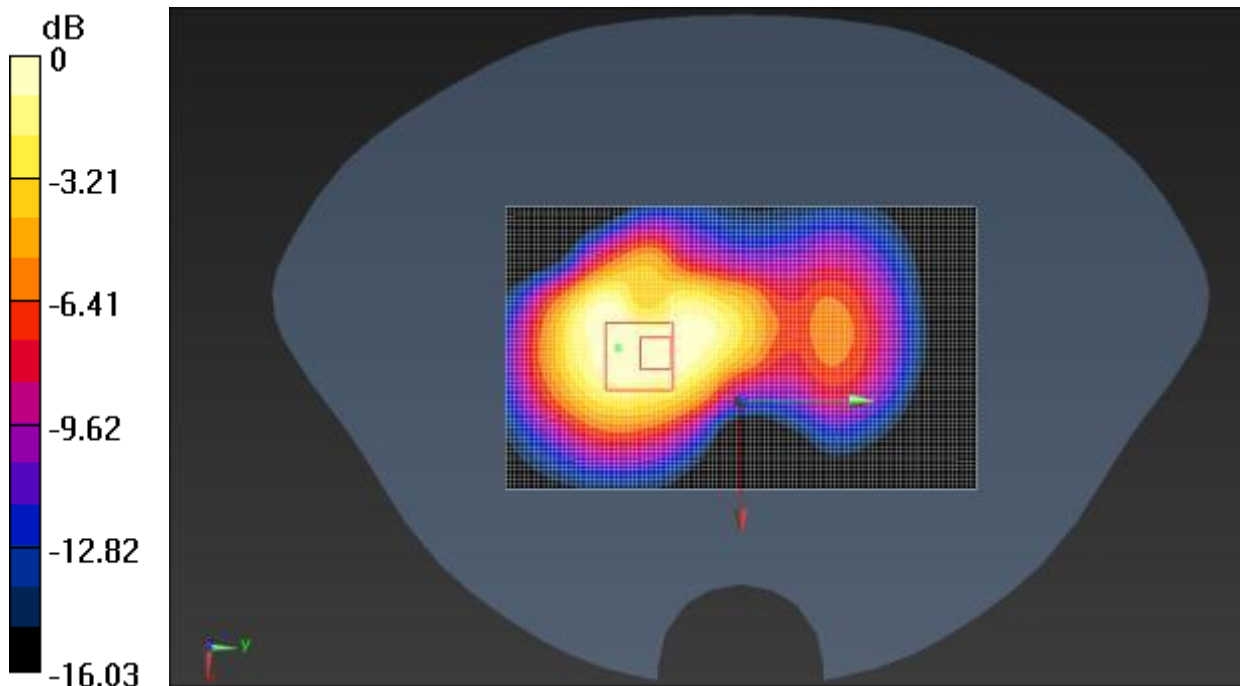

0 dB = 0.395 W/kg = -4.03 dBW/kg

Fig. 26 GSM 1900MHz CH810

# GSM1900 Body

Date/Time: 8/7/2014 10:40:06 AM

Electronics: DAE4 Sn786

Medium: Body 1900MHz

Medium parameters used (interpolated):  $f = 1850.2$  MHz;  $\sigma = 1.47$  S/m;  $\epsilon_r = 52.741$ ;  $\rho = 1000$  kg/m<sup>3</sup>

Ambient Temperature: 24.2°C      Liquid Temperature: 23.7°C

Communication System: GPRS 1900 class 12 Frequency: 1850.2 MHz Duty Cycle: 1:2.67

Probe: EX3DV4 - SN3633 ConvF(4.83, 4.83, 4.83); Calibrated: 10/31/2013

**Rear Low/Area Scan (61x101x1):** Interpolated grid: dx=1.500 mm, dy=1.500 mm

Reference Value = 23.085 V/m; Power Drift = 0.13 dB

Maximum value of SAR (interpolated) = 0.962 W/kg

**Rear Low/Zoom Scan (5x5x7)/Cube 0:** Measurement grid: dx=8mm, dy=8mm, dz=5mm

Reference Value = 23.085 V/m; Power Drift = 0.13 dB

Peak SAR (extrapolated) = 1.15 W/kg

**SAR(1 g) = 0.783 W/kg; SAR(10 g) = 0.469 W/kg**

Maximum value of SAR (measured) = 0.827 W/kg

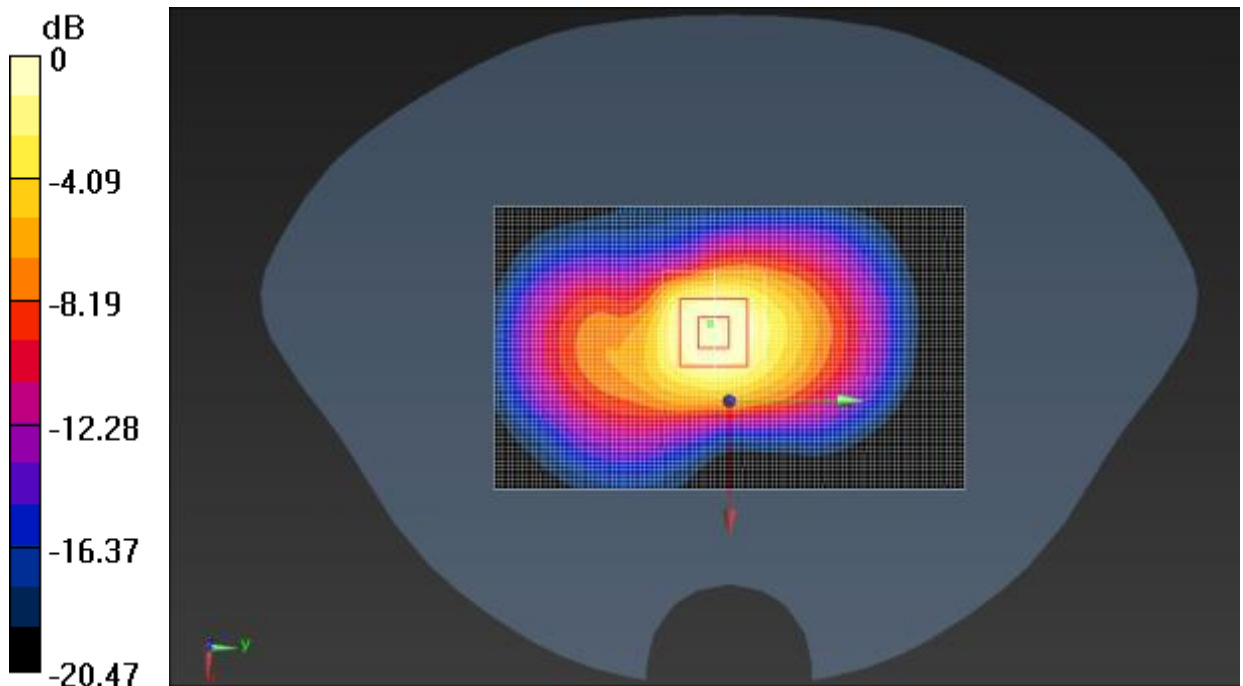

0 dB = 0.827 W/kg = -0.82 dBW/kg

Fig. 27 GSM 1900MHz CH512

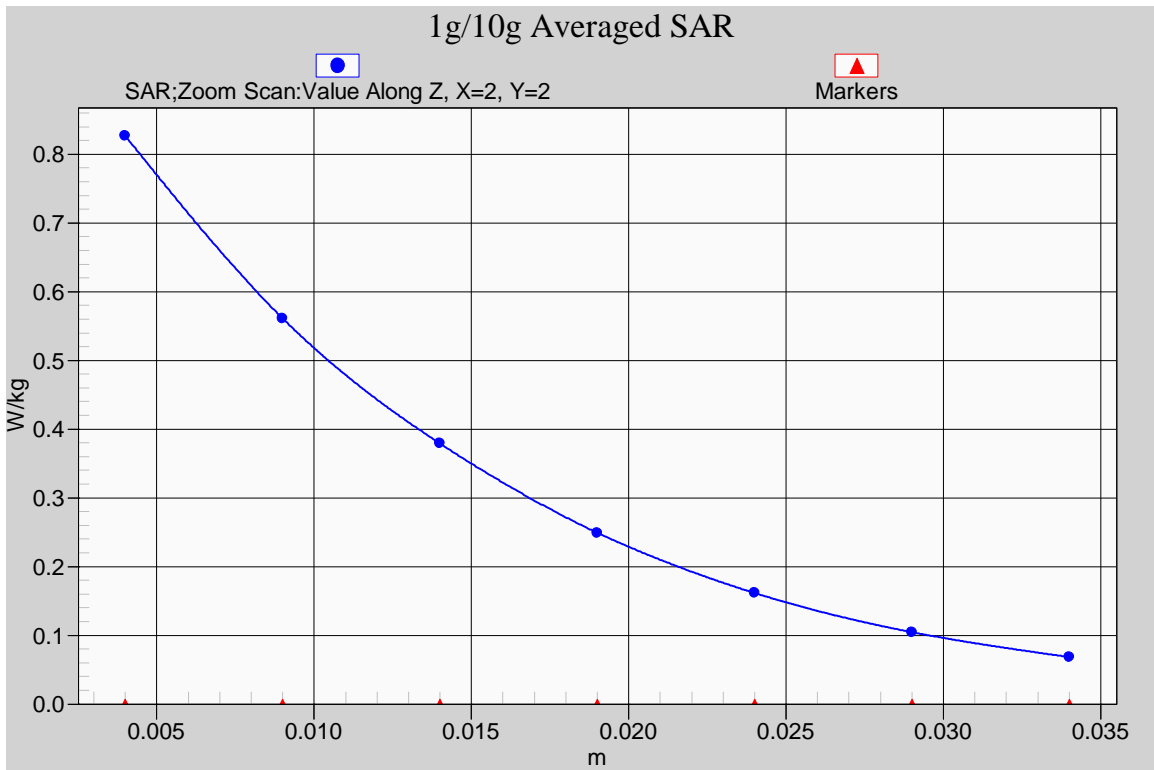

**Fig. 27-1 Z-Scan at power reference point (1900 MHz CH512)**

# GSM1900 body

Date/Time: 8/7/2014 11:24:27 AM

Electronics: DAE4 Sn786

Medium: Body 1900MHz

Medium parameters used (interpolated):  $f = 1850.2$  MHz;  $\sigma = 1.47$  S/m;  $\epsilon_r = 52.741$ ;  $\rho = 1000$  kg/m<sup>3</sup>

Ambient Temperature: 24.2°C      Liquid Temperature: 23.7°C

Communication System: GSM Frequency: 1850.2 MHz Duty Cycle: 1:8.30042

Probe: EX3DV4 - SN3633 ConvF(4.83, 4.83, 4.83); Calibrated: 10/31/2013

**Rear side Low/Area Scan (51x91x1):** Interpolated grid: dx=1.500 mm, dy=1.500 mm

Reference Value = 11.138 V/m; Power Drift = 0.13 dB

Maximum value of SAR (interpolated) = 0.150 W/kg

**Rear side Low/Zoom Scan (5x5x7)/Cube 0:** Measurement grid: dx=8mm, dy=8mm, dz=5mm

Reference Value = 11.138 V/m; Power Drift = 0.13 dB

Peak SAR (extrapolated) = 0.206 W/kg

**SAR(1 g) = 0.137 W/kg; SAR(10 g) = 0.081 W/kg**

Maximum value of SAR (measured) = 0.151 W/kg

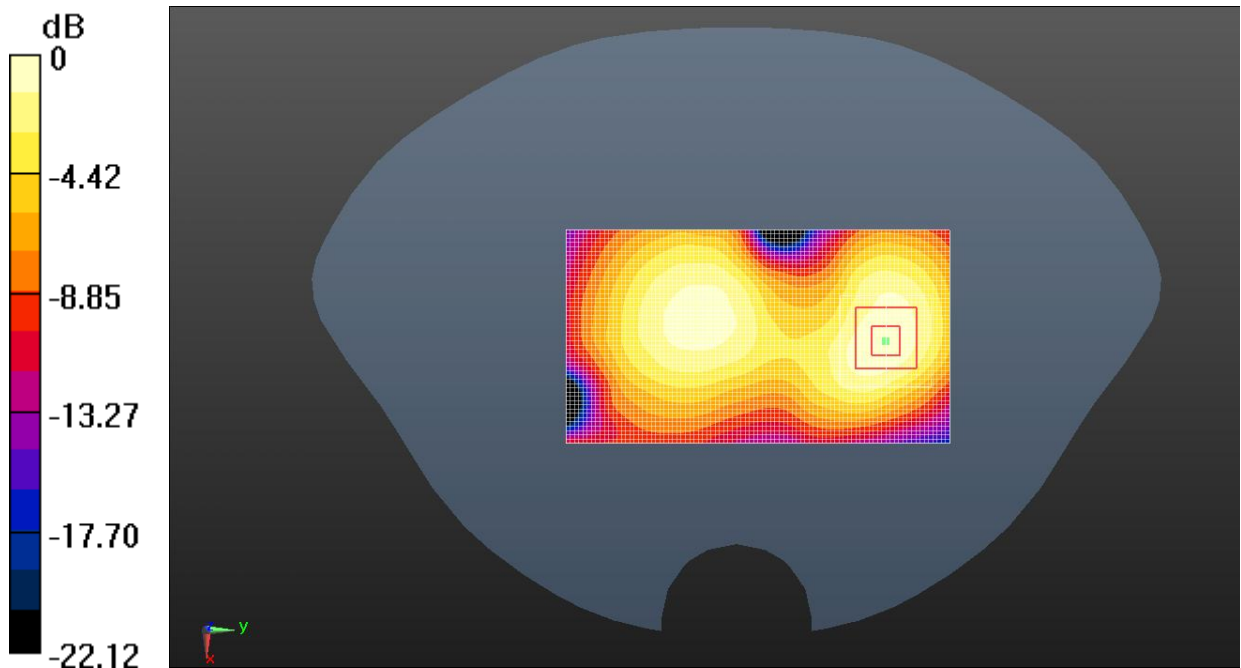

0 dB = 0.151 W/kg = -8.21 dBW/kg

Fig. 28 GSM 1900MHz CH512

## ANNEX B System Verification Results

### 835MHz

Date: 8/6/2014

Electronics: DAE4 Sn786

Medium: Head 900MHz

Medium parameters used (interpolated):  $f = 835 \text{ MHz}$ ;  $\sigma = 0.88 \text{ S/m}$ ;  $\epsilon_r = 42.13$ ;  $\rho = 1000 \text{ kg/m}^3$

Ambient Temperature:  $24.3^\circ\text{C}$       Liquid Temperature:  $23.8^\circ\text{C}$

Communication System: CW\_TMC Frequency: 835 MHz Duty Cycle: 1:1

Probe: EX3DV4 - SN3633 ConvF(6.13, 6.13, 6.13); Calibrated: 10/31/2013

**System Validation /Area Scan (61x181x1):** Interpolated grid:  $dx=1.000 \text{ mm}$ ,  $dy=1.000 \text{ mm}$

Reference Value = 54.509 V/m; Power Drift = 0.01 dB

Maximum value of SAR (interpolated) = 2.64 W/kg

**System Validation /Zoom Scan (7x7x7)/Cube 0:** Measurement grid:  $dx=5\text{mm}$ ,  $dy=5\text{mm}$ ,  $dz=5\text{mm}$

Reference Value = 54.509 V/m; Power Drift = 0.01 dB

Peak SAR (extrapolated) = 3.65 W/kg

**SAR(1 g) = 2.46 W/kg; SAR(10 g) = 1.61 W/kg**

Maximum value of SAR (measured) = 2.65 W/kg

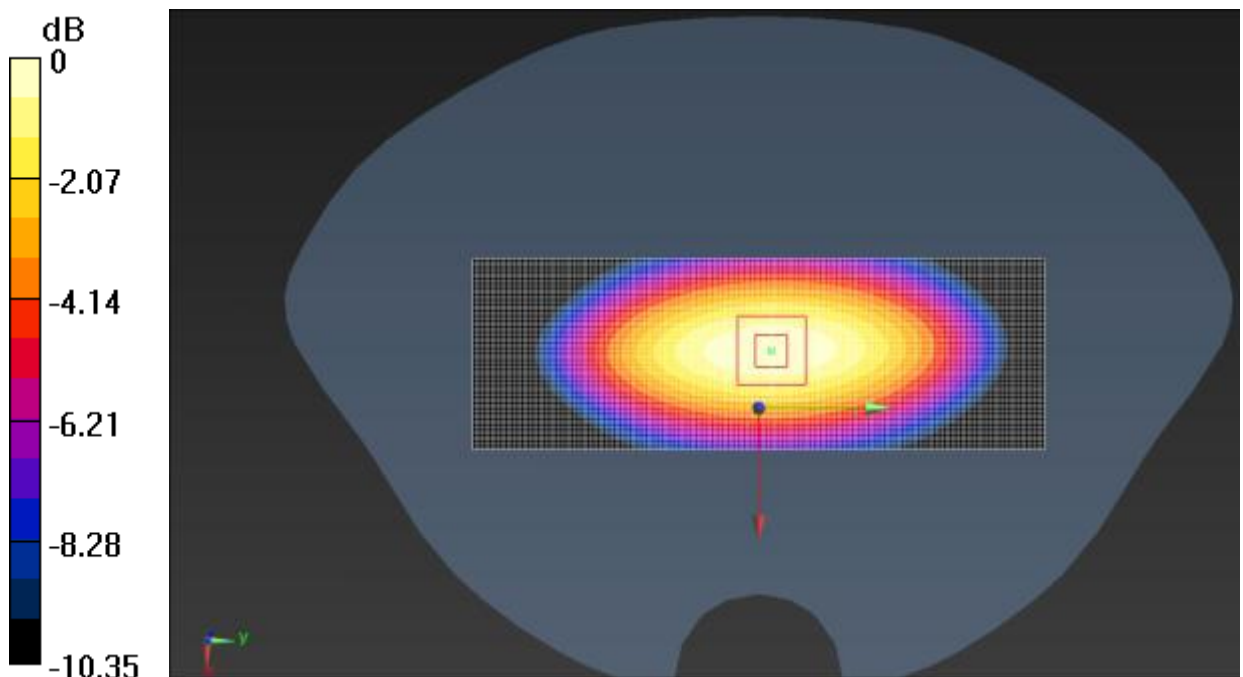

0 dB = 2.65 W/kg = 4.23 dBW/kg

**Fig.B.1 validation 835MHz 250mW**

## 835MHz

Date:8/7/2014

Electronics: DAE4 Sn786

Medium: Body 900

Medium parameters used (interpolated):  $f = 835 \text{ MHz}$ ;  $\sigma = 0.982 \text{ S/m}$ ;  $\epsilon_r = 55.714$ ;  $\rho = 1000 \text{ kg/m}^3$

Ambient Temperature:  $23.5^\circ\text{C}$       Liquid Temperature:  $23.0^\circ\text{C}$

Communication System: CW\_TMC Frequency:  $835 \text{ MHz}$  Duty Cycle: 1:1

Probe: EX3DV4 - SN3633 ConvF(6.1, 6.1, 6.1); Calibrated: 10/31/2013

**System Validation /Area Scan (61x181x1):** Interpolated grid:  $dx=1.000 \text{ mm}$ ,  $dy=1.000 \text{ mm}$

Reference Value =  $53.566 \text{ V/m}$ ; Power Drift =  $-0.02 \text{ dB}$

Maximum value of SAR (interpolated) =  $2.67 \text{ W/kg}$

**System Validation /Zoom Scan (7x7x7)/Cube 0:** Measurement grid:  $dx=5\text{mm}$ ,  $dy=5\text{mm}$ ,  $dz=5\text{mm}$

Reference Value =  $53.566 \text{ V/m}$ ; Power Drift =  $-0.02 \text{ dB}$

Peak SAR (extrapolated) =  $3.58 \text{ W/kg}$

**SAR(1 g) =  $2.46 \text{ W/kg}$ ; SAR(10 g) =  $1.62 \text{ W/kg}$**

Maximum value of SAR (measured) =  $2.66 \text{ W/kg}$

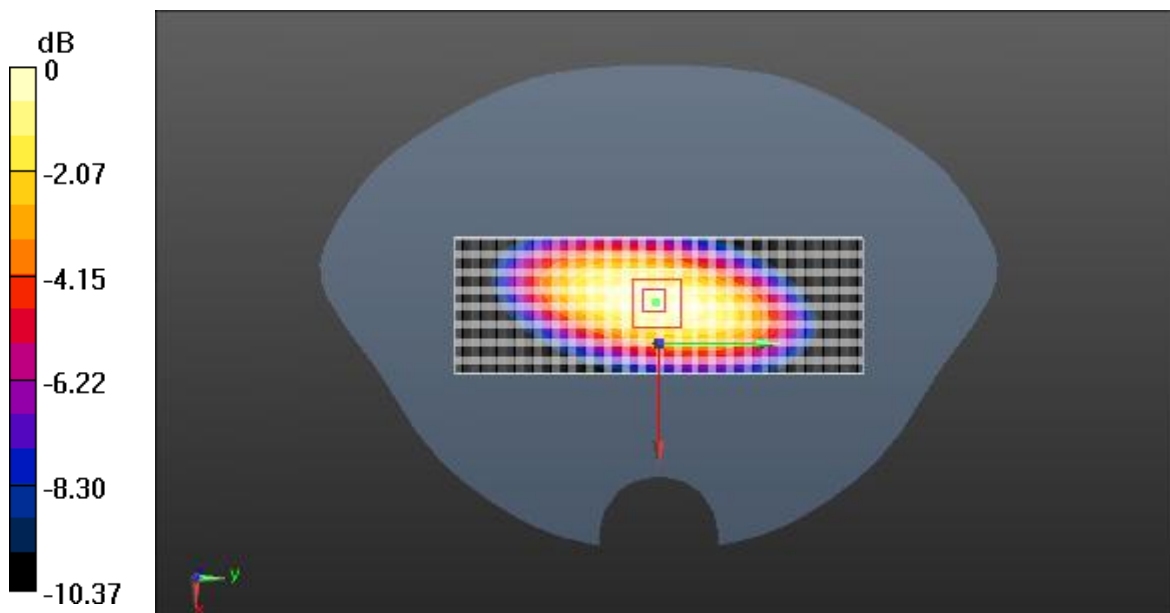

0 dB =  $2.66 \text{ W/kg} = 4.25 \text{ dBW/kg}$

**Fig.B.2 validation 835MHz 250mW**

## 1900MHz

Date: 8/6/2014

Electronics: DAE4 Sn786

Medium: Head 1900

Medium parameters used:  $f = 1900$  MHz;  $\sigma = 1.456$  S/m;  $\epsilon_r = 39.162$ ;  $\rho = 1000$  kg/m<sup>3</sup>

Ambient Temperature: 24.3°C      Liquid Temperature: 23.8°C

Communication System: CW\_TMC Frequency: 1900 MHz Duty Cycle: 1:1

Probe: EX3DV4 - SN3633 ConvF(4.99, 4.99, 4.99); Calibrated: 10/31/2013

**System Validation /Area Scan (61x121x1):** Interpolated grid: dx=1.000 mm, dy=1.000 mm

Reference Value = 86.259 V/m; Power Drift = -0.09 dB

Maximum value of SAR (interpolated) = 11.5 W/kg

**System Validation /Zoom Scan (7x7x7)/Cube 0:** Measurement grid: dx=5mm, dy=5mm, dz=5mm

Reference Value = 86.259 V/m; Power Drift = -0.09 dB

Peak SAR (extrapolated) = 18.4 W/kg

**SAR(1 g) = 10.1 W/kg; SAR(10 g) = 5.18 W/kg**

Maximum value of SAR (measured) = 11.6 W/kg

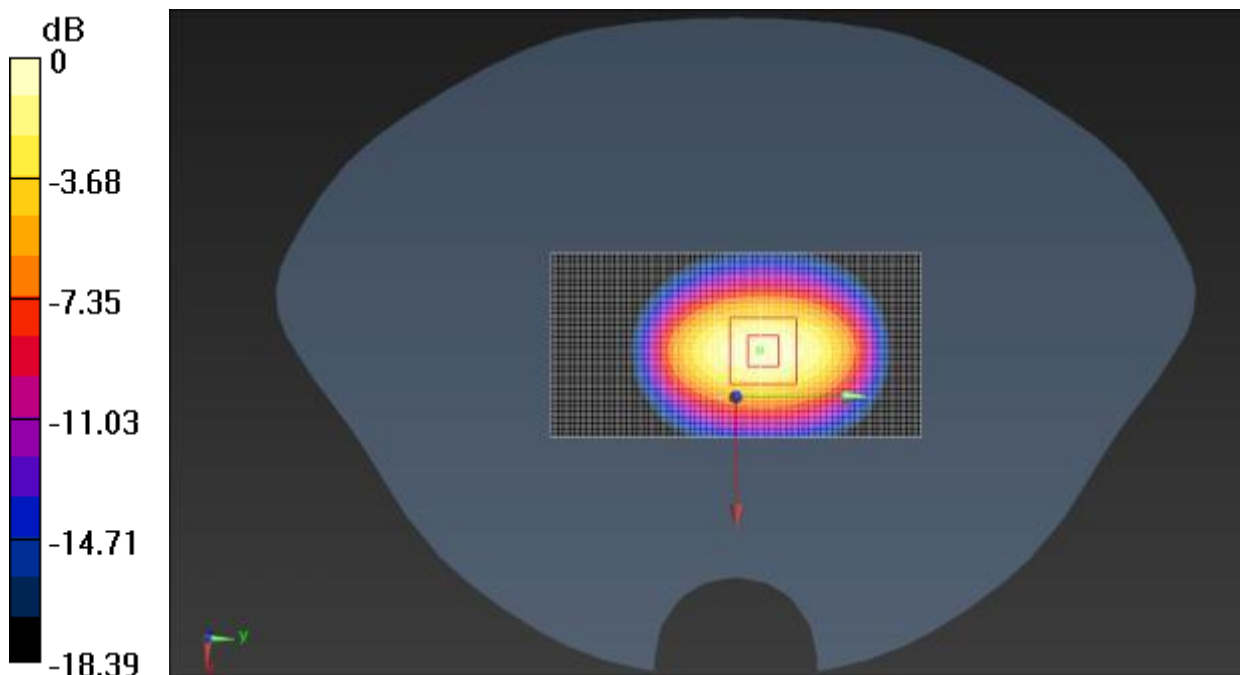

0 dB = 11.6 W/kg = 10.64 dBW/kg

**Fig.B.3 validation 1900MHz 250mW**



## 1900MHz

Date: 8/7/2014

Electronics: DAE4 Sn786

Medium: Body 1900MHz

Medium parameters used:  $f = 1900$  MHz;  $\sigma = 1.512$  S/m;  $\epsilon_r = 52.613$ ;  $\rho = 1000$  kg/m<sup>3</sup>

Ambient Temperature: 22.5°C      Liquid Temperature: 22.0°C

Communication System: CW\_TMC Frequency: 1900 MHz Duty Cycle: 1:1

Probe: EX3DV4 - SN3633 ConvF(4.83, 4.83, 4.83); Calibrated: 10/31/2013

**System validation /Area Scan (61x121x1):** Interpolated grid: dx=1.000 mm, dy=1.000 mm

Reference Value = 60.339 V/m; Power Drift = 0.08 dB

Maximum value of SAR (interpolated) = 12.4 W/kg

**System validation /Zoom Scan (7x7x7)/Cube 0:** Measurement grid: dx=5mm, dy=5mm, dz=5mm

Reference Value = 60.339 V/m; Power Drift = 0.08 dB

Peak SAR (extrapolated) = 19.3 W/kg

**SAR(1 g) = 10.4 W/kg; SAR(10 g) = 5.48 W/kg**

Maximum value of SAR (measured) = 12.4 W/kg

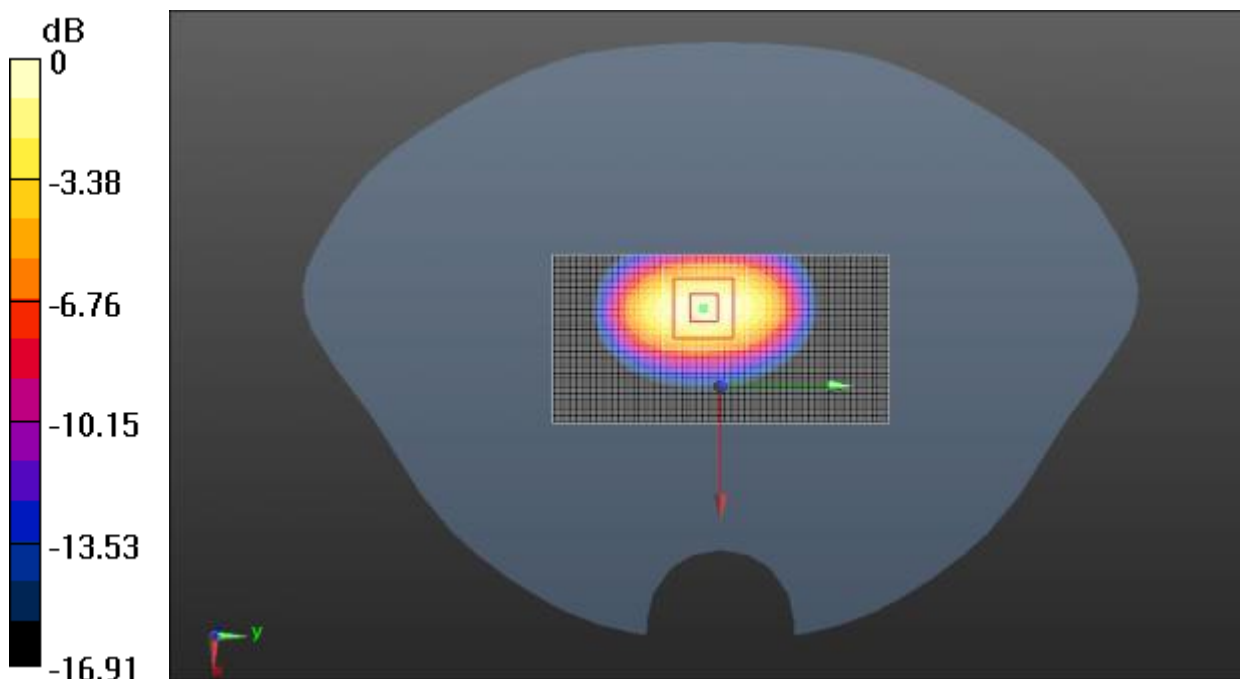

0 dB = 12.4 W/kg = 10.93 dBW/kg

**Fig.B.4 validation 1900MHz 250Mw**

## ANNEX C SAR Measurement Setup

### C.1 Measurement Set-up

The Dasy4 or DASY5 system for performing compliance tests is illustrated above graphically. This system consists of the following items:

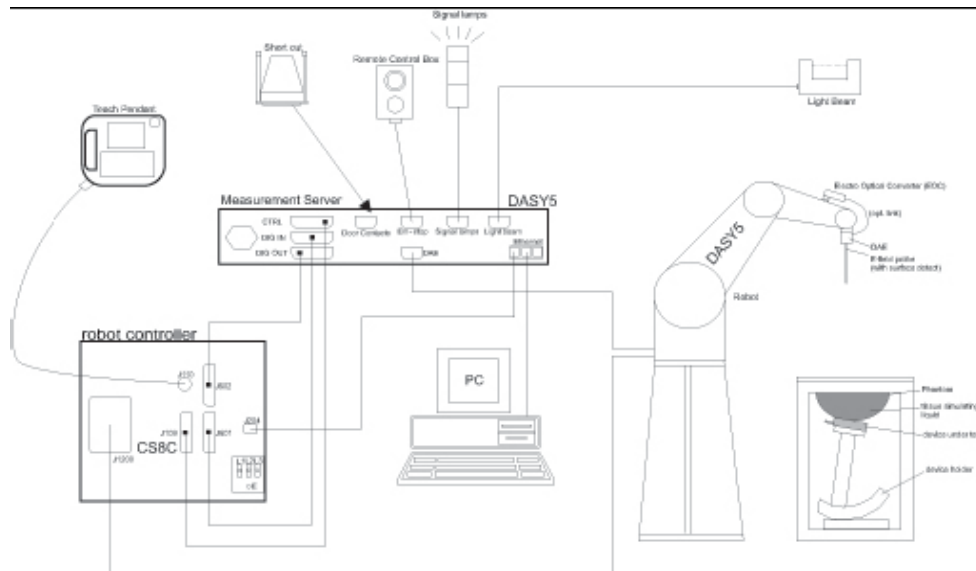

**Picture C.1 SAR Lab Test Measurement Set-up**

- A standard high precision 6-axis robot (Stäubli TX=RX family) with controller, teach pendant and software. An arm extension for accommodating the data acquisition electronics (DAE).
- An isotropic field probe optimized and calibrated for the targeted measurement.
- A data acquisition electronics (DAE) which performs the signal amplification, signal multiplexing, AD-conversion, offset measurements, mechanical surface detection, collision detection, etc. The unit is battery powered with standard or rechargeable batteries. The signal is optically transmitted to the EOC.
- The Electro-optical converter (EOC) performs the conversion from optical to electrical signals for the digital communication to the DAE. To use optical surface detection, a special version of the EOC is required. The EOC signal is transmitted to the measurement server.
- The function of the measurement server is to perform the time critical tasks such as signal filtering, control of the robot operation and fast movement interrupts.
- The Light Beam used is for probe alignment. This improves the (absolute) accuracy of the probe positioning.
- A computer running WinXP and the DASY4 or DASY5 software.
- Remote control and teach pendant as well as additional circuitry for robot safety such as
- warning lamps, etc.
- The phantom, the device holder and other accessories according to the targeted measurement.

## C.2 Dasy4 or DASY5 E-field Probe System

The SAR measurements were conducted with the dosimetric probe designed in the classical triangular configuration and optimized for dosimetric evaluation. The probe is constructed using the thick film technique; with printed resistive lines on ceramic substrates. The probe is equipped with an optical multifiber line ending at the front of the probe tip. It is connected to the EOC box on the robot arm and provides an automatic detection of the phantom surface. Half of the fibers are connected to a pulsed infrared transmitter, the other half to a synchronized receiver. As the probe approaches the surface, the reflection from the surface produces a coupling from the transmitting to the receiving fibers. This reflection increases first during the approach, reaches maximum and then decreases. If the probe is flatly touching the surface, the coupling is zero. The distance of the coupling maximum to the surface is independent of the surface reflectivity and largely independent of the surface to probe angle. The DASY4 or DASY5 software reads the reflection during a software approach and looks for the maximum using 2<sup>nd</sup> order curve fitting. The approach is bottomed out at reaching the maximum.

### Probe Specifications:

<b>Model:</b>	<b>ES3DV3, EX3DV4</b>
<b>Frequency</b>	<b>10MHz — 6.0GHz(EX3DV4)</b>
<b>Range:</b>	<b>10MHz — 4GHz(ES3DV3)</b>
<b>Calibration:</b>	<b>In head and body simulating tissue at Frequencies from 835 up to 5800MHz</b>
<b>Linearity:</b>	<b>± 0.2 dB(30 MHz to 6 GHz) for EX3DV4 ± 0.2 dB(30 MHz to 4 GHz) for ES3DV3</b>
<b>Dynamic Range:</b>	<b>10 mW/kg — 100W/kg</b>
<b>Probe Length:</b>	<b>330 mm</b>
<b>Probe Tip</b>	
<b>Length:</b>	<b>20 mm</b>
<b>Body Diameter:</b>	<b>12 mm</b>
<b>Tip Diameter:</b>	<b>2.5 mm (3.9 mm for ES3DV3)</b>
<b>Tip-Center:</b>	<b>1 mm (2.0mm for ES3DV3)</b>
<b>Application:</b>	<b>SAR Dosimetry Testing Compliance tests of mobile phones Dosimetry in strong gradient fields</b>



Picture C.2 Near-field Probe



Picture C.3 E-field Probe

## C.3 E-field Probe Calibration

Each E-Probe/Probe Amplifier combination has unique calibration parameters. A TEM cell calibration procedure is conducted to determine the proper amplifier settings to enter in the probe parameters. The amplifier settings are determined for a given frequency by subjecting the probe to a known E-field density (1 mW/cm<sup>2</sup>) using an RF Signal generator, TEM cell, and RF Power Meter.

The free space E-field from amplified probe outputs is determined in a test chamber. This calibration can be performed in a TEM cell if the frequency is below 1 GHz and in a waveguide or other methodologies above 1 GHz for free space. For the free space calibration, the probe is placed

in the volumetric center of the cavity and at the proper orientation with the field. The probe is then rotated 360 degrees until the three channels show the maximum reading. The power density readings equates to 1 mW/ cm<sup>2</sup>:

E-field temperature correlation calibration is performed in a flat phantom filled with the appropriate simulated brain tissue. The E-field in the medium correlates with the temperature rise in the dielectric medium. For temperature correlation calibration a RF transparent thermistor-based temperature probe is used in conjunction with the E-field probe.

$$SAR = C \frac{\Delta T}{\Delta t}$$

Where:

$\Delta t$  = Exposure time (30 seconds),

C = Heat capacity of tissue (brain or muscle),

$\Delta T$  = Temperature increase due to RF exposure.

$$SAR = \frac{|E|^2 \cdot \sigma}{\rho}$$

Where:

$\sigma$  = Simulated tissue conductivity,

$\rho$  = Tissue density (kg/m<sup>3</sup>).

## C.4 Other Test Equipment

### C.4.1 Data Acquisition Electronics(DAE)

The data acquisition electronics consist of a highly sensitive electrometer-grade preamplifier with auto-zeroing, a channel and gain-switching multiplexer, a fast 16 bit AD-converter and a command decoder with a control logic unit. Transmission to the measurement server is accomplished through an optical downlink for data and status information, as well as an optical uplink for commands and the clock.

The mechanical probe mounting device includes two different sensor systems for frontal and sideways probe contacts. They are used for mechanical surface detection and probe collision detection.

The input impedance of the DAE is 200 MOhm; the inputs are symmetrical and floating. Common mode rejection is above 80 dB.



PictureC.4: DAE

### C.4.2 Robot

The SPEAG DASY system uses the high precision robots (DASY5: TX90XL) type from Stäubli SA (France). For the 6-axis controller system, the robot controller version from Stäubli is used. The Stäubli robot series have many features that are important for our application:

- High precision (repeatability 0.02mm)
- High reliability (industrial design)
- Low maintenance costs (virtually maintenance free due to direct drive gears; no belt drives)
- Jerk-free straight movements (brushless synchron motors; no stepper motors)
- Low ELF interference (motor control fields shielded via the closed metallic construction shields)



PictureC.5: DASY5 Robot

### C.4.3 Measurement Server

The Measurement server is based on a PC/104 CPU board with CPU (dasy4: 166 MHz, Intel Pentium; DASY5: 400 MHz, Intel Celeron), chipdisk (DASY4: 32 MB; DASY5: 128MB), RAM (DASY4: 64 MB, DASY5: 128MB). The necessary circuits for communication with the DAE electronic box, as well as the 16 bit AD converter system for optical detection and digital I/O interface are contained on the DASY I/O board, which is directly connected to the PC/104 bus of the CPU board.

The measurement server performs all real-time data evaluation of field measurements and surface detection, controls robot movements and handles safety operation. The PC operating system cannot interfere with these time critical processes. All connections are supervised by a watchdog, and disconnection of any of the cables to the measurement server will automatically disarm the robot and disable all program-controlled robot movements. Furthermore, the measurement server is equipped with an expansion port which is reserved for future applications. Please note that this expansion port does not have a standardized pinout, and therefore only devices provided by SPEAG can be connected. Devices from any other supplier could seriously damage the measurement server.



Picture C.6 Server for DASY 4



Picture C.7 Server for DASY 5

#### C.4.4 Device Holder for Phantom

The SAR in the phantom is approximately inversely proportional to the square of the distance between the source and the liquid surface. For a source at 5mm distance, a positioning uncertainty of  $\pm 0.5\text{mm}$  would produce a SAR uncertainty of  $\pm 20\%$ . Accurate device positioning is therefore crucial for accurate and repeatable measurements. The positions in which the devices must be measured are defined by the standards.

The DASY device holder is designed to cope with the different positions given in the standard. It has two scales for device rotation (with respect to the body axis) and device inclination (with respect to the line between the ear reference points). The rotation centers for both scales is the ear reference point (ERP). Thus the device needs no repositioning when changing the angles.

The DASY device holder is constructed of low-loss

POM material having the following dielectric

parameters: relative permittivity  $\epsilon = 3$  and loss tangent  $\delta = 0.02$ . The amount of dielectric material has been reduced in the closest vicinity of the device, since measurements have suggested that the influence of the clamp on the test results could thus be lowered.

<Lapbottom Extension Kit>

The extension is lightweight and made of POM, acrylic glass and foam. It fits easily on the upper part of the Mounting Device in place of the phone positioner. The extension is fully compatible with the Twin-SAM and ELI phantoms.



Picture C.8-1: Device Holder  
Kit

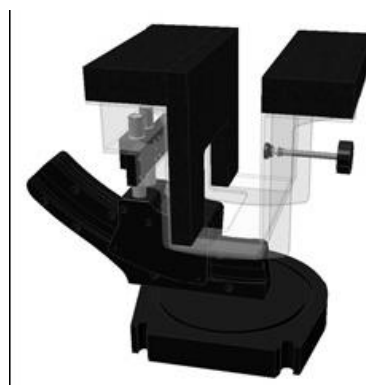

Picture C.8-2: Lapbottom Extension

#### C.4.5 Phantom

The SAM Twin Phantom V4.0 is constructed of a fiberglass shell integrated in a table. The shape of the shell is based on data from an anatomical study designed to

Represent the 90<sup>th</sup> percentile of the population. The phantom enables the dissymmetric evaluation of SAR for both left and right handed handset usage, as well as body-worn usage using the flat phantom region. Reference markings on the Phantom allow the complete setup of all predefined phantom positions and measurement grids by manually teaching three points in the robot. The shell phantom has a 2mm shell thickness (except the ear region where shell thickness increases to 6 mm).

Shell Thickness:  $2 \pm 0.2$  mm  
 Filling Volume: Approx. 25 liters  
 Dimensions: 810 x 1000 x 500 mm (H x L x W)  
 Available: Special



**Picture C.9: SAM Twin Phantom**

The ELI4 phantom is constructed of a fiberglass shell integrated in a wooden table. The shape of the shell is based on data from an anatomical study designed to determine the maximum exposure in at least 90% of all users. The ELI4 phantom is intended for compliance testing of handheld and body-mounted wireless devices in the frequency range of 30MHz to 6GHz. ELI4 is fully compatible with the latest standard IEC 62209-2 and all known tissue simulating liquids. A cover prevents the evaporation of the liquid. Reference markings on the Phantom allow the complete setup of all predefined phantom positions and measurement grids by manually teaching three points in the robot.

Shell Thickness  $2 \pm 0.1$  mm  
 Filling Volume Approx. 20 liters  
 Dimensions 810 x 1000 x 500 mm (H x L x W)  
 Available Special

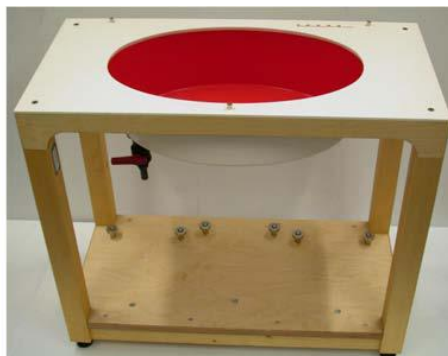

**Picture C.10: SAM Twin Phantom**

## ANNEX D Position of the wireless device in relation to the phantom

### D.1 General Considerations

This standard specifies two handset test positions against the head phantom – the “cheek” position and the “tilt” position.

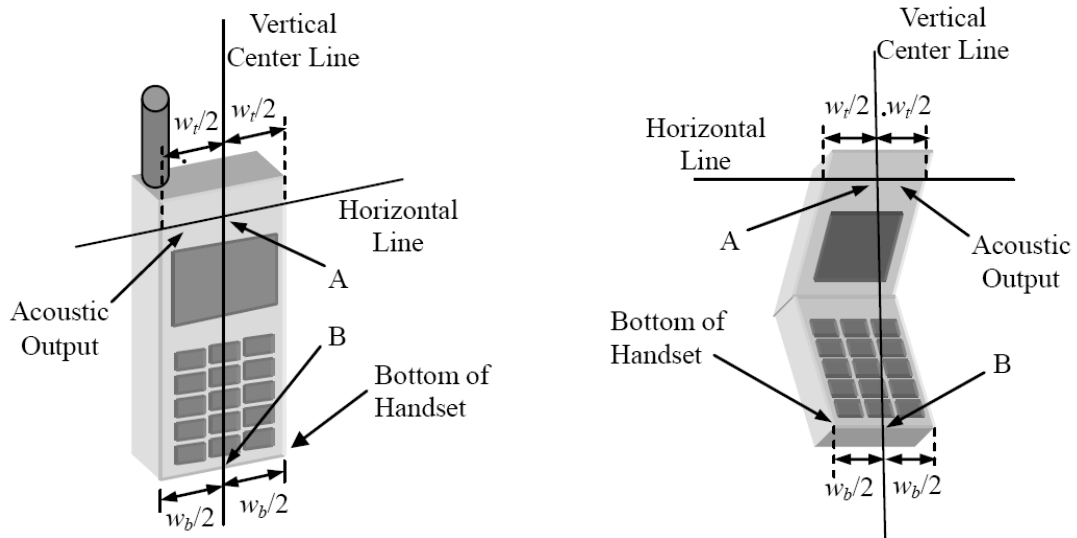

- $w_t$  Width of the handset at the level of the acoustic
- $w_b$  Width of the bottom of the handset
- A Midpoint of the width  $w_t$  of the handset at the level of the acoustic output
- B Midpoint of the width  $w_b$  of the bottom of the handset

Picture D.1-a Typical “fixed” case handset      Picture D.1-b Typical “clam-shell” case handset

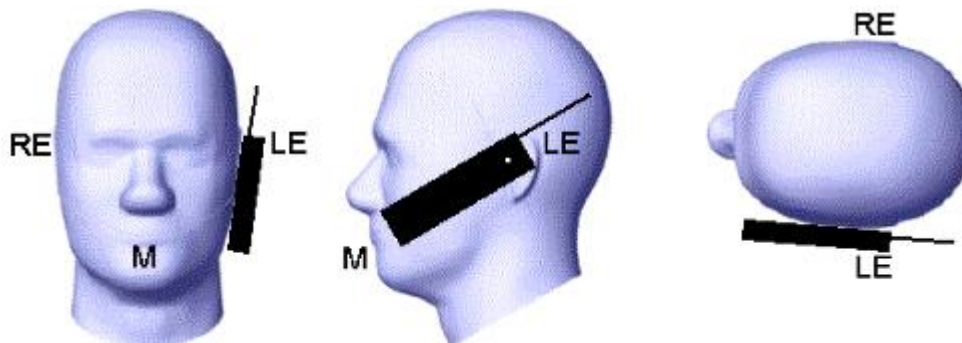

Picture D.2 Cheek position of the wireless device on the left side of SAM



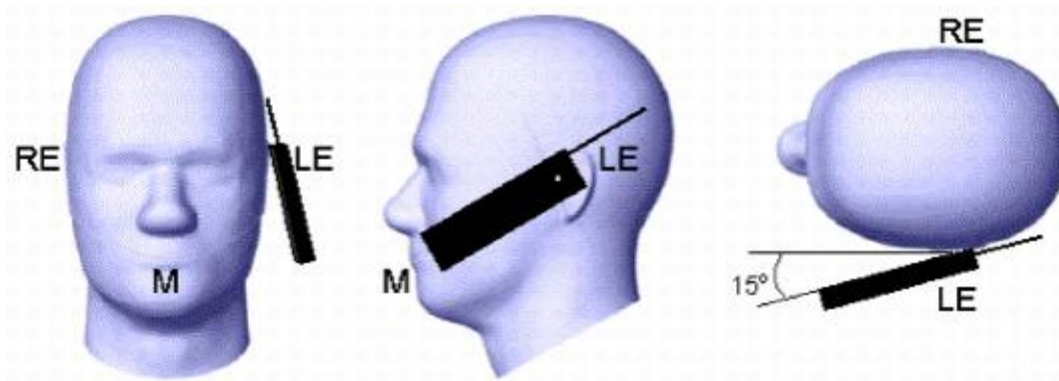

Picture D.3 Tilt position of the wireless device on the left side of SAM

## D.2 Body-worn device

A typical example of a body-worn device is a mobile phone, wireless enabled PDA or other battery operated wireless device with the ability to transmit while mounted on a person's body using a carry accessory approved by the wireless device manufacturer.

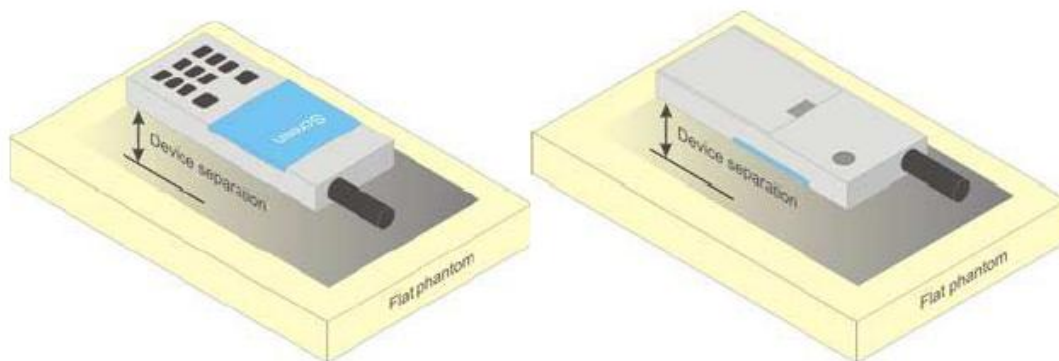

Picture D.4 Test positions for body-worn devices

## D.3 Deskbottom device

A typical example of a deskbottom device is a wireless enabled deskbottom computer placed on a table or desk when used.

The DUT shall be positioned at the distance and in the orientation to the phantom that corresponds to the intended use as specified by the manufacturer in the user instructions. For devices that employ an external antenna with variable positions, tests shall be performed for all antenna positions specified. Picture 8.5 show positions for deskbottom device SAR tests. If the intended use is not specified, the device shall be tested directly against the flat phantom.

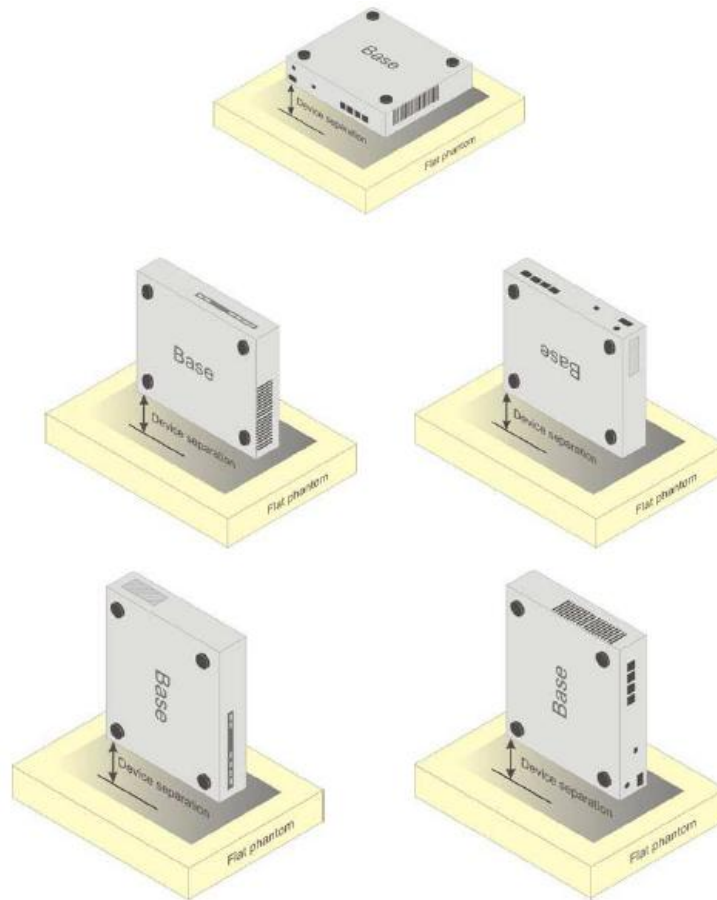

Picture D.5 Test positions for deskbottom devices

#### D.4 DUT Setup Photos



Picture D.6

## ANNEX E Equivalent Media Recipes

The liquid used for the frequency range of 800-3000 MHz consisted of water, sugar, salt, preventol, glycol monobutyl and Cellulose. The liquid has been previously proven to be suited for worst-case. The Table E.1 shows the detail solution. It's satisfying the latest tissue dielectric parameters requirements proposed by the IEEE 1528 and IEC 62209.

**Table E.1: Composition of the Tissue Equivalent Matter**

Frequency (MHz)	835 Head	835 Body	1900 Head	1900 Body	2450 Head	2450 Body
Ingredients (% by weight)						
Water	41.45	52.5	55.242	69.91	58.79	72.60
Sugar	56.0	45.0	\	\	\	\
Salt	1.45	1.4	0.306	0.13	0.06	0.18
Preventol	0.1	0.1	\	\	\	\
Cellulose	1.0	1.0	\	\	\	\
Glycol Monobutyl	\	\	44.452	29.96	41.15	27.22
Dielectric Parameters Target Value	$\epsilon=41.5$ $\sigma=0.90$	$\epsilon=55.2$ $\sigma=0.97$	$\epsilon=40.0$ $\sigma=1.40$	$\epsilon=53.3$ $\sigma=1.52$	$\epsilon=39.2$ $\sigma=1.80$	$\epsilon=52.7$ $\sigma=1.95$

## ANNEX F System Validation

The SAR system must be validated against its performance specifications before it is deployed. When SAR probes, system components or software are changed, upgraded or recalibrated, these must be validated with the SAR system(s) that operates with such components.

**Table F.1: System Validation**

Probe SN.	Liquid name	Validation date	Frequency point	Status (OK or Not)
3633	Head 850MHz	December. 06, 2013	850 MHz	OK
3633	Head 850MHz	December.. 06, 2013	900 MHz	OK
3633	Head 1800MHz	December.07, 2013	1800 MHz	OK
3633	Head 1900MHz	December.. 07, 2013	1900 MHz	OK
3633	Head 2000MHz	December.. 08, 2013	2000 MHz	OK
3633	Head 2100MHz	December.. 08, 2013	2100 MHz	OK
3633	Head 2450MHz	December.. 11, 2013	2450 MHz	OK
3633	Body 850MHz	December.. 12, 2013	850 MHz	OK
3633	Body 850MHz	December.. 12, 2013	900 MHz	OK
3633	Body 1800MHz	December.. 13, 2013	1800 MHz	OK
3633	Body 1900MHz	December.. 13, 2013	1900 MHz	OK
3633	Body 2000MHz	December.. 14, 2013	2000 MHz	OK
3633	Body 2100MHz	December.. 14, 2013	2100 MHz	OK
3633	Body 2450MHz	December.. 15, 2013	2450 MHz	OK

### ANNEX G Probe Calibration Certificate



In Collaboration with  
**s p e a g**  
CALIBRATION LABORATORY

Add: No.52 Huayuanbei Road, Haidian District, Beijing, 100191, China  
Tel: +86-10-62304633-2079 Fax: +86-10-62304633-2504  
E-mail: Info@emcsite.com Http://www.emcsite.com



Client **TMC(SZ)/CSZIT** Certificate No: **J13-2-2909**

#### CALIBRATION CERTIFICATE

Object **EX3DV4 - SN:3633**

Calibration Procedure(s) **TMC-OS-E-02-195**  
Calibration Procedures for Dosimetric E-field Probes

Calibration date: **October 31, 2013**



受控文件  
TMC-CC-13-284-02

This calibration Certificate documents the traceability to national standards, which realize the physical units of measurements(SI). The measurements and the uncertainties with confidence probability are given on the following pages and are part of the certificate.

All calibrations have been conducted in the closed laboratory facility: environment temperature(22±3)°C and humidity<70%.

#### Calibration Equipment used (M&TE critical for calibration)

Primary Standards	ID #	Cal Date(Calibrated by, Certificate No.)	Scheduled Calibration
Power Meter NRP2	101919	01-Jul-13 (TMC, No.JW13-044)	Jun-14
Power sensor NRP-Z91	101547	01-Jul-13 (TMC, No.JW13-044)	Jun-14
Power sensor NRP-Z91	101548	01-Jul-13 (TMC, No.JW13-044)	Jun-14
Reference10dBAttenuator	BT0520	12-Dec-12(TMC,No.JZ12-867)	Dec-14
Reference20dBAttenuator	BT0267	12-Dec-12(TMC,No.JZ12-866)	Dec-14
Reference Probe EX3DV4	SN 3846	03-Sep-13(SPEAG,No.EX3-3846_Sep13)	Sep-14
DAE4	SN 777	22-Feb-13 (SPEAG, DAE4-777_Feb13)	Feb -14
Secondary Standards	ID #	Cal Date(Calibrated by, Certificate No.)	Scheduled Calibration
SignalGeneratorMG3700A	6201052605	01-Jul-13 (TMC, No.JW13-045)	Jun-14
Network Analyzer E5071C	MY46110673	15-Feb-13 (TMC, No.JZ13-781)	Feb-14

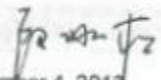
	Name	Function	Signature
Calibrated by:	Zhao Jing	SAR Test Engineer	
Reviewed by:	Qi Dianyuan	SAR Project Leader	
Approved by:	Lu Bingsong	Deputy Director of the laboratory	

Issued: November 4, 2013

This calibration certificate shall not be reproduced except in full without written approval of the laboratory.



In Collaboration with  
**s p e a g**  
CALIBRATION LABORATORY

Add: No.52 Huayuanbei Road, Haidian District, Beijing, 100191, China  
Tel: +86-10-62304633-2079 Fax: +86-10-62304633-2504  
E-mail: Info@emcite.com Http://www.emcite.com

#### Glossary:

TSL	tissue simulating liquid
NORM <sub>x,y,z</sub>	sensitivity in free space
ConvF	sensitivity in TSL / NORM <sub>x,y,z</sub>
DCP	diode compression point
CF	crest factor (1/duty_cycle) of the RF signal
A,B,C,D	modulation dependent linearization parameters
Polarization $\Phi$	$\Phi$ rotation around probe axis
Polarization $\theta$	$\theta$ rotation around an axis that is in the plane normal to probe axis (at measurement center), $\theta=0$ is normal to probe axis

#### Calibration is Performed According to the Following Standards:

- a) IEEE Std 1528-2003, "IEEE Recommended Practice for Determining the Peak Spatial-Averaged Specific Absorption Rate (SAR) in the Human Head from Wireless Communications Devices: Measurement Techniques", December 2003
- b) IEC 62209-1, "Procedure to measure the Specific Absorption Rate (SAR) for hand-held devices used in close proximity to the ear (frequency range of 300MHz to 3GHz)", February 2005

#### Methods Applied and Interpretation of Parameters:

- NORM<sub>x,y,z</sub>: Assessed for E-field polarization  $\theta=0$  (fs900MHz in TEM-cell; f>1800MHz: waveguide). NORM<sub>x,y,z</sub> are only intermediate values, i.e., the uncertainties of NORM<sub>x,y,z</sub> does not effect the  $E^2$ -field uncertainty inside TSL (see below ConvF).
- NORM(f)<sub>x,y,z</sub> = NORM<sub>x,y,z</sub>\* frequency\_response (see Frequency Response Chart). This linearization is implemented in DASY4 software versions later than 4.2. The uncertainty of the frequency response is included in the stated uncertainty of ConvF.
- DCP<sub>x,y,z</sub>: DCP are numerical linearization parameters assessed based on the data of power sweep (no uncertainty required). DCP does not depend on frequency nor media.
- PAR: PAR is the Peak to Average Ratio that is not calibrated but determined based on the signal characteristics.
- Ax,y,z; Bx,y,z; Cx,y,z; VRx,y,z: A,B,C are numerical linearization parameters assessed based on the data of power sweep for specific modulation signal. The parameters do not depend on frequency nor media. VR is the maximum calibration range expressed in RMS voltage across the diode.
- ConvF and Boundary Effect Parameters: Assessed in flat phantom using E-field (or Temperature Transfer Standard for fs800MHz) and inside waveguide using analytical field distributions based on power measurements for f>800MHz. The same setups are used for assessment of the parameters applied for boundary compensation (alpha, depth) of which typical uncertainty valued are given. These parameters are used in DASY4 software to improve probe accuracy close to the boundary. The sensitivity in TSL corresponds to NORM<sub>x,y,z</sub>\* ConvF whereby the uncertainty corresponds to that given for ConvF. A frequency dependent ConvF is used in DASY version 4.4 and higher which allows extending the validity from  $\pm 50$ MHz to  $\pm 100$ MHz.
- Spherical isotropy (3D deviation from isotropy): in a field of low gradients realized using a flat phantom exposed by a patch antenna.
- Sensor Offset: The sensor offset corresponds to the offset of virtual measurement center from the probe tip (on probe axis). No tolerance required.
- Connector Angle: The angle is assessed using the information gained by determining the NORM<sub>x</sub> (no uncertainty required).



In Collaboration with  
**s p e a g**  
CALIBRATION LABORATORY

Add: No.52 Huayuanbei Road, Haidian District, Beijing, 100191, China  
Tel: +86-10-62304633-2079 Fax: +86-10-62304633-2504  
E-mail: Info@emcite.com Http://www.emcite.com

# Probe EX3DV4

SN: 3633

Calibrated: October 31, 2013

Calibrated for DASY/EASY Systems

(Note: non-compatible with DASY2 system!)



Add: No.52 Huayuanbei Road, Haidian District, Beijing, 100191, China  
Tel: +86-10-62304633-2079 Fax: +86-10-62304633-2504  
E-mail: Info@emcite.com Http://www.emcite.com

## DASY – Parameters of Probe: EX3DV4 - SN: 3633

### Basic Calibration Parameters

	Sensor X	Sensor Y	Sensor Z	Unc (k=2)
Norm( $\mu\text{V}/(\text{V}/\text{m})^2$ ) <sup>A</sup>	0.38	0.39	0.37	$\pm 10.8\%$
DCP(mV) <sup>B</sup>	97.7	99.7	99.0	

### Modulation Calibration Parameters

UID	Communication System Name		A dB	B dB $\mu\text{V}$	C	D dB	VR mV	Unc <sup>E</sup> (k=2)
0	CW	X	0.0	0.0	1.0	0.00	95.5	$\pm 2.1\%$
		Y	0.0	0.0	1.0		97.6	
		Z	0.0	0.0	1.0		98.7	

The reported uncertainty of measurement is stated as the standard uncertainty of Measurement multiplied by the coverage factor k=2, which for a normal distribution Corresponds to a coverage probability of approximately 95%.

- <sup>A</sup> The uncertainties of Norm X, Y, Z do not affect the E<sup>2</sup>-field uncertainty inside TSL (see Page 5 and Page 6).  
<sup>B</sup> Numerical linearization parameter; uncertainty not required.  
<sup>E</sup> Uncertainty is determined using the max. deviation from linear response applying rectangular distribution and is expressed for the square of the field value.





Add: No.52 Huayuanbei Road, Haidian District, Beijing, 100191, China  
Tel: +86-10-62304633-2079 Fax: +86-10-62304633-2504  
E-mail: Info@emcite.com Http://www.emcite.com

## DASY – Parameters of Probe: EX3DV4 - SN: 3633

### Calibration Parameter Determined in Head Tissue Simulating Media

f [MHz] <sup>C</sup>	Relative Permittivity <sup>F</sup>	Conductivity (S/m) <sup>F</sup>	ConvF X	ConvF Y	ConvF Z	Alpha	Depth (mm)	Unct. (k=2)
850	41.5	0.92	9.32	9.32	9.32	0.15	1.40	± 12%
900	41.5	0.97	9.23	9.23	9.23	0.15	1.33	± 12%
1810	40.0	1.40	8.07	8.07	8.07	0.14	1.93	± 12%
1900	40.0	1.40	7.92	7.92	7.92	0.17	1.76	± 12%
2000	40.0	1.40	8.01	8.01	8.01	0.12	3.32	± 12%
2450	39.2	1.80	7.78	7.78	7.78	0.36	1.00	± 12%

<sup>C</sup> Frequency validity of ±100MHz only applies for DASY v4.4 and higher (Page 2), else it is restricted to ±50MHz. The uncertainty is the RSS of ConvF uncertainty at calibration frequency and the uncertainty for the indicated frequency band.

<sup>F</sup> At frequency below 3 GHz, the validity of tissue parameters ( $\epsilon$  and  $\sigma$ ) can be relaxed to ±10% if liquid compensation formula is applied to measured SAR values. At frequencies above 3 GHz, the validity of tissue parameters ( $\epsilon$  and  $\sigma$ ) is restricted to ±5%. The uncertainty is the RSS of the ConvF uncertainty for indicated target tissue parameters.



Add: No.52 Huayuanbei Road, Haidian District, Beijing, 100191, China  
Tel: +86-10-62304633-2079 Fax: +86-10-62304633-2504  
E-mail: Info@emcite.com Http://www.emcite.com

## DASY – Parameters of Probe: EX3DV4 - SN: 3633

### Calibration Parameter Determined in Body Tissue Simulating Media

f [MHz] <sup>c</sup>	Relative Permittivity <sup>f</sup>	Conductivity (S/m) <sup>f</sup>	ConvF X	ConvF Y	ConvF Z	Alpha	Depth (mm)	Unct. (k=2)
850	55.2	0.99	9.52	9.52	9.52	0.24	1.16	±12%
900	52.7	1.05	9.58	9.58	9.58	0.28	1.03	±12%
1810	53.3	1.52	7.71	7.71	7.71	0.14	2.61	±12%
1900	53.3	1.52	7.37	7.37	7.37	0.14	3.60	±12%
2000	53.3	1.52	7.73	7.73	7.73	0.15	3.47	±12%
2450	52.7	1.95	7.60	7.60	7.60	0.42	0.97	±12%

<sup>c</sup> Frequency validity of ±100MHz only applies for DASY v4.4 and higher (Page 2), else it is restricted to ±50MHz. The uncertainty is the RSS of ConvF uncertainty at calibration frequency and the uncertainty for the indicated frequency band.

<sup>f</sup> At frequency below 3 GHz, the validity of tissue parameters ( $\epsilon$  and  $\sigma$ ) can be relaxed to ±10% if liquid compensation formula is applied to measured SAR values. At frequencies above 3 GHz, the validity of tissue parameters ( $\epsilon$  and  $\sigma$ ) is restricted to ±5%. The uncertainty is the RSS of the ConvF uncertainty for indicated target tissue parameters.



In Collaboration with  
**s p e a g**  
CALIBRATION LABORATORY

Add: No.52 Huayuanbei Road, Haidian District, Beijing, 100191, China  
Tel: +86-10-62304633-2079 Fax: +86-10-62304633-2504  
E-mail: Info@emcite.com Http://www.emcite.com

### Frequency Response of E-Field (TEM-Cell: ifi110 EXX, Waveguide: R22)

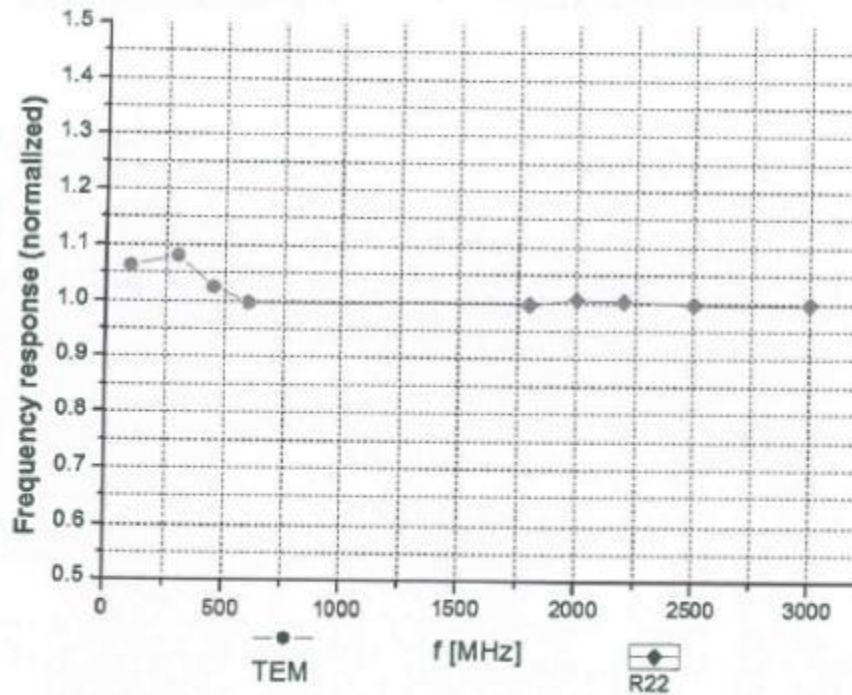

Uncertainty of Frequency Response of E-field:  $\pm 7.5\%$  (k=2)



Add: No.52 Huayuanbei Road, Haidian District, Beijing, 100191, China  
 Tel: +86-10-62304633-2079 Fax: +86-10-62304633-2504  
 E-mail: info@emcite.com Http://www.emcite.com

### Receiving Pattern ( $\Phi$ ), $\theta=0^\circ$

f=600 MHz, TEM

f=1800 MHz, R22

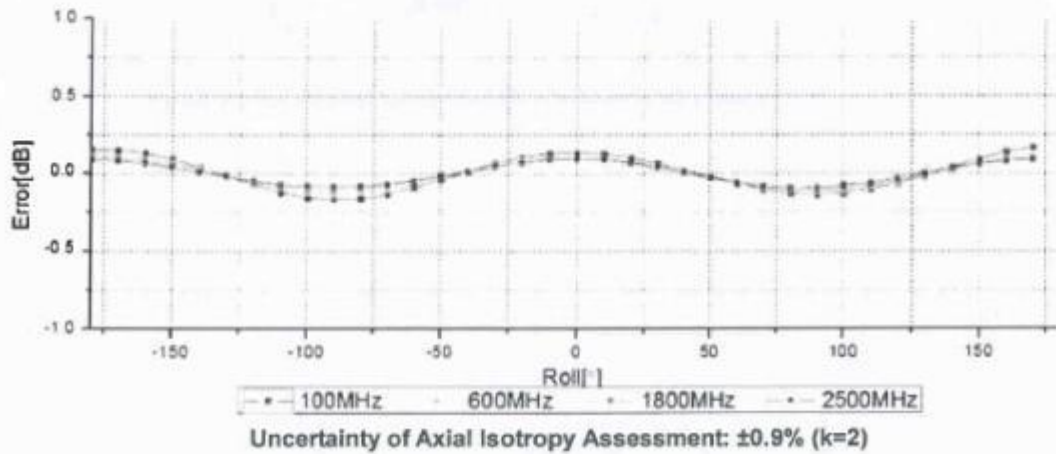
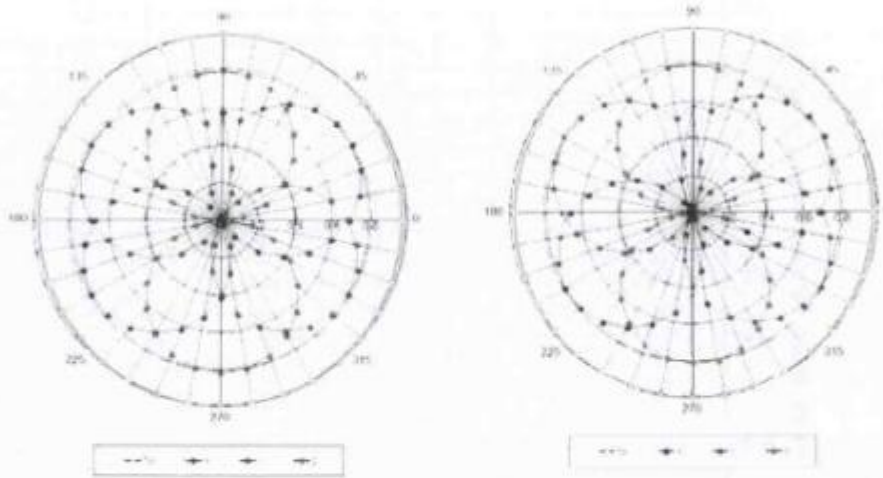



In Collaboration with  
**s p e a g**  
CALIBRATION LABORATORY

Add: No.52 Huiyuanbei Road, Haidian District, Beijing, 100191, China  
Tel: +86-10-62304633-2079 Fax: +86-10-62304633-2504  
E-mail: Info@emcite.com Http://www.emcite.com

### Dynamic Range f(SAR<sub>head</sub>) (TEM cell, f = 900 MHz)

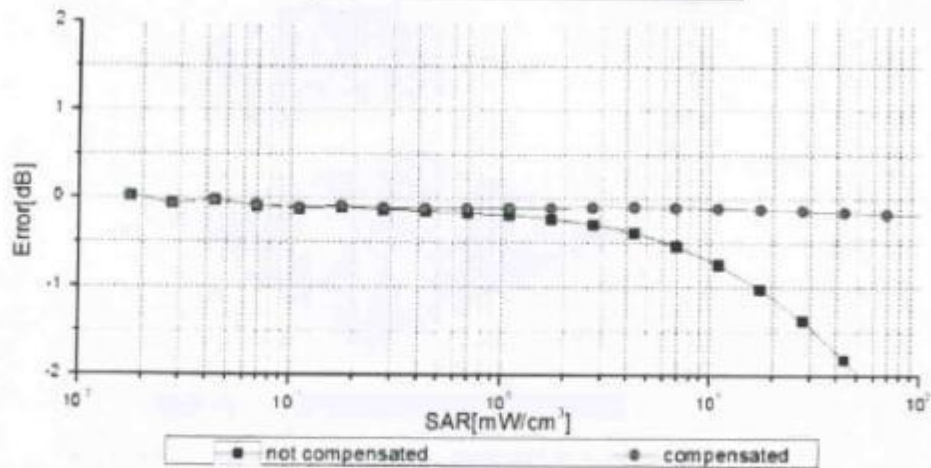
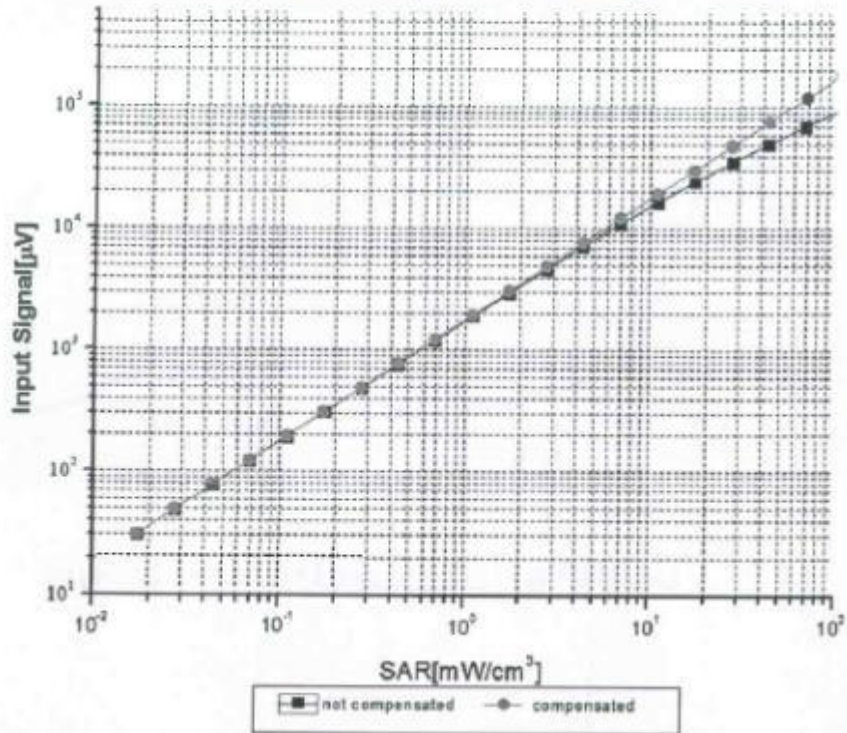

Uncertainty of Linearity Assessment:  $\pm 0.9\%$  (k=2)



Add: No.52 Huayuanbei Road, Haidian District, Beijing, 100191, China  
Tel: +86-10-62304633-2079 Fax: +86-10-62304633-2504  
E-mail: info@emcite.com Http://www.emcite.com

### Conversion Factor Assessment

f=900 MHz, WGLS R9(H\_convF)

f=1900 MHz, WGLS R22(H\_convF)

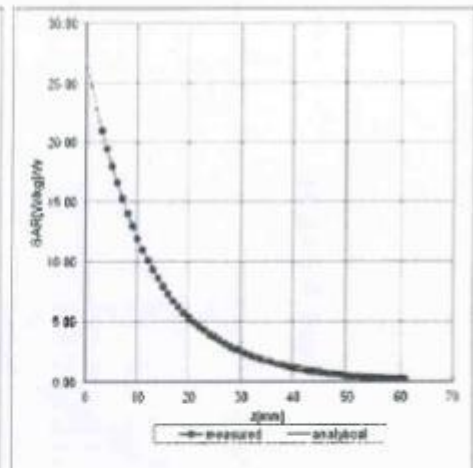
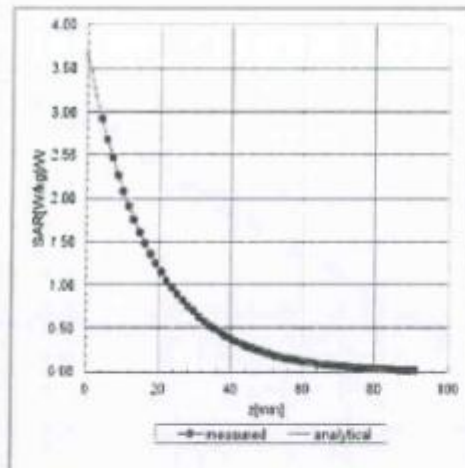

### Deviation from Isotropy in Liquid

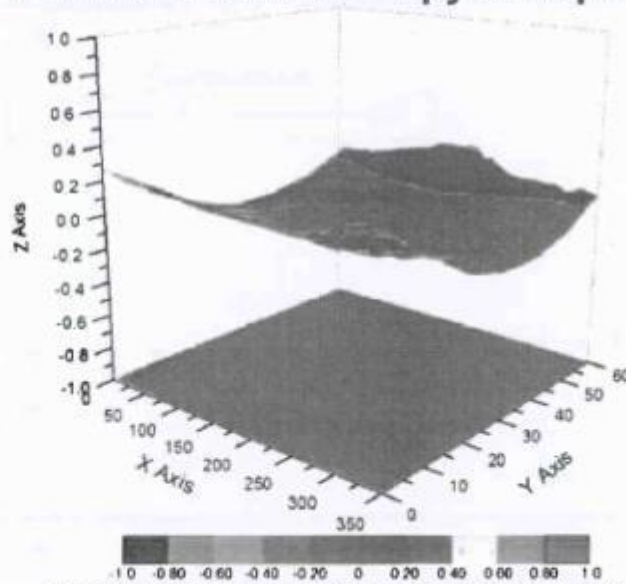

Uncertainty of Spherical Isotropy Assessment:  $\pm 2.8\%$  (K=2)



Add: No.52 Huayuanbei Road, Haidian District, Beijing, 100191, China  
 Tel: +86-10-62304633-2079 Fax: +86-10-62304633-2504  
 E-mail: Info@emcite.com Http://www.emcite.com

## DASY - Parameters of Probe: EX3DV4 - SN: 3633

### Other Probe Parameters

Sensor Arrangement	Triangular
Connector Angle (°)	8
Mechanical Surface Detection Mode	enabled
Optical Surface Detection Mode	disable
Probe Overall Length	337mm
Probe Body Diameter	10mm
Tip Length	9mm
Tip Diameter	2.5mm
Probe Tip to Sensor X Calibration Point	1mm
Probe Tip to Sensor Y Calibration Point	1mm
Probe Tip to Sensor Z Calibration Point	1mm
Recommended Measurement Distance from Surface	2mm



**Acceptable Conditions for SAR Measurements Using Probes and Dipoles  
Calibrated under the SPEAG-TMC Dual-Logo Calibration Program to  
Support FCC Equipment Certification**

The acceptable conditions for SAR measurements using probes, dipoles and DAEs calibrated by TMC (*Telecommunication Metrology Center of MITT in Beijing, China*), under the Dual-Logo Calibration Certificate program and quality assurance (QA) protocols established between SPEAG (*Schmid & Partner Engineering AG, Switzerland*) and TMC, to support FCC (*U.S. Federal Communications Commission*) equipment certification are defined and described in the following.

- 1) The agreement established between SPEAG and TMC is only applicable to calibration services performed by TMC where its clients (companies and divisions of such companies) are headquartered in the Greater China Region, including Taiwan and Hong Kong. This agreement is subject to renewal at the end of each calendar year between SPEAG and TMC. TMC shall inform the FCC of any changes or early termination to the agreement.
- 2) Only a subset of the calibration services specified in the SPEAG-TMC agreement, while it remains valid, are applicable to SAR measurements performed using such equipment for supporting FCC equipment certification. These are identified in the following.
  - a) Calibration of dosimetric (SAR) probes EX3DVx, ET3DVx and ES3DVx.
    - i) Free-space E-field and H-field probes, including those used for HAC (hearing aid compatibility) evaluation, temperature probes, other probes or equipment not identified in this document, when calibrated by TMC, are excluded and cannot be used for measurements to support FCC equipment certification.
    - ii) Signal specific and bundled probe calibrations based on PMR (probe modulation response) characteristics are handled according to the requirements of KDB 865664; that is, "Until standardized procedures are available to make such determination, the applicability of a signal specific probe calibration for testing specific wireless modes and technologies is determined on a case-by-case basis through KDB inquiries, including SAR system verification requirements."
  - b) Calibration of SAR system validation dipoles, excluding HAC dipoles.
  - c) Calibration of data acquisition electronics DAE3Vx, DAE4Vx and DAEasyVx.
  - d) For FCC equipment certification purposes, the frequency range of SAR probe and dipole calibrations is limited to 700 MHz - 6 GHz and provided it is supported by the equipment identified in the TMC QA protocol (a separate attachment to this document).
  - e) The identical system and equipment setup, measurement configurations, hardware, evaluation algorithms, calibration and QA protocols, including the format of calibration certificates and reports used by SPEAG shall be applied by TMC.
  - f) The calibrated items are only applicable to SPEAG DASY 4 and DASY 5 or higher version systems.





- 3) The SPEAG-TMC agreement includes specific protocols identified in the following to ensure the quality of calibration services provided by TMC under this SPEAG-TMC Dual-Logo calibration agreement are equivalent to the calibration services provided by SPEAG. TMC shall, upon request, provide copies of documentation to the FCC to substantiate program implementation.
  - a) The Inter-laboratory Calibration Evaluation (ILCE) stated in the TMC QA protocol shall be performed between SPEAG and TMC at least once every 12 months. The ILCE acceptance criteria defined in the TMC QA protocol shall be satisfied for the TMC, SPEAG and FCC agreements to remain valid.
  - b) Check of Calibration Certificate (CCC) shall be performed by SPEAG for all calibrations performed by TMC. Written confirmation from SPEAG is required for TMC to issue calibration certificates under the SPEAG-TMC Dual-Logo calibration program. Quarterly reports for all calibrations performed by TMC under the program are also issued by SPEAG.
  - c) The calibration equipment and measurement system used by TMC shall be verified before each calibration service according to the specific reference SAR probes, dipoles, and DAE calibrated by SPEAG. The results shall be reproducible and within the defined acceptance criteria specified in the TMC QA protocol before each actual calibration can commence. TMC shall maintain records of the measurement and calibration system verification results for all calibrations.
  - d) Quality Check of Calibration (QCC) certificates shall be performed by SPEAG at least once every 12 months. SPEAG shall visit TMC facilities to verify the laboratory, equipment, applied procedures and plausibility of randomly selected certificates.
- 4) A copy of this document, to be updated annually, shall be provided to TMC clients that accept calibration services according to the SPEAG-TMC Dual-Logo calibration program, which should be presented to a TCB (*Telecommunication Certification Body*), to facilitate FCC equipment approval.
- 5) TMC shall address any questions raised by its clients or TCBs relating to the SPEAG-TMC Dual-Logo calibration program and inform the FCC and SPEAG of any critical issues.

Change Note: Revised on June 26 to clarify the applicability of PMR and Bundled probe calibrations according to the requirements of KDB 865664.

## ANNEX H Dipole Calibration Certificate

### 835 MHz Dipole Calibration Certificate

**Calibration Laboratory of  
Schmid & Partner  
Engineering AG**  
Zeughausstrasse 43, 8004 Zurich, Switzerland





**S** Schweizerischer Kalibrierdienst  
**S** Service suisse d'étalonnage  
**C** Servizio svizzero di taratura  
**S** Swiss Calibration Service

Accredited by the Swiss Accreditation Service (SAS)  
The Swiss Accreditation Service is one of the signatories to the EA  
Multilateral Agreement for the recognition of calibration certificates

Accreditation No.: **SCS 108**

Client: **TMC-SZ (Auden)** Certificate No.: **D835V2-4d057\_Oct12**

**CALIBRATION CERTIFICATE**

Object: **D835V2 - SN: 4d057** 受控文件  
TMC-CC-12-034-02

Calibration procedure(s): **QA CAL-05.v8**  
Calibration procedure for dipole validation kits above 700 MHz

Calibration date: **October 24, 2012**

This calibration certificate documents the traceability to national standards, which realize the physical units of measurements (SI).  
The measurements and the uncertainties with confidence probability are given on the following pages and are part of the certificate.

All calibrations have been conducted in the closed laboratory facility: environment temperature (22 ± 3)°C and humidity < 70%.



Calibration Equipment used (M&TE critical for calibration)

Primary Standards	ID #	Cal Date (Certificate No.)	Scheduled Calibration
Power meter EPM-442A	GB37480704	05-Oct-11 (No. 217-01451)	Oct-12
Power sensor HP 8481A	US37292783	05-Oct-11 (No. 217-01451)	Oct-12
Reference 20 dB Attenuator	SN: 5058 (20k)	27-Mar-12 (No. 217-01530)	Apr-13
Type-N mismatch combination	SN: 5047.2 / 06327	27-Mar-12 (No. 217-01530)	Apr-13
Reference Probe ES3DV3	SN: 3205	30-Dec-11 (No. ES3-3205_Dec11)	Dec-12
DAE4	SN: 601	27-Jun-12 (No. DAE4-601_Jun12)	Jun-13

Secondary Standards	ID #	Check Date (in house)	Scheduled Check
Power sensor HP 8481A	MY41092317	18-Oct-09 (in house check Oct-11)	In house check: Oct-13
RF generator R&S SMT-06	100005	04-Aug-09 (in house check Oct-11)	In house check: Oct-13
Network Analyzer HP 8733E	US37380585 S4206	18-Oct-01 (in house check Oct-12)	In house check: Oct-13

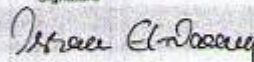

	Name	Function	Signature
Calibrated by:	Israe El-Hissouq	Laboratory Technician	
Approved by:	Katja Polovic	Technical Manager	

Issued: October 24, 2012

This calibration certificate shall not be reproduced except in full without written approval of the laboratory.

Certificate No: D835V2-4d057\_Oct12 Page 1 of 6



**Calibration Laboratory of  
Schmid & Partner  
Engineering AG**  
Zeughausstrasse 43, 8004 Zurich, Switzerland



**S** Schweizerischer Kalibrierdienst  
**C** Service suisse d'étalonnage  
**S** Servizio svizzero di taratura  
**S** Swiss Calibration Service

Accredited by the Swiss Accreditation Service (SAS)  
The Swiss Accreditation Service is one of the signatories to the EA  
Multilateral Agreement for the recognition of calibration certificates

Accreditation No.: **SCS 108**

**Glossary:**

TSL tissue simulating liquid  
ConvF sensitivity in TSL / NORM x,y,z  
N/A not applicable or not measured

**Calibration is Performed According to the Following Standards:**

- a) IEEE Std 1528-2003, "IEEE Recommended Practice for Determining the Peak Spatial-Averaged Specific Absorption Rate (SAR) in the Human Head from Wireless Communications Devices: Measurement Techniques", December 2003
- b) IEC 62209-1, "Procedure to measure the Specific Absorption Rate (SAR) for hand-held devices used in close proximity to the ear (frequency range of 300 MHz to 3 GHz)", February 2005
- c) Federal Communications Commission Office of Engineering & Technology (FCC OET), "Evaluating Compliance with FCC Guidelines for Human Exposure to Radiofrequency Electromagnetic Fields; Additional Information for Evaluating Compliance of Mobile and Portable Devices with FCC Limits for Human Exposure to Radiofrequency Emissions", Supplement C (Edition 01-01) to Bulletin 65

**Additional Documentation:**

- d) DASY4/5 System Handbook

**Methods Applied and Interpretation of Parameters:**

- *Measurement Conditions:* Further details are available from the Validation Report at the end of the certificate. All figures stated in the certificate are valid at the frequency indicated.
- *Antenna Parameters with TSL:* The dipole is mounted with the spacer to position its feed point exactly below the center marking of the flat phantom section, with the arms oriented parallel to the body axis.
- *Feed Point Impedance and Return Loss:* These parameters are measured with the dipole positioned under the liquid filled phantom. The impedance stated is transformed from the measurement at the SMA connector to the feed point. The Return Loss ensures low reflected power. No uncertainty required.
- *Electrical Delay:* One-way delay between the SMA connector and the antenna feed point. No uncertainty required.
- *SAR measured:* SAR measured at the stated antenna input power.
- *SAR normalized:* SAR as measured, normalized to an input power of 1 W at the antenna connector.
- *SAR for nominal TSL parameters:* The measured TSL parameters are used to calculate the nominal SAR result.

The reported uncertainty of measurement is stated as the standard uncertainty of measurement multiplied by the coverage factor  $k=2$ , which for a normal distribution corresponds to a coverage probability of approximately 95%.

### Measurement Conditions

DASY system configuration, as far as not given on page 1.

DASY Version	DASY5	V52.8.3
Extrapolation	Advanced Extrapolation	
Phantom	Modular Flat Phantom	
Distance Dipole Center - TSL	15 mm	with Spacer
Zoom Scan Resolution	dx, dy, dz = 5 mm	
Frequency	835 MHz $\pm$ 1 MHz	

### Head TSL parameters

The following parameters and calculations were applied.

	Temperature	Permittivity	Conductivity
Nominal Head TSL parameters	22.0 °C	41.5	0.90 mho/m
Measured Head TSL parameters	(22.0 $\pm$ 0.2) °C	41.8 $\pm$ 6 %	0.92 mho/m $\pm$ 6 %
Head TSL temperature change during test	< 0.5 °C	---	---

### SAR result with Head TSL

SAR averaged over 1 cm <sup>3</sup> (1 g) of Head TSL	Condition	
SAR measured	250 mW input power	2.44 W/kg
SAR for nominal Head TSL parameters	normalized to 1W	9.62 W/kg $\pm$ 17.0 % (k=2)

SAR averaged over 10 cm <sup>3</sup> (10 g) of Head TSL	condition	
SAR measured	250 mW input power	1.60 W/kg
SAR for nominal Head TSL parameters	normalized to 1W	6.32 W/kg $\pm$ 16.5 % (k=2)

### Body TSL parameters

The following parameters and calculations were applied.

	Temperature	Permittivity	Conductivity
Nominal Body TSL parameters	22.0 °C	55.2	0.97 mho/m
Measured Body TSL parameters	(22.0 $\pm$ 0.2) °C	53.8 $\pm$ 6 %	0.99 mho/m $\pm$ 6 %
Body TSL temperature change during test	< 0.5 °C	---	---

### SAR result with Body TSL

SAR averaged over 1 cm <sup>3</sup> (1 g) of Body TSL	Condition	
SAR measured	250 mW input power	2.43 W/kg
SAR for nominal Body TSL parameters	normalized to 1W	9.52 W/kg $\pm$ 17.0 % (k=2)

SAR averaged over 10 cm <sup>3</sup> (10 g) of Body TSL	condition	
SAR measured	250 mW input power	1.59 W/kg
SAR for nominal Body TSL parameters	normalized to 1W	6.26 W/kg $\pm$ 16.5 % (k=2)

## Appendix

### Antenna Parameters with Head TSL

Impedance, transformed to feed point	52.1 $\Omega$ - 2.7 j $\Omega$
Return Loss	- 29.5 dB

### Antenna Parameters with Body TSL

Impedance, transformed to feed point	48.1 $\Omega$ - 4.4 j $\Omega$
Return Loss	- 26.2 dB

### General Antenna Parameters and Design

Electrical Delay (one direction)	1.396 ns
----------------------------------	----------

After long term use with 100W radiated power, only a slight warming of the dipole near the feedpoint can be measured.

The dipole is made of standard semirigid coaxial cable. The center conductor of the feeding line is directly connected to the second arm of the dipole. The antenna is therefore short-circuited for DC-signals. On some of the dipoles, small end caps are added to the dipole arms in order to improve matching when loaded according to the position as explained in the "Measurement Conditions" paragraph. The SAR data are not affected by this change. The overall dipole length is still according to the Standard.

No excessive force must be applied to the dipole arms, because they might bend or the soldered connections near the feedpoint may be damaged.

### Additional EUT Data

Manufactured by	SPEAG
Manufactured on	November 27, 2006

**DASY5 Validation Report for Head TSL**

Date: 24.10.2012

Test Laboratory: SPEAG, Zurich, Switzerland

**DUT: Dipole 835 MHz; Type: D835V2; Serial: D835V2 - SN: 4d057**

Communication System: CW; Frequency: 835 MHz

Medium parameters used:  $f = 835 \text{ MHz}$ ;  $\sigma = 0.92 \text{ mho/m}$ ;  $\epsilon_r = 41.8$ ;  $\rho = 1000 \text{ kg/m}^3$

Phantom section: Flat Section

Measurement Standard: DASY5 (IEEE/IEC/ANSI C63.19-2007)

**DASY52 Configuration:**

- Probe: ES3DV3 - SN3205; ConvF(6.07, 6.07, 6.07); Calibrated: 30.12.2011;
- Sensor-Surface: 3mm (Mechanical Surface Detection)
- Electronics: DAE4 Sn601; Calibrated: 27.06.2012
- Phantom: Flat Phantom 4.9L; Type: QD000P49AA; Serial: 1001
- DASY52 52.8.3(988); SEMCAD X 14.6.7(6848)

**Dipole Calibration for Head Tissue/Pin=250 mW, d=15mm/Zoom Scan (7x7x7)/Cube 0:**

Measurement grid: dx=5mm, dy=5mm, dz=5mm

Reference Value = 55.185 V/m; Power Drift = 0.03 dB

Peak SAR (extrapolated) = 3.61 W/kg

**SAR(1 g) = 2.44 W/kg; SAR(10 g) = 1.6 W/kg**

Maximum value of SAR (measured) = 2.82 W/kg

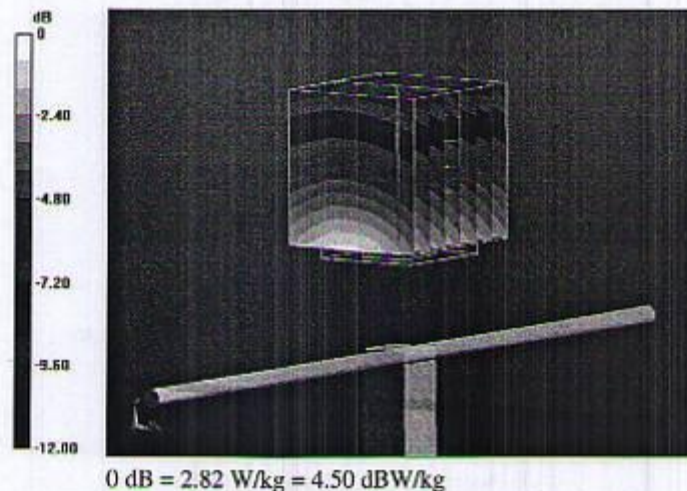

### Impedance Measurement Plot for Head TSL

24 Oct 2012 12:30:58  
 [CH1] S11 1 U F8 1: 52.131  $\Omega$  -2.6582  $\Omega$  71.784 pF 835.000 000 MHz

\*  
 De1  
 Cor

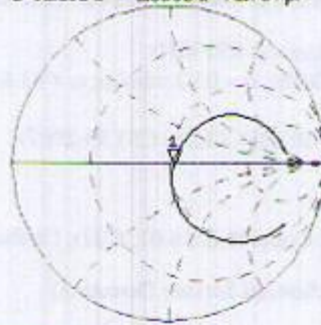

Avg  
 16

H1 d

CH2 S11 L08 5 dB/REF -20 dB 1: -29.529 dB 835.000 000 MHz

Cor

Avg  
 16

H1 d

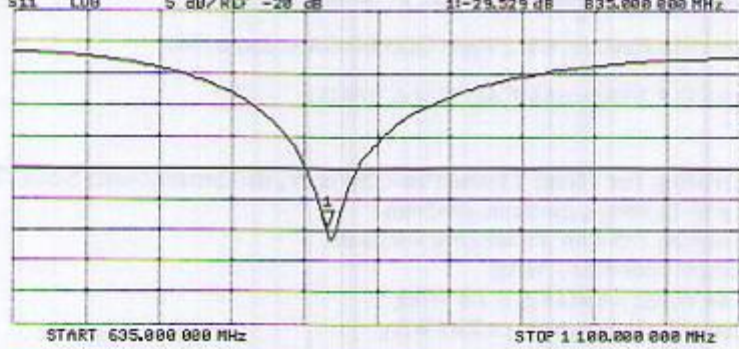

### DASY5 Validation Report for Body TSL

Date: 24.10.2012

Test Laboratory: SPEAG, Zurich, Switzerland

**DUT: Dipole 835 MHz; Type: D835V2; Serial: D835V2 - SN: 4d057**

Communication System: CW; Frequency: 835 MHz

Medium parameters used:  $f = 835 \text{ MHz}$ ;  $\sigma = 0.99 \text{ mho/m}$ ;  $\epsilon_r = 53.8$ ;  $\rho = 1000 \text{ kg/m}^3$

Phantom section: Flat Section

Measurement Standard: DASY5 (IEEE/IEC/ANSI C63.19-2007)

#### DASY52 Configuration:

- Probe: ES3DV3 - SN3205; ConvF(6.02, 6.02, 6.02); Calibrated: 30.12.2011;
- Sensor-Surface: 3mm (Mechanical Surface Detection)
- Electronics: DAE4 Sn601; Calibrated: 27.06.2012
- Phantom: Flat Phantom 4.9L; Type: QD000P49AA; Serial: 1001
- DASY52 52.8.3(988); SEMCAD X 14.6.7(6848)

#### Dipole Calibration for Body Tissue/ $P_{in}=250 \text{ mW}$ , $d=15\text{mm}$ /Zoom Scan (7x7x7)/Cube 0:

Measurement grid:  $dx=5\text{mm}$ ,  $dy=5\text{mm}$ ,  $dz=5\text{mm}$

Reference Value = 55.185 V/m; Power Drift = 0.03 dB

Peak SAR (extrapolated) = 3.53 W/kg

SAR(1 g) = 2.43 W/kg; SAR(10 g) = 1.59 W/kg

Maximum value of SAR (measured) = 2.82 W/kg

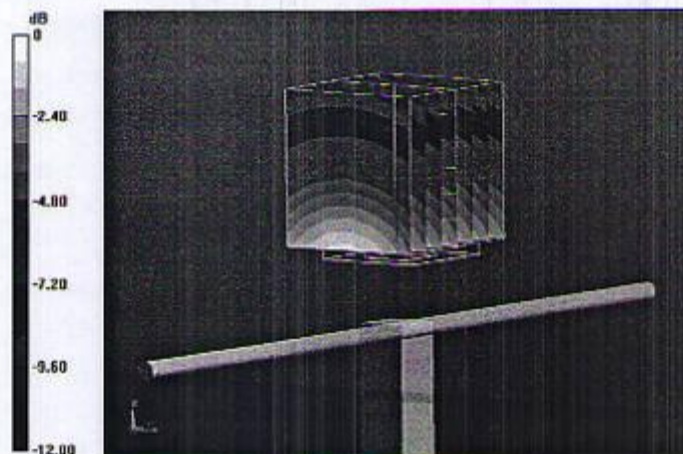

0 dB = 2.82 W/kg = 4.50 dBW/kg



### Impedance Measurement Plot for Body TSL

24 Oct 2012 09:28:43  
 CH1 S11 1 U FS 1: 48.188  $\Omega$  -4.4141  $\Omega$  43.181 pF 635.000 000 MHz

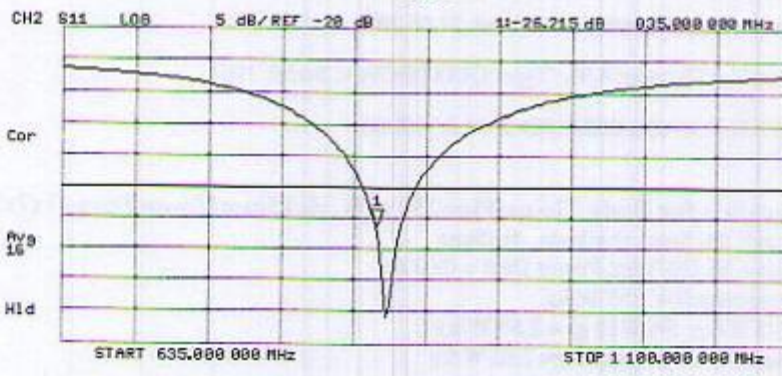
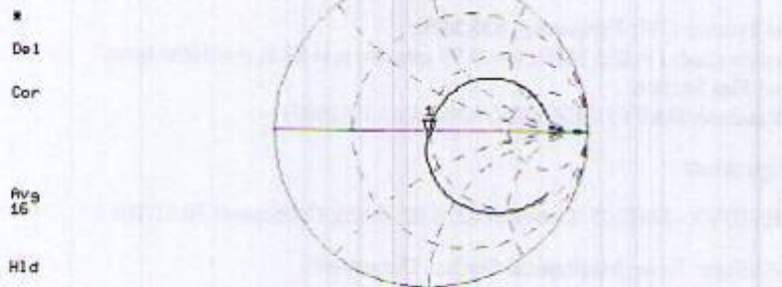

1900 MHz Dipole Calibration Certificate

Calibration Laboratory of  
Schmid & Partner  
Engineering AG  
Zaughausstrasse 43, 8004 Zurich, Switzerland



S Schweizerischer Kalibrierdienst  
C Service suisse d'étalonnage  
S Servizio svizzero di taratura  
S Swiss Calibration Service

Accredited by the Swiss Accreditation Service (SAS)  
The Swiss Accreditation Service is one of the signatories to the EA  
Multilateral Agreement for the recognition of calibration certificates

Accreditation No.: SCS 108

Client TMC-SZ (Auden)

Certificate No: D1900V2-5d088\_Oct12

**CALIBRATION CERTIFICATE**

Object D1900V2 - SN: 5d088

Calibration procedure(s) QA CAL-05.v8  
Calibration procedure for dipole validation kits above 700 MHz

Calibration date: October 17, 2012

受控文件  
 TMC-CC-12-037<sup>SZ</sup> 01

This calibration certificate documents the traceability to national standards, which realize the physical units of measurements (SI).  
The measurements and the uncertainties with confidence probability are given on the following pages and are part of the certificate.

All calibrations have been conducted in the closed laboratory facility: environment temperature ( $22 \pm 3$ )°C and humidity < 70%.

Calibration Equipment used (M&TE critical for calibration)

Primary Standards	ID #	Cal Date (Certificate No.)	Scheduled Calibration
Power meter EPM-442A	GB37480704	05-Oct-11 (No. 217-01451)	Oct-12
Power sensor HP 8481A	US37292783	05-Oct-11 (No. 217-01451)	Oct-12
Reference 20 dB Attenuator	SN: 5058 (20k)	27-Mar-12 (No. 217-01530)	Apr-13
Type-N mismatch combination	SN: 5047.2 / 06327	27-Mar-12 (No. 217-01533)	Apr-13
Reference Probe ES3DV3	SN: 3205	30-Dec-11 (No. ES3-3205_Dec11)	Dec-12
DAE4	SN: 601	27-Jun-12 (No. DAE4-601_Jun12)	Jun-13
Secondary Standards	ID #	Check Date (in house)	Scheduled Check
Power sensor HP 8481A	MY41092317	18-Oct-02 (in house check Oct-11)	In house check: Oct-13
RF generator R&S SMT-06	100005	04-Aug-99 (in house check Oct-11)	In house check: Oct-13
Network Analyzer HP 8753E	US37390585 S4206	18-Oct-01 (in house check Oct-12)	In house check: Oct-13

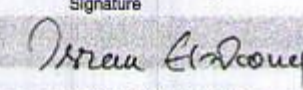
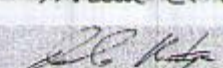
Calibrated by:	Name Israa El-Neouq	Function Laboratory Technician	Signature 
Approved by:	Name Katja Pokovic	Function Technical Manager	Signature 

Issued: October 17, 2012

This calibration certificate shall not be reproduced except in full without written approval of the laboratory.

**Calibration Laboratory of  
Schmid & Partner  
Engineering AG**  
Zeughausstrasse 43, 8004 Zurich, Switzerland



**S** Schweizerischer Kalibrierdienst  
**C** Service suisse d'étalonnage  
**S** Servizio svizzero di taratura  
**S** Swiss Calibration Service

Accredited by the Swiss Accreditation Service (SAS)  
The Swiss Accreditation Service is one of the signatories to the EA  
Multilateral Agreement for the recognition of calibration certificates

Accreditation No.: **SCS 108**

**Glossary:**

TSL	tissue simulating liquid
ConvF	sensitivity in TSL / NORM x,y,z
N/A	not applicable or not measured

**Calibration is Performed According to the Following Standards:**

- a) IEEE Std 1528-2003, "IEEE Recommended Practice for Determining the Peak Spatial-Averaged Specific Absorption Rate (SAR) in the Human Head from Wireless Communications Devices: Measurement Techniques", December 2003
- b) IEC 62209-1, "Procedure to measure the Specific Absorption Rate (SAR) for hand-held devices used in close proximity to the ear (frequency range of 300 MHz to 3 GHz)", February 2005
- c) Federal Communications Commission Office of Engineering & Technology (FCC OET), "Evaluating Compliance with FCC Guidelines for Human Exposure to Radiofrequency Electromagnetic Fields; Additional Information for Evaluating Compliance of Mobile and Portable Devices with FCC Limits for Human Exposure to Radiofrequency Emissions", Supplement C (Edition 01-01) to Bulletin 65

**Additional Documentation:**

- d) DASY4/5 System Handbook

**Methods Applied and Interpretation of Parameters:**

- *Measurement Conditions:* Further details are available from the Validation Report at the end of the certificate. All figures stated in the certificate are valid at the frequency indicated.
- *Antenna Parameters with TSL:* The dipole is mounted with the spacer to position its feed point exactly below the center marking of the flat phantom section, with the arms oriented parallel to the body axis.
- *Feed Point Impedance and Return Loss:* These parameters are measured with the dipole positioned under the liquid filled phantom. The impedance stated is transformed from the measurement at the SMA connector to the feed point. The Return Loss ensures low reflected power. No uncertainty required.
- *Electrical Delay:* One-way delay between the SMA connector and the antenna feed point. No uncertainty required.
- *SAR measured:* SAR measured at the stated antenna input power.
- *SAR normalized:* SAR as measured, normalized to an input power of 1 W at the antenna connector.
- *SAR for nominal TSL parameters:* The measured TSL parameters are used to calculate the nominal SAR result.

The reported uncertainty of measurement is stated as the standard uncertainty of measurement multiplied by the coverage factor  $k=2$ , which for a normal distribution corresponds to a coverage probability of approximately 95%.

### Measurement Conditions

DASY system configuration, as far as not given on page 1.

DASY Version	DASY5	V52.8.3
Extrapolation	Advanced Extrapolation	
Phantom	Modular Flat Phantom	
Distance Dipole Center - TSL	10 mm	with Spacer
Zoom Scan Resolution	dx, dy, dz = 5 mm	
Frequency	1900 MHz ± 1 MHz	

### Head TSL parameters

The following parameters and calculations were applied.

	Temperature	Permittivity	Conductivity
Nominal Head TSL parameters	22.0 °C	40.0	1.40 mho/m
Measured Head TSL parameters	(22.0 ± 0.2) °C	40.0 ± 6 %	1.37 mho/m ± 6 %
Head TSL temperature change during test	< 0.5 °C	----	----

### SAR result with Head TSL

SAR averaged over 1 cm <sup>3</sup> (1 g) of Head TSL	Condition	
SAR measured	250 mW input power	9.86 W/kg
SAR for nominal Head TSL parameters	normalized to 1W	40.0 W/kg ± 17.0 % (k=2)

SAR averaged over 10 cm <sup>3</sup> (10 g) of Head TSL	condition	
SAR measured	250 mW input power	5.19 W/kg
SAR for nominal Head TSL parameters	normalized to 1W	20.9 W/kg ± 16.5 % (k=2)

### Body TSL parameters

The following parameters and calculations were applied.

	Temperature	Permittivity	Conductivity
Nominal Body TSL parameters	22.0 °C	53.3	1.52 mho/m
Measured Body TSL parameters	(22.0 ± 0.2) °C	52.2 ± 6 %	1.54 mho/m ± 6 %
Body TSL temperature change during test	< 0.5 °C	----	----

### SAR result with Body TSL

SAR averaged over 1 cm <sup>3</sup> (1 g) of Body TSL	Condition	
SAR measured	250 mW input power	10.2 W/kg
SAR for nominal Body TSL parameters	normalized to 1W	40.3 W/kg ± 17.0 % (k=2)

SAR averaged over 10 cm <sup>3</sup> (10 g) of Body TSL	condition	
SAR measured	250 mW input power	5.40 W/kg
SAR for nominal Body TSL parameters	normalized to 1W	21.4 W/kg ± 16.5 % (k=2)

**Appendix**

**Antenna Parameters with Head TSL**

Impedance, transformed to feed point	52.0 $\Omega$ + 5.9 j $\Omega$
Return Loss	- 24.3 dB

**Antenna Parameters with Body TSL**

Impedance, transformed to feed point	48.9 $\Omega$ + 6.2 j $\Omega$
Return Loss	- 24.0 dB

**General Antenna Parameters and Design**

Electrical Delay (one direction)	1.195 ns
----------------------------------	----------

After long term use with 100W radiated power, only a slight warming of the dipole near the feedpoint can be measured.

The dipole is made of standard semirigid coaxial cable. The center conductor of the feeding line is directly connected to the second arm of the dipole. The antenna is therefore short-circuited for DC-signals. On some of the dipoles, small end caps are added to the dipole arms in order to improve matching when loaded according to the position as explained in the "Measurement Conditions" paragraph. The SAR data are not affected by this change. The overall dipole length is still according to the Standard.

No excessive force must be applied to the dipole arms, because they might bend or the soldered connections near the feedpoint may be damaged.

**Additional EUT Data**

Manufactured by	SPEAG
Manufactured on	June 28, 2006

**DASY5 Validation Report for Head TSL**

Date: 17.10.2012

Test Laboratory: SPEAG, Zurich, Switzerland

**DUT: Dipole 1900 MHz; Type: D1900V2; Serial: D1900V2 - SN: 5d088**

Communication System: CW; Frequency: 1900 MHz

Medium parameters used:  $f = 1900$  MHz;  $\sigma = 1.37$  mho/m;  $\epsilon_r = 40$ ;  $\rho = 1000$  kg/m<sup>3</sup>

Phantom section: Flat Section

Measurement Standard: DASY5 (IEEE/IEC/ANSI C63.19-2007)

**DASY52 Configuration:**

- Probe: ES3DV3 - SN3205; ConvF(5.01, 5.01, 5.01); Calibrated: 30.12.2011;
- Sensor-Surface: 3mm (Mechanical Surface Detection)
- Electronics: DAE4 Sn601; Calibrated: 27.06.2012
- Phantom: Flat Phantom 5.0 (front); Type: QD000P50AA; Serial: 1001
- DASY52 52.8.3(988); SEMCAD X 14.6.7(6848)

**Dipole Calibration for Head Tissue/Pin=250 mW, d=10mm/Zoom Scan (7x7x7)/Cube 0:**

Measurement grid: dx=5mm, dy=5mm, dz=5mm

Reference Value = 94.805 V/m; Power Drift = 0.04 dB

Peak SAR (extrapolated) = 17.6 W/kg

**SAR(1 g) = 9.86 W/kg; SAR(10 g) = 5.19 W/kg**

Maximum value of SAR (measured) = 12.1 W/kg

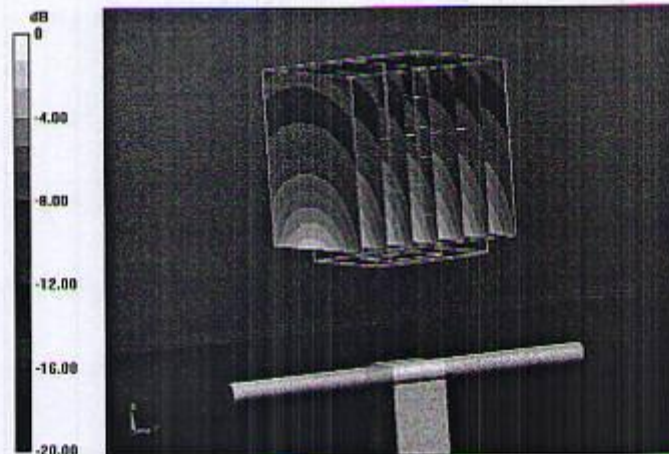

0 dB = 12.1 W/kg = 10.83 dBW/kg

### Impedance Measurement Plot for Head TSL

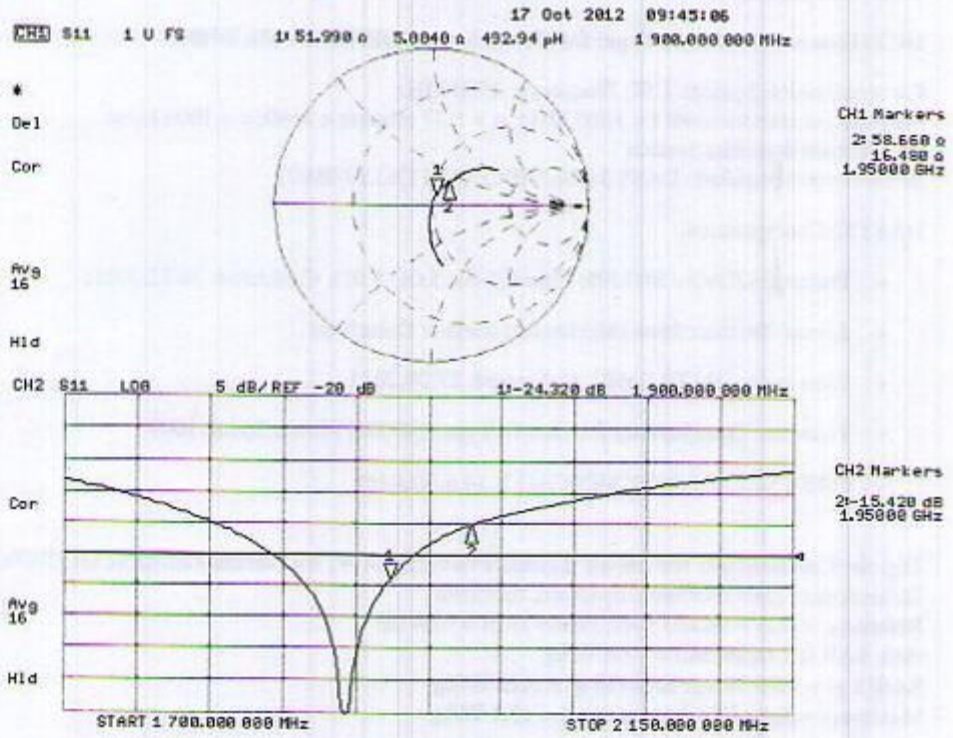

**DASY5 Validation Report for Body TSL**

Date: 17.10.2012

Test Laboratory: SPEAG, Zurich, Switzerland

**DUT: Dipole 1900 MHz; Type: D1900V2; Serial: D1900V2 - SN: 5d088**

Communication System: CW; Frequency: 1900 MHz

Medium parameters used:  $f = 1900 \text{ MHz}$ ;  $\sigma = 1.54 \text{ mho/m}$ ;  $\epsilon_r = 52.2$ ;  $\rho = 1000 \text{ kg/m}^3$

Phantom section: Flat Section

Measurement Standard: DASY5 (IEEE/IEC/ANSI C63.19-2007)

**DASY52 Configuration:**

- Probe: ES3DV3 - SN3205; ConvF(4.62, 4.62, 4.62); Calibrated: 30.12.2011;
- Sensor-Surface: 3mm (Mechanical Surface Detection)
- Electronics: DAE4 Sn601; Calibrated: 27.06.2012
- Phantom: Flat Phantom 5.0 (back); Type: QD000P50AA; Serial: 1002
- DASY52 52.8.3(988); SEMCAD X 14.6.7(6848)

**Dipole Calibration for Body Tissue/Pin=250 mW, d=10mm/Zoom Scan (7x7x7)/Cube 0:**

Measurement grid: dx=5mm, dy=5mm, dz=5mm

Reference Value = 94.805 V/m; Power Drift = 0.03 dB

Peak SAR (extrapolated) = 17.9 W/kg

**SAR(1 g) = 10.2 W/kg; SAR(10 g) = 5.4 W/kg**

Maximum value of SAR (measured) = 12.8 W/kg

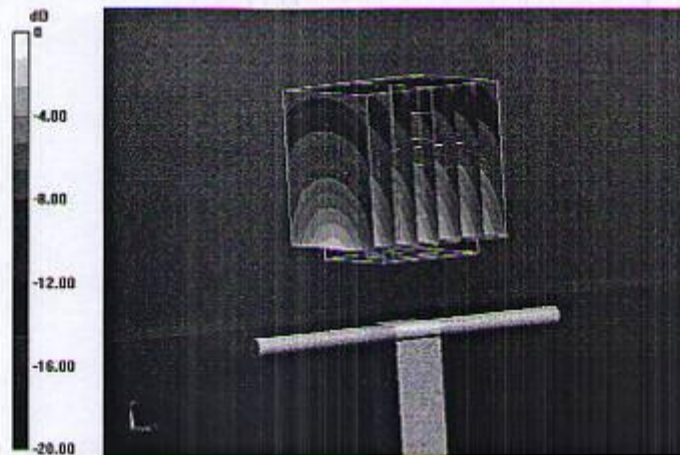

0 dB = 12.8 W/kg = 11.07 dBW/kg



### Impedance Measurement Plot for Body TSL

17 Oct 2012 09:44:40  
 CH1 S11 1 U FS 1: 48.941  $\Omega$  6.1855  $\Omega$  518.14  $\mu\text{H}$  1 900.000 000 MHz

\*  
 Del  
 Cor  
 Avg  
 16  
 H1d



CH1 Markers  
 2: 54.713  $\Omega$   
 16.599  $\Omega$   
 1.95000 GHz

CH2 S11 LOG 5 dB/REF -20 dB 1: -23.972 dB 1 900.000 000 MHz

Cor  
 Avg  
 16  
 H1d

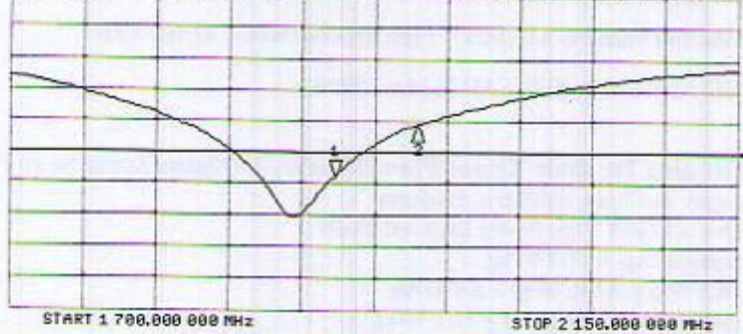

CH2 Markers  
 2: -15.785 dB  
 1.95000 GHz

START 1 700.000 000 MHz STOP 2 150.000 000 MHz

## ANNEX E Accreditation Certificate

 	
<b>China National Accreditation Service for Conformity Assessment</b>	
<b>LABORATORY ACCREDITATION CERTIFICATE</b>	
<b>(Registration No. CNAS L0570 )</b>	
<b>China Academy of Telecommunication Research of MIIT</b>	
<u>No.52, Huayuan North Road, Haidian District, Beijing, China</u>	
<p><i>is accredited to ISO/IEC 17025:2005 General Requirements for the Competence of Testing and Calibration Laboratories(CNAS-CL01 Accreditation Criteria for the Competence of Testing and Calibration Laboratories) for the competence of testing and calibration.</i></p> <p><i>The scope of accreditation is detailed in the attached appendices bearing the same registration number as above. The appendices form an integral part of this certificate.</i></p>	
<b>Date of Issue:</b> 2014-06-20	
<b>Date of Expiry:</b> 2017-06-19	
<b>Date of Initial Accreditation:</b> 1998-07-03	
<b>Date of Update:</b> 2014-06-20	
Signed on behalf of China National Accreditation Service for Conformity Assessment	
<small>China National Accreditation Service for Conformity Assessment (CNAS) is authorized by Certification and Accreditation Administration of the People's Republic of China (CNCA) to operate the national accreditation schemes for conformity assessment. CNAS is the signatory to International Laboratory Accreditation Cooperation Multilateral Recognition Arrangement (ILAC MRA) and Asia Pacific Laboratory Accreditation Cooperation Multilateral Recognition Arrangement (APLAC MRA).</small>	
No.CNAS AL 2	0010037