



TEST REPORT

Report No.: SRMC2008-H024-E0004

Product Name: GSM/GPRS Mobile Phone

Product Model: Philips 9@9q

Manufacture: Shenzhen Sang Fei Consumer
Communications Co., Ltd

Specification: FCC Part 15B

The State Radio Monitoring Center, Equipment Testing Division

The State Radio Spectrum Monitoring and Testing Center

No.80 Beilishi Road Xicheng District Beijing, China

Tel: 86-10-68009202 Fax: 86-10-68009205

CONTENTS

1. General information	3
1.1 Notes of the test report	3
1.2 Information about the testing laboratory.....	3
1.3 Applicant's details	3
1.4 Manufacturer's details.....	3
1.5 Application details	4
1.6 Reference specification.....	4
1.7 Information of EUT	4
1.7.1 General information.....	4
1.7.2 EUT details	5
1.7.3 Auxiliary equipment details.....	5
2. Test information:	6
2.1 Summary of the test results:	6
2.2.1 Conducted Emissions-FCC Part15.107	7
2.2.2 Radiated Emissions -FCC Part15.109	9
2.3. List of test equipments	11
Appendix.....	12

1. General information

1.1 Notes of the test report

The test report may only be reproduced or published in full. Reproduction or publication of extracts from the report requires the prior written permission of The State Radio Monitoring Center.

The test results relate only to individual items of the samples which have been tested.

1.2 Information about the testing laboratory

Company: The State Radio Monitoring Center, Equipment Testing Division
The State Radio Spectrum Monitoring and Testing Center
Address: No.80 Beilishi Road, Xicheng District, Beijing China
City: Beijing
Country or Region: China
Contacted person: Wang Junfeng
Tel: +86 10 68009181 +86 10 68009202
Fax: +86 10 68009195 +86 10 68009205
Email: Wangjf@srrc.org.cn

1.3 Applicant's details

Company: Shenzhen Sang Fei Consumer Communications Co., Ltd.
Address: 11 Science and Technology Road, Shenzhen Hi-tech
Industrial Park Nanshan District, Shenzhen, PRC
City: ShenZhen City, GuangDong
Country or Region: P.R.China
Grantee Code: VQR
Contacted person: Helen Lin
Tel: 86-755-26633217
Fax: 86-755-26635272
Email: helen.lin@sangfei.com

1.4 Manufacturer's details

Company: Shenzhen Sang Fei Consumer Communications Co., Ltd.
Address: 11 Science and Technology Road, Shenzhen Hi-tech Industrial
Park Nanshan District, Shenzhen, PRC
City: ShenZhen City, GuangDong
Country or Region: P.R.China
Grantee Code: VQR
Contacted person: Helen Lin
Tel: 86-755-26633217
Fax: 86-755-26635272
Email: helen.lin@sangfei.com

1.5 Application details

Date of receipt of application: 3th Dec. 2007
Date of receipt of test sample: 3th Dec. 2007
Date of test: 4th Dec. 2007 to 19th Dec. 2007

1.6 Reference specification

FCC Part 15B

1.7 Information of EUT

1.7.1 General information

Name of EUT	GSM/GPRS Mobile Phone
FCC ID	VQRCT9A9Q
Frequency range	PCS1900: Tx:1850~1910MHz Rx:1930~1990MHz
Rated output power	PCS1900:30.0dBm
Modulation type	GMSK
Duplex mode	FDD
Duplex spacing:	PCS1900:80MHz
Antenna type	Integral
Power Supply	Battery or charger
Rated Power Supply Voltage	3.8V
Extreme Temperature	-30°C~+50°C

1.7.2 EUT details

Name	Model	Serial number
GSM/GPRS Mobile Phone	Philips 9@9q	35197802000260



1.7.3 Auxiliary equipment details

Equipment	Notebook
Manufacturer	IBM
Model Number	T23

2. Test information:

2.1 Summary of the test results:

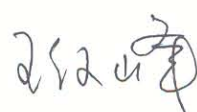
No.	Test case	FCC reference	Verdict
1	Conducted emissions	15.107	Pass
2	Radiated emissions	15.109	Pass

This Test Report Is Issued by: 	Checked by: 
Tested by: 	Issued date: 2008.2.14

2.2 Test result

2.2.1 Conducted Emissions-FCC Part15.107

Ambient condition:

Temperature	Relative humidity	Pressure
21°C	45%	101.0kPa

Test Setup:

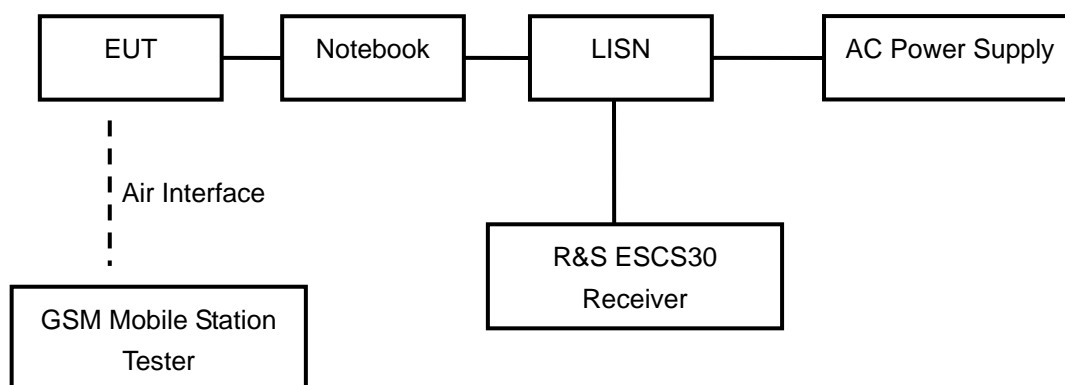

Test Procedure:

The EUT is placed on a non-metallic table 0.8m above the horizontal metal reference ground plane. The EUT is operating in the USB mode. During the test EUT is connected to the notebook via a USB cable. And the data transferring between EUT and notebook is maintained. The notebook is connected to LISN and LISN is connected to the reference ground. The AC power supply is connected with notebook through other LISN. The distance between notebook and LISN is 80cm. The measurement should be done both L line and N line. The receiver uses both average detector and quasi-peak detector. The output power of the EUT is controlled by the tester and driven to maximum value.

Frequency of Emission(MHz)	Limits(dB μ V)	
	Quasi-peak	Average
0.15~0.5	66 to 56*	56 to 46*
0.5~5	56	46
5~30	60	50

Note: * Decreases with the logarithm of the frequency

Test result:
 Refer to the following figures.

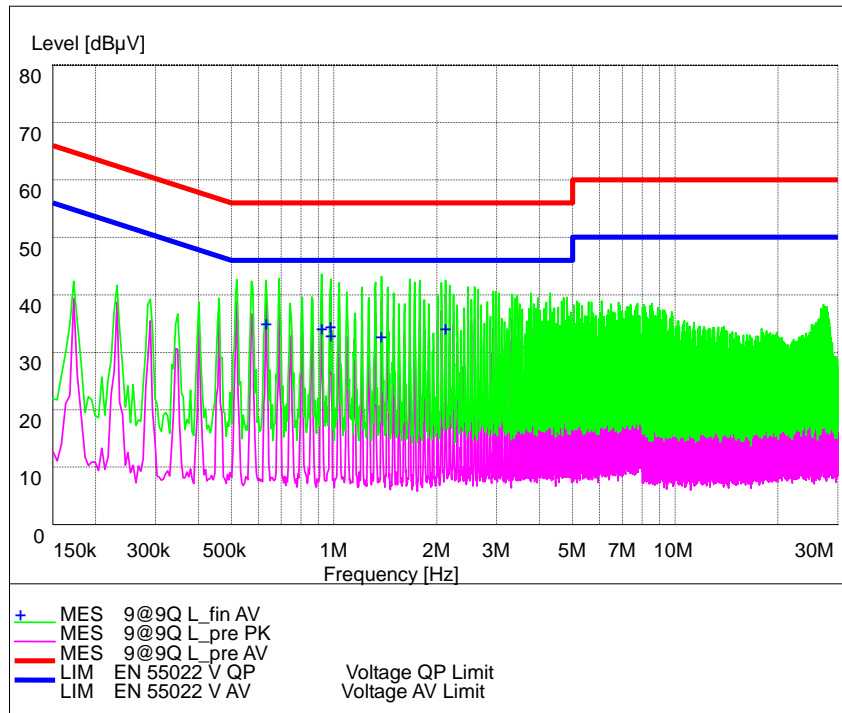

L Line

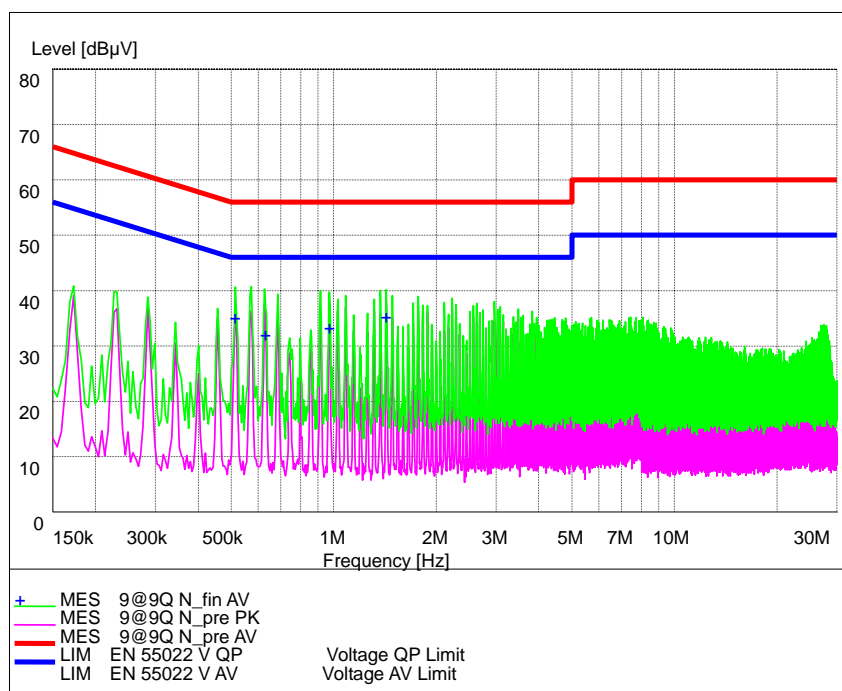

N Line

2.2.2 Radiated Emissions -FCC Part15.109

Ambient condition:

Temperature	Relative humidity	Pressure
21°C	45%	101.0kPa

Test Setup:

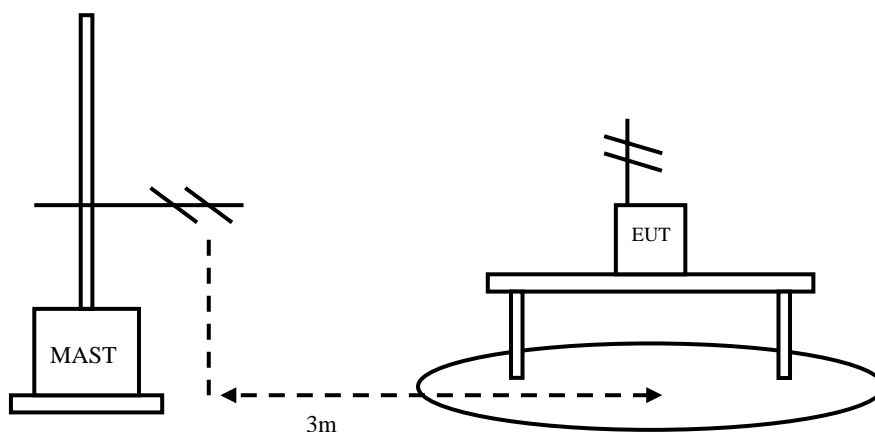

Test Procedure:

The EUT and receive antenna shall be placed to SAC (semi anechoic chamber) upon a non-metallic turn table. The receive antennas shall be moved from 1 to 4 meters. The distance between equipment and receive antenna shall be 3 meters.

The EUT is operating in the USB mode. During the test EUT is connected to the notebook via a USB cable. And the data transferring between EUT and notebook is maintained. Testing shall operate the EUT with the operation and cable positions in a test set-up which is representative of typical system configurations, as declared by the manufacturer. The output port shall be terminated with 50 ohms.

Then start the test software ES-K1. Sweep the whole frequency band through the range from 30MHz to 1GHz, using receive log period antenna HL562.

During the test, the height of receive antenna shall be moved from 1 to 4 meters, and the antenna shall be performed under horizontal and vertical polarization. The turn table shall be rotated from 0 to 360 degrees for detecting the maximum of radiated spurious signal level. The measurements shall be repeated with orthogonal polarization of the test antenna.

The data of cable loss and antenna factor has been calibrated in full testing frequency range before the testing.

Frequency of Emission(MHz)	Limits	
	Unit(μ V/m)	Average(dB μ V/m)
30~88	100	40
88~216	150	43.5
216~960	200	46
960~1000	500	54

Test result:
 Refer to the following figures.

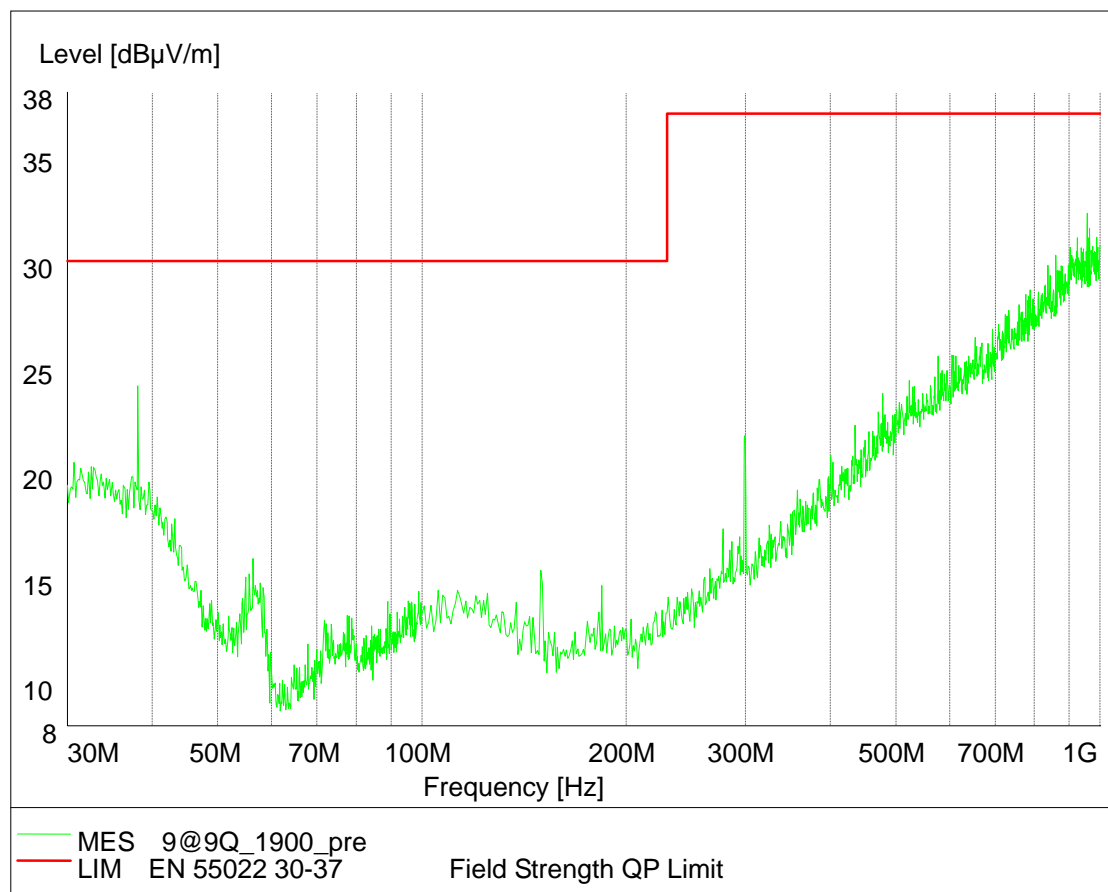

2.3. List of test equipments

No.	Name/Model	Manufacturer	S/N	Calibration Date
1	8960 E5515C Mobile Station Tester	Agilent	GB44050904	Mar. 2007
2	PSA E4440A Spectrum Analyzer	Agilent	MY41000183	Mar. 2007
5	66309B DC Power Supply	Agilent	MY43000461	Aug. 2007
6	1506A Power Splitter	Weinschel	MN154	Aug. 2007
7	9.080m×5.255m×3.525m Shielding room	FRANKONIA	-----	Aug. 2007
8	ESI 40 EMI test receiver	R&S	100015	Aug. 2007
9	SMR 20 Signal generator	R&S	100086	Aug. 2007
10	CMU 200 Radio tester	R&S	100313	Aug. 2007
11	12.65m*8.03m*7.50m Fully-Anechoic Chamber	FRANKONIA	-----	Aug. 2007
12	HL562 Ultra log test antenna	R&S	100016	Aug. 2007
13	ESH3-Z2 Pulse limiter	R&S	10002	Aug. 2007
14	ESH3-Z5 Attenuator	R&S	100020	Aug. 2007
15	ESH2Z11 LISN	R&S	50FH-020-10	Aug. 2007
16	CMU 200 Radio tester	R&S	100313	Aug. 2007
17	HF 906 Double-Ridged Waveguide Horn Antenna	R&S	100030	Aug. 2007
18	HF 906 Double-Ridged Waveguide Horn Antenna	R&S	100029	Aug. 2007
19	PS2000 Turn Table	FRANKONIA	-----	Aug. 2007
20	MA260 Antenna Master	FRANKONIA	-----	Aug. 2007
21	SH-241 Climatic Chamber	ESPEC	92000389	Aug. 2007
22	E5515C Mobile Station Tester	Agilent	GB45071696	Aug. 2007
23	ES-K1 EMI test software	R&S	-----	Aug. 2007
24	HL562 Receive antenna	R&S	100167	Aug. 2007

Appendix

Appendix1 Test Setup