



SAR Test Report

Product Name : Smartphone

Model No. : W5510

FCC ID : VQR-W5510

Applicant : SHENZHEN SANGFEI CONSUMER COMMUNICATIONS
CO.,LTD

Address : 11 Science and Technology Road, Shenzhen Hi-tech
industrial Park Nanshan District. Shenzhen, PRC

Date of Receipt : 01/02/2013

Date of Test : 06/02/2013

Issued Date : 16/02/2013

Report No. : 132S005R-HP-US-P03V01

Report Version : V 2.1

The test results relate only to the samples tested.

The test report shall not be reproduced except in full without the written approval of Quietek Corporation.

Test Report Certification

Issued Date: 16/02/2013

Report No.: 132S005R-HP-US-P03V01



Product Name : Smartphone

Applicant : SHENZHEN SANGFEI CONSUMER COMMUNICATIONS
CO.,LTD

Address : 11 Science and Technology Road, Shenzhen Hi-tech industrial
Park Nanshan District. Shenzhen, PRC

Manufacturer : SHENZHEN SANGFEI CONSUMER COMMUNICATIONS
CO.,LTD

Address : 11 Science and Technology Road, Shenzhen Hi-tech industrial
Park Nanshan District. Shenzhen, PRC

Model No. : W5510

FCC ID : VQR-W5510

Brand Name : PHILIPS

EUT Voltage : DC 3.7V

Applicable Standard : FCC Oet65 Supplement C June 2001
IEEE Std. 1528-2003,47CFR § 2.1093

Test Result : Max. SAR Measurement (1g)
Head: 0.793 W/kg
Body: 1.143 W/kg

Performed Location : Suzhou EMC Laboratory
No.99 Hongye Rd., Suzhou Industrial Park Loufeng Hi-Tech
Development Zone., Suzhou, China
TEL: +86-512-6251-5088 / FAX: +86-512-6251-5098
FCC Registration Number: 800392

Documented By : Alice Ni
(Engineering ADM: Alice Ni)

Reviewed By : Robin Wu
(Engineering Supervisor: Robin Wu)

Approved By : Marlin Chen
(Manager: Marlin Chen)

Laboratory Information

We, **Quietek Corporation**, are an independent EMC and safety consultancy that was established the whole facility in our laboratories. The test facility has been accredited/accepted(audited or listed) by the following related bodies in compliance with ISO 17025, EN 45001 and specified testing scope:

Taiwan R.O.C.	:	BSMI, NCC, TAF
Germany	:	TUV Rheinland
Norway	:	Nemko, DNV
USA	:	FCC, NVLAP
Japan	:	VCCI
China	:	CNAS

The related certificate for our laboratories about the test site and management system can be downloaded from Quietek Corporation's Web Site :<http://www.quietek.com/tw/ctg/cts/accreditations.htm>

The address and introduction of Quietek Corporation's laboratories can be founded in our Web site :
<http://www.quietek.com/>

If you have any comments, Please don't hesitate to contact us. Our contact information is as below:

HsinChu Testing Laboratory :

No.75-2, 3rd Lin, Wangye Keng, Yonghxing Tsuen, Qionglin Shiang, Hsinchu County 307, Taiwan, R.O.C.
TEL:+886-3-592-8858 / FAX:+886-3-592-8859 E-Mail : service@quietek.com

LinKou Testing Laboratory :

No.5-22, Ruishukeng, Linkou Dist., New Taipei City 24451, Taiwan, R.O.C.
TEL : 886-2-8601-3788 / FAX : 886-2-8601-3789 E-Mail : service@quietek.com

Suzhou Testing Laboratory :

No.99 Hongye Rd., Suzhou Industrial Park Loufeng Hi-Tech Development Zone., SuZhou, China
TEL : +86-512-6251-5088 / FAX : 86-512-6251-5098 E-Mail : service@quietek.com

TABLE OF CONTENTS

Description	Page
1. General Information	6
1.1. EUT Description	6
1.2. Test Environment.....	8
1.3. EUT Antenna Locations.....	8
1.4. Simultaneous Transmission Configurations.....	9
1.5. SAR Test Exclusions Applied.....	9
1.6. Power Reduction for SAR.....	10
1.7. Guidance Documents	10
2. SAR Measurement System	11
2.1. DASY5 System Description.....	11
2.1.1. Applications	12
2.1.2. Area Scans	12
2.1.3. Zoom Scan (Cube Scan Averaging).....	12
2.1.4. Uncertainty of Inter-/Extrapolation and Averaging.....	12
2.2. DASY5 E-Field Probe.....	13
2.2.1. Isotropic E-Field Probe Specification	13
2.3. Boundary Detection Unit and Probe Mounting Device	14
2.4. DATA Acquisition Electronics (DAE) and Measurement Server.....	14
2.5. Robot.....	15
2.6. Light Beam Unit.....	15
2.7. Device Holder.....	16
2.8. SAM Twin Phantom	16
3. Tissue Simulating Liquid	17
3.1. The composition of the tissue simulating liquid	17
3.2. Tissue Calibration Result.....	18
3.3. Tissue Dielectric Parameters for Head and Body Phantoms.....	19
4. SAR Measurement Procedure.....	20
4.1. SAR System Validation.....	20
4.1.1. Validation Dipoles	20
4.1.2. Validation Result	21
4.2. SAR Measurement Procedure.....	23
4.3. Body-Worn Accessory Configurations	24

4.4.	Wireless Router Configurations	25
4.5.	SAR Measurement Conditions for UMTS	26
4.5.1.	Output Power Verification	26
4.5.2.	Head SAR Measurements for Handsets	26
4.5.3.	Body SAR Measurements.....	26
4.5.4.	SAR Measurements for Handsets with Rel 5 HSDPA	26
4.5.5.	SAR Measurements for Handsets with Rel 6 HSUPA	27
5.	SAR Exposure Limits.....	28
6.	Test Equipment List	29
7.	Measurement Uncertainty.....	30
8.	Conducted Power Measurement	31
9.	Test Results	35
9.1.	SAR Test Results Summary	35
9.2.	SAR Test Notes	45
Appendix A.	SAR System Validation Data	49
Appendix B.	SAR measurement Data.....	55
Appendix C.	Test Setup Photographs & EUT Photographs	115
Appendix D.	Probe Calibration Data	124
Appendix E.	Dipole Calibration Data.....	135
Appendix F.	DAE Calibration Data	160

1. General Information

1.1. EUT Description

Product Name	Smartphone
Model No.	W5510
IMEI	911131205416242
Hardware Version	SR701_V2.0
Software Version	PhilipsW5510-user 4.0.4 IMM76D eng.root.20130122.224030 test-keys
Device Category	Portable
RF Exposure Environment	Uncontrolled
Antenna Type	Internal
GPS	
Operate Frequency	1575.42MHz
Type of modulation	BPSK
2G	
Support Band	GSM850/PCS1900
GPRS Type	Class B
GPRS Class	Class 12
Uplink	GSM 850: 824~849MHz PCS 1900: 1850~1910MHz
Downlink	GSM 850: 869~894MHz PCS 1900: 1930~1990MHz
Release Version	R99
Type of modulation	GMSK for GSM/GPRS/EDGE
Antenna Gain	GSM 850: -1.5dBi PCS1900: -0.5dBi
Max. Output Power (Conducted)	GSM850: 32.06dBm PCS1900: 29.20dBm
Max. Output Power (Radiated)	GSM850: 30.08dBm- ERP PCS1900: 28.49dBm- EIRP
3G	
Support Band	WCDMA Band II/WCDMA Band V
Uplink	WCDMA Band II: 1850~1910MHz WCDMA Band V: 824~849MHz
Downlink	WCDMA Band II: 1930~1990MHz

	WCDMA Band V: 869~894MHz
Release Version	Rel-6
Type of modulation	QPSK
Antenna Gain	WCDMA Band II: -0.5dBi WCDMA Band V: -1.5dBi
Max. Output Power (Conducted)	WCDMA Band II: 22.81dBm WCDMA Band V: 23.19dBm
Max. Output Power (Radiated)	WCDMA Band II: 22.10dBm - EIRP WCDMA Band V: 21.23dBm - ERP
Bluetooth	
Bluetooth Frequency	2402~2480MHz
Bluetooth Version	V3.0
Type of modulation	FHSS
Data Rate	1Mbps(GFSK), 2Mbps(Pi/4 DQPSK), 3Mbps (8DPSK)
Antenna Gain	-2.5dBi
Wi-Fi	
Hotspots Function	YES
Wi-Fi Frequency	802.11b/g/n(20MHz): 2412 ~ 2462 MHz
Type of modulation	802.11b: DSSS; 802.11g/n: OFDM
Data Rate	802.11b: 1/2/5.5/11 Mbps
	802.11g: 6/9/12/18/24/36/48/54 Mbps
	802.11n: up to 65 Mbps
Antenna Gain	-2.5dBi

1.2. Test Environment

Ambient conditions in the laboratory:

Items	Required	Actual
Temperature (°C)	18-25	21.5± 2
Humidity (%RH)	30-70	52

1.3. EUT Antenna Locations

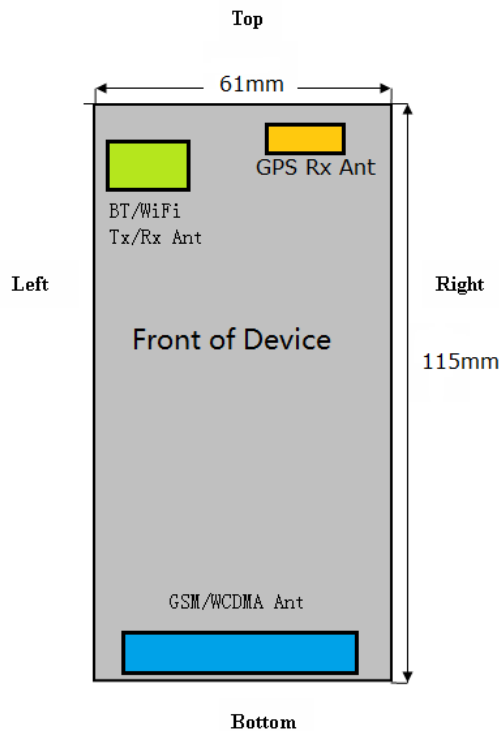

Note: Specific antenna dimensions and separation distances are shown in the EUT Photo.

Mobile Hotspot Sides for SAR Testing

Mode	Back	Front	Top	Bottom	Right	Left
GPRS850	Yes	Yes	No	Yes	Yes	Yes
GPRS1900	Yes	Yes	No	Yes	Yes	Yes
UMTS850	Yes	Yes	No	Yes	Yes	Yes
UMTS1900	Yes	Yes	No	Yes	Yes	Yes
2.4GHz WLAN	Yes	Yes	Yes	No	No	Yes

Note: Particular DUT edges were not required to be evaluated for Wireless Router SAR if the edges were greater than 2.5 cm from the transmitting antenna according to FCC KDB Publication 941225 D06v01 guidance, page 2. The antenna photo shows the distances between the transmit antennas and the edges of the device.

1.4. Simultaneous Transmission Configurations

According to FCC KDB Publication 447498 D05v01,transmitter are considered to be transmitting simultaneously when there is overlapping transmission, with the exception of transmissions during network hand-offs with maximum hand-off duration less than 30 seconds. This device contains multiple transmitters that may operate simultaneously, and therefore requires a simultaneously transmission analysis according to FCC KDB Publication 447498 D01v05 3) procedures.

**Table 1-1
Simultaneous Transmission Scenarios**

Ref.	Simultaneous Transmit Configurations	Head	Body-Worn Accessory	Hotspot	Note
		IEEE1528 Supp C	Supplement C	FCC KDB941225 D06	
1	GSM850 Voice + 2.4GHz Bluetooth	No	Yes	No	
2	GSM1900 Voice + 2.4GHz Bluetooth	No	Yes	No	
3	UMTS850 Voice + 2.4GHz Bluetooth	No	Yes	No	
4	UMTS1900 Voice + 2.4GHz Bluetooth	No	Yes	No	
5	GSM850 Voice + 2.4GHz Wi-Fi	Yes	Yes	No	
6	GSM1900 Voice + 2.4GHz Wi-Fi	Yes	Yes	No	
7	UMTS850 Voice + 2.4GHz Wi-Fi	Yes	Yes	No	
8	UMTS1900 Voice + 2.4GHz Wi-Fi	Yes	Yes	No	
9	GPRS850 Data + 2.4GHz Wi-Fi	No	No	Yes	GPRS + Wi-Fi Hotspot
10	GPRS1900 Data + 2.4GHz Wi-Fi	No	No	Yes	GPRS + Wi-Fi Hotspot
11	UMTS850 Data + 2.4GHz Wi-Fi	Yes	Yes	Yes	UMTS + Wi-Fi Hotspot
12	UMTS190 Data + 2.4GHz Wi-Fi	Yes	Yes	Yes	UMTS + Wi-Fi Hotspot

Note: Bluetooth and WIFI share the same antenna and cannot transmit simultaneously.

1.5. SAR Test Exclusions Applied

(A) Wi-Fi/Bluetooth

Per FCC KDB 447498 D01v05,the SAR exclusion threshold for distances<50mm is defined by the following equation:

$$\frac{\text{Max Power of Channel (mW)}}{\text{Test Separation Dist (mm)}} * \sqrt{\text{Frequency(GHz)}} \leq 3.0$$

Based on the maximum conducted power of Bluetooth and the antenna to use separation distance, Bluetooth SAR was not required; [(3.47mW/10)* √2.480]=0.55 <3.0.

IEEE 802.11g/n were not evaluated for SAR since the average output power was not more than 0.25 dB higher than the average output power of IEEE 802.11b.

(B) Licensed Transmitter(s)

GSM/GPRS/EDGE DTM is not supported for US bands. Therefore, the GSM Voice modes in this report do not transmit simultaneously with GPRS/EDGE Data.

This device is only capable of QPSK HSUPA in the uplink. Therefore, no additional SAR tests are required beyond that described for devices with HSUPA in KDB 941225 D01v02.

When the user utilizes multiple services in UMTS 3G mode it uses multi-Radio Access Bearer or multi-RAB. The power control is based on a physical control channel (Dedicated Physical Control Channel [DPCCH]) and power control will be adjusted to meet the needs of both services. Therefore, the UMTS+WLAN scenario also represents the UMTS Voice/DATA + WLAN Hotspot scenario.

1.6. Power Reduction for SAR

There is no power reduction used for any band/mode implemented in this device for SAR purposes.

1.7. Guidance Documents

- 1) FCC KDB Publication 941225 D01-D06 (2G/3G and Hotspot)
- 2) FCC KDB Publication 447498 D01v05(General SAR Guidance)
- 3) FCC KDB Publication 865664 D01v01(SAR measurement 100 MHz to 6 GHz)
- 4) FCC KDB Publication 248227 D01v01r02 (SAR Considerations for 802.11 Devices)

2. SAR Measurement System

2.1. DASY5 System Description

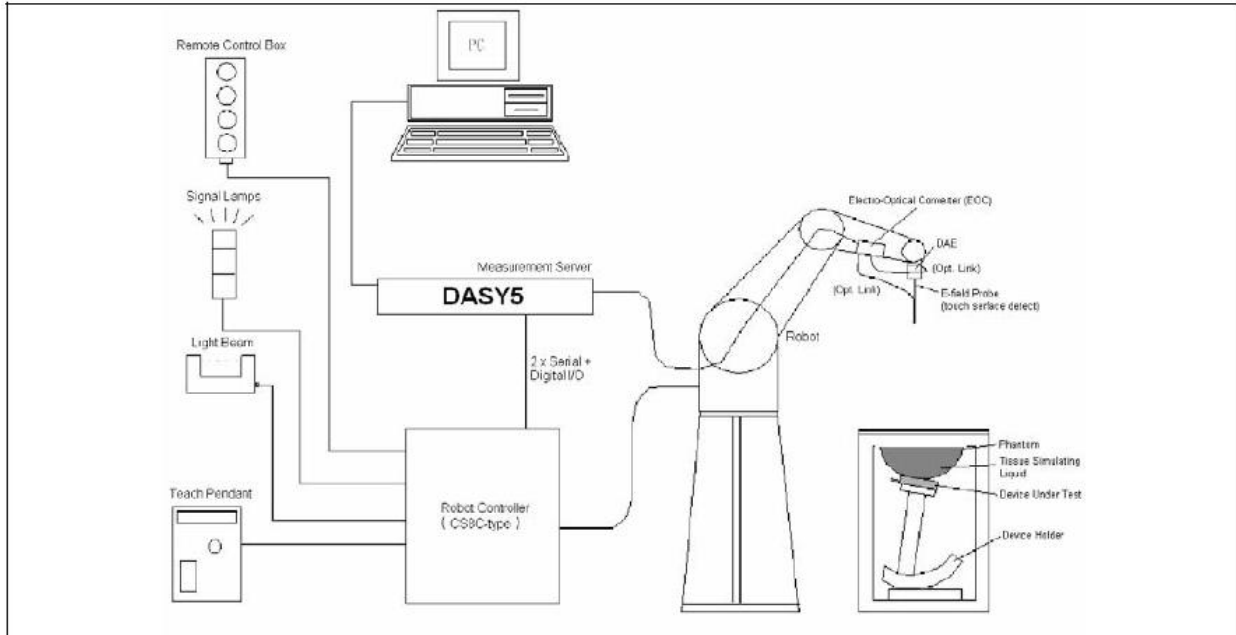

The DASY5 system for performing compliance tests consists of the following items:

- A standard high precision 6-axis robot with controller, teach pendant and software. An arm extension for accommodating the data acquisition electronics (DAE).
- A data acquisition electronics (DAE) which performs the signal amplification, signal multiplexing, AD-conversion, offset measurements, mechanical surface detection, collision detection, etc. The unit is battery powered with standard or rechargeable batteries. The signal is optically transmitted to the EOC.
- The Electro-optical converter (EOC) performs the conversion from optical to electrical signals for the digital communication to the DAE. To use optical surface detection, a special version of the EOC is required. The EOC signal is transmitted to the measurement server.
- The Light Beam used is for probe alignment. This improves the (absolute) accuracy of the probe positioning.
- A computer running WinXP and the DASY5 software.
- Remote control and teach pendant as well as additional circuitry for robot safety such as warning lamps, etc.
- The phantom, the device holder and other accessories according to the targeted measurement.

2.1.1. Applications

Predefined procedures and evaluations for automated compliance testing with all worldwide standards, e.g., IEEE 1528, OET 65, IEC 62209-1, IEC 62209-2, EN 50360, EN 50383 and others.

2.1.2. Area Scans

Area scans are defined prior to the measurement process being executed with a user defined variable spacing between each measurement point (integral) allowing low uncertainty measurements to be conducted. Scans defined for FCC applications utilize a 10mm² step integral, with 1mm interpolation used to locate the peak SAR area used for zoom scan assessments.

When an Area Scan has measured all reachable points, it computes the field maxima found in the scanned area, within a range of the global maximum. The range (in dB) is specified in the standards for compliance testing. For example, a 2 dB range is required in IEEE 1528-2003 and IEC 62209 standards, whereby 3 dB is a requirement when compliance is assessed in accordance with the ARIB standard (Japan).

2.1.3. Zoom Scan (Cube Scan Averaging)

Zoom Scans are used to assess the peak spatial SAR values within a cubic averaging volume containing 1 g and 10 g of simulated tissue. A density of 1000 kg/m³ is used to represent the head and body tissue density and not the phantom liquid density, in order to be consistent with the definition of the liquid dielectric properties, i.e. the side length of the 1 g cube is 10mm, with the side length of the 10 g cube 21,5mm.

The zoom scan integer steps can be user defined so as to reduce uncertainty, but normal practice for typical test applications utilize a physical step of 7x7x7 (5mmx5mmx5mm) providing a volume of 30mm in the X & Y axis, and 30mm in the Z axis.

2.1.4. Uncertainty of Inter-/Extrapolation and Averaging

In order to evaluate the uncertainty of the interpolation, extrapolation and averaged SAR calculation algorithms of the Postprocessor, DASY5 allows the generation of measurement grids which are artificially predefined by analytically based test functions. Therefore, the grids of area scans and zoom scans can be filled with uncertainty test data, according to the SAR benchmark functions of IEEE 1528. The three analytical functions shown in equations as below are used to describe the possible range of the expected SAR distributions for the tested handsets. The field gradients are covered by the spatially flat distribution f1, the spatially steep distribution f3 and f2 accounts for H-field cancellation on the phantom/tissue surface.

$$f_1(x, y, z) = Ae^{-\frac{z}{2a}} \cos^2 \left(\frac{\pi \sqrt{x'^2 + y'^2}}{2 \cdot 5a} \right)$$

$$f_2(x, y, z) = Ae^{-\frac{z}{a}} \frac{a^2}{a^2 + x'^2} \left(3 - e^{-\frac{2z}{a}} \right) \cos^2 \left(\frac{\pi y'}{2 \cdot 3a} \right)$$

$$f_3(x, y, z) = A \frac{a^2}{\frac{a^2}{4} + x'^2 + y'^2} \left(e^{-\frac{2z}{a}} + \frac{a^2}{2(a + 2z)^2} \right)$$

2.2. DASY5 E-Field Probe

The SAR measurement is conducted with the dosimetric probe manufactured by SPEAG. The probe is specially designed and calibrated for use in liquid with high permittivity. The dosimetric probe has special calibration in liquid at different frequency. SPEAG conducts the probe calibration in compliance with international and national standards (e.g. IEEE 1528, EN 62209-1, IEC 62209, etc.) under ISO 17025. The calibration data are in Appendix D.

2.2.1. Isotropic E-Field Probe Specification

Model	EX3DV4	
Construction	Symmetrical design with triangular core Built-in shielding against static charges PEEK enclosure material (resistant to organic solvents, e.g., DGBE)	
Frequency	10 MHz to 6 GHz Linearity: ± 0.2 dB (30 MHz to 6 GHz)	
Directivity	± 0.3 dB in HSL (rotation around probe axis) ± 0.5 dB in tissue material (rotation normal to probe axis)	
Dynamic Range	10 µW/g to 100 mW/g Linearity: ± 0.2 dB (noise: typically < 1 µW/g)	
Dimensions	Overall length: 330 mm (Tip: 20 mm) Tip diameter: 2.5 mm (Body: 12 mm) Typical distance from probe tip to dipole centers: 1 mm	
Application	High precision dosimetric measurements in any exposure scenario (e.g., very strong gradient fields). Only probe which enables compliance testing for frequencies up to 6 GHz with precision of better 30%.	

2.3. Boundary Detection Unit and Probe Mounting Device

The DASY5 probes use a precise connector and an additional holder for the probe, consisting of a plastic tube and a flexible silicon ring to center the probe. The connector at the DAE is flexibly mounted and held in the default position with magnets and springs. Two switching systems in the connector mount detect frontal and lateral probe collisions and trigger the necessary software response.

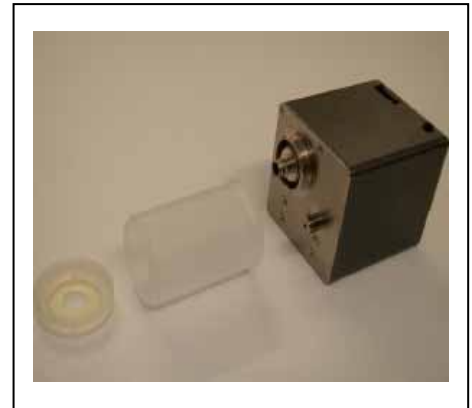

2.4. DATA Acquisition Electronics (DAE) and Measurement Server

The data acquisition electronics (DAE) consists of a highly sensitive electrometer-grade preamplifier with auto-zeroing, a channel and gain-switching multiplexer, a fast 16 bit AD-converter and a command decoder and control logic unit.

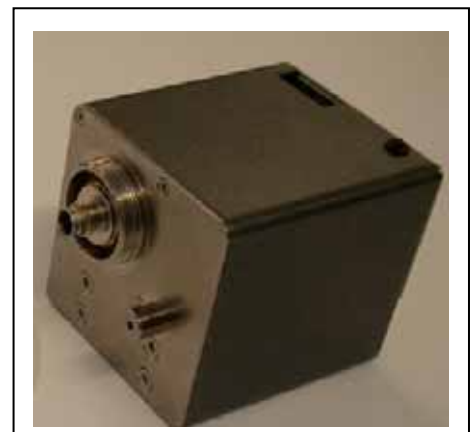

Transmission to the measurement server is accomplished through an optical downlink for data and status information as well as an optical uplink for commands and the clock.

The input impedance of the DAE4 is 200M Ohm; the inputs are symmetrical and floating. Common mode rejection is above 80dB.

The DASY5 measurement server is based on a PC/104 CPU board with a 400MHz intel ULV Celeron, 128MB chipdisk and 128MB RAM. The necessary circuits for communication with the DAE electronics box, as well as the 16 bit AD converter system for optical detection and digital I/O interface are contained on the DASY5 I/O board, which is directly connected to the PC/104 bus of the CPU board.



2.5. Robot

The DASY5 system uses the high precision robots TX90 XL type out of the newer series from Stäubli SA (France). For the 6-axis controller DASY5 system, the CS8C robot controller version from Stäubli is used.

The XL robot series have many features that are important for our application:

- High precision (repeatability 0.02 mm)
- High reliability (industrial design)
- Jerk-free straight movements
- Low ELF interference (the closed metallic construction shields against motor control fields)
- 6-axis controller



2.6. Light Beam Unit

The light beam switch allows automatic "tooling" of the probe. During the process, the actual position of the probe tip with respect to the robot arm is measured, as well as the probe length and the horizontal probe offset. The software then corrects all movements, such that the robot coordinates are valid for the probe tip.

The repeatability of this process is better than 0.1 mm. If a position has been taught with an aligned probe, the same position will be reached with another aligned probe within 0.1 mm, even if the other probe has different dimensions. During probe rotations, the probe tip will keep its actual position.



2.7. Device Holder

The DASY5 device holder is designed to cope with different positions given in the standard. It has two scales for the device rotation (with respect to the body axis) and the device inclination (with respect to the line between the ear reference points). The rotation center for both scales is the ear reference point (EPR).

Thus the device needs no repositioning when changing the angles.

The DASY5 device holder has been made out of low-loss POM material having the following dielectric parameters: relative permittivity $\epsilon_r = 3$ and loss tangent $\delta = 0.02$. The amount of dielectric material has been reduced in the closest vicinity of the device, since measurements have suggested that the influence of the clamp on the test results could thus be lowered.



2.8. SAM Twin Phantom

The SAM twin phantom is a fiberglass shell phantom with 2mm shell thickness (except the ear region where shell thickness increases to 6mm). It has three measurement areas:

- Left head
- Right head
- Flat phantom



The bottom plate contains three pair of bolts for locking the device holder. The device holder positions are adjusted to the standard measurement positions in the three sections. A white cover is provided to tap the phantom during off-periods to prevent water evaporation and changes in the liquid parameters. On the phantom top, three reference markers are provided to identify the phantom position with respect to the robot.

3. Tissue Simulating Liquid

3.1. The composition of the tissue simulating liquid

INGREDIENT (% Weight)	835MHz Head	835MHz Body	1900MHz Head	1900MHz Body	2450MHz Head	2450MHz Body
Water	40.45	52.4	54.90	40.5	46.7	73.2
Salt	1.45	1.40	0.18	0.50	0.00	0.04
Sugar	57.6	45.0	0.00	58.0	0.00	0.00
HEC	0.40	1.00	0.00	0.50	0.00	0.00
Preventol	0.10	0.20	0.00	0.50	0.00	0.00
DGBE	0.00	0.00	44.92	0.00	53.3	26.7

3.2. Tissue Calibration Result

The dielectric parameters of the liquids were verified prior to the SAR evaluation using DASY5 Dielectric Probe Kit and Agilent Vector Network Analyzer E5071C

Head Tissue Simulant Measurement				
Frequency [MHz]	Description	Dielectric Parameters		Tissue Temp. [°C]
		ϵ_r	σ [s/m]	
835 MHz	Reference result ± 5% window	41.50 39.43 to 43.58	0.90 0.86 to 0.95	N/A
	06-02-2013	41.87	0.90	21.0
1900 MHz	Reference result ± 5% window	40.00 38.00 to 42.00	1.40 1.33 to 1.47	N/A
	06-02-2013	39.21	1.44	21.0
2450MHz	Reference result ± 5% window	39.2 37.24 to 41.16	1.80 1.71 to 1.89	N/A
	06-02-2013	38.08	1.86	21.0

Body Tissue Simulant Measurement				
Frequency [MHz]	Description	Dielectric Parameters		Tissue Temp. [°C]
		ϵ_r	σ [s/m]	
835 MHz	Reference result ± 5% window	55.2 52.44 to 57.96	0.97 0.92 to 1.02	N/A
	06-02-2013	53.93	0.96	21.0
1900 MHz	Reference result ± 5% window	53.3 50.64 to 55.97	1.52 1.44 to 1.60	N/A
	06-02-2013	54.21	1.53	21.0
2450MHz	Reference result ± 5% window	52.7 50.07 to 55.34	1.95 1.85 to 2.05	N/A
	06-02-2013	53.33	1.90	21.0

3.3. Tissue Dielectric Parameters for Head and Body Phantoms

The head tissue dielectric parameters recommended by the IEEE SCC-34/SC-2 in P1528 have been incorporated in the following table. These head parameters are derived from planar layer models simulating the highest expected SAR for the dielectric properties and tissue thickness variations in a human head. Other head and body tissue parameters that have not been specified in P1528 are derived from the tissue dielectric parameters computed from the 4-Cole-Cole equations described in Reference [12] and extrapolated according to the head parameters specified in P1528.

Target Frequency (MHz)	Head		Body	
	ϵ_r	σ (S/m)	ϵ_r	σ (S/m)
150	52.3	0.76	61.9	0.80
300	45.3	0.87	58.2	0.92
450	43.5	0.87	56.7	0.94
835	41.5	0.90	55.2	0.97
900	41.5	0.97	55.0	1.05
915	41.5	0.98	55.0	1.06
1450	40.5	1.20	54.0	1.30
1610	40.3	1.29	53.8	1.40
1800 – 2000	40.0	1.40	53.3	1.52
2450	39.2	1.80	52.7	1.95
3000	38.5	2.40	52.0	2.73
5800	35.3	5.27	48.2	6.00

(ϵ_r = relative permittivity, σ = conductivity and $\rho = 1000 \text{ kg/m}^3$)

4. SAR Measurement Procedure

4.1. SAR System Validation

4.1.1. Validation Dipoles

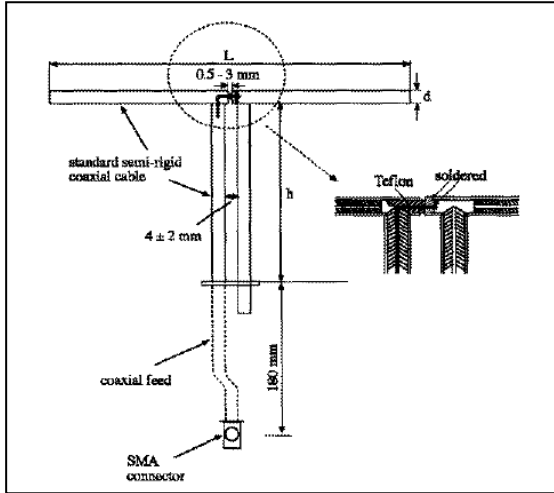

The dipoles used is based on the IEEE-1528 standard, and is complied with mechanical and electrical specifications in line with the requirements of both IEEE and FCC Supplement C. the table below provides details for the mechanical and electrical specifications for the dipoles.

Frequency	L (mm)	h (mm)	d (mm)
835MHz	161.0	89.8	3.6
1900MHz	68.0	39.5	3.6
2450MHz	51.5	30.4	3.6

4.1.2. Validation Result

System Performance Check at 835MHz &1900MHz &2450MHz for Head				
Validation Kit: D835V2-SN 4d120				
Frequency [MHz]	Description	SAR [w/kg] 1g	SAR [w/kg] 10g	Tissue Temp. [°C]
835 MHz	Reference result ± 10% window	9.41 8.47 to 10.35	6.15 5.54 to 6.77	N/A
	06-02-2013	9.76	6.36	21.0
Validation Kit: D1900V2-SN 5d142				
Frequency [MHz]	Description	SAR [w/kg] 1g	SAR [w/kg] 10g	Tissue Temp. [°C]
1900 MHz	Reference result ± 10% window	39.4 35.46 to 43.34	20.8 18.72 to 22.88	N/A
	06-02-2013	39.72	20.08	21.0
Validation Dipole: D2450V2, SN: 839				
Frequency [MHz]	Frequency [MHz]	Frequency [MHz]	Frequency [MHz]	Frequency [MHz]
2450 MHz	Reference result ± 10% window	51.9 46.71 to 57.09	24.1 21.69 to 26.51	N/A
	06-02-2013	52.00	23.20	21.0
Note: All SAR values are normalized to 1W forward power.				
System Performance Check at 835MHz &1900MHz &2450MHz for Body				
Validation Kit: D835V2-SN 4d120				
Frequency [MHz]	Description	SAR [w/kg] 1g	SAR [w/kg] 10g	Tissue Temp. [°C]
835 MHz	Reference result ± 10% window	9.57 8.61 to 10.53	6.33 5.70 to 6.96	N/A
	06-02-2013	9.88	6.44	21.0
Validation Kit: D1900V2-SN 5d142				
Frequency [MHz]	Description	SAR [w/kg] 1g	SAR [w/kg] 10g	Tissue Temp. [°C]
1900 MHz	Reference result ± 10% window	38.7 34.83 to 42.57	20.4 18.36 to 22.44	N/A
	06-02-2013	41.20	21.32	21.0

Validation Dipole: D2450V2, SN: 839				
Frequency [MHz]	Description	SAR [w/kg] 1g	SAR [w/kg] 10g	Tissue Temp. [°C]
2450 MHz	Reference result ± 10% window	48.7 43.83 to 53.57	22.8 20.52 to 25.08	N/A
	06-02-2013	46.80	21.28	21.0
Note: All SAR values are normalized to 1W forward power.				

4.2. SAR Measurement Procedure

The DASY5 calculates SAR using the following equation,

$$SAR = \frac{\sigma |E|^2}{\rho}$$

σ : represents the simulated tissue conductivity

ρ : represents the tissue density

The EUT is set to transmit at the required power in line with product specification, at each frequency relating to the LOW, MID, and HIGH channel settings.

Pre-scans are made on the device to establish the location for the transmitting antenna, using a large area scan in either air or tissue simulation fluid.

The EUT is placed against the Universal Phantom where the maximum area scan dimensions are larger than the physical size of the resonating antenna. When the scan size is not large enough to cover the peak SAR distribution, it is modified by either extending the area scan size in both the X and Y directions, or the device is shifted within the predefined area.

The area scan is then run to establish the peak SAR location (interpolated resolution set at 1mm²) which is then used to orient the center of the zoom scan. The zoom scan is then executed and the 1g and 10g averages are derived from the zoom scan volume (interpolated resolution set at 1mm³).

4.3. Body-Worn Accessory Configurations

Body-worn operating configurations are tested with the belt-clips and holsters attached to the device and positioned against a flat phantom in a normal use configuration. Per FCC KDB Publication 648474 D04_v01, Body-worn accessory exposure is typically related to voice mode operations when handsets are carried in body-worn accessories. The body-worn accessory procedures in FCC KDB Publication 447498 D01_v05 should be used to test for body-worn accessory SAR compliance, without a headset connected to it. This enables the test results for such configuration to be compatible with that required for hotspot mode when the body-worn accessory test separation distance is greater than or equal to that required for hotspot mode, when applicable. When the reported SAR for a body-worn accessory, measured without a headset connected to the handset, is > 1.2 W/kg, the highest reported SAR configuration for that wireless mode and frequency band should be repeated for that body-worn accessory with a headset attached to the handset.

Accessories for Body-worn operation configurations are divided into two categories: those that do not contain metallic components and those that do contain metallic components. When multiple accessories that do not contain metallic components are supplied with the device, the device is tested with only the accessory that dictates the closest spacing to the body. Then multiple accessories that contain metallic components are tested with the device with each accessory. If multiple accessories share an identical metallic component (i.e. the same metallic belt-clip used with different holsters with no other metallic components) only the accessory that dictates the closest spacing to the body is tested.

Body-worn accessories may not always be supplied or available as options for some devices intended to be authorized for body-worn use. In this case, a test configuration with a separation distance between the back of the device and the flat phantom is used. Test position spacing was documented. Transmitters that are designed to operate in front of a person's face, as in push-to-talk configurations, are tested for SAR compliance with the front of the device positioned to face the flat phantom in head fluid. For devices that are carried next to the body such as a shoulder, waist or chest-worn transmitters, SAR compliance is tested with the accessories, including headsets and microphones, attached to the device and positioned against a flat phantom in a normal use configuration.

4.4. Wireless Router Configurations

Some battery-operated handsets have the capability to transmit and receive user data through simultaneous transmission of WIFI simultaneously with a separate licensed transmitter. The FCC has provided guidance in FCC KDB Publication 941225 D06 v01 where SAR test considerations for handsets ($L \times W \geq 9 \text{ cm} \times 5 \text{ cm}$) are based on a composite test separation distance of 10 mm from the front, back and edges of the device containing transmitting antennas within 2.5 cm of their edges, determined from general mixed use conditions for this type of devices. Since the hotspot SAR results may overlap with the body-worn accessory SAR requirements, the more conservative configurations can be considered, thus excluding some body-worn accessory SAR tests.

When the user enables the personal wireless router functions for the handset, actual operations include simultaneous transmission of both the WIFI transmitter and another licensed transmitter. Both transmitters often do not transmit at the same transmitting frequency and thus cannot be evaluated for SAR under actual use conditions due to the limitations of the SAR assessment probes. Therefore, SAR must be evaluated for each frequency transmission and mode separately and spatially summed with the WIFI transmitter according to FCC KDB Publication 447498 D01v05 publication procedures. The "Portable Hotspot" feature on the handset was NOT activated during SAR assessments, to ensure the SAR measurements were evaluated for a single transmission frequency RF signal at a time.

4.5. SAR Measurement Conditions for UMTS

4.5.1. Output Power Verification

Maximum output power is measured on the High, Middle and Low channels for each applicable transmission band according to the general descriptions in section 5.2 of 3GPP TS 34.121, using the appropriate RMC or AMR with TPC (transmit power control) set to all “1s”.

Maximum output power is verified on the High, Middle and Low channels according to the general descriptions in section 5.2 of 3GPP TS 34.121 (release 5), using the appropriate RMC with TPC (transmit power control) set to all “1s” or applying the required inner loop power control procedures to maintain maximum output power while HSUPA is active. Results for all applicable physical channel configurations (DPCCH, DPDCHn and spreading codes, HS-DPCCH etc) are tabulated in this test report. All configurations that are not supported by the DUT or cannot be measured due to technical or equipment limitations are identified.

4.5.2. Head SAR Measurements for Handsets

SAR for head exposure configurations is measured using the 12.2 kbps RMC with TPC bits configured to all “1s”. SAR in AMR configurations is not required when the maximum average output of each RF channel for 12.2 kbps AMR is less than 0.25 dB higher than that measured in 12.2 kbps RMC. Otherwise, SAR is measured on the maximum output channel in 12.2 AMR with a 3.4 kbps SRB (signaling radio bearer) using the exposure configuration that resulted in the highest SAR for that RF channel in the 12.2 kbps RMC mode.

4.5.3. Body SAR Measurements

SAR for body exposure configurations is measured using the 12.2 kbps RMC with the TPC bits all “1s”.

4.5.4. SAR Measurements for Handsets with Rel 5 HSDPA

Body SAR for HSDPA is not required for handsets with HSDPA capabilities when the maximum average output power of each RF channel with HSDPA active is less than 0.25 dB higher than that measured without HSDPA using 12.2 kbps RMC and the maximum SAR for 12.2 kbps RMC is $\leq 75\%$ of the SAR limit. Otherwise, SAR is measured for HSDPA, using an FRC with H-Set 1 in Sub-test 1 and a 12.2 kbps RMC configured in Test Loop Mode 1, using the highest body SAR configuration measured in 12.2 kbps RMC without HSDPA, on the maximum output channel with the body exposure configuration that resulted in the highest SAR in 12.2 kbps RMC mode for that RF channel.

The H-set used in FRC for HSDPA should be configured according to the UE category of a test device. The number of HS-DSCH/HSPDSCHs, HARQ processes, minimum inter-TTI interval, transport block sizes and RV coding sequence are defined by the applicable H-set. To maintain a consistent test configuration and stable transmission conditions, QPSK is used in the FRC for SAR testing. HS-DPCCH should be configured with a CQI feedback cycle of 2 ms to maintain a constant rate of active CQI slots. DPCCH and DPDCH gain factors of $\beta_c=9$ and $\beta_d=15$, and power offset parameters of $\Delta_{ACK}=\Delta_{NACK}=5$ and $\Delta_{CQI}=2$ is used. The CQI value is determined by the UE category, transport block size, number of HS-PDSCHs and modulation used in the FRC.

4.5.5. SAR Measurements for Handsets with Rel 6 HSUPA

Body SAR for HSUPA is not required when the maximum average output of each RF channel with HSUPA/HSDPA active is less than 0.25 dB higher than as measured without HSUPA/HSDPA using 12.2 kbps RMC and maximum SAR for 12.2 kbps RMC is $\leq 75\%$ of the SAR limit. Otherwise SAR is measured on the maximum output channel for the body exposure configuration produced highest SAR in 12.2 kbps RMC for that RF channel, using the additional procedures under “Release 6 HSPA data devices”

Head SAR for VOIP operations under HSPA is not required when maximum average output of each RF channel with HSPA is less than 0.25 dB higher than as measured using 12.2 kbps RMC. Otherwise SAR is measured using same HSPA configuration as used for body SAR.

Sub-test	β_c	β_d	β_d (SF)	β_c/β_d	$\beta_{1w}^{(1)}$	β_{ec}	β_{ed}	β_{ed} (SF)	β_{ed} (codes)	CM ⁽²⁾ (dB)	MPR (dB)	AG ⁽⁴⁾ Index	E-TFCI
1	11/15 ⁽³⁾	15/15 ⁽³⁾	64	11/15 ⁽³⁾	22/15	209/225	1039/225	4	1	1.0	0.0	20	75
2	6/15	15/15	64	6/15	12/15	12/15	94/75	4	1	3.0	2.0	12	67
3	15/15	9/15	64	15/9	30/15	30/15	$\beta_{ed1}: 47/15$ $\beta_{ed2}: 47/15$	4	2	2.0	1.0	15	92
4	2/15	15/15	64	2/15	4/15	2/15	56/75	4	1	3.0	2.0	17	71
5	15/15 ⁽⁴⁾	15/15 ⁽⁴⁾	64	15/15 ⁽⁴⁾	30/15	24/15	134/15	4	1	1.0	0.0	21	81

Note 1: $\Delta_{ACK}, \Delta_{NACK}$ and $\Delta_{CQI} = 8 \Leftrightarrow A_{1w} = \beta_{1w}/\beta_c = 30/15 \Leftrightarrow \beta_{1w} = 30/15 * \beta_c$.

Note 2: CM = 1 for $\beta_c/\beta_d = 12/15, \beta_{1w}/\beta_c = 24/15$. For all other combinations of DPDCH, DPCCH, HS-DPCCH, E-DPDCH and E-DPCCH the MPR is based on the relative CM difference.

Note 3: For subtest 1 the β_c/β_d ratio of 11/15 for the TFC during the measurement period (TF1, TF0) is achieved by setting the signaled gain factors for the reference TFC (TF1, TF1) to $\beta_c = 10/15$ and $\beta_d = 15/15$.

Note 4: For subtest 5 the β_c/β_d ratio of 15/15 for the TFC during the measurement period (TF1, TF0) is achieved by setting the signaled gain factors for the reference TFC (TF1, TF1) to $\beta_c = 14/15$ and $\beta_d = 15/15$.

Note 5: Testing UE using E-DPDCH Physical Layer category 1 Sub-test 3 is not required according to TS 25.306 Table 5.1g.

Note 6: β_{ed} can not be set directly; it is set by Absolute Grant Value.

5. SAR Exposure Limits

SAR assessments have been made in line with the requirements of IEEE-1528, FCC Supplement C, and comply with ANSI/IEEE C95.1-1992 “Uncontrolled Environments” limits. These limits apply to a location which is deemed as “Uncontrolled Environment” which can be described as a situation where the general public may be exposed to an RF source with no prior knowledge or control over their exposure.

Limits for General Population/Uncontrolled Exposure (W/kg)

Type Exposure	Uncontrolled Environment Limit
Spatial Peak SAR (1g cube tissue for brain or body)	1.60 W/kg
Spatial Average SAR (whole body)	0.08 W/kg
Spatial Peak SAR (10g for hands, feet, ankles and wrist)	4.00 W/kg

6. Test Equipment List

Instrument	Manufacturer	Model No.	Serial No.	Cali. Due Date
Stäubli Robot TX60L	Stäubli	TX60L	F10/5C90A1/A/01	only once
Controller	Stäubli	SP1	S-0034	only once
Dipole Validation Kits	Speag	D835V2	4d094	2013.02.17
Dipole Validation Kits	Speag	D1900V2	5d121	2013.02.22
Dipole Validation Kits	Speag	D2450V2	839	2013.02.23
SAM Twin Phantom	Speag	SAM	TP-1561/1562	N/A
Device Holder	Speag	SD 000 H01 HA	N/A	N/A
Data Acquisition Electronic	Speag	DAE4	915	2013.06.21
E-Field Probe	Speag	EX3DV4	3710	2013.03.12
SAR Software	Speag	DASY5	V5.2 Build 162	N/A
Power Amplifier	Mini-Circuit	ZVA-183-S+	N657400950	N/A
Directional Coupler	Agilent	778D	20160	N/A
Universal Radio Communication Tester	R&S	CMU 200	117088	2013.04.18
Vector Network	Agilent	E5071C	MY48367267	2013.04.10
Signal Generator	Agilent	E4438C	MY49070163	2013.04.18
Power Meter	Anritsu	ML2495A	0905006	2013.11.10
Wide Bandwidth Sensor	Anritsu	MA2411B	0846014	2013.11.10

7. Measurement Uncertainty

DASY5 Uncertainty								
Measurement uncertainty for 300 MHz to 3 GHz averaged over 1 gram / 10 gram.								
Error Description	Uncert. value	Prob. Dist.	Div.	(ci) 1g	(ci) 10g	Std. Unc. (1g)	Std. Unc. (10g)	(vi) v_{eff}
Measurement System								
Probe Calibration	±6.0%	N	1	1	1	±6.0%	±6.0%	∞
Axial Isotropy	±4.7%	R	$\sqrt{3}$	0.7	0.7	±1.9%	±1.9%	∞
Hemispherical Isotropy	±9.6%	R	$\sqrt{3}$	0.7	0.7	±3.9%	±3.9%	∞
Boundary Effects	±1.0%	R	$\sqrt{3}$	1	1	±0.6%	±0.6%	∞
Linearity	±4.7%	R	$\sqrt{3}$	1	1	±2.7%	±2.7%	∞
System Detection Limits	±1.0%	R	$\sqrt{3}$	1	1	±0.6%	±0.6%	∞
Readout Electronics	±0.3%	N	1	1	1	±0.3%	±0.3%	∞
Response Time	±0.8%	R	$\sqrt{3}$	1	1	±0.5%	±0.5%	∞
Integration Time	±2.6%	R	$\sqrt{3}$	1	1	±1.5%	±1.5%	∞
RF Ambient Noise	±3.0%	R	$\sqrt{3}$	1	1	±1.7%	±1.7%	∞
RF Ambient Reflections	±3.0%	R	$\sqrt{3}$	1	1	±1.7%	±1.7%	∞
Probe Positioner	±0.4%	R	$\sqrt{3}$	1	1	±0.2%	±0.2%	∞
Probe Positioning	±2.9%	R	$\sqrt{3}$	1	1	±1.7%	±1.7%	∞
Max. SAR Eval.	±1.0%	R	$\sqrt{3}$	1	1	±0.6%	±0.6%	∞
Test Sample Related								
Device Positioning	±2.9%	N	1	1	1	±2.9%	±2.9%	145
Device Holder	±3.6%	N	1	1	1	±3.6%	±3.6%	5
Power Drift	±5.0%	R	$\sqrt{3}$	1	1	±2.9%	±2.9%	∞
Phantom and Setup								
Phantom Uncertainty	±4.0%	R	$\sqrt{3}$	1	1	±2.3%	±2.3%	∞
Liquid Conductivity (target)	±5.0%	R	$\sqrt{3}$	0.64	0.43	±1.8%	±1.2%	∞
Liquid Conductivity (meas.)	±2.5%	N	1	0.64	0.43	±1.6%	±1.1%	∞
Liquid Permittivity (target)	±5.0%	R	$\sqrt{3}$	0.6	0.49	±1.7%	±1.4%	∞
Liquid Permittivity (meas.)	±2.5%	N	1	0.6	0.49	±1.5%	±1.2%	∞
Combined Std. Uncertainty						±11.0%	±10.8%	387
Expanded STD Uncertainty						±22.0%	±21.5%	

8. Conducted Power Measurement

Mode	Frequency (MHz)	Avg. Burst Power (dBm)	Duty Cycle Factor (dB)	Frame Power (dBm)	Max. Power (dBm)	Scaling Factor
GSM850	824.2	31.88	-9	22.88	32.5	1.15
	836.4	31.98	-9	22.98	32.5	1.13
	848.8	32.06	-9	23.06	32.5	1.11
GPRS/EDGE850 (1 Slot)	824.2	31.88	-9	22.88	32.5	1.15
	836.4	31.95	-9	22.95	32.5	1.14
	848.8	32.05	-9	23.05	32.5	1.11
GPRS/EDGE850 (2 Slot)	824.2	30.75	-6	24.75	31.0	1.06
	836.4	30.85	-6	24.85	31.0	1.04
	848.8	30.98	-6	24.98	31.0	1.00
GPRS/EDGE850 (3 Slot)	824.2	29.05	-4.25	24.80	29.5	1.11
	836.4	29.12	-4.25	24.87	29.5	1.09
	848.8	29.26	-4.25	25.01	29.5	1.06
GPRS/EDGE850 (4 Slot)	824.2	27.54	-3	24.54	28.0	1.11
	836.4	27.61	-3	24.61	28.0	1.09
	848.8	27.74	-3	24.74	28.0	1.06
PCS1900	1850.2	29.07	-9	20.07	29.5	1.10
	1880.0	29.16	-9	20.16	29.5	1.08
	1909.8	29.20	-9	20.20	29.5	1.07
GPRS/EDGE1900 (1 Slot)	1850.2	29.04	-9	20.04	29.5	1.11
	1880.0	29.10	-9	20.10	29.5	1.10
	1909.8	29.16	-9	20.16	29.5	1.08
GPRS/EDGE1900 (2 Slot)	1850.2	27.36	-6	21.36	28.0	1.16
	1880.0	27.48	-6	21.48	28.0	1.13
	1909.8	27.54	-6	21.54	28.0	1.11
GPRS/EDGE1900 (3 Slot)	1850.2	25.70	-4.25	21.45	26.0	1.07
	1880.0	25.82	-4.25	21.57	26.0	1.04
	1909.8	25.84	-4.25	21.59	26.0	1.04
GPRS/EDGE1900 (4 Slot)	1850.2	23.99	-3	20.99	24.5	1.12
	1880.0	24.12	-3	21.12	24.5	1.09
	1909.8	24.27	-3	21.27	24.5	1.05

Note 1: Scaling Factor = Max. Power(mW) / Avg. Burst Power(mW)

2: This device operates using the following maximum and nominal output power specifications. SAR values were scaled to the maximum allowed power to determine compliance per KDB Publication

447498 D01v05.

3: Both burst-averaged and calculated frame-averaged powers are included. Frame-averaged powers were calculated from the measured burst-averaged power by converting the slot powers into linear units and calculating the energy over 8 timeslots.

4: The bolded GPRS modes were selected for SAR testing according to the highest frame-averaged output power table per KDB 941225 D03v01.

5: GPRS/EDGE(GMSK) output powers were measured with coding scheme setting of 1 (CS1) on the base station simulator. CS1 was configured to measure GPRS output power measurements and SAR to ensure GMSK modulation in the signal. Our Investigation has shown that CS1 - CS4 settings do not have any impact on the output levels or modulation in the GPRS modes.

WCDMA/HSDPA/HSUPA

Mode	3GPP Subtest	Band II (1900MHz)			Band V (850MHz)			MPR
		Conducted Power (dBm)			Conducted Power (dBm)			
		9262	9400	9538	4132	4182	4233	
WCDMA R99	1	22.48	22.74	22.81	23.03	23.11	23.19	N/A
Rel5 HSDPA	1	22.18	22.44	22.63	22.88	22.98	23.00	0
	2	22.15	22.43	22.61	22.86	22.93	22.96	0
	3	21.74	21.97	22.15	22.47	22.45	22.60	0.5
	4	21.71	21.94	22.12	22.44	22.43	22.58	0.5
Rel6 HSUPA	1	22.07	22.31	22.38	22.79	22.87	22.84	0.0
	2	20.10	20.34	20.37	20.77	20.86	20.83	2.0
	3	21.05	21.28	21.35	21.81	21.91	21.81	1.0
	4	20.08	20.32	20.33	20.75	20.83	20.82	2.0
	5	22.05	22.26	22.36	22.76	22.83	22.80	0.0

Note: UMTS SAR was tested under RMC 12.2 kbps with HSPA Inactive per KDB Publication 941225 D01v02. HSPA SAR was not required since the average output power of the HSPA subtests was not more than 0.25 dB higher than the RMC level and SAR was less than 1.2 W/kg.

Mode	Band II (1900MHz) Channel	Normal Power (dBm)	Max. Power (dBm)	Scaling Factor
WCDMA R99	9262	22.48	23.0	1.13
	9400	22.74	23.0	1.06
	9538	22.81	23.0	1.04
Rel5 HSDPA	9262	22.18	23.0	1.21
	9400	22.44	23.0	1.14
	9538	22.63	23.0	1.09
Rel6 HSUPA	9262	22.07	23.0	1.24
	9400	22.31	23.0	1.17
	9538	22.38	23.0	1.15
Mode	Band V (850MHz) Channel	Normal Power (dBm)	Max. Power (dBm)	Scaling Factor
WCDMA R99	4132	23.03	23.5	1.11
	4182	23.11	23.5	1.09
	4233	23.19	23.5	1.07
Rel5 HSDPA	4132	22.88	23.5	1.15
	4182	22.98	23.5	1.13

	4233	23.00	23.5	1.12
Rel6 HSUPA	4132	22.79	23.5	1.18
	4182	22.87	23.5	1.16
	4233	22.84	23.5	1.16

WLAN output power

Test Mode	Channel No.	Frequency (MHz)	Average Power (dBm)	Max. Power (dBm)	Scaling Factor
802.11b	01	2412	15.38	16.0	1.15
	06	2437	15.69	16.0	1.07
	11	2462	15.28	16.0	1.18
802.11g	01	2412	14.80	15.0	1.05
	06	2437	14.88	15.0	1.03
	11	2462	14.60	15.0	1.10
802.11n (20MHz)	01	2412	14.40	15.0	1.15
	06	2437	14.63	15.0	1.09
	11	2462	14.28	15.0	1.18

Note: Justification for reduced test configurations for WIFI channels per KDB Publication 248227 D01v01r02.

For 2.4 GHz, highest average RF output power channel for the lowest data rate for IEEE 802.11b were selected for SAR evaluation. Other IEEE 802.11 modes (including 802.11g/n) were not investigated since the average output powers over all channels and data rates were not more than 0.25 dB higher than the tested channel in the lowest data rate of IEEE 802.11b mode.

When the maximum extrapolated peak SAR of the zoom scan for the maximum output channel is <1.6 W/kg and the reported 1g averaged SAR is <0.8 W/kg, SAR testing on other channels is not required. Otherwise, the other default (or corresponding required) test channels were additionally tested using the lowest data rate.

The bolded channel above was tested for SAR.

9. Test Results

9.1. SAR Test Results Summary

SAR MEASUREMENT									
Ambient Temperature (°C) : 21.5 ±2					Relative Humidity (%): 52				
Liquid Temperature (°C) : 21.0 ±2					Depth of Liquid (cm):>15				
Product: Smartphone									
Test Mode: GSM850									
Test Position Head	Antenna Position	Frequency		Frame Power (dBm)	Power Drift (<±0.2)	SAR 1g (W/kg)	Scaling Factor	Scaled SAR 1g (W/kg)	Limit (W/kg)
		Channel	MHz						
Left-Cheek	Fixed	128	824.2	22.88	--	--	1.15	--	1.6
Left-Cheek	Fixed	189	836.4	22.98	-0.14	0.613	1.13	0.693	1.6
Left-Cheek	Fixed	251	848.8	23.06	--	--	1.11	--	1.6
Left-Tilted	Fixed	189	836.4	22.98	-0.10	0.390	1.13	0.441	1.6
Right-Cheek	Fixed	128	824.2	22.88	--	--	1.15	--	1.6
Right-Cheek	Fixed	189	836.4	22.98	0.09	0.580	1.13	0.655	1.6
Right-Cheek	Fixed	251	848.8	23.06	--	--	1.11	--	1.6
Right-Tilted	Fixed	189	836.4	22.98	-0.12	0.381	1.13	0.431	1.6
Note: when the 1-g SAR is ≤ 0.8 W/kg, testing for low and high channel is optional, refer to KDB 447498.									

SAR MEASUREMENT									
Ambient Temperature (°C): 21.5 ±2					Relative Humidity (%): 52				
Liquid Temperature (°C): 21.0 ±2					Depth of Liquid (cm):>15				
Product: Smartphone									
Body-worn Accessory SAR Configurations									
Test Mode: GSM850									
Test Position Body (10mm gap)	Antenna Position	Frequency		Frame Power (dBm)	Power Drift (<±0.2)	SAR 1g (W/kg)	Scaling Factor	Scaled SAR 1g (W/kg)	Limit (W/kg)
		Channel	MHz						
Body-worn	Fixed	128	824.2	22.88	--	--	1.15	--	1.6
Body-worn	Fixed	189	836.4	22.98	-0.10	0.672	1.13	0.759	1.6
Body-worn	Fixed	251	848.8	23.06	--	--	1.11	--	1.6
Hotspot SAR Configurations									
Test Mode: GPRS850-3slot									
Body-worn	Fixed	128	824.2	24.80	0.06	1.03	1.11	1.143	1.6
Body-worn*	Fixed	128	824.2	24.87	0.06	0.978	1.09	1.066	1.6
Body-worn	Fixed	189	836.4	24.87	0.14	0.919	1.09	1.002	1.6
Body-worn	Fixed	251	848.8	25.01	0.16	0.815	1.06	0.864	1.6
Body-front	Fixed	189	836.4	24.87	-0.10	0.749	1.09	0.816	1.6
Body-bottom	Fixed	189	836.4	24.87	0.01	0.391	1.09	0.426	1.6
Body-left side	Fixed	189	836.4	24.87	-0.11	0.594	1.09	0.647	1.6
Body-right side	Fixed	189	836.4	24.87	-0.19	0.559	1.09	0.609	1.6
Note 1: when the 1-g SAR is ≤ 0.8 W/kg, testing for low and high channel is optional, refer to KDB 447498.									
2: * - repeated at the highest SAR measurement according to the FCC KDB 865664									

SAR MEASUREMENT									
Ambient Temperature (°C) : 21.5 ±2					Relative Humidity (%): 52				
Liquid Temperature (°C) : 21.0 ±2					Depth of Liquid (cm):>15				
Product: Smartphone									
Test Mode: PCS1900									
Test Position Head	Antenna Position	Frequency		Frame Power (dBm)	Power Drift (<±0.2)	SAR 1g (W/kg)	Scaling Factor	Scaled SAR 1g (W/kg)	Limit (W/kg)
		Channel	MHz						
Left-Cheek	Fixed	512	1850.2	20.07	--	--	1.10	--	1.6
Left-Cheek	Fixed	661	1880.0	20.16	0.02	0.436	1.08	0.471	1.6
Left-Cheek	Fixed	810	1909.8	20.20	--	--	1.07	--	1.6
Left-Tilted	Fixed	661	1880.0	20.16	-0.01	0.120	1.08	0.130	1.6
Right-Cheek	Fixed	512	1850.2	20.07	--	--	1.10	--	1.6
Right-Cheek	Fixed	661	1880.0	20.16	-0.11	0.284	1.08	0.307	1.6
Right-Cheek	Fixed	810	1909.8	20.20	--	--	1.07	--	1.6
Right-Tilted	Fixed	661	1880.0	20.16	-0.07	0.136	1.08	0.147	1.6
Note: when the 1-g SAR is ≤ 0.8 W/kg, testing for low and high channel is optional, refer to KDB 447498.									

SAR MEASUREMENT									
Ambient Temperature (°C) : 21.5 ±2					Relative Humidity (%): 52				
Liquid Temperature (°C) : 21.0 ±2					Depth of Liquid (cm):>15				
Product: Smartphone									
Body-worn Accessory SAR Configurations									
Test Mode: PCS1900									
Test Position Body (10mm gap)	Antenna Position	Frequency		Frame Power (dBm)	Power Drift (<±0.2)	SAR 1g (W/kg)	Scaling Factor	Scaled SAR 1g (W/kg)	Limit (W/kg)
		Channel	MHz						
Body-worn	Fixed	512	1850.2	20.07	--	--	1.10	--	1.6
Body-worn	Fixed	661	1880.0	20.16	0.09	0.409	1.08	0.442	1.6
Body-worn	Fixed	810	1909.8	20.20	--	--	1.07	--	1.6
Hotspot SAR Configurations									
Test Mode: GPRS1900-3slot									
Body-worn	Fixed	512	1850.2	21.45	--	--	1.07	--	1.6
Body-worn	Fixed	661	1880.0	21.57	-0.17	0.562	1.04	0.584	1.6
Body-worn	Fixed	810	1909.8	21.59	--	--	1.04	--	1.6
Body-front	Fixed	661	1880.0	21.57	-0.04	0.428	1.04	0.445	1.6
Body-bottom	Fixed	661	1880.0	21.57	-0.10	0.421	1.04	0.438	1.6
Body-left side	Fixed	661	1880.0	21.57	-0.04	0.211	1.04	0.219	1.6
Body-right side	Fixed	661	1880.0	21.57	-0.10	0.130	1.04	0.135	1.6
Note: when the 1-g SAR is ≤ 0.8 W/kg, testing for low and high channel is optional, refer to KDB 447498.									

SAR MEASUREMENT									
Ambient Temperature (°C) : 21.5 ±2					Relative Humidity (%) : 52				
Liquid Temperature (°C) : 21.0 ±2					Depth of Liquid (cm):>15				
Product: Smartphone									
Test Mode: WCDMA Band II									
Test Position Head	Antenna Position	Frequency		Conducted Power (dBm)	Power Drift (<±0.2)	SAR 1g (W/kg)	Scaling Factor	Scaled SAR 1g (W/kg)	Limit (W/kg)
		Channel	MHz						
Left-Cheek	Fixed	9262	1852.4	22.48	--	--	1.13	--	1.6
Left-Cheek	Fixed	9400	1880.0	22.74	0.08	0.748	1.06	0.793	1.6
Left-Cheek	Fixed	9538	1907.6	22.81	--	--	1.04	--	1.6
Left-Tilt	Fixed	9400	1880.0	22.74	-0.07	0.202	1.06	0.214	1.6
Right-Cheek	Fixed	9262	1852.4	22.48	--	--	1.13	--	1.6
Right-Cheek	Fixed	9400	1880.0	22.74	-0.04	0.600	1.06	0.636	1.6
Right-Cheek	Fixed	9538	1907.6	22.81	--	--	1.04	--	1.6
Right-Tilt	Fixed	9400	1880.0	22.74	0.09	0.233	1.06	0.247	1.6

Note: when the 1-g SAR is ≤ 0.8 W/kg, testing for low and high channel is optional, refer to KDB 447498.

SAR MEASUREMENT									
Ambient Temperature (°C): 21.5 ±2					Relative Humidity (%): 52				
Liquid Temperature (°C): 21.0 ±2					Depth of Liquid (cm):>15				
Product: Smartphone									
Body-worn Accessory SAR Configurations									
Test Mode: WCDMA Band II									
Test Position Body (10mm gap)	Antenna Position	Frequency		Conducted Power (dBm)	Power Drift (<±0.2)	SAR 1g (W/kg)	Scaling Factor	Scaled SAR 1g (W/kg)	Limit (W/kg)
		Channel	MHz						
Body-worn	Fixed	9262	1852.4	22.48	0.00	0.812	1.13	0.918	1.6
Body-worn	Fixed	9400	1880.0	22.74	-0.02	0.832	1.06	0.882	1.6
Body-worn	Fixed	9538	1907.6	22.81	0.06	0.896	1.04	0.932	1.6
Hotspot SAR Configurations									
Test Mode: WCDMA Band II									
Body-worn	Fixed	9262	1852.4	22.48	0.00	0.812	1.13	0.918	1.6
Body-worn	Fixed	9400	1880.0	22.74	-0.02	0.832	1.06	0.882	1.6
Body-worn	Fixed	9538	1907.6	22.81	0.06	0.896	1.04	0.932	1.6
Body-worn*	Fixed	9538	1907.6	22.81	0.17	0.877	1.04	0.912	1.6
Body-front	Fixed	9400	1880.0	22.74	0.05	0.642	1.06	0.681	1.6
Body-bottom	Fixed	9400	1880.0	22.74	0.03	0.601	1.06	0.637	1.6
Body-left side	Fixed	9400	1880.0	22.74	0.04	0.380	1.06	0.403	1.6
Body-right side	Fixed	9400	1880.0	22.74	0.04	0.175	1.06	0.186	1.6
Note 1: when the 1-g SAR is ≤ 0.8 W/kg, testing for low and high channel is optional, refer to KDB 447498.									
2: * - repeated at the highest SAR measurement according to the FCC KDB 865664									

SAR MEASUREMENT									
Ambient Temperature (°C) : 21.5 ±2					Relative Humidity (%): 52				
Liquid Temperature (°C) : 21.0 ±2					Depth of Liquid (cm):>15				
Product: Smartphone									
Test Mode: WCDMA Band V									
Test Position Head	Antenna Position	Frequency		Conducted Power (dBm)	Power Drift (<±0.2)	SAR 1g (W/kg)	Scaling Factor	Scaled SAR 1g (W/kg)	Limit (W/kg)
		Channel	MHz						
Left-Cheek	Fixed	4132	826.4	23.03	--	--	1.11	--	1.6
Left-Cheek	Fixed	4182	836.4	23.11	-0.07	0.421	1.09	0.459	1.6
Left-Cheek	Fixed	4233	846.6	23.19	--	--	1.07	--	1.6
Left-Tilt	Fixed	4182	836.4	23.11	0.02	0.298	1.09	0.325	1.6
Right-Cheek	Fixed	4132	826.4	23.03	--	--	1.11	--	1.6
Right-Cheek	Fixed	4182	836.4	23.11	-0.10	0.402	1.09	0.438	1.6
Right-Cheek	Fixed	4233	846.6	23.19	--	--	1.07	--	1.6
Right-Tilt	Fixed	4182	836.4	23.11	0.07	0.272	1.09	0.296	1.6
Note: when the 1-g SAR is ≤ 0.8 W/kg, testing for low and high channel is optional, refer to KDB 447498.									

SAR MEASUREMENT									
Ambient Temperature (°C): 21.5 ±2					Relative Humidity (%): 52				
Liquid Temperature (°C): 21.0 ±2					Depth of Liquid (cm):>15				
Product: Smartphone									
Body-worn Accessory SAR Configurations									
Test Mode: WCDMA Band V									
Test Position Body (10mm gap)	Antenna Position	Frequency		Conducted Power (dBm)	Power Drift (<±0.2)	SAR 1g (W/kg)	Scaling Factor	Scaled SAR 1g (W/kg)	Limit (W/kg)
		Channel	MHz						
Body-worn	Fixed	4132	826.4	23.03	0.03	0.820	1.11	0.910	1.6
Body-worn	Fixed	4182	836.4	23.11	-0.01	0.821	1.09	0.895	1.6
Body-worn	Fixed	4233	846.6	23.19	-0.01	0.806	1.07	0.862	1.6
Hotspot SAR Configurations									
Test Mode: WCDMA Band V									
Body-worn	Fixed	4132	826.4	23.03	0.03	0.820	1.11	0.910	1.6
Body-worn	Fixed	4182	836.4	23.11	-0.01	0.821	1.09	0.895	1.6
Body-worn*	Fixed	4182	836.4	23.11	0.06	0.778	1.09	0.848	1.6
Body-worn	Fixed	4233	846.6	23.19	-0.01	0.806	1.07	0.862	1.6
Body-front	Fixed	4182	836.4	23.11	0.03	0.456	1.09	0.497	1.6
Body-bottom	Fixed	4182	836.4	23.11	0.00	0.260	1.09	0.283	1.6
Body-left side	Fixed	4182	836.4	23.11	-0.10	0.597	1.09	0.651	1.6
Body-right side	Fixed	4182	836.4	23.11	-0.17	0.436	1.09	0.475	1.6
Note 1: when the 1-g SAR is ≤ 0.8 W/kg, testing for low and high channel is optional, refer to KDB 447498.									
2: * - repeated at the highest SAR measurement according to the FCC KDB 865664									

SAR MEASUREMENT									
Ambient Temperature (°C) : 21.5 ±2					Relative Humidity (%): 52				
Liquid Temperature (°C) : 21.0 ±2					Depth of Liquid (cm):>15				
Product: Smartphone									
Test Mode: 802.11b									
Test Position Head	Antenna Position	Frequency		Average Power (dBm)	Power Drift (<±0.2)	SAR 1g (W/kg)	Scaling Factor	Scaled SAR 1g (W/kg)	Limit (W/kg)
		Channel	MHz						
Left-Cheek	Fixed	1	2412	15.38	--	--	1.15	--	1.6
Left-Cheek	Fixed	6	2437	15.69	-0.12	0.00348	1.07	0.00372	1.6
Left-Cheek	Fixed	11	2462	15.28	--	--	1.18	--	1.6
Left-Tilt	Fixed	6	2437	15.69	0.09	0.000131	1.07	0.00014	1.6
Right-Cheek	Fixed	1	2412	15.38	--	--	1.15	--	1.6
Right-Cheek	Fixed	6	2437	15.69	0.12	0.00473	1.07	0.00506	1.6
Right-Cheek	Fixed	11	2462	15.28	--	--	1.18	--	1.6
Right-Tilt	Fixed	6	2437	15.69	0.18	0.00236	1.07	0.00253	1.6

SAR MEASUREMENT									
Ambient Temperature (°C): 21.5 ±2					Relative Humidity (%): 52				
Liquid Temperature (°C): 21.0 ±2					Depth of Liquid (cm):>15				
Product: Smartphone									
Body-worn Accessory SAR Configurations									
Test Mode: 802.11b									
Test Position Body (10mm gap)	Antenna Position	Frequency		Average Power (dBm)	Power Drift (<±0.2)	SAR 1g (W/kg)	Scaling Factor	Scaled SAR 1g (W/kg)	Limit (W/kg)
		Channel	MHz						
Body-worn	Fixed	1	2412	15.38	--	--	1.15	--	1.6
Body-worn	Fixed	6	2437	15.69	-0.16	0.015	1.07	0.0161	1.6
Body-worn	Fixed	11	2462	15.28	--	--	1.18	--	1.6
Hotspot SAR Configurations									
Test Mode: 802.11b									
Body-worn	Fixed	6	2437	15.69	-0.16	0.015	1.07	0.0161	1.6
Body-front	Fixed	6	2437	15.69	0.16	0.000607	1.07	0.00065	1.6
Body-Top	Fixed	6	2437	15.69	-0.04	0.00471	1.07	0.00504	1.6
Body-left side	Fixed	6	2437	15.69	0.15	0.00401	1.07	0.00421	1.6

9.2. SAR Test Notes

9.2.1. Test position and configuration

Head SAR was performed with the device configured in the positions according to IEEE1528. Device was tested using a fixed spacing for body-worn accessory testing. A separation distance of 10 mm was considered because the manufacturer has determined that there will be body-worn accessories available in the marketplace for users to support this separation distance.

9.2.2. Body SAR with Headset

Per FCC KDB Publication 648474 D04v01, SAR was evaluated without a headset connected to the device. Since the standalone reported SAR was ≤ 1.2 W/kg, no additional SAR evaluations using a headset cable were required.

9.2.3. Hotspot Operation Mode

During SAR Testing for the Wireless Router conditions per FCC KDB Publication 941225 D06v01, the actual Portable Hotspot operation (with actual simultaneous transmission of a transmitter with WIFI) was not activated.

9.2.4. Simultaneous Transmission Procedures

This device contains transmitters that may operate simultaneously. Therefore simultaneous transmission analysis is required. Per FCC KDB 447498 D01v05, simultaneous transmission SAR test exclusion may be applied when the sum of the 1-g SAR for all the simultaneous transmitting antennas in a specific a physical test configuration is ≤ 1.6W/kg. When standalone SAR is not required to be measured, per FCC KDB 447498 D01v05 4.3.2 2, the following equation must be used to estimate the standalone 1g SAR for simultaneous transmission assessment involving that transmitter.

$$\text{Estimated SAR} = \frac{\sqrt{f(\text{GHz})}}{7.5} * \frac{(\text{Max Power of channel, mW})}{\text{Min. Separation Distance, mm}}$$

Estimated SAR for Bluetooth

Mode	Frequency	Maximum Allowed Power	Estimated SAR (Held-to-Ear)	Separation Distance (Body)	Estimated SAR (Body)
	[MHz]	[dBm]	[W/kg]	[mm]	[W/kg]
Bluetooth	2480	5.4	N/A	10	0.073

Note: Held-to ear configurations are not applicable to Bluetooth operations and therefore were not considered for simultaneous transmission.

9.2.5. Simultaneous Transmission Analysis

Simultaneous Transmission Scenario with Wi-Fi

Configuration	Mode	Max. Scaled SAR (W/kg)	Wi-Fi SAR (W/kg)	Σ SAR (W/kg)
Head	GSM850	0.693	0.00506	0.698
Head	PCS1900	0.471	0.00506	0.476
Head	UMTS 850	0.459	0.00506	0.464
Head	UMTS 1900	0.793	0.00506	0.798
Body-Worn	GSM850	0.759	0.0161	0.775
Body-Worn	PCS1900	0.442	0.0161	0.458
Body-Worn	UMTS 850	0.910	0.0161	0.926
Body-Worn	UMTS 1900	0.932	0.0161	0.948

Note: Body worn at 10mm.

Simultaneous Transmission Scenario with Bluetooth

Configuration	Mode	Max. Scaled SAR (W/kg)	Bluetooth SAR (W/kg)	Σ SAR (W/kg)
Body-Worn	GSM850	0.759	0.073	0.832
Body-Worn	PCS1900	0.442	0.073	0.515
Body-Worn	UMTS 850	0.910	0.073	0.983
Body-Worn	UMTS 1900	0.932	0.073	1.005

Note 1: Bluetooth SAR was not required to be measured per FCC KDB 447498. Estimated SAR results were used in the above table to determine simultaneous transmission SAR test exclusion.

2: Body worn at 10mm.

Simultaneous Transmission Scenario (Hotspot)

Simult Tx	Configuration	GPRS850 SAR (W/kg)	Wi-Fi SAR (W/kg)	Σ SAR (W/kg)
Body	Back	1.143	0.0161	1.159
	Front	0.816	0.00065	0.817
	Top	--	0.00504	0.005
	Bottom	0.426	--	0.426
	Left	0.647	0.00421	0.651
	Right	0.609	--	0.609
Simult Tx	Configuration	GPRS1900 SAR (W/kg)	Wi-Fi SAR (W/kg)	Σ SAR (W/kg)
Body	Back	0.584	0.0161	0.600
	Front	0.445	0.00065	0.446
	Top	--	0.00504	0.005
	Bottom	0.438	--	0.438
	Left	0.219	0.00421	0.223
	Right	0.135	--	0.135
Simult Tx	Configuration	UMTS850 SAR (W/kg)	Wi-Fi SAR (W/kg)	Σ SAR (W/kg)
Body	Back	0.910	0.0161	0.926
	Front	0.497	0.00065	0.498
	Top	--	0.00504	0.005
	Bottom	0.283	--	0.283
	Left	0.651	0.00421	0.655
	Right	0.475	--	0.475
Simult Tx	Configuration	UMTS1900 SAR (W/kg)	Wi-Fi SAR (W/kg)	Σ SAR (W/kg)
Body	Back	0.932	0.0161	0.948
	Front	0.681	0.00065	0.682
	Top	--	0.00504	0.005
	Bottom	0.637	--	0.637
	Left	0.403	0.00421	0.407
	Right	0.186	--	0.186

9.2.6. Simultaneous Transmission Conclusion

The above numerical summed SAR results for all the worst-case simultaneous transmission conditions were below the SAR limit. Therefore, the above analysis is sufficient to determine that simultaneous transmission cases will not exceed the SAR limit and therefore no measured volumetric simultaneous SAR summation is required per FCC KDB Publication 447498 D01v05.

Appendix A. SAR System Validation Data

Date/Time: 06-02-2013

Test Laboratory: QuieTek Lab

System Check Head 835MHz

DUT: Dipole 835 MHz D835V2; Type: D835V2

Communication System: CW; Communication System Band: D835(835.0MHz); Duty Cycle: 1:1; Frequency: 835 MHz; Medium parameters used: $f = 835 \text{ MHz}$; $\sigma = 0.9 \text{ mho/m}$; $\epsilon_r = 41.87$; $\rho = 1000 \text{ kg/m}^3$; Phantom section: Flat Section ; Input Power=250mW

Ambient temperature (°C): 21.5, Liquid temperature (°C): 21.0

DASY5 Configuration:

- Probe: EX3DV4 - SN3710; ConvF(9.18, 9.18, 9.18); Calibrated: 12/03/2012;
- Sensor-Surface: 4mm (Mechanical Surface Detection)
- Electronics: DAE4 Sn915; Calibrated: 21/06/2012
- Phantom: SAM1; Type: SAM; Serial: TP1561
- Measurement SW: DASY52, Version 52.8 (1); SEMCAD X Version 14.6.5 (6469)

Configuration/System Check Head 835MHz/Area Scan (6x19x1): Measurement grid: dx=10mm, dy=10mm, Maximum value of SAR (measured) = 2.52 mW/g

Configuration/System Check Head 835MHz/Zoom Scan (7x7x7)/Cube 0: Measurement grid: dx=5mm, dy=5mm, dz=5mm, Reference Value = 53.690 V/m; Power Drift = 0.01 dB

Peak SAR (extrapolated) = 3.673 mW/g

SAR(1 g) = 2.44 mW/g; SAR(10 g) = 1.59 mW/g Maximum value of SAR (measured) = 2.63 mW/g

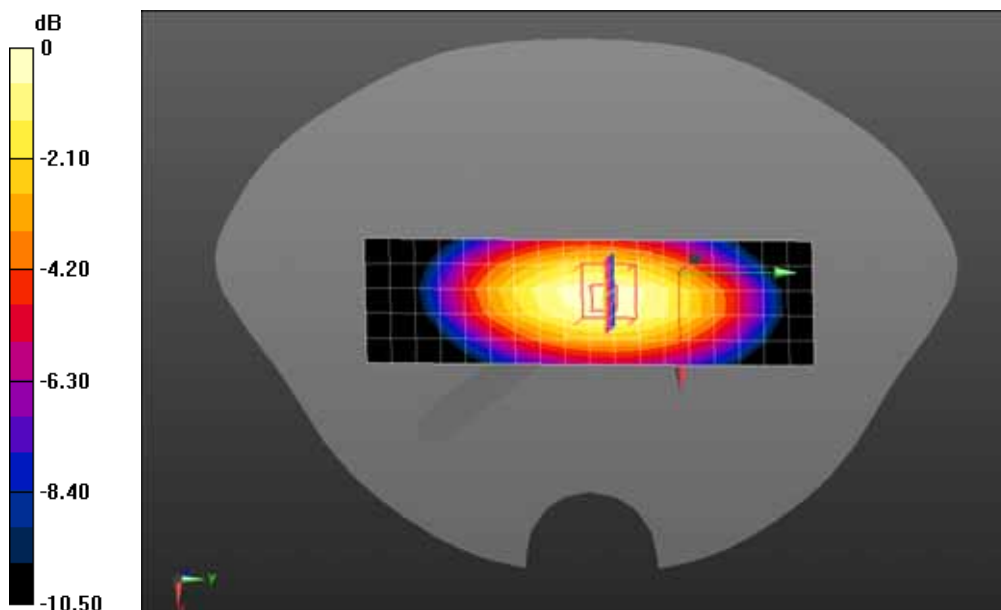

0 dB = 2.63 mW/g = 8.40 dB mW/g

Date/Time: 06-02-2013

Test Laboratory: QuieTek Lab

System Check Body 835MHz

DUT: Dipole 835 MHz D835V2; Type: D835V2

Communication System: CW; Communication System Band: D835 (835.0 MHz); Duty Cycle: 1:1;

Frequency: 835 MHz; Medium parameters used: $f = 835 \text{ MHz}$; $\sigma = 0.96 \text{ mho/m}$; $\epsilon_r = 53.93$; $\rho = 1000 \text{ kg/m}^3$;

Phantom section: Flat Section ; Input Power=250mW

Ambient temperature (): 21.5, Liquid temperature (): 21.0

DASY5 Configuration:

- Probe: EX3DV4 - SN3710; ConvF(9.13, 9.13, 9.13); Calibrated: 12/03/2012;
- Sensor-Surface: 4mm (Mechanical Surface Detection)
- Electronics: DAE4 Sn915; Calibrated: 21/06/2012
- Phantom: SAM1; Type: SAM; Serial: TP1561
- Measurement SW: DASY52, Version 52.8 (1); SEMCAD X Version 14.6.5 (6469)

Configuration/System Check Body 835MHz/Area Scan (8x17x1): Measurement grid: dx=10mm, dy=10mm, Maximum value of SAR (measured) = 2.48 mW/g

Configuration/System Check Body 835MHz/Zoom Scan (7x7x7)/Cube 0: Measurement grid: dx=5mm, dy=5mm, dz=5mm, Reference Value = 52.556 V/m; Power Drift = 0.03 dB

Peak SAR (extrapolated) = 3.736 mW/g

SAR(1 g) = 2.47 mW/g; SAR(10 g) = 1.61 mW/g Maximum value of SAR (measured) = 2.67 mW/g

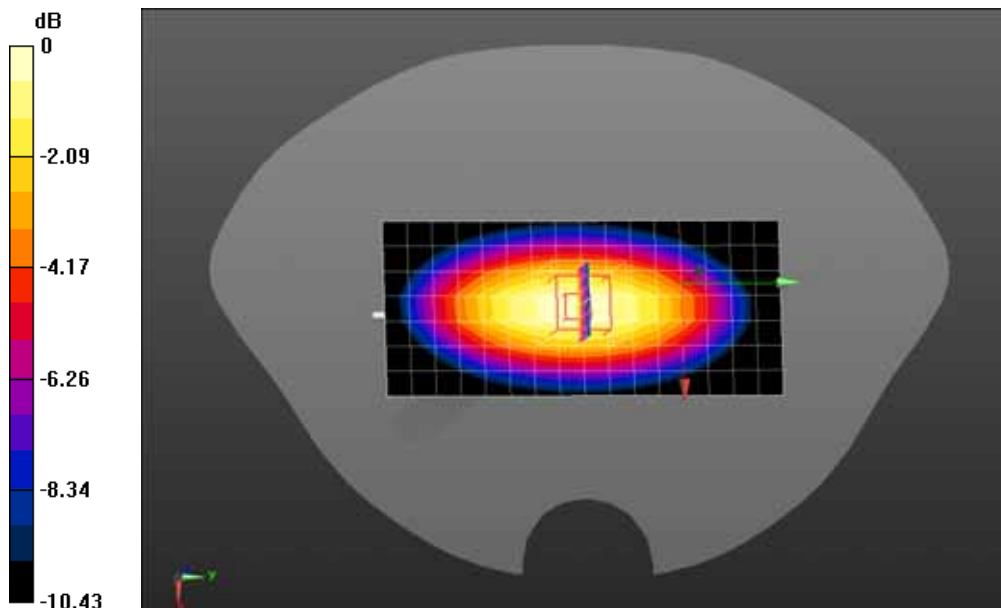

0 dB = 2.67 mW/g = 8.53 dB mW/g

Date/Time: 06-02-2013

Test Laboratory: QuieTek Lab

System Check Head 1900MHz

DUT: Dipole 1900 MHz D1900V2; Type: D1900V2

Communication System: CW; Communication System Band: D1900(1900MHz); Duty Cycle: 1:1; Frequency: 1900 MHz; Medium parameters used: $f = 1900$ MHz; $\sigma = 1.44$ mho/m; $\epsilon_r = 39.21$; $\rho = 1000$ kg/m³; Phantom section: Flat Section ; Input Power=250mW

Ambient temperature (): 21.5, Liquid temperature (): 21.0

DASY5 Configuration:

- Probe: EX3DV4 - SN3710; ConvF(8.16, 8.16, 8.16); Calibrated: 12/03/2012;
- Sensor-Surface: 4mm (Mechanical Surface Detection)
- Electronics: DAE4 Sn915; Calibrated: 21/06/2012
- Phantom: SAM2; Type: SAM; Serial: TP1562
- Measurement SW: DASY52, Version 52.8 (1); SEMCAD X Version 14.6.5 (6469)

Configuration/System Check Head 1900MHz/Area Scan (6x11x1): Measurement grid: dx=10mm, dy=10mm, Maximum value of SAR (measured) = 10.0 mW/g

Configuration/System Check Head 1900MHz/Zoom Scan (7x7x7)/Cube 0: Measurement grid: dx=5mm, dy=5mm, dz=5mm, Reference Value = 86.896 V/m; Power Drift = 0.11 dB

Peak SAR (extrapolated) = 19.242 mW/g

SAR(1 g) = 9.93 mW/g; SAR(10 g) = 5.02 mW/g Maximum value of SAR (measured) = 11.2 mW/g

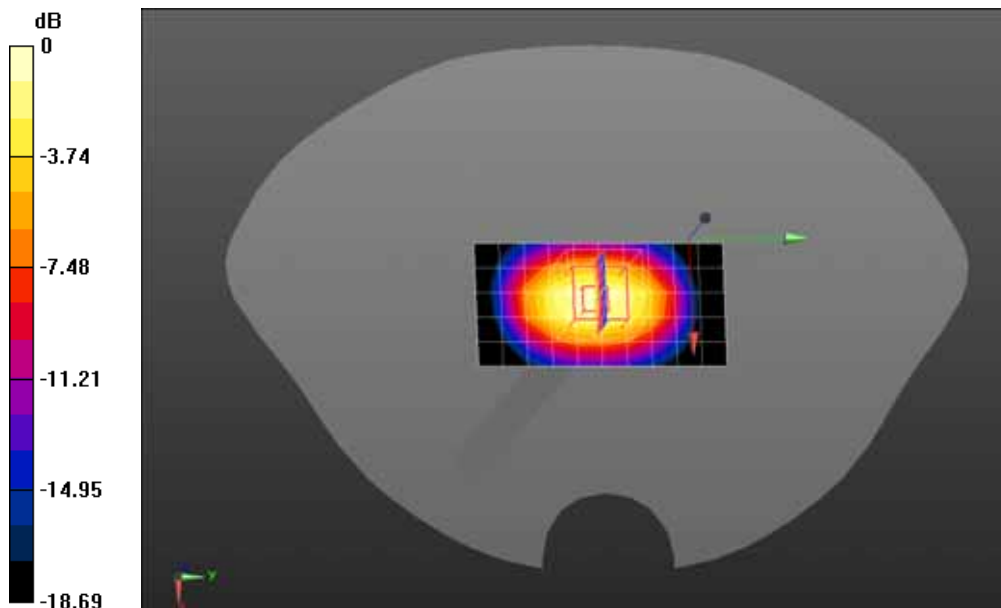

0 dB = 11.2 mW/g = 20.98 dB mW/g

Date/Time: 06-02-2013

Test Laboratory: QuieTek Lab

System Check Body 1900MHz

DUT: Dipole 1900 MHz D1900V2; Type: D1900V2

Communication System: CW; Communication System Band: D1900(1900MHz); Duty Cycle: 1:1; Frequency: 1900 MHz; Medium parameters used: $f = 1900 \text{ MHz}$; $\sigma = 1.53 \text{ mho/m}$; $\epsilon_r = 54.21$; $\rho = 1000 \text{ kg/m}^3$; Phantom section: Flat Section ; Input Power=250mW

Ambient temperature (): 21.5, Liquid temperature (): 21.0

DASY5 Configuration:

- Probe: EX3DV4 - SN3710; ConvF(7.43, 7.43, 7.43); Calibrated: 12/03/2012;
- Sensor-Surface: 4mm (Mechanical Surface Detection)
- Electronics: DAE4 Sn915; Calibrated: 21/06/2012
- Phantom: SAM2; Type: SAM; Serial: TP1562
- Measurement SW: DASY52, Version 52.8 (1); SEMCAD X Version 14.6.5 (6469)

Configuration/System Check Body 1900MHz/Area Scan (7x11x1): Measurement grid: dx=10mm, dy=10mm, Maximum value of SAR (measured) = 11.4 mW/g

Configuration/System Check Body 1900MHz/Zoom Scan (7x7x7)/Cube 0: Measurement grid: dx=5mm, dy=5mm, dz=5mm, Reference Value = 86.570 V/m; Power Drift = 0.03 dB

Peak SAR (extrapolated) = 19.049 mW/g

SAR(1 g) = 10.3 mW/g; SAR(10 g) = 5.33 mW/g Maximum value of SAR (measured) = 11.6 mW/g

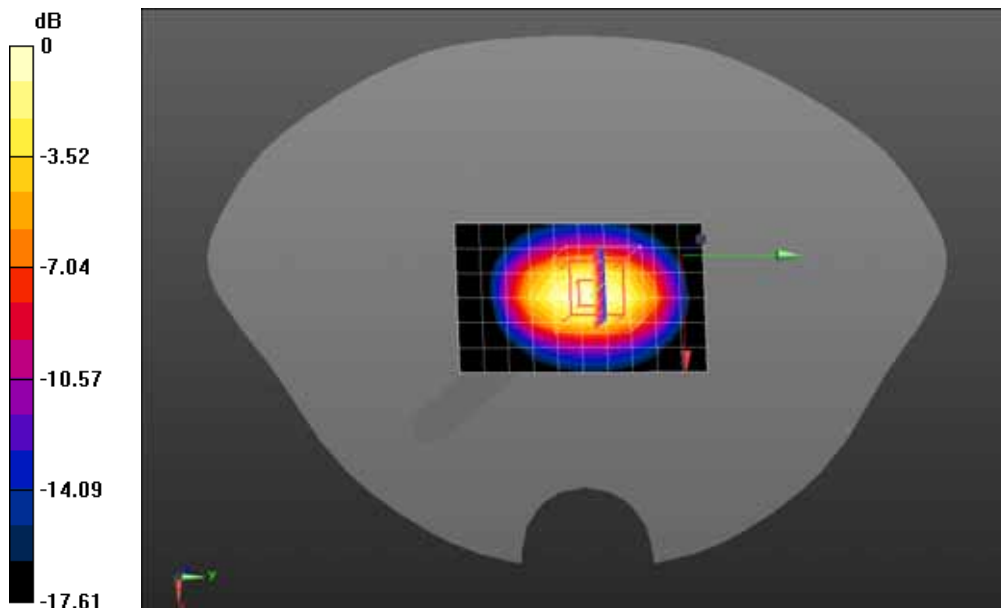

0 dB = 11.6 mW/g = 21.29 dB mW/g

Date/Time: 06-02-2013

Test Laboratory: QuieTek Lab

System Check Head 2450MHz

DUT: Dipole 2450 MHz D2450V2; Type: D2450V2

Communication System: CW; Communication System Band: D2450(2450MHz); Duty Cycle: 1:1; Frequency: 2450 MHz; Medium parameters used: $f = 2450$ MHz; $\sigma = 1.86$ mho/m; $\epsilon_r = 38.08$; $\rho = 1000$ kg/m³; Phantom section: Flat Section ; Input Power=250mW

Ambient temperature (): 21.5, Liquid temperature (): 21.0

DASY5 Configuration:

- Probe: EX3DV4 - SN3710; ConvF(7.25, 7.25, 7.25); Calibrated: 12/03/2012;
- Sensor-Surface: 4mm (Mechanical Surface Detection)
- Electronics: DAE4 Sn915; Calibrated: 21/06/2012
- Phantom: SAM1; Type: SAM; Serial: TP1561
- Measurement SW: DASY52, Version 52.8 (1); SEMCAD X Version 14.6.5 (6469)

Configuration/System Check Head 2450MHz/Area Scan (6x10x1): Measurement grid: dx=10mm, dy=10mm, Maximum value of SAR (measured) = 13.5 mW/g

Configuration/System Check Head 2450MHz/Zoom Scan (7x7x7)/Cube 0: Measurement grid: dx=5mm, dy=5mm, dz=5mm, Reference Value = 85.565 V/m; Power Drift = 0.12 dB

Peak SAR (extrapolated) = 29.260 mW/g

SAR(1 g) = 13 mW/g; SAR(10 g) = 5.8 mW/g Maximum value of SAR (measured) = 14.8 mW/g

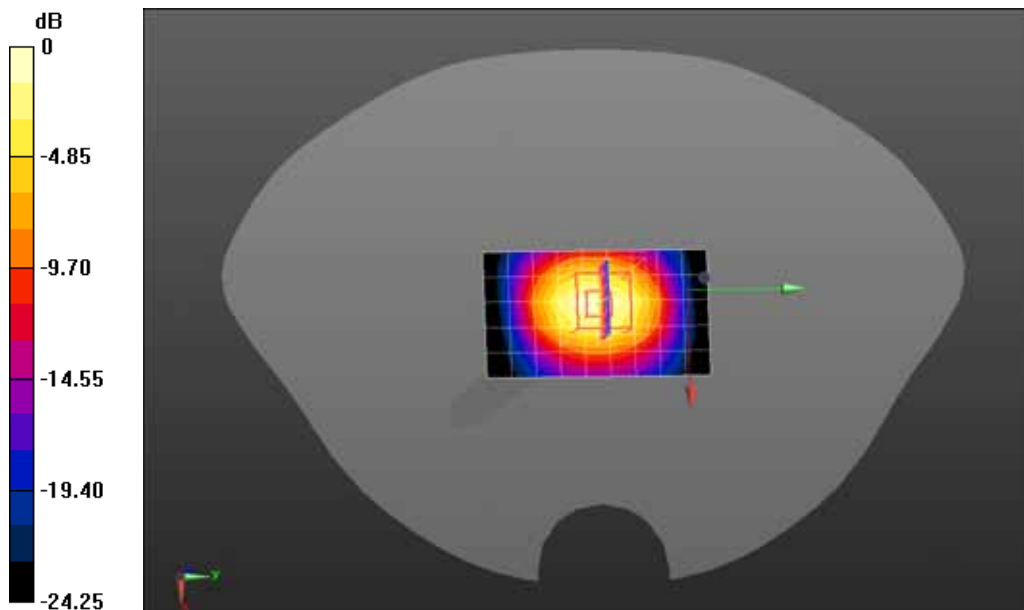

0 dB = 14.8 mW/g = 23.41 dB mW/g

Date/Time: 06-02-2013

Test Laboratory: QuieTek Lab

System Check Body 2450MHz

DUT: Dipole 2450 MHz D2450V2; Type: D2450V2

Communication System: CW; Communication System Band: D2450(2450MHz); Duty Cycle: 1:1; Frequency: 2450 MHz; Medium parameters used: $f = 2450$ MHz; $\sigma = 1.9$ mho/m; $\epsilon_r = 53.33$; $\rho = 1000$ kg/m³; Phantom section: Flat Section ; Input Power=250mW

Ambient temperature (): 21.5, Liquid temperature (): 21.0

DASY5 Configuration:

- Probe: EX3DV4 - SN3710; ConvF(6.98, 6.98, 6.98); Calibrated: 12/03/2012;
- Sensor-Surface: 4mm (Mechanical Surface Detection)
- Electronics: DAE4 Sn915; Calibrated: 21/06/2012
- Phantom: SAM2; Type: SAM; Serial: TP1562
- Measurement SW: DASY52, Version 52.8 (1); SEMCAD X Version 14.6.5 (6469)

Configuration/System Check Body 2450MHz/Area Scan (7x11x1): Measurement grid: dx=10mm, dy=10mm, Maximum value of SAR (measured) = 12.6 mW/g

Configuration/System Check Body 2450MHz/Zoom Scan (7x7x7)/Cube 0: Measurement grid: dx=5mm, dy=5mm, dz=5mm, Reference Value = 81.492 V/m; Power Drift = 0.04 dB

Peak SAR (extrapolated) = 24.706 mW/g

SAR(1 g) = 11.7 mW/g; SAR(10 g) = 5.32 mW/g Maximum value of SAR (measured) = 13.4 mW/g

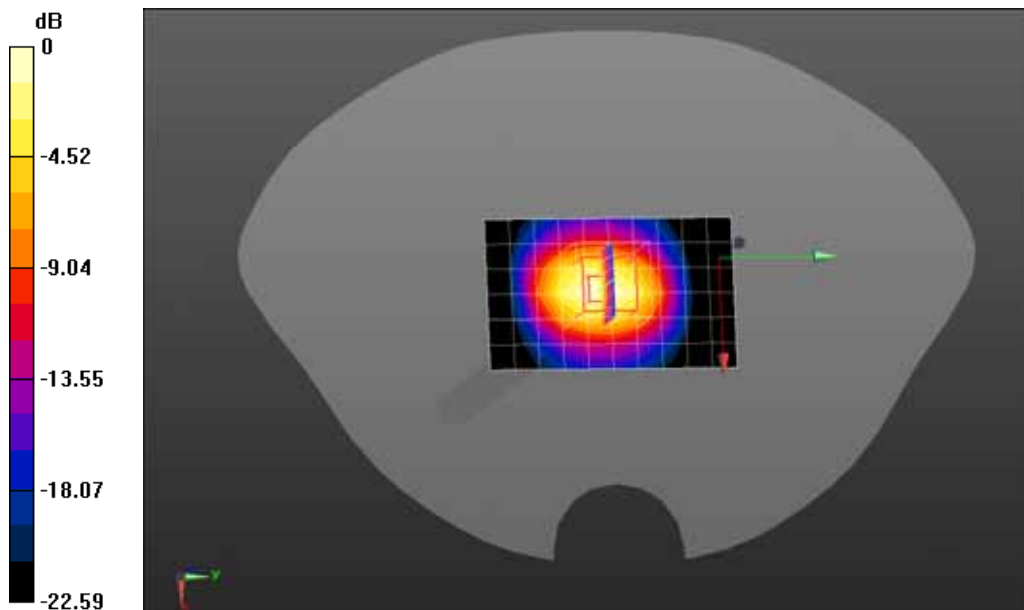

0 dB = 13.4 mW/g = 22.54 dB mW/g

Appendix B. SAR measurement Data

Date/Time: 06-02-2013

Test Laboratory: QuieTek Lab

GSM850 Mid Touch-Left

DUT: Smartphone ; Type: W5510

Communication System: Generic GSM; Communication System Band: GSM850; Duty Cycle: 1:8.3;

Frequency: 836.4 MHz; Medium parameters used: $f = 836.4$ MHz; $\sigma = 0.9$ mho/m; $\epsilon_r = 41.86$; $\rho = 1000$ kg/m³ ; Phantom section: Left Section

Ambient temperature (): 21.5, Liquid temperature (): 21.0

DASY5 Configuration:

- Probe: EX3DV4 - SN3710; ConvF(9.18, 9.18, 9.18); Calibrated: 12/03/2012;
- Sensor-Surface: 4mm (Mechanical Surface Detection)
- Electronics: DAE4 Sn915; Calibrated: 21/06/2012
- Phantom: SAM1; Type: SAM; Serial: TP1561
- Measurement SW: DASY52, Version 52.8 (1); SEMCAD X Version 14.6.5 (6469)

Configuration/GSM850 Mid Touch-Left/Area Scan (7x11x1): Measurement grid: dx=15mm, dy=15mm

Maximum value of SAR (measured) = 0.637 mW/g

Configuration/GSM850 Mid Touch-Left/Zoom Scan (6x6x7)/Cube 0: Measurement grid: dx=8mm,

dy=8mm, dz=5mm, Reference Value = 7.406 V/m; Power Drift = -0.14 dB

Peak SAR (extrapolated) = 0.803 mW/g

SAR(1 g) = 0.613 mW/g; SAR(10 g) = 0.450 mW/g Maximum value of SAR (measured) = 0.644 mW/g

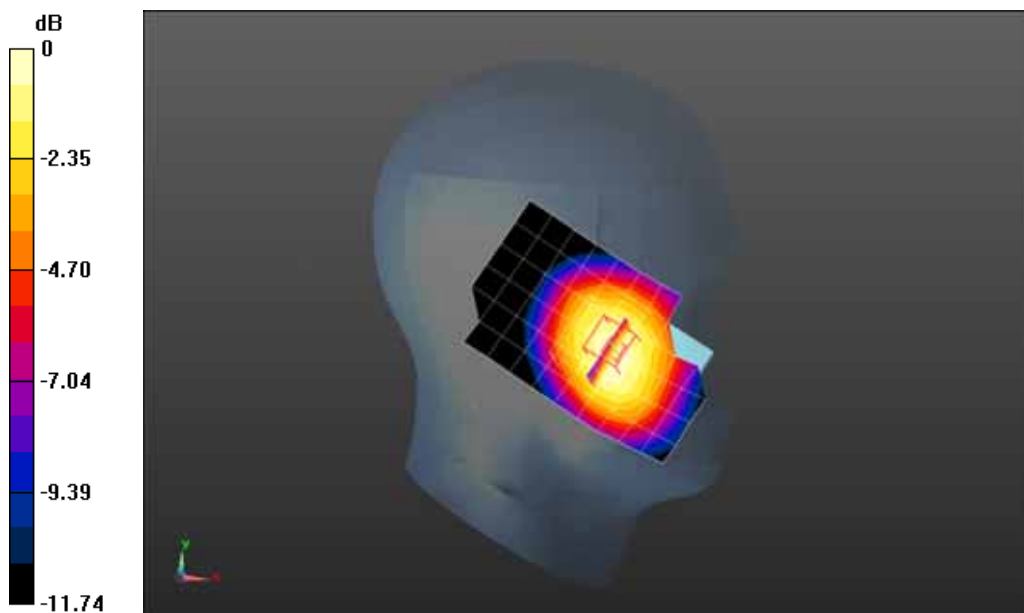

0 dB = 0.644 mW/g = -3.82 dB mW/g

Date/Time: 06-02-2013

Test Laboratory: QuieTek Lab

GSM850 Mid Tilt-Left

DUT: Smartphone ; Type: W5510

Communication System: Generic GSM; Communication System Band: GSM850; Duty Cycle: 1:8.3;

Frequency: 836.4 MHz; Medium parameters used: $f = 836.4$ MHz; $\sigma = 0.9$ mho/m; $\epsilon_r = 41.86$; $\rho = 1000$ kg/m³ ; Phantom section: Left Section

Ambient temperature (): 21.5, Liquid temperature (): 21.0

DASY5 Configuration:

- Probe: EX3DV4 - SN3710; ConvF(9.18, 9.18, 9.18); Calibrated: 12/03/2012;
- Sensor-Surface: 4mm (Mechanical Surface Detection)
- Electronics: DAE4 Sn915; Calibrated: 21/06/2012
- Phantom: SAM1; Type: SAM; Serial: TP1561
- Measurement SW: DASY52, Version 52.8 (1); SEMCAD X Version 14.6.5 (6469)

Configuration/GSM850 Mid Tilt-Left/Area Scan (7x11x1): Measurement grid: dx=15mm, dy=15mm

Maximum value of SAR (measured) = 0.395 mW/g

Configuration/GSM850 Mid Tilt-Left/Zoom Scan (5x5x7)/Cube 0: Measurement grid: dx=8mm, dy=8mm, dz=5mm, Reference Value = 12.789 V/m; Power Drift = -0.10 dB

Peak SAR (extrapolated) = 0.474 mW/g

SAR(1 g) = 0.390 mW/g; SAR(10 g) = 0.299 mW/g Maximum value of SAR (measured) = 0.407 mW/g

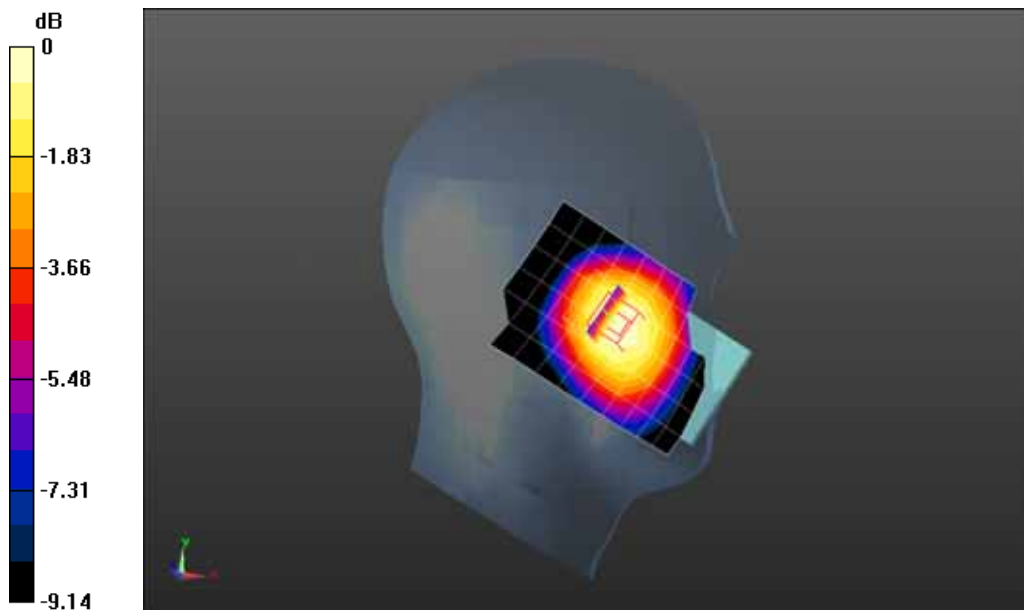

0 dB = 0.407 mW/g = -7.81 dB mW/g

Date/Time: 06-02-2013

Test Laboratory: QuieTek Lab

GSM850 Mid Touch-Right

DUT: Smartphone ; Type: W5510

Communication System: Generic GSM; Communication System Band: GSM850; Duty Cycle: 1:8.3;

Frequency: 836.4 MHz; Medium parameters used: $f = 836.4$ MHz; $\sigma = 0.9$ mho/m; $\epsilon_r = 41.86$; $\rho = 1000$ kg/m³; Phantom section: Right Section

Ambient temperature (): 21.5, Liquid temperature (): 21.0

DASY5 Configuration:

- Probe: EX3DV4 - SN3710; ConvF(9.18, 9.18, 9.18); Calibrated: 12/03/2012;
- Sensor-Surface: 4mm (Mechanical Surface Detection)
- Electronics: DAE4 Sn915; Calibrated: 21/06/2012
- Phantom: SAM1; Type: SAM; Serial: TP1561
- Measurement SW: DASY52, Version 52.8 (1); SEMCAD X Version 14.6.5 (6469)

Configuration/GSM850 Mid Touch-Right/Area Scan (7x11x1): Measurement grid: dx=15mm, dy=15mm

Maximum value of SAR (measured) = 0.586 mW/g

Configuration/GSM850 Mid Touch-Right/Zoom Scan (5x5x7)/Cube 0: Measurement grid: dx=8mm, dy=8mm, dz=5mm, Reference Value = 5.962 V/m; Power Drift = 0.09 dB

Peak SAR (extrapolated) = 0.699 mW/g

SAR(1 g) = 0.580 mW/g; SAR(10 g) = 0.442 mW/g Maximum value of SAR (measured) = 0.605 mW/g

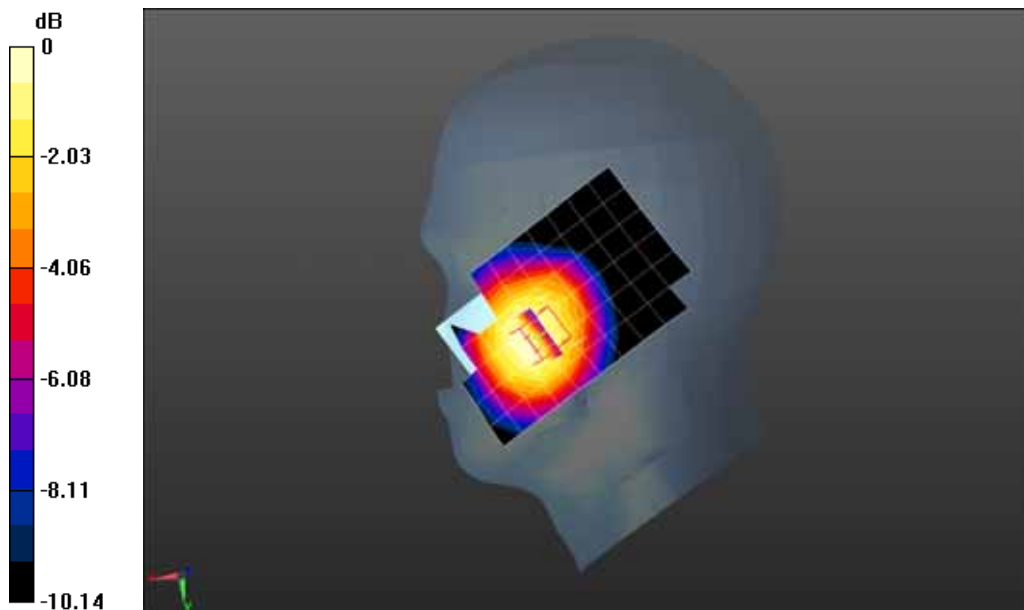

0 dB = 0.605 mW/g = -4.36 dB mW/g

Date/Time: 06-02-2013

Test Laboratory: QuieTek Lab

GSM850 Mid Tilt-Right

DUT: Smartphone ; Type: W5510

Communication System: Generic GSM; Communication System Band: GSM850; Duty Cycle: 1:8.3;
 Frequency: 836.4 MHz; Medium parameters used: $f = 836.4$ MHz; $\sigma = 0.9$ mho/m; $\epsilon_r = 41.86$; $\rho = 1000$ kg/m³ ; Phantom section: Right Section

Ambient temperature (): 21.5, Liquid temperature (): 21.0

DASY5 Configuration:

- Probe: EX3DV4 - SN3710; ConvF(9.18, 9.18, 9.18); Calibrated: 12/03/2012;
- Sensor-Surface: 4mm (Mechanical Surface Detection)
- Electronics: DAE4 Sn915; Calibrated: 21/06/2012
- Phantom: SAM1; Type: SAM; Serial: TP1561
- Measurement SW: DASY52, Version 52.8 (1); SEMCAD X Version 14.6.5 (6469)

Configuration/GSM850 Mid Tilt-Right/Area Scan (7x11x1): Measurement grid: dx=15mm, dy=15mm

Maximum value of SAR (measured) = 0.380 mW/g

Configuration/GSM850 Mid Tilt-Right/Zoom Scan (5x5x7)/Cube 0: Measurement grid: dx=8mm, dy=8mm, dz=5mm, Reference Value = 11.862 V/m; Power Drift = -0.12 dB

Peak SAR (extrapolated) = 0.465 mW/g

SAR(1 g) = 0.381 mW/g; SAR(10 g) = 0.290 mW/g Maximum value of SAR (measured) = 0.400 mW/g

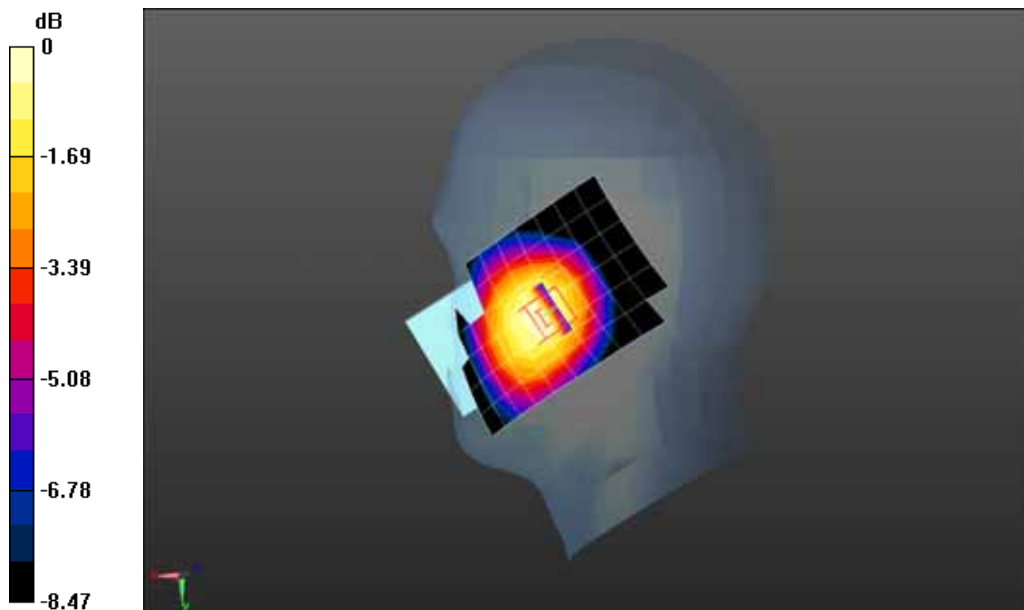

0 dB = 0.400 mW/g = -7.96 dB mW/g

Date/Time: 06-02-2013

Test Laboratory: QuieTek Lab

GSM850 Mid Body-Back

DUT: Smartphone ; Type: W5510

Communication System: Generic GSM; Communication System Band: GSM850; Duty Cycle: 1:8.3;
 Frequency: 836.4 MHz; Medium parameters used: $f = 836.4$ MHz; $\sigma = 0.96$ mho/m; $\epsilon_r = 53.92$; $\rho = 1000$ kg/m³ ; Phantom section: Flat Section

Ambient temperature (): 21.5, Liquid temperature (): 21.0

DASY5 Configuration:

- Probe: EX3DV4 - SN3710; ConvF(9.13, 9.13, 9.13); Calibrated: 12/03/2012;
- Sensor-Surface: 4mm (Mechanical Surface Detection)
- Electronics: DAE4 Sn915; Calibrated: 21/06/2012
- Phantom: SAM1; Type: SAM; Serial: TP1561
- Measurement SW: DASY52, Version 52.8 (1); SEMCAD X Version 14.6.5 (6469)

Configuration/GSM850 Mid Body-Back/Area Scan (7x11x1): Measurement grid: dx=15mm, dy=15mm

Maximum value of SAR (measured) = 0.685 mW/g

Configuration/GSM850 Mid Body-Back/Zoom Scan (5x5x7)/Cube 1: Measurement grid: dx=8mm, dy=8mm, dz=5mm, Reference Value = 11.678 V/m; Power Drift = -0.10 dB

Peak SAR (extrapolated) = 0.877 mW/g

SAR(1 g) = 0.631 mW/g; SAR(10 g) = 0.446 mW/g Maximum value of SAR (measured) = 0.692 mW/g

Configuration/GSM850 Mid Body-Back/Zoom Scan (5x5x7)/Cube 0: Measurement grid: dx=8mm, dy=8mm, dz=5mm, Reference Value = 11.678 V/m; Power Drift = -0.10 dB

Peak SAR (extrapolated) = 0.888 mW/g

SAR(1 g) = 0.672 mW/g; SAR(10 g) = 0.492 mW/g Maximum value of SAR (measured) = 0.708 mW/g

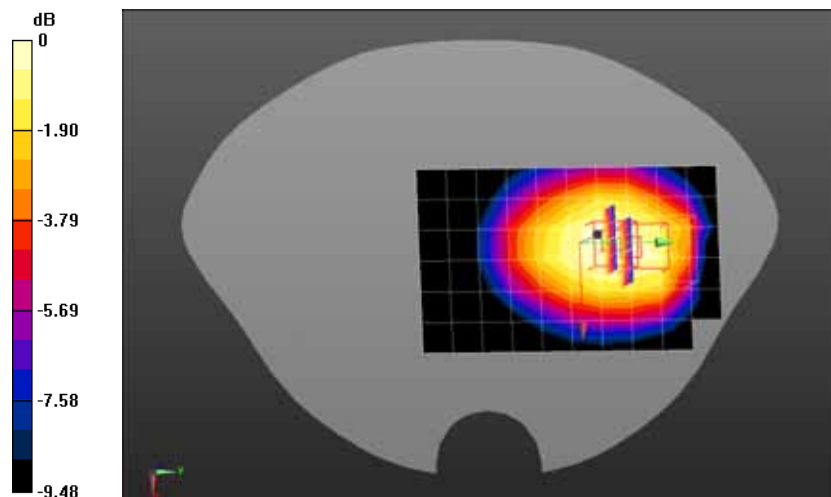

0 dB = 0.708 mW/g = -3.00 dB mW/g

Date/Time: 06-02-2013

Test Laboratory: QuieTek Lab

GPRS850 Low Body-Back(3up)

DUT: Smartphone ; Type: W5510

Communication System: GPRS/EGPRS-3 Slot; Communication System Band: GSM 850; Duty Cycle: 1:2.8 ;
 Frequency: 824.2 MHz; Medium parameters used: $f = 824.2$ MHz; $\sigma = 0.95$ mho/m; $\epsilon_r = 54.06$; $\rho = 1000$ kg/m³ ; Phantom section: Flat Section

Ambient temperature (): 21.5, Liquid temperature (): 21.0

DASY5 Configuration:

- Probe: EX3DV4 - SN3710; ConvF(9.13, 9.13, 9.13); Calibrated: 12/03/2012;
- Sensor-Surface: 4mm (Mechanical Surface Detection)
- Electronics: DAE4 Sn915; Calibrated: 21/06/2012
- Phantom: SAM1; Type: SAM; Serial: TP1561
- Measurement SW: DASY52, Version 52.8 (1); SEMCAD X Version 14.6.5 (6469)

Configuration/GPRS850 Low Body-Back/Area Scan (7x11x1): Measurement grid: dx=15mm, dy=15mm

Maximum value of SAR (measured) = 1.10 mW/g

Configuration/GPRS850 Low Body-Back/Zoom Scan (5x5x7)/Cube 1: Measurement grid: dx=8mm, dy=8mm, dz=5mm, Reference Value = 11.358 V/m; Power Drift = 0.06 dB

Peak SAR (extrapolated) = 1.399 mW/g

SAR(1 g) = 0.927 mW/g; SAR(10 g) = 0.642 mW/g Maximum value of SAR (measured) = 0.992 mW/g

Configuration/GPRS850 Low Body-Back/Zoom Scan (5x5x7)/Cube 0: Measurement grid: dx=8mm, dy=8mm, dz=5mm, Reference Value = 11.358 V/m; Power Drift = 0.06 dB

Peak SAR (extrapolated) = 1.341 mW/g

SAR(1 g) = 1.03 mW/g; SAR(10 g) = 0.763 mW/g Maximum value of SAR (measured) = 1.08 mW/g

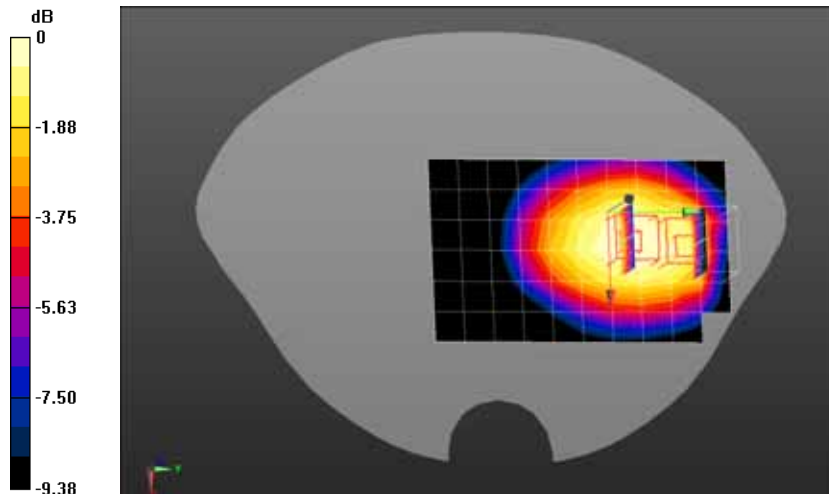

0 dB = 1.08 mW/g = 0.67 dB mW/g

Z-Axis Plot

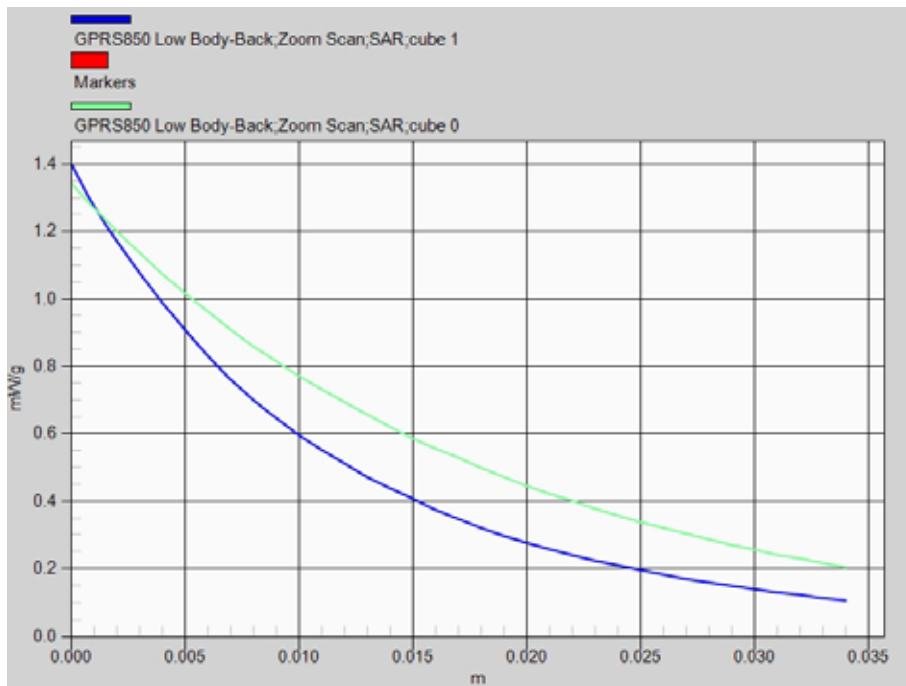

Date/Time: 06-02-2013

Test Laboratory: QuieTek Lab

GPRS850 Low Body-Back(3up)-1

DUT: Smartphone ; Type: W5510

Communication System: GPRS/EGPRS-3 Slot; Communication System Band: GSM 850; Duty Cycle: 1:2.8 ;
 Frequency: 824.2 MHz; Medium parameters used: $f = 824.2$ MHz; $\sigma = 0.95$ mho/m; $\epsilon_r = 54.06$; $\rho = 1000$ kg/m³ ; Phantom section: Flat Section

Ambient temperature (): 21.5, Liquid temperature (): 21.0

DASY5 Configuration:

- Probe: EX3DV4 - SN3710; ConvF(9.13, 9.13, 9.13); Calibrated: 12/03/2012;
- Sensor-Surface: 4mm (Mechanical Surface Detection)
- Electronics: DAE4 Sn915; Calibrated: 21/06/2012
- Phantom: SAM1; Type: SAM; Serial: TP1561
- Measurement SW: DASY52, Version 52.8 (1); SEMCAD X Version 14.6.5 (6469)

Configuration/GPRS850 Low Body-Back/Area Scan (7x11x1): Measurement grid: dx=15mm, dy=15mm

Maximum value of SAR (measured) = 1.02 mW/g

Configuration/GPRS850 Low Body-Back/Zoom Scan (5x5x7)/Cube 1: Measurement grid: dx=8mm, dy=8mm, dz=5mm, Reference Value = 14.317 V/m; Power Drift = 0.06 dB

Peak SAR (extrapolated) = 1.286 mW/g

SAR(1 g) = 0.933 mW/g; SAR(10 g) = 0.661 mW/g Maximum value of SAR (measured) = 1.04 mW/g

Configuration/GPRS850 Low Body-Back/Zoom Scan (5x5x7)/Cube 0: Measurement grid: dx=8mm, dy=8mm, dz=5mm, Reference Value = 14.317 V/m; Power Drift = 0.06 dB

Peak SAR (extrapolated) = 1.268 mW/g

SAR(1 g) = 0.978 mW/g; SAR(10 g) = 0.723 mW/g Maximum value of SAR (measured) = 1.03 mW/g

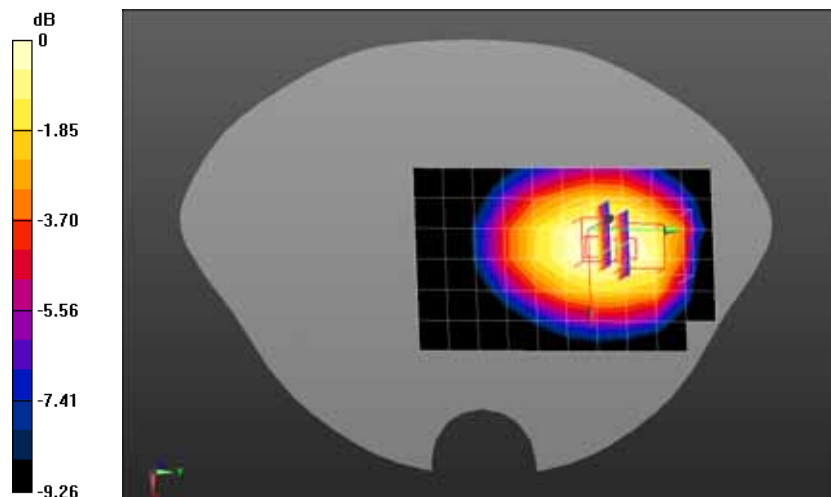

0 dB = 1.03 mW/g = 0.26 dB mW/g

Date/Time: 06-02-2013

Test Laboratory: QuieTek Lab

GPRS850 Mid Body-Back(3up)

DUT: Smartphone ; Type: W5510

Communication System: GPRS/EGPRS-3 Slot; Communication System Band: GSM 850; Duty Cycle: 1:2.8 ; Frequency: 836.4 MHz; Medium parameters used: $f = 836.4$ MHz; $\sigma = 0.96$ mho/m; $\epsilon_r = 53.92$; $\rho = 1000$ kg/m³ ; Phantom section: Flat Section

Ambient temperature (): 21.5, Liquid temperature (): 21.0

DASY5 Configuration:

- Probe: EX3DV4 - SN3710; ConvF(9.13, 9.13, 9.13); Calibrated: 12/03/2012;
- Sensor-Surface: 4mm (Mechanical Surface Detection)
- Electronics: DAE4 Sn915; Calibrated: 21/06/2012
- Phantom: SAM1; Type: SAM; Serial: TP1561
- Measurement SW: DASY52, Version 52.8 (1); SEMCAD X Version 14.6.5 (6469)

Configuration/GPRS850 Mid Body-Back/Area Scan (7x11x1): Measurement grid: dx=15mm, dy=15mm

Maximum value of SAR (measured) = 0.976 mW/g

Configuration/GPRS850 Mid Body-Back/Zoom Scan (5x5x7)/Cube 1: Measurement grid: dx=8mm, dy=8mm, dz=5mm, Reference Value = 13.548 V/m; Power Drift = 0.14 dB

Peak SAR (extrapolated) = 1.277 mW/g

SAR(1 g) = 0.859 mW/g; SAR(10 g) = 0.606 mW/g Maximum value of SAR (measured) = 0.926 mW/g

Configuration/GPRS850 Mid Body-Back/Zoom Scan (5x5x7)/Cube 0: Measurement grid: dx=8mm, dy=8mm, dz=5mm, Reference Value = 13.548 V/m; Power Drift = 0.14 dB

Peak SAR (extrapolated) = 1.264 mW/g

SAR(1 g) = 0.919 mW/g; SAR(10 g) = 0.677 mW/g Maximum value of SAR (measured) = 0.985 mW/g

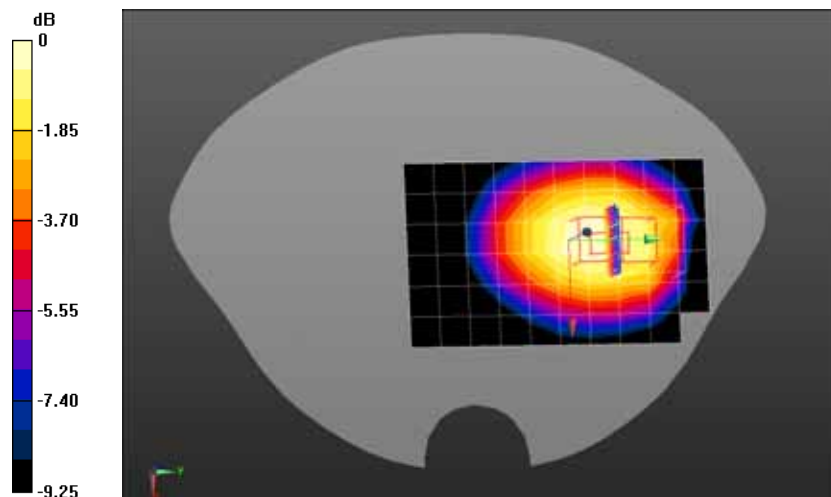

0 dB = 0.985 mW/g = -0.13 dB mW/g

Date/Time: 06-02-2013

Test Laboratory: QuieTek Lab

GPRS850 High Body-Back(3up)

DUT: Smartphone ; Type: W5510

Communication System: GPRS/EGPRS-3 Slot; Communication System Band: GSM 850; Duty Cycle: 1:2.8 ;
 Frequency: 848.8 MHz; Medium parameters used: $f = 848.8$ MHz; $\sigma = 0.97$ mho/m; $\epsilon_r = 53.79$; $\rho = 1000$ kg/m³ ; Phantom section: Flat Section

Ambient temperature (): 21.5, Liquid temperature (): 21.0

DASY5 Configuration:

- Probe: EX3DV4 - SN3710; ConvF(9.13, 9.13, 9.13); Calibrated: 12/03/2012;
- Sensor-Surface: 4mm (Mechanical Surface Detection)
- Electronics: DAE4 Sn915; Calibrated: 21/06/2012
- Phantom: SAM1; Type: SAM; Serial: TP1561
- Measurement SW: DASY52, Version 52.8 (1); SEMCAD X Version 14.6.5 (6469)

Configuration/GPRS850 High Body-Back/Area Scan (7x11x1): Measurement grid: dx=15mm, dy=15mm

Maximum value of SAR (measured) = 0.802 mW/g

Configuration/GPRS850 High Body-Back/Zoom Scan (5x5x7)/Cube 1: Measurement grid: dx=8mm, dy=8mm, dz=5mm, Reference Value = 12.949 V/m; Power Drift = 0.16 dB

Peak SAR (extrapolated) = 1.024 mW/g

SAR(1 g) = 0.729 mW/g; SAR(10 g) = 0.517 mW/g Maximum value of SAR (measured) = 0.823 mW/g

Configuration/GPRS850 High Body-Back/Zoom Scan (5x5x7)/Cube 0: Measurement grid: dx=8mm, dy=8mm, dz=5mm, Reference Value = 12.949 V/m; Power Drift = 0.16 dB

Peak SAR (extrapolated) = 1.068 mW/g

SAR(1 g) = 0.815 mW/g; SAR(10 g) = 0.593 mW/g Maximum value of SAR (measured) = 0.872 mW/g

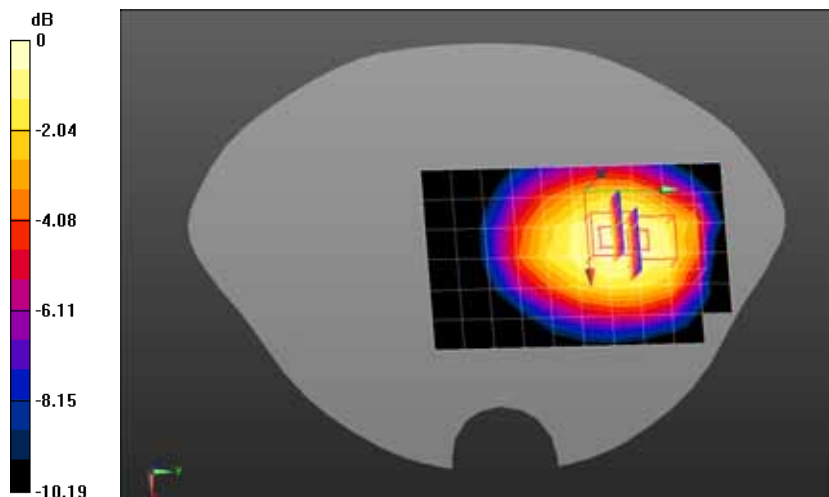

0 dB = 0.872 mW/g = -1.19 dB mW/g

Date/Time: 06-02-2013

Test Laboratory: QuieTek Lab

GPRS850 Mid Body-Front(3up)

DUT: Smartphone ; Type: W5510

Communication System: GPRS/EGPRS-3 Slot; Communication System Band: GSM 850; Duty Cycle: 1:2.8 ;
 Frequency: 836.4 MHz; Medium parameters used: $f = 836.4$ MHz; $\sigma = 0.96$ mho/m; $\epsilon_r = 53.92$; $\rho = 1000$ kg/m³ ; Phantom section: Flat Section

Ambient temperature (): 21.5, Liquid temperature (): 21.0

DASY5 Configuration:

- Probe: EX3DV4 - SN3710; ConvF(9.13, 9.13, 9.13); Calibrated: 12/03/2012;
- Sensor-Surface: 4mm (Mechanical Surface Detection)
- Electronics: DAE4 Sn915; Calibrated: 21/06/2012
- Phantom: SAM1; Type: SAM; Serial: TP1561
- Measurement SW: DASY52, Version 52.8 (1); SEMCAD X Version 14.6.5 (6469)

Configuration/GPRS850 Mid Body-Front/Area Scan (7x11x1): Measurement grid: dx=15mm, dy=15mm

Maximum value of SAR (measured) = 0.783 mW/g

Configuration/GPRS850 Mid Body-Front/Zoom Scan (5x5x7)/Cube 0: Measurement grid: dx=8mm, dy=8mm, dz=5mm, Reference Value = 8.168 V/m; Power Drift = -0.10 dB

Peak SAR (extrapolated) = 0.996 mW/g

SAR(1 g) = 0.749 mW/g; SAR(10 g) = 0.557 mW/g Maximum value of SAR (measured) = 0.781 mW/g

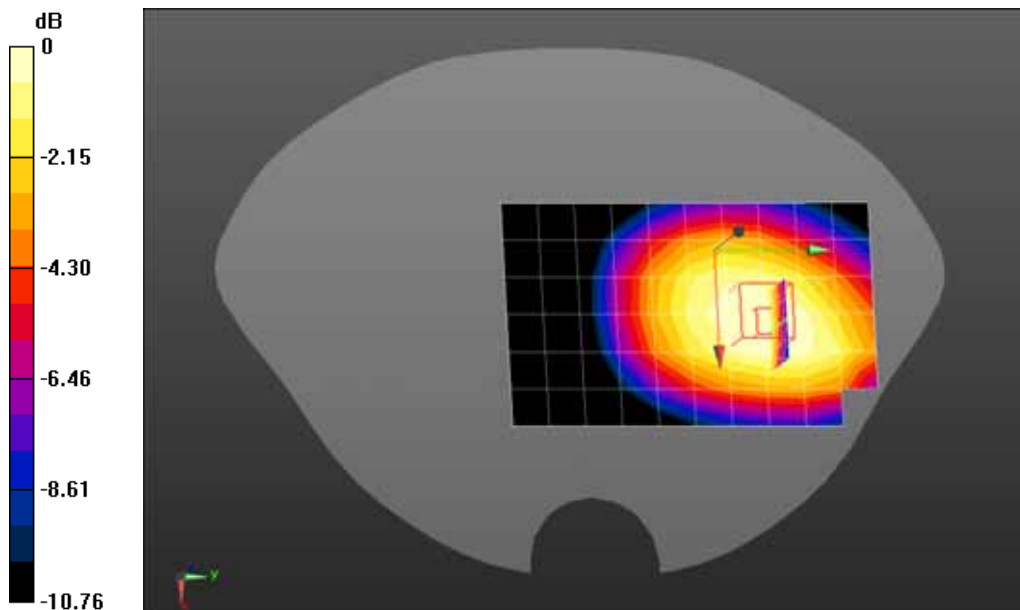

0 dB = 0.781 mW/g = -2.15 dB mW/g

Date/Time: 06-02-2013

Test Laboratory: QuieTek Lab

GPRS850 Mid Body-Bottom(3up)

DUT: Smartphone ; Type: W5510

Communication System: GPRS/EGPRS-3 Slot; Communication System Band: GSM 850; Duty Cycle: 1:2.8 ;
 Frequency: 836.4 MHz; Medium parameters used: $f = 836.4$ MHz; $\sigma = 0.96$ mho/m; $\epsilon_r = 53.92$; $\rho = 1000$ kg/m³ ; Phantom section: Flat Section

Ambient temperature (): 21.5, Liquid temperature (): 21.0

DASY5 Configuration:

- Probe: EX3DV4 - SN3710; ConvF(9.13, 9.13, 9.13); Calibrated: 12/03/2012;
- Sensor-Surface: 4mm (Mechanical Surface Detection)
- Electronics: DAE4 Sn915; Calibrated: 21/06/2012
- Phantom: SAM1; Type: SAM; Serial: TP1561
- Measurement SW: DASY52, Version 52.8 (1); SEMCAD X Version 14.6.5 (6469)

Configuration/GPRS850 Mid Body-Bottom/Area Scan (7x7x1): Measurement grid: dx=15mm, dy=15mm

Maximum value of SAR (measured) = 0.398 mW/g

Configuration/GPRS850 Mid Body-Bottom/Zoom Scan (5x5x7)/Cube 0: Measurement grid: dx=8mm, dy=8mm, dz=5mm, Reference Value = 15.737 V/m; Power Drift = 0.01 dB

Peak SAR (extrapolated) = 0.822 mW/g

SAR(1 g) = 0.391 mW/g; SAR(10 g) = 0.205 mW/g Maximum value of SAR (measured) = 0.402 mW/g

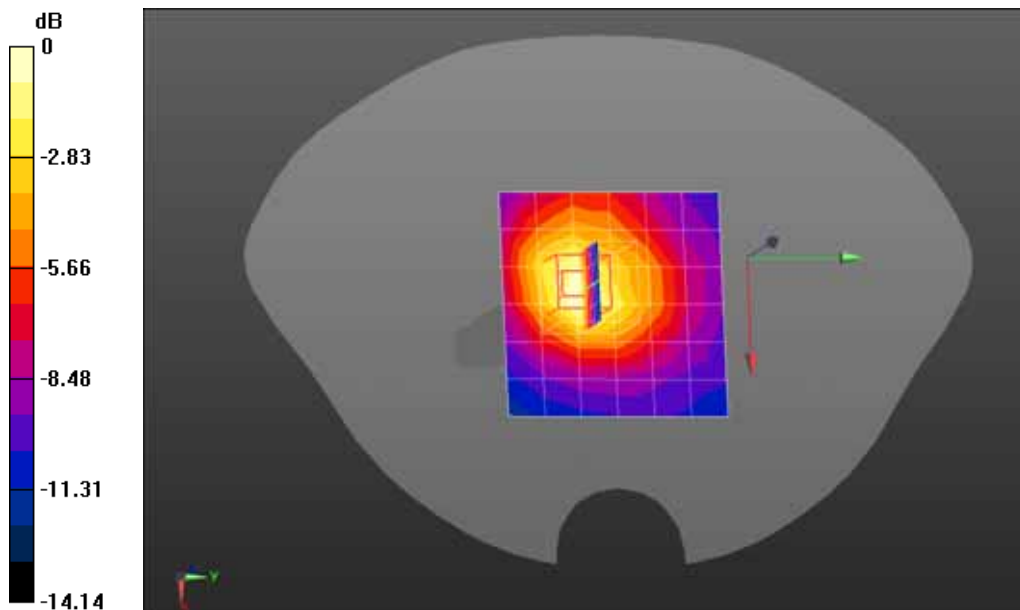

0 dB = 0.402 mW/g = -7.92 dB mW/g

Date/Time: 06-02-2013

Test Laboratory: QuieTek Lab

GPRS850 Mid Body-Left side(3up)

DUT: Smartphone ; Type: W5510

Communication System: GPRS/EGPRS-3 Slot; Communication System Band: GSM 850; Duty Cycle: 1:2.8 ;
 Frequency: 836.4 MHz; Medium parameters used: $f = 836.4$ MHz; $\sigma = 0.96$ mho/m; $\epsilon_r = 53.92$; $\rho = 1000$ kg/m³ ; Phantom section: Flat Section

Ambient temperature (): 21.5, Liquid temperature (): 21.0

DASY5 Configuration:

- Probe: EX3DV4 - SN3710; ConvF(9.13, 9.13, 9.13); Calibrated: 12/03/2012;
- Sensor-Surface: 4mm (Mechanical Surface Detection)
- Electronics: DAE4 Sn915; Calibrated: 21/06/2012
- Phantom: SAM1; Type: SAM; Serial: TP1561
- Measurement SW: DASY52, Version 52.8 (1); SEMCAD X Version 14.6.5 (6469)

Configuration/GPRS850 Mid Body-Left side/Area Scan (6x11x1): Measurement grid: dx=15mm, dy=15mm, Maximum value of SAR (measured) = 0.606 mW/g

Configuration/GPRS850 Mid Body-Left side/Zoom Scan (5x5x7)/Cube 0: Measurement grid: dx=8mm, dy=8mm, dz=5mm, Reference Value = 15.355 V/m; Power Drift = -0.11 dB

Peak SAR (extrapolated) = 0.836 mW/g

SAR(1 g) = 0.594 mW/g; SAR(10 g) = 0.409 mW/g Maximum value of SAR (measured) = 0.631 mW/g

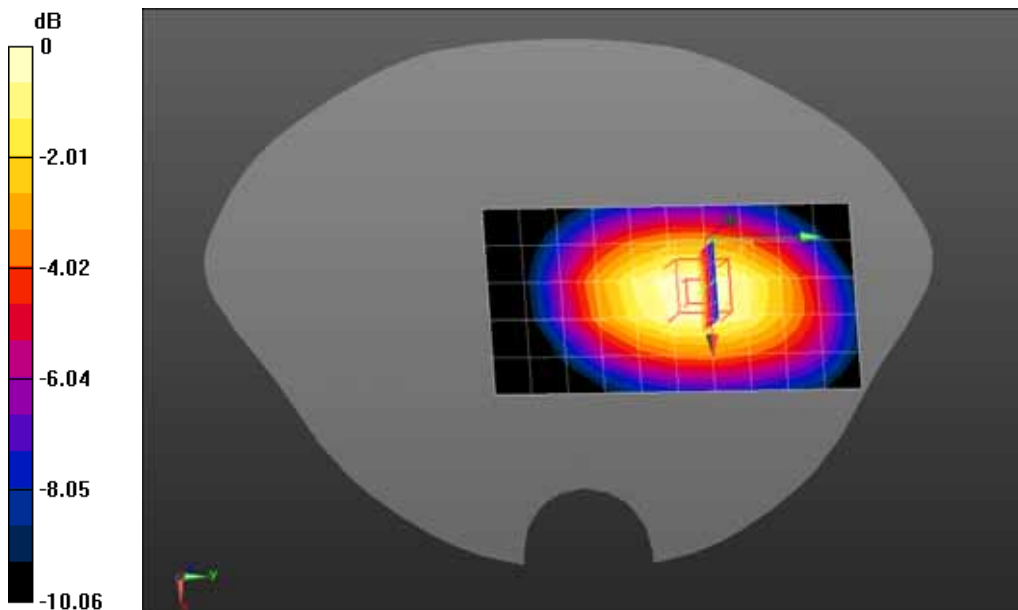

0 dB = 0.631 mW/g = -4.00 dB mW/g

Date/Time: 06-02-2013

Test Laboratory: QuieTek Lab

GPRS850 Mid Body-Right side(3up)

DUT: Smartphone ; Type: W5510

Communication System: GPRS/EGPRS-3 Slot; Communication System Band: GSM 850; Duty Cycle: 1:2.8 ;
 Frequency: 836.4 MHz; Medium parameters used: $f = 836.4$ MHz; $\sigma = 0.96$ mho/m; $\epsilon_r = 53.92$; $\rho = 1000$ kg/m³ ; Phantom section: Flat Section

Ambient temperature (): 21.5, Liquid temperature (): 21.0

DASY5 Configuration:

- Probe: EX3DV4 - SN3710; ConvF(9.13, 9.13, 9.13); Calibrated: 12/03/2012;
- Sensor-Surface: 4mm (Mechanical Surface Detection)
- Electronics: DAE4 Sn915; Calibrated: 21/06/2012
- Phantom: SAM1; Type: SAM; Serial: TP1561
- Measurement SW: DASY52, Version 52.8 (1); SEMCAD X Version 14.6.5 (6469)

Configuration/GPRS850 Mid Body-Right side/Area Scan (6x11x1): Measurement grid: dx=15mm, dy=15mm, Maximum value of SAR (measured) = 0.560 mW/g

Configuration/GPRS850 Mid Body-Right side/Zoom Scan (5x5x7)/Cube 0: Measurement grid: dx=8mm, dy=8mm, dz=5mm, Reference Value = 16.913 V/m; Power Drift = -0.19 dB

Peak SAR (extrapolated) = 0.794 mW/g

SAR(1 g) = 0.559 mW/g; SAR(10 g) = 0.386 mW/g Maximum value of SAR (measured) = 0.597 mW/g

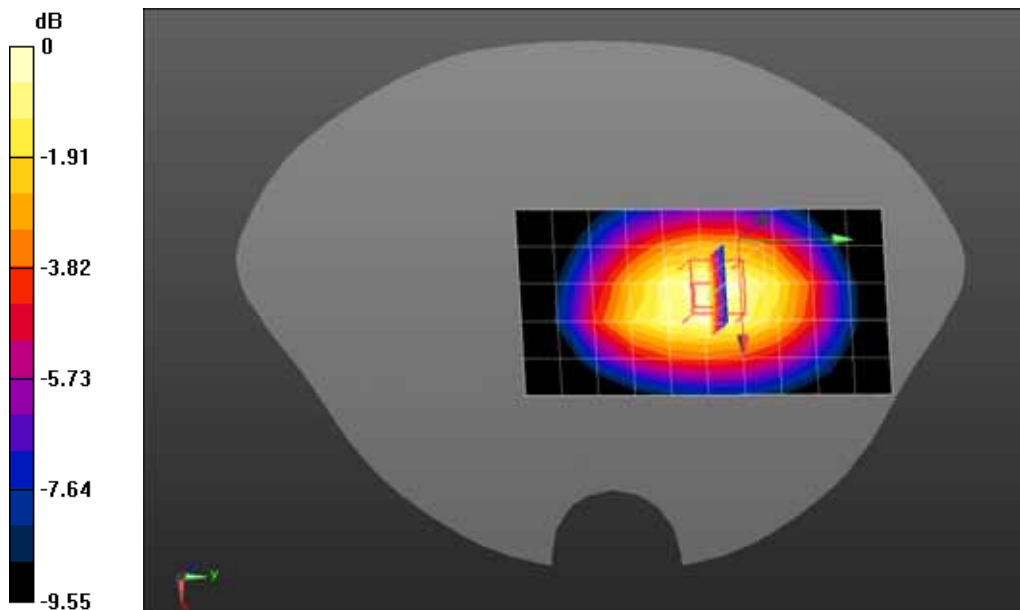

0 dB = 0.597 mW/g = -4.48 dB mW/g

Date/Time: 06-02-2013

Test Laboratory: QuieTek Lab

PCS1900 Mid Touch-Left

DUT: Smartphone ; Type: W5510

Communication System: Generic GSM; Communication System Band: PCS1900; Duty Cycle: 1:8.3;

Frequency: 1880 MHz; Medium parameters used: $f = 1880$ MHz; $\sigma = 1.44$ mho/m; $\epsilon_r = 39.28$; $\rho = 1000$

kg/m³ ; Phantom section: Left Section

Ambient temperature (): 21.5, Liquid temperature (): 21.0

DASY5 Configuration:

- Probe: EX3DV4 - SN3710; ConvF(8.16, 8.16, 8.16); Calibrated: 12/03/2012;
- Sensor-Surface: 4mm (Mechanical Surface Detection)
- Electronics: DAE4 Sn915; Calibrated: 21/06/2012
- Phantom: SAM2; Type: SAM; Serial: TP1562
- Measurement SW: DASY52, Version 52.8 (1); SEMCAD X Version 14.6.5 (6469)

Configuration/PCS1900 Mid Touch-Left/Area Scan (7x11x1): Measurement grid: dx=15mm, dy=15mm

Maximum value of SAR (measured) = 0.407 mW/g

Configuration/PCS1900 Mid Touch-Left/Zoom Scan (5x5x7)/Cube 0: Measurement grid: dx=8mm, dy=8mm, dz=5mm, Reference Value = 6.180 V/m; Power Drift = 0.02 dB

Peak SAR (extrapolated) = 0.776 mW/g

SAR(1 g) = 0.436 mW/g; SAR(10 g) = 0.238 mW/g Maximum value of SAR (measured) = 0.472 mW/g

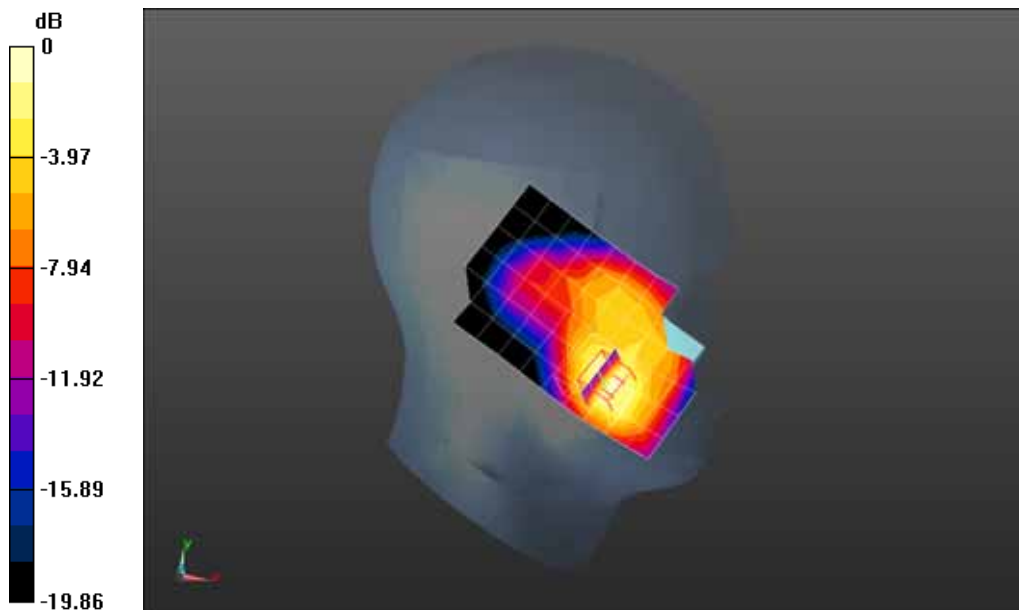

0 dB = 0.472 mW/g = -6.52 dB mW/g

Date/Time: 06-02-2013

Test Laboratory: QuieTek Lab

PCS1900 Mid Tilt-Left

DUT: Smartphone ; Type: W5510

Communication System: Generic GSM; Communication System Band: PCS1900; Duty Cycle: 1:8.3;

Frequency: 1880 MHz; Medium parameters used: $f = 1880$ MHz; $\sigma = 1.44$ mho/m; $\epsilon_r = 39.28$; $\rho = 1000$ kg/m³ ; Phantom section: Left Section

Ambient temperature (): 21.5, Liquid temperature (): 21.0

DASY5 Configuration:

- Probe: EX3DV4 - SN3710; ConvF(8.16, 8.16, 8.16); Calibrated: 12/03/2012;
- Sensor-Surface: 4mm (Mechanical Surface Detection)
- Electronics: DAE4 Sn915; Calibrated: 21/06/2012
- Phantom: SAM2; Type: SAM; Serial: TP1562
- Measurement SW: DASY52, Version 52.8 (1); SEMCAD X Version 14.6.5 (6469)

Configuration/PCS1900 Mid Tilt-Left/Area Scan (7x11x1): Measurement grid: dx=15mm, dy=15mm

Maximum value of SAR (measured) = 0.119 mW/g

Configuration/PCS1900 Mid Tilt-Left/Zoom Scan (5x5x7)/Cube 0: Measurement grid: dx=8mm, dy=8mm, dz=5mm, Reference Value = 9.487 V/m; Power Drift = -0.01 dB

Peak SAR (extrapolated) = 0.202 mW/g

SAR(1 g) = 0.120 mW/g; SAR(10 g) = 0.069 mW/g Maximum value of SAR (measured) = 0.132 mW/g

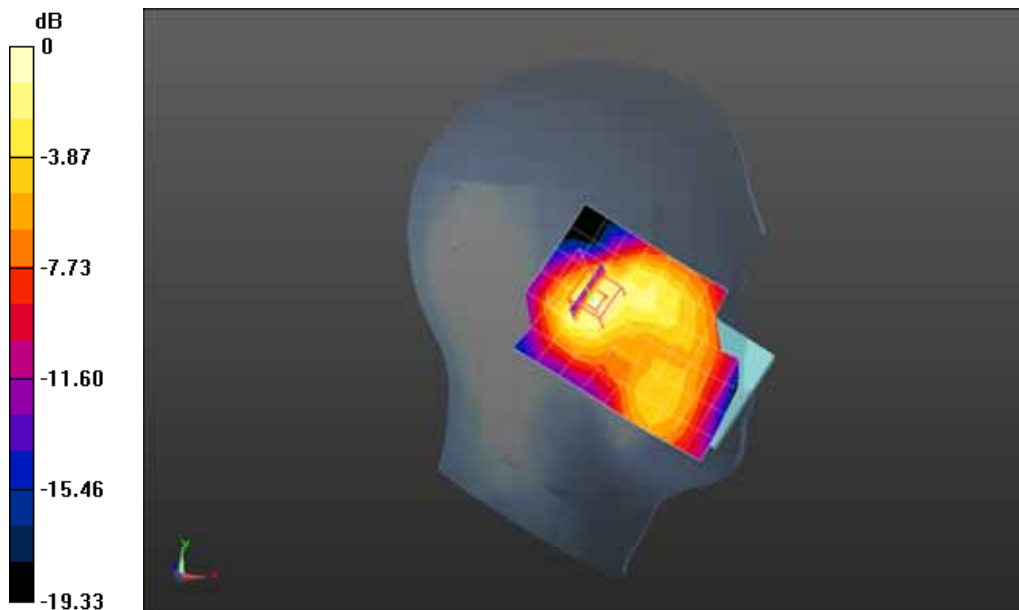

0 dB = 0.132 mW/g = -17.59 dB mW/g

Date/Time: 06-02-2013

Test Laboratory: QuieTek Lab

PCS1900 Mid Touch-Right

DUT: Smartphone ; Type: W5510

Communication System: Generic GSM; Communication System Band: PCS1900; Duty Cycle: 1:8.3;

Frequency: 1880 MHz; Medium parameters used: $f = 1880$ MHz; $\sigma = 1.44$ mho/m; $\epsilon_r = 39.28$; $\rho = 1000$

kg/m³ ; Phantom section: Right Section

Ambient temperature (): 21.5, Liquid temperature (): 21.0

DASY5 Configuration:

- Probe: EX3DV4 - SN3710; ConvF(8.16, 8.16, 8.16); Calibrated: 12/03/2012;
- Sensor-Surface: 4mm (Mechanical Surface Detection)
- Electronics: DAE4 Sn915; Calibrated: 21/06/2012
- Phantom: SAM2; Type: SAM; Serial: TP1562
- Measurement SW: DASY52, Version 52.8 (1); SEMCAD X Version 14.6.5 (6469)

Configuration/PCS1900 Mid Touch-Right/Area Scan (7x11x1): Measurement grid: dx=15mm, dy=15mm

Maximum value of SAR (measured) = 0.304 mW/g

Configuration/PCS1900 Mid Touch-Right/Zoom Scan (5x5x7)/Cube 0: Measurement grid: dx=8mm,

dy=8mm, dz=5mm, Reference Value = 6.149 V/m; Power Drift = -0.11 dB

Peak SAR (extrapolated) = 0.444 mW/g

SAR(1 g) = 0.284 mW/g; SAR(10 g) = 0.171 mW/g Maximum value of SAR (measured) = 0.299 mW/g

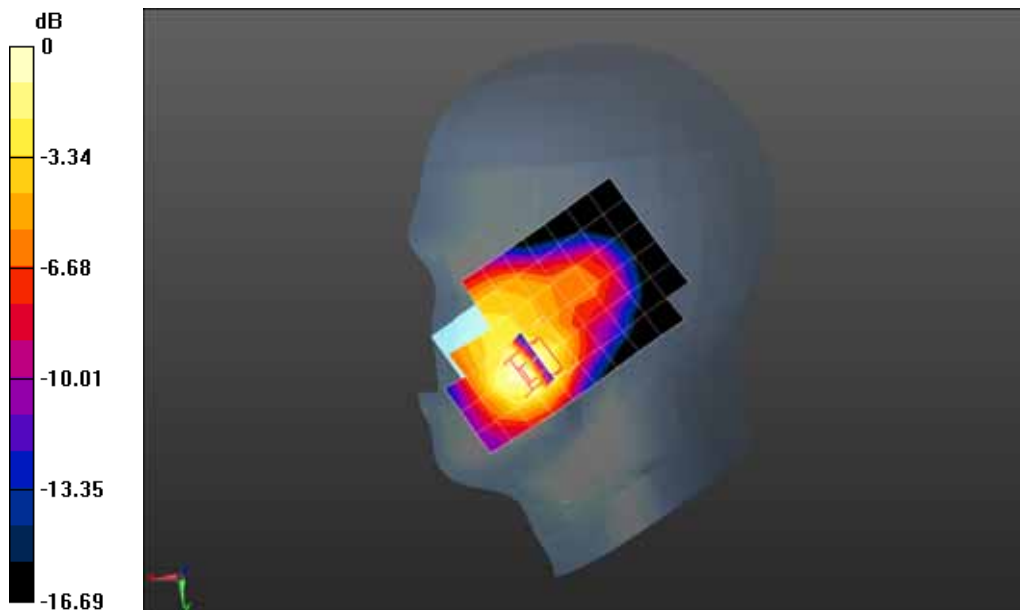

0 dB = 0.299 mW/g = -10.49 dB mW/g

Date/Time: 06-02-2013

Test Laboratory: QuieTek Lab

PCS1900 Mid Tilt-Right

DUT: Smartphone ; Type: W5510

Communication System: Generic GSM; Communication System Band: PCS1900; Duty Cycle: 1:8.3;

Frequency: 1880 MHz; Medium parameters used: $f = 1880$ MHz; $\sigma = 1.44$ mho/m; $\epsilon_r = 39.28$; $\rho = 1000$ kg/m³; Phantom section: Right Section

Ambient temperature (): 21.5, Liquid temperature (): 21.0

DASY5 Configuration:

- Probe: EX3DV4 - SN3710; ConvF(8.16, 8.16, 8.16); Calibrated: 12/03/2012;
- Sensor-Surface: 4mm (Mechanical Surface Detection)
- Electronics: DAE4 Sn915; Calibrated: 21/06/2012
- Phantom: SAM2; Type: SAM; Serial: TP1562
- Measurement SW: DASY52, Version 52.8 (1); SEMCAD X Version 14.6.5 (6469)

Configuration/PCS1900 Mid Tilt-Right/Area Scan (7x11x1): Measurement grid: dx=15mm, dy=15mm

Maximum value of SAR (measured) = 0.136 mW/g

Configuration/PCS1900 Mid Tilt-Right/Zoom Scan (5x5x7)/Cube 0: Measurement grid: dx=8mm, dy=8mm, dz=5mm, Reference Value = 8.744 V/m; Power Drift = -0.07 dB

Peak SAR (extrapolated) = 0.232 mW/g

SAR(1 g) = 0.136 mW/g; SAR(10 g) = 0.077 mW/g Maximum value of SAR (measured) = 0.149 mW/g

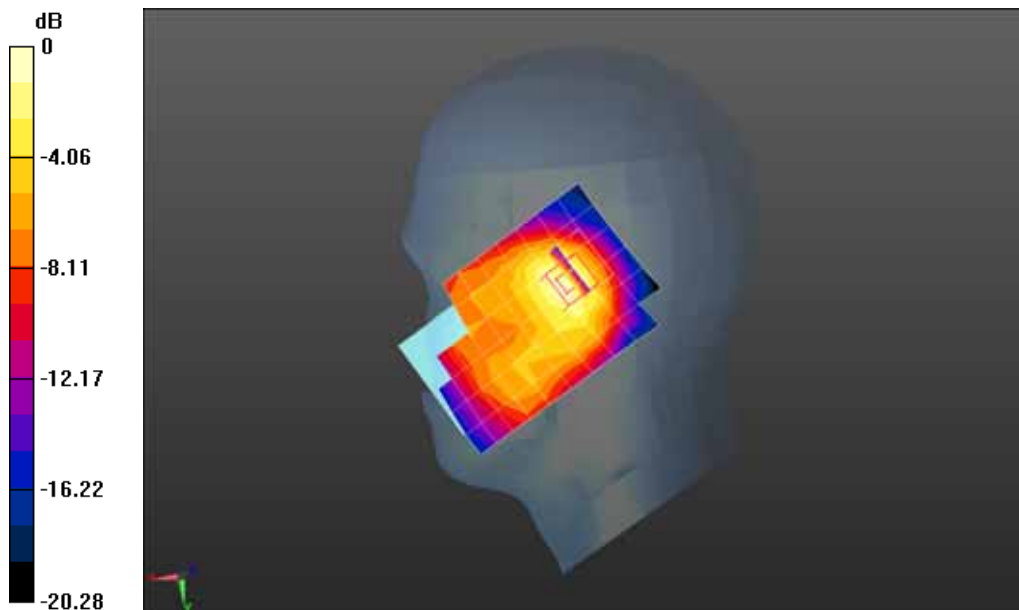

0 dB = 0.149 mW/g = -16.54 dB mW/g

Date/Time: 06-02-2013

Test Laboratory: QuieTek Lab

PCS1900 Mid Body-Back

DUT: Smartphone ; Type: W5510

Communication System: Generic GSM; Communication System Band: PCS1900; Duty Cycle: 1:8.3;

Frequency: 1880 MHz; Medium parameters used: $f = 1880$ MHz; $\sigma = 1.51$ mho/m; $\epsilon_r = 54.3$; $\rho = 1000$ kg/m³ ;

Phantom section: Flat Section

Ambient temperature (): 21.5, Liquid temperature (): 21.0

DASY5 Configuration:

- Probe: EX3DV4 - SN3710; ConvF(7.43, 7.43, 7.43); Calibrated: 12/03/2012;
- Sensor-Surface: 4mm (Mechanical Surface Detection)
- Electronics: DAE4 Sn915; Calibrated: 21/06/2012
- Phantom: SAM2; Type: SAM; Serial: TP1562
- Measurement SW: DASY52, Version 52.8 (1); SEMCAD X Version 14.6.5 (6469)

Configuration/PCS1900 Mid Body-Back/Area Scan (7x11x1): Measurement grid: dx=15mm, dy=15mm

Maximum value of SAR (measured) = 0.432 mW/g

Configuration/PCS1900 Mid Body-Back/Zoom Scan (5x5x7)/Cube 0: Measurement grid: dx=8mm, dy=8mm, dz=5mm, Reference Value = 8.002 V/m; Power Drift = 0.09 dB

Peak SAR (extrapolated) = 0.686 mW/g

SAR(1 g) = 0.409 mW/g; SAR(10 g) = 0.234 mW/g Maximum value of SAR (measured) = 0.459 mW/g

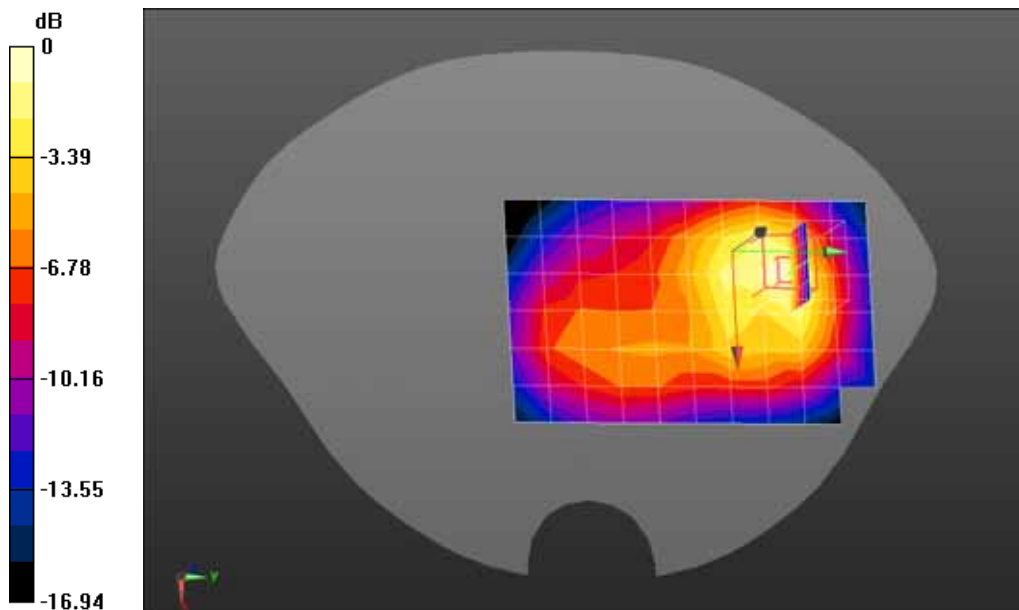

0 dB = 0.459 mW/g = -6.76 dB mW/g

Date/Time: 06-02-2013

Test Laboratory: QuieTek Lab

GPRS1900 Mid Body-Back(3up)

DUT: Smartphone ; Type: W5510

Communication System: GPRS/EGPRS-3 Slot; Communication System Band: PCS 1900; Duty Cycle:

1:2.8 ; Frequency: 1880 MHz; Medium parameters used: $f = 1880$ MHz; $\sigma = 1.51$ mho/m; $\epsilon_r = 54.3$; $\rho = 1000$ kg/m³ ; Phantom section: Flat Section

Ambient temperature (): 21.5, Liquid temperature (): 21.0

DASY5 Configuration:

- Probe: EX3DV4 - SN3710; ConvF(7.43, 7.43, 7.43); Calibrated: 12/03/2012;
- Sensor-Surface: 4mm (Mechanical Surface Detection)
- Electronics: DAE4 Sn915; Calibrated: 21/06/2012
- Phantom: SAM2; Type: SAM; Serial: TP1562
- Measurement SW: DASY52, Version 52.8 (1); SEMCAD X Version 14.6.5 (6469)

Configuration/GPRS1900 Mid Body-Back/Area Scan (7x11x1): Measurement grid: dx=15mm, dy=15mm

Maximum value of SAR (measured) = 0.594 mW/g

Configuration/GPRS1900 Mid Body-Back/Zoom Scan (5x5x7)/Cube 0: Measurement grid: dx=8mm, dy=8mm, dz=5mm, Reference Value = 9.723 V/m; Power Drift = -0.17 dB

Peak SAR (extrapolated) = 0.942 mW/g

SAR(1 g) = 0.562 mW/g; SAR(10 g) = 0.321 mW/g Maximum value of SAR (measured) = 0.626 mW/g

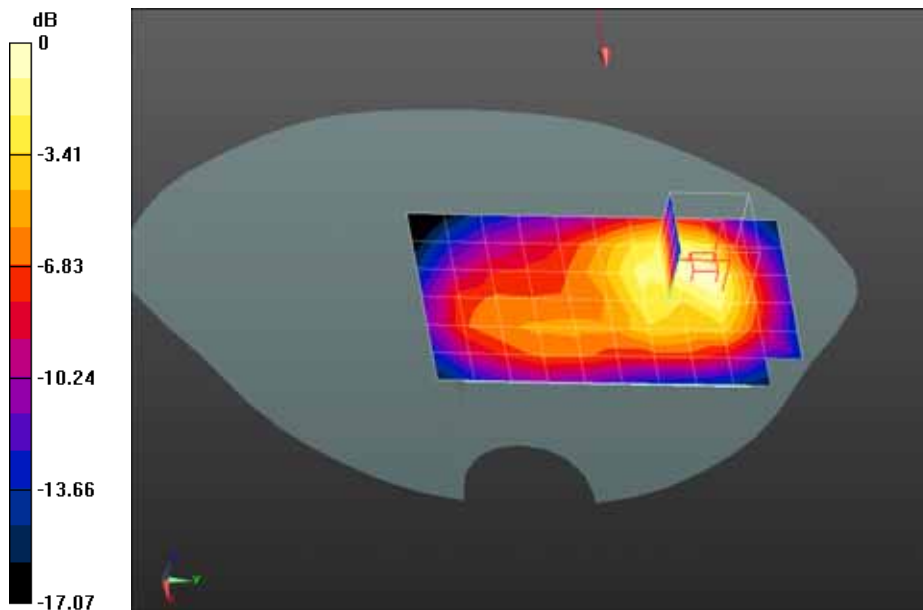

0 dB = 0.626 mW/g = -4.07 dB mW/g

Z-Axis Plot

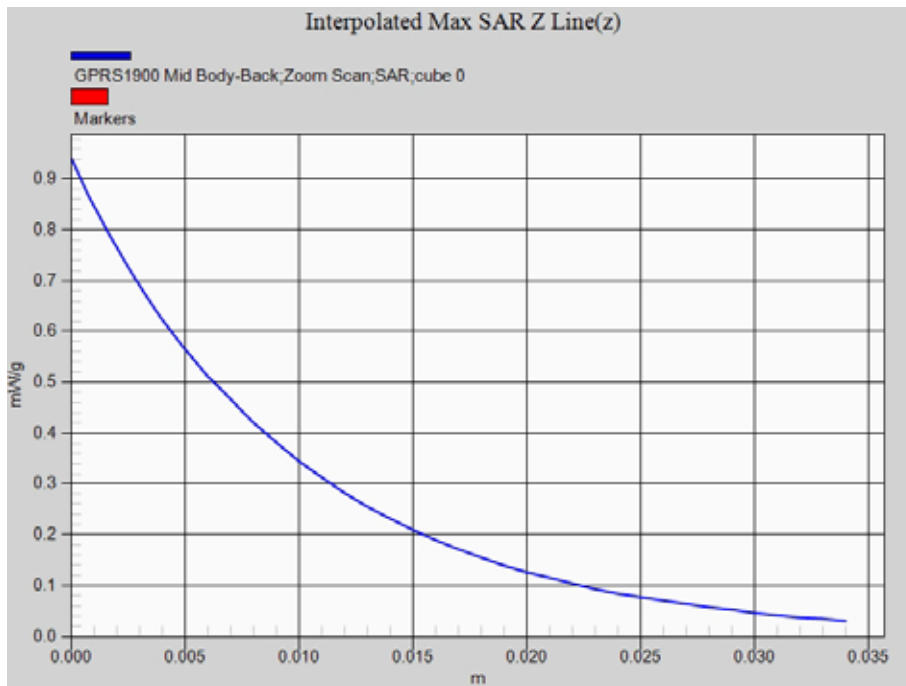

Date/Time: 06-02-2013

Test Laboratory: QuieTek Lab

GPRS1900 Mid Body-Front(3up)

DUT: Smartphone ; Type: W5510

Communication System: GPRS/EGPRS-3 Slot; Communication System Band: PCS 1900; Duty Cycle:

1:2.8 ; Frequency: 1880 MHz; Medium parameters used: $f = 1880 \text{ MHz}$; $\sigma = 1.51 \text{ mho/m}$; $\epsilon_r = 54.3$; $\rho = 1000 \text{ kg/m}^3$; Phantom section: Flat Section

Ambient temperature (): 21.5, Liquid temperature (): 21.0

DASY5 Configuration:

- Probe: EX3DV4 - SN3710; ConvF(7.43, 7.43, 7.43); Calibrated: 12/03/2012;
- Sensor-Surface: 4mm (Mechanical Surface Detection)
- Electronics: DAE4 Sn915; Calibrated: 21/06/2012
- Phantom: SAM2; Type: SAM; Serial: TP1562
- Measurement SW: DASY52, Version 52.8 (1); SEMCAD X Version 14.6.5 (6469)

Configuration/GPRS1900 Mid Body-Front/Area Scan (7x11x1): Measurement grid: dx=15mm, dy=15mm

Maximum value of SAR (measured) = 0.455 mW/g

Configuration/GPRS1900 Mid Body-Front/Zoom Scan (5x5x7)/Cube 0: Measurement grid: dx=8mm, dy=8mm, dz=5mm, Reference Value = 10.344 V/m; Power Drift = -0.04 dB

Peak SAR (extrapolated) = 0.738 mW/g

SAR(1 g) = 0.428 mW/g; SAR(10 g) = 0.259 mW/g Maximum value of SAR (measured) = 0.475 mW/g

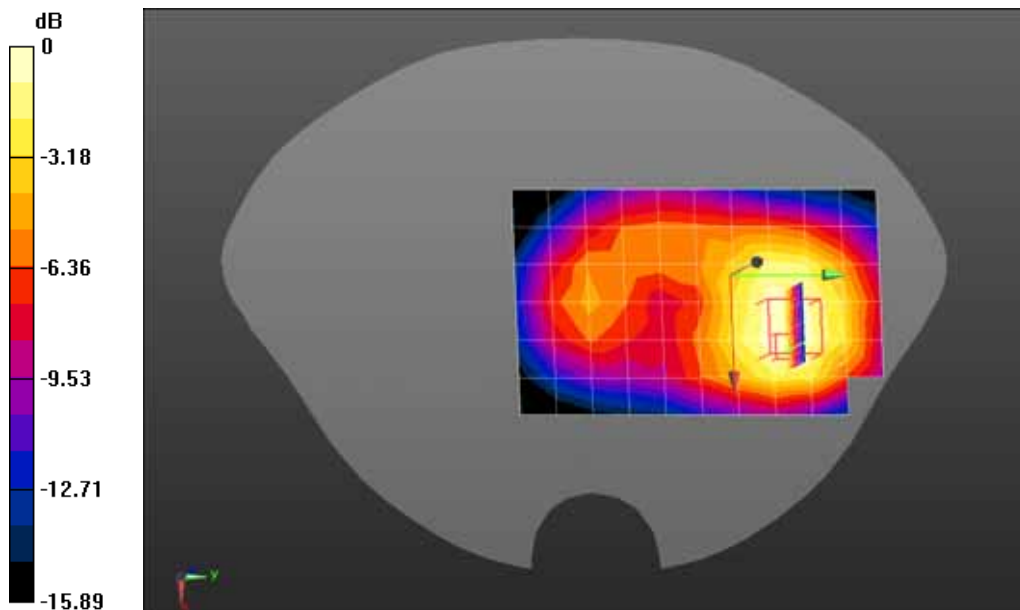

0 dB = 0.475 mW/g = -6.47 dB mW/g

Date/Time: 06-02-2013

Test Laboratory: QuieTek Lab

GPRS1900 Mid Body-Bottom(3up)

DUT: Smartphone ; Type: W5510

Communication System: GPRS/EGPRS-3 Slot; Communication System Band: PCS 1900; Duty Cycle:

1:2.8 ; Frequency: 1880 MHz; Medium parameters used: $f = 1880$ MHz; $\sigma = 1.51$ mho/m; $\epsilon_r = 54.3$; $\rho = 1000$ kg/m³ ; Phantom section: Flat Section

Ambient temperature (): 21.5, Liquid temperature (): 21.0

DASY5 Configuration:

- Probe: EX3DV4 - SN3710; ConvF(7.43, 7.43, 7.43); Calibrated: 12/03/2012;
- Sensor-Surface: 4mm (Mechanical Surface Detection)
- Electronics: DAE4 Sn915; Calibrated: 21/06/2012
- Phantom: SAM2; Type: SAM; Serial: TP1562
- Measurement SW: DASY52, Version 52.8 (1); SEMCAD X Version 14.6.5 (6469)

Configuration/GPRS1900 Mid Body-Bottom/Area Scan (6x7x1): Measurement grid: dx=15mm, dy=15mm, Maximum value of SAR (measured) = 0.405 mW/g

Configuration/GPRS1900 Mid Body-Bottom/Zoom Scan (5x5x7)/Cube 0: Measurement grid: dx=8mm, dy=8mm, dz=5mm, Reference Value = 17.288 V/m; Power Drift = -0.10 dB

Peak SAR (extrapolated) = 0.689 mW/g

SAR(1 g) = 0.421 mW/g; SAR(10 g) = 0.246 mW/g Maximum value of SAR (measured) = 0.460 mW/g

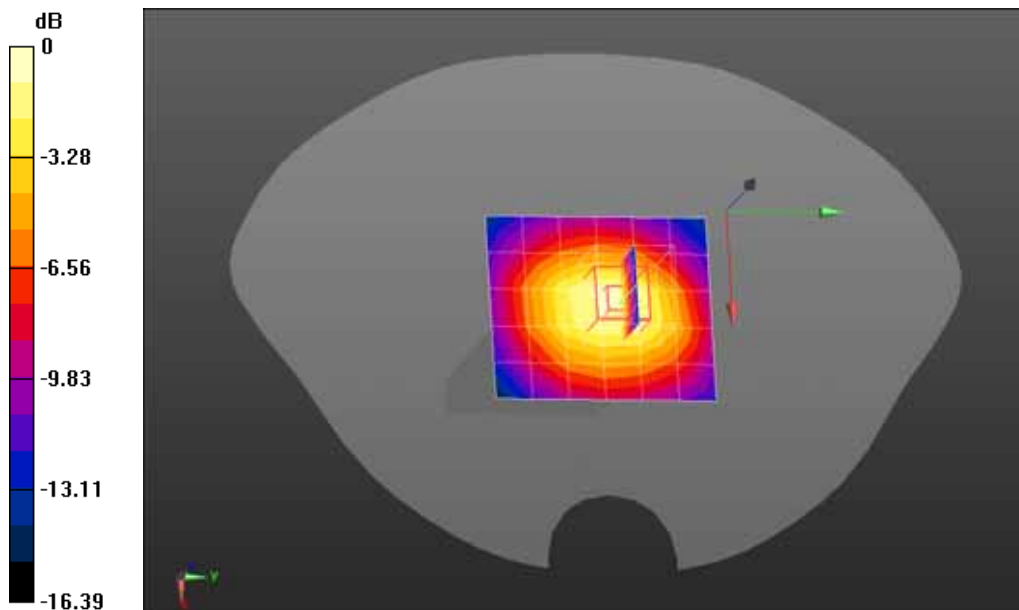

0 dB = 0.460 mW/g = -6.74 dB mW/g

Date/Time: 06-02-2013

Test Laboratory: QuieTek Lab

GPRS1900 Mid Body-Left side(3up)

DUT: Smartphone ; Type: W5510

Communication System: GPRS/EGPRS-3 Slot; Communication System Band: PCS 1900; Duty Cycle:

1:2.8 ; Frequency: 1880 MHz; Medium parameters used: $f = 1880 \text{ MHz}$; $\sigma = 1.51 \text{ mho/m}$; $\epsilon_r = 54.3$; $\rho = 1000 \text{ kg/m}^3$; Phantom section: Flat Section

Ambient temperature (): 21.5, Liquid temperature (): 21.0

DASY5 Configuration:

- Probe: EX3DV4 - SN3710; ConvF(7.43, 7.43, 7.43); Calibrated: 12/03/2012;
- Sensor-Surface: 4mm (Mechanical Surface Detection)
- Electronics: DAE4 Sn915; Calibrated: 21/06/2012
- Phantom: SAM2; Type: SAM; Serial: TP1562
- Measurement SW: DASY52, Version 52.8 (1); SEMCAD X Version 14.6.5 (6469)

Configuration/GPRS1900 Mid Body-Left side/Area Scan (5x11x1): Measurement grid: dx=15mm, dy=15mm, Maximum value of SAR (measured) = 0.222 mW/g

Configuration/GPRS1900 Mid Body-Left side/Zoom Scan (5x5x7)/Cube 0: Measurement grid: dx=8mm, dy=8mm, dz=5mm, Reference Value = 8.161 V/m; Power Drift = -0.04 dB

Peak SAR (extrapolated) = 0.355 mW/g

SAR(1 g) = 0.211 mW/g; SAR(10 g) = 0.121 mW/g Maximum value of SAR (measured) = 0.233 mW/g

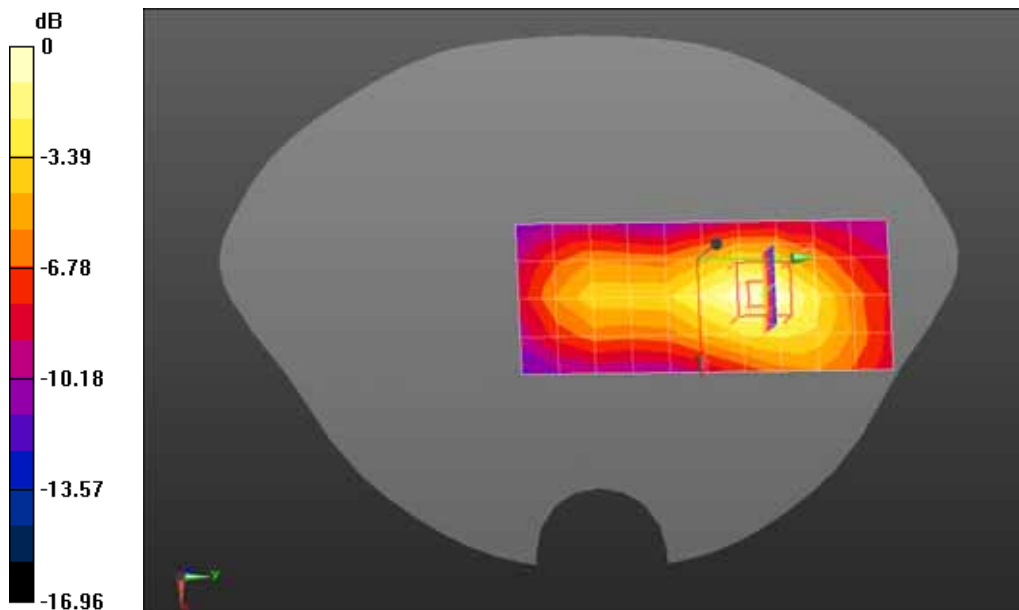

0 dB = 0.233 mW/g = -12.65 dB mW/g

Date/Time: 06-02-2013

Test Laboratory: QuieTek Lab

GPRS1900 Mid Body-Right side(3up)

DUT: Smartphone ; Type: W5510

Communication System: GPRS/EGPRS-3 Slot; Communication System Band: PCS 1900; Duty Cycle:

1:2.8 ; Frequency: 1880 MHz; Medium parameters used: $f = 1880$ MHz; $\sigma = 1.51$ mho/m; $\epsilon_r = 54.3$; $\rho = 1000$ kg/m³ ; Phantom section: Flat Section

Ambient temperature (): 21.5, Liquid temperature (): 21.0

DASY5 Configuration:

- Probe: EX3DV4 - SN3710; ConvF(7.43, 7.43, 7.43); Calibrated: 12/03/2012;
- Sensor-Surface: 4mm (Mechanical Surface Detection)
- Electronics: DAE4 Sn915; Calibrated: 21/06/2012
- Phantom: SAM2; Type: SAM; Serial: TP1562
- Measurement SW: DASY52, Version 52.8 (1); SEMCAD X Version 14.6.5 (6469)

Configuration/GPRS1900 Mid Body-Left side/Area Scan (5x11x1): Measurement grid: dx=15mm, dy=15mm, Maximum value of SAR (measured) = 0.127 mW/g

Configuration/GPRS1900 Mid Body-Left side/Zoom Scan (5x5x7)/Cube 0: Measurement grid: dx=8mm, dy=8mm, dz=5mm, Reference Value = 7.083 V/m; Power Drift = -0.10 dB

Peak SAR (extrapolated) = 0.208 mW/g

SAR(1 g) = 0.130 mW/g; SAR(10 g) = 0.078 mW/g Maximum value of SAR (measured) = 0.141 mW/g

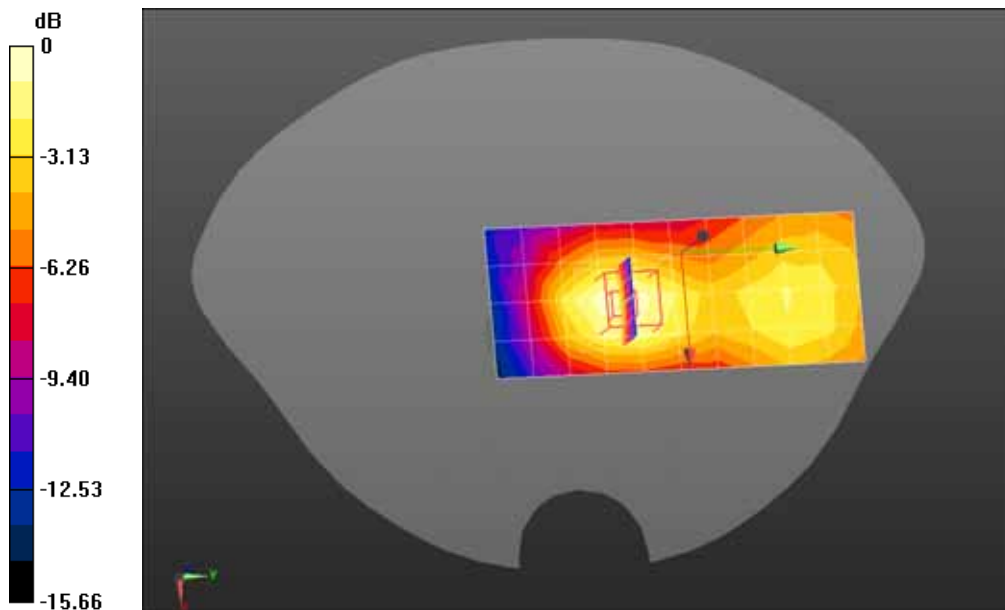

0 dB = 0.141 mW/g = -17.02 dB mW/g

Date/Time: 06-02-2013

Test Laboratory: QuieTek Lab

WCDMA Band II Mid Touch-Left

DUT: Smartphone ; Type: W5510

Communication System: UMTS; Communication System Band: Band II UTRA/FDD; Duty Cycle: 1:1; Frequency: 1880 MHz; Medium parameters used: $f = 1880$ MHz; $\sigma = 1.44$ mho/m; $\epsilon_r = 39.28$; $\rho = 1000$ kg/m³; Phantom section: Left Section

Ambient temperature (): 21.5, Liquid temperature (): 21.0

DASY5 Configuration:

- Probe: EX3DV4 - SN3710; ConvF(8.16, 8.16, 8.16); Calibrated: 12/03/2012;
- Sensor-Surface: 4mm (Mechanical Surface Detection)
- Electronics: DAE4 Sn915; Calibrated: 21/06/2012
- Phantom: SAM2; Type: SAM; Serial: TP1562
- Measurement SW: DASY52, Version 52.8 (1); SEMCAD X Version 14.6.5 (6469)

Configuration/WCDMA Band II Mid Touch-Left/Area Scan (7x11x1): Measurement grid: dx=15mm, dy=15mm, Maximum value of SAR (measured) = 0.665 mW/g

Configuration/WCDMA Band II Mid Touch-Left/Zoom Scan (5x5x7)/Cube 0: Measurement grid: dx=8mm, dy=8mm, dz=5mm, Reference Value = 8.926 V/m; Power Drift = 0.08 dB
Peak SAR (extrapolated) = 1.280 mW/g

SAR(1 g) = 0.748 mW/g; SAR(10 g) = 0.416 mW/g Maximum value of SAR (measured) = 0.818 mW/g

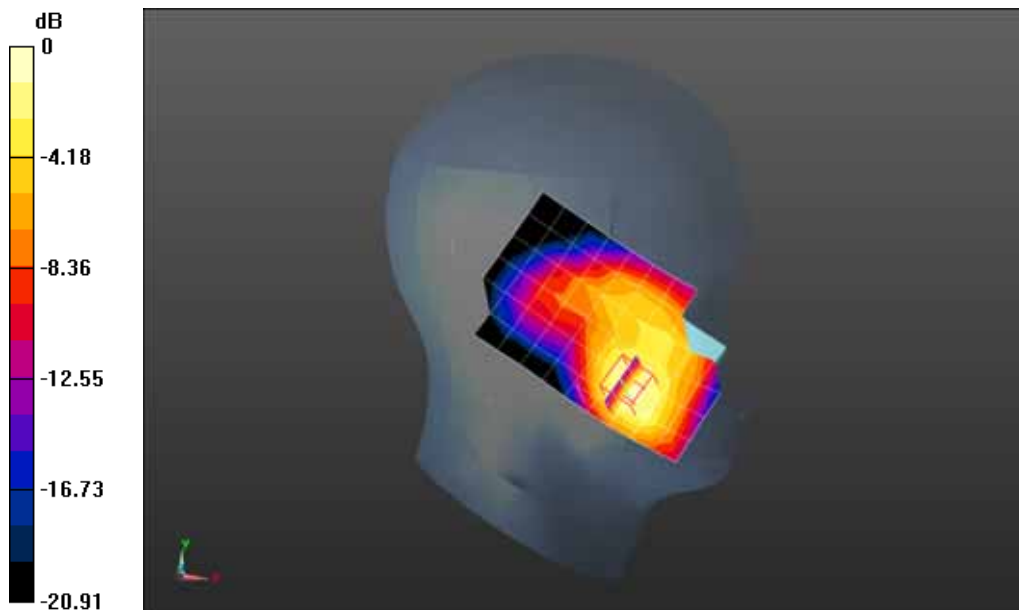

0 dB = 0.818 mW/g = -1.74 dB mW/g

Date/Time: 06-02-2013

Test Laboratory: QuieTek Lab

WCDMA Band II Mid Tilt-Left

DUT: Smartphone ; Type: W5510

Communication System: UMTS; Communication System Band: Band II UTRA/FDD; Duty Cycle: 1:1; Frequency: 1880 MHz; Medium parameters used: $f = 1880$ MHz; $\sigma = 1.44$ mho/m; $\epsilon_r = 39.28$; $\rho = 1000$ kg/m³; Phantom section: Left Section

Ambient temperature (): 21.5, Liquid temperature (): 21.0

DASY5 Configuration:

- Probe: EX3DV4 - SN3710; ConvF(8.16, 8.16, 8.16); Calibrated: 12/03/2012;
- Sensor-Surface: 4mm (Mechanical Surface Detection)
- Electronics: DAE4 Sn915; Calibrated: 21/06/2012
- Phantom: SAM2; Type: SAM; Serial: TP1562
- Measurement SW: DASY52, Version 52.8 (1); SEMCAD X Version 14.6.5 (6469)

Configuration/WCDMA Band II Mid Tilt-Left/Area Scan (7x11x1): Measurement grid: dx=15mm, dy=15mm, Maximum value of SAR (measured) = 0.204 mW/g

Configuration/WCDMA Band II Mid Tilt-Left/Zoom Scan (5x5x7)/Cube 0: Measurement grid: dx=8mm, dy=8mm, dz=5mm, Reference Value = 11.080 V/m; Power Drift = -0.07 dB

Peak SAR (extrapolated) = 0.335 mW/g

SAR(1 g) = 0.202 mW/g; SAR(10 g) = 0.118 mW/g Maximum value of SAR (measured) = 0.210 mW/g

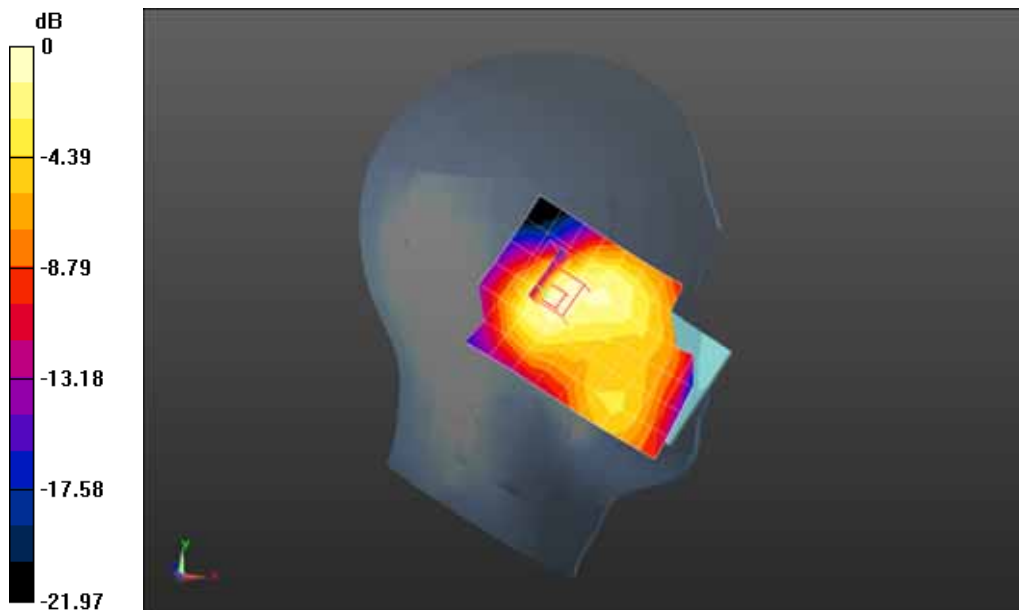

0 dB = 0.210 mW/g = -13.56 dB mW/g

Date/Time: 06-02-2013

Test Laboratory: QuieTek Lab

WCDMA Band II Mid Touch-Right

DUT: Smartphone ; Type: W5510

Communication System: UMTS; Communication System Band: Band II UTRA/FDD; Duty Cycle: 1:1; Frequency: 1880 MHz; Medium parameters used: $f = 1880$ MHz; $\sigma = 1.44$ mho/m; $\epsilon_r = 39.28$; $\rho = 1000$ kg/m³; Phantom section: Right Section

Ambient temperature (): 21.5, Liquid temperature (): 21.0

DASY5 Configuration:

- Probe: EX3DV4 - SN3710; ConvF(8.16, 8.16, 8.16); Calibrated: 12/03/2012;
- Sensor-Surface: 4mm (Mechanical Surface Detection)
- Electronics: DAE4 Sn915; Calibrated: 21/06/2012
- Phantom: SAM2; Type: SAM; Serial: TP1562
- Measurement SW: DASY52, Version 52.8 (1); SEMCAD X Version 14.6.5 (6469)

Configuration/WCDMA Band II Mid Touch-Right/Area Scan (7x11x1): Measurement grid: dx=15mm, dy=15mm, Maximum value of SAR (measured) = 0.640 mW/g

Configuration/WCDMA Band II Mid Touch-Right/Zoom Scan (5x5x7)/Cube 0: Measurement grid: dx=8mm, dy=8mm, dz=5mm, Reference Value = 8.076 V/m; Power Drift = -0.04 dB
Peak SAR (extrapolated) = 0.967 mW/g

SAR(1 g) = 0.600 mW/g; SAR(10 g) = 0.352 mW/g Maximum value of SAR (measured) = 0.644 mW/g

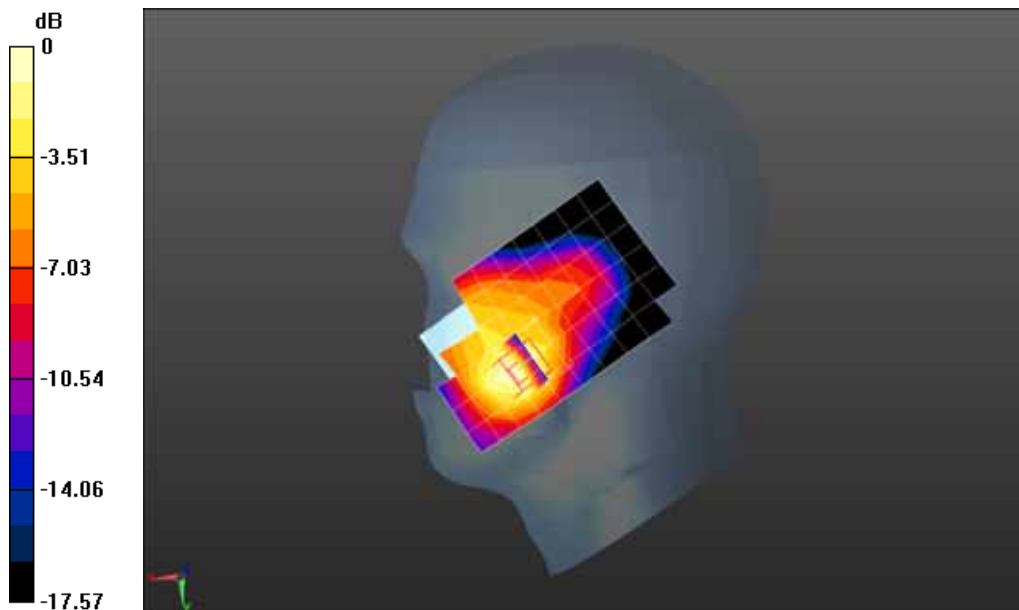

0 dB = 0.644 mW/g = -3.82 dB mW/g

Date/Time: 06-02-2013

Test Laboratory: QuieTek Lab

WCDMA Band II Mid Tilt-Right

DUT: Smartphone ; Type: W5510

Communication System: UMTS; Communication System Band: Band II UTRA/FDD; Duty Cycle: 1:1; Frequency: 1880 MHz; Medium parameters used: $f = 1880$ MHz; $\sigma = 1.44$ mho/m; $\epsilon_r = 39.28$; $\rho = 1000$ kg/m³; Phantom section: Right Section

Ambient temperature (): 21.5, Liquid temperature (): 21.0

DASY5 Configuration:

- Probe: EX3DV4 - SN3710; ConvF(8.16, 8.16, 8.16); Calibrated: 12/03/2012;
- Sensor-Surface: 4mm (Mechanical Surface Detection)
- Electronics: DAE4 Sn915; Calibrated: 21/06/2012
- Phantom: SAM2; Type: SAM; Serial: TP1562
- Measurement SW: DASY52, Version 52.8 (1); SEMCAD X Version 14.6.5 (6469)

Configuration/WCDMA Band II Mid Tilt-Right/Area Scan (7x11x1): Measurement grid: dx=15mm, dy=15mm, Maximum value of SAR (measured) = 0.214 mW/g

Configuration/WCDMA Band II Mid Tilt-Right/Zoom Scan (5x5x7)/Cube 0: Measurement grid: dx=8mm, dy=8mm, dz=5mm, Reference Value = 11.617 V/m; Power Drift = 0.09 dB

Peak SAR (extrapolated) = 0.390 mW/g

SAR(1 g) = 0.233 mW/g; SAR(10 g) = 0.134 mW/g Maximum value of SAR (measured) = 0.251 mW/g

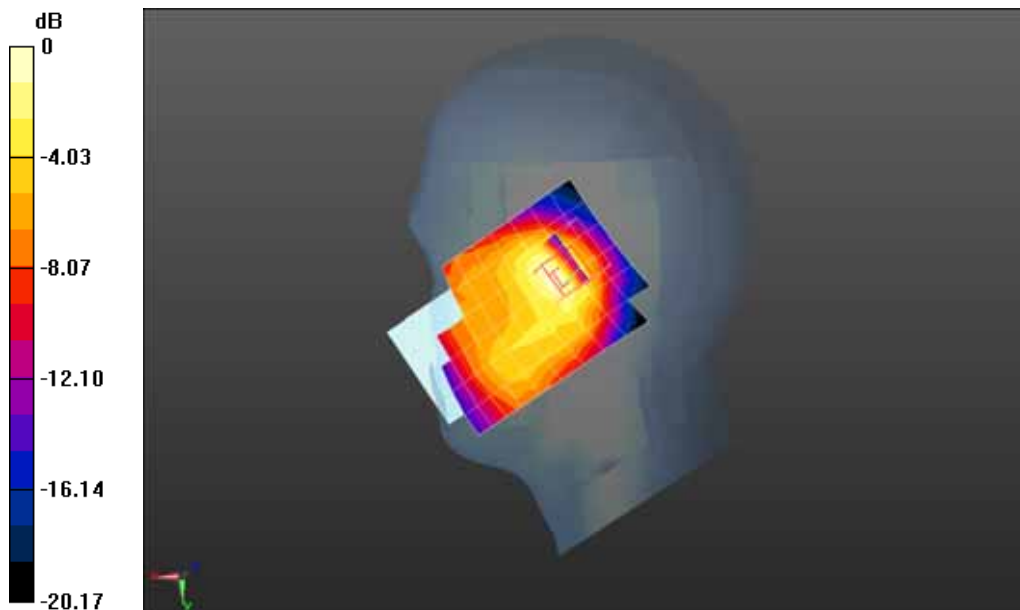

0 dB = 0.251 mW/g = -12.01 dB mW/g

Date/Time: 06-02-2013

Test Laboratory: QuieTek Lab

WCDMA Band II Low Body-Back

DUT: Smartphone ; Type: W5510

Communication System: UMTS; Communication System Band: Band II UTRA/FDD; Duty Cycle: 1:1;

Frequency: 1852.4 MHz; Medium parameters used: $f = 1852.4$ MHz; $\sigma = 1.45$ mho/m; $\epsilon_r = 54.7$; $\rho = 1000$ kg/m³; Phantom section: Flat Section

Ambient temperature (): 21.5, Liquid temperature (): 21.0

DASY5 Configuration:

- Probe: EX3DV4 - SN3710; ConvF(7.43, 7.43, 7.43); Calibrated: 12/03/2012;
- Sensor-Surface: 4mm (Mechanical Surface Detection)
- Electronics: DAE4 Sn915; Calibrated: 21/06/2012
- Phantom: SAM2; Type: SAM; Serial: TP1562
- Measurement SW: DASY52, Version 52.8 (1); SEMCAD X Version 14.6.5 (6469)

Configuration/WCDMA Band II Low Body-Back/Area Scan (7x11x1): Measurement grid: dx=15mm, dy=15mm, Maximum value of SAR (measured) = 0.888 mW/g

Configuration/WCDMA Band II Low Body-Back/Zoom Scan (5x5x7)/Cube 0: Measurement grid: dx=8mm, dy=8mm, dz=5mm, Reference Value = 12.156 V/m; Power Drift = 0.00 dB
Peak SAR (extrapolated) = 1.326 mW/g

SAR(1 g) = 0.812 mW/g; SAR(10 g) = 0.479 mW/g Maximum value of SAR (measured) = 0.854 mW/g

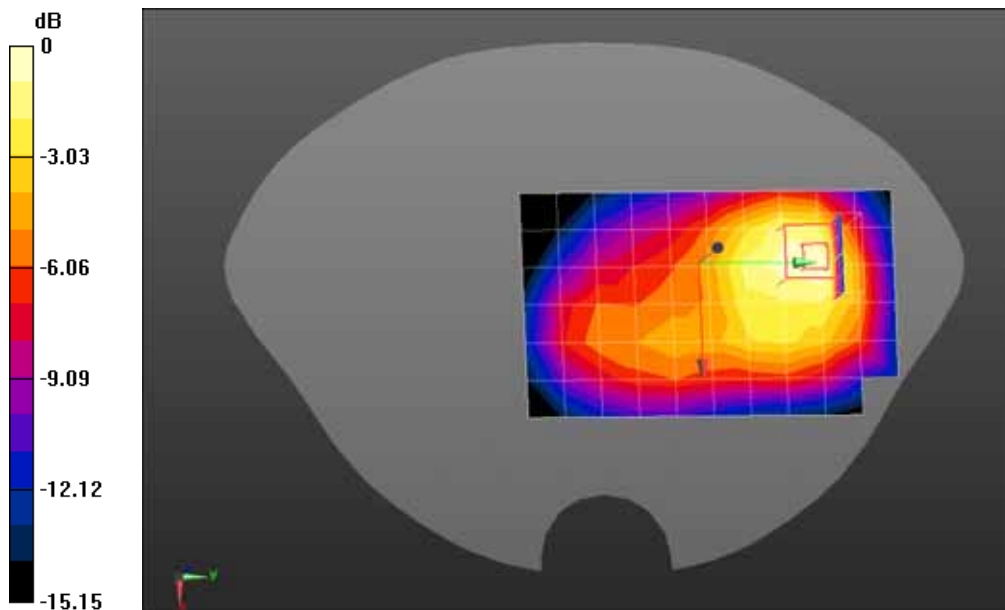

0 dB = 0.854 mW/g = -1.37 dB mW/g

Date/Time: 06-02-2013

Test Laboratory: QuieTek Lab

WCDMA Band II Mid Body-Back

DUT: Smartphone ; Type: W5510

Communication System: UMTS; Communication System Band: Band II UTRA/FDD; Duty Cycle: 1:1;

Frequency: 1880 MHz; Medium parameters used: $f = 1880$ MHz; $\sigma = 1.51$ mho/m; $\epsilon_r = 54.3$; $\rho = 1000$ kg/m³ ;

Phantom section: Flat Section

Ambient temperature (): 21.5, Liquid temperature (): 21.0

DASY5 Configuration:

- Probe: EX3DV4 - SN3710; ConvF(7.43, 7.43, 7.43); Calibrated: 12/03/2012;
- Sensor-Surface: 4mm (Mechanical Surface Detection)
- Electronics: DAE4 Sn915; Calibrated: 21/06/2012
- Phantom: SAM2; Type: SAM; Serial: TP1562
- Measurement SW: DASY52, Version 52.8 (1); SEMCAD X Version 14.6.5 (6469)

Configuration/WCDMA Band II Mid Body-Back/Area Scan (7x11x1): Measurement grid: dx=15mm, dy=15mm, Maximum value of SAR (measured) = 0.913 mW/g

Configuration/WCDMA Band II Mid Body-Back/Zoom Scan (5x5x7)/Cube 0: Measurement grid: dx=8mm, dy=8mm, dz=5mm, Reference Value = 11.895 V/m; Power Drift = -0.02 dB
Peak SAR (extrapolated) = 1.384 mW/g

SAR(1 g) = 0.832 mW/g; SAR(10 g) = 0.476 mW/g Maximum value of SAR (measured) = 0.909 mW/g

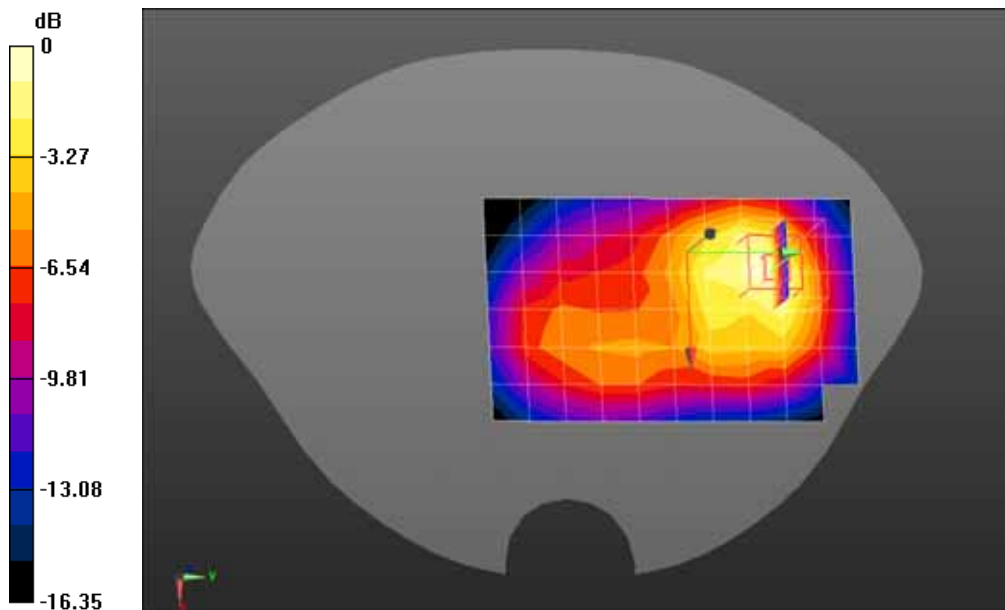

0 dB = 0.909 mW/g = -0.83 dB mW/g

Date/Time: 06-02-2013

Test Laboratory: QuieTek Lab

WCDMA Band II High Body-Back

DUT: Smartphone ; Type: W5510

Communication System: UMTS; Communication System Band: Band II UTRA/FDD; Duty Cycle: 1:1;

Frequency: 1907.6 MHz; Medium parameters used: $f = 1907.6$ MHz; $\sigma = 1.54$ mho/m; $\epsilon_r = 54.2$; $\rho = 1000$ kg/m³ ; Phantom section: Flat Section

Ambient temperature (): 21.5, Liquid temperature (): 21.0

DASY5 Configuration:

- Probe: EX3DV4 - SN3710; ConvF(7.43, 7.43, 7.43); Calibrated: 12/03/2012;
- Sensor-Surface: 4mm (Mechanical Surface Detection)
- Electronics: DAE4 Sn915; Calibrated: 21/06/2012
- Phantom: SAM2; Type: SAM; Serial: TP1562
- Measurement SW: DASY52, Version 52.8 (1); SEMCAD X Version 14.6.5 (6469)

Configuration/WCDMA Band II High Body-Back/Area Scan (7x11x1): Measurement grid: dx=15mm, dy=15mm, Maximum value of SAR (measured) = 0.968 mW/g

Configuration/WCDMA Band II High Body-Back/Zoom Scan (5x5x7)/Cube 0: Measurement grid: dx=8mm, dy=8mm, dz=5mm, Reference Value = 11.978 V/m; Power Drift = 0.06 dB
Peak SAR (extrapolated) = 1.505 mW/g

SAR(1 g) = 0.896 mW/g; SAR(10 g) = 0.514 mW/g Maximum value of SAR (measured) = 0.972 mW/g

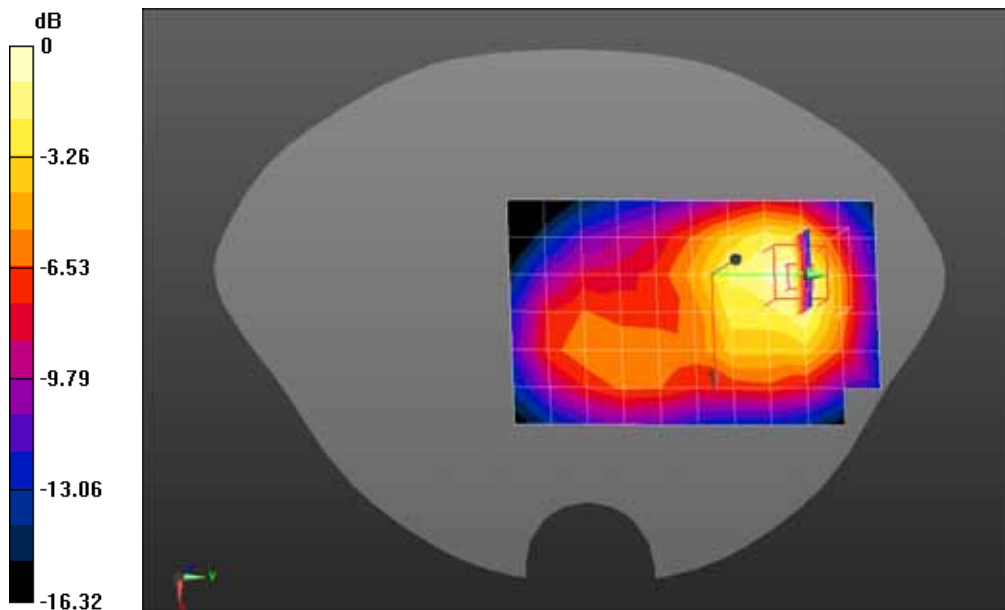

0 dB = 0.972 mW/g = -0.25 dB mW/g

Z-Axis Plot

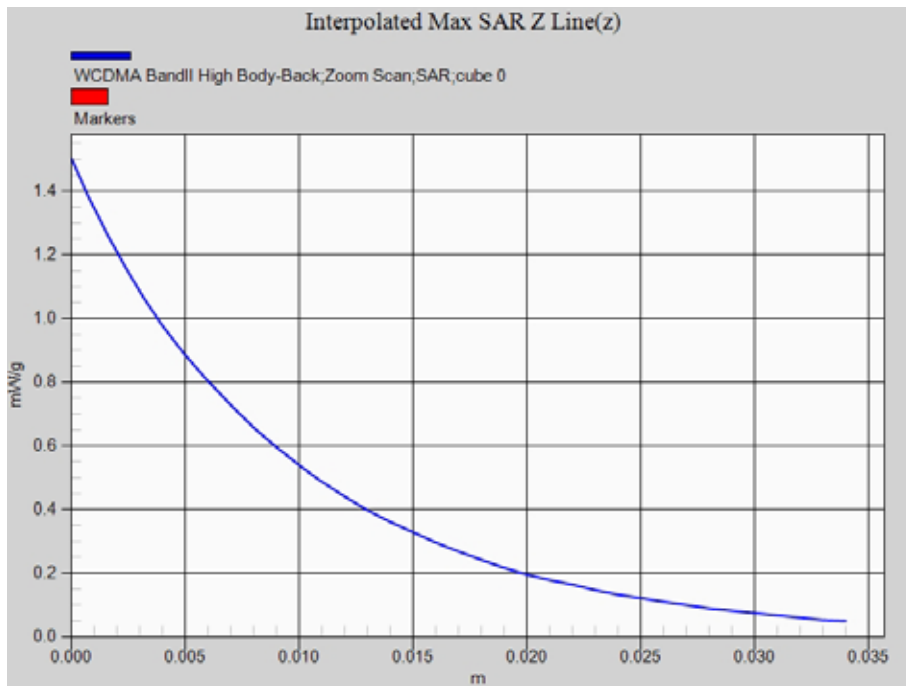

Date/Time: 06-02-2013

Test Laboratory: QuieTek Lab

WCDMA Band II High Body-Back-1

DUT: Smartphone ; Type: W5510

Communication System: UMTS; Communication System Band: Band II UTRA/FDD; Duty Cycle: 1:1;

Frequency: 1907.6 MHz; Medium parameters used: $f = 1907.6$ MHz; $\sigma = 1.54$ mho/m; $\epsilon_r = 54.2$; $\rho = 1000$ kg/m³ ; Phantom section: Flat Section

Ambient temperature (): 21.5, Liquid temperature (): 21.0

DASY5 Configuration:

- Probe: EX3DV4 - SN3710; ConvF(7.43, 7.43, 7.43); Calibrated: 12/03/2012;
- Sensor-Surface: 4mm (Mechanical Surface Detection)
- Electronics: DAE4 Sn915; Calibrated: 21/06/2012
- Phantom: SAM2; Type: SAM; Serial: TP1562
- Measurement SW: DASY52, Version 52.8 (1); SEMCAD X Version 14.6.5 (6469)

Configuration/WCDMA Band II High Body-Back/Area Scan (7x11x1): Measurement grid: dx=15mm, dy=15mm, Maximum value of SAR (measured) = 0.966 mW/g

Configuration/WCDMA Band II High Body-Back/Zoom Scan (5x5x7)/Cube 0: Measurement grid: dx=8mm, dy=8mm, dz=5mm, Reference Value = 11.664 V/m; Power Drift = 0.17 dB
Peak SAR (extrapolated) = 1.463 mW/g

SAR(1 g) = 0.877 mW/g; SAR(10 g) = 0.503 mW/g Maximum value of SAR (measured) = 0.955 mW/g

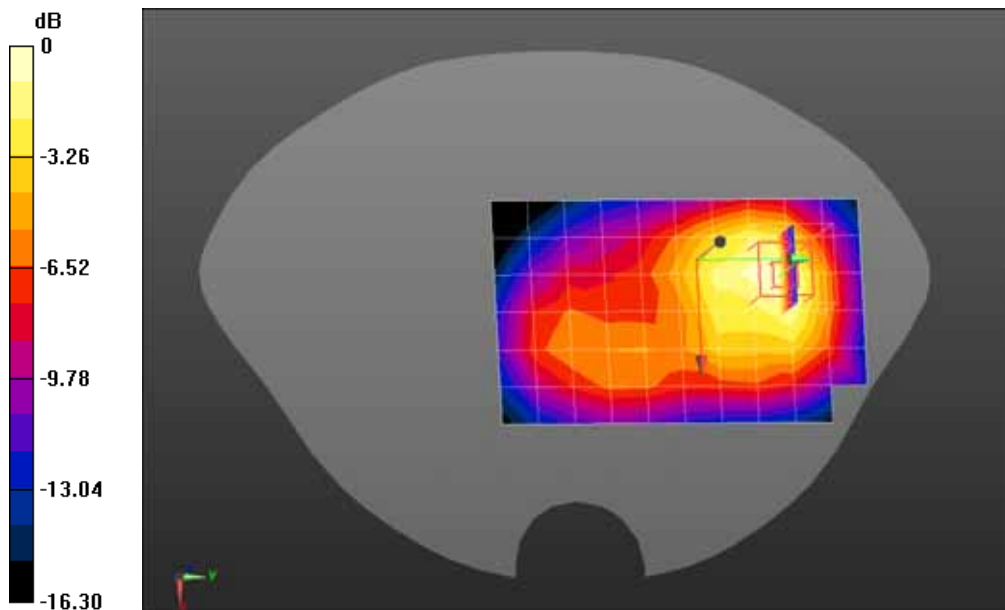

0 dB = 0.955 mW/g = -0.40 dB mW/g

Date/Time: 06-02-2013

Test Laboratory: QuieTek Lab

WCDMA Band II Mid Body-Front

DUT: Smartphone ; Type: W5510

Communication System: UMTS; Communication System Band: Band II UTRA/FDD; Duty Cycle: 1:1;

Frequency: 1880 MHz; Medium parameters used: $f = 1880$ MHz; $\sigma = 1.51$ mho/m; $\epsilon_r = 54.3$; $\rho = 1000$ kg/m³ ;

Phantom section: Flat Section

Ambient temperature (): 21.5, Liquid temperature (): 21.0

DASY5 Configuration:

- Probe: EX3DV4 - SN3710; ConvF(7.43, 7.43, 7.43); Calibrated: 12/03/2012;
- Sensor-Surface: 4mm (Mechanical Surface Detection)
- Electronics: DAE4 Sn915; Calibrated: 21/06/2012
- Phantom: SAM2; Type: SAM; Serial: TP1562
- Measurement SW: DASY52, Version 52.8 (1); SEMCAD X Version 14.6.5 (6469)

Configuration/WCDMA Band II Mid Body-Front/Area Scan (7x11x1): Measurement grid: dx=15mm, dy=15mm, Maximum value of SAR (measured) = 0.679 mW/g

Configuration/WCDMA Band II Mid Body-Front/Zoom Scan (5x5x7)/Cube 0: Measurement grid: dx=8mm, dy=8mm, dz=5mm, Reference Value = 11.310 V/m; Power Drift = 0.05 dB
Peak SAR (extrapolated) = 1.102 mW/g

SAR(1 g) = 0.642 mW/g; SAR(10 g) = 0.387 mW/g Maximum value of SAR (measured) = 0.703 mW/g

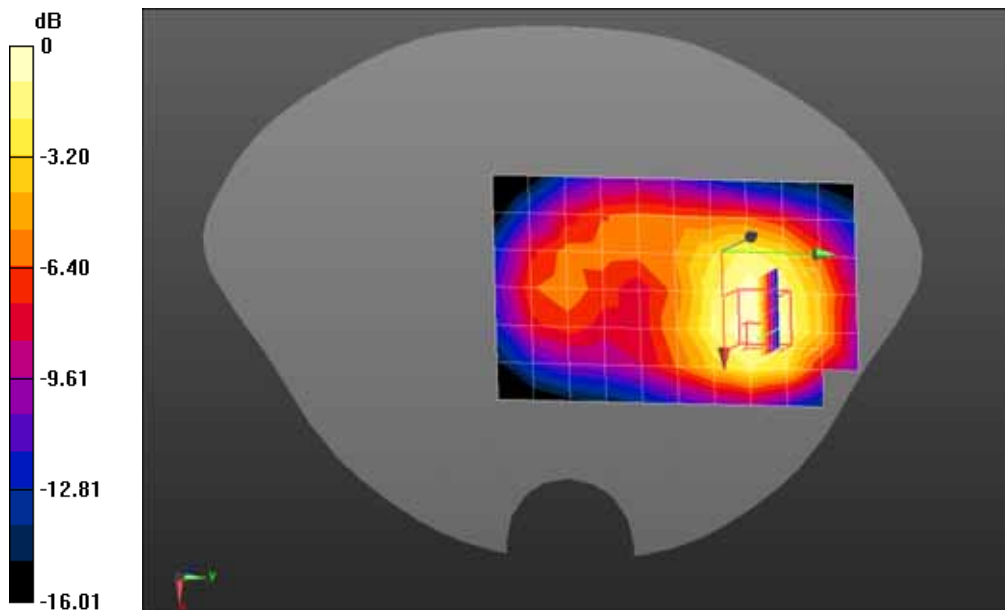

0 dB = 0.703 mW/g = -3.06 dB mW/g

Date/Time: 06-02-2013

Test Laboratory: QuieTek Lab

WCDMA Band II Mid Body-Bottom

DUT: Smartphone ; Type: W5510

Communication System: UMTS; Communication System Band: Band II UTRA/FDD; Duty Cycle: 1:1;

Frequency: 1880 MHz; Medium parameters used: $f = 1880$ MHz; $\sigma = 1.51$ mho/m; $\epsilon_r = 54.3$; $\rho = 1000$ kg/m³ ;

Phantom section: Flat Section

Ambient temperature (): 21.5, Liquid temperature (): 21.0

DASY5 Configuration:

- Probe: EX3DV4 - SN3710; ConvF(7.43, 7.43, 7.43); Calibrated: 12/03/2012;
- Sensor-Surface: 4mm (Mechanical Surface Detection)
- Electronics: DAE4 Sn915; Calibrated: 21/06/2012
- Phantom: SAM2; Type: SAM; Serial: TP1562
- Measurement SW: DASY52, Version 52.8 (1); SEMCAD X Version 14.6.5 (6469)

Configuration/WCDMA Band II Mid Body-Bottom/Area Scan (6x7x1): Measurement grid: dx=15mm, dy=15mm, Maximum value of SAR (measured) = 0.562 mW/g

Configuration/WCDMA Band II Mid Body-Bottom/Zoom Scan (5x5x7)/Cube 0: Measurement grid: dx=8mm, dy=8mm, dz=5mm, Reference Value = 20.446 V/m; Power Drift = 0.03 dB
Peak SAR (extrapolated) = 0.986 mW/g

SAR(1 g) = 0.601 mW/g; SAR(10 g) = 0.350 mW/g Maximum value of SAR (measured) = 0.663 mW/g

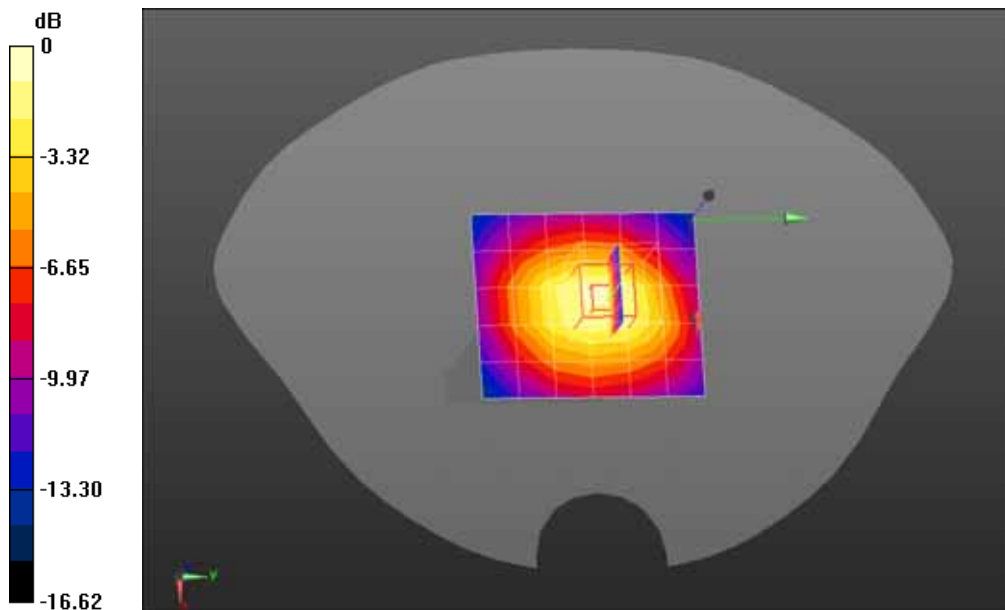

0 dB = 0.663 mW/g = -3.57 dB mW/g

Date/Time: 06-02-2013

Test Laboratory: QuieTek Lab

WCDMA Band II Mid Body-Left side

DUT: Smartphone ; Type: W5510

Communication System: UMTS; Communication System Band: Band II UTRA/FDD; Duty Cycle: 1:1;

Frequency: 1880 MHz; Medium parameters used: $f = 1880$ MHz; $\sigma = 1.51$ mho/m; $\epsilon_r = 54.3$; $\rho = 1000$ kg/m³ ;

Phantom section: Flat Section

Ambient temperature (): 21.5, Liquid temperature (): 21.0

DASY5 Configuration:

- Probe: EX3DV4 - SN3710; ConvF(7.43, 7.43, 7.43); Calibrated: 12/03/2012;
- Sensor-Surface: 4mm (Mechanical Surface Detection)
- Electronics: DAE4 Sn915; Calibrated: 21/06/2012
- Phantom: SAM2; Type: SAM; Serial: TP1562
- Measurement SW: DASY52, Version 52.8 (1); SEMCAD X Version 14.6.5 (6469)

Configuration/WCDMA Band II Mid Body-Left side/Area Scan (5x11x1): Measurement grid: dx=15mm, dy=15mm, Maximum value of SAR (measured) = 0.363 mW/g

Configuration/WCDMA Band II Mid Body-Left side/Zoom Scan (5x5x7)/Cube 0: Measurement grid: dx=8mm, dy=8mm, dz=5mm, Reference Value = 11.256 V/m; Power Drift = 0.04 dB
Peak SAR (extrapolated) = 0.647 mW/g

SAR(1 g) = 0.380 mW/g; SAR(10 g) = 0.214 mW/g Maximum value of SAR (measured) = 0.424 mW/g

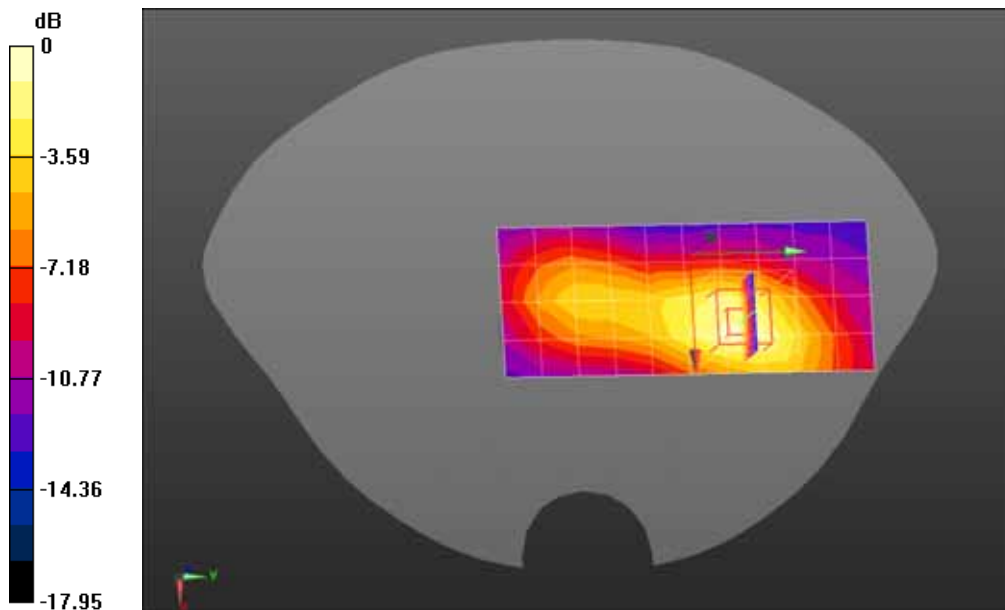

0 dB = 0.424 mW/g = -7.45 dB mW/g

Date/Time: 06-02-2013

Test Laboratory: QuieTek Lab

WCDMA Band II Mid Body-Right side

DUT: Smartphone ; Type: W5510

Communication System: UMTS; Communication System Band: Band II UTRA/FDD; Duty Cycle: 1:1;

Frequency: 1880 MHz; Medium parameters used: $f = 1880$ MHz; $\sigma = 1.51$ mho/m; $\epsilon_r = 54.3$; $\rho = 1000$ kg/m³ ;

Phantom section: Flat Section

Ambient temperature (): 21.5, Liquid temperature (): 21.0

DASY5 Configuration:

- Probe: EX3DV4 - SN3710; ConvF(7.43, 7.43, 7.43); Calibrated: 12/03/2012;
- Sensor-Surface: 4mm (Mechanical Surface Detection)
- Electronics: DAE4 Sn915; Calibrated: 21/06/2012
- Phantom: SAM2; Type: SAM; Serial: TP1562
- Measurement SW: DASY52, Version 52.8 (1); SEMCAD X Version 14.6.5 (6469)

Configuration/WCDMA Band II Mid Body-Right side/Area Scan (5x11x1): Measurement grid: dx=15mm, dy=15mm, Maximum value of SAR (measured) = 0.175 mW/g

Configuration/WCDMA Band II Mid Body-Right side/Zoom Scan (5x5x7)/Cube 0: Measurement grid: dx=8mm, dy=8mm, dz=5mm, Reference Value = 9.735 V/m; Power Drift = 0.04 dB

Peak SAR (extrapolated) = 0.283 mW/g

SAR(1 g) = 0.175 mW/g; SAR(10 g) = 0.104 mW/g Maximum value of SAR (measured) = 0.191 mW/g

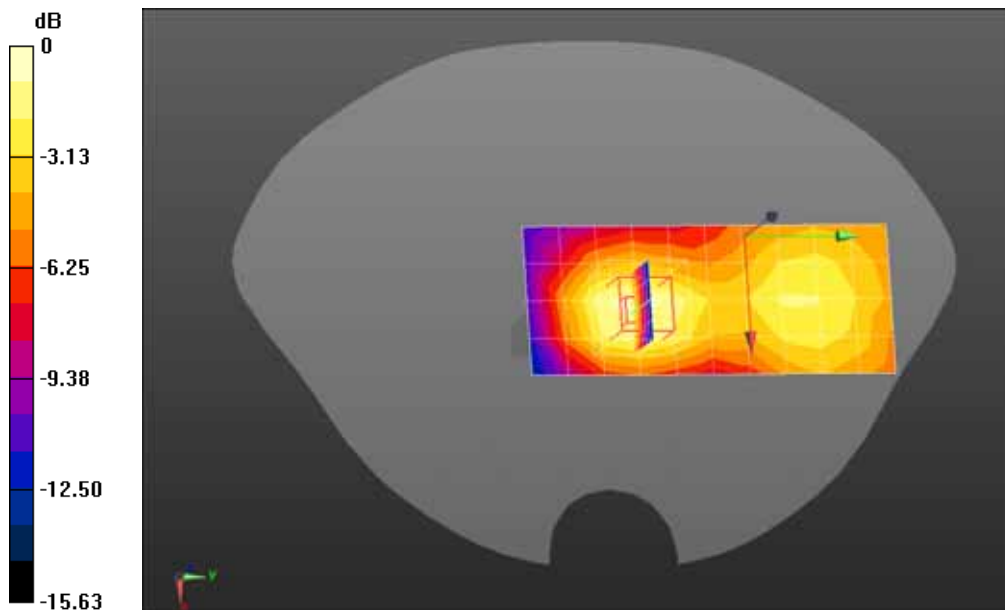

0 dB = 0.191 mW/g = -14.38 dB mW/g

Date/Time: 06-02-2013

Test Laboratory: QuieTek Lab

WCDMA Band V Mid Touch-Left

DUT: Smartphone ; Type: W5510

Communication System: UMTS; Communication System Band: Band V UTRA/FDD; Duty Cycle: 1:1;
 Frequency: 836.4 MHz; Medium parameters used: $f = 836.4$ MHz; $\sigma = 0.9$ mho/m; $\epsilon_r = 41.32$; $\rho = 1000$ kg/m³; Phantom section: Left Section

Ambient temperature (): 21.5, Liquid temperature (): 21.0

DASY5 Configuration:

- Probe: EX3DV4 - SN3710; ConvF(9.18, 9.18, 9.18); Calibrated: 12/03/2012;
- Sensor-Surface: 4mm (Mechanical Surface Detection)
- Electronics: DAE4 Sn915; Calibrated: 21/06/2012
- Phantom: SAM1; Type: SAM; Serial: TP1561
- Measurement SW: DASY52, Version 52.8 (1); SEMCAD X Version 14.6.5 (6469)

Configuration/WCDMA Band V Mid Touch-Left/Area Scan (7x11x1): Measurement grid: dx=15mm, dy=15mm, Maximum value of SAR (measured) = 0.445 mW/g

Configuration/WCDMA Band V Mid Touch-Left/Zoom Scan (5x5x7)/Cube 0: Measurement grid: dx=8mm, dy=8mm, dz=5mm, Reference Value = 6.183 V/m; Power Drift = -0.07 dB
 Peak SAR (extrapolated) = 0.537 mW/g

SAR(1 g) = 0.421 mW/g; SAR(10 g) = 0.313 mW/g Maximum value of SAR (measured) = 0.443 mW/g

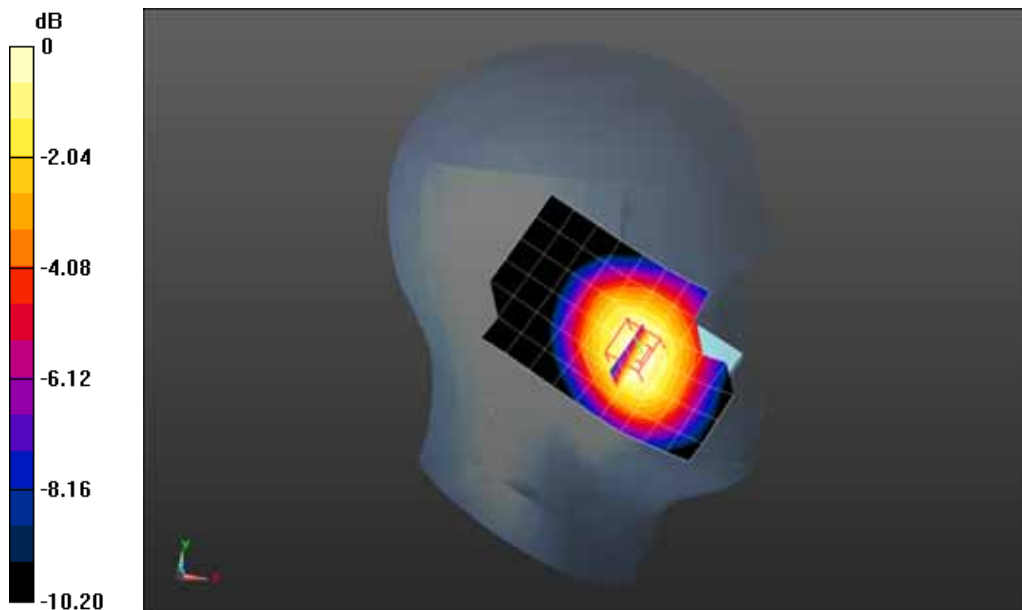

0 dB = 0.443 mW/g = -7.07 dB mW/g

Date/Time: 06-02-2013

Test Laboratory: QuieTek Lab

WCDMA Band V Mid Tilt-Left

DUT: Smartphone ; Type: W5510

Communication System: UMTS; Communication System Band: Band V UTRA/FDD; Duty Cycle: 1:1;
 Frequency: 836.4 MHz; Medium parameters used: $f = 836.4$ MHz; $\sigma = 0.9$ mho/m; $\epsilon_r = 41.32$; $\rho = 1000$ kg/m³ ; Phantom section: Left Section

Ambient temperature (): 21.5, Liquid temperature (): 21.0

DASY5 Configuration:

- Probe: EX3DV4 - SN3710; ConvF(9.18, 9.18, 9.18); Calibrated: 12/03/2012;
- Sensor-Surface: 4mm (Mechanical Surface Detection)
- Electronics: DAE4 Sn915; Calibrated: 21/06/2012
- Phantom: SAM1; Type: SAM; Serial: TP1561
- Measurement SW: DASY52, Version 52.8 (1); SEMCAD X Version 14.6.5 (6469)

Configuration/WCDMA Band V Mid Tilt-Left/Area Scan (7x11x1): Measurement grid: dx=15mm, dy=15mm, Maximum value of SAR (measured) = 0.301 mW/g

Configuration/WCDMA Band V Mid Tilt-Left/Zoom Scan (5x5x7)/Cube 0: Measurement grid: dx=8mm, dy=8mm, dz=5mm, Reference Value = 11.074 V/m; Power Drift = 0.02 dB

Peak SAR (extrapolated) = 0.356 mW/g

SAR(1 g) = 0.298 mW/g; SAR(10 g) = 0.229 mW/g Maximum value of SAR (measured) = 0.311 mW/g

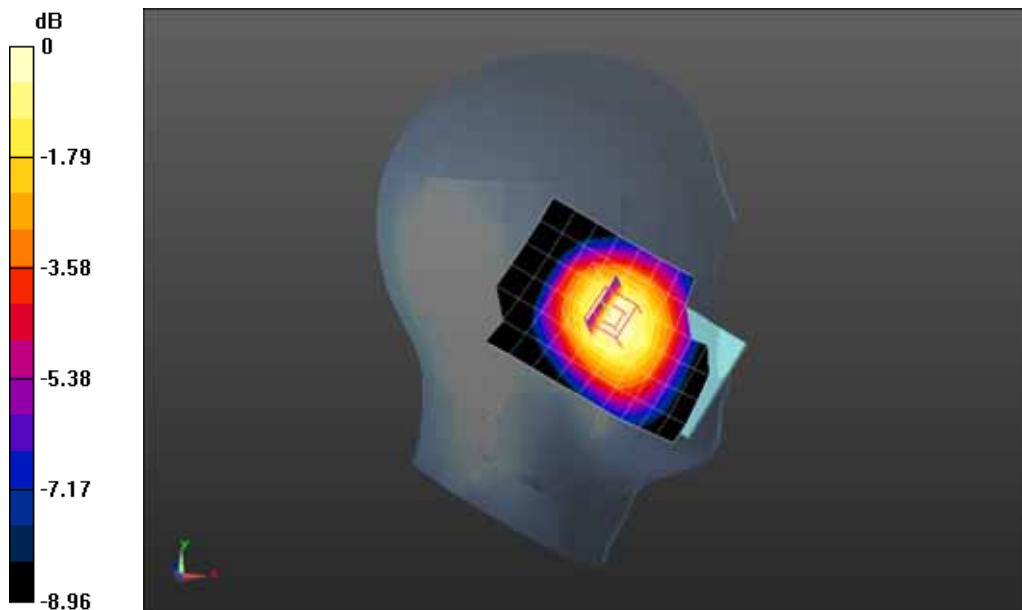

0 dB = 0.311 mW/g = -10.14 dB mW/g

Date/Time: 06-02-2013

Test Laboratory: QuieTek Lab

WCDMA Band V Mid Touch-Right

DUT: Smartphone ; Type: W5510

Communication System: UMTS; Communication System Band: Band V UTRA/FDD; Duty Cycle: 1:1;
 Frequency: 836.4 MHz; Medium parameters used: $f = 836.4$ MHz; $\sigma = 0.9$ mho/m; $\epsilon_r = 41.32$; $\rho = 1000$ kg/m³; Phantom section: Right Section

Ambient temperature (): 21.5, Liquid temperature (): 21.0

DASY5 Configuration:

- Probe: EX3DV4 - SN3710; ConvF(9.18, 9.18, 9.18); Calibrated: 12/03/2012;
- Sensor-Surface: 4mm (Mechanical Surface Detection)
- Electronics: DAE4 Sn915; Calibrated: 21/06/2012
- Phantom: SAM1; Type: SAM; Serial: TP1561
- Measurement SW: DASY52, Version 52.8 (1); SEMCAD X Version 14.6.5 (6469)

Configuration/WCDMA Band V Mid Touch-Right/Area Scan (7x11x1): Measurement grid: dx=15mm, dy=15mm, Maximum value of SAR (measured) = 0.400 mW/g

Configuration/WCDMA Band V Mid Touch-Right/Zoom Scan (5x5x7)/Cube 0: Measurement grid: dx=8mm, dy=8mm, dz=5mm, Reference Value = 4.845 V/m; Power Drift = -0.10 dB
 Peak SAR (extrapolated) = 0.484 mW/g

SAR(1 g) = 0.402 mW/g; SAR(10 g) = 0.306 mW/g Maximum value of SAR (measured) = 0.422 mW/g

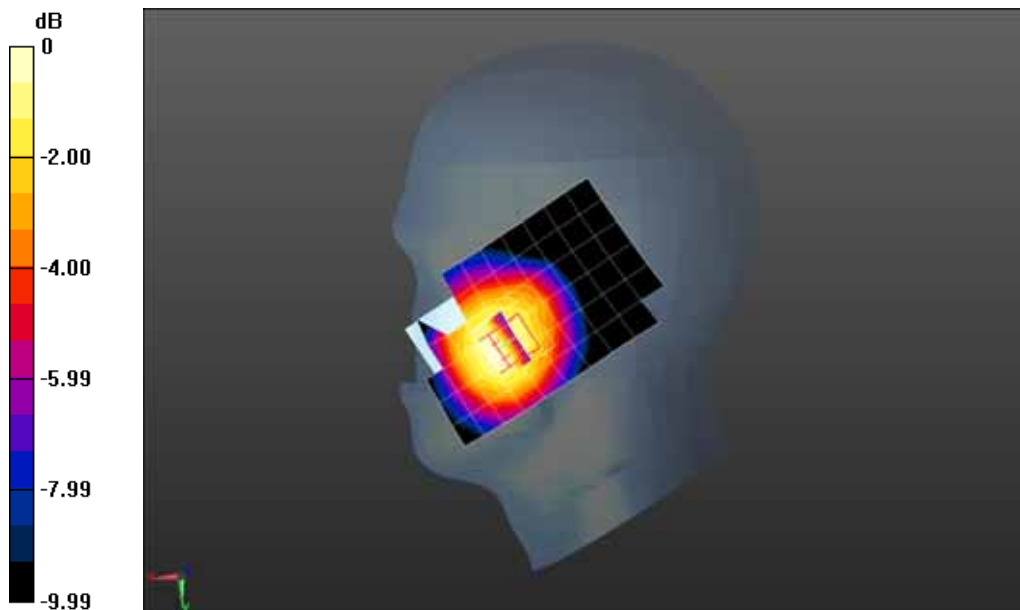

0 dB = 0.422 mW/g = -7.49 dB mW/g

Date/Time: 06-02-2013

Test Laboratory: QuieTek Lab

WCDMA Band V Mid Tilt-Right

DUT: Smartphone ; Type: W5510

Communication System: UMTS; Communication System Band: Band V UTRA/FDD; Duty Cycle: 1:1;
 Frequency: 836.4 MHz; Medium parameters used: $f = 836.4$ MHz; $\sigma = 0.9$ mho/m; $\epsilon_r = 41.32$; $\rho = 1000$ kg/m³; Phantom section: Right Section

Ambient temperature (): 21.5, Liquid temperature (): 21.0

DASY5 Configuration:

- Probe: EX3DV4 - SN3710; ConvF(9.18, 9.18, 9.18); Calibrated: 12/03/2012;
- Sensor-Surface: 4mm (Mechanical Surface Detection)
- Electronics: DAE4 Sn915; Calibrated: 21/06/2012
- Phantom: SAM1; Type: SAM; Serial: TP1561
- Measurement SW: DASY52, Version 52.8 (1); SEMCAD X Version 14.6.5 (6469)

Configuration/WCDMA Band V Mid Tilt-Right/Area Scan (7x11x1): Measurement grid: dx=15mm, dy=15mm, Maximum value of SAR (measured) = 0.275 mW/g

Configuration/WCDMA Band V Mid Tilt-Right/Zoom Scan (5x5x7)/Cube 0: Measurement grid: dx=8mm, dy=8mm, dz=5mm, Reference Value = 9.801 V/m; Power Drift = 0.07 dB

Peak SAR (extrapolated) = 0.330 mW/g

SAR(1 g) = 0.272 mW/g; SAR(10 g) = 0.207 mW/g Maximum value of SAR (measured) = 0.284 mW/g

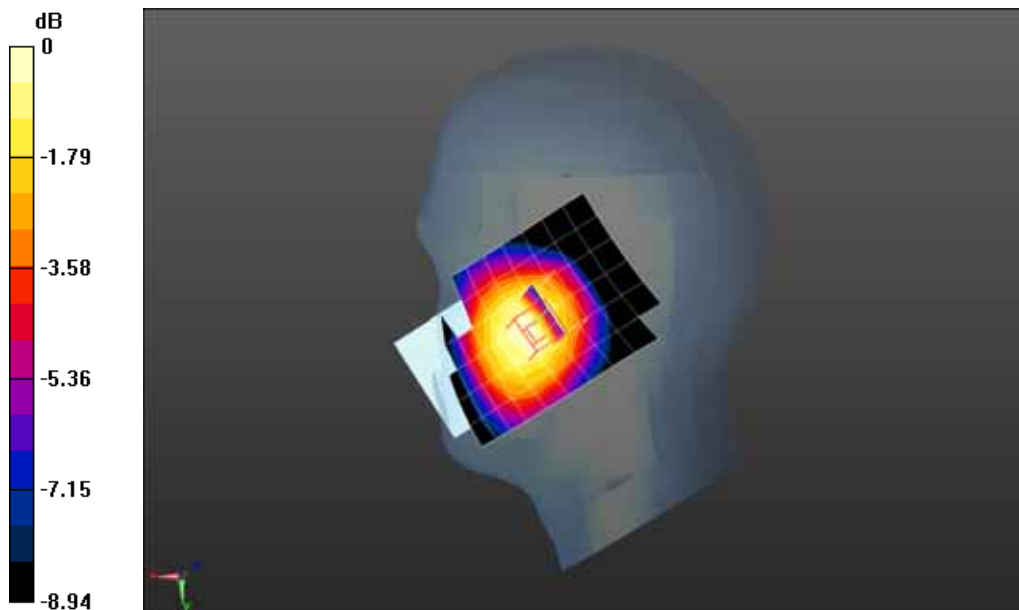

0 dB = 0.284 mW/g = -10.93 dB mW/g

Date/Time: 06-02-2013

Test Laboratory: QuieTek Lab

WCDMA Band V Low Body-Back

DUT: Smartphone ; Type: W5510

Communication System: UMTS; Communication System Band: Band V UTRA/FDD; Duty Cycle: 1:1;
 Frequency: 826.4 MHz; Medium parameters used: $f = 826.4$ MHz; $\sigma = 0.97$ mho/m; $\epsilon_r = 53.77$; $\rho = 1000$ kg/m³ ; Phantom section: Flat Section

Ambient temperature (): 21.5, Liquid temperature (): 21.0

DASY5 Configuration:

- Probe: EX3DV4 - SN3710; ConvF(9.13, 9.13, 9.13); Calibrated: 12/03/2012;
- Sensor-Surface: 4mm (Mechanical Surface Detection)
- Electronics: DAE4 Sn915; Calibrated: 21/06/2012
- Phantom: SAM1; Type: SAM; Serial: TP1561
- Measurement SW: DASY52, Version 52.8 (1); SEMCAD X Version 14.6.5 (6469)

Configuration/WCDMA Band V Low Body-Back/Area Scan (7x11x1): Measurement grid: dx=15mm, dy=15mm, Maximum value of SAR (measured) = 0.835 mW/g

Configuration/WCDMA Band V Low Body-Back/Zoom Scan (5x5x7)/Cube 1: Measurement grid: dx=8mm, dy=8mm, dz=5mm, Reference Value = 8.807 V/m; Power Drift = 0.03 dB
 Peak SAR (extrapolated) = 1.033 mW/g

SAR(1 g) = 0.706 mW/g; SAR(10 g) = 0.497 mW/g Maximum value of SAR (measured) = 0.782 mW/g

Configuration/WCDMA Band V Low Body-Back/Zoom Scan (5x5x7)/Cube 0: Measurement grid: dx=8mm, dy=8mm, dz=5mm, Reference Value = 8.807 V/m; Power Drift = 0.03 dB
 Peak SAR (extrapolated) = 1.062 mW/g

SAR(1 g) = 0.820 mW/g; SAR(10 g) = 0.604 mW/g Maximum value of SAR (measured) = 0.863 mW/g

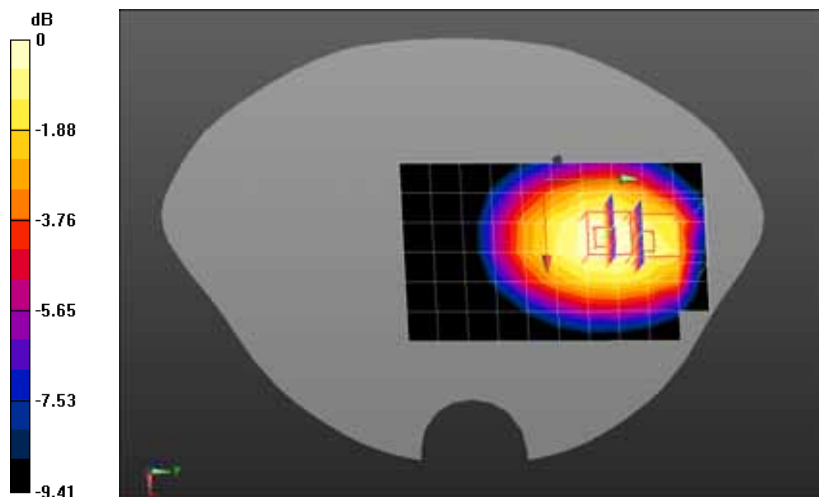

0 dB = 0.863 mW/g = -1.28 dB mW/g

Date/Time: 06-02-2013

Test Laboratory: QuieTek Lab

WCDMA Band V Mid Body-Back

DUT: Smartphone ; Type: W5510

Communication System: UMTS; Communication System Band: Band V UTRA/FDD; Duty Cycle: 1:1;
 Frequency: 836.4 MHz; Medium parameters used: $f = 836.4$ MHz; $\sigma = 0.98$ mho/m; $\epsilon_r = 53.64$; $\rho = 1000$ kg/m³ ; Phantom section: Flat Section

Ambient temperature (): 21.5, Liquid temperature (): 21.0

DASY5 Configuration:

- Probe: EX3DV4 - SN3710; ConvF(9.13, 9.13, 9.13); Calibrated: 12/03/2012;
- Sensor-Surface: 4mm (Mechanical Surface Detection)
- Electronics: DAE4 Sn915; Calibrated: 21/06/2012
- Phantom: SAM1; Type: SAM; Serial: TP1561
- Measurement SW: DASY52, Version 52.8 (1); SEMCAD X Version 14.6.5 (6469)

Configuration/WCDMA Band V Mid Body-Back/Area Scan (7x11x1): Measurement grid: dx=15mm, dy=15mm, Maximum value of SAR (measured) = 0.829 mW/g

Configuration/WCDMA Band V Mid Body-Back/Zoom Scan (5x5x7)/Cube 1: Measurement grid: dx=8mm, dy=8mm, dz=5mm, Reference Value = 9.122 V/m; Power Drift = -0.01 dB
 Peak SAR (extrapolated) = 1.028 mW/g

SAR(1 g) = 0.697 mW/g; SAR(10 g) = 0.490 mW/g Maximum value of SAR (measured) = 0.775 mW/g

Configuration/WCDMA Band V Mid Body-Back/Zoom Scan (5x5x7)/Cube 0: Measurement grid: dx=8mm, dy=8mm, dz=5mm, Reference Value = 9.122 V/m; Power Drift = -0.01 dB
 Peak SAR (extrapolated) = 1.061 mW/g

SAR(1 g) = 0.821 mW/g; SAR(10 g) = 0.604 mW/g Maximum value of SAR (measured) = 0.866 mW/g

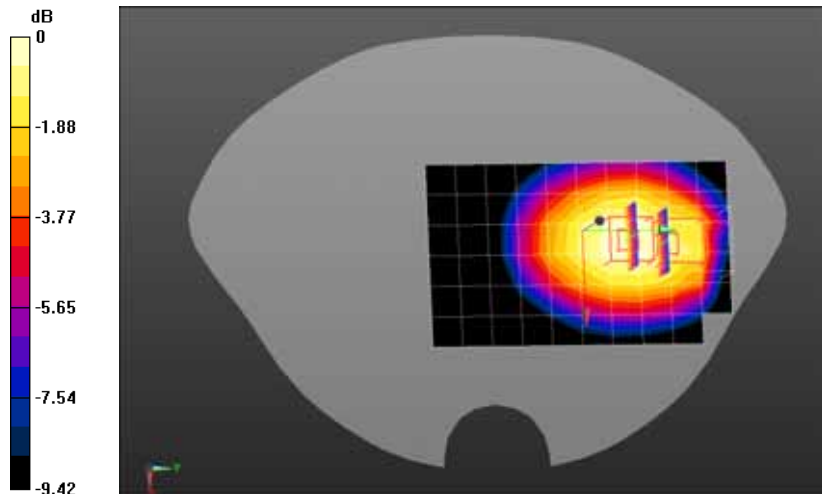

0 dB = 0.866 mW/g = -1.25 dB mW/g

Z-Axis Plot

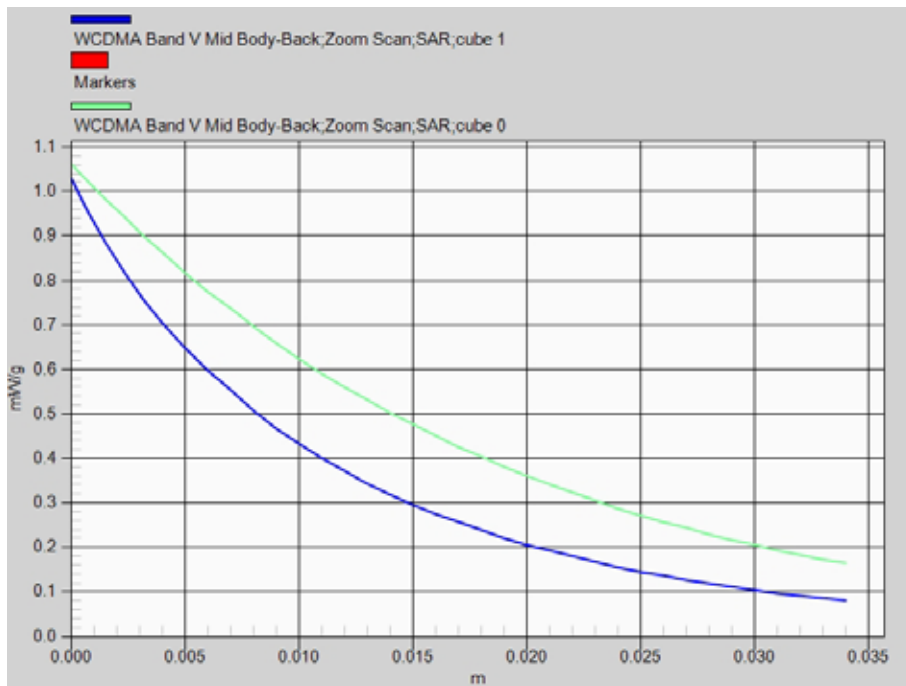

Date/Time: 06-02-2013

Test Laboratory: QuieTek Lab

WCDMA Band V Mid Body-Back-1

DUT: Smartphone ; Type: W5510

Communication System: UMTS; Communication System Band: Band V UTRA/FDD; Duty Cycle: 1:1;
 Frequency: 836.4 MHz; Medium parameters used: $f = 836.4$ MHz; $\sigma = 0.98$ mho/m; $\epsilon_r = 53.64$; $\rho = 1000$ kg/m³ ; Phantom section: Flat Section

Ambient temperature (): 21.5, Liquid temperature (): 21.0

DASY5 Configuration:

- Probe: EX3DV4 - SN3710; ConvF(9.13, 9.13, 9.13); Calibrated: 12/03/2012;
- Sensor-Surface: 4mm (Mechanical Surface Detection)
- Electronics: DAE4 Sn915; Calibrated: 21/06/2012
- Phantom: SAM1; Type: SAM; Serial: TP1561
- Measurement SW: DASY52, Version 52.8 (1); SEMCAD X Version 14.6.5 (6469)

Configuration/WCDMA Band V Mid Body-Back/Area Scan (7x11x1): Measurement grid: dx=15mm, dy=15mm, Maximum value of SAR (measured) = 0.787 mW/g

Configuration/WCDMA Band V Mid Body-Back/Zoom Scan (5x5x7)/Cube 1: Measurement grid: dx=8mm, dy=8mm, dz=5mm, Reference Value = 9.669 V/m; Power Drift = 0.06 dB
 Peak SAR (extrapolated) = 0.972 mW/g

SAR(1 g) = 0.662 mW/g; SAR(10 g) = 0.458 mW/g Maximum value of SAR (measured) = 0.728 mW/g

Configuration/WCDMA Band V Mid Body-Back/Zoom Scan (5x5x7)/Cube 0: Measurement grid: dx=8mm, dy=8mm, dz=5mm, Reference Value = 9.669 V/m; Power Drift = 0.06 dB
 Peak SAR (extrapolated) = 1.008 mW/g

SAR(1 g) = 0.778 mW/g; SAR(10 g) = 0.572 mW/g Maximum value of SAR (measured) = 0.822 mW/g

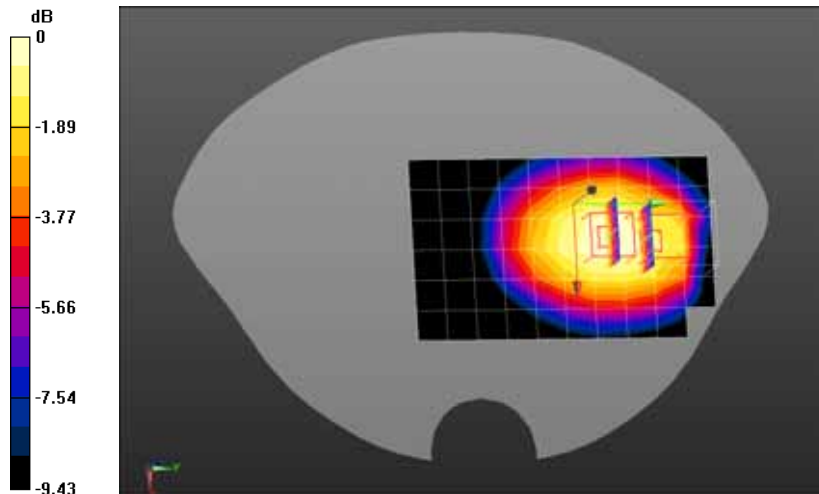

0 dB = 0.822 mW/g = -1.70 dB mW/g

Date/Time: 06-02-2013

Test Laboratory: QuieTek Lab

WCDMA Band V High Body-Back

DUT: Smartphone ; Type: W5510

Communication System: UMTS; Communication System Band: Band V UTRA/FDD; Duty Cycle: 1:1;
 Frequency: 846.6 MHz; Medium parameters used: $f = 846.6$ MHz; $\sigma = 0.99$ mho/m; $\epsilon_r = 53.55$; $\rho = 1000$ kg/m³ ; Phantom section: Flat Section

Ambient temperature (): 21.5, Liquid temperature (): 21.0

DASY5 Configuration:

- Probe: EX3DV4 - SN3710; ConvF(9.13, 9.13, 9.13); Calibrated: 12/03/2012;
- Sensor-Surface: 4mm (Mechanical Surface Detection)
- Electronics: DAE4 Sn915; Calibrated: 21/06/2012
- Phantom: SAM1; Type: SAM; Serial: TP1561
- Measurement SW: DASY52, Version 52.8 (1); SEMCAD X Version 14.6.5 (6469)

Configuration/WCDMA Band V High Body-Back/Area Scan (7x11x1): Measurement grid: dx=15mm, dy=15mm, Maximum value of SAR (measured) = 0.820 mW/g

Configuration/WCDMA Band V High Body-Back/Zoom Scan (5x5x7)/Cube 1: Measurement grid: dx=8mm, dy=8mm, dz=5mm, Reference Value = 9.258 V/m; Power Drift = -0.01 dB
 Peak SAR (extrapolated) = 1.006 mW/g

SAR(1 g) = 0.676 mW/g; SAR(10 g) = 0.474 mW/g Maximum value of SAR (measured) = 0.756 mW/g

Configuration/WCDMA Band V High Body-Back/Zoom Scan (5x5x7)/Cube 0: Measurement grid: dx=8mm, dy=8mm, dz=5mm, Reference Value = 9.258 V/m; Power Drift = -0.01 dB
 Peak SAR (extrapolated) = 1.048 mW/g

SAR(1 g) = 0.806 mW/g; SAR(10 g) = 0.593 mW/g Maximum value of SAR (measured) = 0.849 mW/g

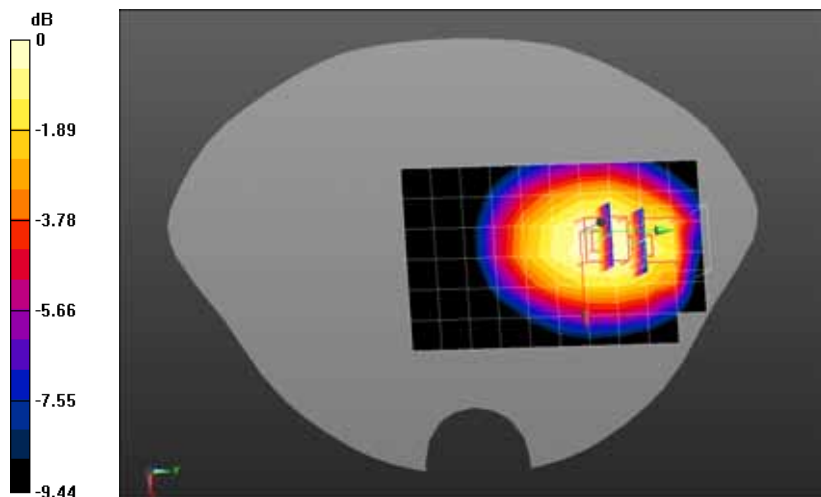

0 dB = 0.849 mW/g = -1.42 dB mW/g

Date/Time: 06-02-2013

Test Laboratory: QuieTek Lab

WCDMA Band V Mid Body-Front

DUT: Smartphone ; Type: W5510

Communication System: UMTS; Communication System Band: Band V UTRA/FDD; Duty Cycle: 1:1;
 Frequency: 836.4 MHz; Medium parameters used: $f = 836.4$ MHz; $\sigma = 0.98$ mho/m; $\epsilon_r = 53.64$; $\rho = 1000$ kg/m³; Phantom section: Flat Section

Ambient temperature (): 21.5, Liquid temperature (): 21.0

DASY5 Configuration:

- Probe: EX3DV4 - SN3710; ConvF(9.13, 9.13, 9.13); Calibrated: 12/03/2012;
- Sensor-Surface: 4mm (Mechanical Surface Detection)
- Electronics: DAE4 Sn915; Calibrated: 21/06/2012
- Phantom: SAM1; Type: SAM; Serial: TP1561
- Measurement SW: DASY52, Version 52.8 (1); SEMCAD X Version 14.6.5 (6469)

Configuration/WCDMA Band V Mid Body-Front/Area Scan (7x11x1): Measurement grid: dx=15mm, dy=15mm, Maximum value of SAR (measured) = 0.472 mW/g

Configuration/WCDMA Band V Mid Body-Front/Zoom Scan (5x5x7)/Cube 0: Measurement grid: dx=8mm, dy=8mm, dz=5mm, Reference Value = 6.479 V/m; Power Drift = 0.03 dB
 Peak SAR (extrapolated) = 0.593 mW/g

SAR(1 g) = 0.456 mW/g; SAR(10 g) = 0.340 mW/g Maximum value of SAR (measured) = 0.481 mW/g

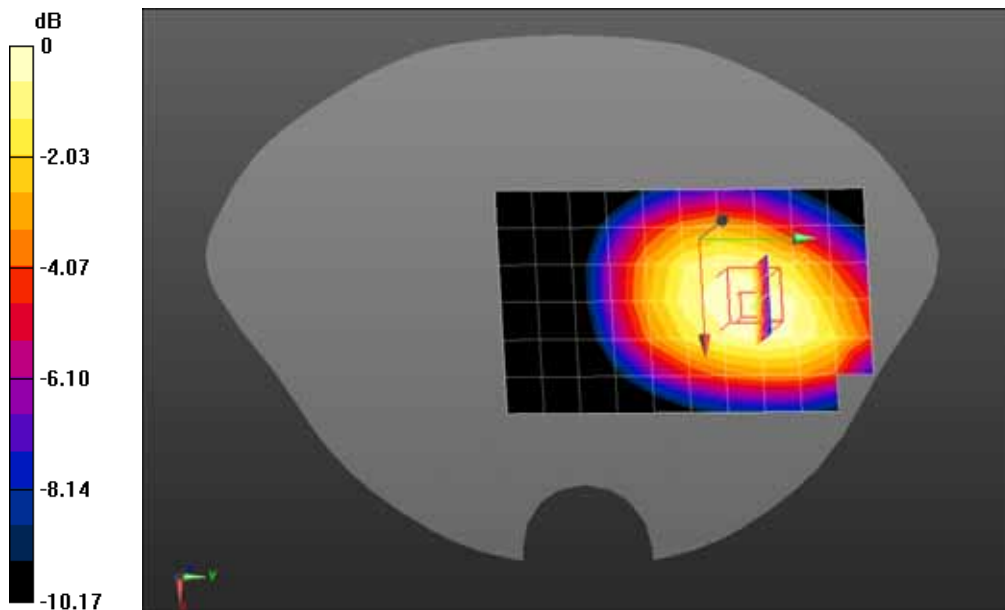

0 dB = 0.481 mW/g = -6.36 dB mW/g

Date/Time: 06-02-2013

Test Laboratory: QuieTek Lab

WCDMA Band V Mid Body-Bottom

DUT: Smartphone ; Type: W5510

Communication System: UMTS; Communication System Band: Band V UTRA/FDD; Duty Cycle: 1:1;
 Frequency: 836.4 MHz; Medium parameters used: $f = 836.4$ MHz; $\sigma = 0.98$ mho/m; $\epsilon_r = 53.64$; $\rho = 1000$ kg/m³; Phantom section: Flat Section

Ambient temperature (): 21.5, Liquid temperature (): 21.0

DASY5 Configuration:

- Probe: EX3DV4 - SN3710; ConvF(9.13, 9.13, 9.13); Calibrated: 12/03/2012;
- Sensor-Surface: 4mm (Mechanical Surface Detection)
- Electronics: DAE4 Sn915; Calibrated: 21/06/2012
- Phantom: SAM1; Type: SAM; Serial: TP1561
- Measurement SW: DASY52, Version 52.8 (1); SEMCAD X Version 14.6.5 (6469)

Configuration/WCDMA Band V Mid Body-Bottom/Area Scan (7x7x1): Measurement grid: dx=15mm, dy=15mm, Maximum value of SAR (measured) = 0.251 mW/g

Configuration/WCDMA Band V Mid Body-Bottom/Zoom Scan (5x5x7)/Cube 0: Measurement grid: dx=8mm, dy=8mm, dz=5mm, Reference Value = 12.805 V/m; Power Drift = 0.00 dB
 Peak SAR (extrapolated) = 0.529 mW/g

SAR(1 g) = 0.260 mW/g; SAR(10 g) = 0.134 mW/g Maximum value of SAR (measured) = 0.280 mW/g

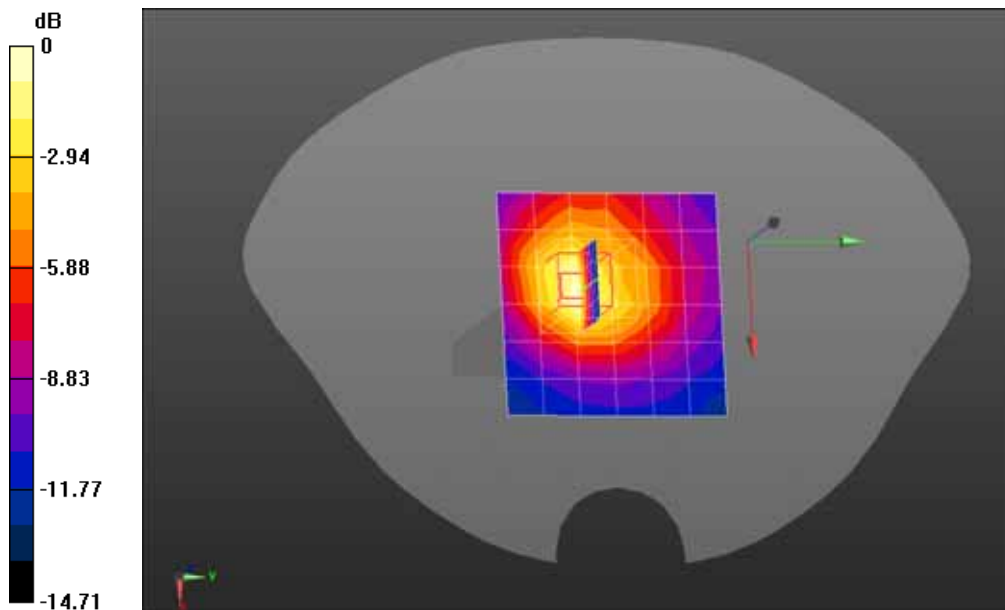

0 dB = 0.280 mW/g = -11.06 dB mW/g

Date/Time: 06-02-2013

Test Laboratory: QuieTek Lab

WCDMA Band V Mid Body-Left side

DUT: Smartphone ; Type: W5510

Communication System: UMTS; Communication System Band: Band V UTRA/FDD; Duty Cycle: 1:1;
 Frequency: 836.4 MHz; Medium parameters used: $f = 836.4$ MHz; $\sigma = 0.98$ mho/m; $\epsilon_r = 53.64$; $\rho = 1000$ kg/m³; Phantom section: Flat Section

Ambient temperature (): 21.5, Liquid temperature (): 21.0

DASY5 Configuration:

- Probe: EX3DV4 - SN3710; ConvF(9.13, 9.13, 9.13); Calibrated: 12/03/2012;
- Sensor-Surface: 4mm (Mechanical Surface Detection)
- Electronics: DAE4 Sn915; Calibrated: 21/06/2012
- Phantom: SAM1; Type: SAM; Serial: TP1561
- Measurement SW: DASY52, Version 52.8 (1); SEMCAD X Version 14.6.5 (6469)

Configuration/WCDMA Band V Mid Body-Left side/Area Scan (7x11x1): Measurement grid: dx=15mm, dy=15mm, Maximum value of SAR (measured) = 0.654 mW/g

Configuration/WCDMA Band V Mid Body-Left side/Zoom Scan (5x5x7)/Cube 0: Measurement grid: dx=8mm, dy=8mm, dz=5mm, Reference Value = 19.623 V/m; Power Drift = -0.10 dB
 Peak SAR (extrapolated) = 0.887 mW/g

SAR(1 g) = 0.597 mW/g; SAR(10 g) = 0.395 mW/g Maximum value of SAR (measured) = 0.641 mW/g

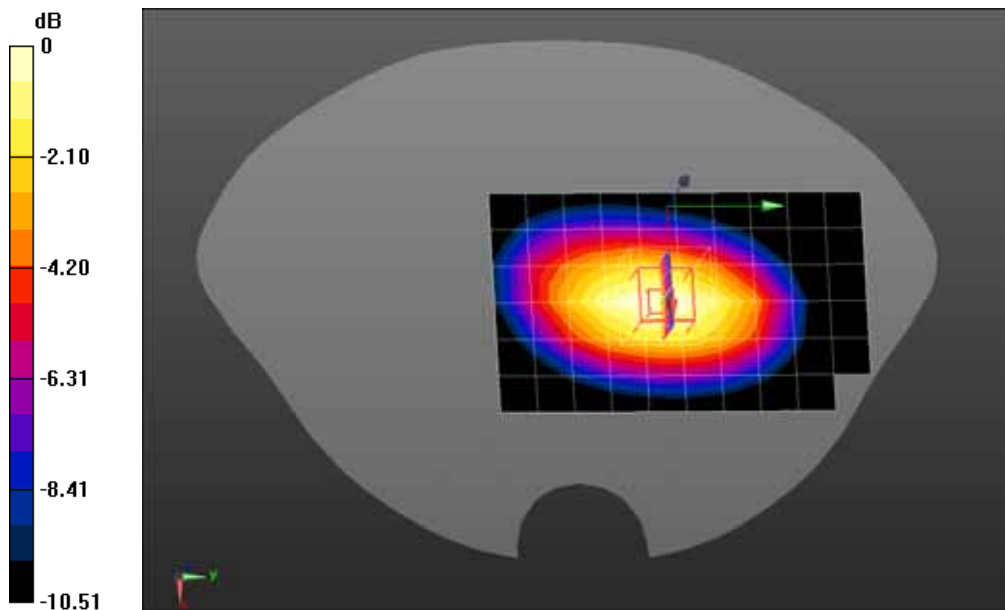

0 dB = 0.641 mW/g = -3.86 dB mW/g

Date/Time: 06-02-2013

Test Laboratory: QuieTek Lab

WCDMA Band V Mid Body-Right side

DUT: Smartphone ; Type: W5510

Communication System: UMTS; Communication System Band: Band V UTRA/FDD; Duty Cycle: 1:1;
 Frequency: 836.4 MHz; Medium parameters used: $f = 836.4$ MHz; $\sigma = 0.98$ mho/m; $\epsilon_r = 53.64$; $\rho = 1000$ kg/m³ ; Phantom section: Flat Section

Ambient temperature (): 21.5, Liquid temperature (): 21.0

DASY5 Configuration:

- Probe: EX3DV4 - SN3710; ConvF(9.13, 9.13, 9.13); Calibrated: 12/03/2012;
- Sensor-Surface: 4mm (Mechanical Surface Detection)
- Electronics: DAE4 Sn915; Calibrated: 21/06/2012
- Phantom: SAM1; Type: SAM; Serial: TP1561
- Measurement SW: DASY52, Version 52.8 (1); SEMCAD X Version 14.6.5 (6469)

Configuration/WCDMA Band V Mid Body-Right side/Area Scan (7x11x1): Measurement grid: dx=15mm, dy=15mm, Maximum value of SAR (measured) = 0.432 mW/g

Configuration/WCDMA Band V Mid Body-Right side/Zoom Scan (5x5x7)/Cube 0: Measurement grid: dx=8mm, dy=8mm, dz=5mm, Reference Value = 18.349 V/m; Power Drift = -0.17 dB
 Peak SAR (extrapolated) = 0.621 mW/g

SAR(1 g) = 0.436 mW/g; SAR(10 g) = 0.299 mW/g Maximum value of SAR (measured) = 0.468 mW/g

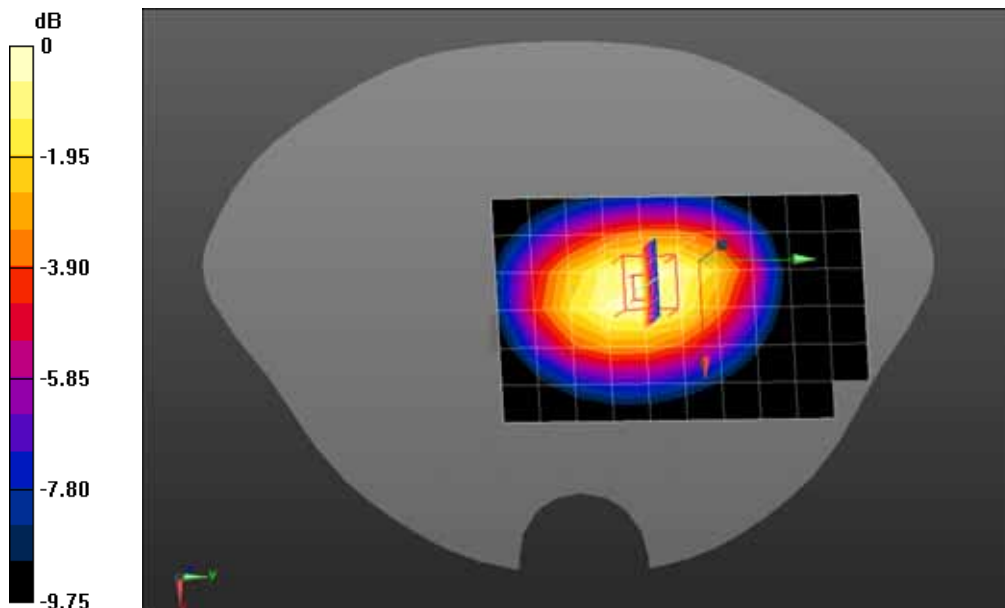

0 dB = 0.468 mW/g = -6.60 dB mW/g

Date/Time: 06-02-2013

Test Laboratory: QuieTek Lab

802.11b 2437MHz Touch-Left

DUT: Smartphone ; Type: W5510

Communication System: Wi-Fi; Communication System Band: 802.11b; Duty Cycle: 1:1; Frequency: 2437 MHz; Medium parameters used: $f = 2437$ MHz; $\sigma = 1.84$ mho/m; $\epsilon_r = 38.11$; $\rho = 1000$ kg/m³ ; Phantom section: Left Section

Ambient temperature (): 21.5, Liquid temperature (): 21.0

DASY5 Configuration:

- Probe: EX3DV4 - SN3710; ConvF(7.25, 7.25, 7.25); Calibrated: 12/03/2012;
- Sensor-Surface: 4mm (Mechanical Surface Detection)
- Electronics: DAE4 Sn915; Calibrated: 21/06/2012
- Phantom: SAM1; Type: SAM; Serial: TP1561
- Measurement SW: DASY52, Version 52.8 (1); SEMCAD X Version 14.6.5 (6469)

Configuration/802.11b 2437MHz Touch-Left/Area Scan (7x11x1): Measurement grid: dx=15mm, dy=15mm, Maximum value of SAR (measured) = 0.00331 mW/g

Configuration/802.11b 2437MHz Touch-Left/Zoom Scan (5x5x7)/Cube 0: Measurement grid: dx=8mm, dy=8mm, dz=5mm, Reference Value = 1.532 V/m; Power Drift = -0.12 dB

Peak SAR (extrapolated) = 0.012 mW/g

SAR(1 g) = 0.00348 mW/g; SAR(10 g) = 0.00102 mW/g Maximum value of SAR (measured) = 0.00343 mW/g

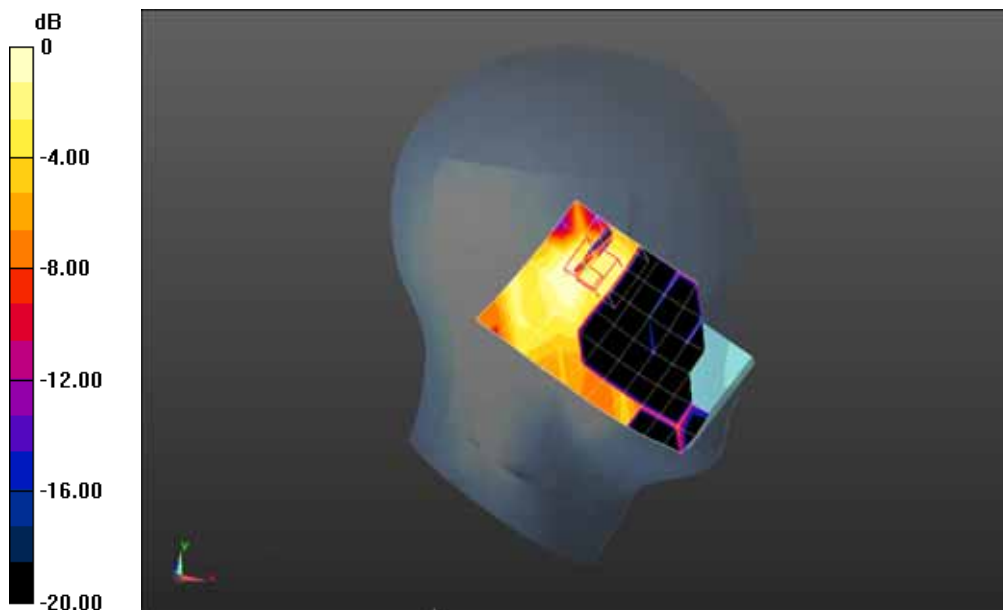

0 dB = 0.00343 mW/g = -49.29 dB mW/g

Date/Time: 06-02-2013

Test Laboratory: QuieTek Lab

802.11b 2437MHz Tilt-Left

DUT: Smartphone ; Type: W5510

Communication System: Wi-Fi; Communication System Band: 802.11b; Duty Cycle: 1:1; Frequency: 2437 MHz; Medium parameters used: $f = 2437$ MHz; $\sigma = 1.84$ mho/m; $\epsilon_r = 38.11$; $\rho = 1000$ kg/m³; Phantom section: Left Section

Ambient temperature (): 21.5, Liquid temperature (): 21.0

DASY5 Configuration:

- Probe: EX3DV4 - SN3710; ConvF(7.25, 7.25, 7.25); Calibrated: 12/03/2012;
- Sensor-Surface: 4mm (Mechanical Surface Detection)
- Electronics: DAE4 Sn915; Calibrated: 21/06/2012
- Phantom: SAM1; Type: SAM; Serial: TP1561
- Measurement SW: DASY52, Version 52.8 (1); SEMCAD X Version 14.6.5 (6469)

Configuration/802.11b 2437MHz Tilt-Left/Area Scan (7x11x1): Measurement grid: dx=15mm, dy=15mm

Maximum value of SAR (measured) = 0.00424 mW/g

Configuration/802.11b 2437MHz Tilt-Left/Zoom Scan (5x5x7)/Cube 0: Measurement grid: dx=8mm,

dy=8mm, dz=5mm, Reference Value = 1.082 V/m; Power Drift = 0.09 dB

Peak SAR (extrapolated) = 0.00384 mW/g

SAR(1 g) = 0.000131 mW/g; SAR(10 g) = 1.39e-005 mW/g Maximum value of SAR (measured) = 0.00526 mW/g

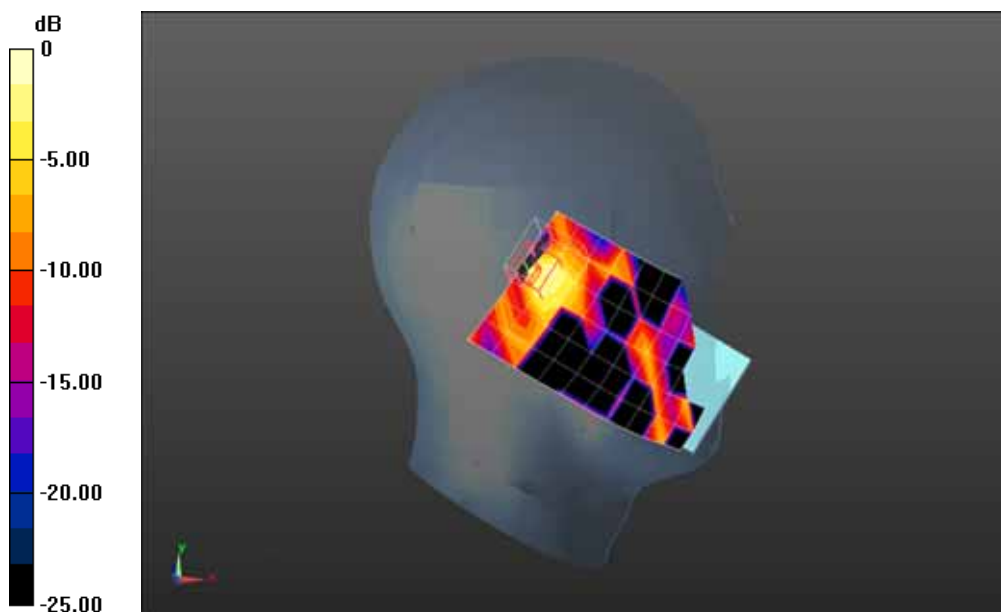

0 dB = 0.00526 mW/g = -45.58 dB mW/g

Date/Time: 06-02-2013

Test Laboratory: QuieTek Lab

802.11b 2437MHz Touch-Right

DUT: Smartphone ; Type: W5510

Communication System: Wi-Fi; Communication System Band: 802.11b; Duty Cycle: 1:1; Frequency: 2437 MHz; Medium parameters used: $f = 2437$ MHz; $\sigma = 1.84$ mho/m; $\epsilon_r = 38.11$; $\rho = 1000$ kg/m³; Phantom section: Right Section

Ambient temperature (): 21.5, Liquid temperature (): 21.0

DASY5 Configuration:

- Probe: EX3DV4 - SN3710; ConvF(7.25, 7.25, 7.25); Calibrated: 12/03/2012;
- Sensor-Surface: 4mm (Mechanical Surface Detection)
- Electronics: DAE4 Sn915; Calibrated: 21/06/2012
- Phantom: SAM1; Type: SAM; Serial: TP1561
- Measurement SW: DASY52, Version 52.8 (1); SEMCAD X Version 14.6.5 (6469)

Configuration/802.11b 2437MHz Touch-Right/Area Scan (7x11x1): Measurement grid: dx=15mm, dy=15mm, Maximum value of SAR (measured) = 0.00571 mW/g

Configuration/802.11b 2437MHz Touch-Right/Zoom Scan (5x5x7)/Cube 0: Measurement grid: dx=8mm, dy=8mm, dz=5mm, Reference Value = 0.866 V/m; Power Drift = 0.12 dB

Peak SAR (extrapolated) = 0.011 mW/g

SAR(1 g) = 0.00473 mW/g; SAR(10 g) = 0.00163 mW/g Maximum value of SAR (measured) = 0.00569 mW/g

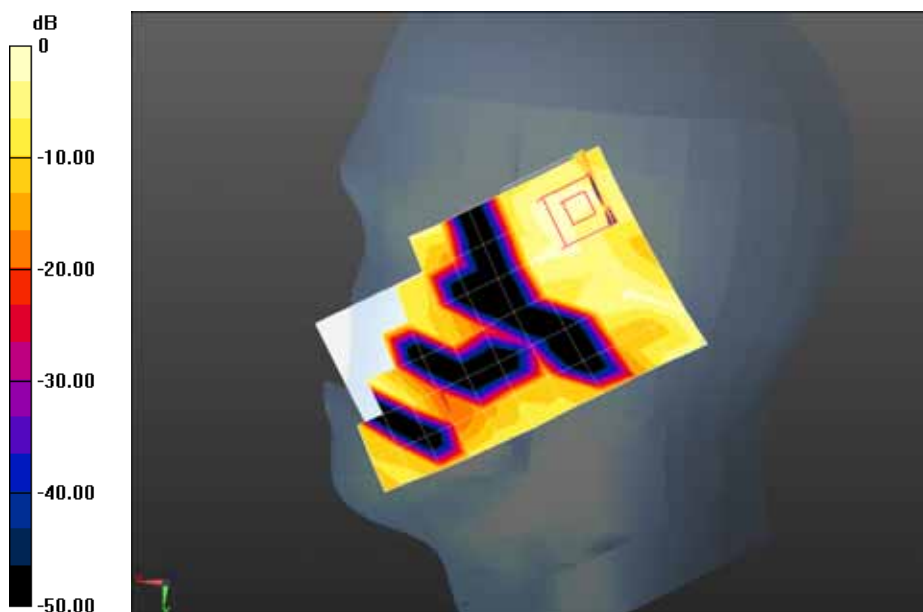

0 dB = 0.00569 mW/g = -44.90 dB mW/g

Date/Time: 06-02-2013

Test Laboratory: QuieTek Lab

802.11b 2437MHz Tilt-Right

DUT: Smartphone ; Type: W5510

Communication System: Wi-Fi; Communication System Band: 802.11b; Duty Cycle: 1:1; Frequency: 2437 MHz; Medium parameters used: $f = 2437$ MHz; $\sigma = 1.84$ mho/m; $\epsilon_r = 38.11$; $\rho = 1000$ kg/m³; Phantom section: Right Section

Ambient temperature (): 21.5, Liquid temperature (): 21.0

DASY5 Configuration:

- Probe: EX3DV4 - SN3710; ConvF(7.25, 7.25, 7.25); Calibrated: 12/03/2012;
- Sensor-Surface: 4mm (Mechanical Surface Detection)
- Electronics: DAE4 Sn915; Calibrated: 21/06/2012
- Phantom: SAM1; Type: SAM; Serial: TP1561
- Measurement SW: DASY52, Version 52.8 (1); SEMCAD X Version 14.6.5 (6469)

Configuration/802.11b 2437MHz Tilt-Right/Area Scan (7x11x1): Measurement grid: dx=15mm, dy=15mm, Maximum value of SAR (measured) = 0.00527 mW/g

Configuration/802.11b 2437MHz Tilt-Right/Zoom Scan (5x5x7)/Cube 0: Measurement grid: dx=8mm, dy=8mm, dz=5mm, Reference Value = 0.919 V/m; Power Drift = 0.18 dB

Peak SAR (extrapolated) = 0.011 mW/g

SAR(1 g) = 0.00236 mW/g; SAR(10 g) = 0.000367 mW/g Maximum value of SAR (measured) = 0.00602 mW/g

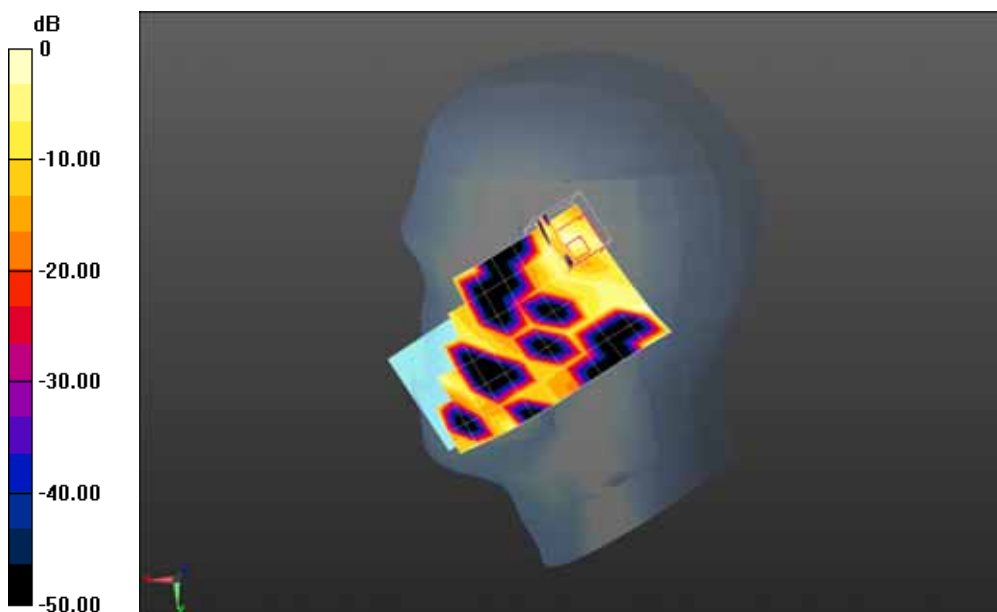

0 dB = 0.00602 mW/g = -44.41 dB mW/g

Date/Time: 06-02-2013

Test Laboratory: QuieTek Lab

802.11b 2437MHz Body-Back

DUT: Smartphone ; Type: W5510

Communication System: Wi-Fi; Communication System Band: 802.11b; Duty Cycle: 1:1; Frequency: 2437 MHz; Medium parameters used: $f = 2437$ MHz; $\sigma = 1.89$ mho/m; $\epsilon_r = 53.36$; $\rho = 1000$ kg/m³; Phantom section: Flat Section

Ambient temperature (): 21.5, Liquid temperature (): 21.0

DASY5 Configuration:

- Probe: EX3DV4 - SN3710; ConvF(6.98, 6.98, 6.98); Calibrated: 12/03/2012;
- Sensor-Surface: 4mm (Mechanical Surface Detection)
- Electronics: DAE4 Sn915; Calibrated: 21/06/2012
- Phantom: SAM2; Type: SAM; Serial: TP1562
- Measurement SW: DASY52, Version 52.8 (1); SEMCAD X Version 14.6.5 (6469)

Configuration/802.11b 2437MHz Body-Back/Area Scan (7x11x1): Measurement grid: dx=15mm, dy=15mm, Maximum value of SAR (measured) = 0.0133 mW/g

Configuration/802.11b 2437MHz Body-Back/Zoom Scan (5x5x7)/Cube 0: Measurement grid: dx=8mm, dy=8mm, dz=5mm, Reference Value = 1.490 V/m; Power Drift = -0.16 dB

Peak SAR (extrapolated) = 0.024 mW/g

SAR(1 g) = 0.015 mW/g; SAR(10 g) = 0.00628 mW/g Maximum value of SAR (measured) = 0.0195 mW/g

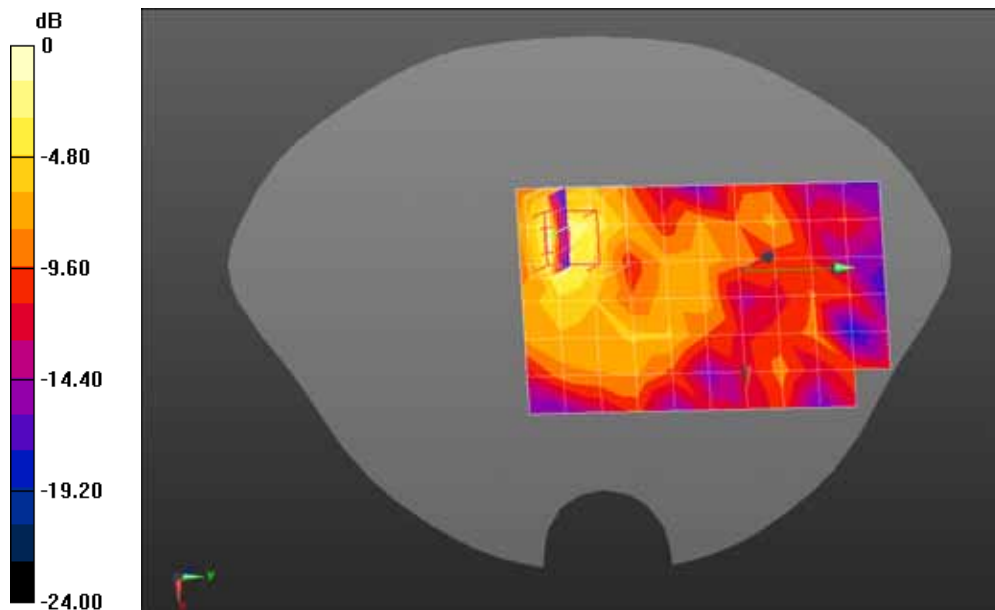

0 dB = 0.0195 mW/g = -34.20 dB mW/g

Z-Axis Plot

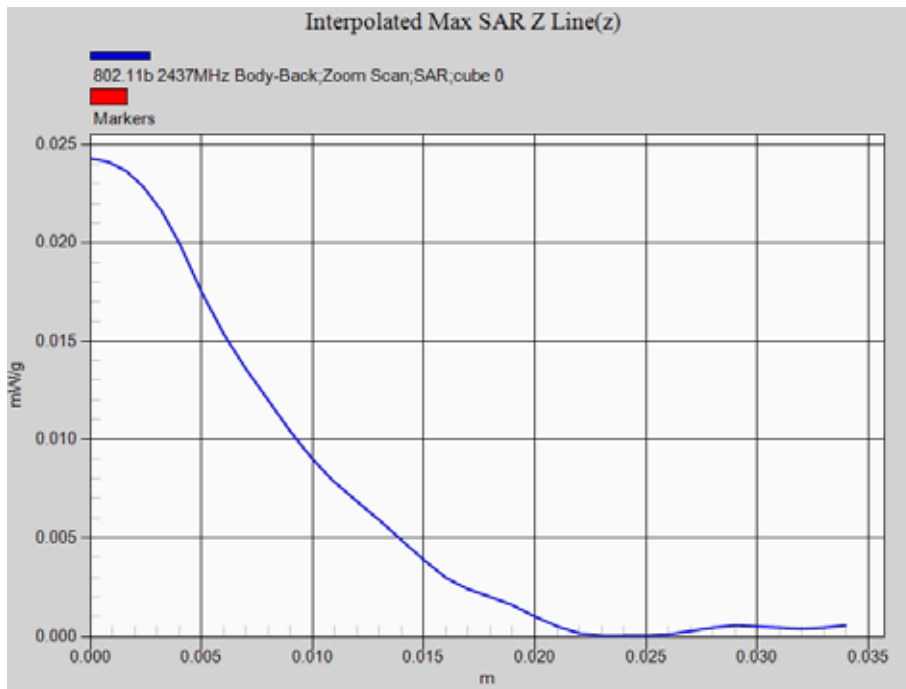

Date/Time: 06-02-2013

Test Laboratory: QuieTek Lab

802.11b 2437MHz Body-Front

DUT: Smartphone ; Type: W5510

Communication System: Wi-Fi; Communication System Band: 802.11b; Duty Cycle: 1:1; Frequency: 2437 MHz; Medium parameters used: $f = 2437$ MHz; $\sigma = 1.89$ mho/m; $\epsilon_r = 53.36$; $\rho = 1000$ kg/m³; Phantom section: Flat Section

Ambient temperature (): 21.5, Liquid temperature (): 21.0

DASY5 Configuration:

- Probe: EX3DV4 - SN3710; ConvF(6.98, 6.98, 6.98); Calibrated: 12/03/2012;
- Sensor-Surface: 4mm (Mechanical Surface Detection)
- Electronics: DAE4 Sn915; Calibrated: 21/06/2012
- Phantom: SAM2; Type: SAM; Serial: TP1562
- Measurement SW: DASY52, Version 52.8 (1); SEMCAD X Version 14.6.5 (6469)

Configuration/802.11b 2437MHz Body-Front/Area Scan (7x11x1): Measurement grid: dx=15mm, dy=15mm, Maximum value of SAR (measured) = 0.00188 mW/g

Configuration/802.11b 2437MHz Body-Front/Zoom Scan (5x5x7)/Cube 0: Measurement grid: dx=8mm, dy=8mm, dz=5mm, Reference Value = 0.352 V/m; Power Drift = 0.16 dB

Peak SAR (extrapolated) = 0.00393 mW/g

SAR(1 g) = 0.000607 mW/g; SAR(10 g) = 9.05e-005 mW/g Maximum value of SAR (measured) = 0.00233 mW/g

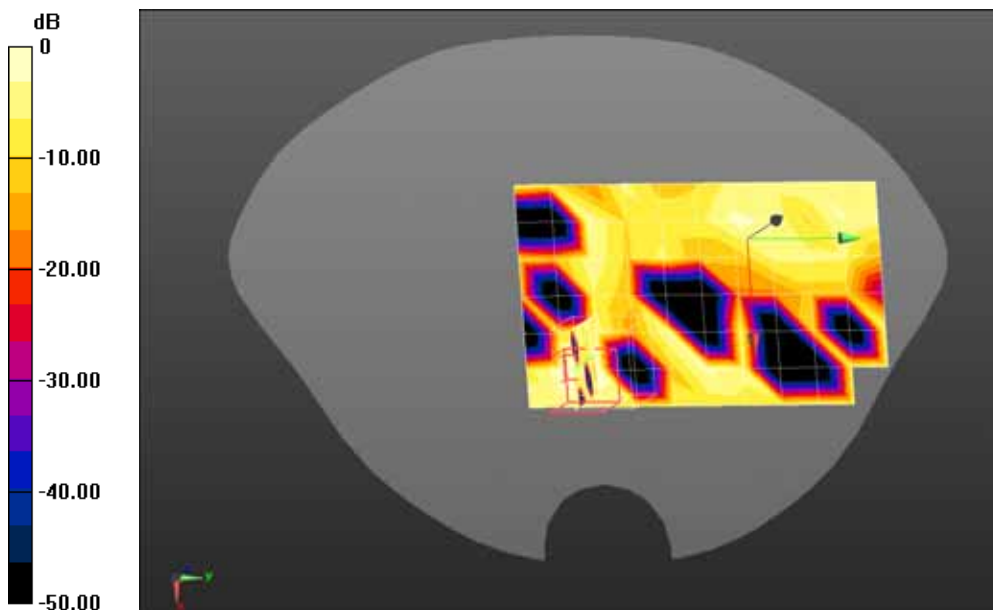

0 dB = 0.00233 mW/g = -52.65 dB mW/g

Date/Time: 06-02-2013

Test Laboratory: QuieTek Lab

802.11b 2437MHz Body-Top

DUT: Smartphone ; Type: W5510

Communication System: Wi-Fi; Communication System Band: 802.11b; Duty Cycle: 1:1; Frequency: 2437 MHz; Medium parameters used: $f = 2437$ MHz; $\sigma = 1.89$ mho/m; $\epsilon_r = 53.36$; $\rho = 1000$ kg/m³; Phantom section: Flat Section

Ambient temperature (): 21.5, Liquid temperature (): 21.0

DASY5 Configuration:

- Probe: EX3DV4 - SN3710; ConvF(6.98, 6.98, 6.98); Calibrated: 12/03/2012;
- Sensor-Surface: 4mm (Mechanical Surface Detection)
- Electronics: DAE4 Sn915; Calibrated: 21/06/2012
- Phantom: SAM2; Type: SAM; Serial: TP1562
- Measurement SW: DASY52, Version 52.8 (1); SEMCAD X Version 14.6.5 (6469)

Configuration/802.11b 2437MHz Body-Top/Area Scan (5x11x1): Measurement grid: dx=15mm, dy=15mm, Maximum value of SAR (measured) = 0.00347 mW/g

Configuration/802.11b 2437MHz Body-Top/Zoom Scan (5x5x7)/Cube 0: Measurement grid: dx=8mm, dy=8mm, dz=5mm, Reference Value = 1.349 V/m; Power Drift = 0.15 dB

Peak SAR (extrapolated) = 0.012 mW/g

SAR(1 g) = 0.00401 mW/g; SAR(10 g) = 0.00148 mW/g Maximum value of SAR (measured) = 0.00438 mW/g

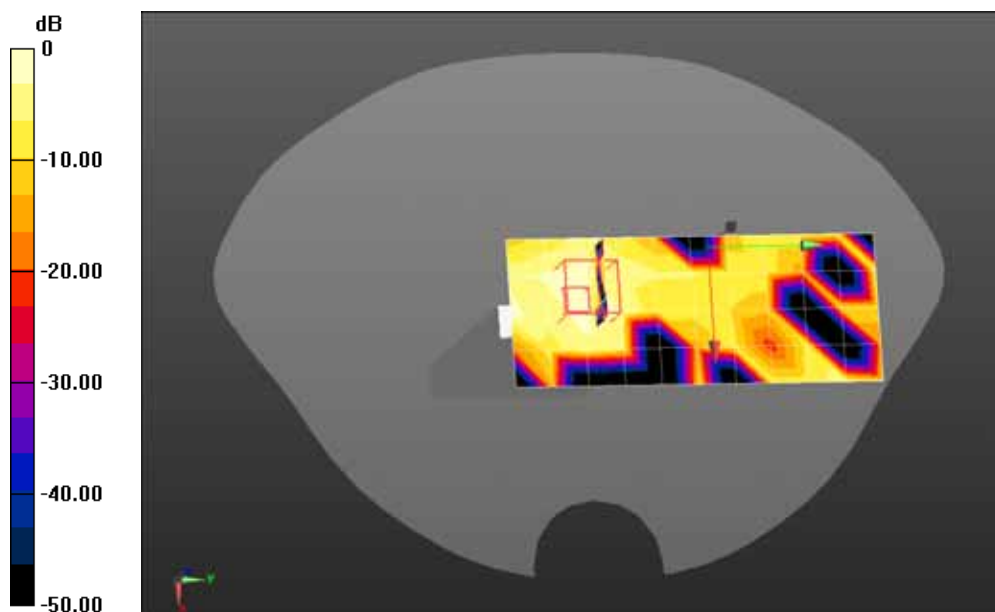

0 dB = 0.00438 mW/g = -47.17 dB mW/g

Date/Time: 06-02-2013

Test Laboratory: QuieTek Lab

802.11b 2437MHz Body-Left side

DUT: Smartphone ; Type: W5510

Communication System: Wi-Fi; Communication System Band: 802.11b; Duty Cycle: 1:1; Frequency: 2437 MHz; Medium parameters used: $f = 2437$ MHz; $\sigma = 1.89$ mho/m; $\epsilon_r = 53.36$; $\rho = 1000$ kg/m³; Phantom section: Flat Section

Ambient temperature (): 21.5, Liquid temperature (): 21.0

DASY5 Configuration:

- Probe: EX3DV4 - SN3710; ConvF(6.98, 6.98, 6.98); Calibrated: 12/03/2012;
- Sensor-Surface: 4mm (Mechanical Surface Detection)
- Electronics: DAE4 Sn915; Calibrated: 21/06/2012
- Phantom: SAM2; Type: SAM; Serial: TP1562
- Measurement SW: DASY52, Version 52.8 (1); SEMCAD X Version 14.6.5 (6469)

Configuration/802.11b 2437MHz Body-Left side/Area Scan (5x11x1): Measurement grid: dx=15mm, dy=15mm, Maximum value of SAR (measured) = 0.00365 mW/g

Configuration/802.11b 2437MHz Body-Left side/Zoom Scan (5x5x7)/Cube 0: Measurement grid: dx=8mm, dy=8mm, dz=5mm, Reference Value = 1.256 V/m; Power Drift = -0.04 dB
Peak SAR (extrapolated) = 0.020 mW/g

SAR(1 g) = 0.00471 mW/g; SAR(10 g) = 0.00146 mW/g Maximum value of SAR (measured) = 0.00515 mW/g

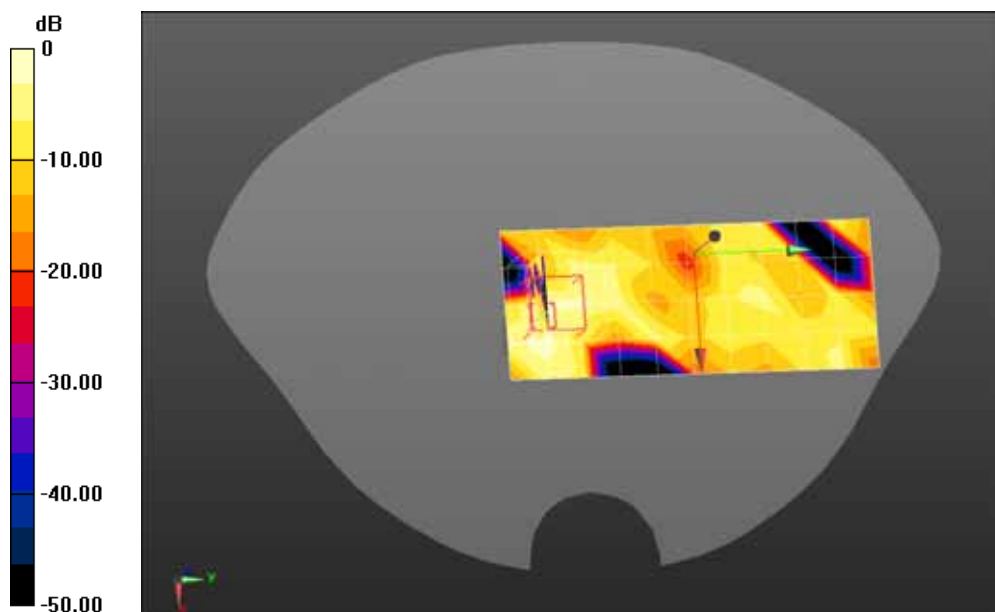

0 dB = 0.00515 mW/g = -45.76 dB mW/g

Appendix C. Test Setup Photographs & EUT Photographs

Test Setup Photographs



Left-Cheek Touch



Left-Tilt 15 °

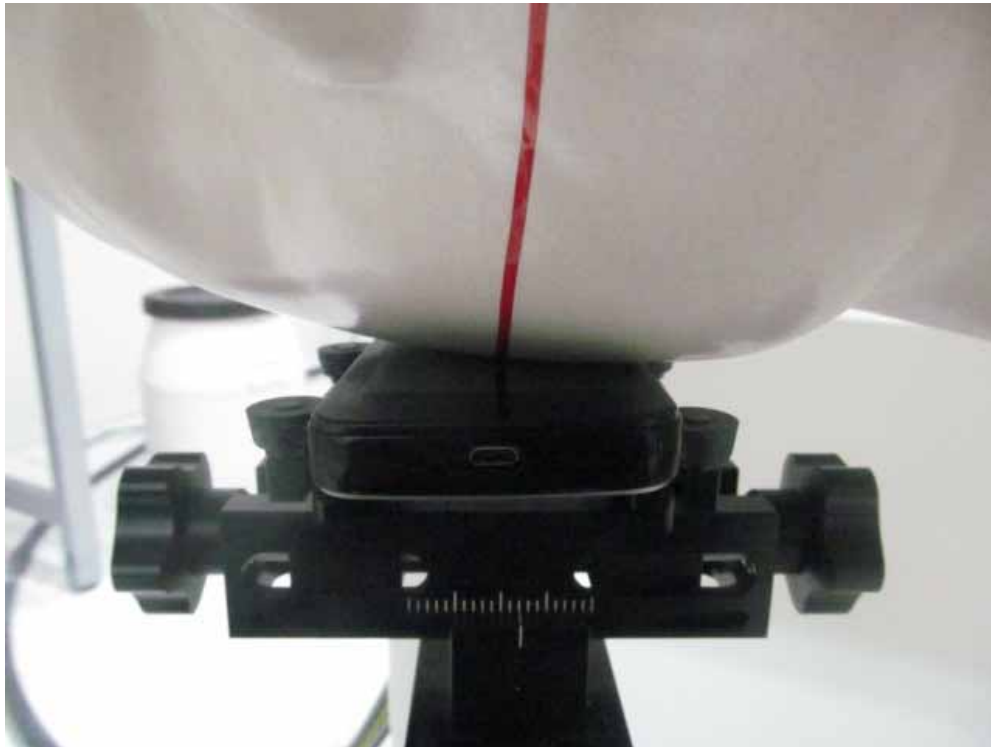

Right-Cheek Touch

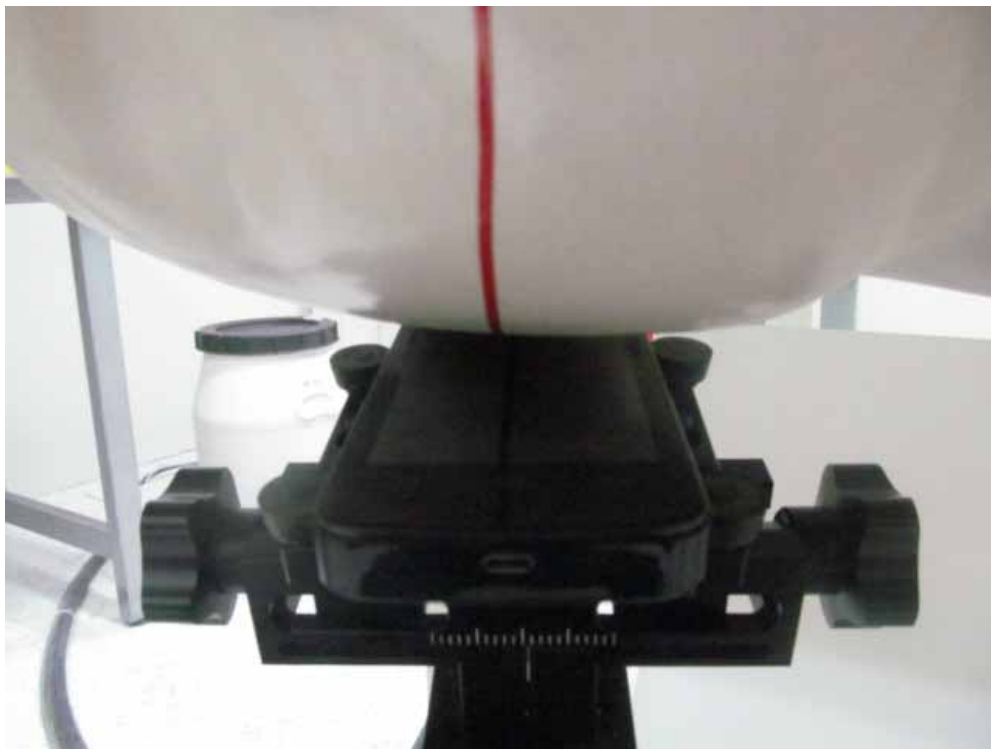

Right-Tilt 15 °

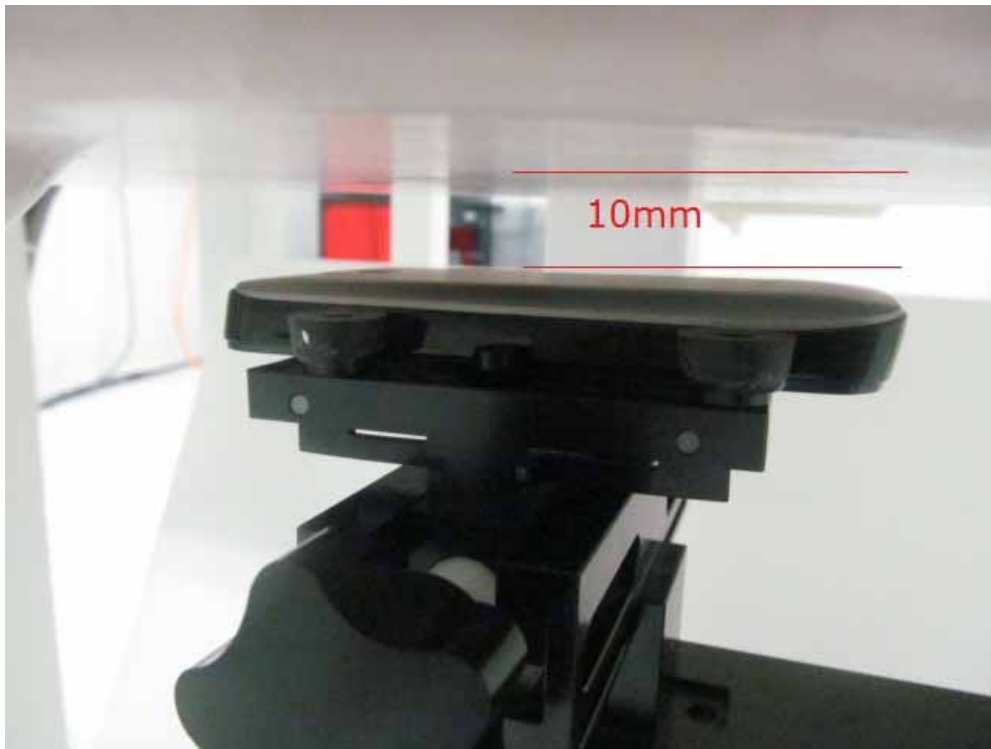

Body SAR Back 10mm

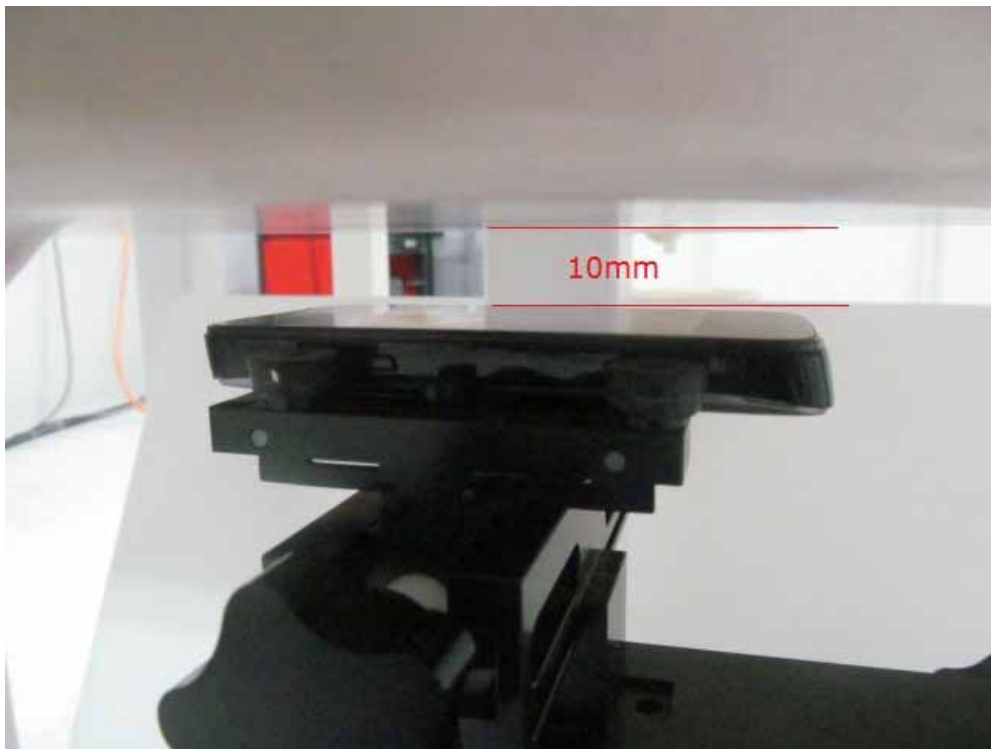

Body SAR Front 10mm

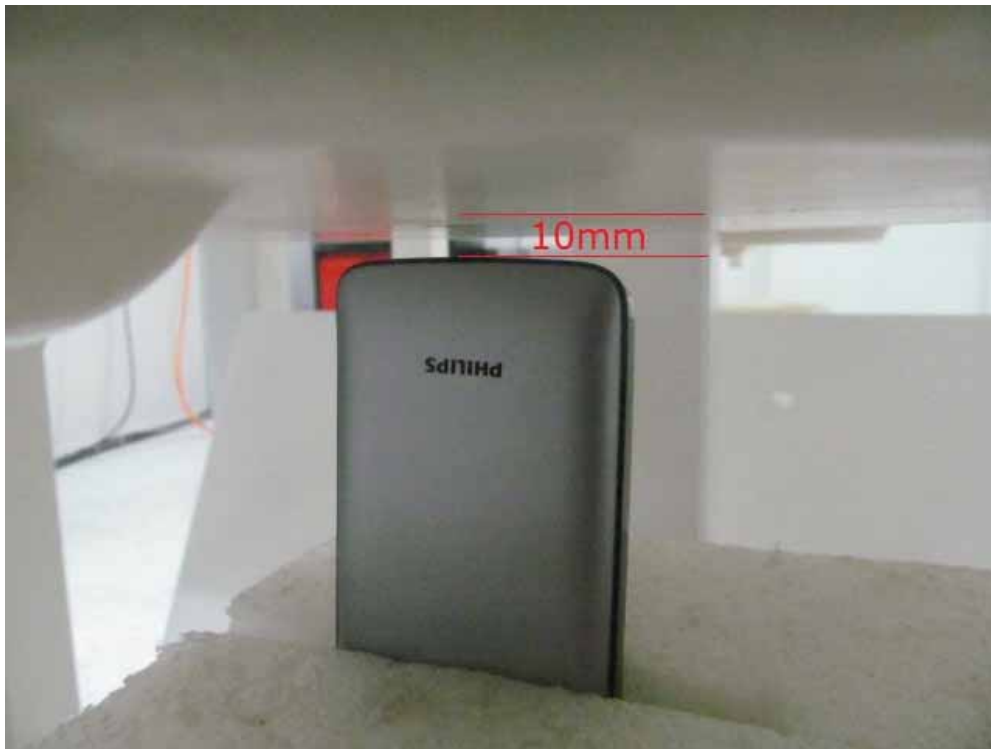

Body SAR Bottom 10mm for GSM/UMTS

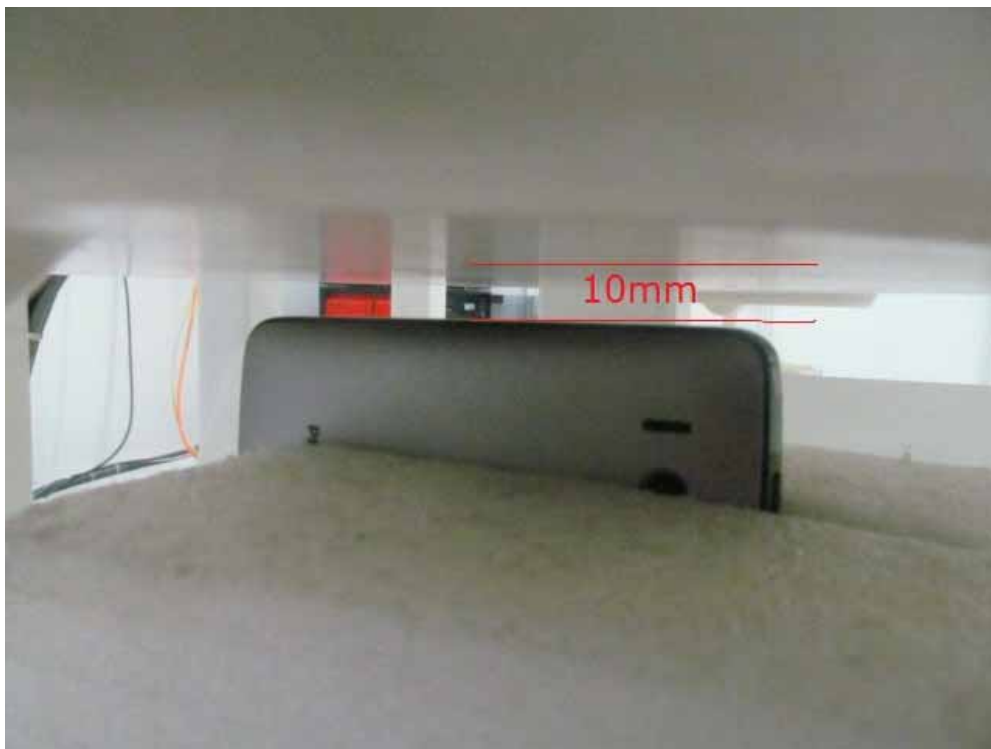

Body SAR Right Side 10mm for GSM/UMTS



Body SAR Left Side 10mm for GSM/UMTS



Body SAR Top 10mm for Wi-Fi



Body SAR Left Side 10mm for Wi-Fi

Depth of the liquid in the phantom – Zoom in

Note: The position used in the measurements were according to IEEE 1528 - 2003

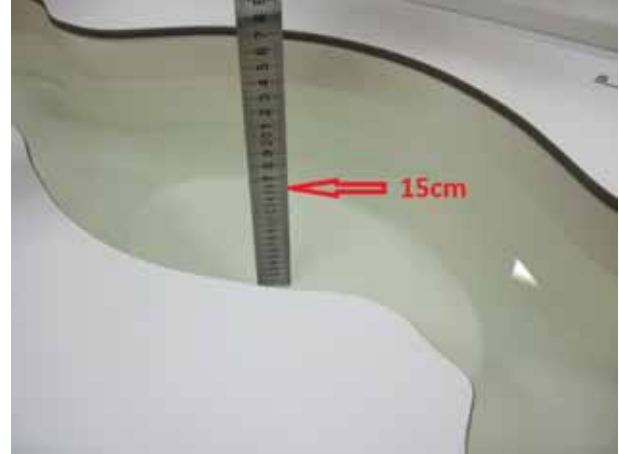
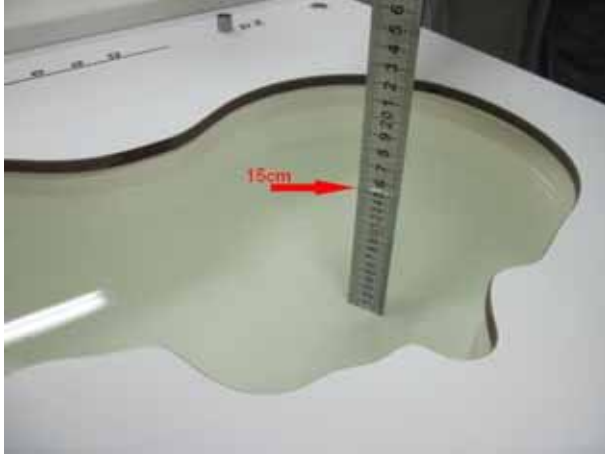

EUT Photographs

(1) EUT Photo



(2) EUT Photo



(3) EUT Photo

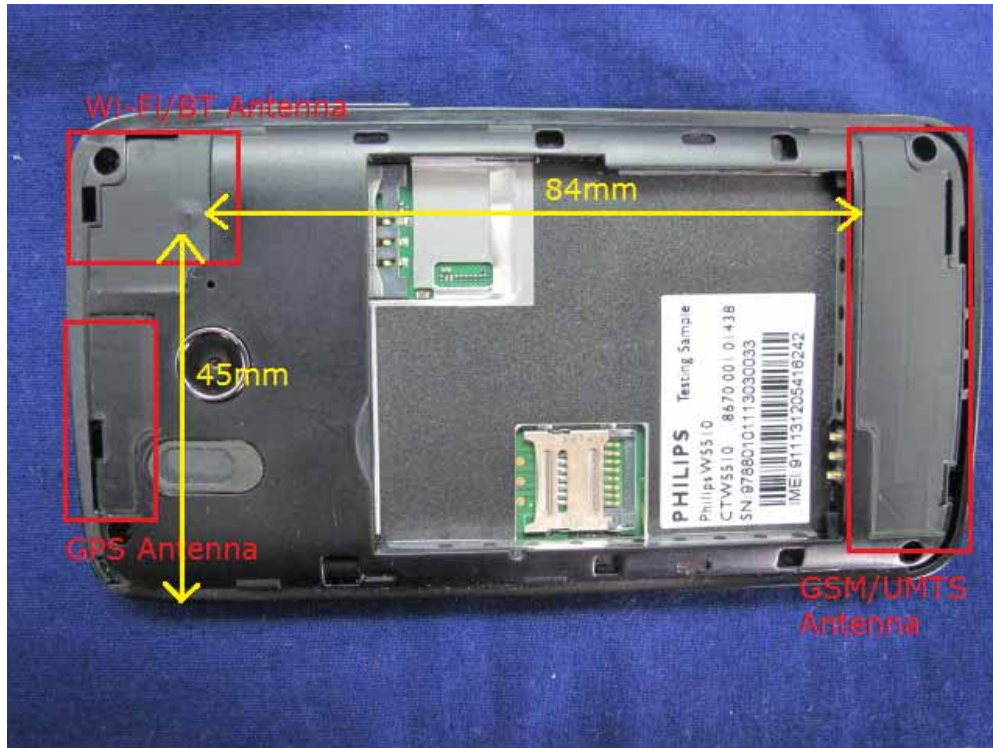

Appendix D. Probe Calibration Data

**Calibration Laboratory of
Schmid & Partner
Engineering AG**
Zeughausstrasse 43, 8004 Zurich, Switzerland



S Schweizerischer Kalibrierdienst
C Service suisse d'étalonnage
S Servizio svizzero di taratura
S Swiss Calibration Service

Accredited by the Swiss Accreditation Service (SAS)
The Swiss Accreditation Service is one of the signatories to the EA
Multilateral Agreement for the recognition of calibration certificates

Accreditation No.: **SCS 108**

Client **Quietek-CN (Auden)**

Certificate No: **EX3-3710_Mar12**

CALIBRATION CERTIFICATE

Object: **EX3DV4 - SN:3710**

Calibration procedure(s): **QA CAL-01.v8, QA CAL-12.v7, QA CAL-14.v3, QA CAL-23.v4, QA CAL-25.v4
Calibration procedure for dosimetric E-field probes**

Calibration date: **March 12, 2012**

This calibration certificate documents the traceability to national standards, which realize the physical units of measurements (SI). The measurements and the uncertainties with confidence probability are given on the following pages and are part of the certificate.

All calibrations have been conducted in the closed laboratory facility: environment temperature (22 ± 3)°C and humidity < 70%.

Calibration Equipment used (M&TE critical for calibration)

Primary Standards	ID	Cal Date (Certificate No.)	Scheduled Calibration
Power meter E4419B	GB41293874	31-Mar-11 (No. 217-01372)	Apr-12
Power sensor E4412A	MY41498087	31-Mar-11 (No. 217-01372)	Apr-12
Reference 3 dB Attenuator	SN: S5054 (3c)	29-Mar-11 (No. 217-01369)	Apr-12
Reference 20 dB Attenuator	SN: S5086 (20b)	29-Mar-11 (No. 217-01367)	Apr-12
Reference 30 dB Attenuator	SN: S5129 (30b)	29-Mar-11 (No. 217-01370)	Apr-12
Reference Probe ES3DV2	SN: 3013	29-Dec-11 (No. ES3-3013_Dec11)	Dec-12
DAE4	SN: 654	3-May-11 (No. DAE4-654_May11)	May-12
Secondary Standards	ID	Check Date (in house)	Scheduled Check
RF generator HP 8648C	US3642U01700	4-Aug-99 (in house check Apr-11)	In house check: Apr-13
Network Analyzer HP 8753E	US37390585	18-Oct-01 (in house check Oct-11)	In house check: Oct-12

	Name	Function	Signature
Calibrated by:	Jeton Kastrati	Laboratory Technician	
Approved by:	Katja Pokovic	Technical Manager	

Issued: March 13, 2012

This calibration certificate shall not be reproduced except in full without written approval of the laboratory.

**Calibration Laboratory of
Schmid & Partner
Engineering AG**
Zeughausstrasse 43, 8004 Zurich, Switzerland



S Schweizerischer Kalibrierdienst
S Service suisse d'étalonnage
S Servizio svizzero di taratura
S Swiss Calibration Service

Accredited by the Swiss Accreditation Service (SAS)

Accreditation No.: **SCS 108**

The Swiss Accreditation Service is one of the signatories to the EA
Multilateral Agreement for the recognition of calibration certificates

Glossary:

TSL	tissue simulating liquid
NORM _{x,y,z}	sensitivity in free space
ConvF	sensitivity in TSL / NORM _{x,y,z}
DCP	diode compression point
CF	crest factor (1/duty_cycle) of the RF signal
A, B, C	modulation dependent linearization parameters
Polarization φ	φ rotation around probe axis
Polarization ϑ	ϑ rotation around an axis that is in the plane normal to probe axis (at measurement center), i.e., $\vartheta = 0$ is normal to probe axis

Calibration is Performed According to the Following Standards:

- IEEE Std 1528-2003, "IEEE Recommended Practice for Determining the Peak Spatial-Averaged Specific Absorption Rate (SAR) in the Human Head from Wireless Communications Devices: Measurement Techniques", December 2003
- IEC 62209-1, "Procedure to measure the Specific Absorption Rate (SAR) for hand-held devices used in close proximity to the ear (frequency range of 300 MHz to 3 GHz)", February 2005

Methods Applied and Interpretation of Parameters:

- NORM_{x,y,z}**: Assessed for E-field polarization $\vartheta = 0$ ($f \leq 900$ MHz in TEM-cell; $f > 1800$ MHz: R22 waveguide). NORM_{x,y,z} are only intermediate values, i.e., the uncertainties of NORM_{x,y,z} does not affect the E²-field uncertainty inside TSL (see below ConvF).
- NORM(f)_{x,y,z} = NORM_{x,y,z} * frequency_response** (see Frequency Response Chart). This linearization is implemented in DASY4 software versions later than 4.2. The uncertainty of the frequency response is included in the stated uncertainty of ConvF.
- DCP_{x,y,z}**: DCP are numerical linearization parameters assessed based on the data of power sweep with CW signal (no uncertainty required). DCP does not depend on frequency nor media.
- PAR**: PAR is the Peak to Average Ratio that is not calibrated but determined based on the signal characteristics
- A_{x,y,z}; B_{x,y,z}; C_{x,y,z}; VR_{x,y,z}; A, B, C** are numerical linearization parameters assessed based on the data of power sweep for specific modulation signal. The parameters do not depend on frequency nor media. VR is the maximum calibration range expressed in RMS voltage across the diode.
- ConvF and Boundary Effect Parameters**: Assessed in flat phantom using E-field (or Temperature Transfer Standard for $f \leq 800$ MHz) and inside waveguide using analytical field distributions based on power measurements for $f > 800$ MHz. The same setups are used for assessment of the parameters applied for boundary compensation (alpha, depth) of which typical uncertainty values are given. These parameters are used in DASY4 software to improve probe accuracy close to the boundary. The sensitivity in TSL corresponds to NORM_{x,y,z} * ConvF whereby the uncertainty corresponds to that given for ConvF. A frequency dependent ConvF is used in DASY version 4.4 and higher which allows extending the validity from ± 50 MHz to ± 100 MHz.
- Spherical isotropy (3D deviation from isotropy)**: in a field of low gradients realized using a flat phantom exposed by a patch antenna.
- Sensor Offset**: The sensor offset corresponds to the offset of virtual measurement center from the probe tip (on probe axis). No tolerance required.

EX3DV4 – SN:3710

March 12, 2012

Probe EX3DV4

SN:3710

Manufactured:	July 21, 2009
Repaired:	February 21, 2012
Calibrated:	March 12, 2012

Calibrated for DASY/EASY Systems
(Note: non-compatible with DASY2 system!)

EX3DV4- SN:3710

March 12, 2012

DASY/EASY - Parameters of Probe: EX3DV4 - SN:3710

Basic Calibration Parameters

	Sensor X	Sensor Y	Sensor Z	Unc (k=2)
Norm ($\mu\text{V}/(\text{V}/\text{m})^2$) ^A	0.51	0.56	0.44	$\pm 10.1 \%$
DCP (mV) ^B	101.3	98.9	100.9	

Modulation Calibration Parameters

UID	Communication System Name	PAR		A dB	B dB	C dB	VR mV	Unc ^E (k=2)
10000	CW	0.00	X	0.00	0.00	1.00	114.4	$\pm 2.2 \%$
			Y	0.00	0.00	1.00	94.4	
			Z	0.00	0.00	1.00	114.2	

The reported uncertainty of measurement is stated as the standard uncertainty of measurement multiplied by the coverage factor k=2, which for a normal distribution corresponds to a coverage probability of approximately 95%.

^A The uncertainties of NormX,Y,Z do not affect the E²-field uncertainty inside TSL (see Pages 5 and 6).

^B Numerical linearization parameter: uncertainty not required.

^E Uncertainty is determined using the max. deviation from linear response applying rectangular distribution and is expressed for the square of the field value.

DASY/EASY - Parameters of Probe: EX3DV4 - SN:3710

Calibration Parameter Determined in Head Tissue Simulating Media

f (MHz) ^C	Relative Permittivity ^F	Conductivity (S/m) ^F	ConvF X	ConvF Y	ConvF Z	Alpha	Depth (mm)	Unct. (k=2)
450	43.5	0.87	9.61	9.61	9.61	0.12	1.00	± 13.4 %
750	41.9	0.89	9.51	9.51	9.51	0.24	1.16	± 12.0 %
835	41.5	0.90	9.18	9.18	9.18	0.22	1.15	± 12.0 %
900	41.5	0.97	8.97	8.97	8.97	0.19	1.35	± 12.0 %
1810	40.0	1.40	8.32	8.32	8.32	0.79	0.60	± 12.0 %
1900	40.0	1.40	8.16	8.16	8.16	0.72	0.66	± 12.0 %
2450	39.2	1.80	7.25	7.25	7.25	0.36	0.91	± 12.0 %
2600	39.0	1.96	6.96	6.96	6.96	0.39	0.95	± 12.0 %
3500	37.9	2.91	6.80	6.80	6.80	0.33	1.09	± 13.1 %
5200	36.0	4.66	5.21	5.21	5.21	0.35	1.80	± 13.1 %
5500	35.6	4.96	4.95	4.95	4.95	0.35	1.80	± 13.1 %
5800	35.3	5.27	4.56	4.56	4.56	0.45	1.80	± 13.1 %

^C Frequency validity of ± 100 MHz only applies for DASY v4.4 and higher (see Page 2), else it is restricted to ± 50 MHz. The uncertainty is the RSS of the ConvF uncertainty at calibration frequency and the uncertainty for the indicated frequency band.

^F At frequencies below 3 GHz, the validity of tissue parameters (ϵ and σ) can be relaxed to ± 10% if liquid compensation formula is applied to measured SAR values. At frequencies above 3 GHz, the validity of tissue parameters (ϵ and σ) is restricted to ± 5%. The uncertainty is the RSS of the ConvF uncertainty for indicated target tissue parameters.

EX3DV4--SN:3710

March 12, 2012

DASY/EASY - Parameters of Probe: EX3DV4 - SN:3710

Calibration Parameter Determined in Body Tissue Simulating Media

f (MHz) ^C	Relative Permittivity ^F	Conductivity (S/m) ^F	ConvF X	ConvF Y	ConvF Z	Alpha	Depth (mm)	Unct. (k=2)
450	56.7	0.94	10.69	10.69	10.69	0.06	1.00	± 13.4 %
750	55.5	0.96	9.33	9.33	9.33	0.43	0.86	± 12.0 %
835	55.2	0.97	9.13	9.13	9.13	0.63	0.70	± 12.0 %
900	55.0	1.05	9.04	9.04	9.04	0.39	0.88	± 12.0 %
1810	53.3	1.52	7.73	7.73	7.73	0.33	1.10	± 12.0 %
1900	53.3	1.52	7.43	7.43	7.43	0.42	0.90	± 12.0 %
2450	52.7	1.95	6.98	6.98	6.98	0.79	0.59	± 12.0 %
2600	52.5	2.16	6.68	6.68	6.68	0.79	0.52	± 12.0 %
3500	51.3	3.31	6.23	6.23	6.23	0.36	1.13	± 13.1 %
5200	49.0	5.30	4.20	4.20	4.20	0.50	1.90	± 13.1 %
5500	48.6	5.65	3.82	3.82	3.82	0.50	1.90	± 13.1 %
5800	48.2	6.00	3.89	3.89	3.89	0.60	1.90	± 13.1 %

^C Frequency validity of ± 100 MHz only applies for DASY v4.4 and higher (see Page 2), else it is restricted to ± 50 MHz. The uncertainty is the RSS of the ConvF uncertainty at calibration frequency and the uncertainty for the indicated frequency band.

^F At frequencies below 3 GHz, the validity of tissue parameters (ϵ and σ) can be relaxed to ± 10% if liquid compensation formula is applied to measured SAR values. At frequencies above 3 GHz, the validity of tissue parameters (ϵ and σ) is restricted to ± 5%. The uncertainty is the RSS of the ConvF uncertainty for indicated target tissue parameters.

EX3DV4- SN:3710

March 12, 2012

Frequency Response of E-Field (TEM-Cell:ifi110 EXX, Waveguide: R22)

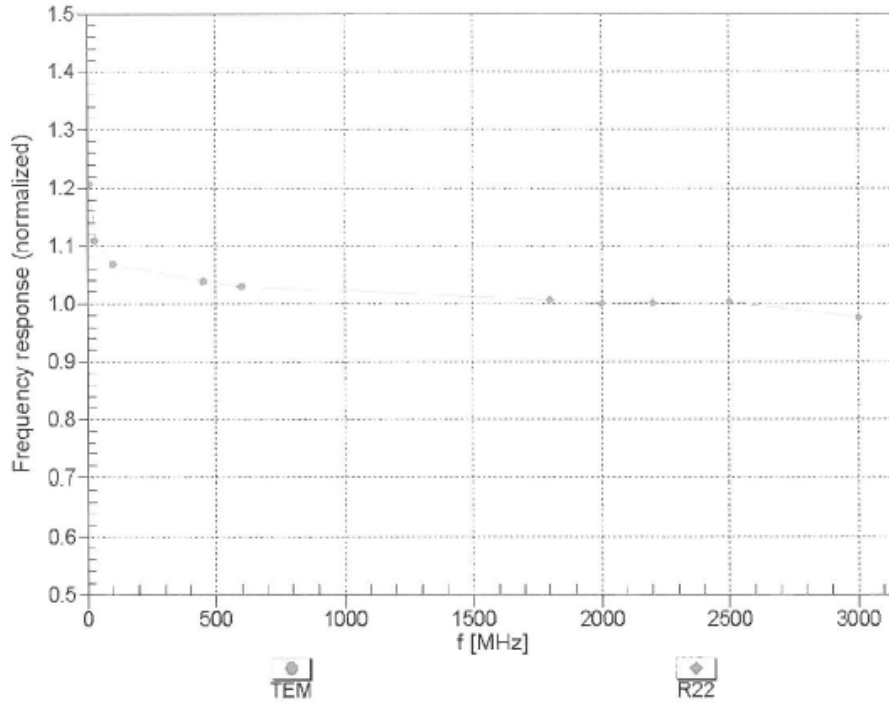

Uncertainty of Frequency Response of E-field: $\pm 6.3\%$ (k=2)

EX3DV4- SN:3710

March 12, 2012

Receiving Pattern (ϕ), $\vartheta = 0^\circ$

f=600 MHz,TEM

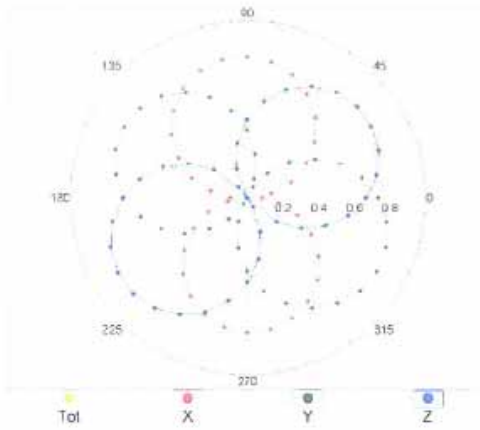

f=1800 MHz,R22

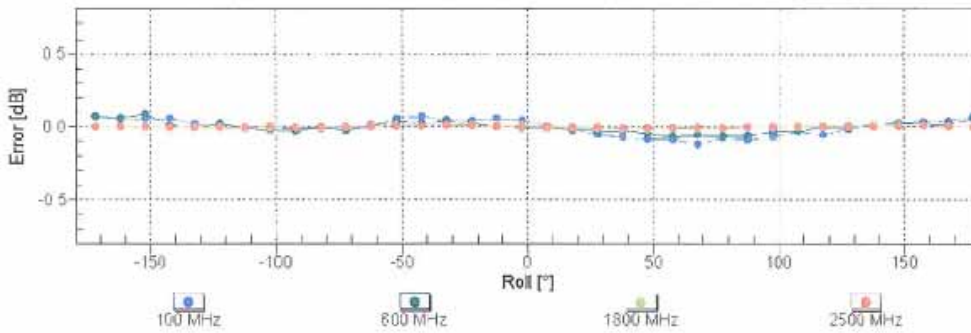
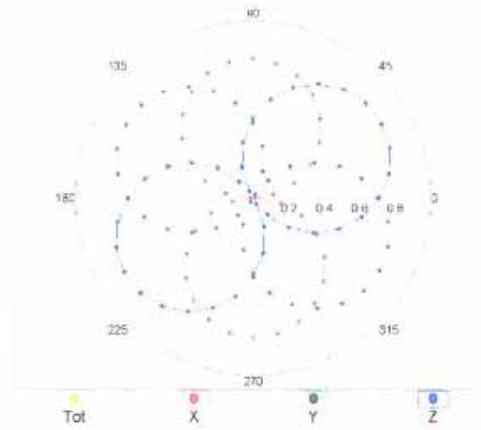

Uncertainty of Axial Isotropy Assessment: $\pm 0.5\%$ (k=2)

EX3DV4-- SN:3710

March 12, 2012

Dynamic Range f(SAR_{head}) (TEM cell , f = 900 MHz)

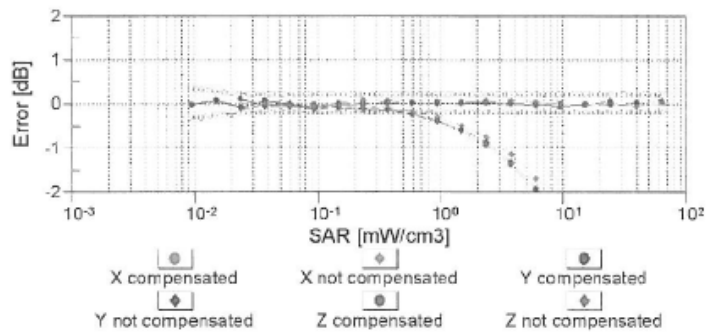
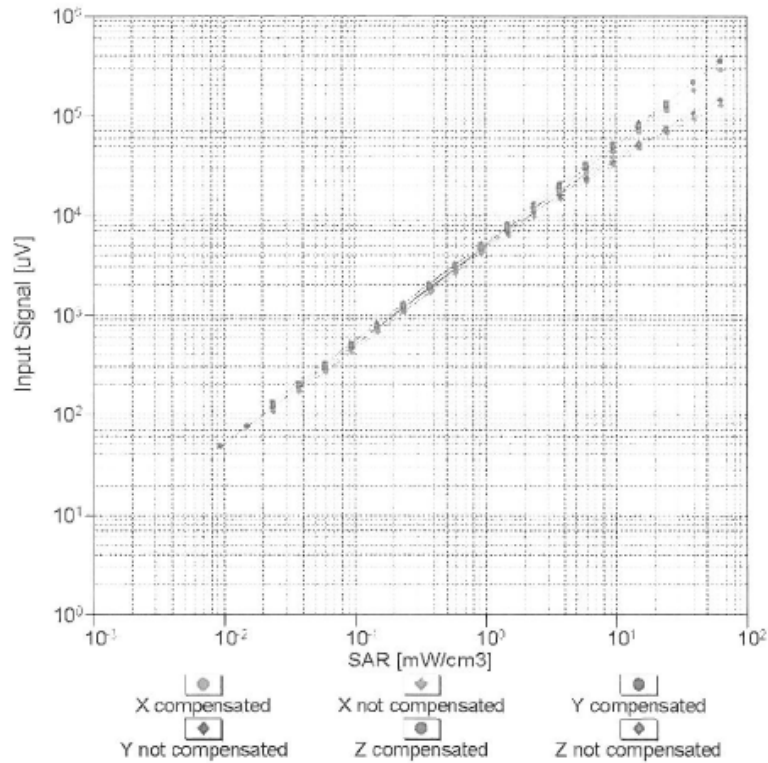

Uncertainty of Linearity Assessment: ± 0.6% (k=2)

EX3DV4-SN:3710

March 12, 2012

Conversion Factor Assessment

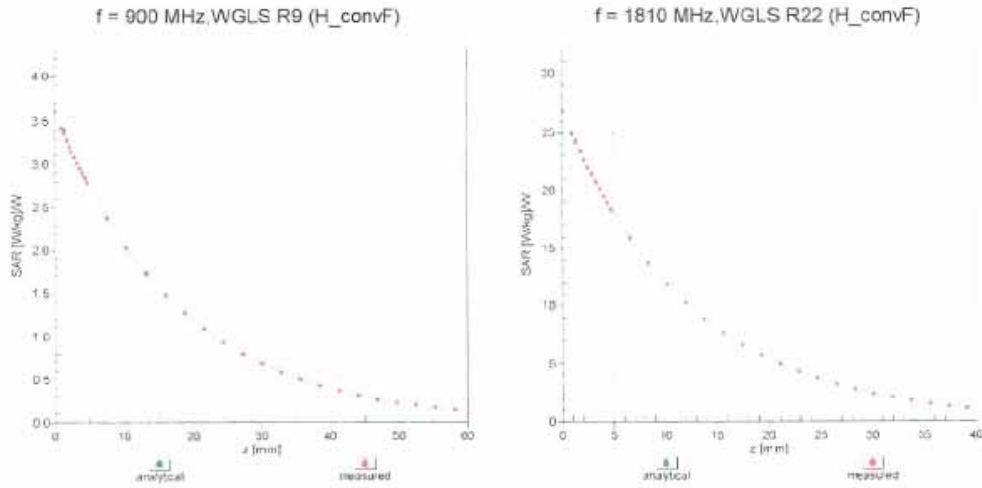

Deviation from Isotropy in Liquid Error (ϕ, θ), f = 900 MHz

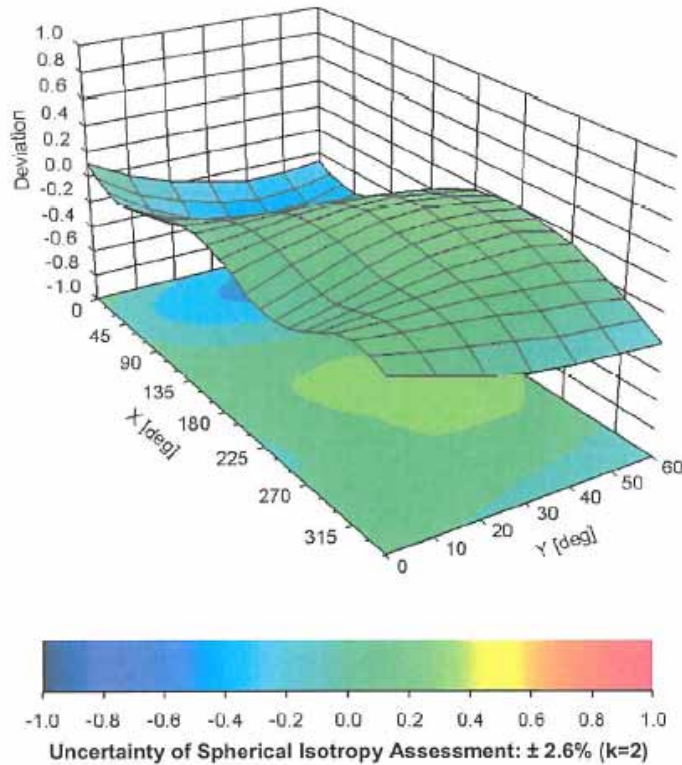

EX3DV4- SN:3710

March 12, 2012

DASY/EASY - Parameters of Probe: EX3DV4 - SN:3710

Other Probe Parameters

Sensor Arrangement	Triangular
Connector Angle (°)	Not applicable
Mechanical Surface Detection Mode	enabled
Optical Surface Detection Mode	disabled
Probe Overall Length	337 mm
Probe Body Diameter	10 mm
Tip Length	9 mm
Tip Diameter	2.5 mm
Probe Tip to Sensor X Calibration Point	1 mm
Probe Tip to Sensor Y Calibration Point	1 mm
Probe Tip to Sensor Z Calibration Point	1 mm
Recommended Measurement Distance from Surface	2 mm

Appendix E. Dipole Calibration Data

**Calibration Laboratory of
Schmid & Partner
Engineering AG**
Zeughausstrasse 43, 8004 Zurich, Switzerland



S Schweizerischer Kalibrierdienst
S Service suisse d'étalonnage
C Servizio svizzero di taratura
S Swiss Calibration Service

Accredited by the Swiss Accreditation Service (SAS)
The Swiss Accreditation Service is one of the signatories to the EA
Multilateral Agreement for the recognition of calibration certificates

Accreditation No.: **SCS 108**

Client: **Quietek-CN (Auden)**

Certificate No: **D835V2-4d094_Feb12**

CALIBRATION CERTIFICATE																																															
Objekt	D835V2 - SN: 4d094																																														
Calibration procedure(s)	QA CAL-05.v8 Calibration procedure for dipole validation kits above 700 MHz																																														
Calibration date:	February 17, 2012																																														
<p>This calibration certificate documents the traceability to national standards, which realize the physical units of measurements (SI). The measurements and the uncertainties with confidence probability are given on the following pages and are part of the certificate.</p> <p>All calibrations have been conducted in the closed laboratory facility; environment temperature (22 ± 3)°C and humidity < 70%.</p> <p>Calibration Equipment used (M&TE critical for calibration)</p> <table border="1"> <thead> <tr> <th>Primary Standards</th> <th>ID #</th> <th>Cal Date (Certificate No.)</th> <th>Scheduled Calibration</th> </tr> </thead> <tbody> <tr> <td>Power meter EPM-442A</td> <td>GB37480704</td> <td>05-Oct-11 (No. 217-01451)</td> <td>Oct-12</td> </tr> <tr> <td>Power sensor HP 8481A</td> <td>US37292783</td> <td>05-Oct-11 (No. 217-01451)</td> <td>Oct-12</td> </tr> <tr> <td>Reference 20 dB Attenuator</td> <td>SN: 5086 (20g)</td> <td>29-Mar-11 (No. 217-01368)</td> <td>Apr-12</td> </tr> <tr> <td>Type-N mismatch combination</td> <td>SN: 5047.2 / 06327</td> <td>29-Mar-11 (No. 217-01371)</td> <td>Apr-12</td> </tr> <tr> <td>Reference Probe ES3DV3</td> <td>SN: 3205</td> <td>30-Dec-11 (No. ES3-3205_Dec11)</td> <td>Dec-12</td> </tr> <tr> <td>DAE4</td> <td>SN: 601</td> <td>04-Jul-11 (No. DAE4-601_Jul11)</td> <td>Jul-12</td> </tr> </tbody> </table> <table border="1"> <thead> <tr> <th>Secondary Standards</th> <th>ID #</th> <th>Check Date (in house)</th> <th>Scheduled Check</th> </tr> </thead> <tbody> <tr> <td>Power sensor HP 8481A</td> <td>MY41092317</td> <td>18-Oct-02 (in house check Oct-11)</td> <td>In house check: Oct-13</td> </tr> <tr> <td>RF generator R&S SMT-06</td> <td>100005</td> <td>04-Aug-99 (in house check Oct-11)</td> <td>In house check: Oct-13</td> </tr> <tr> <td>Network Analyzer HP 8753E</td> <td>US37390585 S4206</td> <td>18-Oct-01 (in house check Oct-11)</td> <td>In house check: Oct-12</td> </tr> </tbody> </table>				Primary Standards	ID #	Cal Date (Certificate No.)	Scheduled Calibration	Power meter EPM-442A	GB37480704	05-Oct-11 (No. 217-01451)	Oct-12	Power sensor HP 8481A	US37292783	05-Oct-11 (No. 217-01451)	Oct-12	Reference 20 dB Attenuator	SN: 5086 (20g)	29-Mar-11 (No. 217-01368)	Apr-12	Type-N mismatch combination	SN: 5047.2 / 06327	29-Mar-11 (No. 217-01371)	Apr-12	Reference Probe ES3DV3	SN: 3205	30-Dec-11 (No. ES3-3205_Dec11)	Dec-12	DAE4	SN: 601	04-Jul-11 (No. DAE4-601_Jul11)	Jul-12	Secondary Standards	ID #	Check Date (in house)	Scheduled Check	Power sensor HP 8481A	MY41092317	18-Oct-02 (in house check Oct-11)	In house check: Oct-13	RF generator R&S SMT-06	100005	04-Aug-99 (in house check Oct-11)	In house check: Oct-13	Network Analyzer HP 8753E	US37390585 S4206	18-Oct-01 (in house check Oct-11)	In house check: Oct-12
Primary Standards	ID #	Cal Date (Certificate No.)	Scheduled Calibration																																												
Power meter EPM-442A	GB37480704	05-Oct-11 (No. 217-01451)	Oct-12																																												
Power sensor HP 8481A	US37292783	05-Oct-11 (No. 217-01451)	Oct-12																																												
Reference 20 dB Attenuator	SN: 5086 (20g)	29-Mar-11 (No. 217-01368)	Apr-12																																												
Type-N mismatch combination	SN: 5047.2 / 06327	29-Mar-11 (No. 217-01371)	Apr-12																																												
Reference Probe ES3DV3	SN: 3205	30-Dec-11 (No. ES3-3205_Dec11)	Dec-12																																												
DAE4	SN: 601	04-Jul-11 (No. DAE4-601_Jul11)	Jul-12																																												
Secondary Standards	ID #	Check Date (in house)	Scheduled Check																																												
Power sensor HP 8481A	MY41092317	18-Oct-02 (in house check Oct-11)	In house check: Oct-13																																												
RF generator R&S SMT-06	100005	04-Aug-99 (in house check Oct-11)	In house check: Oct-13																																												
Network Analyzer HP 8753E	US37390585 S4206	18-Oct-01 (in house check Oct-11)	In house check: Oct-12																																												
Calibrated by:	Name Israe El-Naouq	Function Laboratory Technician	Signature 																																												
Approved by:	Katja Pokovic	Technical Manager																																													
Issued: February 17, 2012																																															
This calibration certificate shall not be reproduced except in full without written approval of the laboratory.																																															

**Calibration Laboratory of
Schmid & Partner
Engineering AG**
Zeughausstrasse 43, 8004 Zurich, Switzerland



S Schweizerischer Kalibrierdienst
C Service suisse d'étalonnage
S Servizio svizzero di taratura
S Swiss Calibration Service

Accredited by the Swiss Accreditation Service (SAS)
The Swiss Accreditation Service is one of the signatories to the EA
Multilateral Agreement for the recognition of calibration certificates

Accreditation No.: **SCS 108**

Glossary:

TSL	tissue simulating liquid
ConvF	sensitivity in TSL / NORM x,y,z
N/A	not applicable or not measured

Calibration is Performed According to the Following Standards:

- a) IEEE Std 1528-2003, "IEEE Recommended Practice for Determining the Peak Spatial-Averaged Specific Absorption Rate (SAR) in the Human Head from Wireless Communications Devices: Measurement Techniques", December 2003
- b) IEC 62209-1, "Procedure to measure the Specific Absorption Rate (SAR) for hand-held devices used in close proximity to the ear (frequency range of 300 MHz to 3 GHz)", February 2005
- c) Federal Communications Commission Office of Engineering & Technology (FCC OET), "Evaluating Compliance with FCC Guidelines for Human Exposure to Radiofrequency Electromagnetic Fields; Additional Information for Evaluating Compliance of Mobile and Portable Devices with FCC Limits for Human Exposure to Radiofrequency Emissions", Supplement C (Edition 01-01) to Bulletin 65

Additional Documentation:

- d) DASY4/5 System Handbook

Methods Applied and Interpretation of Parameters:

- *Measurement Conditions:* Further details are available from the Validation Report at the end of the certificate. All figures stated in the certificate are valid at the frequency indicated.
- *Antenna Parameters with TSL:* The dipole is mounted with the spacer to position its feed point exactly below the center marking of the flat phantom section, with the arms oriented parallel to the body axis.
- *Feed Point Impedance and Return Loss:* These parameters are measured with the dipole positioned under the liquid filled phantom. The impedance stated is transformed from the measurement at the SMA connector to the feed point. The Return Loss ensures low reflected power. No uncertainty required.
- *Electrical Delay:* One-way delay between the SMA connector and the antenna feed point. No uncertainty required.
- *SAR measured:* SAR measured at the stated antenna input power.
- *SAR normalized:* SAR as measured, normalized to an input power of 1 W at the antenna connector.
- *SAR for nominal TSL parameters:* The measured TSL parameters are used to calculate the nominal SAR result.

Measurement Conditions

DASY system configuration, as far as not given on page 1.

DASY Version	DASY5	V52.8.0
Extrapolation	Advanced Extrapolation	
Phantom	Modular Flat Phantom	
Distance Dipole Center - TSL	15 mm	with Spacer
Zoom Scan Resolution	dx, dy, dz = 5 mm	
Frequency	835 MHz ± 1 MHz	

Head TSL parameters

The following parameters and calculations were applied.

	Temperature	Permittivity	Conductivity
Nominal Head TSL parameters	22.0 °C	41.5	0.90 mho/m
Measured Head TSL parameters	(22.0 ± 0.2) °C	41.0 ± 6 %	0.89 mho/m ± 6 %
Head TSL temperature change during test	< 0.5 °C	----	----

SAR result with Head TSL

SAR averaged over 1 cm ³ (1 g) of Head TSL	Condition	
SAR measured	250 mW input power	2.34 mW / g
SAR for nominal Head TSL parameters	normalized to 1W	9.41 mW /g ± 17.0 % (k=2)

SAR averaged over 10 cm ³ (10 g) of Head TSL	condition	
SAR measured	250 mW input power	1.53 mW / g
SAR for nominal Head TSL parameters	normalized to 1W	6.15 mW /g ± 16.5 % (k=2)

Body TSL parameters

The following parameters and calculations were applied.

	Temperature	Permittivity	Conductivity
Nominal Body TSL parameters	22.0 °C	55.2	0.97 mho/m
Measured Body TSL parameters	(22.0 ± 0.2) °C	55.7 ± 6 %	1.01 mho/m ± 6 %
Body TSL temperature change during test	< 0.5 °C	----	----

SAR result with Body TSL

SAR averaged over 1 cm ³ (1 g) of Body TSL	Condition	
SAR measured	250 mW input power	2.46 mW / g
SAR for nominal Body TSL parameters	normalized to 1W	9.57 mW / g ± 17.0 % (k=2)

SAR averaged over 10 cm ³ (10 g) of Body TSL	condition	
SAR measured	250 mW input power	1.62 mW / g
SAR for nominal Body TSL parameters	normalized to 1W	6.33 mW / g ± 16.5 % (k=2)

Appendix

Antenna Parameters with Head TSL

Impedance, transformed to feed point	53.5 Ω - 2.0 j Ω
Return Loss	- 28.1 dB

Antenna Parameters with Body TSL

Impedance, transformed to feed point	47.7 Ω - 5.3 j Ω
Return Loss	- 24.5 dB

General Antenna Parameters and Design

Electrical Delay (one direction)	1.387 ns
----------------------------------	----------

After long term use with 100W radiated power, only a slight warming of the dipole near the feedpoint can be measured.

The dipole is made of standard semirigid coaxial cable. The center conductor of the feeding line is directly connected to the second arm of the dipole. The antenna is therefore short-circuited for DC-signals. On some of the dipoles, small end caps are added to the dipole arms in order to improve matching when loaded according to the position as explained in the "Measurement Conditions" paragraph. The SAR data are not affected by this change. The overall dipole length is still according to the Standard.

No excessive force must be applied to the dipole arms, because they might bend or the soldered connections near the feedpoint may be damaged.

Additional EUT Data

Manufactured by	SPEAG
Manufactured on	September 15, 2009

DASY5 Validation Report for Head TSL

Date: 17.02.2012

Test Laboratory: SPEAG, Zurich, Switzerland

DUT: Dipole 835 MHz; Type: D835V2; Serial: D835V2 - SN: 4d094

Communication System: CW; Frequency: 835 MHz

Medium parameters used: $f = 835 \text{ MHz}$; $\sigma = 0.89 \text{ mho/m}$; $\epsilon_r = 41$; $\rho = 1000 \text{ kg/m}^3$

Phantom section: Flat Section

Measurement Standard: DASY5 (IEEE/IEC/ANSI C63.19-2007)

DASY52 Configuration:

- Probe: ES3DV3 - SN3205; ConvF(6.07, 6.07, 6.07); Calibrated: 30.12.2011
- Sensor-Surface: 3mm (Mechanical Surface Detection)
- Electronics: DAE4 Sn601; Calibrated: 04.07.2011
- Phantom: Flat Phantom 4.9L; Type: QD000P49AA; Serial: 1001
- DASY52 52.8.0(692); SEMCAD X 14.6.4(4989)

Dipole Calibration for Head Tissue/Pin=250 mW, d=15mm/Zoom Scan (7x7x7)/Cube 0:

Measurement grid: dx=5mm, dy=5mm, dz=5mm

Reference Value = 57.027 V/m; Power Drift = 0.02 dB

Peak SAR (extrapolated) = 3.4380

SAR(1 g) = 2.34 mW/g; SAR(10 g) = 1.53 mW/g

Maximum value of SAR (measured) = 2.712 mW/g

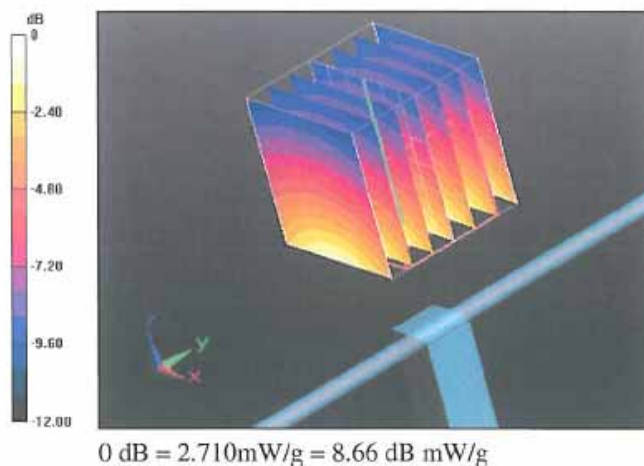

Impedance Measurement Plot for Head TSL

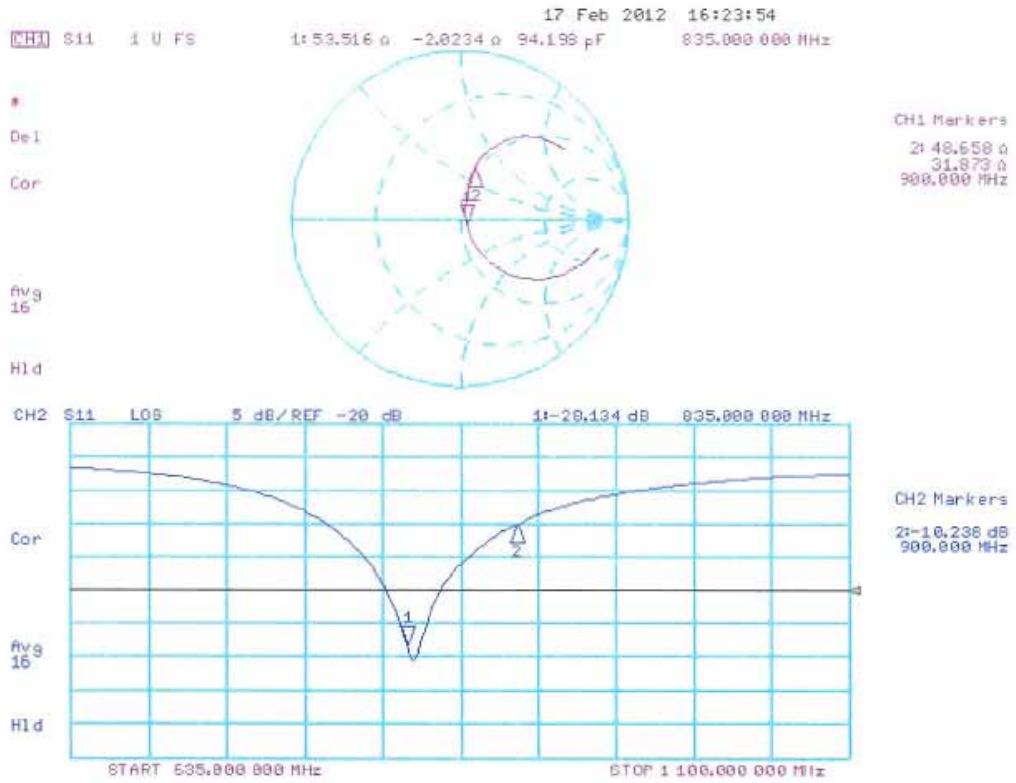

DASY5 Validation Report for Body TSL

Date: 17.02.2012

Test Laboratory: SPEAG, Zurich, Switzerland

DUT: Dipole 835 MHz; Type: D835V2; Serial: D835V2 - SN: 4d094

Communication System: CW; Frequency: 835 MHz

Medium parameters used: $f = 835$ MHz; $\sigma = 1.01$ mho/m; $\epsilon_r = 55.7$; $\rho = 1000$ kg/m³

Phantom section: Flat Section

Measurement Standard: DASY5 (IEEE/IEC/ANSI C63.19-2007)

DASY52 Configuration:

- Probe: ES3DV3 - SN3205; ConvF(6.02, 6.02, 6.02); Calibrated: 30.12.2011
- Sensor-Surface: 3mm (Mechanical Surface Detection)
- Electronics: DAE4 Sn601; Calibrated: 04.07.2011
- Phantom: Flat Phantom 4.9L; Type: QD000P49AA; Serial: 1001
- DASY52 52.8.0(692); SEMCAD X 14.6.4(4989)

Dipole Calibration for Body Tissue/Pin=250 mW, d=15mm/Zoom Scan (7x7x7)/Cube 0:

Measurement grid: dx=5mm, dy=5mm, dz=5mm

Reference Value = 55.114 V/m; Power Drift = 0.0041 dB

Peak SAR (extrapolated) = 3.5590

SAR(1 g) = 2.46 mW/g; SAR(10 g) = 1.62 mW/g

Maximum value of SAR (measured) = 2.861 mW/g

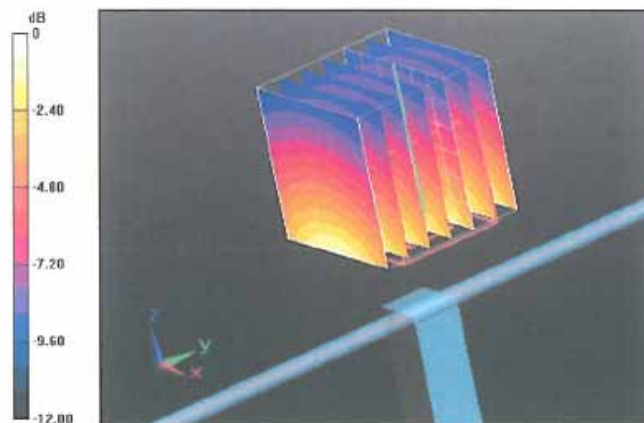

0 dB = 2.860mW/g = 9.13 dB mW/g

Impedance Measurement Plot for Body TSL

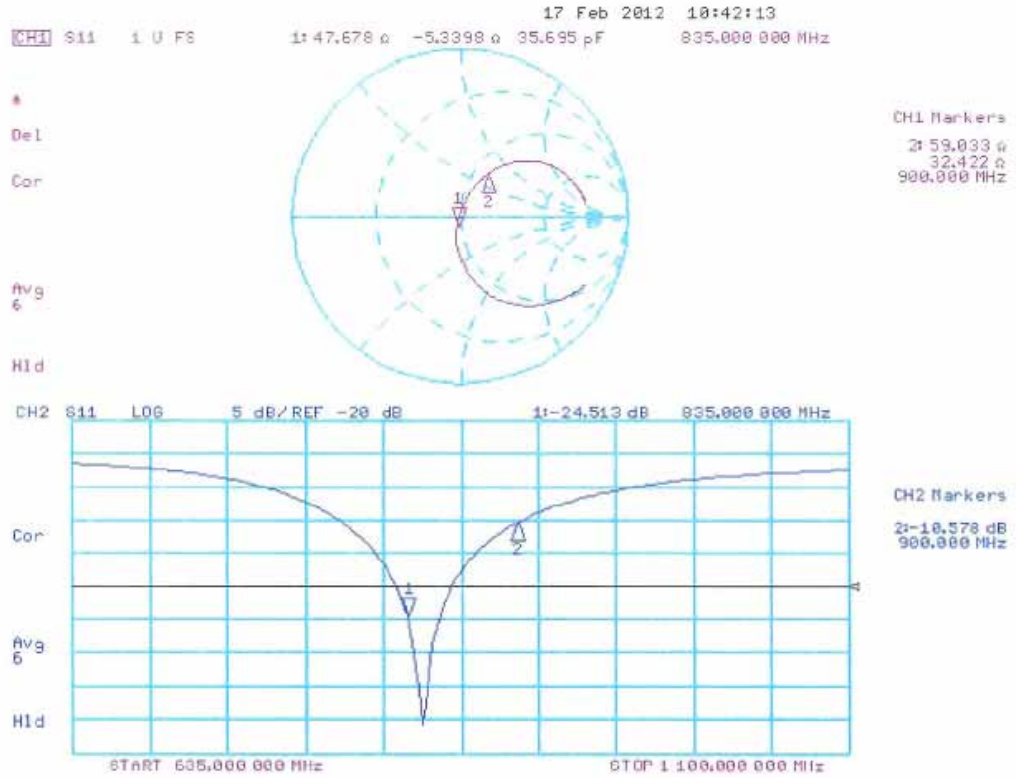

**Calibration Laboratory of
Schmid & Partner
Engineering AG**
Zeughausstrasse 43, 8004 Zurich, Switzerland



S Schweizerischer Kalibrierdienst
C Service suisse d'étalonnage
S Servizio svizzero di taratura
S Swiss Calibration Service

Accredited by the Swiss Accreditation Service (SAS)
The Swiss Accreditation Service is one of the signatories to the EA
Multilateral Agreement for the recognition of calibration certificates

Accreditation No.: **SCS 108**

Client **Quietek-CN (Auden)**

Certificate No: **D1900V2-5d121_Feb12**

CALIBRATION CERTIFICATE

Object **D1900V2 - SN: 5d121**

Calibration procedure(s) **QA CAL-05.v8
Calibration procedure for dipole validation kits above 700 MHz**

Calibration date: **February 22, 2012**

This calibration certificate documents the traceability to national standards, which realize the physical units of measurements (SI).
The measurements and the uncertainties with confidence probability are given on the following pages and are part of the certificate.

All calibrations have been conducted in the closed laboratory facility: environment temperature (22 ± 3)°C and humidity < 70%.

Calibration Equipment used (M&TE critical for calibration)

Primary Standards	ID #	Cal Date (Certificate No.)	Scheduled Calibration
Power meter EPM-442A	GB37480704	05-Oct-11 (No. 217-01451)	Oct-12
Power sensor HP 8481A	US37292783	05-Oct-11 (No. 217-01451)	Oct-12
Reference 20 dB Attenuator	SN: 5086 (20g)	29-Mar-11 (No. 217-01368)	Apr-12
Type-N mismatch combination	SN: 6047.2 / 06327	29-Mar-11 (No. 217-01371)	Apr-12
Reference Probe ES3DV3	SN: 3205	30-Dec-11 (No. ES3-3205_Dec11)	Dec-12
DAE4	SN: 601	04-Jul-11 (No. DAE4-601_Jul11)	Jul-12
Secondary Standards	ID #	Check Date (in house)	Scheduled Check
Power sensor HP 8481A	MY41092317	18-Oct-02 (in house check Oct-11)	In house check: Oct-13
RF generator R&S SMT-06	100005	04-Aug-99 (in house check Oct-11)	In house check: Oct-13
Network Analyzer HP 8753E	US37390585 S4206	18-Oct-01 (in house check Oct-11)	In house check: Oct-12

Calibrated by:	Name	Function	Signature
	Israe El-Nacouq	Laboratory Technician	
Approved by:	Name	Function	Signature
	Katja Pokovic	Technical Manager	

Issued: February 22, 2012

This calibration certificate shall not be reproduced except in full without written approval of the laboratory.

**Calibration Laboratory of
Schmid & Partner
Engineering AG**
Zeughausstrasse 43, 8004 Zurich, Switzerland



S Schweizerischer Kalibrierdienst
C Service suisse d'étalonnage
S Servizio svizzero di taratura
S Swiss Calibration Service

Accredited by the Swiss Accreditation Service (SAS)
The Swiss Accreditation Service is one of the signatories to the EA
Multilateral Agreement for the recognition of calibration certificates

Accreditation No.: **SCS 108**

Glossary:

TSL tissue simulating liquid
ConvF sensitivity in TSL / NORM x,y,z
N/A not applicable or not measured

Calibration is Performed According to the Following Standards:

- a) IEEE Std 1528-2003, "IEEE Recommended Practice for Determining the Peak Spatial-Averaged Specific Absorption Rate (SAR) in the Human Head from Wireless Communications Devices: Measurement Techniques", December 2003
- b) IEC 62209-1, "Procedure to measure the Specific Absorption Rate (SAR) for hand-held devices used in close proximity to the ear (frequency range of 300 MHz to 3 GHz)", February 2005
- c) Federal Communications Commission Office of Engineering & Technology (FCC OET), "Evaluating Compliance with FCC Guidelines for Human Exposure to Radiofrequency Electromagnetic Fields; Additional Information for Evaluating Compliance of Mobile and Portable Devices with FCC Limits for Human Exposure to Radiofrequency Emissions", Supplement C (Edition 01-01) to Bulletin 65

Additional Documentation:

- d) DASY4/5 System Handbook

Methods Applied and Interpretation of Parameters:

- *Measurement Conditions:* Further details are available from the Validation Report at the end of the certificate. All figures stated in the certificate are valid at the frequency indicated.
- *Antenna Parameters with TSL:* The dipole is mounted with the spacer to position its feed point exactly below the center marking of the flat phantom section, with the arms oriented parallel to the body axis.
- *Feed Point Impedance and Return Loss:* These parameters are measured with the dipole positioned under the liquid filled phantom. The impedance stated is transformed from the measurement at the SMA connector to the feed point. The Return Loss ensures low reflected power. No uncertainty required.
- *Electrical Delay:* One-way delay between the SMA connector and the antenna feed point. No uncertainty required.
- *SAR measured:* SAR measured at the stated antenna input power.
- *SAR normalized:* SAR as measured, normalized to an input power of 1 W at the antenna connector.
- *SAR for nominal TSL parameters:* The measured TSL parameters are used to calculate the nominal SAR result.

Measurement Conditions

DASY system configuration, as far as not given on page 1.

DASY Version	DASY5	V52.8.0
Extrapolation	Advanced Extrapolation	
Phantom	Modular Flat Phantom	
Distance Dipole Center - TSL	10 mm	with Spacer
Zoom Scan Resolution	dx, dy, dz = 5 mm	
Frequency	1900 MHz ± 1 MHz	

Head TSL parameters

The following parameters and calculations were applied.

	Temperature	Permittivity	Conductivity
Nominal Head TSL parameters	22.0 °C	40.0	1.40 mho/m
Measured Head TSL parameters	(22.0 ± 0.2) °C	40.4 ± 6 %	1.40 mho/m ± 6 %
Head TSL temperature change during test	< 0.5 °C	----	----

SAR result with Head TSL

SAR averaged over 1 cm ³ (1 g) of Head TSL	Condition	
SAR measured	250 mW input power	9.84 mW / g
SAR for nominal Head TSL parameters	normalized to 1W	39.4 mW / g ± 17.0 % (k=2)

SAR averaged over 10 cm ³ (10 g) of Head TSL	condition	
SAR measured	250 mW input power	5.19 mW / g
SAR for nominal Head TSL parameters	normalized to 1W	20.8 mW / g ± 16.5 % (k=2)

Body TSL parameters

The following parameters and calculations were applied.

	Temperature	Permittivity	Conductivity
Nominal Body TSL parameters	22.0 °C	53.3	1.52 mho/m
Measured Body TSL parameters	(22.0 ± 0.2) °C	53.0 ± 6 %	1.56 mho/m ± 6 %
Body TSL temperature change during test	< 0.5 °C	----	----

SAR result with Body TSL

SAR averaged over 1 cm ³ (1 g) of Body TSL	Condition	
SAR measured	250 mW input power	9.84 mW / g
SAR for nominal Body TSL parameters	normalized to 1W	38.7 mW / g ± 17.0 % (k=2)

SAR averaged over 10 cm ³ (10 g) of Body TSL	condition	
SAR measured	250 mW input power	5.15 mW / g
SAR for nominal Body TSL parameters	normalized to 1W	20.4 mW / g ± 16.5 % (k=2)

Appendix

Antenna Parameters with Head TSL

Impedance, transformed to feed point	51.6 Ω + 7.2 j Ω
Return Loss	- 22.8 dB

Antenna Parameters with Body TSL

Impedance, transformed to feed point	47.4 Ω + 7.4 j Ω
Return Loss	- 21.9 dB

General Antenna Parameters and Design

Electrical Delay (one direction)	1.205 ns
----------------------------------	----------

After long term use with 100W radiated power, only a slight warming of the dipole near the feedpoint can be measured.

The dipole is made of standard semirigid coaxial cable. The center conductor of the feeding line is directly connected to the second arm of the dipole. The antenna is therefore short-circuited for DC-signals. On some of the dipoles, small end caps are added to the dipole arms in order to improve matching when loaded according to the position as explained in the "Measurement Conditions" paragraph. The SAR data are not affected by this change. The overall dipole length is still according to the Standard.

No excessive force must be applied to the dipole arms, because they might bend or the soldered connections near the feedpoint may be damaged.

Additional EUT Data

Manufactured by	SPEAG
Manufactured on	August 25, 2009

DASY5 Validation Report for Head TSL

Date: 22.02.2012

Test Laboratory: SPEAG, Zurich, Switzerland

DUT: Dipole 1900 MHz; Type: D1900V2; Serial: D1900V2 - SN: 5d121

Communication System: CW; Frequency: 1900 MHz

Medium parameters used: $f = 1900$ MHz; $\sigma = 1.4$ mho/m; $\epsilon_r = 40.4$; $\rho = 1000$ kg/m³

Phantom section: Flat Section

Measurement Standard: DASY5 (IEEE/IEC/ANSI C63.19-2007)

DASY52 Configuration:

- Probe: ES3DV3 - SN3205; ConvF(5.01, 5.01, 5.01); Calibrated: 30.12.2011
- Sensor-Surface: 3mm (Mechanical Surface Detection)
- Electronics: DAE4 Sn601; Calibrated: 04.07.2011
- Phantom: Flat Phantom 5.0 (front); Type: QD000P50AA; Serial: 1001
- DASY52 52.8.0(692); SEMCAD X 14.6.4(4989)

Dipole Calibration for Head Tissue/Pin=250 mW, d=10mm/Zoom Scan (7x7x7)/Cube 0:

Measurement grid: dx=5mm, dy=5mm, dz=5mm

Reference Value = 96.900 V/m; Power Drift = 0.04 dB

Peak SAR (extrapolated) = 17.5160

SAR(1 g) = 9.84 mW/g; SAR(10 g) = 5.19 mW/g

Maximum value of SAR (measured) = 12.195 mW/g

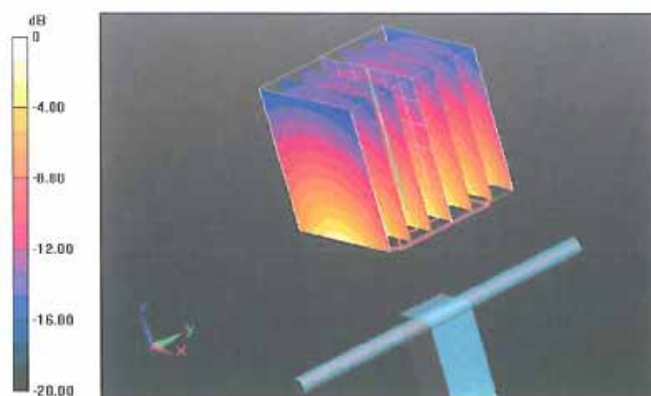

0 dB = 12.200mW/g = 21.73 dB mW/g

Impedance Measurement Plot for Head TSL

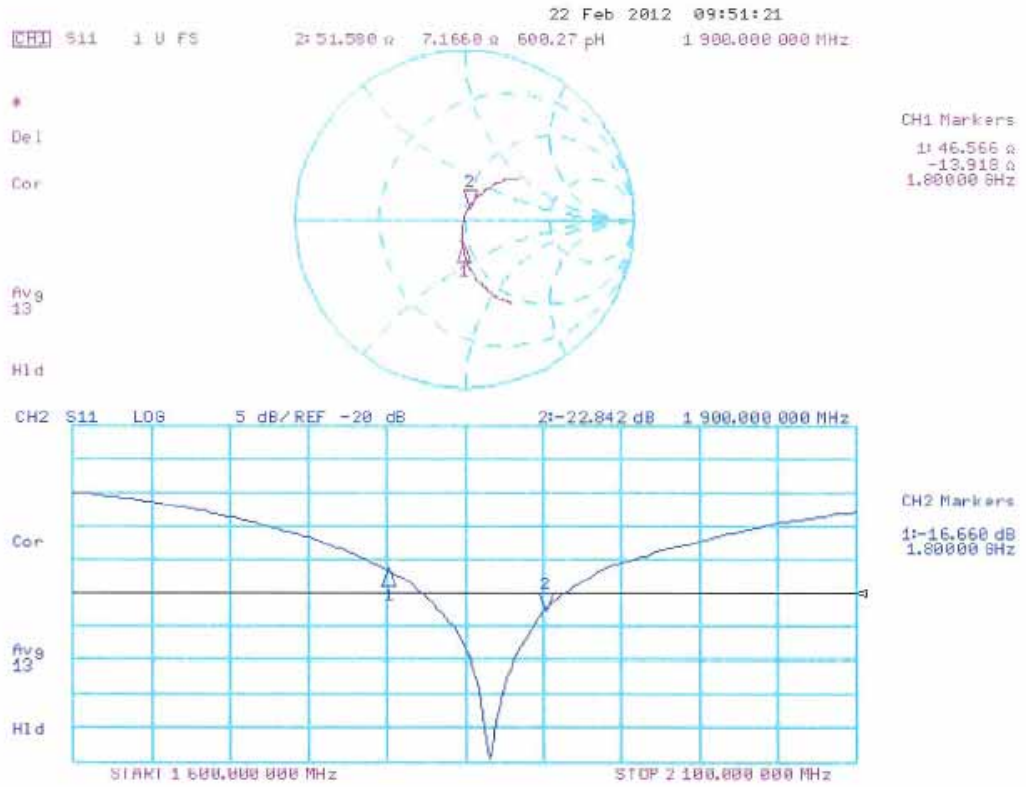

DASY5 Validation Report for Body TSL

Date: 22.02.2012

Test Laboratory: SPEAG, Zurich, Switzerland

DUT: Dipole 1900 MHz; Type: D1900V2; Serial: D1900V2 - SN: 5d121

Communication System: CW; Frequency: 1900 MHz

Medium parameters used: $f = 1900$ MHz; $\sigma = 1.56$ mho/m; $\epsilon_r = 53$; $\rho = 1000$ kg/m³

Phantom section: Flat Section

Measurement Standard: DASY5 (IEEE/IEC/ANSI C63.19-2007)

DASY52 Configuration:

- Probe: ES3DV3 - SN3205; ConvF(4.62, 4.62, 4.62); Calibrated: 30.12.2011
- Sensor-Surface: 3mm (Mechanical Surface Detection)
- Electronics: DAE4 Sn601; Calibrated: 04.07.2011
- Phantom: Flat Phantom 5.0 (back); Type: QD000P50AA; Serial: 1002
- DASY52 52.8.0(692); SEMCAD X 14.6.4(4989)

Dipole Calibration for Body Tissue/Pin=250 mW, d=10mm/Zoom Scan (7x7x7)/Cube 0:

Measurement grid: dx=5mm, dy=5mm, dz=5mm

Reference Value = 93.537 V/m; Power Drift = 0.0039 dB

Peak SAR (extrapolated) = 17.3450

SAR(1 g) = 9.84 mW/g; SAR(10 g) = 5.15 mW/g

Maximum value of SAR (measured) = 12.473 mW/g

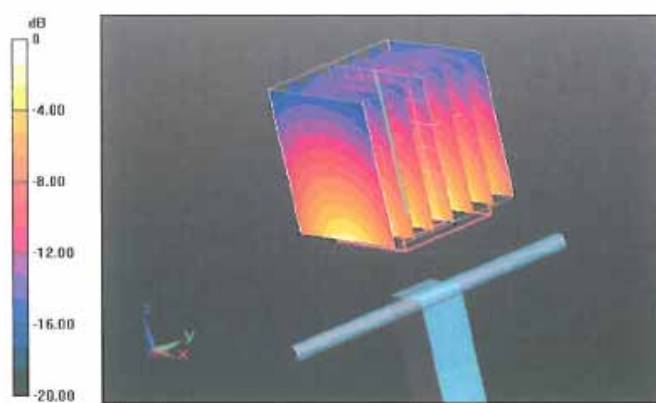

0 dB = 12.470mW/g = 21.92 dB mW/g

Impedance Measurement Plot for Body TSL

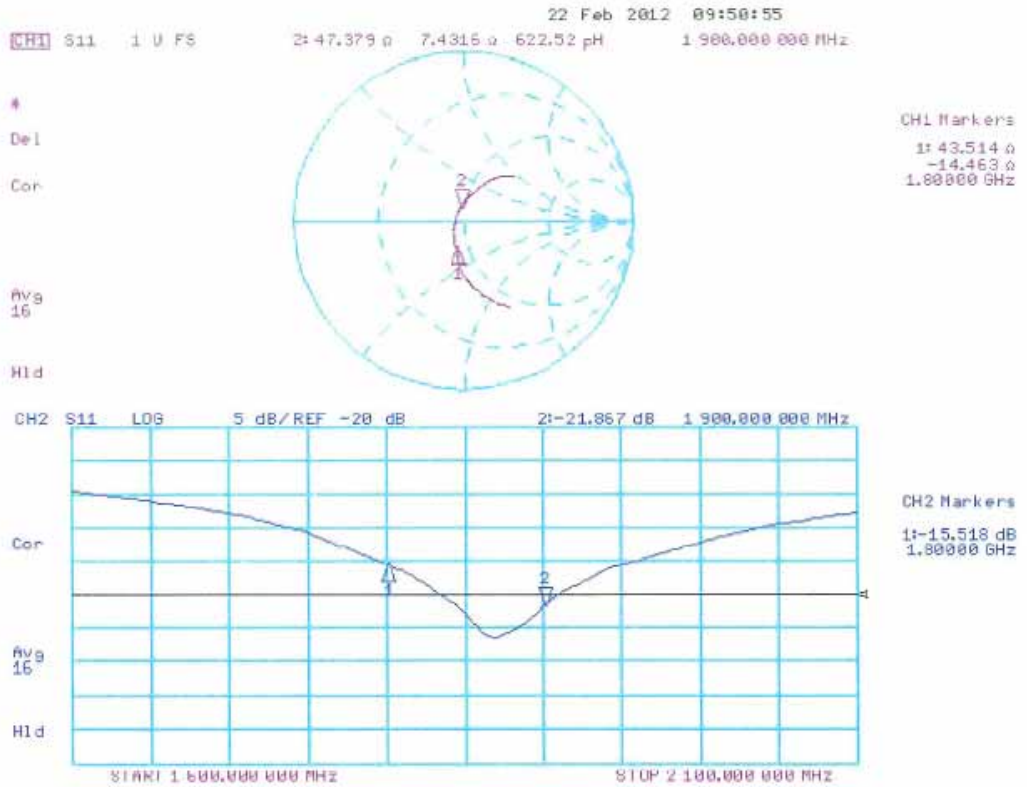

Impedance Measurement Plot for Body TSL

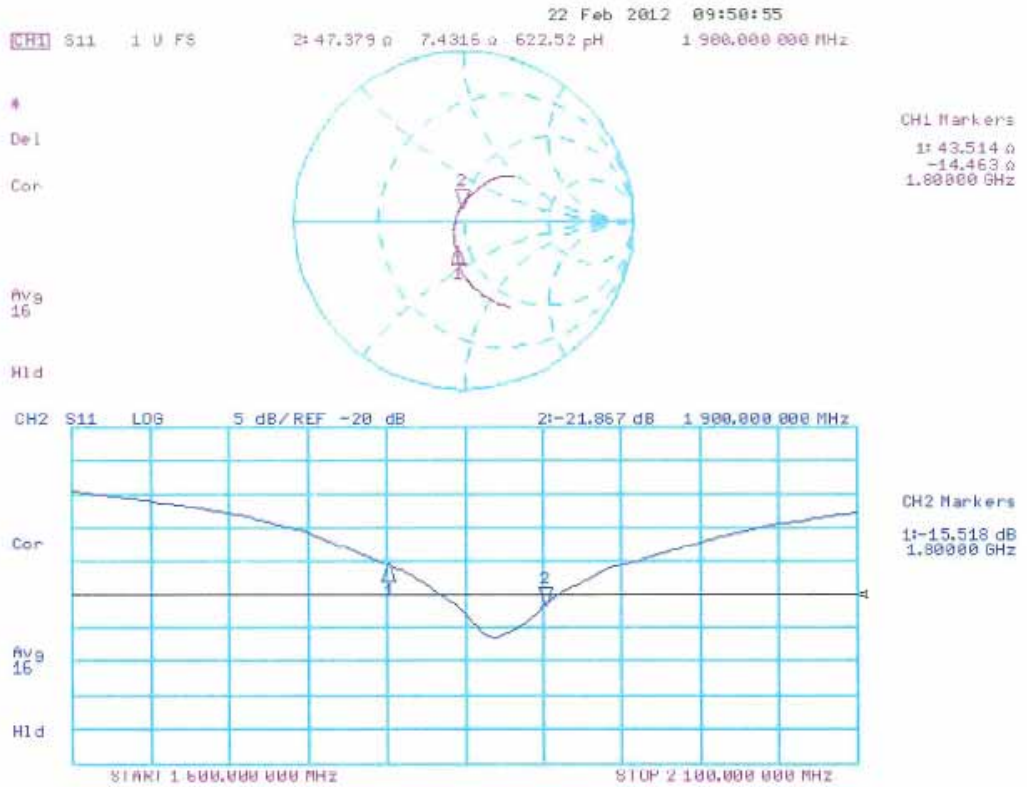

**Calibration Laboratory of
Schmid & Partner
Engineering AG**
Zeughausstrasse 43, 8004 Zurich, Switzerland



S Schweizerischer Kalibrierdienst
C Service suisse d'étalonnage
S Servizio svizzero di taratura
S Swiss Calibration Service

Accredited by the Swiss Accreditation Service (SAS)
The Swiss Accreditation Service is one of the signatories to the EA
Multilateral Agreement for the recognition of calibration certificates

Accreditation No.: **SCS 108**

Client **Quietek-CN (Auden)**

Certificate No: **D2450V2-839_Feb12**

CALIBRATION CERTIFICATE

Object: **D2450V2 - SN: 839**

Calibration procedure(s): **QA CAL-05.v8
Calibration procedure for dipole validation kits above 700 MHz**

Calibration date: **February 23, 2012**

This calibration certificate documents the traceability to national standards, which realize the physical units of measurements (SI).
The measurements and the uncertainties with confidence probability are given on the following pages and are part of the certificate.

All calibrations have been conducted in the closed laboratory facility: environment temperature (22 ± 3)°C and humidity < 70%.

Calibration Equipment used (M&TE critical for calibration)

Primary Standards	ID #	Cal Date (Certificate No.)	Scheduled Calibration
Power meter EPM-442A	GB37480704	05-Oct-11 (No. 217-01451)	Oct-12
Power sensor HP 8481A	US37292783	05-Oct-11 (No. 217-01451)	Oct-12
Reference 20 dB Attenuator	SN: 5086 (20g)	29-Mar-11 (No. 217-01368)	Apr-12
Type N mismatch combination	SN: 5017.2 / 06327	29-Mar-11 (No. 217-01371)	Apr-12
Reference Probe ES3DV3	SN: 3205	30-Dec-11 (No. ES3-3205_Dec11)	Dec-12
DAE4	SN: 601	04-Jul-11 (No. DAE4-601_Jul11)	Jul-12
Secondary Standards	ID #	Check Date (in house)	Scheduled Check
Power sensor HP 8481A	MY41092317	18-Oct-02 (in house check Oct-11)	In house check: Oct-13
RF generator R&S SMT-06	100005	04-Aug-99 (in house check Oct-11)	In house check: Oct-13
Network Analyzer HP 8753E	US37390585 S4206	18-Oct-01 (in house check Oct-11)	In house check: Oct-12

Calibrated by:	Name Israa El-Naouq	Function Laboratory Technician	Signature
Approved by:	Name Katja Pokovic	Function Technical Manager	

Issued: February 23, 2012

This calibration certificate shall not be reproduced except in full without written approval of the laboratory.

**Calibration Laboratory of
Schmid & Partner
Engineering AG**
Zeughausstrasse 43, 8004 Zurich, Switzerland



S Schweizerischer Kalibrierdienst
C Service suisse d'étalonnage
S Servizio svizzero di taratura
S Swiss Calibration Service

Accredited by the Swiss Accreditation Service (SAS)
The Swiss Accreditation Service is one of the signatories to the EA
Multilateral Agreement for the recognition of calibration certificates

Accreditation No.: **SCS 108**

Glossary:

TSL	tissue simulating liquid
ConvF	sensitivity in TSL / NORM x,y,z
N/A	not applicable or not measured

Calibration is Performed According to the Following Standards:

- a) IEEE Std 1528-2003, "IEEE Recommended Practice for Determining the Peak Spatial-Averaged Specific Absorption Rate (SAR) in the Human Head from Wireless Communications Devices: Measurement Techniques", December 2003
- b) IEC 62209-1, "Procedure to measure the Specific Absorption Rate (SAR) for hand-held devices used in close proximity to the ear (frequency range of 300 MHz to 3 GHz)", February 2005
- c) Federal Communications Commission Office of Engineering & Technology (FCC OET), "Evaluating Compliance with FCC Guidelines for Human Exposure to Radiofrequency Electromagnetic Fields; Additional Information for Evaluating Compliance of Mobile and Portable Devices with FCC Limits for Human Exposure to Radiofrequency Emissions", Supplement C (Edition 01-01) to Bulletin 65

Additional Documentation:

- d) DASY4/5 System Handbook

Methods Applied and Interpretation of Parameters:

- *Measurement Conditions:* Further details are available from the Validation Report at the end of the certificate. All figures stated in the certificate are valid at the frequency indicated.
- *Antenna Parameters with TSL:* The dipole is mounted with the spacer to position its feed point exactly below the center marking of the flat phantom section, with the arms oriented parallel to the body axis.
- *Feed Point Impedance and Return Loss:* These parameters are measured with the dipole positioned under the liquid filled phantom. The impedance stated is transformed from the measurement at the SMA connector to the feed point. The Return Loss ensures low reflected power. No uncertainty required.
- *Electrical Delay:* One-way delay between the SMA connector and the antenna feed point. No uncertainty required.
- *SAR measured:* SAR measured at the stated antenna input power.
- *SAR normalized:* SAR as measured, normalized to an input power of 1 W at the antenna connector.
- *SAR for nominal TSL parameters:* The measured TSL parameters are used to calculate the nominal SAR result.

Measurement Conditions

DASY system configuration, as far as not given on page 1.

DASY Version	DASY5	V52.8.0
Extrapolation	Advanced Extrapolation	
Phantom	Modular Flat Phantom	
Distance Dipole Center - TSL	10 mm	with Spacer
Zoom Scan Resolution	dx, dy, dz = 5 mm	
Frequency	2450 MHz ± 1 MHz	

Head TSL parameters

The following parameters and calculations were applied.

	Temperature	Permittivity	Conductivity
Nominal Head TSL parameters	22.0 °C	39.2	1.80 mho/m
Measured Head TSL parameters	(22.0 ± 0.2) °C	38.9 ± 6 %	1.86 mho/m ± 6 %
Head TSL temperature change during test	< 0.5 °C	----	----

SAR result with Head TSL

SAR averaged over 1 cm ³ (1 g) of Head TSL	Condition	
SAR measured	250 mW input power	13.2 mW / g
SAR for nominal Head TSL parameters	normalized to 1W	51.9 mW / g ± 17.0 % (k=2)

SAR averaged over 10 cm ³ (10 g) of Head TSL	condition	
SAR measured	250 mW input power	6.09 mW / g
SAR for nominal Head TSL parameters	normalized to 1W	24.1 mW / g ± 16.5 % (k=2)

Body TSL parameters

The following parameters and calculations were applied.

	Temperature	Permittivity	Conductivity
Nominal Body TSL parameters	22.0 °C	52.7	1.95 mho/m
Measured Body TSL parameters	(22.0 ± 0.2) °C	52.3 ± 6 %	2.02 mho/m ± 6 %
Body TSL temperature change during test	< 0.5 °C	----	----

SAR result with Body TSL

SAR averaged over 1 cm ³ (1 g) of Body TSL	Condition	
SAR measured	250 mW input power	12.4 mW / g
SAR for nominal Body TSL parameters	normalized to 1W	48.7 mW / g ± 17.0 % (k=2)

SAR averaged over 10 cm ³ (10 g) of Body TSL	condition	
SAR measured	250 mW input power	5.76 mW / g
SAR for nominal Body TSL parameters	normalized to 1W	22.8 mW / g ± 16.5 % (k=2)

Appendix

Antenna Parameters with Head TSL

Impedance, transformed to feed point	55.7 Ω - 1.0 j Ω
Return Loss	- 25.2 dB

Antenna Parameters with Body TSL

Impedance, transformed to feed point	52.1 Ω + 1.0 j Ω
Return Loss	- 32.9 dB

General Antenna Parameters and Design

Electrical Delay (one direction)	1.160 ns
----------------------------------	----------

After long term use with 100W radiated power, only a slight warming of the dipole near the feedpoint can be measured.

The dipole is made of standard semirigid coaxial cable. The center conductor of the feeding line is directly connected to the second arm of the dipole. The antenna is therefore short-circuited for DC-signals. On some of the dipoles, small end caps are added to the dipole arms in order to improve matching when loaded according to the position as explained in the "Measurement Conditions" paragraph. The SAR data are not affected by this change. The overall dipole length is still according to the Standard.

No excessive force must be applied to the dipole arms, because they might bend or the soldered connections near the feedpoint may be damaged.

Additional EUT Data

Manufactured by	SPEAG
Manufactured on	July 20, 2009

DASY5 Validation Report for Head TSL

Date: 23.02.2012

Test Laboratory: SPEAG, Zurich, Switzerland

DUT: Dipole 2450 MHz; Type: D2450V2; Serial: D2450V2 - SN: 839

Communication System: CW; Frequency: 2450 MHz
 Medium parameters used: $f = 2450$ MHz; $\sigma = 1.86$ mho/m; $\epsilon_r = 38.9$; $\rho = 1000$ kg/m³
 Phantom section: Flat Section
 Measurement Standard: DASY5 (IEEE/IEC/ANSI C63.19-2007)

DASY52 Configuration:

- Probe: ES3DV3 - SN3205; ConvF(4.45, 4.45, 4.45); Calibrated: 30.12.2011
- Sensor-Surface: 3mm (Mechanical Surface Detection)
- Electronics: DAE4 Sn601; Calibrated: 04.07.2011
- Phantom: Flat Phantom 5.0 (front); Type: QD000P50AA; Serial: 1001
- DASY52 52.8.0(692); SEMCAD X 14.6.4(4989)

Dipole Calibration for Head Tissue/Pin=250 mW, d=10mm/Zoom Scan (7x7x7)/Cube 0:

Measurement grid: dx=5mm, dy=5mm, dz=5mm
 Reference Value = 98.155 V/m; Power Drift = 0.08 dB
 Peak SAR (extrapolated) = 27.8700
SAR(1 g) = 13.2 mW/g; SAR(10 g) = 6.09 mW/g
 Maximum value of SAR (measured) = 16.839 mW/g

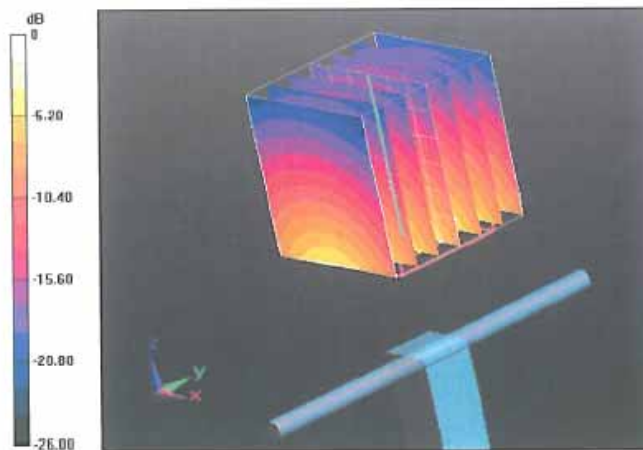

0 dB = 16.840mW/g = 24.53 dB mW/g

Impedance Measurement Plot for Head TSL

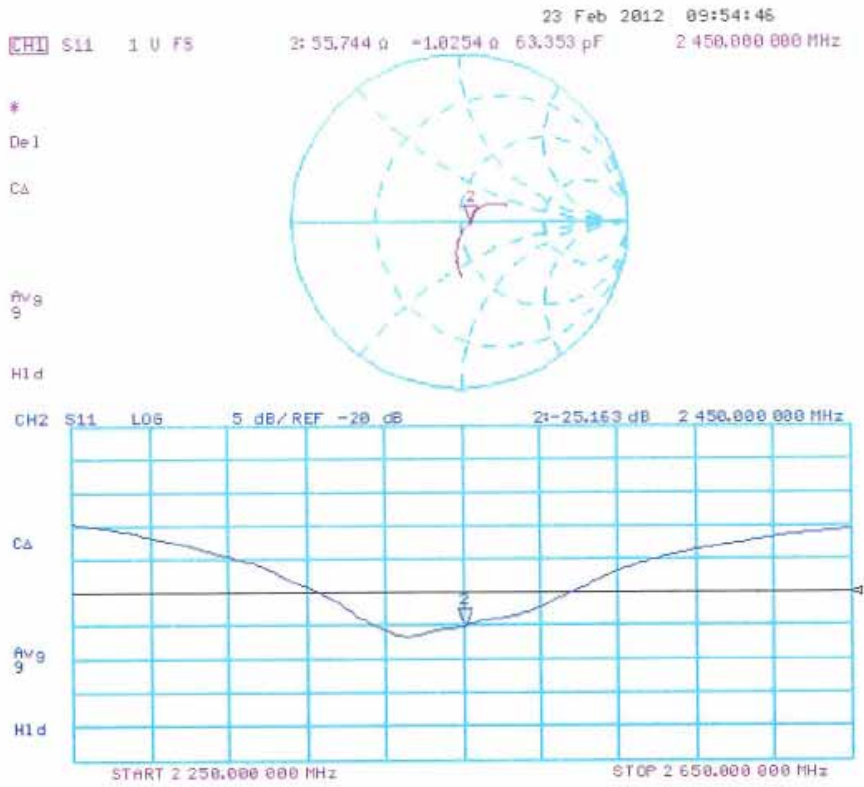

DASY5 Validation Report for Body TSL

Date: 23.02.2012

Test Laboratory: SPEAG, Zurich, Switzerland

DUT: Dipole 2450 MHz; Type: D2450V2; Serial: D2450V2 - SN: 839

Communication System: CW; Frequency: 2450 MHz

Medium parameters used: $f = 2450$ MHz; $\sigma = 2.02$ mho/m; $\epsilon_r = 52.3$; $\rho = 1000$ kg/m³

Phantom section: Flat Section

Measurement Standard: DASY5 (IEEE/IEC/ANSI C63.19-2007)

DASY52 Configuration:

- Probe: ES3DV3 - SN3205; ConvF(4.26, 4.26, 4.26); Calibrated: 30.12.2011
- Sensor-Surface: 3mm (Mechanical Surface Detection)
- Electronics: DAE4 Sn601; Calibrated: 04.07.2011
- Phantom: Flat Phantom 5.0 (back); Type: QD000P50AA; Serial: 1002
- DASY52 52.8.0(692); SEMCAD X 14.6.4(4989)

Dipole Calibration for Body Tissue/Pin=250 mW, d=10mm/Zoom Scan (7x7x7)/Cube 0:

Measurement grid: dx=5mm, dy=5mm, dz=5mm

Reference Value = 93.056 V/m; Power Drift = 0.0053 dB

Peak SAR (extrapolated) = 25.2250

SAR(1 g) = 12.4 mW/g; SAR(10 g) = 5.76 mW/g

Maximum value of SAR (measured) – 16.258 mW/g

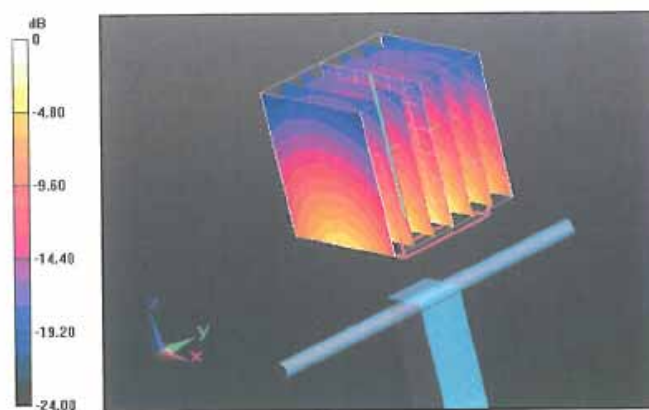

0 dB = 16.260mW/g = 24.22 dB mW/g

Impedance Measurement Plot for Body TSL

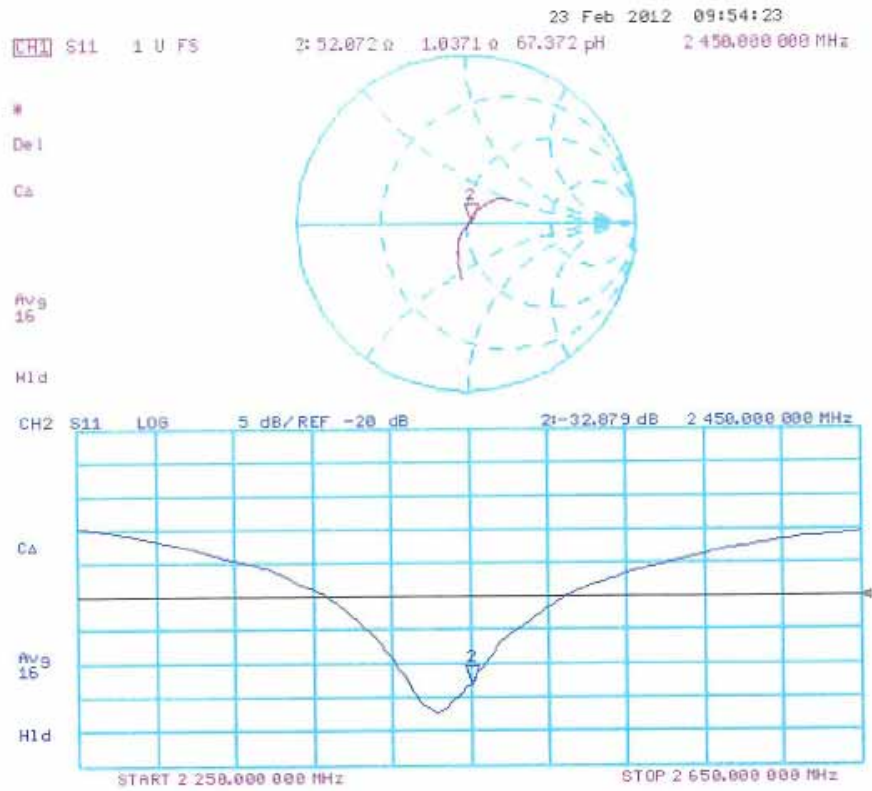

Appendix F. DAE Calibration Data

**Calibration Laboratory of
Schmid & Partner
Engineering AG**
Zeughausstrasse 43, 8004 Zurich, Switzerland



S Schweizerischer Kalibrierdienst
C Service suisse d'étalonnage
S Servizio svizzero di taratura
S Swiss Calibration Service

Accredited by the Swiss Accreditation Service (SAS)
The Swiss Accreditation Service is one of the signatories to the EA
Multilateral Agreement for the recognition of calibration certificates

Accreditation No.: **SCS 108**

Client: **Auden**

Certificate No.: **DAE4-915_Jun12**

CALIBRATION CERTIFICATE																			
Object	DAE4 - SD 000 D04 BK - SN: 915																		
Calibration procedure(s)	QA CAL-06.v24 Calibration procedure for the data acquisition electronics (DAE)																		
Calibration date:	June 21, 2012																		
<p>This calibration certificate documents the traceability to national standards, which realize the physical units of measurements (SI). The measurements and the uncertainties with confidence probability are given on the following pages and are part of the certificate.</p> <p>All calibrations have been conducted in the closed laboratory facility: environment temperature (22 ± 3)°C and humidity < 70%.</p> <p>Calibration Equipment used (M&TE critical for calibration)</p> <table border="1"> <thead> <tr> <th>Primary Standards</th> <th>ID #</th> <th>Cal Date (Certificate No.)</th> <th>Scheduled Calibration</th> </tr> </thead> <tbody> <tr> <td>Keithley Multimeter Type 2001</td> <td>SN: 0810278</td> <td>28-Sep-11 (No:11450)</td> <td>Sep-12</td> </tr> <tr> <th>Secondary Standards</th> <th>ID #</th> <th>Check Date (in house)</th> <th>Scheduled Check</th> </tr> <tr> <td>Calibrator Box V2.1</td> <td>SE UWS 053 AA 1001</td> <td>05-Jan-12 (in house check)</td> <td>In house check: Jan-13</td> </tr> </tbody> </table>				Primary Standards	ID #	Cal Date (Certificate No.)	Scheduled Calibration	Keithley Multimeter Type 2001	SN: 0810278	28-Sep-11 (No:11450)	Sep-12	Secondary Standards	ID #	Check Date (in house)	Scheduled Check	Calibrator Box V2.1	SE UWS 053 AA 1001	05-Jan-12 (in house check)	In house check: Jan-13
Primary Standards	ID #	Cal Date (Certificate No.)	Scheduled Calibration																
Keithley Multimeter Type 2001	SN: 0810278	28-Sep-11 (No:11450)	Sep-12																
Secondary Standards	ID #	Check Date (in house)	Scheduled Check																
Calibrator Box V2.1	SE UWS 053 AA 1001	05-Jan-12 (in house check)	In house check: Jan-13																
Calibrated by:	Name Roland Mayoraz	Function Technician	Signature <i>R. Mayoraz</i>																
Approved by:	Name Fin Bomholt	Function R&D Director	Signature <i>F. Bomholt</i>																
			Issued: June 21, 2012																
This calibration certificate shall not be reproduced except in full without written approval of the laboratory.																			

**Calibration Laboratory of
Schmid & Partner
Engineering AG**
Zeughausstrasse 43, 8004 Zurich, Switzerland



S Schweizerischer Kalibrierdienst
S Service suisse d'étalonnage
C Servizio svizzero di taratura
S Swiss Calibration Service

Accredited by the Swiss Accreditation Service (SAS)
The Swiss Accreditation Service is one of the signatories to the EA
Multilateral Agreement for the recognition of calibration certificates

Accreditation No.: **SCS 108**

Glossary

DAE data acquisition electronics
Connector angle information used in DASY system to align probe sensor X to the robot coordinate system.

Methods Applied and Interpretation of Parameters

- *DC Voltage Measurement*: Calibration Factor assessed for use in DASY system by comparison with a calibrated instrument traceable to national standards. The figure given corresponds to the full scale range of the voltmeter in the respective range.
- *Connector angle*: The angle of the connector is assessed measuring the angle mechanically by a tool inserted. Uncertainty is not required.
- The following parameters as documented in the Appendix contain technical information as a result from the performance test and require no uncertainty.
 - *DC Voltage Measurement Linearity*: Verification of the Linearity at +10% and -10% of the nominal calibration voltage. Influence of offset voltage is included in this measurement.
 - *Common mode sensitivity*: Influence of a positive or negative common mode voltage on the differential measurement.
 - *Channel separation*: Influence of a voltage on the neighbor channels not subject to an input voltage.
 - *AD Converter Values with inputs shorted*: Values on the internal AD converter corresponding to zero input voltage
 - *Input Offset Measurement*: Output voltage and statistical results over a large number of zero voltage measurements.
 - *Input Offset Current*: Typical value for information; Maximum channel input offset current, not considering the input resistance.
 - *Input resistance*: Typical value for information: DAE input resistance at the connector, during internal auto-zeroing and during measurement.
 - *Low Battery Alarm Voltage*: Typical value for information. Below this voltage, a battery alarm signal is generated.
 - *Power consumption*: Typical value for information. Supply currents in various operating modes.

DC Voltage Measurement

A/D - Converter Resolution nominal

High Range: 1LSB = 6.1µV , full range = -100...+300 mV

Low Range: 1LSB = 61nV , full range = -1.....+3mV

DASY measurement parameters: Auto Zero Time: 3 sec; Measuring time: 3 sec

Calibration Factors	X	Y	Z
High Range	404.305 ± 0.1% (k=2)	404.426 ± 0.1% (k=2)	404.778 ± 0.1% (k=2)
Low Range	3.97864 ± 0.7% (k=2)	4.00935 ± 0.7% (k=2)	3.98892 ± 0.7% (k=2)

Connector Angle

Connector Angle to be used in DASY system	116 ° ± 1 °
---	-------------

Appendix

1. DC Voltage Linearity

High Range		Reading (μV)	Difference (μV)	Error (%)
Channel X	+ Input	200000.26	1.68	0.00
Channel X	+ Input	200003.23	2.08	0.01
Channel X	- Input	-199998.66	1.23	-0.01
Channel Y	+ Input	199996.84	-1.53	-0.00
Channel Y	+ Input	199999.90	-1.02	-0.01
Channel Y	- Input	-200000.07	0.11	-0.00
Channel Z	+ Input	199993.70	0.23	0.00
Channel Z	+ Input	200000.34	-0.59	-0.00
Channel Z	- Input	-200000.03	0.16	-0.00

Low Range		Reading (μV)	Difference (μV)	Error (%)
Channel X	+ Input	2002.19	0.67	0.03
Channel X	+ Input	202.26	0.28	0.14
Channel X	- Input	-197.72	0.18	-0.09
Channel Y	+ Input	2001.61	0.27	0.01
Channel Y	+ Input	201.57	-0.16	-0.08
Channel Y	- Input	-198.41	-0.36	0.18
Channel Z	+ Input	2001.79	0.43	0.02
Channel Z	+ Input	200.97	-0.82	-0.41
Channel Z	- Input	-199.00	-0.86	0.43

2. Common mode sensitivity

DASY measurement parameters: Auto Zero Time: 3 sec; Measuring time: 3 sec

	Common mode Input Voltage (mV)	High Range Average Reading (μV)	Low Range Average Reading (μV)
Channel X	200	-15.57	-17.16
	- 200	18.87	16.94
Channel Y	200	-6.38	-5.72
	- 200	4.83	4.69
Channel Z	200	-0.66	-0.92
	- 200	-0.31	-1.10

3. Channel separation

DASY measurement parameters: Auto Zero Time: 3 sec; Measuring time: 3 sec

	Input Voltage (mV)	Channel X (μV)	Channel Y (μV)	Channel Z (μV)
Channel X	200	-	3.29	-3.71
Channel Y	200	8.64	-	4.52
Channel Z	200	9.52	6.29	-

4. AD-Converter Values with inputs shorted

DASY measurement parameters: Auto Zero Time: 3 sec; Measuring time: 3 sec

	High Range (LSB)	Low Range (LSB)
Channel X	16126	14475
Channel Y	15990	15218
Channel Z	15881	15749

5. Input Offset Measurement

DASY measurement parameters: Auto Zero Time: 3 sec; Measuring time: 3 sec

Input 10M Ω

	Average (μ V)	min. Offset (μ V)	max. Offset (μ V)	Std. Deviation (μ V)
Channel X	0.67	-0.42	2.33	0.45
Channel Y	-0.59	-1.65	0.86	0.45
Channel Z	-0.66	-2.36	0.65	0.44

6. Input Offset Current

Nominal Input circuitry offset current on all channels: <25fA

7. Input Resistance (Typical values for information)

	Zeroing (kOhm)	Measuring (MOhm)
Channel X	200	200
Channel Y	200	200
Channel Z	200	200

8. Low Battery Alarm Voltage (Typical values for information)

Typical values	Alarm Level (VDC)
Supply (+ Vcc)	+7.9
Supply (- Vcc)	-7.6

9. Power Consumption (Typical values for information)

Typical values	Switched off (mA)	Stand by (mA)	Transmitting (mA)
Supply (+ Vcc)	+0.01	+6	+14
Supply (- Vcc)	-0.01	-8	-9