

TEST REPORT

For

**Mobile Phone
(WCDMA/HSDPA/HSUPA850)**

In conformity with

FCC Part22H (01 Oct, 2009)

Model : F-10C
FCC ID : VQK-F10C
Test Item : Mobile Phone
Report No : RY1103P11R2
Issue Date : 11 Mar, 2011

Prepared for

FUJITSU LIMITED
1-1, Kamikodanaka 4-chome, Nakahara-ku, Kawasaki 211-8588,
Japan

Prepared by

RF Technologies Ltd.
472, Nippa-cho, Kohoku-ku, Yokohama, 223-0057, Japan
Telephone: +81+(0)45- 534-0645
FAX: +81+(0)45- 534-0646

This report shall not be reproduced, except in full, without the written permission of RF Technologies Ltd. The test results in this report apply only to the sample(s) tested. RF Technologies Ltd. is managed to ISO17025 and has the necessary knowledge and test facilities for testing according to the referenced standards.

Table of Contents

1	General information	3
1.1	Product description	3
1.2	Test(s) performed/ Summary of test result	3
1.3	Test facility	4
1.4	Measurement uncertainty.....	4
1.5	Description of essential requirements and test results	5
1.5.1	Transmitter requirements.....	5
1.5.2	AC Power Line Parameters	5
1.5.3	Normal test conditions	5
1.5.4	Extreme test conditions.....	5
1.6	Setup of equipment under test (EUT).....	6
1.6.1	Test configuration of EUT.....	6
1.6.2	Operating condition:	6
1.6.3	Setup diagram of tested system:	6
1.7	Equipment modifications.....	6
1.8	Deviation from the standard	6
2	Test procedure and result	7
2.1	Carrier Output Power (Conducted).....	7
2.2	Carrier Output Power (Radiated).....	8
2.3	Frequency Stability (Temperature).....	10
2.4	Frequency Stability (Voltage).....	12
2.5	Occupied Bandwidth	13
2.6	Transmitter Out of Band Spurious Emissions (Conducted)	16
2.7	Transmitter Out of Band Spurious Emissions (Radiated)	21
2.8	Band Edge Emissions	23
2.9	Transmitter AC Power Line Emission requirement	25
3	Test setup photographs	26
4	List of utilized test equipment/ calibration.....	27

History

Report No.	Issue Date	Revision Contents	Issued by
RY1103P11R2	11 Mar, 2011	Initial Issue	T.Kato

1 General information

1.1 Product description

Test item : Mobile Phone
Manufacturer : FUJITSU LIMITED
Address : 1-1, Kamikodanaka 4-chome, Nakahara-ku, Kawasaki 211-8588,
Japan
Model : F-10C
FCC ID : VQK-F10C
Operating frequency range : TX 826.4-846.6 MHz (WCDMA850, HSDPA Cat8, HSUPA Cat6)
: RX 871.4-891.6 MHz (WCDMA850, HSDPA Cat8, HSUPA Cat6)
Type of Modulation : QPSK(WCDMA), 16QAM(HSDPA, HSUPA)
Receipt date of EUT : 22 Feb, 2011
Nominal power voltages : 3.7VDC
Power Class : 3 (Maximum power 24dBm nominal)
Antenna Type : Integral antenna
Serial numbers : 3546 9004 0004 517

1.2 Test(s) performed/ Summary of test result

Applicable Standard(s) : FCC Part22H (01 Oct, 2009)
Test(s) started : 01 Mar, 2011
Test(s) completed : 04 Mar, 2011
Purpose of test(s) : Certification of FCC

Summary of test result : Complied (RF conducted test only)

Note: The above judgment is only based on the measurement data and it does not include the measurement uncertainty. Accordingly, the statement below is applied to the test result. The EUT complies with the limit required in the standard in case that the margin is not less than the measurement uncertainty in the Laboratory. Compliance of the EUT is more probable than non-compliance is case that the margin is less than the measurement uncertainty in the Laboratory.

Test engineer : 
T. Kato (Engineer, EMC testing department)

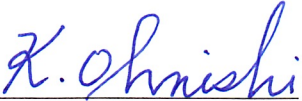
Reviewer : 
K. Ohnishi (Manager, EMC testing department)

1.3 Test facility

The Federal Communications Commission has reviewed the technical characteristics of the test facilities at RF Technologies Ltd., located in 472, Nippa-cho, Kohoku-ku, Yokohama, 223-0057, Japan, and has found these test facilities to be in compliance with the requirements of 47 CFR Part 15, section 2.948, per 01 October, 2009. The description of the test facilities has been filed under registration number 319924 at the Office of the Federal Communications Commission. The facility has been added to the list of laboratories performing these test services for the public on a fee basis.

The list of all public test facilities is available on the Internet at <http://www.fcc.gov>.

Registered by Voluntary Control Council for Interference by Information Technology Equipment (VCCI).

Each registered facility number is as follows;

Test site (Semi-anechoic chamber 3m) R-2393

Test site (Shielded room) C-2617

Registered by Industry Canada (IC). The registered facility number is as follows;

Test site No.1(Semi-anechoic chamber 3m) : 6974A-1

Accredited by **National Voluntary Laboratory Accreditation Program (NVLAP)** for the emission tests stated in the scope of the certificate under Certificate Number 200780-0

This report must not be used by the client to claim product certification, approval, or endorsement by NVLAP, NIST, or any agency of the Federal Government.



NVLAP LAB CODE 200780-0

1.4 Measurement uncertainty

The treatment of uncertainty is based on the general matters on the definition of uncertainty in “Guide to the expression of uncertainty in measurement (GUM)” published by ISO. The Lab’s uncertainty is determined by referring UKAS Publication LAB34: 2002 “The Expression of Uncertainty in EMC Testing” and CISPR16-4-2: 2003 “Uncertainty in EMC Measurements”.

The uncertainty of the measurement result in the level of confidence of approximately 95% (k=2) is as follows;

RF frequency: $\pm 1 \times 10^{-7}$

RF power conducted: ± 1.1 dB

AC Power line emission: ± 1.9 dB

Radiated emission (30MHz - 1000MHz): ± 5.9 dB

Radiated emission (1GHz - 20GHz): ± 5.8 dB

Temperature: ± 1 degree

Humidity: ± 5 %

1.5 Description of essential requirements and test results

An overview of radio requirements, as laid out in FCC Part22 are given below.

1.5.1 Transmitter requirements

Test Description	Section in this report	Test performed	Result
Carrier Output Power (Conducted)	2.1	Yes	Pass
Carrier Output Power (Radiated)	2.2	No	-
Frequency Stability (Temp. Variation)	2.3	Yes	Pass
Frequency Stability (Voltage Variation)	2.4	Yes	Pass
Occupied Bandwidth	2.5	Yes	Pass
Out of Band Emissions (Conducted)	2.6	Yes	Pass
Out of Band Emissions (Radiated)	2.7	No	-
Band Edge Emissions	2.8	Yes	Pass

1.5.2 AC Power Line Parameters

Test Description	Section in this report	Test Performed	Result
AC power line Spurious Emissions (Traffic mode)	2.9	No	-

1.5.3 Normal test conditions

Temperature(*) : +15 degC to +35 degC
 Relative humidity(*) : 20 % to 75 %
 Supply voltage : 3.7 VDC (Nominal)
 Measurement Frequency : 826.4 MHz(4132ch), 836.4 MHz(4182ch), 846.6 MHz(4233ch)

* When it is impracticable to carry out tests under these conditions, a note to this effect, stating the ambient temperature and relative humidity during the tests, must be stated separately.

1.5.4 Extreme test conditions

Temperature : -30 °C (min) to +50 °C (max)
 Supply voltage : 3.33 VDC [min] to 4.07 VDC [max] (declared by manufacturer)

1.6 Setup of equipment under test (EUT)

1.6.1 Test configuration of EUT

Equipment(s) under test:

	Item	Manufacturer	Model No.	Serial No.
A	Mobile Phone	FUJITSU LIMITED	F-10C	3546 9004 0004 517

Support Equipment(s):

	Item	Manufacturer	Model No.	Serial No.	Comment
B	-	-	-	-	-

Connected cable(s):

No.	Item	Identification (Manu.e.t.c)	Shielded Yes / No	Ferrite Core Yes / No	Connector Type Shielded Yes / No	Length (m)
-	-	-	-	-	-	-

1.6.2 Operating condition:

Traffic mode : EUT is connected with RF tester in Max power level. (Normal/HSDPA/HSUPA mode)

1.6.3 Setup diagram of tested system:

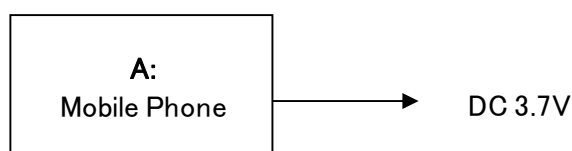

1.7 Equipment modifications

No modifications have been made to the equipment in order to achieve compliance with the applicable standards described in clause 1.2.

1.8 Deviation from the standard

No deviations from the standards described in clause 1.2.

2 Test procedure and result

2.1 Carrier Output Power (Conducted)

Reference Standard

Part22.913, 2.1046

Test Conditions

Date: 01 Mar, 2011
 Ambient Temperature: 22 degC
 Relative humidity: 47 %
 Test Voltage: 3.7 VDC

Test Method

- a) EUT is connected to RF tester with pseudo random data modulation and set to maximum output power level.
- b) The output power is measured with RF tester (CMU200 etc.).

Test Setup

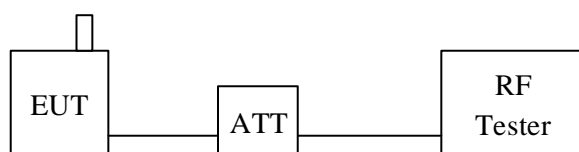

Test Results

Channel	Frequency [MHz]	Output Power [dBm]		
		Normal	HSDPA	HSUPA
Bottom (4132ch)	826.4	23.4	22.6	22.8
Middle (4182ch)	836.4	23.4	22.6	22.7
Top (4233ch)	846.6	23.6	22.8	22.9

Test Equipment Used

Equipment name	RFT ID No.
RF tester	RC03
RF cable	CL27

2.2 Carrier Output Power (Radiated)

Reference Standard

Part22.913, 2.1046

Test Conditions

Date: -
Ambient Temperature: -
Relative humidity: -
Test Voltage: -

Test Method

Substitution method is used for this test.

a) EUT is set on non-conducting table and the output power is set to the maximum level.

b) As a receive antenna, Horn antenna is used.

c) Maximum power is measured by a spectrum analyzer (SA) in below conditions.

Turntable is rotated 360 degrees.

The height of receive antenna is changed from 1m to 4m.

Receive antenna polarization is set to vertical and horizontal.

This maximum power is recorded.

During this measurement, receive antenna is adjusted the direction to keep the EUT within the beamwidth of receive antenna.

d) Reference antenna is replaced with EUT, and connected with signal generator (SG).

SG output power is adjusted to get same level as the recorded maximum radiated EUT power by SA.

e) Radiated output power (Pout) is calculated with adjusted SG output (Psg) [dBm], reference antenna gain (Gref) [dBd] and cable loss between SG and reference antenna (Lcab) [dB].

$$P_{out} [\text{dBm e.r.p}] = P_{sg} + G_{ref} + L_{cab}$$

Test Setup

[Measurement]

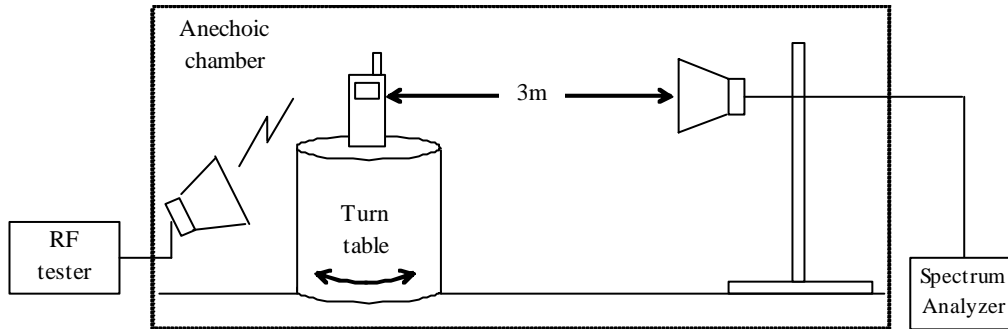

[Substitution]

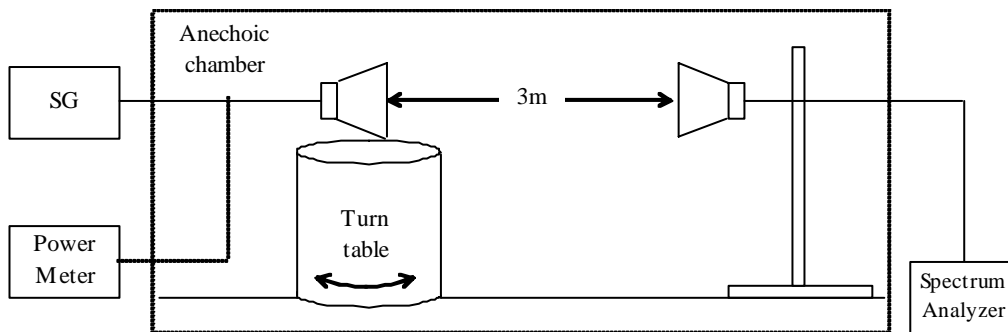

Test Results

Test Equipment Used

Final Result

This item was not tested.

2.3 Frequency Stability (Temperature)

Reference Standard

Part22.355, 2.1055

Test Conditions

Date: 04 Mar, 2011
Ambient Temperature: 23 degC
Relative humidity: 20 %
Test Voltage: 3.7 VDC

Test Method

To measure the carrier frequency, “Frequency error measurement” function of RF tester is used.

- a) EUT is hold about 30 minutes under measurement temperature condition.
- b) EUT is powered on with nominal voltage.
- c) EUT is connected to RF tester with Max transmit power level.
- d) Frequency error is measured by RF tester for 10 minutes.
- e) Process a) to d) is repeated at 10deg increments from -30 to +50degC.

Test Setup

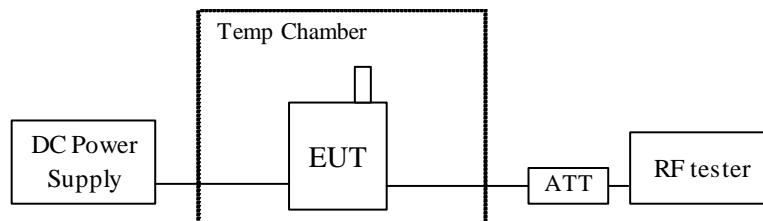

Test Results**Middle Channel (4182ch, Nominal Freq.:836.4MHz)**

Temperature [deg C]	Frequency Error [Hz]	Frequency Error [ppm]	Limit [ppm]	Result
-30	+ 30	+ 0.04	± 2.5	Pass
-20	+ 21	+ 0.03	± 2.5	Pass
-10	+ 8	+ 0.01	± 2.5	Pass
0	+10	+ 0.01	± 2.5	Pass
10	- 12	- 0.01	± 2.5	Pass
20	+ 10	+ 0.01	± 2.5	Pass
30	- 11	- 0.01	± 2.5	Pass
40	+ 17	+ 0.02	± 2.5	Pass
50	+ 19	+ 0.02	± 2.5	Pass

Test Equipment Used

Equipment name	RFT ID No.
RF tester	RC03
Temp Chamber	TC01

Final Result

The EUT met the requirements of the standard for this test

2.4 Frequency Stability (Voltage)

Reference Standard

Part22.355, 2.1055

Test Conditions

Date: 04 Mar, 2011
 Ambient Temperature: 23 degC
 Relative humidity: 20 %
 Test Voltage: 3.33 to 4.07 VDC

Test Method

To measure the carrier frequency, "Frequency error measurement" function of RF tester is used.

- EUT is powered on with nominal voltage. Temperature is 20degC.
- EUT is connected to RF tester with Max transmitter power level.
- Frequency error is measured by RF tester for 10 minutes.
- Process a) to c) is repeated at minimum and maximum voltage condition.

Test Setup

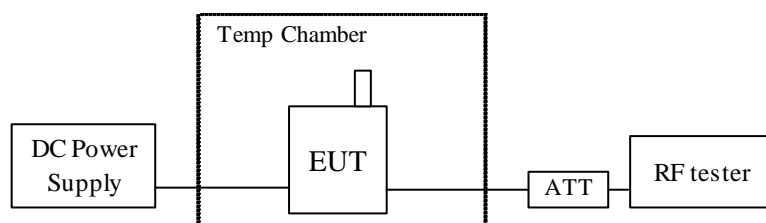

Test Results

Middle Channel (4182ch, Nominal Freq.:836.4MHz)

Voltage [V]	Frequency Error [Hz]	Frequency Error [ppm]	Limit [ppm]	Result
3.33	- 12	- 0.01	± 2.5	Pass
3.70	+ 10	+ 0.01	± 2.5	Pass
4.07	- 9	- 0.01	± 2.5	Pass

Test Equipment Used

Equipment name	RFT ID No.
RF tester	RC03
Temp chamber	TC01

Final Result

The EUT met the requirements of the standard for this test

2.5 Occupied Bandwidth

Reference Standard

Part2.1049

Test Conditions

Date: 01 Mar, 2011
 Ambient Temperature: 22 degC
 Relative humidity: 47 %
 Test Voltage: 3.7 VDC

Test Method

- a) EUT is connected to RF tester with Max transmitter power level.
- b) 26dB bandwidth is measured by Spectrum Analyzer.
- c) 99% occupied bandwidth of transmitter spectrum is measured by Spectrum Analyzer.

Test Setup

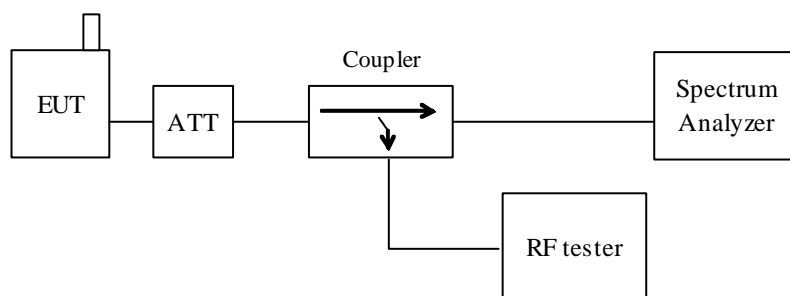

Test Results

Channel	Frequency [MHz]	26dB Bandwidth [MHz]			99% Bandwidth [MHz]		
		Normal	HSDPA	HSUPA	Normal	HSDPA	HSUPA
4132ch	826.4	4.625	4.645	4.650	4.144	4.149	4.149
4182ch	836.4	4.655	4.640	4.655	4.144	4.144	4.144
4233ch	846.6	4.620	4.640	4.655	4.149	4.149	4.139

Test Equipment Used

Equipment name	RFT ID No.
Spectrum Analyzer	TR06
RF tester	RC03
RF cable	CL27
Directional coupler	DC03

Graphical Data

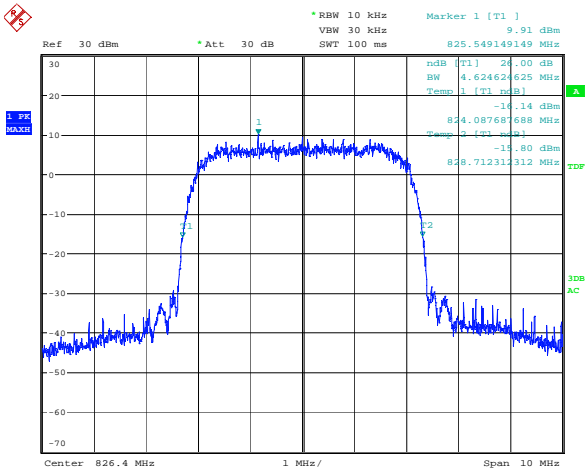

4132ch 26dB Bandwidth (Normal)

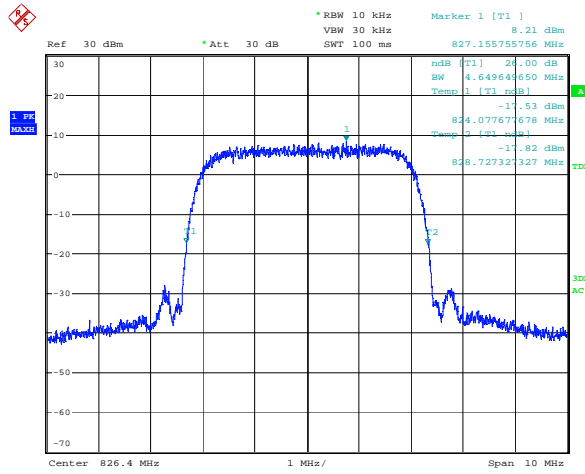

4132ch 26dB Bandwidth (HSUPA)

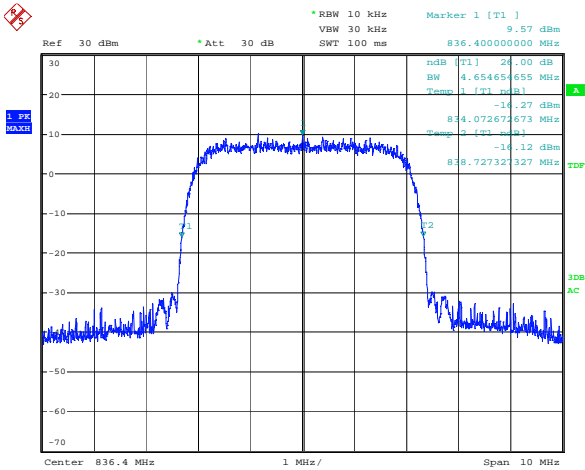

4182ch 26dB Bandwidth (Normal)

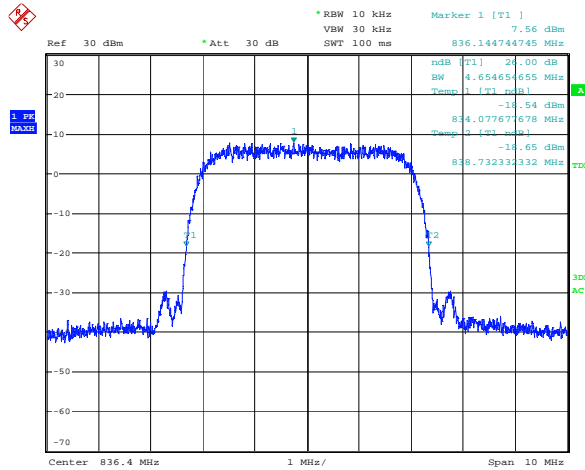

4182ch 26dB Bandwidth (HSUPA)

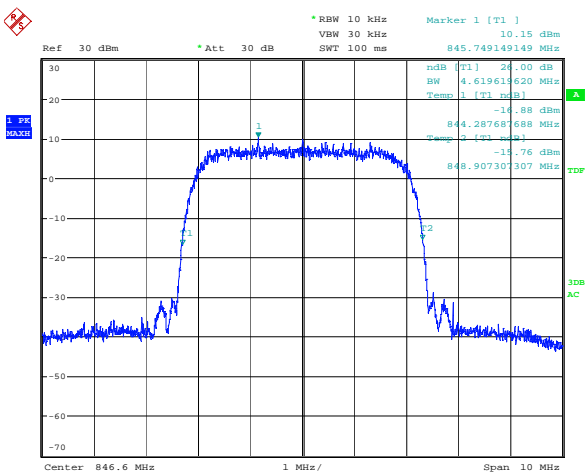

4233ch 26dB Bandwidth (Normal)

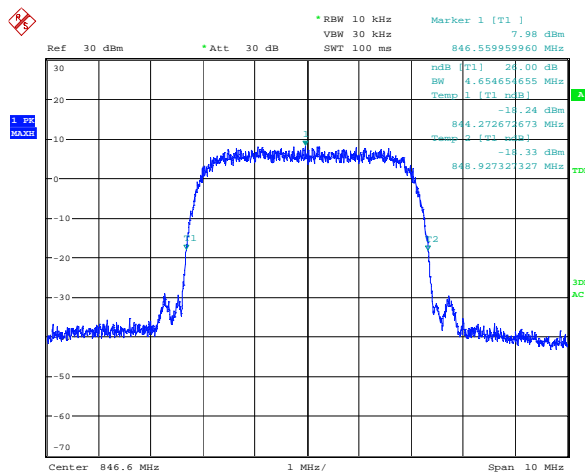

4233ch 26dB Bandwidth (HSUPA)

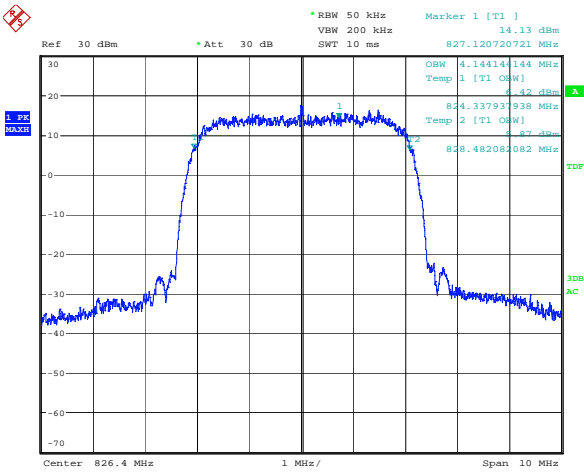

4132ch Occupied Bandwidth (Normal)

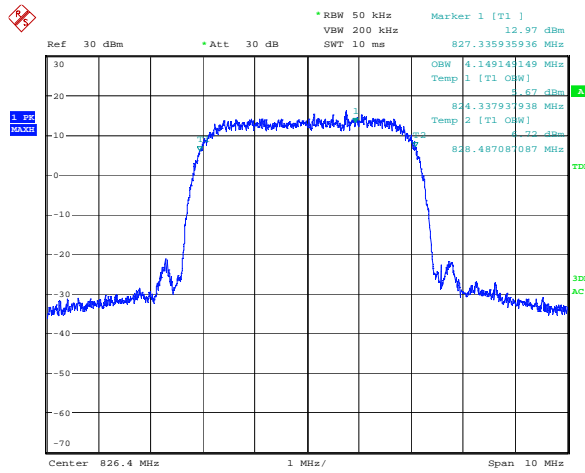

4132ch Occupied Bandwidth (HSUPA)

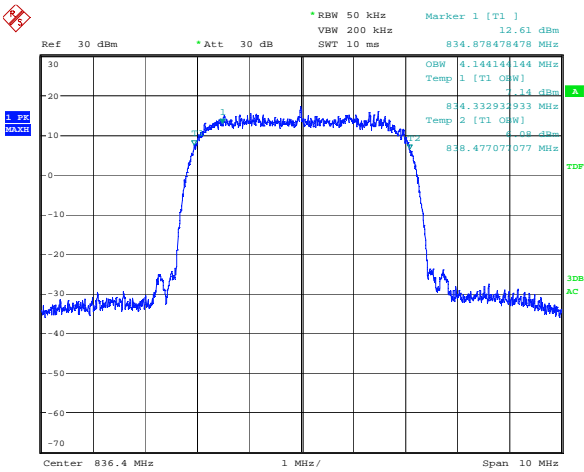

4182ch Occupied Bandwidth (Normal)

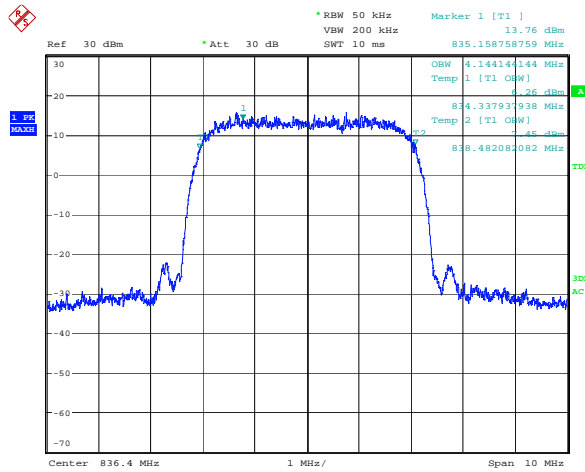

4182ch Occupied Bandwidth (HSUPA)

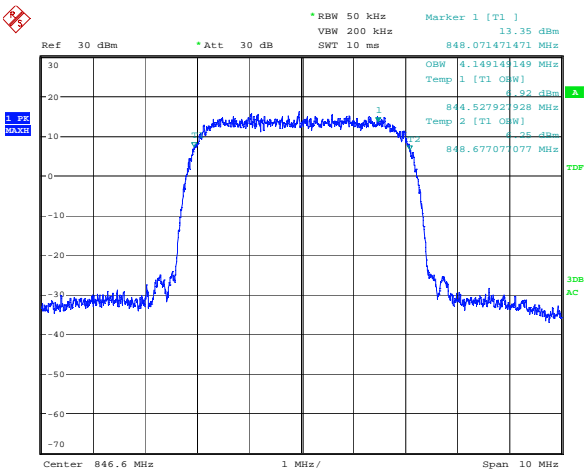

4233ch Occupied Bandwidth (Normal)

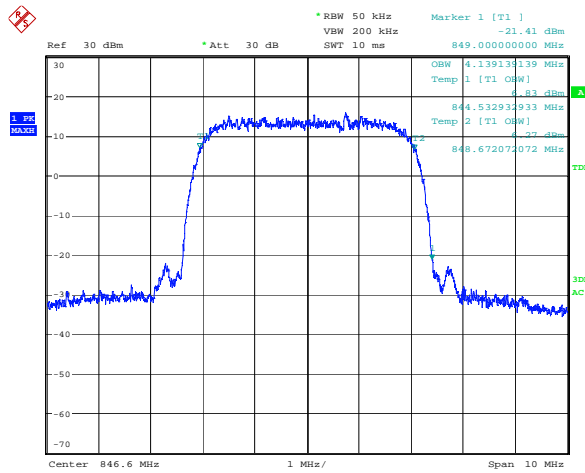

4233ch Occupied Bandwidth (HSUPA)

2.6 Transmitter Out of Band Spurious Emissions (Conducted)

Reference Standard

Part22.917

Test Conditions

Date: 01 Mar, 2011
Ambient Temperature: 22 degC
Relative humidity: 47 %
Test Voltage: 3.7 VDC

Test Method

- EUT is connected to RF tester with Max transmitter power level.
- Out of band Spurious is measured by Spectrum Analyzer.
- Resolution band width of spectrum analyzer is set to 1MHz (above 1GHz) or 100kHz (below 1GHz).

Test Setup

30MHz to 1500MHz

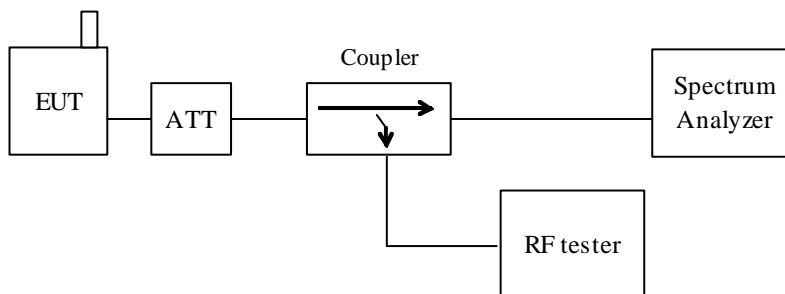

above 1500MHz

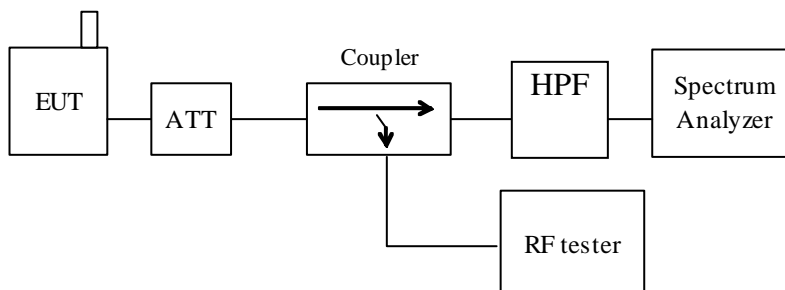

Test Results

Bottom Channel (4132ch, Nominal Freq.:826.4MHz)

Measurement Frequency [MHz]	Measurement Bandwidth [MHz]	Emission Level [dBm]			Limit [dBm]	Result Pass/Fail
		Normal	HSDPA	HSUPA		
1652.8	1	-40.2	-40.3	-38.6	-13.0	Pass
2479.2	1	-55.5	-55.1	-50.8	-13.0	Pass
3305.6	1	-57.1	-57.3	-55.9	-13.0	Pass
4132.0	1	-57.3	-57.9	-56.2	-13.0	Pass
4958.4	1	-58.9	-59.2	-58.4	-13.0	Pass
5784.8	1	< -60.0	< -60.0	< -60.0	-13.0	Pass
6611.2	1	< -60.0	< -60.0	< -60.0	-13.0	Pass
7437.6	1	< -60.0	< -60.0	< -60.0	-13.0	Pass
8264.0	1	< -60.0	< -60.0	< -60.0	-13.0	Pass
others		-	-	-	-13.0	Pass

Middle Channel (4182ch, Nominal Freq.:836.4MHz)

Measurement Frequency [MHz]	Measurement Bandwidth [MHz]	Emission Level [dBm]			Limit [dBm]	Result Pass/Fail
		Normal	HSDPA	HSUPA		
1672.8	1	-42.0	-42.1	-40.7	-13.0	Pass
2509.2	1	-56.0	-56.9	-52.8	-13.0	Pass
3345.6	1	-57.1	-57.5	-56.2	-13.0	Pass
4182.0	1	-56.1	-57.2	-55.1	-13.0	Pass
5018.4	1	< -60.0	< -60.0	< -60.0	-13.0	Pass
5854.8	1	< -60.0	< -60.0	< -60.0	-13.0	Pass
6691.2	1	< -60.0	< -60.0	< -60.0	-13.0	Pass
7527.6	1	< -60.0	< -60.0	< -60.0	-13.0	Pass
8364.0	1	< -60.0	< -60.0	< -60.0	-13.0	Pass
others		-	-	-	-13.0	Pass

Top Channel (4233ch, Nominal Freq.:846.6MHz)

Measurement Frequency [MHz]	Measurement Bandwidth [MHz]	Emission Level [dBm]			Limit [dBm]	Result Pass/Fail
		Normal	HSDPA	HSUPA		
1693.2	1	-45.1	-45.5	-44.4	-13.0	Pass
2539.8	1	-51.2	-51.3	-46.5	-13.0	Pass
3386.4	1	-57.4	-57.5	-56.7	-13.0	Pass
4233.0	1	-54.4	-55.0	-53.5	-13.0	Pass
5079.6	1	< -60.0	< -60.0	< -60.0	-13.0	Pass
5926.2	1	< -60.0	< -60.0	< -60.0	-13.0	Pass
6772.8	1	< -60.0	< -60.0	< -60.0	-13.0	Pass
7619.4	1	< -60.0	< -60.0	< -60.0	-13.0	Pass
8466.0	1	< -60.0	< -60.0	< -60.0	-13.0	Pass
others		-	-	-	-13.0	Pass

Graphical Data (4182ch, Pre-scan)

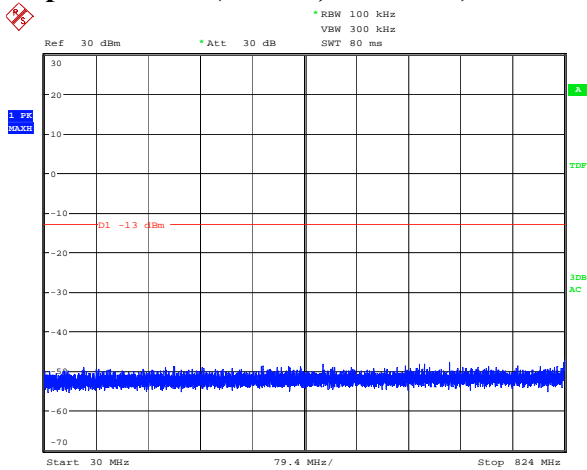

Normal

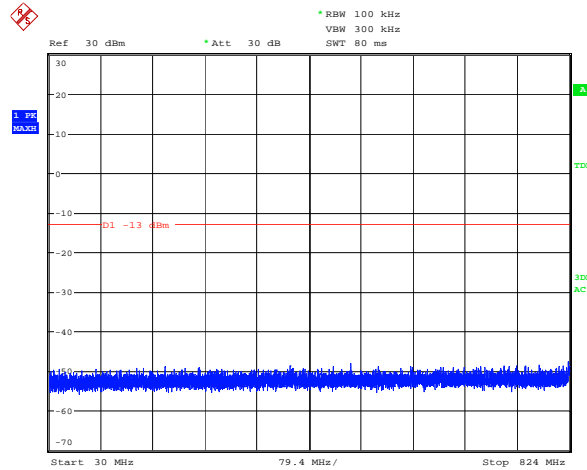

HSUPA

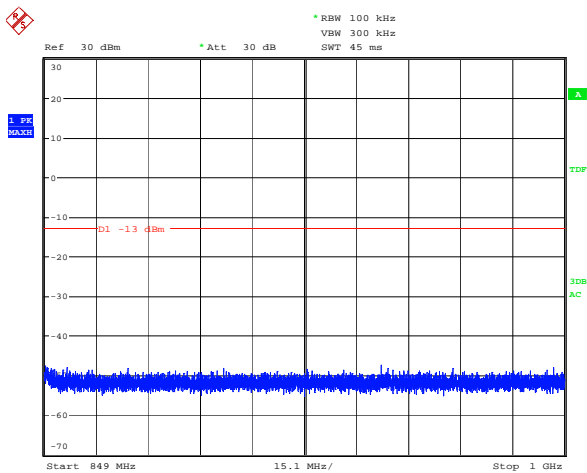

Normal

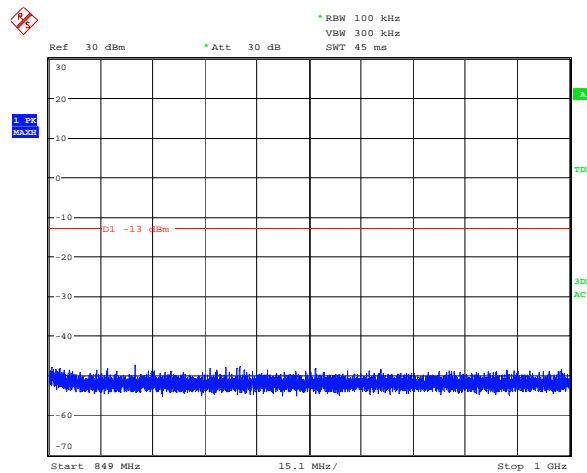

HSUPA

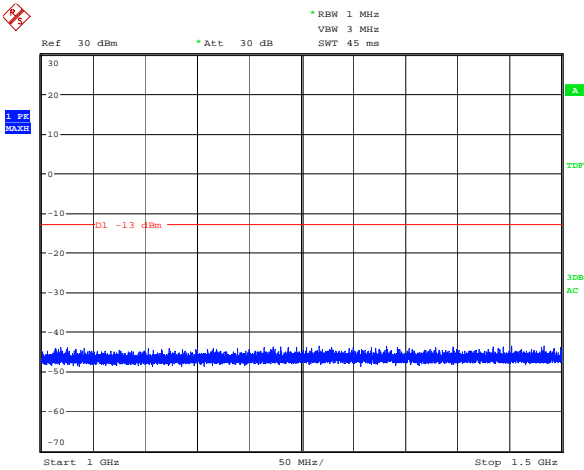

Normal

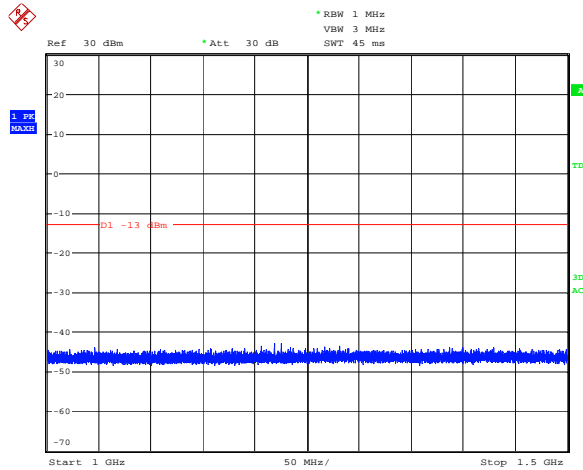

HSUPA

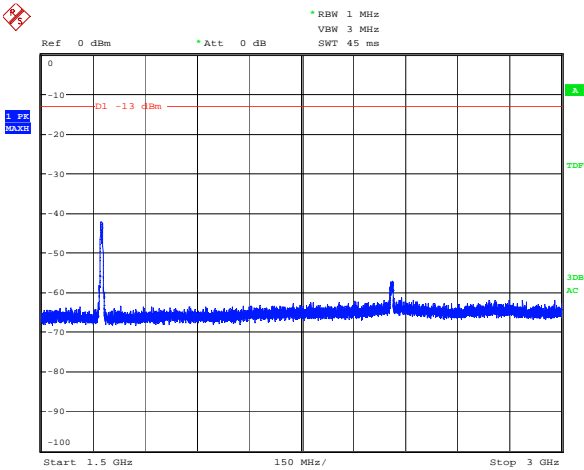

Normal

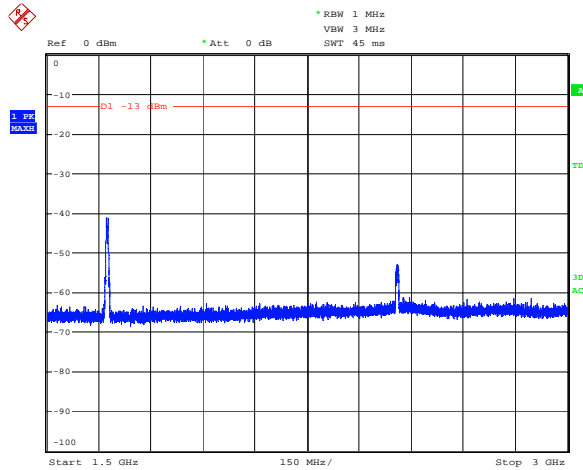

HSUPA

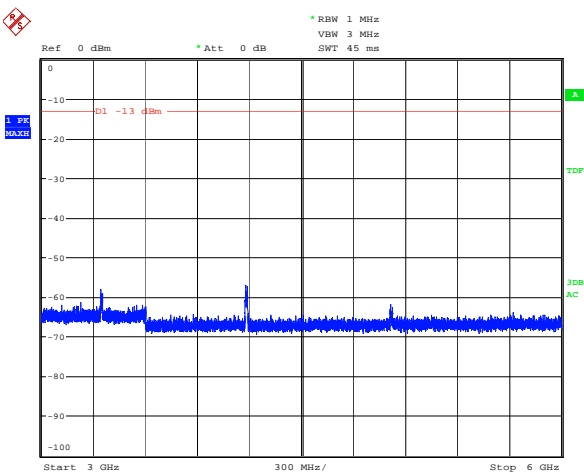

Normal

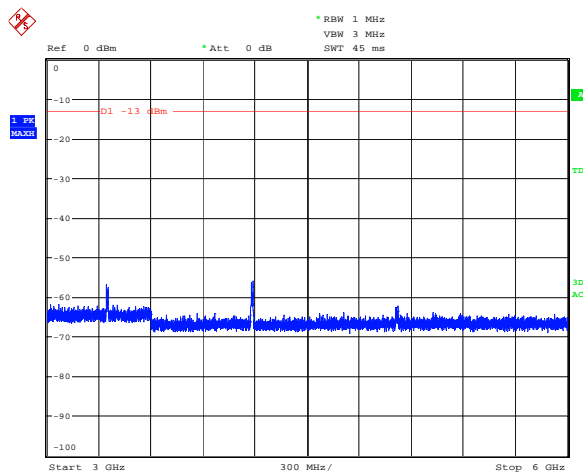

HSUPA

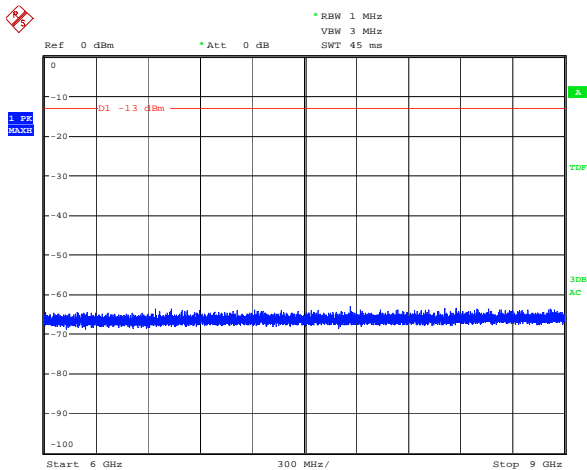

Normal

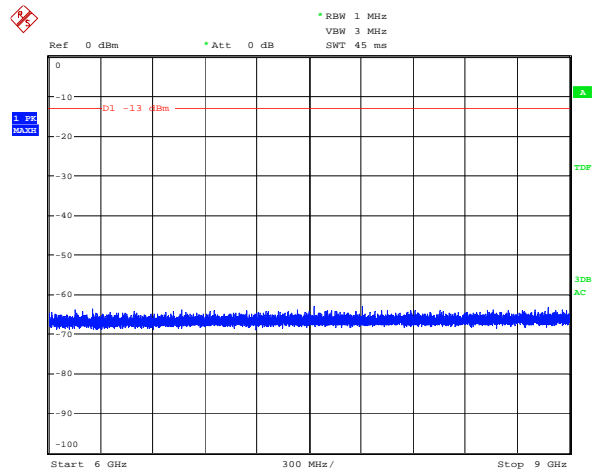

HSUPA

Test Equipment Used

Equipment name	RFT ID No.
Spectrum Analyzer	TR06
RF tester	RC03
RF cable	CL27
Directional coupler	DC03
High pass filter	HPF2

Final Result

The EUT met the requirements of the standard for this test.

2.7 Transmitter Out of Band Spurious Emissions (Radiated)

Reference Standard

Part22.917

Test Conditions

Date: -
Ambient Temperature: -
Relative humidity: -
Test Voltage: -

Test Method

Substitution method is used for this test.

- a) EUT is set on non-conducting table and the output power is set to the maximum level.
- b) As a receive antenna, Horn antenna is used for high frequency range (above 1GHz), and Biological antenna is used for low frequency range (30MHz to 1GHz).
- c) The maximum level of each spurious emission is measured by a spectrum analyzer (SA) in below conditions.

Turntable is rotated 360 degrees.

The height of receive antenna is changed from 1m to 4m.

Receive antenna polarization is set to vertical and horizontal.

EUT was placed at three different orientations (X, Y and Z axis) in order to find the worst orientation.

This emission level is recorded.

During this measurement, receive antenna is adjusted the direction to keep the EUT within the beamwidth of receive antenna.

- d) Reference antenna is replaced with EUT, and connected with signal generator (SG).
SG output power is adjusted to get same level as the recorded maximum radiated EUT power by SA.
- e) Radiated output power (Pout) is calculated with adjusted SG output (Psg) [dBm], reference antenna gain (Gref) [dBd] and cable loss between SG and reference antenna (Lcab) [dB].

$$P_{out} \text{ [dBm e.r.p]} = P_{sg} + G_{ref} + L_{cab}$$

Test Setup

[Measurement]

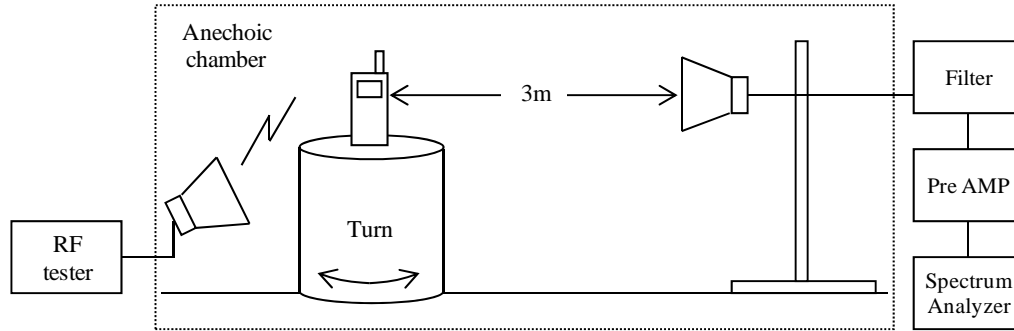

[Substitution]

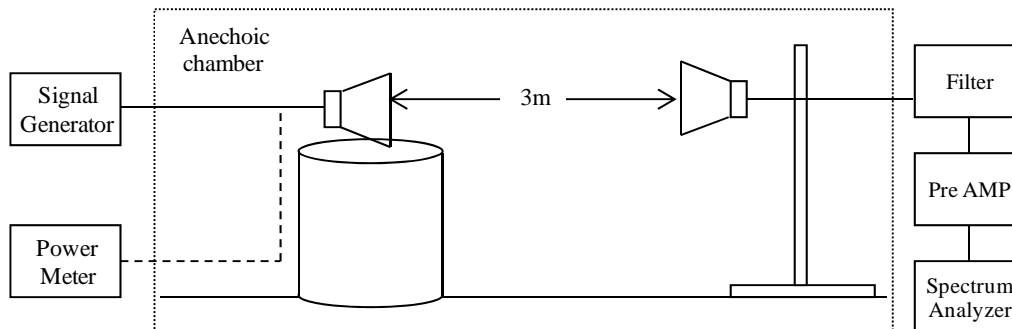

Test Results

Test Equipment Used

Final Result

This item was not tested.

2.8 Band Edge Emissions

Reference Standard

Part22.917

Test Conditions

Date: 01 Mar, 2011
 Ambient Temperature: 22 degC
 Relative humidity: 47 %
 Test Voltage: 3.7 VDC

Test Method

- EUT is connected to RF tester with Max transmitter power level.
- Lower band edge level is measured in bottom channel transmission.
- Higher band edge level is measured in top channel transmission.
- 1% of band width is used for resolution band width for spectrum analyzer.

Test Setup

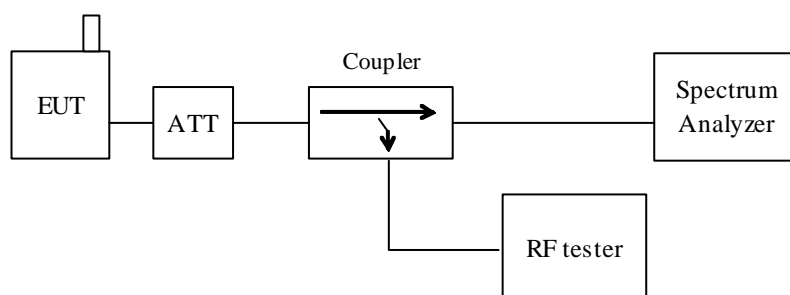

Test Results

Bottom Band Edge

Mode	Measured Frequency [MHz]	Peak Level [dBm]	Limit [dBm]	Result
Normal	824.000	-22.2	-13.0	Pass
HSDPA	823.901	-22.2	-13.0	Pass
HSUPA	823.662	-21.7	-13.0	Pass

Top Band Edge

Mode	Measured Frequency [MHz]	Peak Level [dBm]	Limit [dBm]	Result
Normal	849.000	-20.1	-13.0	Pass
HSDPA	849.099	-22.0	-13.0	Pass
HSUPA	849.000	-21.1	-13.0	Pass

Graphical Data

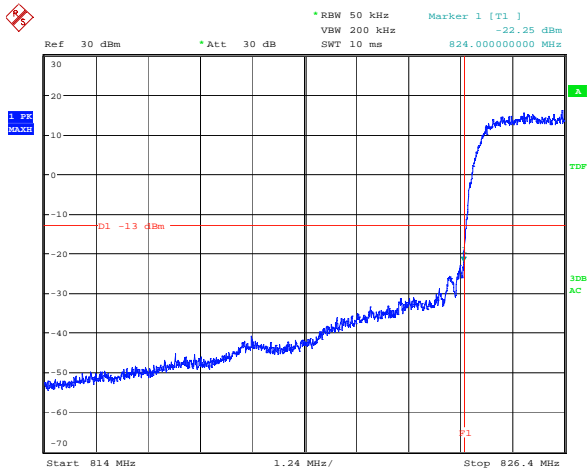

Bottom Band Edge (Normal)

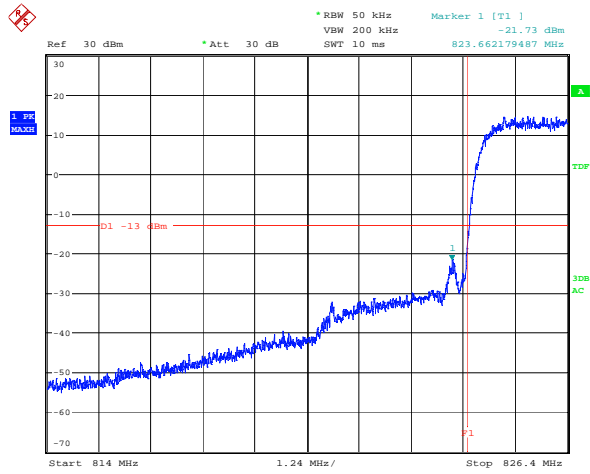

Bottom Band Edge (HSUPA)

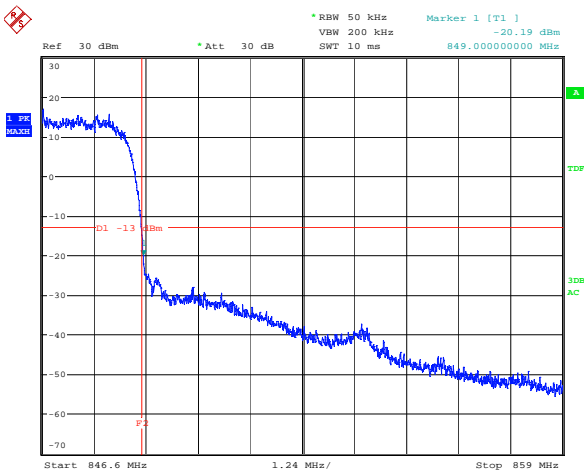

Top Band Edge (Normal)

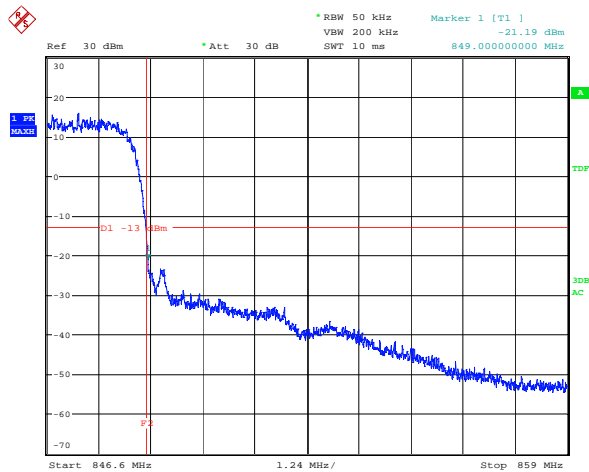

Top Band Edge (HSUPA)

Test Equipment Used

Equipment name	RFT ID No.
Spectrum Analyzer	TR06
RF tester	RC03
RF cable	CL27
Directional coupler	DC03

Final Result

The EUT met the requirements of the standard for this test.

2.9 Transmitter AC Power Line Emission requirement

Reference Standard

Part15.207

Test Conditions

Date: -
 Ambient Temperature: -
 Relative humidity: -
 Test Voltage: -

Test Method

- a) EUT is connected to RF tester with Max transmitter power level.
- b) AC power is supplied to AC charger through LISN.
- c) AC charger is connected to EUT.
- d) AC Line conducted emission is measured by EMI receiver.
 Both Va/Vb line are measured emission level.

Test Setup

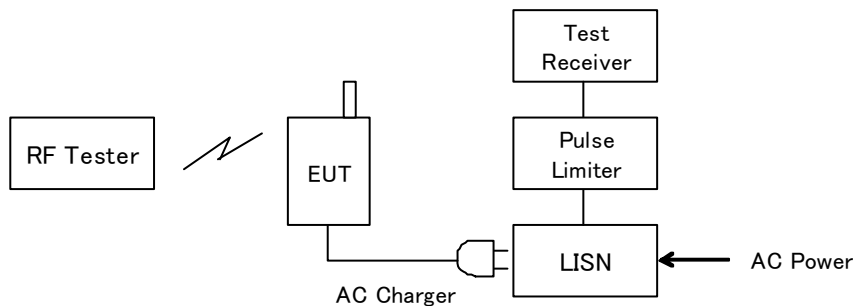

Limit

Frequency [MHz]	Limit QP [dB μ V]	Limit AVE [dB μ V]
0.15 - 0.5	66 - 56	56 - 46
0.5 - 5	56	46
5 - 30	60	50

Test Results

Graphical Data

Test Equipment Used

Final Result

This item was not tested.

4 List of utilized test equipment/ calibration

RFT ID No.	Kind of Equipment and Precision	Manufacturer	Model No.	Serial Number	Calibration Date	Calibrated until
CL27	RF Cable 0.5m	SUHNER	SUCOFLEX104	230286	2010/6/15	2011/6/30
DC03	Directional Coupler	Merrimac	CWM-10R-10.2G	83263	2010/7/2	2011/7/31
HPF2	High Pass Filter (1500MHz)	M-City	HPF0900-01	RF0003-01	2010/6/15	2011/6/30
TR06	Test Receiver (F/W : 3.93 SP2)	Rohde & Schwarz	ESU26	100002	2010/9/2	2011/9/30
RC03	Radio communication tester (F/W : 10.20 #005)	Anritsu	MT8820B	6200636657	2010/6/10	2011/6/30
TC01	Temperature Chamber	ESPEC	SH-641	92000964	2010/11/19	2011/11/30

The measuring equipment, which was utilized in performing the tests documented herein, has been calibrated in accordance with the manufacturer's recommendations for utilizing calibration equipment, which is traceable to recognized national standards.