

TEST REPORT

For

Mobile Phone (GSM/GPRS1900)

In conformity with

FCC Part24E (01 Oct, 2009)

Model: F-09C
FCC ID: VQK-F09C
Test Item: Mobile Phone
Report No: RY1103P09R1
Issue Date: 09 Mar, 2011

Prepared for

FUJITSU LIMITED
1-1, Kamikodanaka 4-chome, Nakahara-ku, Kawasaki 211-8588,
Japan

Prepared by

RF Technologies Ltd.
472, Nippa-cho, Kohoku-ku, Yokohama, 223-0057, Japan
Telephone: +81+(0)45- 534-0645
FAX: +81+(0)45- 534-0646

This report shall not be reproduced, except in full, without the written permission of RF Technologies Ltd. The test results in this report apply only to the sample(s) tested. RF Technologies Ltd. is managed to ISO17025 and has the necessary knowledge and test facilities for testing according to the referenced standards.

Table of Contents

1	General information	3
1.1	Product description	3
1.2	Test(s) performed/ Summary of test result	3
1.3	Test facility	4
1.4	Measurement uncertainty	4
1.5	Description of essential requirements and test results.....	5
1.5.1	Transmitter requirements	5
1.5.2	AC Power Line Parameters.....	5
1.5.3	Normal test conditions	5
1.5.4	Extreme test conditions.....	5
1.6	Setup of equipment under test (EUT)	6
1.6.1	Test configuration of EUT	6
1.6.2	Operating condition:	6
1.6.3	Setup diagram of tested system:.....	6
1.7	Equipment modifications	6
1.8	Deviation from the standard.....	6
2	Test procedure and result.....	7
2.1	Carrier Output Power (Conducted).....	7
2.2	Carrier Output Power (Radiated)	8
2.3	Frequency Stability (Temperature)	10
2.4	Frequency Stability (Voltage).....	12
2.5	Occupied Bandwidth.....	13
2.6	Transmitter Out of Band Spurious Emissions (Conducted).....	15
2.7	Transmitter Out of Band Spurious Emissions (Radiated).....	19
2.8	Band Edge Emissions.....	21
2.9	Transmitter AC Power Line Emission requirement.....	23
3	Test setup photographs.....	24
4	List of utilized test equipment/ calibration.....	25

History

Report No.	Issue Date	Revision Contents	Issued by
RY1103P09R1	09 Mar, 2011	Initial Issue	T.Kato

1 General information

1.1 Product description

Test item : Mobile Phone
Manufacturer : FUJITSU LIMITED
Address : 1-1, Kamikodanaka 4-chome, Nakahara-ku, Kawasaki 211-8588, Japan
Model : F-09C
FCC ID : VQK-F09C
Operating frequency range : TX 1850.2-1909.8 MHz (GSM1900/GPRS Class8)
: RX 1930.2-1989.8 MHz (GSM1900/GPRS Class8)
Type of Modulation : GMSK
Receipt date of EUT : 14 Feb, 2011
Nominal power voltages : 3.7 VDC
Power Class : 1 (Maximum power 30dBm nominal)
Antenna Type : Integral Antenna
Serial numbers : 3551 1504 0014 190

1.2 Test(s) performed/ Summary of test result

Applicable Standard(s) : FCC Part24E (01 Oct, 2009)
Test(s) started : 28 Feb, 2011
Test(s) completed : 09 Mar, 2011
Purpose of test(s) : Certification of FCC
Summary of test result : Complied (RF conducted test only)

Note: The above judgment is only based on the measurement data and it does not include the measurement uncertainty. Accordingly, the statement below is applied to the test result. The EUT complies with the limit required in the standard in case that the margin is not less than the measurement uncertainty in the Laboratory. Compliance of the EUT is more probable than non-compliance is case that the margin is less than the measurement uncertainty in the Laboratory.

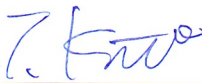
Test engineer : 
T. Kato (Engineer, EMC testing department)

Reviewer : 
K. Ohnishi (Manager, EMC testing department)

1.3 Test facility

The Federal Communications Commission has reviewed the technical characteristics of the test facilities at RF Technologies Ltd., located in 472, Nippa-cho, Kohoku-ku, Yokohama, 223-0057, Japan, and has found these test facilities to be in compliance with the requirements of 47 CFR Part 15, section 2.948, per 01 October, 2009. The description of the test facilities has been filed under registration number 319924 at the Office of the Federal Communications Commission. The facility has been added to the list of laboratories performing these test services for the public on a fee basis.

The list of all public test facilities is available on the Internet at <http://www.fcc.gov>.

Registered by Voluntary Control Council for Interference by Information Technology Equipment (VCCI).

Each registered facility number is as follows;

Test site (Semi-anechoic chamber 3m) R-2393

Test site (Shielded room) C-2617

Registered by Industry Canada (IC). The registered facility number is as follows;

Test site No.1(Semi-anechoic chamber 3m) : 6974A-1

Accredited by **National Voluntary Laboratory Accreditation Program (NVLAP)** for the emission tests stated in the scope of the certificate under Certificate Number 200780-0

This report must not be used by the client to claim product certification, approval, or endorsement by NVLAP, NIST, or any agency of the Federal Government.



NVLAP LAB CODE 200780-0

1.4 Measurement uncertainty

The treatment of uncertainty is based on the general matters on the definition of uncertainty in “Guide to the expression of uncertainty in measurement (GUM)” published by ISO. The Lab’s uncertainty is determined by referring UKAS Publication LAB34: 2002 “The Expression of Uncertainty in EMC Testing” and CISPR16-4-2: 2003 “Uncertainty in EMC Measurements”.

The uncertainty of the measurement result in the level of confidence of approximately 95% (k=2) is as follows;

RF frequency: $\pm 1 \times 10^{-7}$

RF power conducted: ± 1.1 dB

AC power line emission: ± 1.9 dB

Radiated emission (30 MHz - 1000 MHz): ± 5.9 dB

Radiated emission (1 GHz - 20 GHz): ± 5.8 dB

Temperature: ± 1 degree

Humidity: ± 5 %

1.5 Description of essential requirements and test results

An overview of radio requirements, as laid out in FCC Part24 are given below.

1.5.1 Transmitter requirements

Test Description	Section in this report	Test Performed	Result
Carrier Output Power (Conducted)	2.1	Yes	Passed
Carrier Output Power (Radiated)	2.2	No	-
Frequency Stability (Temp. Variation)	2.3	Yes	Passed
Frequency Stability (Voltage Variation)	2.4	Yes	Passed
Occupied Bandwidth	2.5	Yes	Passed
Out of Band Emissions (Conducted)	2.6	Yes	Passed
Out of Band Emissions (Radiated)	2.7	No	-
Band Edge Emissions	2.8	Yes	Passed

1.5.2 AC Power Line Parameters

Test Description	Section in this report	Test Performed	Result
AC power line Spurious Emissions (Traffic mode)	2.9	No	-

1.5.3 Normal test conditions

Temperature(*) : +15 degC to +35 degC
 Relative humidity(*) : 20 % to 75 %
 Supply voltage : 3.7 VDC (Nominal)
 Measurement Frequency : 1850.2 MHz(512ch), 1880.0 MHz(661ch), 1909.8 MHz(810ch)

* When it is impracticable to carry out tests under these conditions, a note to this effect, stating the ambient temperature and relative humidity during the tests, must be stated separately.

1.5.4 Extreme test conditions

Temperature : -30 °C (min) to +50 °C (max)
 Supply voltage : 3.33 VDC [min] to 4.07 VDC [max] (declared by manufacturer)

1.6 Setup of equipment under test (EUT)

1.6.1 Test configuration of EUT

Equipment(s) under test:

	Item	Manufacturer	Model No.	Serial No.
A	Mobile Phone	FUJITSU LIMITED	F-09C	3551 1504 0014 190

Support Equipment(s):

	Item	Manufacturer	Model No.	Serial No.	Comment
B	-	-	-	-	-

Connected cable(s):

No.	Item	Identification (Manu.e.t.c)	Shielded Yes / No	Ferrite Core Yes / No	Connector Type Shielded Yes / No	Length (m)
-	-	-	-	-	-	-

1.6.2 Operating condition:

Traffic mode : EUT is connected with RF tester in Max power level. (GSM/GPRS mode)

1.6.3 Setup diagram of tested system:



1.7 Equipment modifications

No modifications have been made to the equipment in order to achieve compliance with the applicable standards described in clause 1.2.

1.8 Deviation from the standard

No deviations from the standards described in clause 1.2.

2 Test procedure and result

2.1 Carrier Output Power (Conducted)

Reference Standard

Part24.232, 2.1046

Test Conditions

Date: 28 Feb, 2011
 Ambient Temperature: 22 degC
 Relative humidity: 43 %
 Test Voltage: 3.7 VDC

Test Method

- a) EUT is connected to RF tester with pseudo random data modulation and set to maximum output power level.
- b) The peak output power is measured with RF tester (CMU200 etc.).

Test Setup

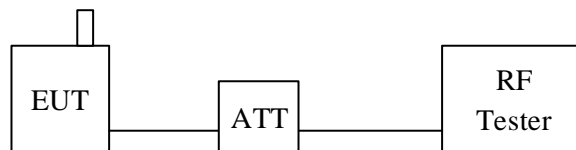

Test Results

Channel	Frequency [MHz]	Output Power [dBm]	
		Normal	GPRS
Bottom (512ch)	1850.2	29.4	29.4
Middle (661ch)	1880.0	29.5	29.5
Top (810ch)	1909.8	29.6	29.6

EUT can employ a power control function that output power can be controlled from +30dBm to +0dBm (nominal) by 2dB step. So EUT meet the requirement of Part24.232(c).

Test Equipment Used

Equipment name	RFT ID No.
RF tester	RC03
RF cable	CL27

2.2 Carrier Output Power (Radiated)

Reference Standard

Part24.232, 2.1046

Test Conditions

Date: -
Ambient Temperature: -
Relative humidity: -
Test Voltage: -

Test Method

Substitution method is used for this test.

- a) EUT is set on non-conducting table and the output power is set to the maximum level.
- b) As a receive antenna, Horn antenna is used.
- c) Maximum peak power is measured by a spectrum analyzer(SA) in below conditions.
 - Turntable is rotated 360 degrees.
 - The height of receive antenna is changed from 1m to 4m.
 - Receive antenna polarization is set to vertical and horizontal.This maximum peak power is recorded.

During this measurement, receive antenna is adjusted the direction to keep the EUT within the beamwidth of receive antenna.
- d) Reference antenna is replaced with EUT, and connected with signal generator(SG).

SG output power is adjusted to get same level as the recorded maximum radiated EUT power by SA.
- e) Radiated output power (Pout) is calculated with adjusted SG output (Psg) [dBm], reference antenna gain (Gref) [dBi] and cable loss between SG and reference antenna (Lcab) [dB].

$$P_{out} \text{ [dBm e.i.r.p]} = P_{sg} + G_{ref} + L_{cab}$$

Test Setup

[Measurement]

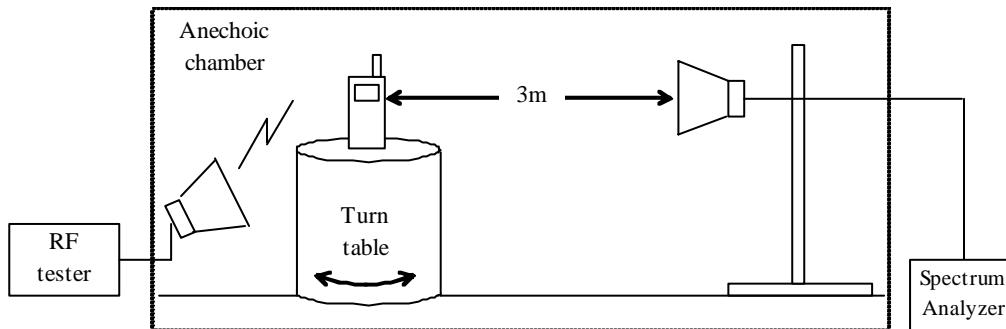

[Substitution]

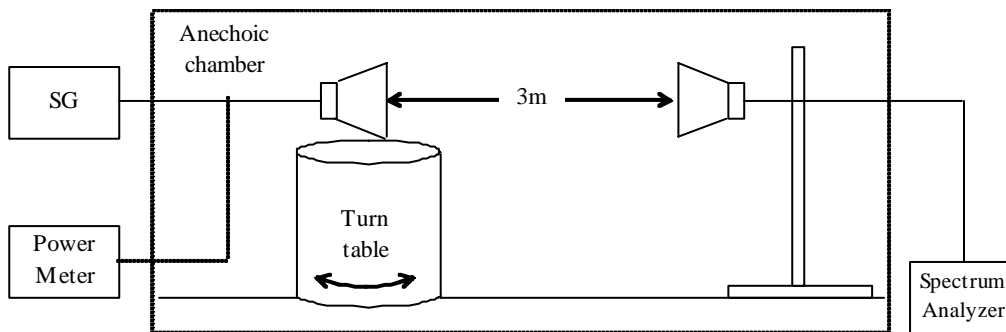

Test Results

Test Equipment Used

Final Result

This item was not tested.

2.3 Frequency Stability (Temperature)

Reference Standard

Part24.235, 2.1055

Test Conditions

Date: 09 Mar, 2011
Ambient Temperature: 22 degC
Relative humidity: 27 %
Test Voltage: 3.7 VDC

Test Method

To measure the carrier frequency, “Frequency error measurement” function of RF tester is used.

- a) EUT is hold about 30 minutes under measurement temperature condition.
- b) EUT is powered on with nominal voltage.
- c) EUT is connected to RF tester with Max transmit power level.
- d) Frequency error is measured by RF tester for 10 minutes.
- e) Process a) to d) is repeated at 10deg increments from -30 to +50degC.

Test Setup

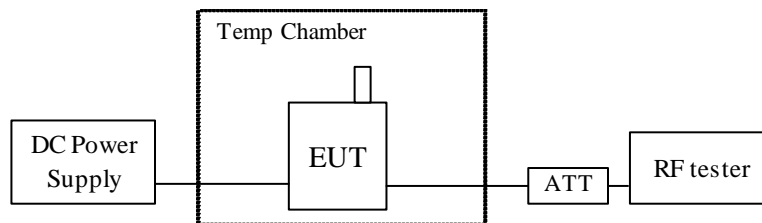

Test Results**Middle Channel (661ch, Nominal Freq.:1880.0MHz)**

Temperature [deg C]	Frequency Error [Hz]	Frequency Error [ppm]	Limit [ppm]	Result
-30	- 62	- 0.03	± 2.5	Pass
-20	- 60	- 0.03	± 2.5	Pass
-10	- 60	- 0.03	± 2.5	Pass
0	- 65	- 0.03	± 2.5	Pass
10	- 67	- 0.04	± 2.5	Pass
20	- 63	- 0.03	± 2.5	Pass
30	- 66	- 0.04	± 2.5	Pass
40	- 65	- 0.03	± 2.5	Pass
50	- 65	- 0.03	± 2.5	Pass

Test Equipment Used

Equipment name	RFT ID No.
RF tester	RC03
Temp chamber	TC01

Final Result

The EUT met the requirements of the standard for this test.

2.4 Frequency Stability (Voltage)

Reference Standard

Part24.235, 2.1055

Test Conditions

Date: 09 Mar, 2011
 Ambient Temperature: 22 degC
 Relative humidity: 27 %
 Test Voltage: 3.33 to 4.07 VDC

Test Method

To measure the carrier frequency, “Frequency error measurement” function of RF tester is used.

- a) EUT is powered on with nominal voltage. Temperature is 20degC.
- b) EUT is connected to RF tester with Max transmitter power level.
- c) Frequency error is measured by RF tester for 10 minutes.
- d) Process a) to c) is repeated at minimum and maximum voltage condition.

Test Setup

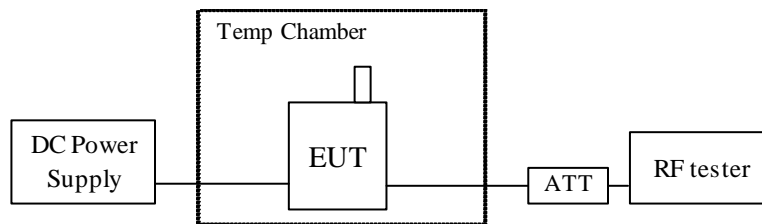

Test Results

Middle Channel (661ch, Nominal Freq.:1880.0MHz)

Voltage [V]	Frequency Error [Hz]	Frequency Error [ppm]	Limit [ppm]	Result
3.0	- 63	- 0.03	± 2.5	Pass
3.3	- 63	- 0.03	± 2.5	Pass
3.6	- 62	- 0.03	± 2.5	Pass

Test Equipment Used

Equipment name	RFT ID No.
RF tester	RC03
Temp chamber	TC01

Final Result

The EUT met the requirements of the standard for this test.

2.5 Occupied Bandwidth

Reference Standard

Part24.238

Test Conditions

Date: 28 Feb, 2011
 Ambient Temperature: 22 degC
 Relative humidity: 43 %
 Test Voltage: 3.7 VDC

Test Method

- a) EUT is connected to RF tester with Max transmitter power level.
- b) 26dB bandwidth is measured by Spectrum Analyzer.
- c) 99% occupied bandwidth of transmitter spectrum is measured by Spectrum Analyzer.

Test Setup

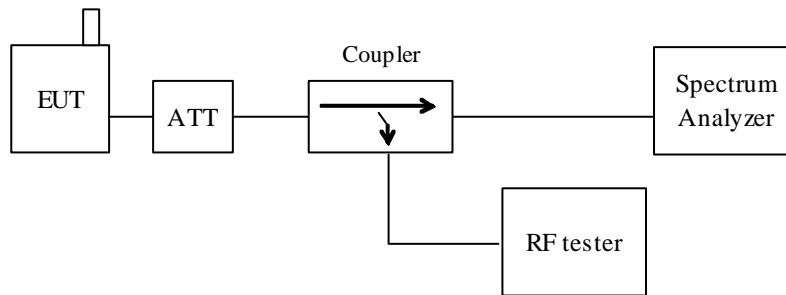

Test Results

Channel	Frequency [MHz]	26dB Bandwidth [kHz]	99% Bandwidth [kHz]
Bottom (512ch)	1850.2	315	250
Middle (661ch)	1880.0	322	248
Top (810ch)	1909.8	318	252

Test Equipment Used

Equipment name	RFT ID No.
Spectrum Analyzer	TR06
RF tester	RC03
RF cable	CL27
Directional Coupler	DC03

Graphical Data

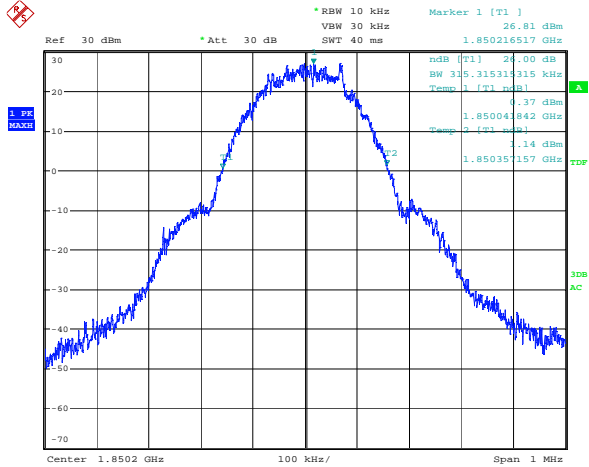

26dB Bandwidth (512ch)

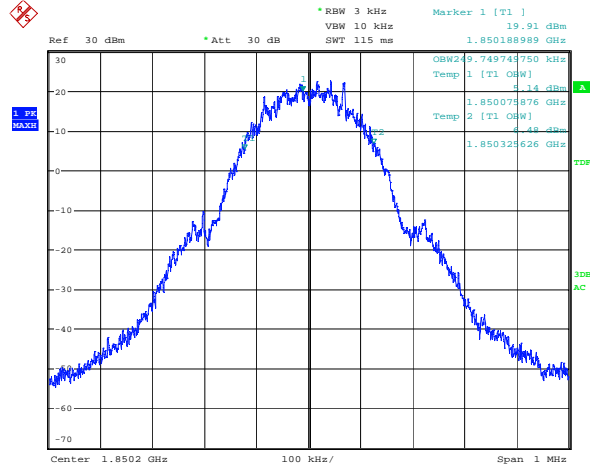

Occupied Bandwidth (512ch)

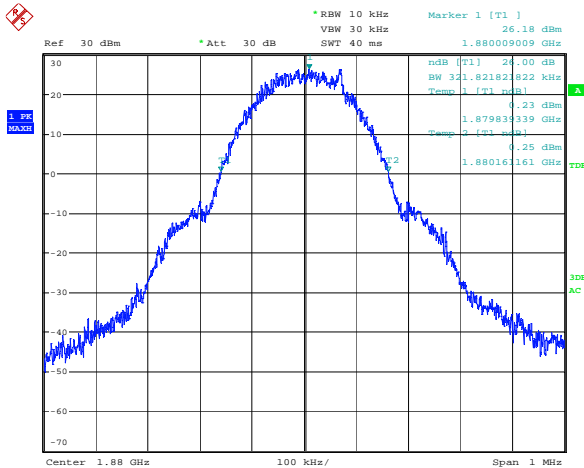

26dB Bandwidth (661ch)

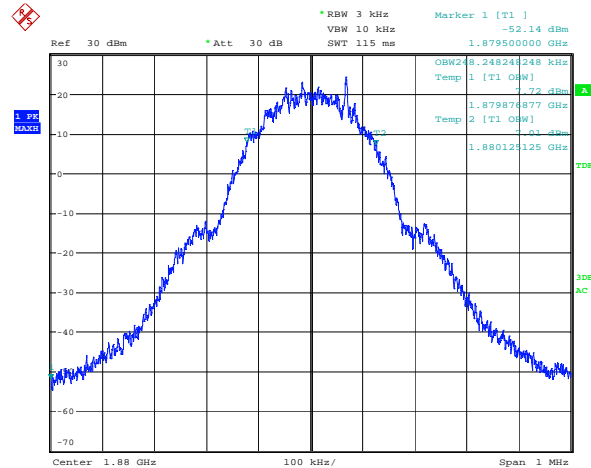

Occupied Bandwidth (661ch)

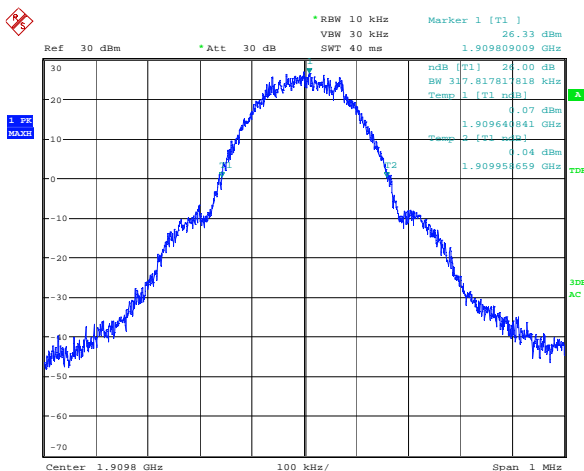

26dB Bandwidth (810ch)

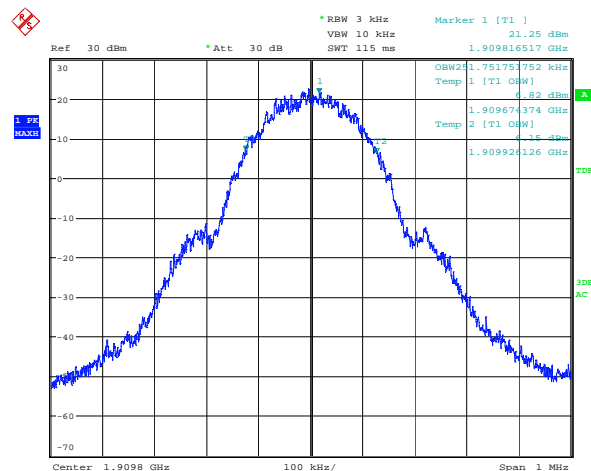

Occupied Bandwidth (810ch)

2.6 Transmitter Out of Band Spurious Emissions (Conducted)

Reference Standard

Part24.238

Test Conditions

Date: 28 Feb, 2011
Ambient Temperature: 22 degC
Relative humidity: 43 %
Test Voltage: 3.7 VDC

Test Method

- EUT is connected to RF tester with Max transmitter power level.
- Out of band Spurious is measured by Spectrum Analyzer.
- Resolution band width of spectrum analyzer is set to 1MHz (above 1GHz) or 100kHz (below1GHz).

Test Setup

30MHz to 3500MHz

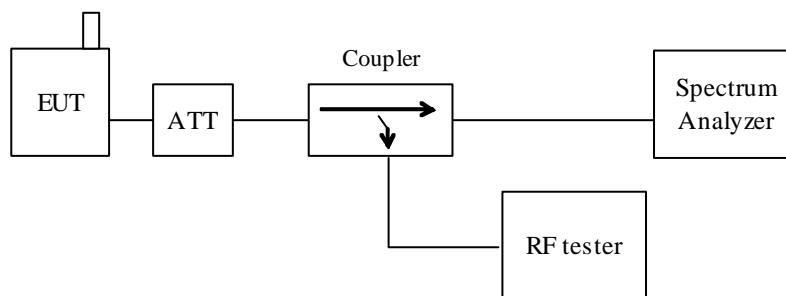

above 3500MHz

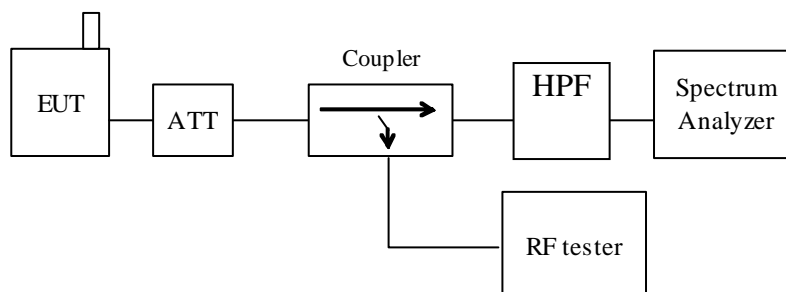

Test Results

Bottom Channel (512ch, Nominal Freq.:1850.2MHz)

Measurement Frequency [MHz]	Measurement Bandwidth [MHz]	Emission Level [dBm]	Limit [dBm]	Result Pass/Fail
3700.4	1	-52.0	-13.0	Pass
5550.6	1	-57.3	-13.0	Pass
7400.8	1	< -60.0	-13.0	Pass
9251.0	1	< -60.0	-13.0	Pass
11101.2	1	< -60.0	-13.0	Pass
12951.4	1	< -60.0	-13.0	Pass
14801.6	1	< -60.0	-13.0	Pass
16651.8	1	< -60.0	-13.0	Pass
18502.0	1	< -60.0	-13.0	Pass
others		-	-13.0	Pass

Middle Channel (661ch, Nominal Freq.:1880.0MHz)

Measurement Frequency [MHz]	Measurement Bandwidth [MHz]	Emission Level [dBm]	Limit [dBm]	Result Pass/Fail
3760.0	1	-50.7	-13.0	Pass
5640.0	1	-56.4	-13.0	Pass
7520.0	1	< -60.0	-13.0	Pass
9400.0	1	< -60.0	-13.0	Pass
11280.0	1	< -60.0	-13.0	Pass
13160.0	1	< -60.0	-13.0	Pass
15040.0	1	< -60.0	-13.0	Pass
16920.0	1	< -60.0	-13.0	Pass
18800.0	1	< -60.0	-13.0	Pass
others		-	-13.0	Pass

Top Channel (810ch, Nominal Freq.:1909.8MHz)

Measurement Frequency [MHz]	Measurement Bandwidth [MHz]	Emission Level [dBm]	Limit [dBm]	Result Pass/Fail
3819.6	1	-50.1	-13.0	Pass
5729.4	1	-55.5	-13.0	Pass
7639.2	1	< -60.0	-13.0	Pass
9549.0	1	< -60.0	-13.0	Pass
11458.8	1	< -60.0	-13.0	Pass
13368.6	1	< -60.0	-13.0	Pass
15278.4	1	< -60.0	-13.0	Pass
17188.2	1	< -60.0	-13.0	Pass
19098.0	1	< -60.0	-13.0	Pass
others		-	-13.0	Pass

Graphical Data (661ch, Pre-scan data)

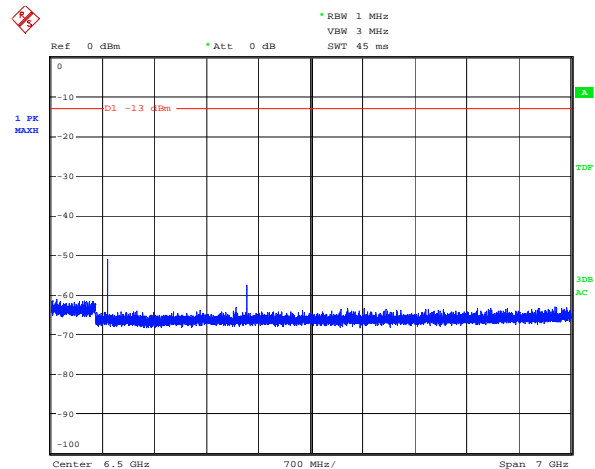
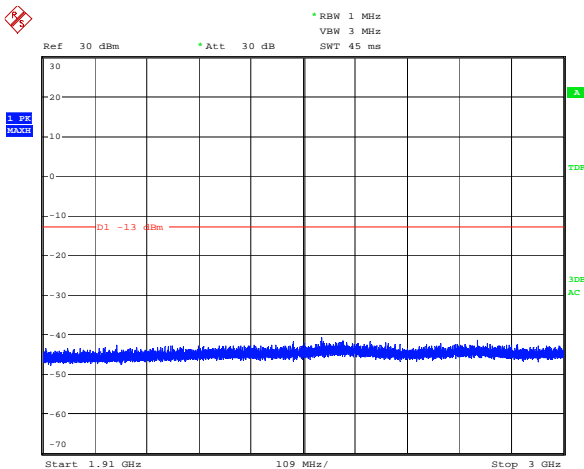
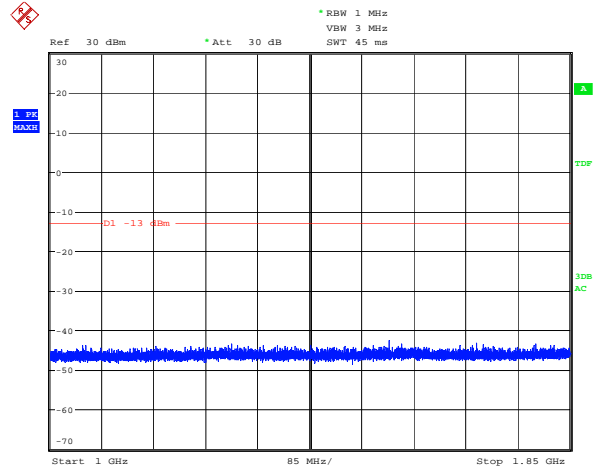
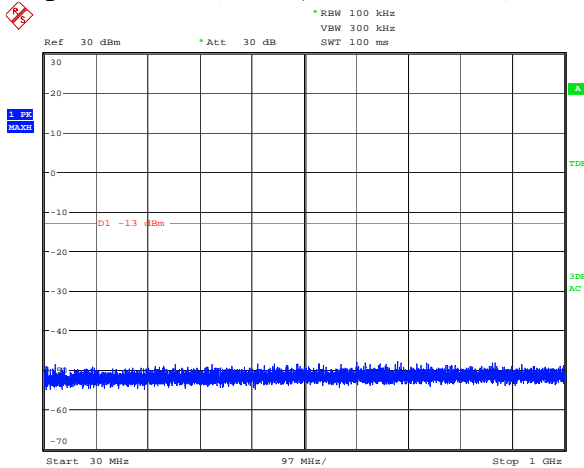

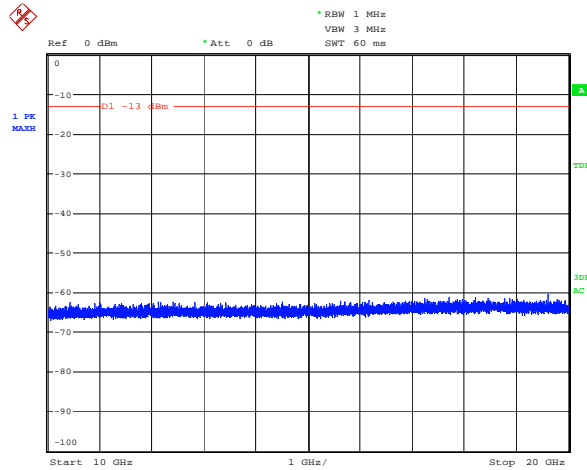

Test Equipment Used

Equipment name	RFT ID No.
Spectrum Analyzer	TR06
RF tester	RC03
RF cable	CL27
High pass filter	HPF4
Directional coupler	DC03

Final Result

The EUT met the requirements of the standard for this test.

2.7 Transmitter Out of Band Spurious Emissions (Radiated)

Reference Standard

Part24.238

Test Conditions

Date: -
Ambient Temperature: -
Relative humidity: -
Test Voltage: -

Test Method

Substitution method is used for this test.

- a) EUT is set on non-conducting turntable and the output power is set to the maximum level.
- b) As a receive antenna, Horn antenna is used for high frequency range (above 1GHz), and Bilogical antenna is used for low frequency range (30MHz to 1GHz).
- c) The maximum level of each spurious emission is measured by a spectrum analyzer(SA) in below conditions.

Turntable is rotated 360 degrees.

The height of receive antenna is changed from 1m to 4m.

Receive antenna polarization is set to vertical and horizontal.

EUT was placed at three different orientations (X, Y and Z axis) in order to find the worst orientation.

This emission level is recorded.

During this measurement, receive antenna is adjusted the direction to keep the EUT within the beamwidth of receive antenna.

- d) Reference antenna is replaced with EUT, and connected with signal generator(SG).
SG output power is adjusted to get same level as the recorded maximum radiated EUT power by SA.
- e) Radiated output power (Pout) is calculated with adjusted SG output (Psg) [dBm],
reference antenna gain (Gref) [dBd] and cable loss between SG and reference antenna (Lcab) [dB].

$$Pout \text{ [dBm e.r.p]} = Psg + Gref + Lcab$$

Test Setup

[Measurement]

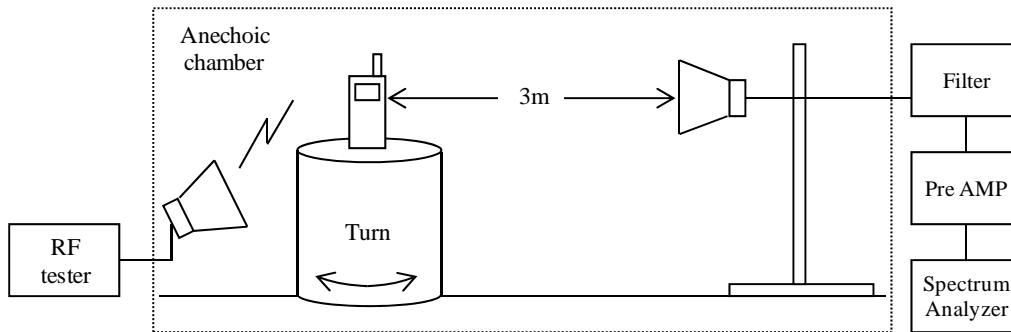

[Substitution]

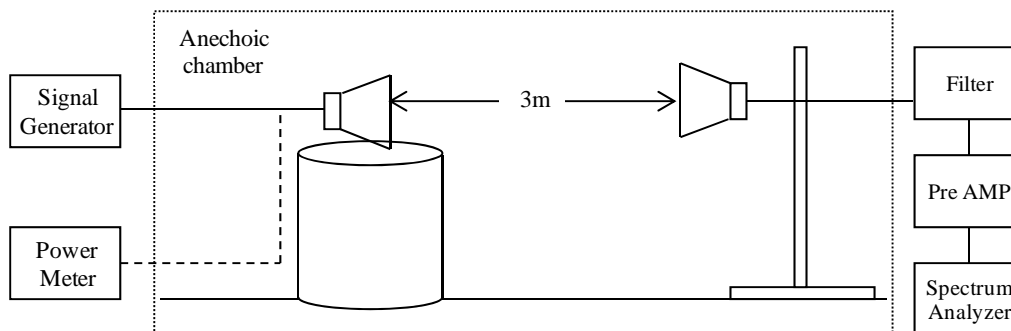

Test Results

Test Equipment Used

Final Result

This item was not tested.

2.8 Band Edge Emissions

Reference Standard

Part24.238

Test Conditions

Date: 28 Feb, 2011
 Ambient Temperature: 22 degC
 Relative humidity: 43 %
 Test Voltage: 3.7 VDC

Test Method

- a) EUT is connected to RF tester with Max transmitter power level.
- b) Lower band edge level is measured in bottom channel transmission.
- c) Higher band edge level is measured in top channel transmission.
- d) 1% of band width is used for resolution band width for spectrum analyzer.

Test Setup

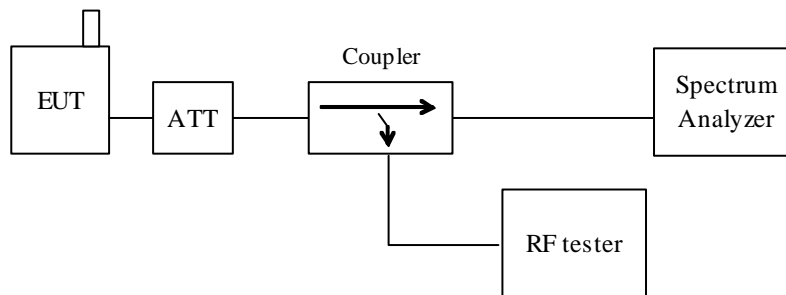

Test Results

Bottom Band Edge

Measured Frequency [MHz]	Peak Level [dBm]	Limit [dBm]	Result
1849.996	-14.1	-13.0	Pass

Top Band Edge

Measured Frequency [MHz]	Peak Level [dBm]	Limit [dBm]	Result
1910.021	-13.7	-13.0	Pass

Graphical Data

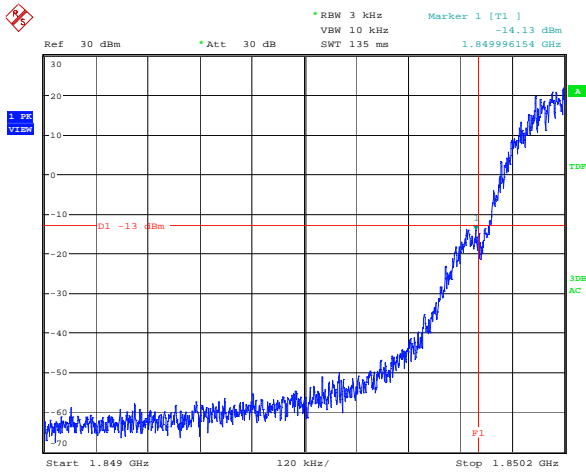

Bottom Band Edge

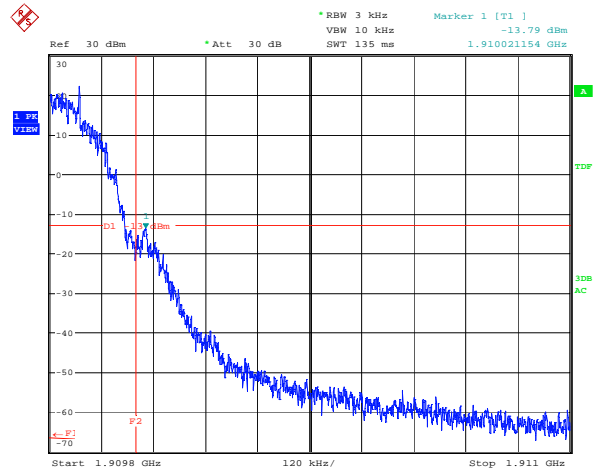

Top Band Edge

Test Equipment Used

Equipment name	RFT ID No.
Spectrum Analyzer	TR06
RF tester	RC03
RF cable	CL27
Directional Coupler	DC03

Final Result

The EUT met the requirements of the standard for this test.

2.9 Transmitter AC Power Line Emission requirement

Reference Standard

Part15.207

Test Conditions

Date: -
 Ambient Temperature: -
 Relative humidity: -
 Test Voltage: -

Test Method

- a) EUT is connected to RF tester with Max transmitter power level.
- b) AC power is supplied to AC charger through LISN.
- c) AC charger is connected to EUT.
- d) AC Line conducted emission is measured by EMI receiver.
 Both Va/Vb line are measured emission level.

Test Setup

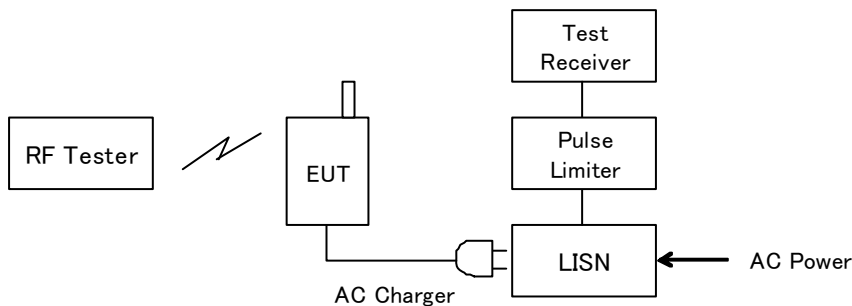

Limit

Frequency [MHz]	Limit QP [dBμV]	Limit AVE [dBμV]
0.15 - 0.5	66 - 56	56 - 46
0.5 - 5	56	46
5 - 30	60	50

Test Results

Graphical Data

Test Equipment Used

Final Result

This item was not tested.

4 List of utilized test equipment / calibration

RFT ID No.	Kind of Equipment and Precision	Manufacturer	Model No.	Serial Number	Calibration Date	Calibrated until
CL27	RF Cable 0.5m	SUHNER	SUCOFLEX104	230286	2010/6/15	2011/6/30
DC03	Directional Coupler	Merrimac	CWM-10R-10.2G	83263	2010/7/2	2011/7/31
HPF4	High Pass Filter (3000MHz)	Tokyo KEIKI	TF23LCCZGA	9001	2010/10/14	2011/10/31
TR06	Test Receiver (F/W : 3.93 SP2)	Rohde & Schwarz	ESU26	100002	2010/9/2	2011/9/30
RC03	Radio communication tester (F/W : 10.20 #005)	Anritsu	MT8820B	6200636657	2010/6/10	2011/6/30
TC01	Temperature Chamber	ESPEC	SH-641	92000964	2010/11/19	2011/11/30

The measuring equipment, which was utilized in performing the tests documented herein, has been calibrated in accordance with the manufacturer's recommendations for utilizing calibration equipment, which is traceable to recognized national standards.