



FCC TEST REPORT

REPORT NO.: RF140326C05-6

MODEL NO.: F-06F

FCC ID: VQK-F06F

RECEIVED: Mar. 26, 2014

TESTED: Apr. 29 ~ May 08, 2014

ISSUED: May 29, 2014

APPLICANT: FUJITSU LIMITED

ADDRESS: 1-1, Kamikodanaka 4-chome, Nakahara-ku,
Kawasaki 211-8588, Japan

ISSUED BY: Bureau Veritas Consumer Products Services (H.K.)
Ltd., Taoyuan Branch

LAB ADDRESS: No. 47, 14th Ling, Chia Pau Vil., Lin Kou Dist.,
New Taipei City, Taiwan, R.O.C.

TEST LOCATION: No. 19, Hwa Ya 2nd Rd, Wen Hwa Tsuen, Kwei
Shan Hsiang, Taoyuan Hsien 333, Taiwan, R.O.C.

This report should not be used by the client to claim product certification, approval, or endorsement by TAF or any government agencies.



This report is for your exclusive use. Any copying or replication of this report to or for any other person or entity, or use of our name or trademark, is permitted only with our prior written permission. This report sets forth our findings solely with respect to the test samples identified herein. The results set forth in this report are not indicative or representative of the quality or characteristics of the lot from which a test sample was taken or any similar or identical product unless specifically and expressly noted. Our report includes all of the tests requested by you and the results thereof based upon the information that you provided to us. You have 60 days from date of issuance of this report to notify us of any material error or omission caused by our negligence, provided, however, that such notice shall be in writing and shall specifically address the issue you wish to raise. A failure to raise such issue within the prescribed time shall constitute your unqualified acceptance of the completeness of this report, the tests conducted and the correctness of the report contents. Unless specific mention, the uncertainty of measurement has been explicitly taken into account to declare the compliance or non-compliance to the specification.

Table of Contents

RELEASE CONTROL RECORD	4
1. CERTIFICATION	5
2. SUMMARY OF TEST RESULTS	6
2.1 MEASUREMENT UNCERTAINTY	6
3. GENERAL INFORMATION	7
3.1 GENERAL DESCRIPTION OF EUT	7
3.2 DESCRIPTION OF TEST MODES	8
3.2.1 TEST MODE APPLICABILITY AND TESTED CHANNEL DETAIL	9
3.3 DESCRIPTION OF SUPPORT UNITS	11
3.3.1 CONFIGURATION OF SYSTEM UNDER TEST	11
3.4 GENERAL DESCRIPTION OF APPLIED STANDARDS	12
4. TEST TYPES AND RESULTS	13
4.1 RADIATED EMISSION AND BANDEDGE MEASUREMENT	13
4.1.1 LIMITS OF RADIATED EMISSION AND BANDEDGE MEASUREMENT	13
4.1.2 TEST INSTRUMENTS	14
4.1.3 TEST PROCEDURES	15
4.1.4 DEVIATION FROM TEST STANDARD	15
4.1.5 TEST SETUP	16
4.1.6 EUT OPERATING CONDITIONS	17
4.1.7 TEST RESULTS	18
4.2 CONDUCTED EMISSION MEASUREMENT	26
4.2.1 LIMITS OF CONDUCTED EMISSION MEASUREMENT	26
4.2.2 TEST INSTRUMENTS	26
4.2.3 TEST PROCEDURES	27
4.2.4 DEVIATION FROM TEST STANDARD	27
4.2.5 TEST SETUP	28
4.2.6 EUT OPERATING CONDITIONS	28
4.2.7 TEST RESULTS	29
4.3 NUMBER OF HOPPING FREQUENCY USED	33
4.3.1 LIMIT OF HOPPING FREQUENCY USED	33
4.3.2 TEST SETUP	33
4.3.3 TEST INSTRUMENTS	33
4.3.4 TEST PROCEDURES	33
4.3.5 DEVIATION FROM TEST STANDARD	33
4.3.6 TEST RESULTS	33
4.4 DWELL TIME ON EACH CHANNEL	35
4.4.1 LIMIT OF DWELL TIME USED	35
4.4.2 TEST SETUP	35
4.4.3 TEST INSTRUMENTS	35
4.4.4 TEST PROCEDURES	35
4.4.5 DEVIATION FROM TEST STANDARD	35
4.4.6 TEST RESULTS	36
4.5 CHANNEL BANDWIDTH	38
4.5.1 LIMITS OF CHANNEL BANDWIDTH	38
4.5.2 TEST SETUP	38
4.5.3 TEST INSTRUMENTS	38
4.5.4 TEST PROCEDURE	38
4.5.5 DEVIATION FROM TEST STANDARD	38



A D T

4.5.6	EUT OPERATING CONDITION.....	38
4.5.7	TEST RESULTS	39
4.6	HOPPING CHANNEL SEPARATION	40
4.6.1	LIMIT OF HOPPING CHANNEL SEPARATION	40
4.6.2	TEST SETUP	40
4.6.3	TEST INSTRUMENTS.....	40
4.6.4	TEST PROCEDURES	40
4.6.5	DEVIATION FROM TEST STANDARD	40
4.6.6	TEST RESULTS	41
4.7	MAXIMUM OUTPUT POWER	42
4.7.1	LIMITS OF MAXIMUM OUTPUT POWER MEASUREMENT	42
4.7.2	TEST SETUP	42
4.7.3	TEST INSTRUMENTS.....	42
4.7.4	TEST PROCEDURES	42
4.7.5	DEVIATION FROM TEST STANDARD	42
4.7.6	EUT OPERATING CONDITION.....	42
4.7.7	TEST RESULTS	43
4.8	CONDUCTED OUT OF BAND EMISSION MEASUREMENT	44
4.8.1	LIMITS OF CONDUCTED OUT OF BAND EMISSION MEASUREMENT.....	44
4.8.2	TEST INSTRUMENTS.....	44
4.8.3	TEST PROCEDURE.....	44
4.8.4	DEVIATION FROM TEST STANDARD	44
4.8.5	EUT OPERATING CONDITION.....	44
4.8.6	TEST RESULTS	44
5.	PHOTOGRAPHS OF THE TEST CONFIGURATION.....	47
6.	INFORMATION ON THE TESTING LABORATORIES.....	48
7.	APPENDIX A - MODIFICATIONS RECORDERS FOR ENGINEERING CHANGES TO THE EUT BY THE LAB.....	49



A D T

RELEASE CONTROL RECORD

ISSUE NO.	REASON FOR CHANGE	DATE ISSUED
RF140326C05-6	Original release.	May 29, 2014



1. CERTIFICATION

PRODUCT: Smart Phone
MODEL NO.: F-06F
BRAND: FUJITSU
APPLICANT: FUJITSU LIMITED
TESTED: Apr. 29 ~ May 08, 2014
TEST SAMPLE: ENGINEERING SAMPLE
STANDARDS: **FCC Part 15, Subpart C (Section 15.247)**
ANSI C63.10-2009

The above equipment (model: F-06F) has been tested by **Bureau Veritas Consumer Products Services (H.K.) Ltd., Taoyuan Branch**, and found compliance with the requirement of the above standards. The test record, data evaluation & Equipment Under Test (EUT) configurations represented herein are true and accurate accounts of the measurements of the sample's EMC characteristics under the conditions specified in this report.

PREPARED BY : Celine Chou , **DATE** : May 29, 2014
Celine Chou / Specialist

APPROVED BY : Ken Liu , **DATE** : May 29, 2014
Ken Liu / Senior Manager

2. SUMMARY OF TEST RESULTS

The EUT has been tested according to the following specifications:

APPLIED STANDARD: FCC Part 15, Subpart C			
STANDARD SECTION	TEST TYPE AND LIMIT	RESULT	REMARK
15.207	AC Power Conducted Emission	PASS	Meet the requirement of limit. Minimum passing margin is -15.99dB at 0.46179MHz.
15.247(a)(1) (iii)	Number of Hopping Frequency Used	PASS	Meet the requirement of limit.
15.247(a)(1) (iii)	Dwell Time on Each Channel	PASS	Meet the requirement of limit.
15.247(a)(1)	1. Hopping Channel Separation 2. Spectrum Bandwidth of a Frequency Hopping Sequence Spread Spectrum System	PASS	Meet the requirement of limit.
15.247(b)	Maximum Peak Output Power	PASS	Meet the requirement of limit.
15.205 & 209	Radiated Emissions	PASS	Meet the requirement of limit. Minimum passing margin is -10.4dB at 30.00MHz.
15.247(d)	Band Edge Measurement	PASS	Meet the requirement of limit. Minimum passing margin is -26.0dB at 2400.00MHz.
15.247(d)	Antenna Port Emission	PASS	Meet the requirement of limit.
15.203	Antenna Requirement	PASS	No antenna connector is used.

NOTE: If The Frequency Hopping System operating in 2400-2483.5MHz band and the output power less than 125mW. The hopping channel carrier frequencies separated by a minimum of 25kHz or two-thirds of the 20dB bandwidth of hopping channel whichever is greater.

2.1 MEASUREMENT UNCERTAINTY

Where relevant, the following measurement uncertainty levels have been estimated for tests performed on the EUT as specified in CISPR 16-4-2:

MEASUREMENT	FREQUENCY	UNCERTAINTY
Conducted emissions	150kHz~30MHz	2.44 dB
Radiated emissions	30MHz ~ 200MHz	2.93 dB
	200MHz ~ 1000MHz	2.95 dB
	1GHz ~ 18GHz	2.26 dB
	18GHz ~ 40GHz	1.94 dB

This uncertainty represents an expanded uncertainty expressed at approximately the 95% confidence level using a coverage factor of k=2.

3. GENERAL INFORMATION

3.1 GENERAL DESCRIPTION OF EUT

EUT	Smart Phone
MODEL NO.	F-06F
POWER SUPPLY	3.8Vdc (Battery) 5.0Vdc (Adapter or cradle or host equipment)
MODULATION TYPE	GFSK, $\pi/4$ -DQPSK, 8DPSK
MODULATION TECHNOLOGY	FHSS
TRANSFER RATE	1/2/3Mbps
OPERATING FREQUENCY	2402 ~ 2480MHz
NUMBER OF CHANNEL	79
MAX. OUTPUT POWER	9.484mW
ANTENNA TYPE	$\lambda/4$ Monopole antenna with -4.3dBi gain
ANTENNA CONNECTOR	N/A
I/O PORTS	Refer to user's manual
DATA CABLE	N/A
ACCESSORY DEVICES	Refer to Note as below

NOTE:

1. The EUT contains the following accessories.

No.	Product	Brand	Model	Description
1	Battery	NTT docomo	F30	3.8Vdc, 2100mA , 8.0Wh Type: Li-on
2	Cradle	NTT docomo	F46	Input : 5.0Vdc, 1.5A Output : 5.0Vdc, 1.5A

2. SW version is R06.2e.
3. HW version is V2.1.0.
4. IMEI Code: 352295060015393 and 352295060013901.
5. The above EUT information is declared by manufacturer and for more detailed features description, please refer to the manufacturer's specifications or User's Manual.



3.2 DESCRIPTION OF TEST MODES

79 channels are provided to this EUT:

CHANNEL	FREQ. (MHz)	CHANNEL	FREQ. (MHz)	CHANNEL	FREQ. (MHz)	CHANNEL	FREQ. (MHz)
0	2402	20	2422	40	2442	60	2462
1	2403	21	2423	41	2443	61	2463
2	2404	22	2424	42	2444	62	2464
3	2405	23	2425	43	2445	63	2465
4	2406	24	2426	44	2446	64	2466
5	2407	25	2427	45	2447	65	2467
6	2408	26	2428	46	2448	66	2468
7	2409	27	2429	47	2449	67	2469
8	2410	28	2430	48	2450	68	2470
9	2411	29	2431	49	2451	69	2471
10	2412	30	2432	50	2452	70	2472
11	2413	31	2433	51	2453	71	2473
12	2414	32	2434	52	2454	72	2474
13	2415	33	2435	53	2455	73	2475
14	2416	34	2436	54	2456	74	2476
15	2417	35	2437	55	2457	75	2477
16	2418	36	2438	56	2458	76	2478
17	2419	37	2439	57	2459	77	2479
18	2420	38	2440	58	2460	78	2480
19	2421	39	2441	59	2461		



3.2.1 TEST MODE APPLICABILITY AND TESTED CHANNEL DETAIL

EUT CONFIGURE MODE	APPLICABLE TO				DESCRIPTION
	RE≥1G	RE<1G	PLC	APCM	
A	√	√	√	√	Powered by adapter
B	-	√	√	-	Powered by cradle

Where **RE≥1G**: Radiated Emission above 1GHz **RE<1G**: Radiated Emission below 1GHz
PLC: Power Line Conducted Emission **APCM**: Antenna Port Conducted Measurement

NOTE:

1. The EUT had been pre-tested on the positioned of each 3 axis. The worst case was found when positioned on **X-plane**.
2. "-" means no effect.

RADIATED EMISSION TEST (ABOVE 1 GHz):

- Pre-Scan has been conducted to determine the worst-case mode from all possible combinations between available modulations, antenna ports (if EUT with antenna diversity architecture) and packet type.
- Following channel(s) was (were) selected for the final test as listed below.

EUT CONFIGURE MODE	AVAILABLE CHANNEL	TESTED CHANNEL	MODULATION TECHNOLOGY	MODULATION TYPE	PACKET TYPE
A	0 to 78	0, 39, 78	FHSS	GFSK	DH5
A	0 to 78	0, 39, 78	FHSS	8DPSK	DH5

RADIATED EMISSION TEST (BELOW 1 GHz):

- Pre-Scan has been conducted to determine the worst-case mode from all possible combinations between available modulations, antenna ports (if EUT with antenna diversity architecture) and packet type.
- Following channel(s) was (were) selected for the final test as listed below.

EUT CONFIGURE MODE	AVAILABLE CHANNEL	TESTED CHANNEL	MODULATION TECHNOLOGY	MODULATION TYPE	PACKET TYPE
A & B	0 to 78	39	FHSS	GFSK	DH5

POWER LINE CONDUCTED EMISSION:

- Pre-Scan has been conducted to determine the worst-case mode from all possible combinations between available modulations, antenna ports (if EUT with antenna diversity architecture) and packet type.
- Following channel(s) was (were) selected for the final test as listed below.

EUT CONFIGURE MODE	AVAILABLE CHANNEL	TESTED CHANNEL	MODULATION TECHNOLOGY	MODULATION TYPE	PACKET TYPE
A & B	0 to 78	39	FHSS	GFSK	DH5



BANDEDGE MEASUREMENT:

- Pre-Scan has been conducted to determine the worst-case mode from all possible combinations between available modulations, antenna ports (if EUT with antenna diversity architecture), and packet types.
- Following channel(s) was (were) selected for the final test as listed below.

EUT CONFIGURE MODE	AVAILABLE CHANNEL	TESTED CHANNEL	MODULATION TECHNOLOGY	MODULATION TYPE	PACKET TYPE
A	0 to 78	0, 78	FHSS	GFSK	DH5
A	0 to 78	0, 78	FHSS	8DPSK	DH5

ANTENNA PORT CONDUCTED MEASUREMENT:

- This item includes all test value of each mode, but only includes spectrum plot of worst value of each mode.
- Pre-Scan has been conducted to determine the worst-case mode from all possible combinations between available modulations, antenna ports (if EUT with antenna diversity architecture), and packet types.
- Following channel(s) was (were) selected for the final test as listed below.

EUT CONFIGURE MODE	AVAILABLE CHANNEL	TESTED CHANNEL	MODULATION TECHNOLOGY	MODULATION TYPE	PACKET TYPE
A	0 to 78	0, 39, 78	FHSS	GFSK	DH5
A	0 to 78	0, 39, 78	FHSS	8DPSK	DH5

TEST CONDITION:

APPLICABLE TO	ENVIRONMENTAL CONDITIONS	INPUT POWER (SYSTEM)	TESTED BY
RE≥1G	25deg. C, 65%RH	120Vac, 60Hz	Ted Chang
RE<1G	25deg. C, 65%RH	120Vac, 60Hz	Ted Chang
PLC	25deg. C, 65%RH	120Vac, 60Hz	Ted Chang
APCM	25deg. C, 60%RH	120Vac, 60Hz	Cedric Wu

3.3 DESCRIPTION OF SUPPORT UNITS

The EUT has been tested as an independent unit together with other necessary accessories or support units. The following support units or accessories were used to form a representative test configuration during the tests.

NO.	PRODUCT	BRAND	MODEL NO.	SERIAL NO.	FCC ID
1	ADAPTER	NTT docomo	AC Adapter 04	NA	NA

NO.	SIGNAL CABLE DESCRIPTION OF THE ABOVE SUPPORT UNITS
1	NA

NOTE:

1. All power cords of the above support units are non shielded (1.8m).
2. Item 1 was provided by the client
3. 1.05m DC cable with 2 cores attached on adapter.

3.3.1 CONFIGURATION OF SYSTEM UNDER TEST

TEST MODE A

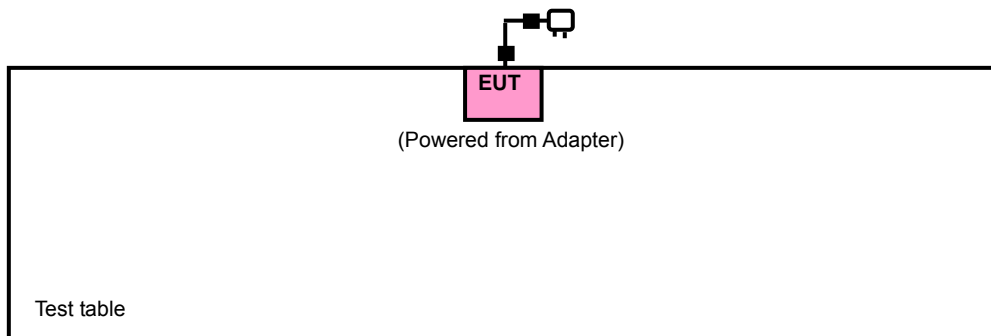

TEST MODE B

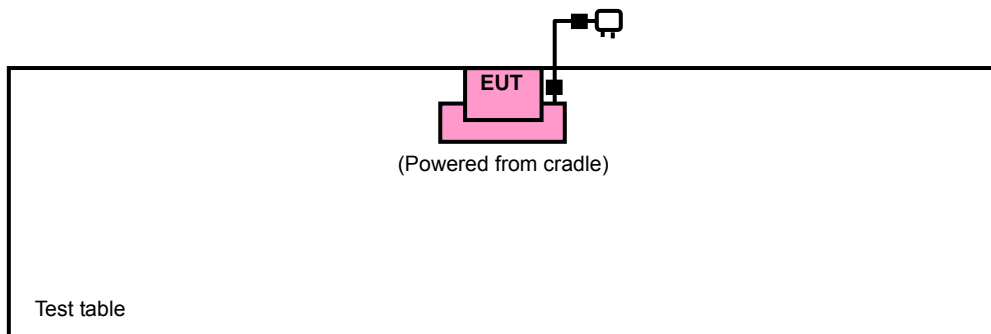



3.4 GENERAL DESCRIPTION OF APPLIED STANDARDS

The EUT is a RF Product. According to the specifications of the manufacturer, it must comply with the requirements of the following standards:

FCC Part 15, Subpart C (15.247)

FCC Public Notice DA 00-705

ANSI C63.10-2009

All test items have been performed and recorded as per the above standards.

NOTE: The EUT is also considered as a kind of computer peripheral, because the connection to computer is necessary for typical use. It has been verified to comply with the requirements of FCC Part 15, Subpart B, Class B (DoC). The test report has been issued separately.

4. TEST TYPES AND RESULTS

4.1 RADIATED EMISSION AND BANDEDGE MEASUREMENT

4.1.1 LIMITS OF RADIATED EMISSION AND BANDEDGE MEASUREMENT

Radiated emissions which fall in the restricted bands must comply with the radiated emission limits specified as below table. Other emissions shall be at least 20dB below the highest level of the desired power:

FREQUENCIES (MHz)	FIELD STRENGTH (microvolts/meter)	MEASUREMENT DISTANCE (meters)
0.009 ~ 0.490	2400/F(kHz)	300
0.490 ~ 1.705	24000/F(kHz)	30
1.705 ~ 30.0	30	30
30 ~ 88	100	3
88 ~ 216	150	3
216 ~ 960	200	3
Above 960	500	3

NOTE:

1. The lower limit shall apply at the transition frequencies.
2. Emission level (dBuV/m) = 20 log Emission level (uV/m).
3. For frequencies above 1000MHz, the field strength limits are based on average detector, however, the peak field strength of any emission shall not exceed the maximum permitted average limits, specified above by more than 20dB under any condition of modulation.

4.1.2 TEST INSTRUMENTS

DESCRIPTION & MANUFACTURER	MODEL NO.	SERIAL NO.	DATE OF CALIBRATION	DUE DATE OF CALIBRATION
Test Receiver ROHDE & SCHWARZ	ESCS30	100289	Nov. 29, 2013	Nov. 28, 2014
Spectrum Analyzer ROHDE & SCHWARZ	FSP40	100269	Feb. 11, 2014	Feb. 10, 2015
BILOG Antenna SCHWARZBECK	VULB9168	9168-156	Feb. 25, 2014	Feb. 24, 2015
HORN Antenna SCHWARZBECK	BBHA 9120 D	9120D-209	Sep. 12, 2013	Sep. 11, 2014
HORN Antenna SCHWARZBECK	BBHA 9170	148	Jul. 15, 2013	Jul. 14, 2014
Preamplifier Agilent	8449B	3008A01911	Aug. 22, 2013	Aug. 21, 2014
Preamplifier Agilent	8447D	2944A10638	Oct. 18, 2013	Oct. 17, 2014
RF signal cable HUBER+SUHNNER	SUCOFLEX 104	248780/4 309222/4 274092/4	Aug. 26, 2013	Aug. 25, 2014
RF signal cable Worken	5D-FB	Cable-HYCH9-01	Aug. 11, 2013	Aug. 10, 2014
Software BV ADT	ADT_Radiated_ V7.6.15.9.4	NA	NA	NA
Antenna Tower EMCO	2070/2080	512.835.4684	NA	NA
Turn Table EMCO	2087-2.03	NA	NA	NA
Antenna Tower & Turn Table Controller EMCO	2090	NA	NA	NA
High Speed Peak Power Meter	ML2495A	0824011	Jul. 29, 2013	Jul. 28, 2014
Power Sensor	MA2411B	0738171	Jul. 29, 2013	Jul. 28, 2014

- NOTE:**
1. The calibration interval of the above test instruments is 12 months and the calibrations are traceable to NML/ROC and NIST/USA.
 2. The test was performed in HwaYa Chamber 9.
 3. The horn antenna and HP preamplifier (model: 8449B) are used only for the measurement of emission frequency above 1GHz if tested.
 4. The FCC Site Registration No. is 215374.
 5. The IC Site Registration No. is IC 7450F-9.

4.1.3 TEST PROCEDURES

- a. The EUT was placed on the top of a rotating table 0.8 meters above the ground at a 3 meter semi-anechoic chamber. The table was rotated 360 degrees to determine the position of the highest radiation.
- b. The EUT was set 3 meters away from the interference-receiving antenna, which was mounted on the top of a variable-height antenna tower.
- c. The antenna is a broadband antenna, and its height is varied from one meter to four meters above the ground to determine the maximum value of the field strength. Both horizontal and vertical polarizations of the antenna are set to make the measurement.
- d. For each suspected emission, the EUT was arranged to its worst case and then the antenna was tuned to heights from 1 meter to 4 meters and the rotatable table was turned from 0 degrees to 360 degrees to find the maximum reading.
- e. The test-receiver system was set to Peak Detect Function and Specified Bandwidth with Maximum Hold Mode.
- f. If the emission level of the EUT in peak mode was lower than the limit specified, then testing could be stopped and the peak values of the EUT would be reported. Otherwise the emissions would be re-tested one by one using peak, quasi-peak or average method as specified and then reported in a data sheet.

NOTE:

1. The resolution bandwidth and video bandwidth of test receiver/spectrum analyzer is 120kHz for Quasi-peak detection at frequency below 1GHz.
2. The resolution bandwidth of test receiver/spectrum analyzer is 1 MHz and video bandwidth is 3MHz for Peak detection at frequency above 1GHz.
3. All modes of operation were investigated and the worst-case emissions are reported.

4.1.4 DEVIATION FROM TEST STANDARD

No deviation.

4.1.5 TEST SETUP

Frequency range 30MHz~1GHz

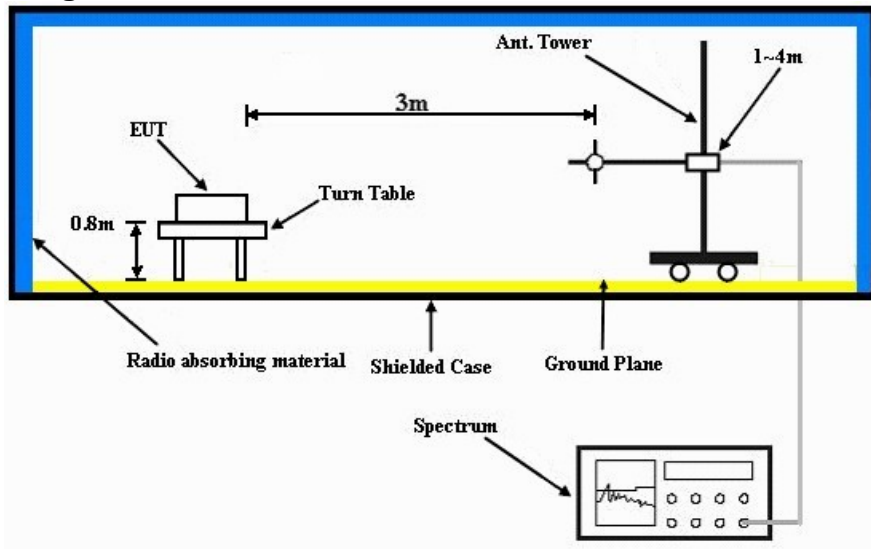

Frequency range above 1GHz

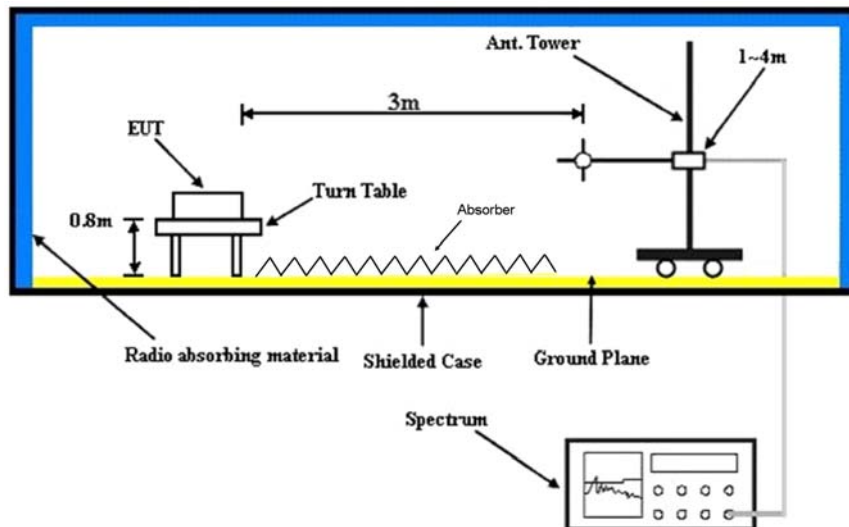

For the actual test configuration, please refer to the attached file (Test Setup Photo).

4.1.6 EUT OPERATING CONDITIONS

Test Mode A

Set the EUT under transmission condition continuously at specific channel frequency.

Test Mode B

- a. Plugged the EUT into the cradle and placed them on the test table.
- b. Set the EUT under transmission condition continuously at specific channel frequency.



A D T

4.1.7 TEST RESULTS

ABOVE 1GHz DATA :

GFSK

EUT TEST CONDITION		MEASUREMENT DETAIL	
CHANNEL	Channel 0	FREQUENCY RANGE	1 ~ 25GHz
INPUT POWER (SYSTEM)	120Vac, 60Hz	DETECTOR FUNCTION	Peak (PK) Average (AV)
ENVIRONMENTAL CONDITIONS	25deg. C, 65%RH	TESTED BY	Ted Chang

ANTENNA POLARITY & TEST DISTANCE: HORIZONTAL AT 3 M								
NO.	FREQ. (MHz)	EMISSION LEVEL (dBuV/m)	LIMIT (dBuV/m)	MARGIN (dB)	ANTENNA HEIGHT (m)	TABLE ANGLE (Degree)	RAW VALUE (dBuV)	CORRECTION FACTOR (dB/m)
1	2390.00	50.3 PK	74.0	-23.7	1.06 H	205	54.10	-3.80
2	2390.00	37.8 AV	54.0	-16.2	1.06 H	205	41.60	-3.80
3	#2400.00	43.0 PK	76.8	-33.8	1.06 H	200	9.70	33.30
4	#2400.00	12.9 AV	46.7	-33.8	1.06 H	200	-20.40	33.30
5	*2402.00	96.8 PK			1.06 H	205	63.50	33.30
6	*2402.00	66.7 AV			1.06 H	205	33.40	33.30
7	4804.00	47.5 PK	74.0	-26.5	1.22 H	206	45.80	1.70
8	4804.00	17.4 AV	54.0	-36.6	1.22 H	206	15.70	1.70
ANTENNA POLARITY & TEST DISTANCE: VERTICAL AT 3 M								
NO.	FREQ. (MHz)	EMISSION LEVEL (dBuV/m)	LIMIT (dBuV/m)	MARGIN (dB)	ANTENNA HEIGHT (m)	TABLE ANGLE (Degree)	RAW VALUE (dBuV)	CORRECTION FACTOR (dB/m)
1	2390.00	50.2 PK	74.0	-23.8	1.69 V	182	54.00	-3.80
2	2390.00	37.6 AV	54.0	-16.4	1.69 V	182	41.40	-3.80
3	#2400.00	43.5 PK	69.5	-26.0	1.69 V	182	10.20	33.30
4	#2400.00	13.4 AV	39.4	-26.0	1.69 V	182	-19.90	33.30
5	*2402.00	89.5 PK			1.69 V	182	56.20	33.30
6	*2402.00	59.4 AV			1.69 V	182	26.10	33.30
7	4804.00	43.9 PK	74.0	-30.1	1.52 V	121	42.20	1.70
8	4804.00	13.8 AV	54.0	-40.2	1.52 V	121	12.10	1.70

REMARKS:

- Emission Level(dBuV/m) = Raw Value(dBuV) + Correction Factor(dB/m)
- Correction Factor(dB/m) = Antenna Factor(dB/m) + Cable Factor(dB)
– Pre-Amplifier Factor(dB)
- The other emission levels were very low against the limit.
- Margin value = Emission Level – Limit value
- " * ": Fundamental frequency.
- The DH5 packet was the worse case duty cycle for a transmit dwell time on a channel, based upon bluetooth theory the transmitter is on 0.625 * 5 per 296.25 ms per channel. Therefore, the duty cycle correlation factor be equal to: $20\log(3.125 / 100) = -30.1$ dB
- Average value = peak reading + $20\log(\text{duty cycle})$
- "#": The radiated frequency is out the restricted band.

EUT TEST CONDITION		MEASUREMENT DETAIL	
CHANNEL	Channel 39	FREQUENCY RANGE	1 ~ 25GHz
INPUT POWER (SYSTEM)	120Vac, 60Hz	DETECTOR FUNCTION	Peak (PK) Average (AV)
ENVIRONMENTAL CONDITIONS	25deg. C, 65%RH	TESTED BY	Ted Chang

ANTENNA POLARITY & TEST DISTANCE: HORIZONTAL AT 3 M								
NO.	FREQ. (MHz)	EMISSION LEVEL (dBuV/m)	LIMIT (dBuV/m)	MARGIN (dB)	ANTENNA HEIGHT (m)	TABLE ANGLE (Degree)	RAW VALUE (dBuV)	CORRECTION FACTOR (dB/m)
1	*2441.00	97.5 PK			1.02 H	207	64.20	33.30
2	*2441.00	67.4 AV			1.02 H	207	34.10	33.30
3	4882.00	47.1 PK	74.0	-26.9	1.24 H	202	45.20	1.90
4	4882.00	17.0 AV	54.0	-37.0	1.24 H	202	15.10	1.90
ANTENNA POLARITY & TEST DISTANCE: VERTICAL AT 3 M								
NO.	FREQ. (MHz)	EMISSION LEVEL (dBuV/m)	LIMIT (dBuV/m)	MARGIN (dB)	ANTENNA HEIGHT (m)	TABLE ANGLE (Degree)	RAW VALUE (dBuV)	CORRECTION FACTOR (dB/m)
1	*2441.00	90.2 PK			1.72 V	189	56.90	33.30
2	*2441.00	60.1 AV			1.72 V	189	26.80	33.30
3	4882.00	45.5 PK	74.0	-28.5	1.45 V	126	43.60	1.90
4	4882.00	15.4 AV	54.0	-38.6	1.45 V	126	13.50	1.90

REMARKS:

- Emission Level(dBuV/m) = Raw Value(dBuV) + Correction Factor(dB/m)
- Correction Factor(dB/m) = Antenna Factor(dB/m) + Cable Factor(dB)
– Pre-Amplifier Factor(dB)
- The other emission levels were very low against the limit.
- Margin value = Emission Level – Limit value
- * *: Fundamental frequency.
- The DH5 packet was the worse case duty cycle for a transmit dwell time on a channel, based upon bluetooth theory the transmitter is on 0.625 * 5 per 296.25 ms per channel. Therefore, the duty cycle correlation factor be equal to: $20\log(3.125 / 100) = -30.1$ dB
- Average value = peak reading + $20\log(\text{duty cycle})$



A D T

EUT TEST CONDITION		MEASUREMENT DETAIL	
CHANNEL	Channel 78	FREQUENCY RANGE	1 ~ 25GHz
INPUT POWER (SYSTEM)	120Vac, 60Hz	DETECTOR FUNCTION	Peak (PK) Average (AV)
ENVIRONMENTAL CONDITIONS	25deg. C, 65%RH	TESTED BY	Ted Chang

ANTENNA POLARITY & TEST DISTANCE: HORIZONTAL AT 3 M								
NO.	FREQ. (MHz)	EMISSION LEVEL (dBuV/m)	LIMIT (dBuV/m)	MARGIN (dB)	ANTENNA HEIGHT (m)	TABLE ANGLE (Degree)	RAW VALUE (dBuV)	CORRECTION FACTOR (dB/m)
1	*2480.00	98.2 PK			1.09 H	241	64.70	33.50
2	*2480.00	68.1 AV			1.09 H	241	34.60	33.50
3	2483.50	46.0 PK	74.0	-28.0	1.09 H	241	12.40	33.60
4	2483.50	15.9 AV	54.0	-38.1	1.09 H	241	-17.70	33.60
5	4960.00	47.2 PK	74.0	-26.8	1.28 H	224	45.20	2.00
6	4960.00	17.1 AV	54.0	-36.9	1.28 H	224	15.10	2.00
ANTENNA POLARITY & TEST DISTANCE: VERTICAL AT 3 M								
NO.	FREQ. (MHz)	EMISSION LEVEL (dBuV/m)	LIMIT (dBuV/m)	MARGIN (dB)	ANTENNA HEIGHT (m)	TABLE ANGLE (Degree)	RAW VALUE (dBuV)	CORRECTION FACTOR (dB/m)
1	*2480.00	90.7 PK			1.78 V	192	57.20	33.50
2	*2480.00	60.6 AV			1.78 V	192	27.10	33.50
3	2483.50	46.1 PK	74.0	-27.9	1.78 V	192	12.50	33.60
4	2483.50	16.0 AV	54.0	-38.0	1.78 V	192	-17.60	33.60
5	4960.00	46.1 PK	74.0	-27.9	1.52 V	128	44.10	2.00
6	4960.00	16.0 AV	54.0	-38.0	1.52 V	128	14.00	2.00

REMARKS:

- Emission Level(dBuV/m) = Raw Value(dBuV) + Correction Factor(dB/m)
- Correction Factor(dB/m) = Antenna Factor(dB/m) + Cable Factor(dB)
– Pre-Amplifier Factor(dB)
- The other emission levels were very low against the limit.
- Margin value = Emission Level – Limit value
- * * *: Fundamental frequency.
- The DH5 packet was the worse case duty cycle for a transmit dwell time on a channel, based upon bluetooth theory the transmitter is on 0.625 * 5 per 296.25 ms per channel. Therefore, the duty cycle correlation factor be equal to: $20\log(3.125 / 100) = -30.1$ dB
- Average value = peak reading + $20\log(\text{duty cycle})$



A D T

8DPSK

EUT TEST CONDITION		MEASUREMENT DETAIL	
CHANNEL	Channel 0	FREQUENCY RANGE	1 ~ 25GHz
INPUT POWER (SYSTEM)	120Vac, 60Hz	DETECTOR FUNCTION	Peak (PK) Average (AV)
ENVIRONMENTAL CONDITIONS	25deg. C, 65%RH	TESTED BY	Ted Chang

ANTENNA POLARITY & TEST DISTANCE: HORIZONTAL AT 3 M								
NO.	FREQ. (MHz)	EMISSION LEVEL (dBuV/m)	LIMIT (dBuV/m)	MARGIN (dB)	ANTENNA HEIGHT (m)	TABLE ANGLE (Degree)	RAW VALUE (dBuV)	CORRECTION FACTOR (dB/m)
1	2390.00	50.3 PK	74.0	-23.7	1.01 H	36	54.10	-3.80
2	2390.00	37.9 AV	54.0	-16.1	1.01 H	36	41.70	-3.80
3	#2400.00	41.2 PK	78.2	-37.0	1.01 H	36	7.90	33.30
4	#2400.00	11.1 AV	48.1	-37.0	1.01 H	36	-22.20	33.30
5	*2402.00	98.2 PK			1.01 H	36	64.90	33.30
6	*2402.00	68.1 AV			1.01 H	36	34.80	33.30
7	4804.00	46.9 PK	74.0	-27.1	1.24 H	196	45.20	1.70
8	4804.00	16.8 AV	54.0	-37.2	1.24 H	196	15.10	1.70
ANTENNA POLARITY & TEST DISTANCE: VERTICAL AT 3 M								
NO.	FREQ. (MHz)	EMISSION LEVEL (dBuV/m)	LIMIT (dBuV/m)	MARGIN (dB)	ANTENNA HEIGHT (m)	TABLE ANGLE (Degree)	RAW VALUE (dBuV)	CORRECTION FACTOR (dB/m)
1	2390.00	49.6 PK	74.0	-24.4	1.34 V	128	53.40	-3.80
2	2390.00	37.8 AV	54.0	-16.2	1.34 V	128	41.60	-3.80
3	#2400.00	41.8 PK	71.1	-29.3	1.34 V	128	8.50	33.30
4	#2400.00	11.7 AV	41.0	-29.3	1.34 V	128	-21.60	33.30
5	*2402.00	91.1 PK			1.34 V	128	57.80	33.30
6	*2402.00	61.0 AV			1.34 V	128	27.70	33.30
7	4804.00	44.2 PK	74.0	-29.8	1.46 V	118	42.50	1.70
8	4804.00	14.1 AV	54.0	-39.9	1.46 V	118	12.40	1.70

REMARKS:

- Emission Level(dBuV/m) = Raw Value(dBuV) + Correction Factor(dB/m)
- Correction Factor(dB/m) = Antenna Factor(dB/m) + Cable Factor(dB)
– Pre-Amplifier Factor(dB)
- The other emission levels were very low against the limit.
- Margin value = Emission Level – Limit value
- " * ": Fundamental frequency.
- The DH5 packet was the worse case duty cycle for a transmit dwell time on a channel, based upon bluetooth theory the transmitter is on 0.625 * 5 per 296.25 ms per channel. Therefore, the duty cycle correlation factor be equal to: $20\log(3.125 / 100) = -30.1$ dB
- Average value = peak reading + $20\log(\text{duty cycle})$
- "#":The radiated frequency is out the restricted band.



A D T

EUT TEST CONDITION		MEASUREMENT DETAIL	
CHANNEL	Channel 39	FREQUENCY RANGE	1 ~ 25GHz
INPUT POWER (SYSTEM)	120Vac, 60Hz	DETECTOR FUNCTION	Peak (PK) Average (AV)
ENVIRONMENTAL CONDITIONS	25deg. C, 65%RH	TESTED BY	Ted Chang

ANTENNA POLARITY & TEST DISTANCE: HORIZONTAL AT 3 M								
NO.	FREQ. (MHz)	EMISSION LEVEL (dBuV/m)	LIMIT (dBuV/m)	MARGIN (dB)	ANTENNA HEIGHT (m)	TABLE ANGLE (Degree)	RAW VALUE (dBuV)	CORRECTION FACTOR (dB/m)
1	*2441.00	98.9 PK			1.35 H	216	65.60	33.30
2	*2441.00	68.8 AV			1.35 H	216	35.50	33.30
3	4882.00	47.5 PK	74.0	-26.5	1.22 H	216	45.60	1.90
4	4882.00	17.4 AV	54.0	-36.6	1.22 H	216	15.50	1.90
ANTENNA POLARITY & TEST DISTANCE: VERTICAL AT 3 M								
NO.	FREQ. (MHz)	EMISSION LEVEL (dBuV/m)	LIMIT (dBuV/m)	MARGIN (dB)	ANTENNA HEIGHT (m)	TABLE ANGLE (Degree)	RAW VALUE (dBuV)	CORRECTION FACTOR (dB/m)
1	*2441.00	91.8 PK			1.64 V	178	58.50	33.30
2	*2441.00	61.7 AV			1.64 V	178	28.40	33.30
3	4882.00	44.7 PK	74.0	-29.3	1.51 V	124	42.80	1.90
4	4882.00	14.6 AV	54.0	-39.4	1.51 V	124	12.70	1.90

REMARKS:

- Emission Level(dBuV/m) = Raw Value(dBuV) + Correction Factor(dB/m)
- Correction Factor(dB/m) = Antenna Factor(dB/m) + Cable Factor(dB) – Pre-Amplifier Factor(dB)
- The other emission levels were very low against the limit.
- Margin value = Emission Level – Limit value
- “ * ”: Fundamental frequency.
- The DH5 packet was the worse case duty cycle for a transmit dwell time on a channel, based upon bluetooth theory the transmitter is on 0.625 * 5 per 296.25 ms per channel. Therefore, the duty cycle correlation factor be equal to: $20\log(3.125 / 100) = -30.1$ dB
- Average value = peak reading + $20\log(\text{duty cycle})$



A D T

EUT TEST CONDITION		MEASUREMENT DETAIL	
CHANNEL	Channel 78	FREQUENCY RANGE	1 ~ 25GHz
INPUT POWER (SYSTEM)	120Vac, 60Hz	DETECTOR FUNCTION	Peak (PK) Average (AV)
ENVIRONMENTAL CONDITIONS	25deg. C, 65%RH	TESTED BY	Ted Chang

ANTENNA POLARITY & TEST DISTANCE: HORIZONTAL AT 3 M								
NO.	FREQ. (MHz)	EMISSION LEVEL (dBuV/m)	LIMIT (dBuV/m)	MARGIN (dB)	ANTENNA HEIGHT (m)	TABLE ANGLE (Degree)	RAW VALUE (dBuV)	CORRECTION FACTOR (dB/m)
1	*2480.00	97.5 PK			1.32 H	195	64.00	33.50
2	*2480.00	67.4 AV			1.32 H	195	33.90	33.50
3	2483.50	43.5 PK	74.0	-30.5	1.32 H	195	9.90	33.60
4	2483.50	13.4 AV	54.0	-40.6	1.32 H	195	-20.20	33.60
5	4960.00	47.2 PK	74.0	-26.8	1.26 H	222	45.20	2.00
6	4960.00	17.1 AV	54.0	-36.9	1.26 H	222	15.10	2.00
ANTENNA POLARITY & TEST DISTANCE: VERTICAL AT 3 M								
NO.	FREQ. (MHz)	EMISSION LEVEL (dBuV/m)	LIMIT (dBuV/m)	MARGIN (dB)	ANTENNA HEIGHT (m)	TABLE ANGLE (Degree)	RAW VALUE (dBuV)	CORRECTION FACTOR (dB/m)
1	*2480.00	90.7 PK			1.58 V	182	57.20	33.50
2	*2480.00	60.6 AV			1.58 V	182	27.10	33.50
3	2483.50	43.5 PK	74.0	-30.5	1.58 V	182	9.90	33.60
4	2483.50	13.4 AV	54.0	-40.6	1.58 V	182	-20.20	33.60
5	4960.00	44.6 PK	74.0	-29.4	1.48 V	122	42.60	2.00
6	4960.00	14.5 AV	54.0	-39.5	1.48 V	122	12.50	2.00

REMARKS:

1. Emission Level(dBuV/m) = Raw Value(dBuV) + Correction Factor(dB/m)
2. Correction Factor(dB/m) = Antenna Factor(dB/m) + Cable Factor(dB)
– Pre-Amplifier Factor(dB)
3. The other emission levels were very low against the limit.
4. Margin value = Emission Level – Limit value
5. “ * “: Fundamental frequency.
6. The DH5 packet was the worse case duty cycle for a transmit dwell time on a channel, based upon bluetooth theory the transmitter is on 0.625 * 5 per 296.25 ms per channel. Therefore, the duty cycle correlation factor be equal to: $20\log(3.125 / 100) = -30.1$ dB
7. Average value = peak reading + $20\log(\text{duty cycle})$



A D T

BELOW 1GHz WORST-CASE DATA : GFSK

EUT TEST CONDITION		MEASUREMENT DETAIL	
CHANNEL	Channel 39	FREQUENCY RANGE	Below 1000MHz
INPUT POWER (SYSTEM)	120Vac, 60Hz	DETECTOR FUNCTION	Quasi-Peak
ENVIRONMENTAL CONDITIONS	25deg. C, 65%RH	TESTED BY	Ted Chang
TEST MODE	A		

ANTENNA POLARITY & TEST DISTANCE: HORIZONTAL AT 3 M								
NO.	FREQ. (MHz)	EMISSION LEVEL (dBuV/m)	LIMIT (dBuV/m)	MARGIN (dB)	ANTENNA HEIGHT (m)	TABLE ANGLE (Degree)	RAW VALUE (dBuV)	CORRECTION FACTOR (dB/m)
1	157.47	21.3 QP	43.5	-22.2	1.24 H	266	35.00	-13.70
2	194.78	23.9 QP	43.5	-19.6	1.00 H	79	40.10	-16.20
3	284.94	21.6 QP	46.0	-24.4	1.49 H	288	34.20	-12.60
4	432.61	22.7 QP	46.0	-23.3	1.99 H	178	31.90	-9.20
5	642.47	25.9 QP	46.0	-20.1	1.24 H	76	31.40	-5.50
6	827.45	30.0 QP	46.0	-16.0	1.00 H	296	32.20	-2.20
ANTENNA POLARITY & TEST DISTANCE: VERTICAL AT 3 M								
NO.	FREQ. (MHz)	EMISSION LEVEL (dBuV/m)	LIMIT (dBuV/m)	MARGIN (dB)	ANTENNA HEIGHT (m)	TABLE ANGLE (Degree)	RAW VALUE (dBuV)	CORRECTION FACTOR (dB/m)
1	30.00	29.6 QP	40.0	-10.4	1.00 V	317	45.40	-15.80
2	56.43	24.4 QP	40.0	-15.6	1.00 V	335	38.50	-14.10
3	173.01	18.7 QP	43.5	-24.8	1.00 V	2	33.10	-14.40
4	376.65	21.4 QP	46.0	-24.6	1.24 V	8	32.00	-10.60
5	535.21	24.2 QP	46.0	-21.8	1.24 V	18	32.00	-7.80
6	717.08	26.7 QP	46.0	-19.3	1.49 V	16	31.30	-4.60

REMARKS:

1. Emission Level(dBuV/m) = Raw Value(dBuV) + Correction Factor(dB/m)
2. Correction Factor(dB/m) = Antenna Factor(dB/m) + Cable Factor(dB) – Pre-Amplifier Factor (dB)
3. The other emission levels were very low against the limit.
4. Margin value = Emission Level – Limit value



A D T

EUT TEST CONDITION		MEASUREMENT DETAIL	
CHANNEL	Channel 39	FREQUENCY RANGE	Below 1000MHz
INPUT POWER (SYSTEM)	120Vac, 60Hz	DETECTOR FUNCTION	Quasi-Peak
ENVIRONMENTAL CONDITIONS	25deg. C, 65%RH	TESTED BY	Ted Chang
TEST MODE	B		

ANTENNA POLARITY & TEST DISTANCE: HORIZONTAL AT 3 M								
NO.	FREQ. (MHz)	EMISSION LEVEL (dBuV/m)	LIMIT (dBuV/m)	MARGIN (dB)	ANTENNA HEIGHT (m)	TABLE ANGLE (Degree)	RAW VALUE (dBuV)	CORRECTION FACTOR (dB/m)
1	47.10	20.4 QP	40.0	-19.6	1.75 H	180	34.50	-14.10
2	99.95	20.2 QP	43.5	-23.3	1.50 H	190	38.80	-18.60
3	148.14	21.5 QP	43.5	-22.0	1.75 H	99	35.40	-13.90
4	230.53	20.9 QP	46.0	-25.1	1.25 H	49	36.90	-16.00
5	522.77	24.8 QP	46.0	-21.2	1.00 H	30	32.70	-7.90
6	644.02	26.5 QP	46.0	-19.5	1.00 H	139	32.00	-5.50
ANTENNA POLARITY & TEST DISTANCE: VERTICAL AT 3 M								
NO.	FREQ. (MHz)	EMISSION LEVEL (dBuV/m)	LIMIT (dBuV/m)	MARGIN (dB)	ANTENNA HEIGHT (m)	TABLE ANGLE (Degree)	RAW VALUE (dBuV)	CORRECTION FACTOR (dB/m)
1	36.22	29.1 QP	40.0	-10.9	1.00 V	90	44.30	-15.20
2	76.64	24.9 QP	40.0	-15.1	1.00 V	18	42.60	-17.70
3	143.48	24.7 QP	43.5	-18.8	2.00 V	12	38.80	-14.10
4	221.20	22.4 QP	46.0	-23.6	1.50 V	62	38.70	-16.30
5	583.40	25.4 QP	46.0	-20.6	1.75 V	139	32.00	-6.60
6	631.59	27.0 QP	46.0	-19.0	2.00 V	146	32.40	-5.40

REMARKS:

1. Emission Level(dBuV/m) = Raw Value(dBuV) + Correction Factor(dB/m)
2. Correction Factor(dB/m) = Antenna Factor(dB/m) + Cable Factor(dB)
– Pre-Amplifier Factor (dB)
3. The other emission levels were very low against the limit.
4. Margin value = Emission Level – Limit value

4.2 CONDUCTED EMISSION MEASUREMENT

4.2.1 LIMITS OF CONDUCTED EMISSION MEASUREMENT

FREQUENCY OF EMISSION (MHz)	CONDUCTED LIMIT (dB μ V)	
	Quasi-peak	Average
0.15 ~ 0.5	66 to 56	56 to 46
0.5 ~ 5	56	46
5 ~ 30	60	50

- NOTE:** 1. The lower limit shall apply at the transition frequencies.
 2. The limit decreases in line with the logarithm of the frequency in the range of 0.15 to 0.50MHz.
 3. All emanations from a class A/B digital device or system, including any network of conductors and apparatus connected thereto, shall not exceed the level of field strengths specified above.

4.2.2 TEST INSTRUMENTS

DESCRIPTION & MANUFACTURER	MODEL NO.	SERIAL NO.	DATE OF CALIBRATION	DUE DATE OF CALIBRATION
Test Receiver ROHDE & SCHWARZ	ESCS30	100289	Nov. 29, 2013	Nov. 28, 2014
RF signal cable Woken	5D-FB	Cable-HYC01-01	Dec. 27, 2013	Dec. 26, 2014
LISN ROHDE & SCHWARZ (EUT)	ESH3-Z5	835239/001	Feb. 13, 2014	Feb. 12, 2015
LISN ROHDE & SCHWARZ (Peripheral)	ESH3-Z5	100311	Jul. 17, 2013	Jul. 16, 2014
Software ADT	BV ADT_Cond_ V7.3.7.3	NA	NA	NA

- NOTE:** 1. The calibration interval of the above test instruments is 12 months and the calibrations are traceable to NML/ROC and NIST/USA.
 2. The test was performed in HwaYa Shielded Room 1.
 3. The VCCI Site Registration No. is C-2040.

4.2.3 TEST PROCEDURES

- a. The EUT was placed 0.4 meters from the conducting wall of the shielded room with EUT being connected to the power mains through a line impedance stabilization network (LISN). Other support units were connected to the power mains through another LISN. The two LISNs provide 50 ohm/ 50uH of coupling impedance for the measuring instrument.
- b. Both lines of the power mains connected to the EUT were checked for maximum conducted interference.
- c. The frequency range from 150kHz to 30MHz was searched. Emission levels under (Limit - 20dB) was not recorded.

NOTE: All modes of operation were investigated and the worst-case emissions are reported.

4.2.4 DEVIATION FROM TEST STANDARD

No deviation.

4.2.5 TEST SETUP

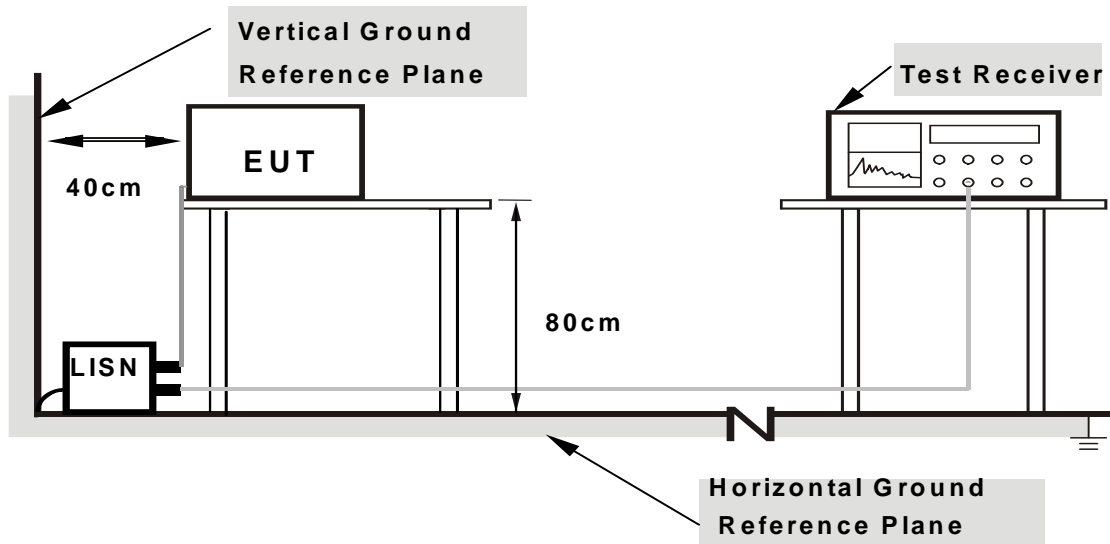

- Note:**
- 1.Support units were connected to second LISN.
 - 2.Both of LISNs (AMN) are 80 cm from EUT and at least 80 from other units and other metal planes

For the actual test configuration, please refer to the attached file (Test Setup Photo).

4.2.6 EUT OPERATING CONDITIONS

Same as 4.1.6.



A D T

4.2.7 TEST RESULTS

CONDUCTED WORST-CASE DATA : GFSK

PHASE	Line 1	6dB BANDWIDTH	9kHz
TEST MODE	A		

No	Freq. [MHz]	Corr. Factor (dB)	Reading Value		Emission Level		Limit		Margin	
			[dB (uV)]		[dB (uV)]		[dB (uV)]		(dB)	
			Q.P.	AV.	Q.P.	AV.	Q.P.	AV.	Q.P.	AV.
1	0.19717	0.09	38.83	33.61	38.92	33.70	63.73	53.73	-24.81	-20.03
2	0.45097	0.12	33.89	24.39	34.01	24.51	56.86	46.86	-22.85	-22.35
3	0.87372	0.19	31.01	22.61	31.20	22.80	56.00	46.00	-24.80	-23.20
4	1.34599	0.22	31.13	22.49	31.35	22.71	56.00	46.00	-24.65	-23.29
5	3.10596	0.26	30.59	21.01	30.85	21.27	56.00	46.00	-25.15	-24.73
6	11.10191	0.61	30.34	24.30	30.95	24.91	60.00	50.00	-29.05	-25.09

REMARKS:

1. Q.P. and AV. are abbreviations of quasi-peak and average individually.
2. The emission levels of other frequencies were very low against the limit.
3. Margin value = Emission level - Limit value
4. Correction factor = Insertion loss + Cable loss
5. Emission Level = Correction Factor + Reading Value

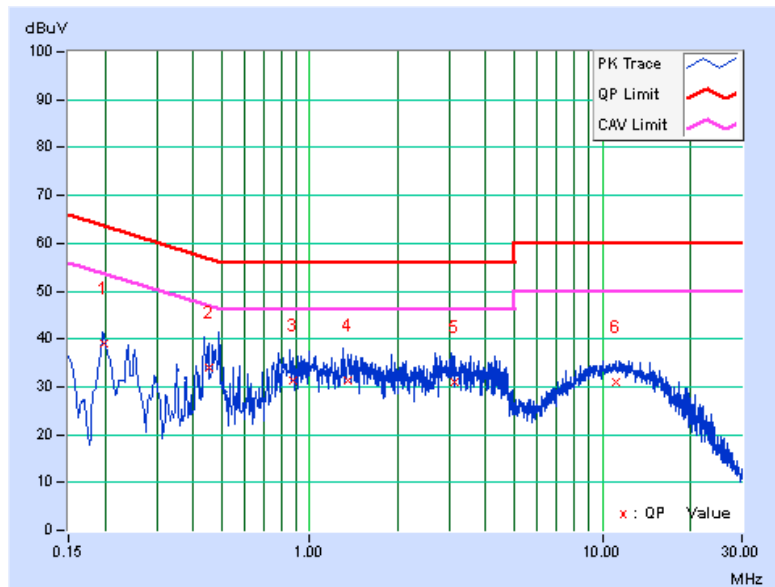



A D T

PHASE	Line 2	6dB BANDWIDTH	9kHz
TEST MODE	A		

No	Freq. [MHz]	Corr. Factor (dB)	Reading Value		Emission Level		Limit		Margin	
			[dB (uV)]		[dB (uV)]		[dB (uV)]		(dB)	
			Q.P.	AV.	Q.P.	AV.	Q.P.	AV.	Q.P.	AV.
1	0.19717	0.09	32.57	27.54	32.66	27.63	63.73	53.73	-31.07	-26.10
2	0.34560	0.15	34.61	28.95	34.76	29.10	59.07	49.07	-24.31	-19.97
3	0.49324	0.18	35.57	28.82	35.75	29.00	56.11	46.11	-20.37	-17.12
4	0.97084	0.22	29.88	21.00	30.10	21.22	56.00	46.00	-25.90	-24.78
5	3.90751	0.26	30.96	23.03	31.22	23.29	56.00	46.00	-24.78	-22.71
6	10.55842	0.57	31.33	26.04	31.90	26.61	60.00	50.00	-28.10	-23.39

REMARKS:

1. Q.P. and AV. are abbreviations of quasi-peak and average individually.
2. The emission levels of other frequencies were very low against the limit.
3. Margin value = Emission level - Limit value
4. Correction factor = Insertion loss + Cable loss
5. Emission Level = Correction Factor + Reading Value

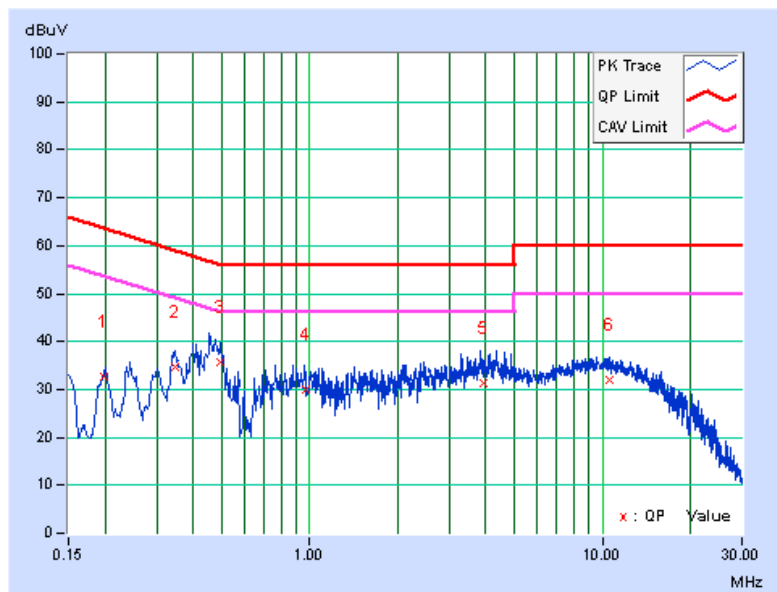



A D T

PHASE	Line 1	6dB BANDWIDTH	9kHz
TEST MODE	B		

No	Freq. [MHz]	Corr. Factor (dB)	Reading Value		Emission Level		Limit		Margin	
			[dB (uV)]		[dB (uV)]		[dB (uV)]		(dB)	
			Q.P.	AV.	Q.P.	AV.	Q.P.	AV.	Q.P.	AV.
1	0.19978	0.09	38.31	32.81	38.40	32.90	63.62	53.62	-25.22	-20.72
2	0.46792	0.12	34.27	25.50	34.39	25.62	56.55	46.55	-22.16	-20.93
3	0.91858	0.20	32.33	24.26	32.53	24.46	56.00	46.00	-23.47	-21.54
4	1.46826	0.23	31.67	23.27	31.90	23.50	56.00	46.00	-24.10	-22.50
5	4.22813	0.27	28.99	17.67	29.26	17.94	56.00	46.00	-26.74	-28.06
6	10.93390	0.60	29.83	24.41	30.43	25.01	60.00	50.00	-29.57	-24.99

REMARKS:

1. Q.P. and AV. are abbreviations of quasi-peak and average individually.
2. The emission levels of other frequencies were very low against the limit.
3. Margin value = Emission level - Limit value
4. Correction factor = Insertion loss + Cable loss
5. Emission Level = Correction Factor + Reading Value

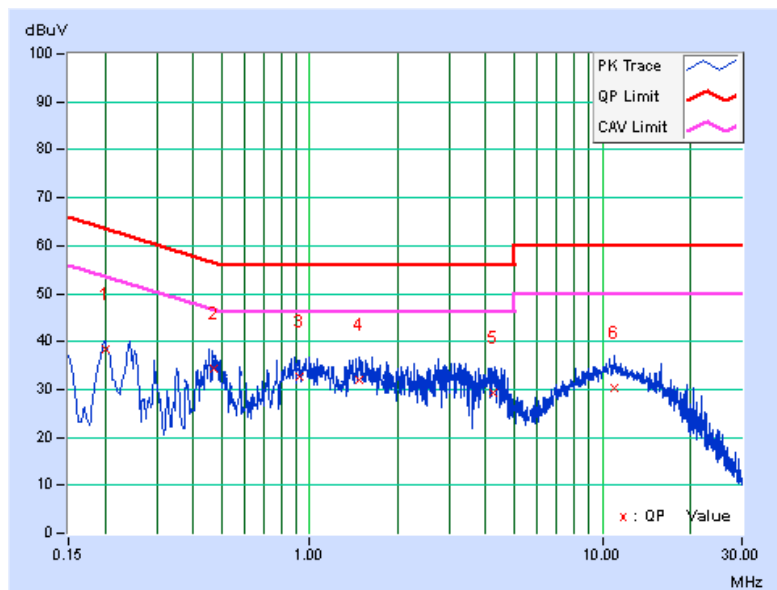



A D T

PHASE	Line 2	6dB BANDWIDTH	9kHz
TEST MODE	B		

No	Freq. [MHz]	Corr. Factor (dB)	Reading Value		Emission Level		Limit		Margin	
			[dB (uV)]		[dB (uV)]		[dB (uV)]		(dB)	
			Q.P.	AV.	Q.P.	AV.	Q.P.	AV.	Q.P.	AV.
1	0.19717	0.09	32.15	27.08	32.24	27.17	63.73	53.73	-31.49	-26.56
2	0.46179	0.18	36.79	30.50	36.97	30.68	56.66	46.66	-19.70	-15.99
3	0.94808	0.22	29.12	20.84	29.34	21.06	56.00	46.00	-26.66	-24.94
4	1.69277	0.22	27.89	19.56	28.11	19.78	56.00	46.00	-27.89	-26.22
5	4.11370	0.27	30.64	22.72	30.91	22.99	56.00	46.00	-25.09	-23.01
6	10.26517	0.55	31.13	25.66	31.68	26.21	60.00	50.00	-28.32	-23.79

REMARKS:

1. Q.P. and AV. are abbreviations of quasi-peak and average individually.
2. The emission levels of other frequencies were very low against the limit.
3. Margin value = Emission level - Limit value
4. Correction factor = Insertion loss + Cable loss
5. Emission Level = Correction Factor + Reading Value

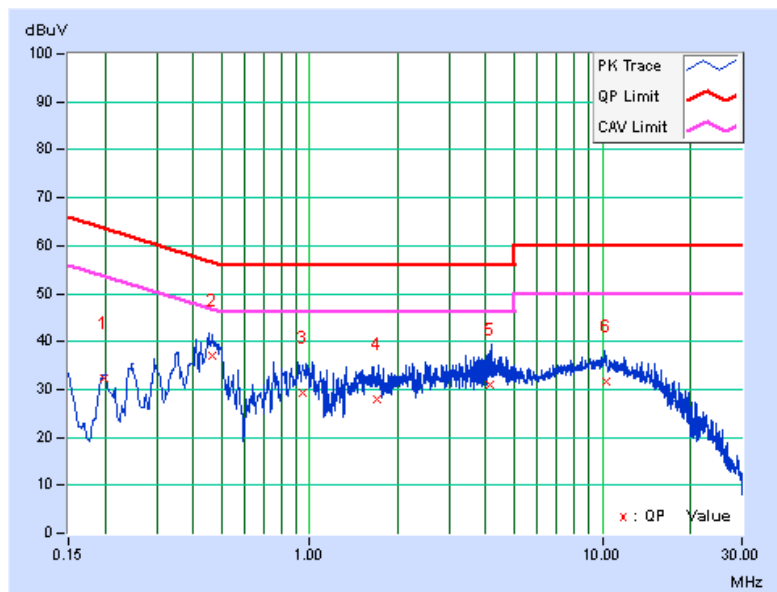

4.3 NUMBER OF HOPPING FREQUENCY USED

4.3.1 LIMIT OF HOPPING FREQUENCY USED

At least 15 channels frequencies, and should be equally spaced.

4.3.2 TEST SETUP

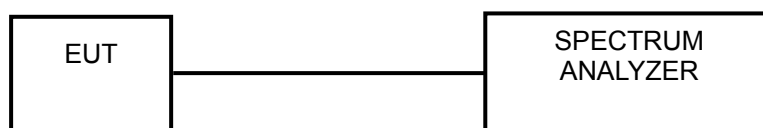

4.3.3 TEST INSTRUMENTS

Refer to section 4.1.2 to get information of above instrument.

4.3.4 TEST PROCEDURES

- Check the calibration of the measuring instrument (SA) using either an internal calibrator or a known signal from an external generator.
- Turn on the EUT and connect its antenna terminal to measurement via a low loss cable. Then set it to any one measured frequency within its operating range and make sure the instrument is operated in its linear range.
- Set the SA on MaxHold Mode, and then keep the EUT in hopping mode. Record all the signals from each channel until each one has been recorded.
- Set the SA on View mode and then plot the result on SA screen.
- Repeat above procedures until all frequencies measured were complete.

4.3.5 DEVIATION FROM TEST STANDARD

No deviation.

4.3.6 TEST RESULTS

There are 79 hopping frequencies in the hopping mode. Please refer to next page for the test result. On the plots, it shows that the hopping frequencies are equally spaced.



A D T

GFSK

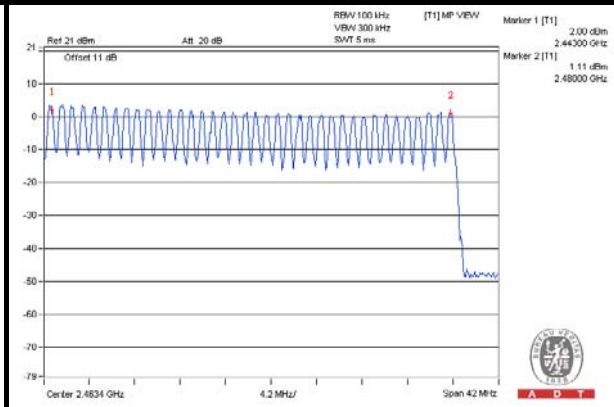
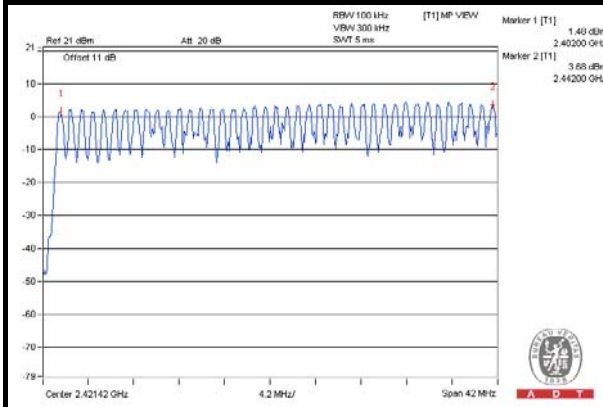

8DPSK

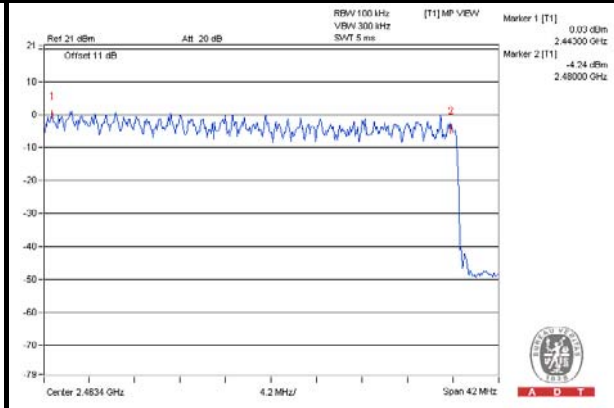
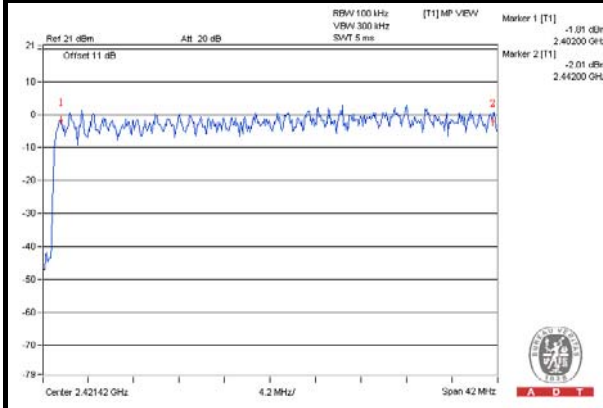

4.4 DWELL TIME ON EACH CHANNEL

4.4.1 LIMIT OF DWELL TIME USED

The average time of occupancy on any channel shall not be greater than 0.4 seconds within a period of 0.4 seconds multiplied by the number of hopping channels employed.

4.4.2 TEST SETUP

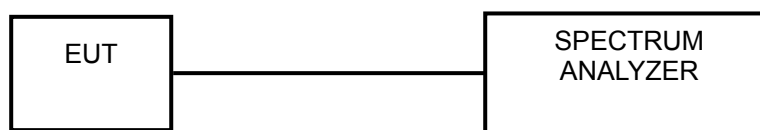

4.4.3 TEST INSTRUMENTS

Refer to section 4.1.2 to get information of above instrument.

4.4.4 TEST PROCEDURES

- Check the calibration of the measuring instrument (SA) using either an internal calibrator or a known signal from an external generator.
- Turn on the EUT and connect its antenna terminal to measurement via a low loss cable. Then set it to any one measured frequency within its operating range and make sure the instrument is operated in its linear range.
- Adjust the center frequency of SA on any frequency be measured and set SA to zero span mode. And then, set RBW and VBW of spectrum analyzer to proper value.
- Measure the time duration of one transmission on the measured frequency. And then plot the result with time difference of this time duration.
- Repeat above procedures until all different time-slot modes have been completed.

4.4.5 DEVIATION FROM TEST STANDARD

No deviation.

4.4.6 TEST RESULTS

GFSK

Mode	Number of transmission in a 31.6 (79Hopping*0.4)	Length of transmission time (msec)	Result (msec)	Limit (msec)
DH1	50 (times / 5 sec) * 6.32 = 316.00 times	0.42	132.72	400
DH3	25 (times / 5 sec) * 6.32 = 158.00 times	1.77	279.66	400
DH5	16 (times / 5 sec) * 6.32 = 101.12 times	3.00	303.36	400

NOTE: Test plots of the transmitting time slot are shown as below.

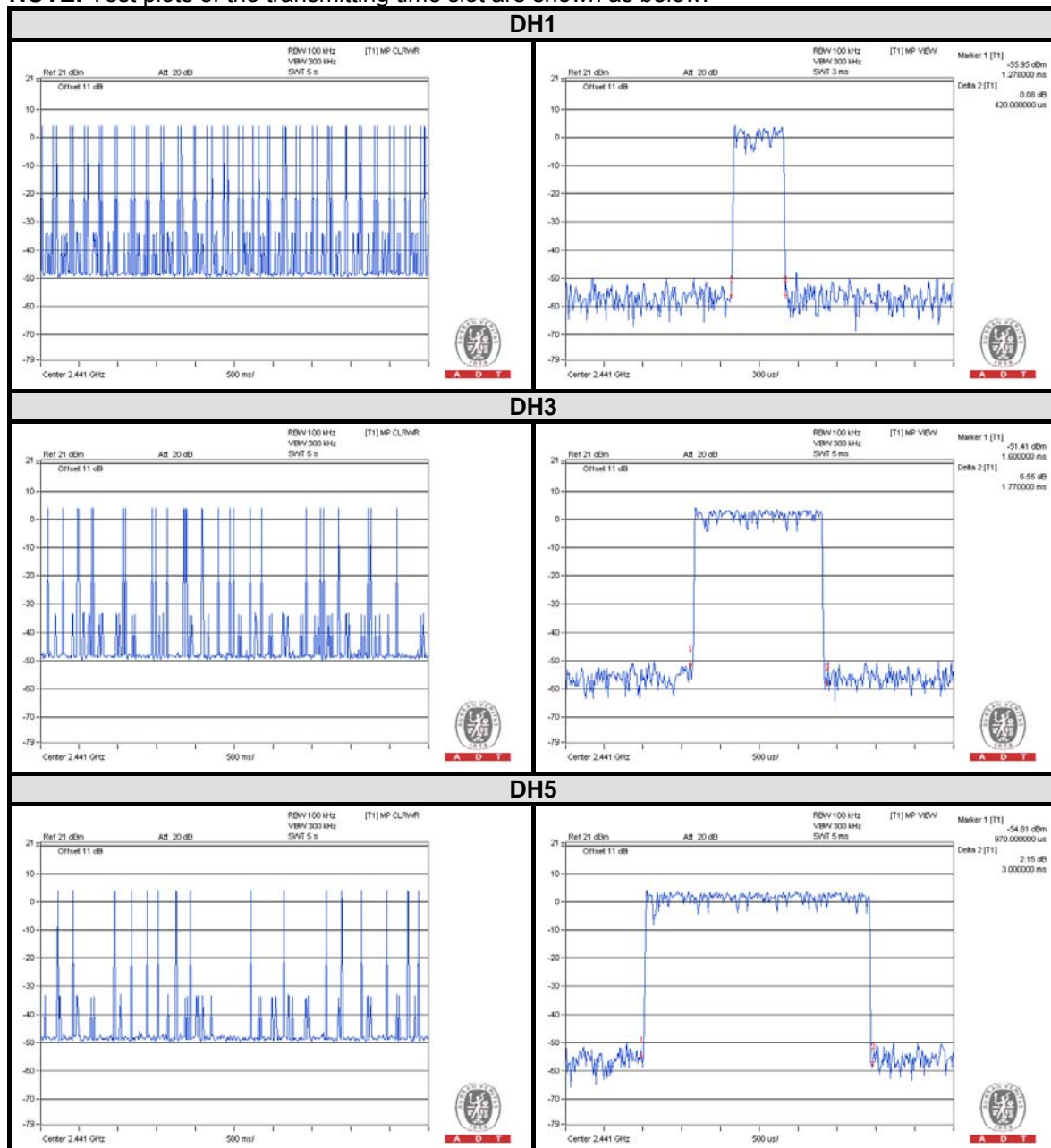



A D T

8DPSK

Mode	Number of transmission in a 31.6 (79Hopping*0.4)	Length of transmission time (msec)	Result (msec)	Limit (msec)
DH1	50 (times / 5 sec) * 6.32 = 316.00 times	0.44	140.30	400
DH3	26 (times / 5 sec) * 6.32 = 164.32 times	1.69	277.70	400
DH5	17 (times / 5 sec) * 6.32 = 107.44 times	2.96	318.02	400

NOTE: Test plots of the transmitting time slot are shown as below.

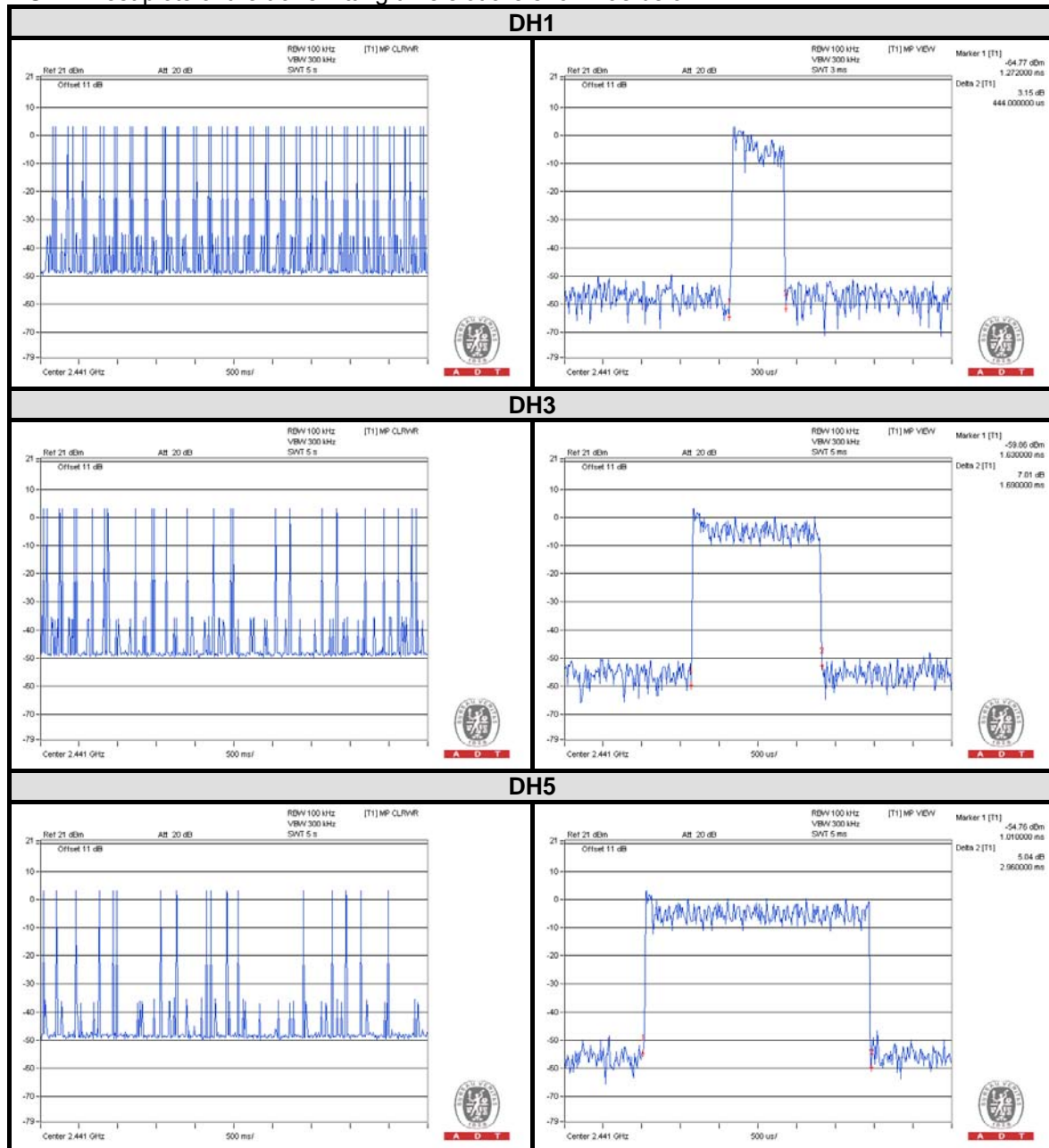

4.5 CHANNEL BANDWIDTH

4.5.1 LIMITS OF CHANNEL BANDWIDTH

For frequency hopping system operating in the 2400-2483.5MHz, If the 20dB bandwidth of hopping channel is greater than 25kHz, two-thirds 20dB bandwidth of hopping channel shall be a minimum limit for the hopping channel separation.

4.5.2 TEST SETUP

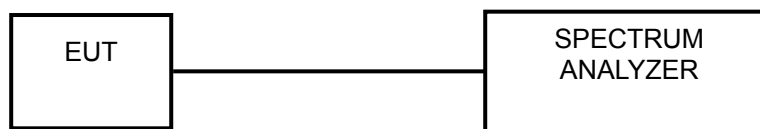

4.5.3 TEST INSTRUMENTS

Refer to section 4.1.2 to get information of above instrument.

4.5.4 TEST PROCEDURE

- a. Check the calibration of the measuring instrument using either an internal calibrator or a known signal from an external generator.
- b. Turn on the EUT and connect it to measurement instrument. Then set it to any one convenient frequency within its operating range. Set a reference level on the measuring instrument equal to the highest peak value.
- c. Measure the frequency difference of two frequencies that were attenuated 20dB from the reference level. Record the frequency difference as the emission bandwidth.
- d. Repeat above procedures until all frequencies measured were complete.

4.5.5 DEVIATION FROM TEST STANDARD

No deviation.

4.5.6 EUT OPERATING CONDITION

The software provided by client enabled the EUT to transmit and receive data at lowest, middle and highest channel frequencies individually.



A D T

4.5.7 TEST RESULTS

CHANNEL	FREQUENCY (MHz)	20dB BANDWIDTH (MHz)	
		GFSK	8DPSK
0	2402	1.01	1.24
39	2441	1.01	1.24
78	2480	1.01	1.24

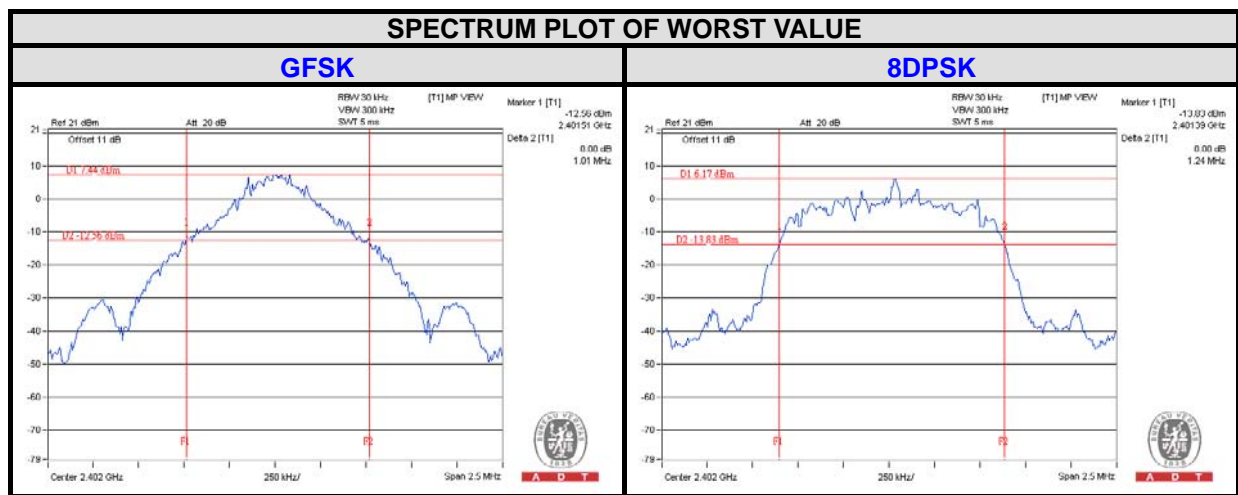

4.6 HOPPING CHANNEL SEPARATION

4.6.1 LIMIT OF HOPPING CHANNEL SEPARATION

At least 25kHz or two-third of 20dB hopping channel bandwidth (whichever is greater).

4.6.2 TEST SETUP

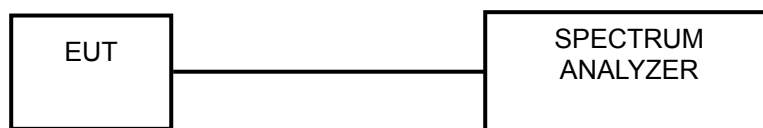

4.6.3 TEST INSTRUMENTS

Refer to section 4.1.2 to get information of above instrument.

4.6.4 TEST PROCEDURES

- a. Check the calibration of the measuring instrument using either an internal calibrator or a known signal from an external generator.
- b. Turn on the EUT and connect it to measurement instrument. Then set it to any one convenient frequency within its operating range.
- c. By using the MaxHold function record the separation of two adjacent channels.
- d. Measure the frequency difference of these two adjacent channels by SA MARK function. And then plot the result on SA screen.
- e. Repeat above procedures until all frequencies measured were complete.

4.6.5 DEVIATION FROM TEST STANDARD

No deviation.

4.6.6 TEST RESULTS

CHANNEL	FREQUENCY (MHz)	ADJACENT CHANNEL SEPARATION (MHz)		20dB BANDWIDTH (MHz)		MINIMUM LIMIT (MHz)		PASS / FAIL
		GFSK	8DPSK	GFSK	8DPSK	GFSK	8DPSK	
0	2402	1.01	1.01	1.01	1.24	0.67	0.83	PASS
39	2441	1.01	1.00	1.01	1.24	0.67	0.83	PASS
78	2480	1.00	1.00	1.01	1.24	0.67	0.83	PASS

NOTE: The minimum limit is two-third 20dB bandwidth.

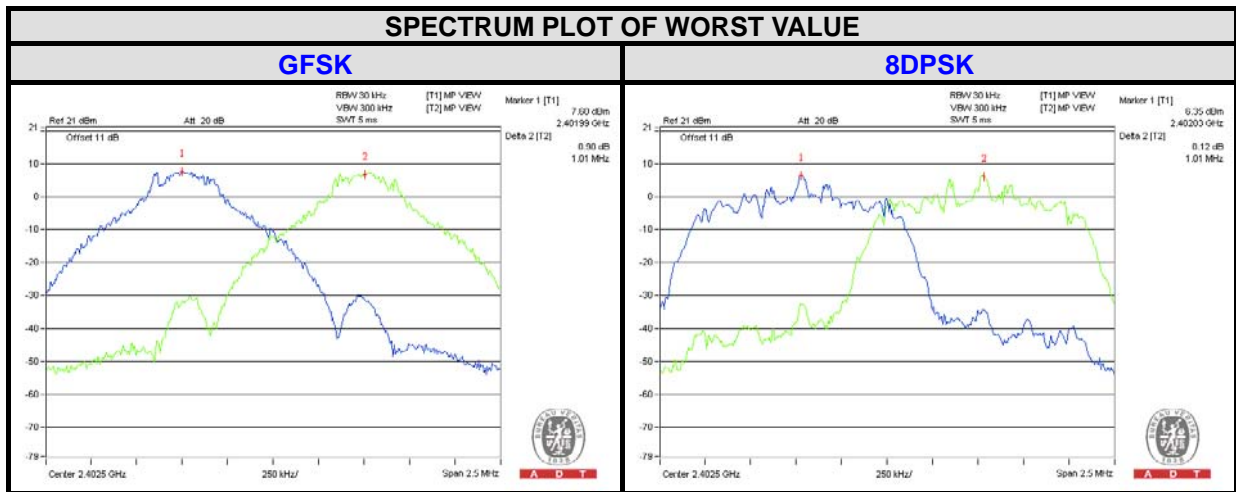

4.7 MAXIMUM OUTPUT POWER

4.7.1 LIMITS OF MAXIMUM OUTPUT POWER MEASUREMENT

The Maximum Output Power Measurement is 125mW.

4.7.2 TEST SETUP

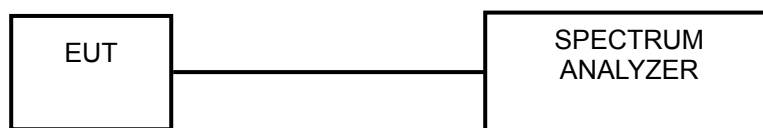

4.7.3 TEST INSTRUMENTS

Refer to section 4.1.2 to get information of above instrument.

4.7.4 TEST PROCEDURES

- a. Check the calibration of the measuring instrument using either an internal calibrator or a known signal from an external generator.
- b. Turn on the EUT and connect it to measurement instrument. Then set it to any one convenient frequency within its operating range. Set a reference level on the measuring instrument equal to the highest peak value.
- c. The center frequency of the spectrum analyzer is set to the fundamental frequency and using 3MHz RBW and 10MHz VBW.
- d. Measure the captured power within the band and recording the plot.
- e. Repeat above procedures until all frequencies required were complete.

4.7.5 DEVIATION FROM TEST STANDARD

No deviation.

4.7.6 EUT OPERATING CONDITION

The software provided by client enabled the EUT to transmit and receive data at lowest, middle and highest channel frequencies individually.



A D T

4.7.7 TEST RESULTS

CHANNEL	FREQUENCY (MHz)	OUTPUT POWER (mW)		OUTPUT POWER (dBm)		POWER LIMIT (mW)	PASS / FAIL
		GFSK	8DPSK	GFSK	8DPSK		
0	2402	9.354	6.546	9.71	8.16	125	PASS
39	2441	9.484	7.603	9.77	8.81	125	PASS
78	2480	7.621	5.248	8.82	7.20	125	PASS

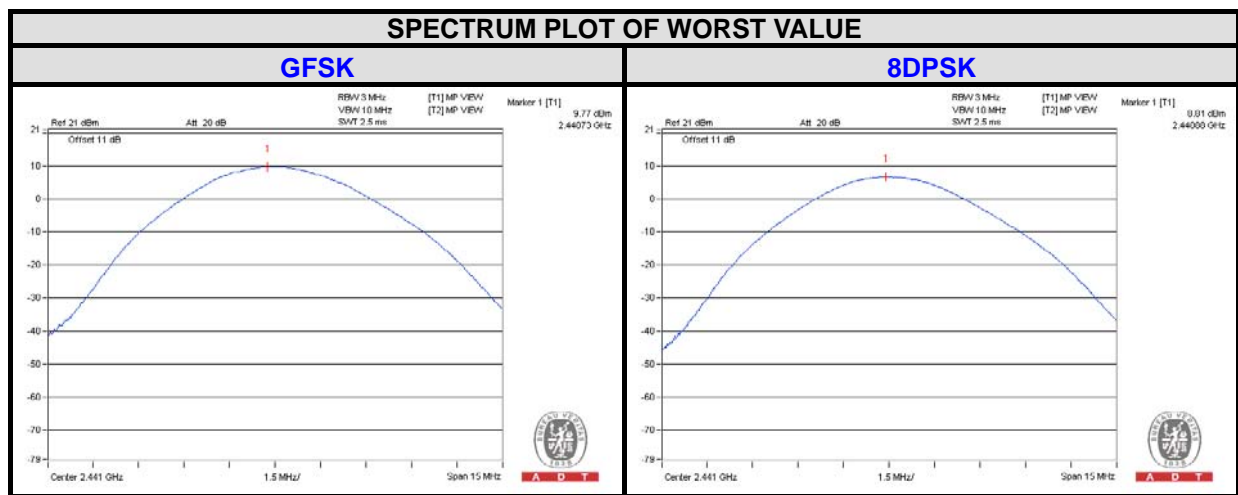

4.8 CONDUCTED OUT OF BAND EMISSION MEASUREMENT

4.8.1 LIMITS OF CONDUCTED OUT OF BAND EMISSION MEASUREMENT

Below -20dB of the highest emission level of operating band (in 100KHz RBW).

4.8.2 TEST INSTRUMENTS

Refer to section 4.1.2 to get information of above instrument.

4.8.3 TEST PROCEDURE

The transmitter output was connected to the spectrum analyzer via a low lose cable. Set both RBW and VBW of spectrum analyzer to 100 kHz and 300 kHz with suitable frequency span including 100 MHz bandwidth from band edge. The band edges was measured and recorded.

4.8.4 DEVIATION FROM TEST STANDARD

No deviation.

4.8.5 EUT OPERATING CONDITION

The software provided by client enabled the EUT to transmit and receive data at lowest, middle and highest channel frequencies individually.

4.8.6 TEST RESULTS

The spectrum plots are attached on the following images. D1 line indicates the highest level, D2 line indicates the 20dB offset below D1. It shows compliance with the requirement.



A D T

GFSK

Hopping disabled_ Low Channel

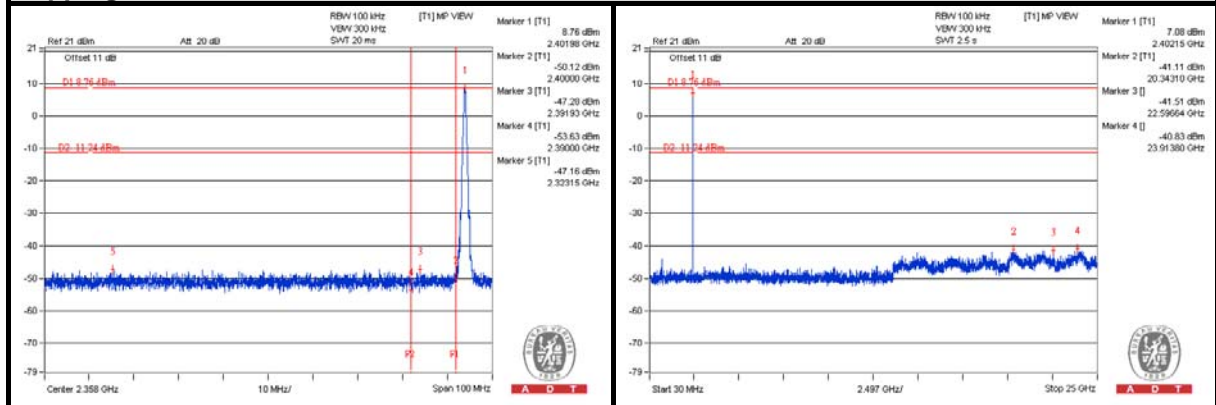

Hopping disabled_ High Channel

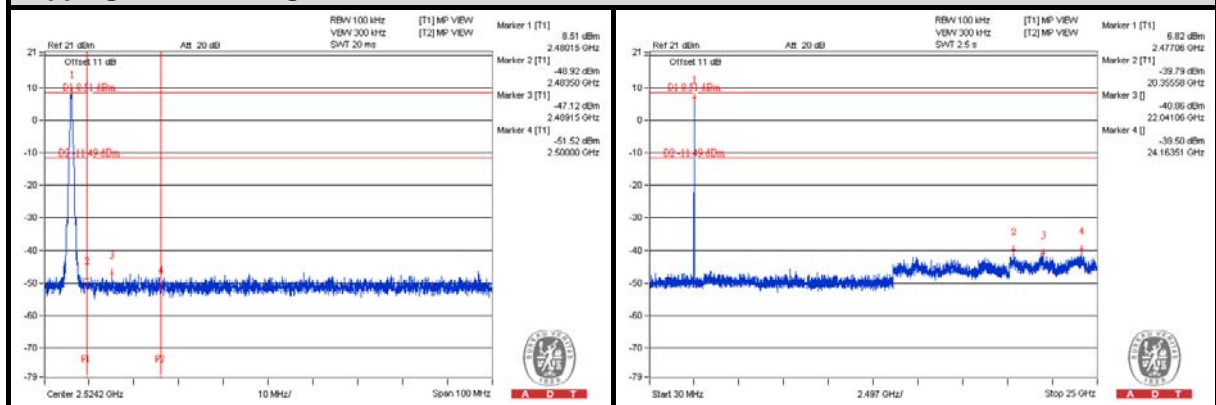

Hopping enabled_ Low Channel

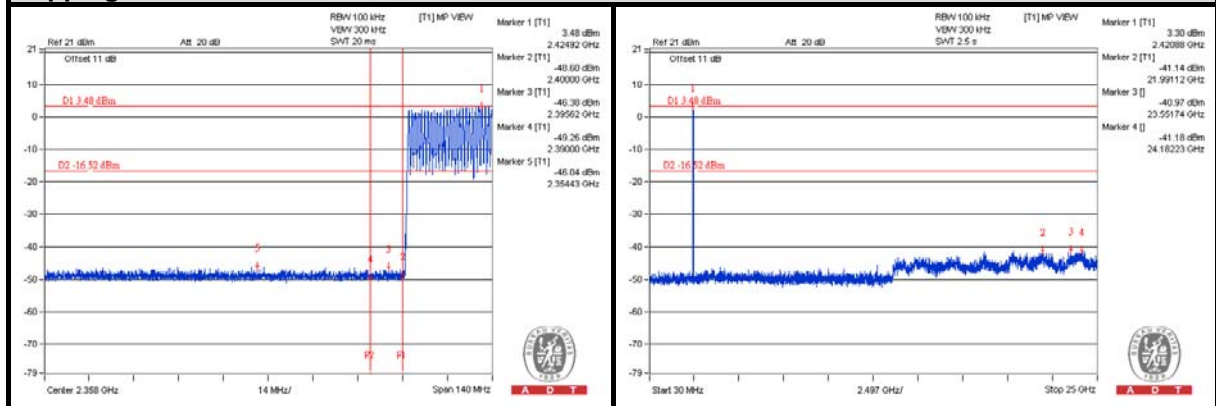

Hopping enabled_ High Channel

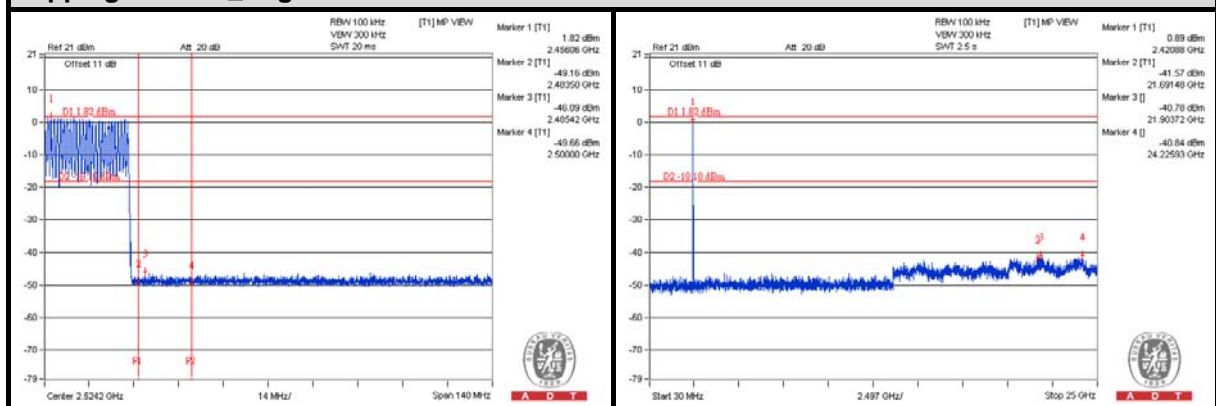



A D T

8DPSK

Hopping disabled_ Low Channel

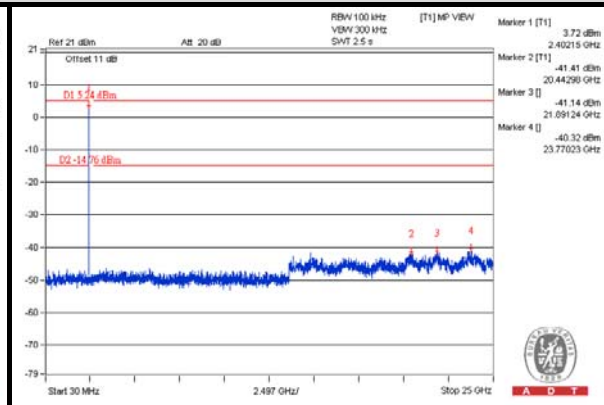
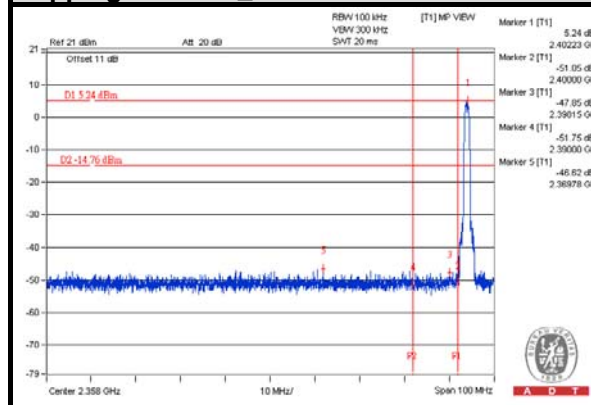

Hopping disabled_ High Channel

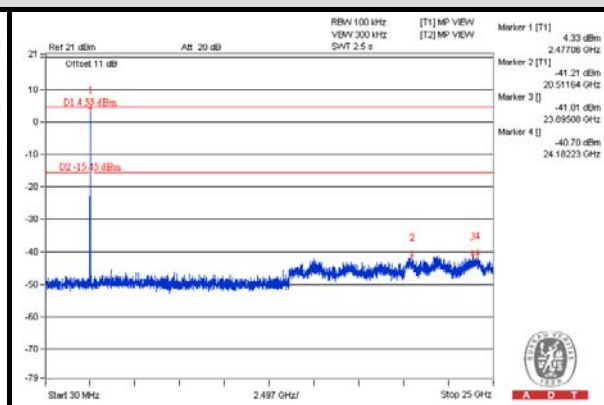
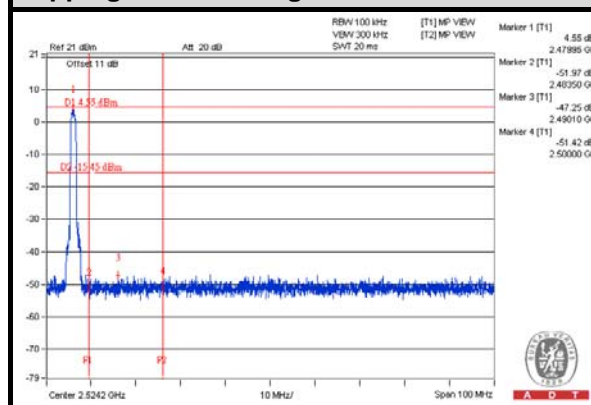

Hopping enabled_ Low Channel

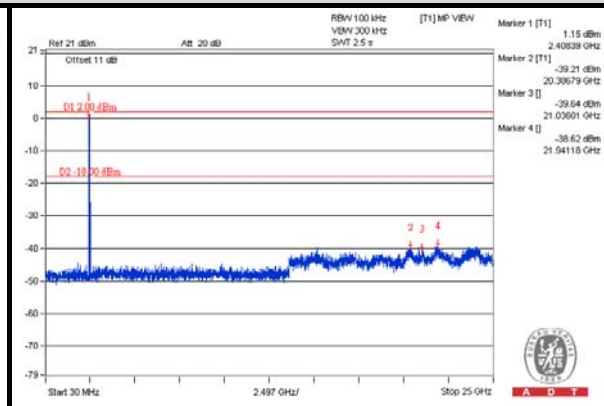
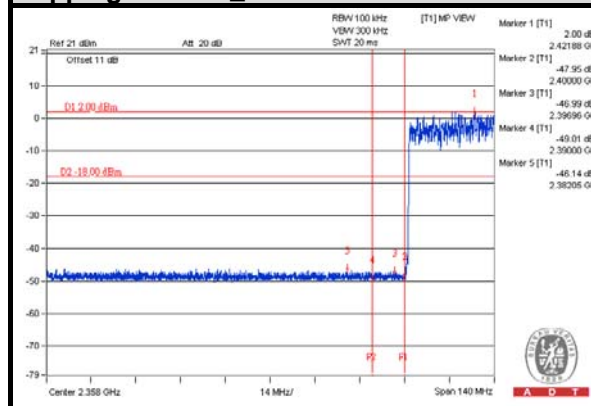

Hopping enabled_ High Channel

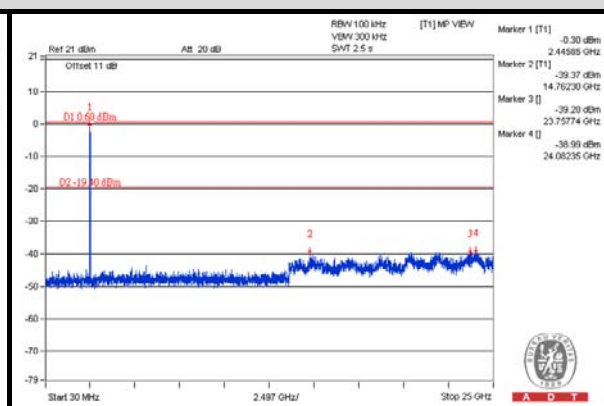
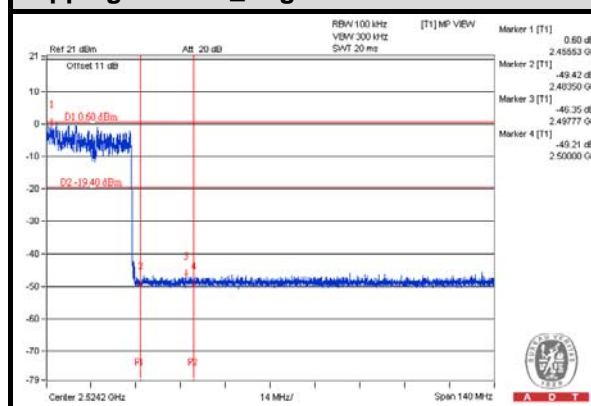



A D T

5. PHOTOGRAPHS OF THE TEST CONFIGURATION

Please refer to the attached file (Test Setup Photo).



6. INFORMATION ON THE TESTING LABORATORIES

We, Bureau Veritas Consumer Products Services (H.K.) Ltd., Taoyuan Branch, were founded in 1988 to provide our best service in EMC, Radio, Telecom and Safety consultation. Our laboratories are accredited and approved according to ISO/IEC 17025.

If you have any comments, please feel free to contact us at the following:

Linko EMC/RF Lab:

Tel: 886-2-26052180

Fax: 886-2-26051924

Hsin Chu EMC/RF Lab:

Tel: 886-3-5935343

Fax: 886-3-5935342

Hwa Ya EMC/RF/Safety Telecom Lab:

Tel: 886-3-3183232

Fax: 886-3-3270892

Email: service.adt@tw.bureauveritas.com

Web Site: www.bureauveritas-adt.com

The address and road map of all our labs can be found in our web site also.

7. APPENDIX A – MODIFICATIONS RECORDERS FOR ENGINEERING CHANGES TO THE EUT BY THE LAB

No any modifications are made to the EUT by the lab during the test.

--- END ---