

TEST REPORT

For

Mobile phone incorporated with Felica (RFID)

In conformity with

FCC CFR 47 Part15 (October 1, 2007) / RSS-210 Issue 7, RSS-Gen Issue 2

Model: F-04A

FCC ID/ IC Certification No.: VQK-F-04A / 337E-F04A

Test Item: Mobile phone incorporated with Felica (RFID)

Report No: RY0811P07R3

Issue Date: 7 November 2008

Prepared for

Fujitsu Limited.
1-1, Kamikodanaka 4-chome, Nakahara-ku, Kawasaki 211-8588,
Japan

Prepared by

RF Technologies Ltd.
472, Nippa-cho, Kohoku-ku, Yokohama, 223-0057, Japan
Telephone: +81+(0)45- 534-0645
FAX: +81+(0)45- 534-0646

This report shall not be reproduced, except in full, without the written permission of RF Technologies Ltd. The test results in this report apply only to the sample tested. RF Technologies Ltd. is managed to ISO17025 and has the necessary knowledge and test facilities for testing according to the referenced standards.

Table of contents

1	General information.....	3
1.1	Product description	3
1.2	Test(s) performed/ Summary of test result	3
1.3	Test facility	4
1.4	Measurement uncertainty.....	4
1.5	Summary of test results.....	5
1.6	Setup of equipment under test (EUT)	5
1.6.1	Test configuration of EUT	5
1.6.2	Operating condition	6
1.6.3	Setup diagram of tested system.....	6
1.7	Equipment modifications	6
1.8	Deviation from the standard	6
2	Test procedure and test data	7
2.1	Occupied bandwidth (99%)	7
2.2	Transmitter AC power line conducted emissions	8
2.3	Transmitter radiated spurious emissions between 9 KHz to 30 MHz	11
2.4	Transmitter radiated spurious emissions between 30MHz to 1000MHz	14
2.5	Frequency stability.....	17
2.6	Receiver AC power line conducted emissions.....	18
2.7	Receiver Radiated spurious emissions between 30MHz to 1000MHz	21
3	Test setup photographs	24
3.1	Definition of the EUT axis.....	24
3.2	Radiated spurious emissions.....	26
3.3	AC power line conducted emissions.....	28
4	List of utilized test equipment/ calibration	29

History

Report No	Date	Revisions	Revised by
RY0811P07R3	7 November 2008	Initial Issue	M.Asano

1 General information

1.1 Product description

Test item : Mobile phone incorporated with Felica (RFID)
Manufacturer : Fujitsu Limited
Address : 1-1, Kamikodanaka 4-chome, Nakahara-ku, Kawasaki, 211-8588, Japan
Model : F-04A
FCC ID : VQK-F-04A
IC Certification No : 337E-F04A
Serial numbers : 353709020001995
Transmitting Frequency : 13.56 MHz (RFID)
Type of Modulation : ASK
Operating temperature range : -10 to +55 degree C (Manufacturer declared)
Receipt date of EUT : 20 October 2008
Nominal power source voltages : DC 3.7V (Battery)

1.2 Test(s) performed/ Summary of test result

Test specification(s) : FCC CFR 47. Part 15 (October 1, 2007) / RSS-210 Issue 7, RSS-Gen Issue 2
Test method(s) : ANSI C63.4: 2003
Test(s) started : 20 October 2008
Test(s) completed : 24 October 2008
Purpose of test(s) : Grant for Certification of FCC / IC

Summary of test result : Complied

Note: The above judgment is only based on the measurement data and it does not include the measurement uncertainty. Accordingly, the statement below is applied to the test result.

The EUT complies with the limit required in the standard in case that the margin is not less than the measurement uncertainty in the Laboratory.

Compliance of the EUT is more probable than non-compliance is case that the margin is less than the measurement uncertainty in the Laboratory.

Test engineer : M. Asano
M.Asano
EMC testing department

Reviewer : T. Ikegami
T. Ikegami
Manager
EMC testing department

1.3 Test facility

The Federal Communications Commission has reviewed the technical characteristics of the test facilities at **RF Technologies Ltd.**, located in 472, Nippa-cho, Kohoku-ku, Yokohama, 223-0057, Japan, and has found these test facilities to be in compliance with the requirements of 47 CFR Part 15, section 2.948, per October 1, 2007. The description of the test facilities has been filed under registration number 879401 at the Office of the Federal Communications Commission. The facility has been added to the list of laboratories performing these test services for the public on a fee basis.

The list of all public test facilities is available on the Internet at <http://www.fcc.gov>.

Registered by Voluntary Control Council for Interference by Information Technology Equipment (VCCI);

Each registered facility number is as follows;

Test site (Semi-Anechoic chamber 3m) R-2393

Test site (Shielded room) C-2617

Registered by Industry Canada (IC): The registered facility number is as follows

Test site No.1 (Anechoic chamber 3m): 6974A

Accredited by **National Voluntary Laboratory Accreditation Program (NVLAP)** for the emission tests stated in the scope of the certificate under Certificate Number 200780-0

This report must not be used by the client to claim product certification, approval, or endorsement by NVLAP, NIST, or any agency of the Federal Government.



NVLAP LAB CODE 200780-0

1.4 Measurement uncertainty

The treatment of uncertainty is based on the general matters on the definition of uncertainty in “Guide to the expression of uncertainty in measurement (GUM)” published by ISO. The Lab’s uncertainty is determined by referring UKAS Publication LAB34: 2002 “The Expression of Uncertainty in EMC Testing” and CISPR16-4-2: 2003 “Uncertainty in EMC Measurements”.

The uncertainty of the measurement result in the level of confidence of approximately 95% (k=2) is as follows;

Conducted emission: ± 1.9 dB (10 kHz – 30 MHz)

Radiated emission (9 kHz - 30MHz): ± 2.8 dB

Radiated emission (30MHz - 1000MHz): ± 5.7 dB

1.5 Summary of test results

Requirement of;	Section in FCC15	Section in RSS210/ RSS-Gen	Result	Section in this report
1.5.1 Occupied bandwidth (99%)	-	RSS-Gen 4.6.1	-	2.1
1.5.2 Transmitter AC power line conducted emissions	15.207	RSS-Gen 7.2.2	Complied	2.2
1.5.3 Transmitter radiated emissions between 9kHz to 30 MHz	15.225(a),(b),(c) and (d)	A2.6(a),(b),(c) and(d)	Complied	2.3
1.5.4 Transmitter radiated emissions between 30MHz to 1000 MHz	15.225 (d)	A2.6 (d)	Complied	2.4
1.5.5 Carrier frequency stability	15.225 (e)	A2.6 (d)	Complied	2.5
1.5.6 Receiver AC power line conducted emissions	15.107	RSS-Gen 7.2.2	Complied	2.6
1.5.7 Receiver radiated emissions above 30 MHz	15.109	RSS-Gen 6	Complied	2.7

The field strength of spurious emission was measured in three orthogonal EUT positions (X-Plane, Y- Plane and Z- Plane). The axis defined in the photographs in clause 3.1 in this report.

1.6 Setup of equipment under test (EUT)

1.6.1 Test configuration of EUT

Equipment(s) under test:

	Item	Manufacturer	Model No.	Serial No.
A	Mobile phone incorporated with Felica (RFID)	Fujitsu Limited	F-04A	353709020001995
B	Li-ion Battery Pack	Fujitsu Limited	F09	AAF29091

Support Equipment(s):

	Item	Manufacturer	Model No.	Serial No.
C	AC Adapter	NEC Corporation	MAS-BH0008-A 002	QKA

Connected cable(s):

No.	Item	Identification (Manu.e.t.c)	Shielded YES / NO	Ferrite Core YES / NO	Connector Type Shielded YES / NO	Length (m)
1(*)	DC power cable	NEC Corporation	No	No	No	0.6
2	AC power cable	NEC Corporation	No	No	No	1.3
3(*)	Conector convert cable	-	No	No	No	0.1
4	Earphone cable	NTT DOCOMO, INC.	No	No	No	1.3

* No.1 and No.3 are selectable.

1.6.2 Operating condition

Operating mode:

- Continuous transmission under the test mode
- Standby mode under the test mode

1.6.3 Setup diagram of tested system

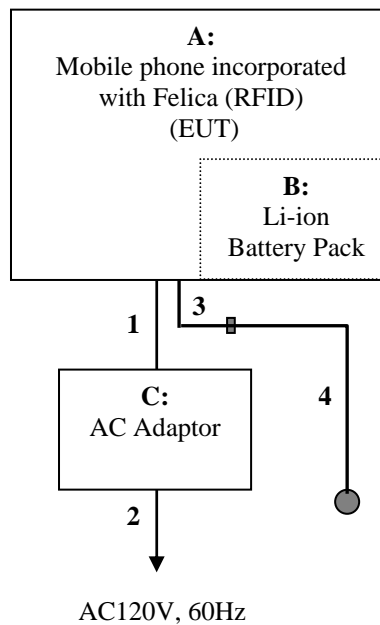

Note: EUT has one connector which is connected either AC adapter (No.1 and No.2 above) or Earphone (No. 3 and No.4 above). On each tests, the result of the worse condition is reported as worst case in this report.

1.7 Equipment modifications

No modifications have been made to the equipment in order to achieve compliance with the applicable standards described in clause 1.2.

1.8 Deviation from the standard

No deviations from the standards described in clause 1.2.

2 Test procedure and test data

2.1 Occupied bandwidth (99%)

Test setup

Test setup was implemented according to the method of ANSI C63.4: 2003 13.1.7 “Occupied bandwidth measurements” and Annex H.6 “Occupied bandwidth measurements”.

Test procedure

Measurement procedures were implemented according to the method of ANSI C63.4: 2003 13.1.7 “Occupied bandwidth measurements” and Annex H.6 “Occupied bandwidth measurements”.

The spectrum analyzer RBW was set as follows and VBW the video bandwidth shall be set to a value at least three times greater than the RBW.

Fundamental frequency being measured	Minimum instrument bandwidth
9 kHz to 30 MHz	1 kHz
30 MHz to 1000 MHz	10 kHz
1000 MHz to 40 GHz	100 kHz

Limitation

There are no limitations. The measurement value is used to calculate the emission designator.

Test equipment used (refer to List of utilized test equipment)

TR04	LP01	CL11			
------	------	------	--	--	--

Test results – Reporting purpose.

Frequency (MHz)	99% Bandwidth (kHz)
13.56	2.26

Test Data

Tested Date: 22 October 2008

Temperature: 18 °C
 Humidity: 62 %
 Atmos. Press: 1025 hPa

Operating mode: Continuous transmission with modulation

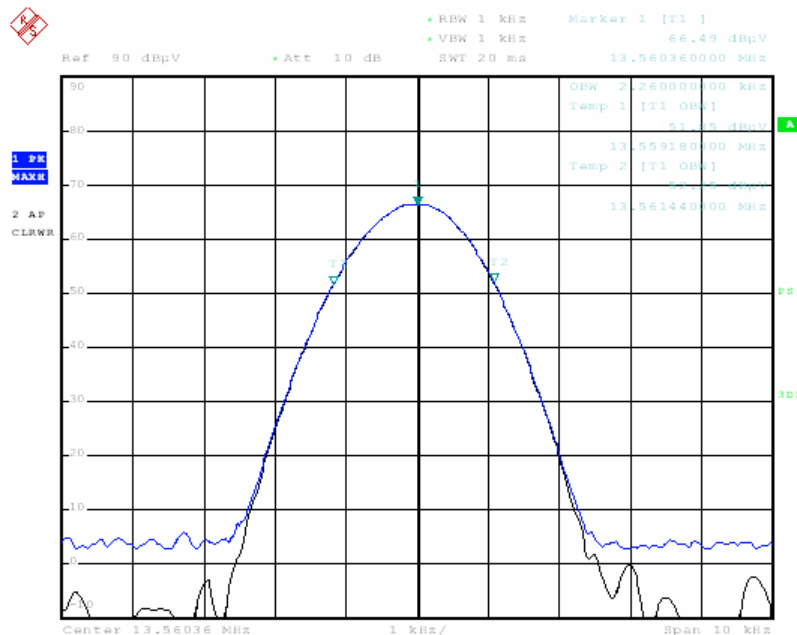

2.2 Transmitter AC power line conducted emissions

Test setup

Test setup was implemented according to the method of ANSI C63.4: 2003 clause 6 “General requirements for EUT equipment arrangements and operation” and Annex H.1 “AC power line conducted emission measurements setup”.

Test procedure

Measurement procedures were implemented according to the method of ANSI C63.4: 2003 clauses 7, clause 13.1.3 and Annex H.2 “AC power line conducted emission measurements”.

Exploratory measurements were used the spectrum analyzer to identify the frequency of the emission that has the highest amplitude relative to the limit by operating the EUT in a range of typical modes of operation, cable positions, and with a typical system equipment configuration and arrangement.

Final ac power line conducted emission measurements were performed based on the exploratory tests.

The EUT cable configuration and arrangement and mode of operation that produced the emission with the highest amplitude relative to the limit are selected for the final measurement.

When the measurement value is grater than average limitation the average detection measurements were performed.

Applicable rule and limitation

§15.207 (a) AC power line conducted limits

Frequency of Emission (MHz)	Conducted Limit (dBuV)	
	Quasi-peak	Average
0.15-0.5	66 to 56 *	56 to 46 *
0.5-5	56	46
5-30	60	50

* Decreases with the logarithm of the frequency.

The lower limit applies at the band edges.

Test equipment used (refer to List of utilized test equipment)

TR04	PL06	LN05	CL11
------	------	------	------

Test results - Complied with requirement.

Test Data

Tested Date: 20 October 2008

Temperature: 18 °C
Humidity: 60 %
Atmos. Press: 1015 hPa

Operating Mode: Continuous Transmission (Worst case configuration)

No.	Frequency [MHz]	Reading		C.F. [dB]	Result		Limit		Margin		PHASE
		QP [dBuV]	AV [dBuV]		QP [dBuV]	AV [dBuV]	QP [dBuV]	AV [dBuV]	QP [dB]	AV [dB]	
1	0.151	45.7	31.4	0.3	46.0	31.7	65.9	55.9	19.9	24.2	N
2	0.151	47.4	33.1	0.3	47.7	33.4	65.9	55.9	18.2	22.5	L
3	1.810	39.7	27.8	0.3	40.0	28.1	56.0	46.0	16.0	17.9	L
4	1.865	40.1	29.1	0.3	40.4	29.4	56.0	46.0	15.6	16.6	N
5	13.560	34.3	33.7	1.1	35.4	34.8	60.0	50.0	24.6	15.2	L
6	13.560	38.4	38.0	1.1	39.5	39.1	60.0	50.0	20.5	10.9	N

The power line conducted emission voltage is calculated by adding the LISN factor and Cable loss attenuation from the measured reading. The calculation is as follows:

$$\text{Result} = \text{Reading} + \text{C. F.}$$

where C.F. = LISN Factor + Cable Loss [dB]

Sample calculation at 13.560 MHz Ave. result as follow:

$$\text{Result} = \text{Reading} + \text{C.F.} = 38.0 + 1.1 = 39.1 \text{ [dBuV]}$$
$$\text{Margin} = \text{Limit} - \text{Result} = 50.0 - 39.1 = 10.9 \text{ [dB]}$$

Graphical express of test result (0.15 MHz-30MHz)

AC Power line conducted emission. (Phase N)

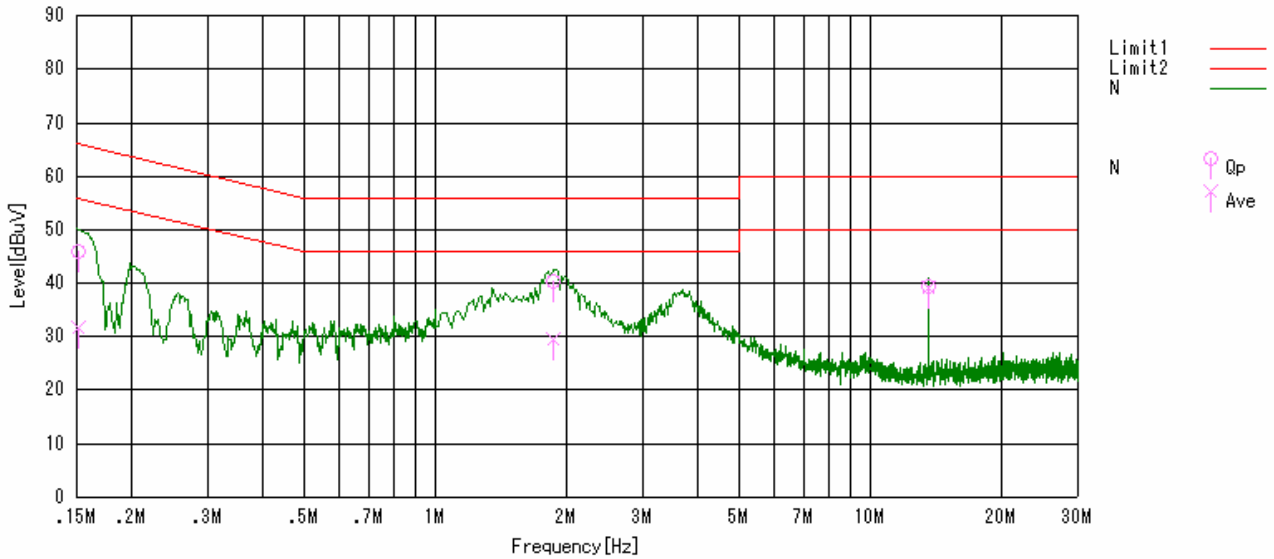

AC Power line conducted emission. (Phase L)

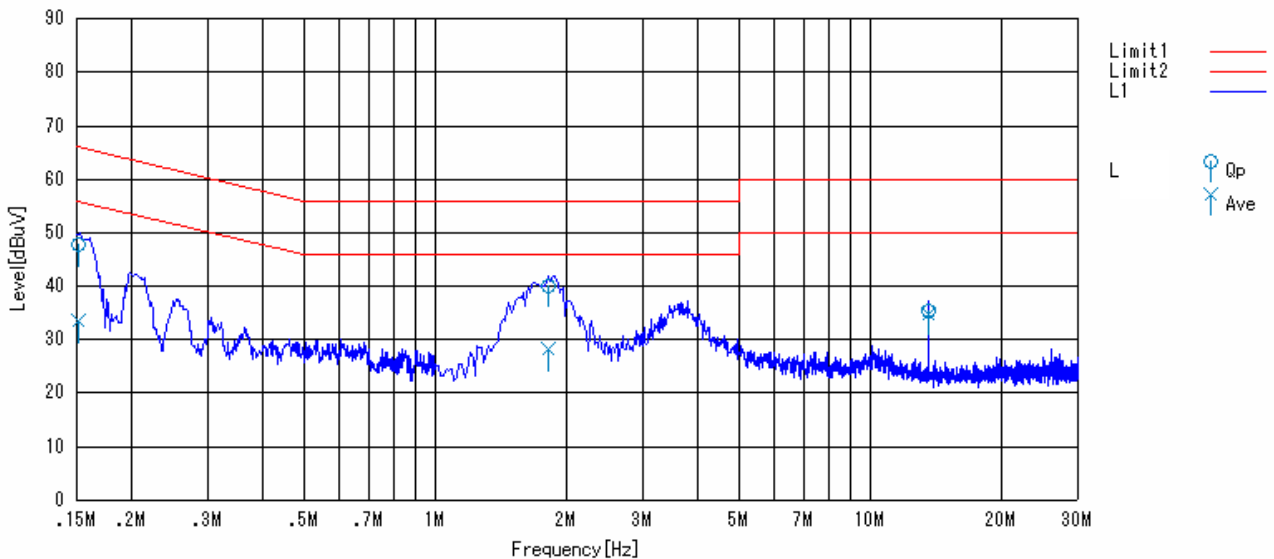

2.3 Transmitter radiated spurious emissions between 9 KHz to 30 MHz

Test setup

Test setup was implemented according to the method of ANSI C63.4: 2003 clause 6 “General requirements for EUT equipment arrangements and operation”, clause 8.2 and Annex H.3 “Radiated emission measurements setup”.

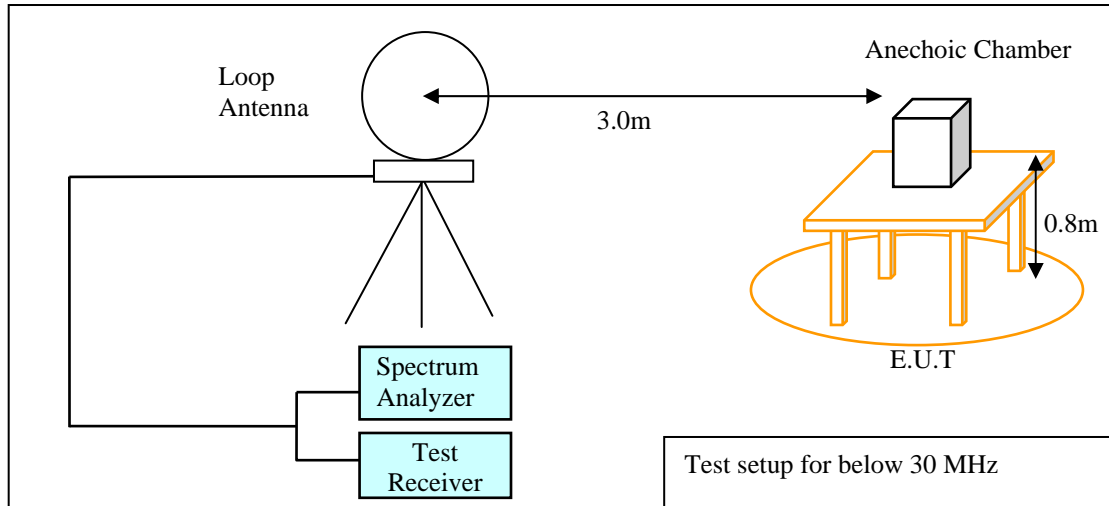

Test procedure

Measurement procedures were implemented according to the method of ANSI C63.4: 2003 clauses 8.2. The EUT is placed on a non-conducted table which is 0.8m height from a ground plane and the measurement antenna to EUT distance is 3 meters. The turn table is rotated for 360 degrees to determine the maximum emission level.

In the frequency range of 9 kHz to 30 MHz, a calibrated loop antenna was positioned with its plane vertical at the distance 3m from the EUT with an extrapolation of corrected distance factor and rotated about its vertical axis for maximum response at each azimuth about the EUT. For certain applications, the loop antenna also needs to be positioned horizontally. The center of the loop shall be 1 m above the ground.

EUT is placed at three different orientations (X, Y and Z axis) in order to find the worst orientation. The spectrum analyzer and receiver is set to the followings;

Below 30 MHz:

RBW=10 kHz, VBW= 30 kHz, final measurement is carried out with a receiver RBW of 9 kHz (QP)

Applicable rule and limitation

§15.205 restricted bands of operation

Except as shown in paragraph 15.205 (d) of this section, only spurious emissions are permitted in any of the frequency bands listed below:

MHz	MHz	MHz	GHz
0.090 - 0.110	16.42 - 16.423	399.9 - 410	4.5 - 5.15
0.490 - 0.510	16.69475 - 16.69525	608 - 614	5.35 - 5.46
2.1735 - 2.1905	16.80425 - 16.80475	960 - 1240	7.25 - 7.75
4.125 - 4.128	25.5 - 25.67	1300 - 1427	8.025 - 8.5
4.17725 - 4.17775	37.5 - 38.25	1435 - 1626.5	9.0 - 9.2
4.20725 - 4.20775	73 - 74.6	1645.5 - 1646.5	9.3 - 9.5
6.215 - 6.218	74.8 - 75.2	1660 - 1710	10.6 - 12.7
6.26775 - 6.26825	108 - 121.94	1718.8 - 1722.2	13.25 - 13.4
6.31175 - 6.31225	123 - 138	2200 - 2300	14.47 - 14.5
8.291 - 8.294	149.9 - 150.05	2310 - 2390	15.35 - 16.2
8.362 - 8.366	156.52475 - 156.52525	2483.5 - 2500	17.7 - 21.4
8.37625 - 8.38675	156.7 - 156.9	2690 - 2900	22.01 - 23.12
8.41425 - 8.41475	162.0125 - 167.17	3260 - 3267	23.6 - 24.0
12.29 - 12.293	167.72 - 173.2	3332 - 3339	31.2 - 31.8
12.51975 - 12.52025	240 - 285	3345.8 - 3358	36.43 - 36.5
12.57675 - 12.57725	322 - 335.4	3600 - 4400	(1)

15.205(b) except as provided in paragraphs (d) and (e), the field strength of emissions appearing within these frequency bands shall not exceed the limits shown in Section 15.209. At frequencies equal to or less than 1000 MHz, compliance with the limits in Section 15.209 shall be demonstrated using measurement instrumentation employing a CISPR quasi-peak detector. Above 1000 MHz, compliance with the emission limits in Section 15.209 shall be demonstrated based on the average value of the measured emissions. The provisions in Section 15.35 apply to these measurements.

§15.209 general requirements

Except as provided elsewhere in this Subpart, the emissions from an intentional radiator shall not exceed the field strength levels specified in the following table:

Frequency (MHz)	Field Strength (uV/m)	Measurement Distance (m)
0.009 - 0.490	2400/F (kHz)	300
0.490 - 1.705	24000/F (kHz)	30
1.705 - 30.0	30	30

In the emission table above, the tighter limit applies at the band edges.

The level of any unwanted emissions from an intentional radiator operating under these general provisions shall not exceed the level of the fundamental emission.

The emission limits shown in the above table are based on measurements employing a CISPR quasi-peak detector except for the frequency bands 9-90 kHz, 110-490 kHz.

Radiated emission limits in the above bands are based on measurements employing an average detector.

§15.225 Operation within the band 13.110 – 14.010 MHz

Frequency (MHz)	Field strength @30m (uV/m)	Field strength @30m (dBuV/m)	Field strength @3m (dBuV/m)
13.110 - 13.410	106	40.5	80.5
13.410 - 13.553	334	50.5	90.5
13.553 - 13.567	15,848	84.0	124.0
13.567 - 13.710	334	50.5	90.5
13.710 - 14.010	106	40.5	80.5

$\text{dBuV/m} = 20 \times \log(\text{uV/m})$, Corrected distance factor = 40dB / decade (15.31(f))

The field strength of any emissions appearing outside of the 13.110-14.010 MHz band shall not exceed the above radiated emission limits in § 15.209.

Test equipment used (refer to List of utilized test equipment)

AC01	LP01	CL11	TR04
------	------	------	------

Test results - Complied with requirement.

Test Data

Tested Date: 22 October 2008

Temperature: 19 °C
Humidity: 60 %
Atmos. Press: 1025 hPa

Operating mode: Continuous Communication
EUT position: Y-plane (Worst case)
Connected cable: AC adapter
Measurement distance: 3 m

§15.225(a)/ (b)/ (c) Fundamental emission

Freq. (MHz)	Reading at 3m (dBuV)	Detector (QP/Ave)	Corr. Factor (dB)	Result (dBuV/m)	Limit at 3m (dBuV/m)	Margin (dB)
13.560	39.6	QP	11.0	50.6	124.0	73.4

Correction Factor [dB] = Antenna Factor [dB/m] + Cable Loss [dB]

§15.225(d) Harmonics and spurious emission between 9 kHz to 30MHz (refer 15.209 and 15.205)

There were no spurious emissions graters than noise floor or 20dB below the limit.

2.4 Transmitter radiated spurious emissions between 30MHz to 1000MHz

Test setup

Test setup was implemented according to the method of ANSI C63.4: 2003 clause 6 “General requirements for EUT equipment arrangements and operation”, clause 8.2.3 and Annex H.4 “Radiated emission measurements setup”.

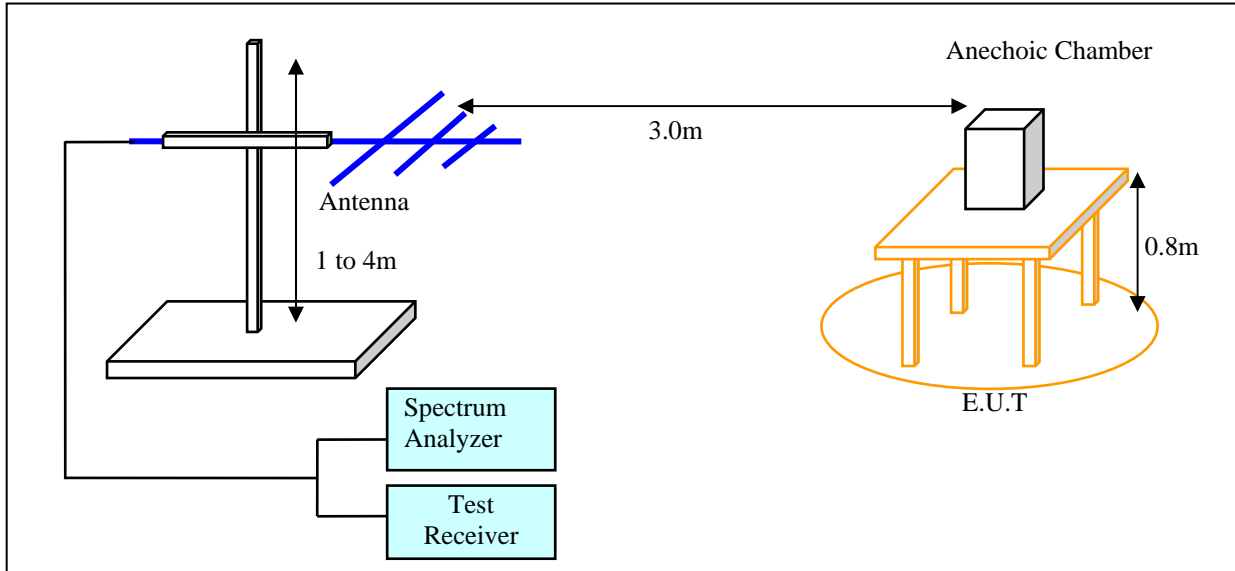

Test procedure

Measurement procedures were implemented according to the method of ANSI C63.4: 2003 clauses 8.2.3. Exploratory radiated measurements were performed at the measurement distance of 3 meters using broadband antennas and a spectrum analyzer. The EUT was set up in its typical configuration and arrangement, and operated in its various modes.

For each mode of operation required to be tested, the frequency spectrum were monitored. Variations in antenna height between 1 and 4 m, antenna polarization, EUT azimuth, and cable or wire placement (each variable within bounds specified elsewhere) were explored to produce the emission that has the highest amplitude relative to the limit.

Based on the exploratory measurement results, the one EUT, cable and wire arrangement, and mode of operation that produces the emission that has the highest amplitude relative to the limit is selected for the final measurement. This investigation was performed with the EUT rotated 360°, the antenna height scanned between 1m and 4m, and the antenna rotated to repeat the measurements for both the horizontal and vertical antenna polarizations. EUT was placed at three different orientations (X, Y and Z axis) in order to find the worst orientation.

Applicable rule and limitation

§15.209 general requirements

Except as provided elsewhere in this Subpart, the emissions from an intentional radiator shall not exceed the field strength levels specified in the following table:

Frequency (MHz)	Measurement Distance (m)	Field Strength (uV/m)	Field Strength (dBuV/m)
30 – 88	3	100	40.0
88 – 216	3	150	43.5
216 – 960	3	200	46.0
Above 960	3	500	54.0

In the emission table above, the tighter limit applies at the band edges.

The level of any unwanted emissions from an intentional radiator operating under these general provisions shall not exceed the level of the fundamental emission.

The emission limits shown in the above table are based on measurements employing a CISPR quasi-peak detector.

Test equipment used (refer to List of utilized test equipment)

AC01	BA03	CL11	PR03	TR04
------	------	------	------	------

Test results - Complied with requirement.

Test Data

Tested Date: 22 October 2008

Temperature: 19 °C
 Humidity: 60 %
 Atmos. Press: 1025 hPa

Operating mode: Continuous Communication

EUT position: X-plane (Worst case)

Connected cable: AC adapter

Measurement distance: 3 m

§15.225(d) Harmonics and spurious emission between 30MHz to 1000MHz (refer 15.209)

No.	Frequency [MHz]	Reading [dBuV]	Antenna Factor [dB/m]	Cable Loss [dB]	Preamplifier Gain [dB]	Result [dBuV/m]	Limit [dBuV/m]	Margin [dB]	Antenna Polarization
1	40.681	38.0	13.0	7.4	29.8	28.6	40.0	11.4	Vert.
2	54.241	39.6	7.5	7.6	29.7	25.0	40.0	15.0	Vert.
3	67.802	40.2	6.0	7.9	29.7	24.4	40.0	15.6	Hori.
4	67.802	37.9	6.0	7.9	29.7	22.1	40.0	17.9	Vert.
5	149.164	38.0	10.8	8.9	29.6	28.1	43.5	15.4	Hori.
6	149.164	36.9	10.8	8.9	29.6	27.0	43.5	16.5	Vert.

Calculation method

The Correction Factors and Result are calculated as followings.

$$\text{Correction Factor [dB]} = \text{Antenna Factor [dB/m]} + \text{Cable Loss [dB]} - \text{Preamplifier Gain [dB]}$$

$$\text{Result [dBuV/m]} = \text{Reading [dBuV]} + \text{Correction Factor [dB]}$$

Sample calculation at 40.681 MHz vertical result as follow:

$$\text{Result} = \text{Reading} + \text{C.F.} = 38.0 - 9.4 = 28.6 \text{ [dBuV/m]}$$

$$\text{Margin} = \text{Limit} - \text{Result} = 40.0 - 28.6 = 11.4 \text{ [dB]}$$

Graphical express of test result (30MHz-1000MHz)

Antenna polarization: **Horizontal**

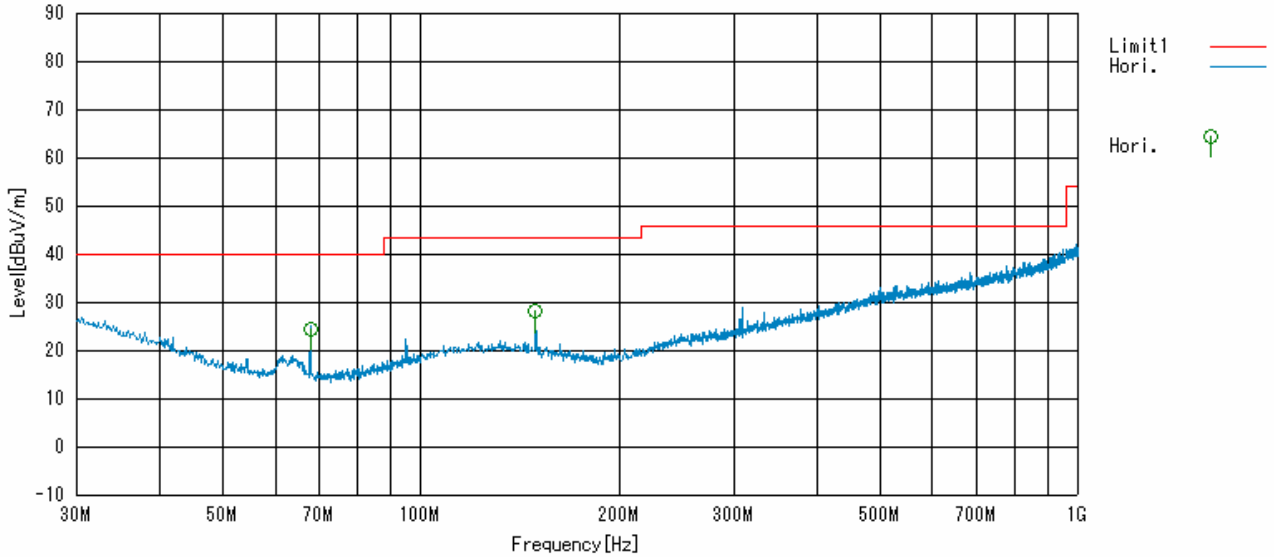

Antenna polarization: **Vertical**

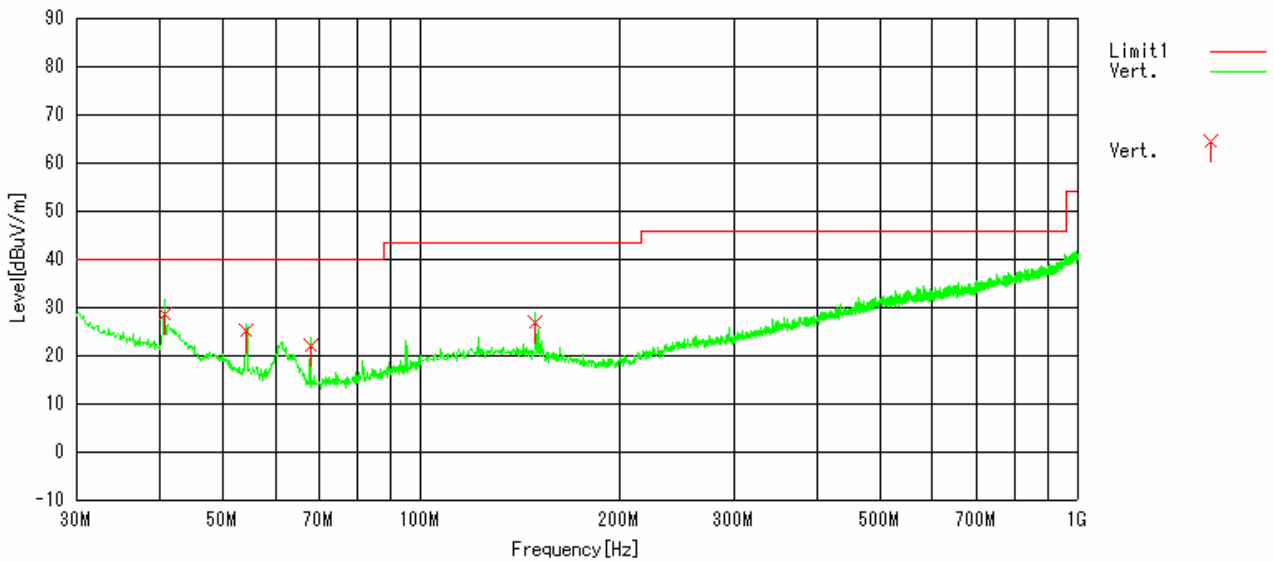

2.5 Frequency stability

Test setup

Test setup was implemented according to the method of ANSI C63.4: 2003 clauses 13.1.6.1 “Frequency stability measurements”, and Annex H.5 “Frequency measurements”.

Test procedure

Measurement procedures were implemented according to the test method of ANSI C63.4: 2003 Annex H5.

Place the de-energized EUT in the temperature test chamber. Supply the EUT with nominal ac voltage, or install a new or fully charged battery in the EUT. An antenna was connected to the antenna output connector of the EUT if possible.

The frequency counter was connected to the measurement antenna with a suitable length of coaxial cable.

The environmental chamber set to the highest temperature specified in applicable regulation.

Allow sufficient time (approximately 30 minutes) for the temperature of the chamber to stabilize.

Turn the EUT on and measure the EUT operating frequency at startup, and two, five, and ten minutes after startup.

The measurements were performed that the temperature chamber set to reduce the lowest temperature specified in applicable regulation.

Applicable rule and limitation

§15.225(e) Frequency tolerance

Test items	Variation ranges	Limit
Temperature variations	-10 to +55 degrees *	+/-0.01%

Note1: The above operating range is declared by manufacturer.

Test equipment used (refer to List of utilized test equipment)

LP51	TC01	TR06	
------	------	------	--

Test results - Complied with requirement.

Test Data

Tested Date: 24 October 2008

Temperature: 22 °C
 Humidity: 62 %
 Atmos. Press: 1020 hPa

Operating Mode: Continuous Transmission

Power supply: Full charged Li-ion battery

Temp. (Degrees)	Voltages (V)	Measured Frequency (MHz)				Worst Deviation (%)	Limit (%)
		Start-up	2 min.	5 min.	10 min.		
Ambient Temperatures Variation							
55	DC3.7V	13.560291	13.560293	13.560295	13.560295	+0.00218	+/-0.01
20	DC3.7V	13.560317	13.560316	13.560316	13.560316	+0.00234	+/-0.01
0	DC3.7V	13.560328	13.560324	13.560322	13.560321	+0.00242	+/-0.01
-10	DC3.7V	13.560291	13.560281	13.560269	13.560268	+0.00215	+/-0.01

2.6 Receiver AC power line conducted emissions

Test setup - Same as clause 2.2

Test procedure - Same as clause 2.2

Applicable rule and limitation

§15.107 (a) AC power line conducted limits

Frequency of Emission (MHz)	Conducted Limit (dBuV)	
	Quasi-peak	Average
0.15-0.5	66 to 56 *	56 to 46 *
0.5-5	56	46
5-30	60	50

* Decreases with the logarithm of the frequency. The lower limit applies at the band edges.

Test equipment used (refer to List of utilized test equipment)

TR04	PL06	LN05	CL11
------	------	------	------

Test results - Complied with requirement.

This transceiver could not achieved receiving mode only therefore the measurement was carried out under receiving ready condition of the EUT. This condition is same as standby.

Test Data

Tested Date: 20 October 2008

Temperature: 18 °C
Humidity: 60 %
Atmos. Press: 1015 hPa

Operating Mode: Ready to reception (same as standby)

No.	Frequency [MHz]	Reading		C.F. [dB]	Result		Limit		Margin		PHASE
		QP [dBuV]	AV [dBuV]		QP [dBuV]	AV [dBuV]	QP [dBuV]	AV [dBuV]	QP [dB]	AV [dB]	
1	0.152	45.1	30.1	0.3	45.4	30.4	65.9	55.9	20.5	25.5	N
2	0.168	44.5	33.2	0.3	44.8	33.5	65.1	55.1	20.3	21.6	L
3	1.671	36.8	21.7	0.3	37.1	22.0	56.0	46.0	18.9	24.0	L
4	1.872	40.2	28.4	0.3	40.5	28.7	56.0	46.0	15.5	17.3	N
5	3.676	35.6	25.2	0.5	36.1	25.7	56.0	46.0	19.9	20.3	N
6	3.688	29.1	14.3	0.5	29.6	14.8	56.0	46.0	26.4	31.2	L

The power line conducted emission voltage is calculated by adding the LISN factor and Cable loss attenuation from the measured reading. The calculation is as follows:

$$\text{Result} = \text{Reading} + \text{C. F.}$$

where C.F. = LISN Factor + Cable Loss [dB]

Sample calculation at 1.872 MHz QP. result as follow:

$$\text{Result} = \text{Reading} + \text{C.F.} = 40.2 + 0.3 = 40.5 \text{ [dBuV]}$$

$$\text{Margin} = \text{Limit} - \text{Result} = 56.0 - 40.5 = 15.5 \text{ [dB]}$$

Graphical express of test result (0.15 MHz-30MHz)

AC Power line conducted emission. (Phase N)

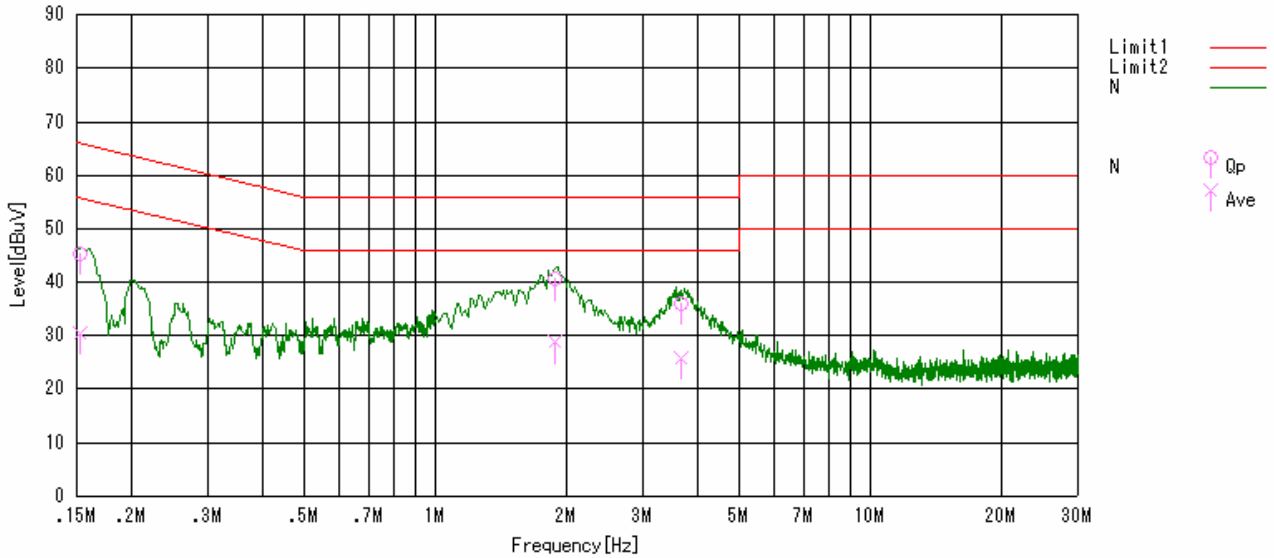

AC Power line conducted emission. (Phase L)

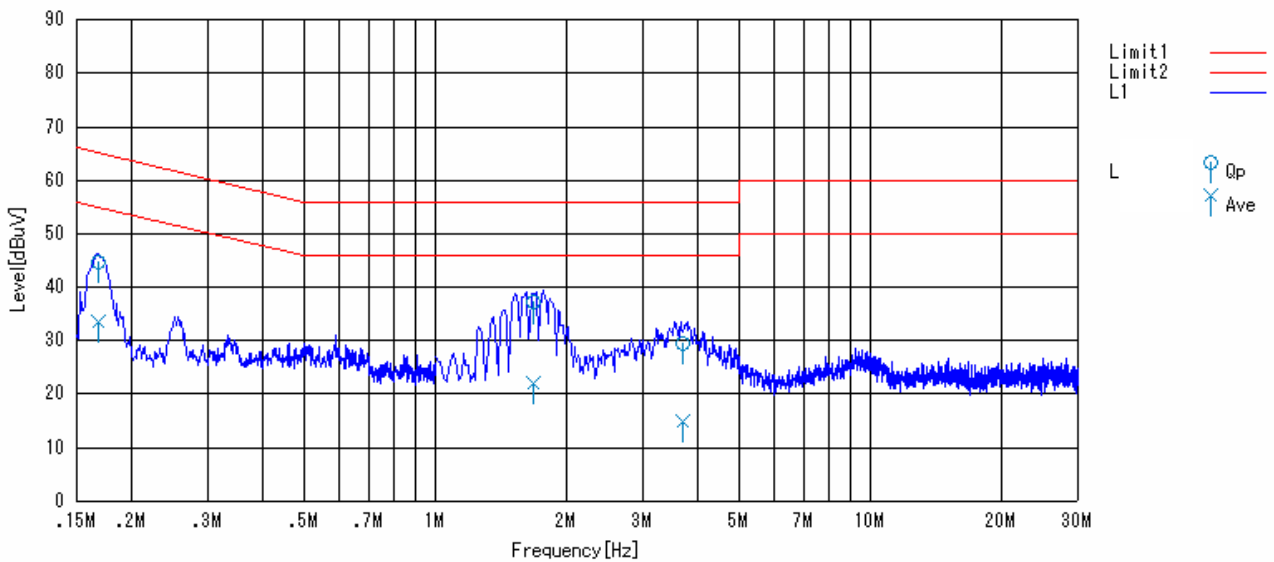

2.7 Receiver Radiated spurious emissions between 30MHz to 1000MHz

Test setup - Same as clause 2.4

Test procedure - Same as clause 2.4

Applicable rule and limitation at 3m

§15.109 radiated emission limitation

Frequency (MHz)	Measurement Distance (m)	Field Strength (uV/m)	Field Strength (dBuV/m)
30 – 88	3	100	40.0
88 – 216	3	150	43.5
216 – 960	3	200	46.0
Above 960	3	500	54.0

In the emission table above, the tighter limit applies at the band edges.

The emission limits shown in the above table are based on measurements employing a CISPR quasi-peak detector.

Test results - Complied with requirement.

This transceiver could not achieved receiving mode only therefore the measurement was carried out under receiving ready condition of the EUT. This condition is same as standby.

Test equipment used (refer to List of utilized test equipment)

AC01	BA03	CL11	PR03	TR04
------	------	------	------	------

Test Data

Tested Date: 22 October 2008

Temperature: 19 °C
 Humidity: 60 %
 Atmos. Press: 1025 hPa

Operating Mode: Ready to reception (same as standby)

EUT position: X-plane (Worst case)

Connected cable: AC adapter

Measurement distance: 3 m

No.	Frequency [MHz]	Reading [dBuV]	Antenna Factor [dB/m]	Cable Loss [dB]	Preamplifier Gain [dB]	Result [dBuV/m]	Limit [dBuV/m]	Margin [dB]	Antenna Polarization
1	41.800	29.8	12.4	7.4	29.8	19.8	40.0	20.2	Vert.
2	61.780	31.7	6.2	7.8	29.7	16.0	40.0	24.0	Vert.
3	64.440	27.9	6.1	7.8	29.7	12.1	40.0	27.9	Hori.
4	307.840	32.3	13.5	10.5	29.7	26.6	46.0	19.4	Hori.
5	331.962	32.0	14.2	10.9	29.8	27.3	46.0	18.7	Hori.
6	344.033	32.0	14.6	11.2	29.8	28.0	46.0	18.0	Hori.

Calculation method

The Correction Factors and Result are calculated as followings.

$$\text{Correction Factor [dB/m]} = \text{Antenna Factor [dB/m]} + \text{Cable Loss [dB]} - \text{Preamplifier Gain [dB]}$$

$$\text{Result [dBuV/m]} = \text{Reading [dBuV]} + \text{Correction Factor [dB/m]}$$

Sample calculation at 344.033 MHz horizontal result as follow:

$$\text{Result} = \text{Reading} + \text{C.F.} = 32.0 + 4.0 = 28.0 \text{ [dBuV/m]}$$

$$\text{Margin} = \text{Limit} - \text{Result} = 46.0 - 28.0 = 18.0 \text{ [dB]}$$

Graphical express of test result (30MHz-1000MHz)

Antenna polarization: **Horizontal**

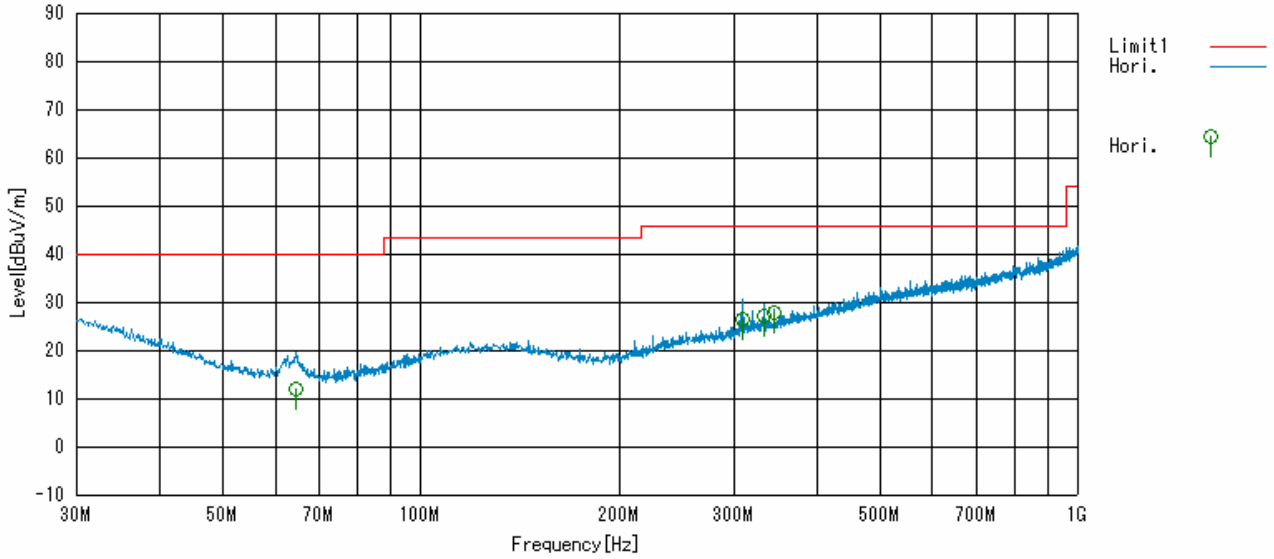

Antenna polarization: **Vertical**

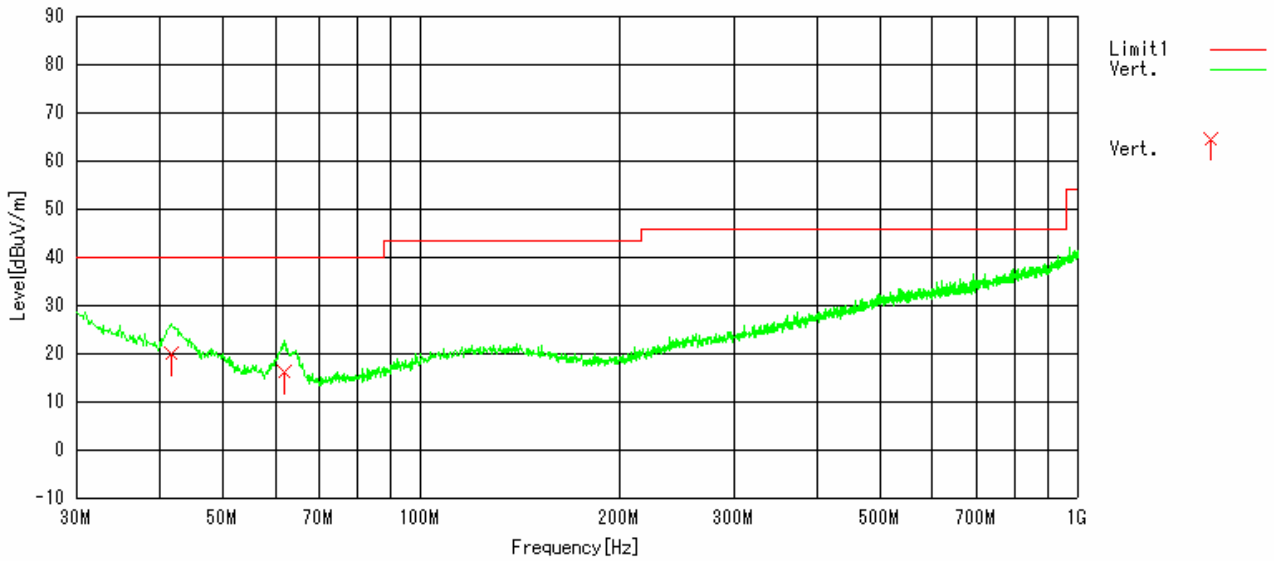

4 List of utilized test equipment/ calibration

RFT ID No.	Kind of Equipment and Precision	Manufacturer	Model No.	Serial Number	Calibration Date	Calibrated until
AC01	Anechoic Chamber (1st test room)	JSE	203397C	-	2008/07/04	2009/07/03
BA03	Biological Antenna	CHASE	CBL6111	1309	2008/05/07	2009/05/06
CL11	Antenna Cable	RFT	-	-	2008/06/11	2009/06/10
LN05	LISN	Kyoritsu	KNW-407	8-1773-3	2008/05/12	2009/05/11
LP01	Loop Antenna	EMCO	6502	3436	2008/06/10	2009/06/09
PL06	Pulse Limiter	PMM	PL-01	0000J10109	2008/01/17	2009/01/15
PR03	Pre. Amplifier	Anritsu	MH648A	M41984	2008/05/12	2009/05/11
TR06	Test Receiver (F/W : 3.93 SP2)	Rohde & Schwarz	ESU26	100002	2008/09/02	2009/09/01
TR04	Test Receiver (F/W : 3.82 SP1)	Rohde & Schwarz	ESCI	100447	2008/09/16	2009/09/15
TC01	Temperature Chamber	ESPEC	SH-641	92000964	2008/05/07	2009/05/06
LP51	Test Loop Antenna	Panasonic	VQ-085C	002861A122	not applicable	not applicable

The measuring equipment, which was utilized in performing the tests documented herein, has been calibrated in accordance with the manufacturer's recommendations for utilizing calibration equipment, which is traceable to recognized national standards.