

TEST REPORT (SAR EVALUATION)

APPLICANT : FUJITSU LIMITED
ADDRESS : 1-1, Kamikodanaka 4-chome, Nakahara-ku, Kawasaki,
211-8588, Japan

PRODUCTS : Cellular Phone
MODEL NO. : F-01A
SERIAL NO. : 359935010014839
FCC ID : VQK-F-01A

TEST STANDARD : FCC/OET Bulletin 65 Supplement C (Edition 01-01)

TESTING LOCATION : Japan Quality Assurance Organization
KITA-KANSAI Testing Center
1-7-7, Ishimaru, Minoh-shi, Osaka 562-0027, Japan

TEST RESULTS : **Passed**

DATE OF TEST : August 7 ~ 13, 2008

This report must not be used by the client to claim product endorsement by NVLAP or NIST or any agency of the U.S. Government.



Yuichi Fukumoto

Manager

Japan Quality Assurance Organization

KITA-KANSAI Testing Center

Testing Dept. EMC Division

1-7-7, Ishimaru, Minoh-shi, Osaka 562-0027, Japan

- The measurement values stated in Test Report was made with traceable to National Institute of Advanced Industrial Science and Technology (AIST) of Japan, National Institute of Information and Communications Technology (NICT) of Japan, and Laboratory for EMF and Microwave Electronics at the Swiss Federal Institute of Technology (ETH) in Zürich, Switzerland.
- The applicable standard, testing condition and testing method which were used for the tests are based on the request of the applicant.
- The test results presented in this report relate only to the offered test sample.
- The contents of this test report cannot be used for the purposes, such as advertisement for consumers.
- This test report shall not be reproduced except in full without the written approval of JQA.

TABLE OF CONTENTS

	Page
Documentation	3
1 Test Regulation	3
2 Test Location	3
3 Recognition of Test Laboratory	3
4 Description of the Equipment Under Test	4
5 Measurement System Diagram	5
6 System Components	6
7 Measurement Process	8
8 Measurement Uncertainties	9
9 Equipment Under Test Modification	10
10 Responsible Party	10
11 Deviation from Standard	10
12 Test Results	11
13 Summary	13
14 Test Arrangement	14
15 Procedures used to Establish Test Signal	16
Appendix A: Test Data	19
Appendix B: Test Instruments	33
Appendix C: Attachments	34

DEFINITIONS FOR ABBREVIATION AND SYMBOLS USED IN THIS TEST REPORT

EUT : Equipment Under Test	EMC : Electromagnetic Compatibility
AE : Associated Equipment	EMI : Electromagnetic Interference
N/A : Not Applicable	EMS : Electromagnetic Susceptibility
N/T : Not Tested	SAR : Specific Absorption Rate

- indicates that the listed condition, standard or equipment is applicable for this report.
 - indicates that the listed condition, standard or equipment is not applicable for this report.

Documentation

1 Test Regulation

Applied Standard : FCC/OET Bulletin 65 Supplement C (Edition 01-01)
Evaluating Compliance with FCC Guidelines for Human Exposure to Radio-
frequency Electromagnetic Fields
*Additional Information for Evaluating Compliance of Mobile and Portable
Devices with FCC Limits for Human Exposure to Radiofrequency Emissions*

Test Procedure : FCC/OET Bulletin 65 Supplement C (Edition 01-01)
IEEE Std.1528–2003
KDB Publication 941225 Rev. 2.0 (October 2007)
KDB Publication 648474 Rev. 1.3 (May 2008)

Exposure Limits : ANSI/IEEE Std. C95.1, 1999 Edition

2 Test Location

KITA-KANSAI Testing Center
7-7, Ishimaru, 1-chome, Minoh-shi, Osaka, 562-0027, Japan
KAMEOKA EMC Branch
9-1, Ozaki, Inukanno, Nishibetsuin-cho, Kameoka-shi, Kyoto, 621-0126, Japan

3 Recognition of Test Laboratory

JQA KITA-KANSAI Testing Center Testing Department EMC Division is accredited under ISO/IEC 17025 by following accreditation bodies and the test facility of Testing Division is registered by the following bodies.

VLAC Code : VLAC-001-2 (Effective through : April 3, 2010)
NVLAP Lab Code : 200191-0 (Effective through : June 30, 2009)
BSMI Recognition No. : SL2-IS-E-6006, SL2-IN-E-6006, SL2-AI-E-6006
(Effective through : September 14, 2010)

VCCI Registration No. : R-008, R-1117, C-006, C-007, C-1674, C-2143, T-1418, T-1419
(Effective through : April 3, 2010)

IC Registration No. : IC 4125-1, IC 6217-1, IC 6217-2 (Effective through : November 16, 2008)

Accredited as conformity assessment body for Japan electrical appliances and material law by METI.
(Effective through : February 22, 2010)

4 Description of the Equipment Under Test

1. Manufacturer : FUJITSU LIMITED
1-1, Kamikodanaka 4-chome, Nakahara-ku, Kawasaki,
211-8588, Japan
2. Products : Cellular Phone
3. Model No. : F-01A
4. Serial No. : 359935010014839
5. Product Type : Prototype
6. Date of Manufacture : --
7. Transmitting Frequency : 826.40 MHz – 846.60 MHz (WCDMA 850 MHz)
1850.20 MHz – 1909.80 MHz (PCS 1900 MHz)
2402 MHz – 2480 MHz (Bluetooth)
8. Battery Option : Lithium-ion Battery Pack CA54310-0006 (870mAh)
9. Power Rating : 3.7VDC
10. EUT Grounding : None
11. Device Category : Portable Device (§2.1093)
12. Exposure Category : General Population/Uncontrolled Exposure
13. FCC Rule Part(s) : 22(H), 24(E), 15.247
14. EUT Authorization : Certification
15. Received Date of EUT : August 7, 2008

5 Measurement System Diagram

These measurements are performed using the DASY4 automated dosimetric assessment system (manufactured by Schmid & Partner Engineering AG (SPEAG) in Zürich, Switzerland). It consists of high precision robotics system, cell controller system, DASY4 measurement server, personal computer with DASY4 software, data acquisition electronic (DAE) circuit, the Electro-optical converter (EOC), near-field probe, and the twin SAM phantom containing the equivalent tissue. The robot is a six-axis industrial robot performing precise movements to position the probe to the location (points) of maximum electromagnetic field (EMF).

The Robot is connected to the cell controller to allow software manipulation of the robot. The DAE is connected to the EOC. The DAE performs the signal amplification, signal multiplexing, A/D conversion, offset measurements, mechanical surface detection, collision detection, etc. The EOC performs the conversion from the optical into digital electric signal of the DAE and transfers data to the DASY4 measurement server.

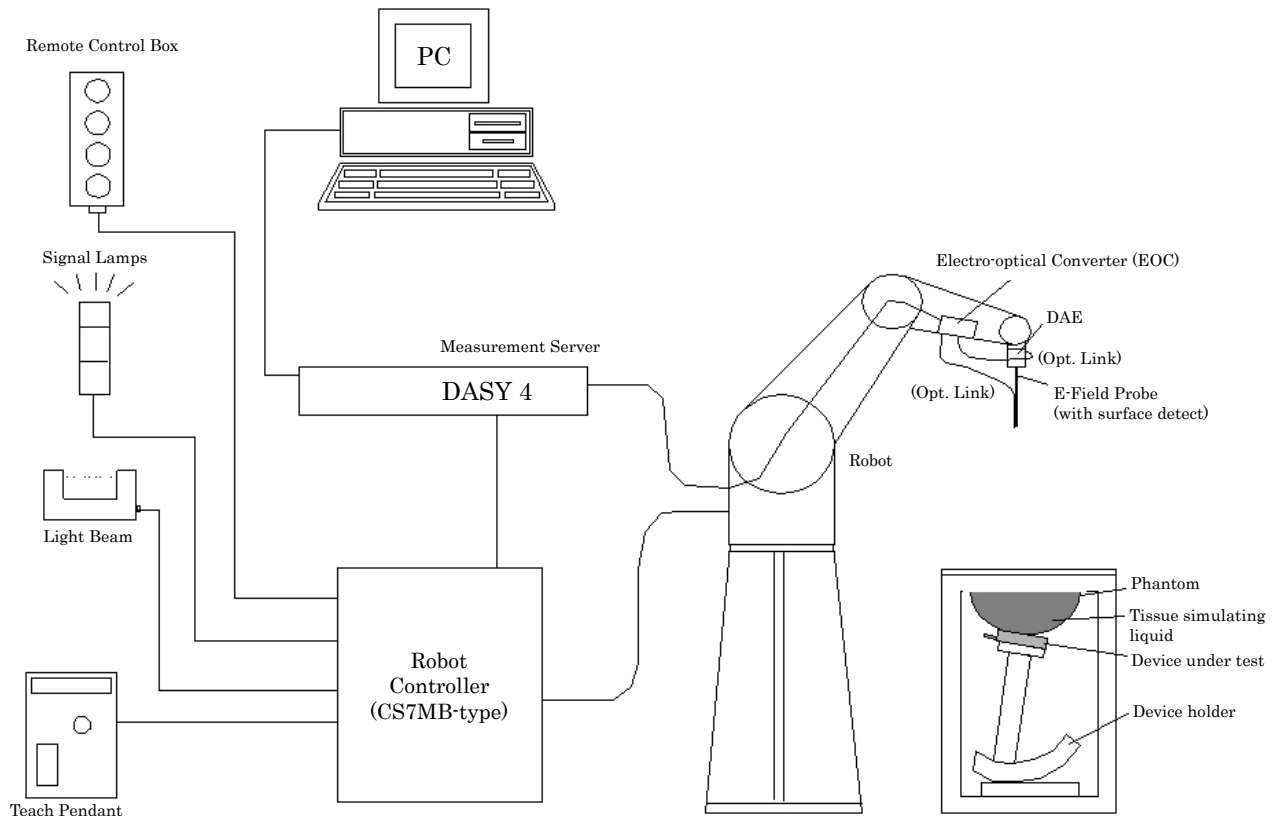

6 System Components

6.1 Probe Specification

Construction : Symmetrical design with triangular core
Built-in optical fiber for surface detection system
Built-in shielding against static changes

Calibration : In air form 10 MHz to 2.5 GHz
In head tissue simulating liquid (HSL) and
muscle tissue simulating liquid
900 MHz (accuracy $\pm 11.0\%$; $k=2$)
1810 MHz (accuracy $\pm 11.0\%$; $k=2$)
1950 MHz (accuracy $\pm 11.0\%$; $k=2$)
2450 MHz (accuracy $\pm 11.8\%$; $k=2$)

Frequency : 10 MHz to 3 GHz (dosimetry);
Linearity: ± 0.2 dB (30 MHz to 3 GHz)

Directivity : ± 0.2 dB in HSL (rotation around probe axis)
 ± 0.4 dB in HSL (rotation normal probe axis)

Dynamic Range : $5 \mu\text{W/g}$ to $>100 \text{ mW/g}$; Linearity: ± 0.2 dB

Surface Detection : ± 0.2 mm repeatability in air and clear liquids over diffuse reflecting surfaces

Dimensions : Overall length 330 mm
Tip length 16 mm
Body diameter 12 mm
Tip diameter 6.8 mm
Distance from probe tip to dipole centers 2.7 mm



6.2 Twin SAM Phantom

The shell corresponds to the specifications of the Specific Anthropomorphic Mannequin (SAM) phantom defined in IEEE 1528-2003, CENELEC 50361 and IEC 62209-1. It enables the dosimetric evaluation of left and right head phone usage as well as body mounted usage at the flat phantom region. A cover prevents evaporation of the liquid. Reference markings on the phantom allow the complete setup of all predefined phantom positions and measurement grids by manually teaching three points with the robot.



Shell Thickness : 2 ± 0.2 mm
 Filling Volume : Volume Approx. 25 liters
 Dimensions : $810 \times 1000 \times 500$ mm (H \times L \times W)

6.3 Mounting Device for Transmitters

The Mounting Device enables the rotation of the mounted transmitter in spherical coordinates, whereby the rotation point is the ear opening. The devices can be easily and accurately positioned according to IEC, IEEE, CENELEC, FCC or other specifications. The device holder can be locked at different phantom locations (left head, right head, flat phantom).



6.4 Typical Composition of Ingredients for Liquid Tissue

Ingredients (% by weight)	Frequency (MHz)					
	835		1900		2450	
	Head	Body	Head	Body	Head	Body
Water	41.45	52.40	54.90	40.40	62.70	73.20
Salt (NaCl)	1.45	1.40	0.18	0.50	0.50	0.04
Sugar	56.00	45.00	0.00	58.00	0.00	0.00
HEC	1.00	1.00	0.00	1.00	0.00	0.00
Bactericide	0.10	0.10	0.00	0.10	0.00	0.00
Triton X-100	0.00	0.00	0.00	0.00	36.80	0.00
DGBE	0.00	0.00	44.92	0.00	0.00	26.70

Salt : 99+% Pure Sodium Chloride Sugar : 98+% Pure Sucrose
 Water : De-ionized, 16 MΩ⁺ resistivity HEC : Hydroxyethyl Cellulose
 DGBE : 99+% Di (ethylene glycol) butyl ether, [2-(2-butoxyethoxy)ethanol]
 Triton X-100 (ultra pure) : Polyethylene glycol mono [4-(1,1,3,3-tetramethylbutyl)phenyl]ether

The composition of ingredients is according to FCC/OET Bulletin 65 Supplement C.

7 Measurement Process

Area Scan for Maximum Search :

The SAR distribution at the exposed side of the head was measured at a distance of 3.9 mm from the inner surface of the shell. The area covered the entire dimension of the head and the horizontal grid spacing was 15 mm × 15 mm. The evaluation on the measured area scan gives the interpolated maximum (hot spot) of the measured area.

Cube Scan for Spatial Peak SAR Evaluation :

The 1g and 10g peak evaluations were available for the predefined cube 5×5×7 scans. The grid spacing was 8 mm × 8 mm × 5 mm. The first procedure is an extrapolation to get the points between the lowest measured plane and the surface. The next step uses 3D interpolation to get all points within the measured volume in a 1mm grid (35000 points). In the last step, a 1g cube is placed numerically into the volume and its averaged SAR is calculated. This cube is moved around until the highest averaged SAR is found. This last procedure is repeated for a 10g cube. If the highest SAR is found at the edge of the measured volume, the system will issue a warning: higher SAR values might be found outside of the measured volume. In that case the cube measurement can be repeated, using the new interpolated maximum as the center.

Extrapolation :

The extrapolation is based on a least square algorithm. Through the points in the first 3 cm in all z-axis, polynomials of order four are calculated. This polynomial is then used to evaluate the points between the surface and the probe tip. The points, calculated from the surface, have a distance of 1 mm from one another.

Interpolation :

The maximum interpolated value is searched with a straightforward algorithm. Around this maximum the SAR values averaged over the spatial volumes (1g or 10g) are computed by the 3D spline algorithm. The 3D spline is composed of three one-dimensional splines with the "Not a knot" -condition (x, y and z -directions). The volume is integrated with the trapezoidal algorithm.

8 Measurement Uncertainties

Uncertainty Component	Tol. (± %)	Prob. Dist.	Div.	c_i (1g)	c_i (10g)	Std. Unc. (± %)		ν_i
						1g	10g	
Measurement System								
Probe calibration	5.9	N	1	1	1	5.9	5.9	∞
Axial isotropy	4.7	R	$\sqrt{3}$	0.7	0.7	1.9	1.9	∞
Hemispherical isotropy	9.6	R	$\sqrt{3}$	0.7	0.7	3.9	3.9	∞
Boundary effect	1.0	R	$\sqrt{3}$	1	1	0.6	0.6	∞
Linearity	4.7	R	$\sqrt{3}$	1	1	2.7	2.7	∞
System detection limits	1.0	R	$\sqrt{3}$	1	1	0.6	0.6	∞
Readout electronics	0.4	N	1	1	1	0.4	0.4	∞
Response time	0.0	R	$\sqrt{3}$	1	1	0.0	0.0	∞
Integration time	2.6	R	$\sqrt{3}$	1	1	1.5	1.5	∞
RF ambient conditions – noise	3.0	R	$\sqrt{3}$	1	1	1.7	1.7	∞
RF ambient conditions – reflections	3.0	R	$\sqrt{3}$	1	1	1.7	1.7	∞
Probe positioner mechanical tolerance	0.4	R	$\sqrt{3}$	1	1	0.2	0.2	∞
Probe positioning with respect to phantom shell	2.9	R	$\sqrt{3}$	1	1	1.7	1.7	∞
Extrapolation, interpolation and integration algorithms for max. SAR evaluation	1.0	R	$\sqrt{3}$	1	1	0.6	0.6	∞
Test Sample Related								
Test sample positioning	3.4	N	1	1	1	3.4	3.4	23
Device holder uncertainty	2.9	N	1	1	1	2.9	2.9	5
Output power variation – SAR drift measurement	5.0	R	$\sqrt{3}$	1	1	2.9	2.9	∞
Phantom and Tissue Parameters								
Phantom uncertainty	4.0	R	$\sqrt{3}$	1	1	2.3	2.3	∞
Liquid conductivity – deviation from target	5.0	R	$\sqrt{3}$	0.64	0.43	1.8	1.2	∞
Liquid Conductivity – measurement uncertainty	3.2	N	1	0.64	0.43	2.0	1.4	5
Liquid Permittivity – deviation from target	5.0	R	$\sqrt{3}$	0.6	0.49	1.7	1.4	∞
Liquid Permittivity – measurement uncertainty	3.0	N	1	0.6	0.49	1.8	1.5	5
Combined Standard Uncertainty			RSS			11.0	10.7	
Expanded Uncertainty (95% Confidence Interval)			k=2			22.0	21.4	
NOTES								
1. Tol. : tolerance in influence quantity								
2. Prob. Dist. : probability distributions								
3. N, R : normal, rectangular								
4. Div. : divisor used to obtain standard uncertainty								
5. c_i : sensitivity coefficient								
6. Std. Unc. : standard uncertainty								
7. Measurement uncertainties are according to IEEE Std. 1528 and IEC 62209-1.								

9 Equipment Under Test Modification

- No modifications were conducted by JQA to achieve compliance to the limitations.
 - To achieve compliance to the limitations, the following changes were made by JQA during the compliance test.

The modifications will be implemented in all production models of this equipment.

Applicant : Not Applicable
Date : Not Applicable
Typed Name : Not Applicable
Position : Not Applicable

Signatory : Not Applicable

10 Responsible PartyResponsible Party of Test Item (Product)

Responsible Party :	
Contact Person :	_____
	Signatory

11 Deviation from Standard

- No deviations from the standard described in clause 1.
 - The following deviations were employed from the standard described in clause 1.
-

12 Test Results**12.1 WCDMA 850 MHz (Band-V) Band****12.1.1 SAR Measurement for Head Configuration**

Maximum SAR (1g) 0.250 mW/g at 846.60 MHz

Phantom Position - Left Head - Right Head

Device Position - Cheek/Touch - Ear/Tilt

Antenna Position - In - Out - Fixed

Modulation Type WCDMA

Remarks : _____

12.1.2 SAR Measurement for Body-worn Configuration

Maximum SAR (1g) 0.329 mW/g at 826.40 MHz

Body-worn Carry Accessories - Supplied - Not supplied

Separation Distance between Device and Phantom 1.5 cm

Modulation Type WCDMA

Remarks : _____

12.2 PCS 1900 MHz Band**12.2.1 SAR Measurement for Head Configuration**Maximum SAR (1g) 0.362 mW/g at 1909.80 MHzPhantom Position - Left Head - Right HeadDevice Position - Cheek/Touch - Ear/TiltAntenna Position - In - Out - FixedModulation Type GSM

Remarks : _____

12.2.2 SAR Measurement for Body-worn ConfigurationMaximum SAR (1g) 0.339 mW/g at 1850.20 MHzBody-worn Carry Accessories - Supplied - Not suppliedSeparation Distance between Device and Phantom 1.5 cmModulation Type GSM

Remarks : _____

13 Summary**General Remarks :**

The EUT was tested according to the requirements of the following standard.

FCC/OET Bulletin 65 Supplement C (Edition 01-01)

The test configuration is shown in clause 14 to 15.

The conclusion for the test items of which are required by the applied regulation is indicated under the test results.

Determining compliance with the limits in this report was based on the results of the compliance measurement, not taking into account measurement instrumentation uncertainty.

Test Results :

The "as received" sample:

- fulfill the test requirements of the regulation mentioned on clause 1.
- doesn't fulfill the test requirements of the regulation mentioned on clause 1.

Reviewed by:



Shigeru Kinoshita
Deputy Manager
Testing Dept. EMC Div.
JQA KITA-KANSAI Testing Center

Tested by:



Yasuhisa Sakai
Assistant Manager
Testing Dept. EMC Div.
JQA KITA-KANSAI Testing Center

14 Test Arrangement

14.1 Cheek-Touch Position

1. Position the device with the vertical center line of the body of the device and the horizontal line crossing the center of the ear piece in a plane parallel to the sagittal plane of the phantom.
2. While maintaining the device in this plane, align the vertical center line with the reference plane containing the three ear and mouth reference points (M, RE and LE) and align the center of the ear piece with the line RE-LE.
3. Translate the mobile phone box towards the phantom with the ear piece aligned with the line RE-LE until the phone touches the ear.
4. While maintaining the device in the reference plane and maintaining the phone contact with the ear, move the bottom of the box until any point on the front side is in contact with the cheek of the phantom or until contact with the ear is lost.

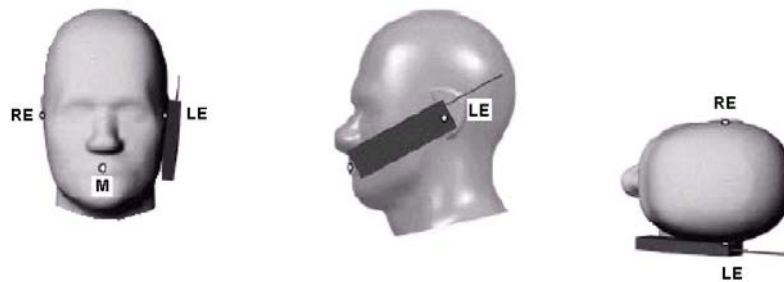
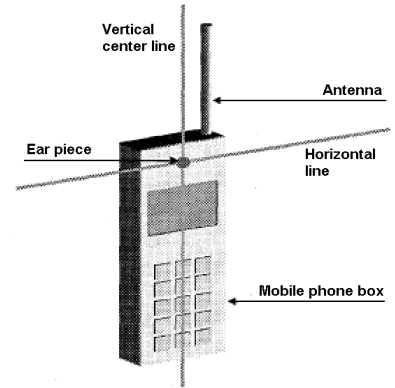

14.2 Ear-Tilt Position

1. Position the device in the “Cheek/Touch Position”.
2. While maintaining the device in the reference plane and pivoting against the ear, move it outward away from the mouth by an angle of 15 degrees or until contact with the ear is lost.

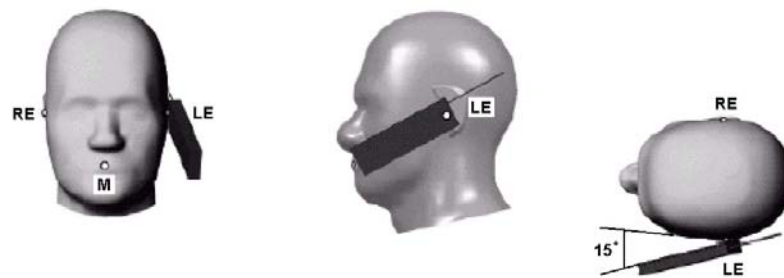

14.3 Body-worn Configuration

Body-worn operating configurations should be tested with the belt-clips and holsters attached to the device and positioned against a flat phantom in normal use configurations. Devices with a headset output should be tested with a headset connected to the device. Both the physical spacing to the body of the user as dictated by the accessory and the materials used in an accessory affect the SAR produced by the transmitting device. For purpose of determining test requirements, accessories may be divided into two categories: those that do not contain metallic components and those that do.

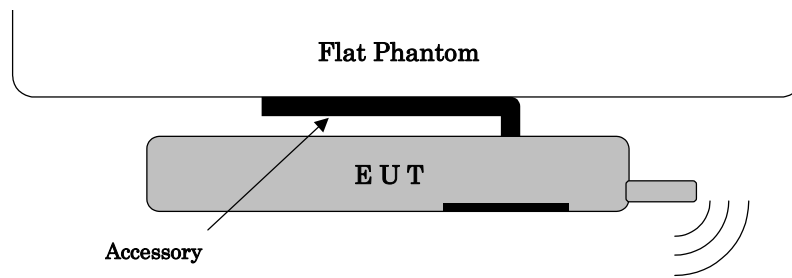

When multiple accessories that do not contain metallic components are supplied with the device, the device may be tested with only the accessory that dictates the closest spacing to the body. When multiple accessories that contain metallic components are supplied with the device, the device must be tested with each accessory that contains a unique metallic component. If multiple accessories share an identical metallic component (e.g., the same metallic belt-clip used with different holsters with no other metallic components), only the accessory that dictates the closest spacing to the body must be tested.

Body-worn accessories may not always be supplied or available as options for some devices that are intended to be authorized for body-worn use. A separation distance of 1.5 cm between the back of the device and a flat phantom is recommended for testing body-worn SAR compliance under such circumstances. Other separation distances may be used, but they should not exceed 2.5 cm. In these cases, the device may use body-worn accessories that provide a separation distance greater than that tested for the device provided however that the accessory contains no metallic components.

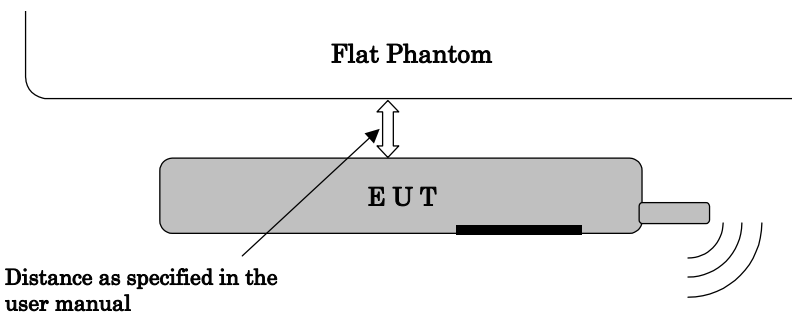

Lap-held device (e.g. laptop computer)
 SAR is tested for a lap-held position with the bottom of the computer in direct contact against a flat phantom.

15 Procedures used to Establish Test Signal

The following procedures had been used to prepare the EUT for the SAR test.

15.1 WCDMA 850 MHz (Band-V) Band

To setup the desire channel frequency and the maximum output power, a Radio Communication Tester “Anritsu, MT8820B” was used to program the EUT.

System Configuration : W-CDMA (MX882000C 10.23 #002)

WCDMA mode

Test Loop Mode : Mode 1
 Channel Coding : 12.2 kbps RMC
 TPC Bit Pattern : All 1

Conducted power measurements in 12.2 kbps RMC:

Channel	Frequency (MHz)	Conducted Power (dBm)
4132	826.40	23.60
4182	836.40	23.36
4233	846.60	23.27

Conducted power measurements:

Channel Coding (Data Rate)	Conducted Power (dBm)		
	4132 ch (826.40 MHz)	4182 ch (836.40 MHz)	4233 ch (846.60 MHz)
12.2 kbps RMC	23.60	23.36	23.27
64 kbps RMC	23.60	23.36	23.27
144 kbps RMC	23.59	23.35	23.27
384 kbps RMC	23.59	23.34	23.25
12.2 kbps Voice AMR	23.59	23.36	23.27

SAR for other configuration are not required when the maximum average output power for each of these configurations is less than ¼ dB higher than those measured in 12.2 kbps RMC.

HSDPA mode

Test Loop Mode : Mode 1
Channel Coding : FRC with H-Set 1 (QPSK)
HS-DPCCH Sub-test : Sub-test 1 (Beta C = 2, Beta D = 15)
TPC Bit Pattern : All 1

Conducted power measurements for HSDPA mode:

Sub-Test	Conducted Power (dBm)		
	4132 ch (826.40 MHz)	4182 ch (836.40 MHz)	4233 ch (846.60 MHz)
1	22.90	22.52	22.38
2	22.96	22.54	22.44
3	22.12	21.62	21.36
4	21.05	20.84	20.55

Body SAR for HSDPA is not required when the maximum average output with HSDPA active is less than $\frac{1}{4}$ dB higher than that measured without HSDPA using 12.2 kbps RMC and the maximum SAR for 12.2 kbps RMC is $\leq 75\%$ of the SAR limit.

Maximum conducted power was measured by replacing the antenna with an adapter for conductive measurements, before and after the SAR measurements was done.

15.2 PCS 1900 MHz Band

To setup the desire channel frequency and the maximum output power, a Radio Communication Tester "Rohde & Schwarz, CMU-200" was used to program the EUT.

SM Mobile Station : GSM 1900

GSM mode

Network Support : GSM only

Main Service : Circuit Switched

Power Setting : PCL 0 (30 dBm)

GPRS mode

Network Support : GSM+GPRS (Power Setting 30 dBm)

Main Service : Packet Data

Service Selection : Test Mode A

Slot Configuration : GPRS Class 8 (4 down / 1 up / 5 sum)

Coding Scheme : CS1 (GMSK)

Conducted power measurements:

Channel	Frequency (MHz)	Conducted Power (dBm)	
		GSM	GPRS
512	1850.20	29.50	29.52
661	1880.00	29.29	29.31
810	1909.80	29.26	29.28

Maximum conducted power was measured by replacing the antenna with an adapter for conductive measurements, before and after the SAR measurements was done.

For the Bluetooth operation, the client supplied a special driving program to program the EUT to continually transmit the specified maximum power.

Modulation type : Frequency Hopping Spread Spectrum (FHSS)

Transmitting Frequency : 2402 MHz (0 ch) – 2480 MHz (78 ch)

RF Output Power : Max. 2.5 mW (Class 2)

The output of Bluetooth transmitter is $\leq P_{\text{ref}}$ and its antenna is >2.5 cm from other antennas, so the stand-alone SAR evaluation for Bluetooth is not required. ($P_{\text{ref}} = \frac{1}{2} \cdot 60 / f_{\text{(GHz)}} [\text{mW}]$)

Appendix A: Test Data

A.1 Tissue Verification

The tissue dielectric parameters of the tissue medium at the middle of a device transmission band should be within $\pm 5\%$ of the parameters specified at that target frequency. It is verified by using the dielectric probe and the network analyzer.

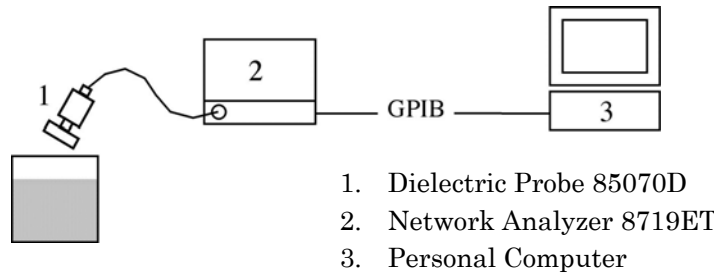

Tissue Verification Results :

Liquid		Parameters	Target	Measured	Deviation [%]	Limit [%]
Frequency	Temp. [°C]					
Ambient Conditions : 23°C 67%		Date : August 12, 2008				
Head 900 MHz	23.0	Permittivity	41.5	42.30	+1.93	± 5
		Conductivity	0.97	0.941	-2.99	± 5
Head 835 MHz	23.0	Permittivity	41.5	42.74	+2.99	± 5
		Conductivity	0.90	0.888	-1.33	± 5
Ambient Conditions : 22°C 73%		Date : August 13, 2008				
Body 900 MHz	22.0	Permittivity	55.0	54.23	-1.40	± 5
		Conductivity	1.05	1.015	-3.33	± 5
Body 835 MHz	22.0	Permittivity	55.2	54.74	-0.83	± 5
		Conductivity	0.97	0.950	-2.06	± 5
Ambient Conditions : 22°C 72%		Date : August 7, 2008				
Head 1800 MHz	22.0	Permittivity	40.0	39.83	-0.43	± 5
		Conductivity	1.40	1.360	-2.86	± 5
Head 1900 MHz	22.0	Permittivity	40.0	39.63	-0.93	± 5
		Conductivity	1.40	1.428	+2.00	± 5
Ambient Conditions : 22°C 70%		Date : August 11, 2008				
Body 1800 MHz	22.0	Permittivity	53.3	52.64	-1.24	± 5
		Conductivity	1.52	1.493	-1.78	± 5
Body 1900 MHz	22.0	Permittivity	53.3	52.47	-1.56	± 5
		Conductivity	1.52	1.567	+3.09	± 5

A.2 System Validation

The power meter PM1 (including Attenuator) measures the forward power at the location of the validation dipole connector. The signal generator is adjusted for 250 mW at the dipole connector and the power meter PM2 is read at that level. After connecting the cable to the dipole, the signal generator is readjusted for the same reading at power meter PM2.

The dipole antenna is matched to be used near flat phantom filled with tissue simulating solution. A specific distance holder is used in the positioning of the antenna to ensure correct spacing between the phantom and the dipole.

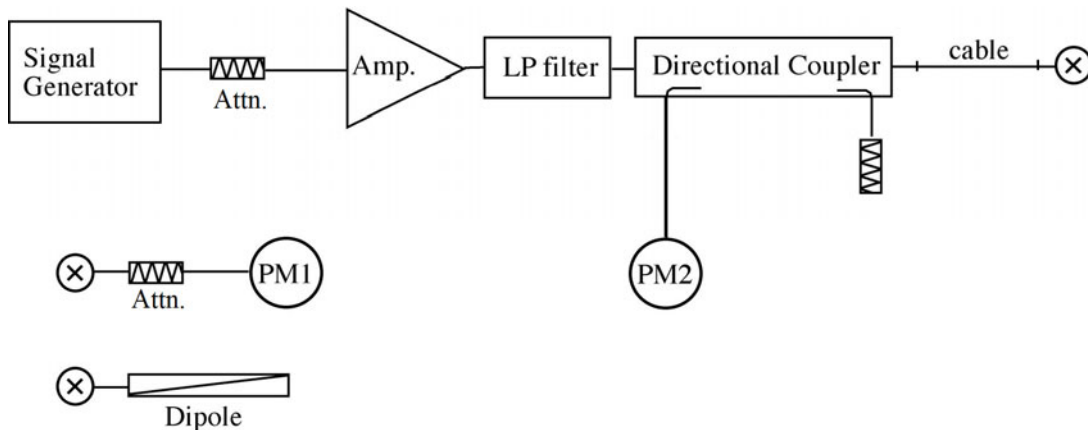

System Validation Results :

System Validation Dipole : D900V2, S/N: 153						
Ambient Conditions : 23°C 67%		Depth of Liquid : 15.0 cm		Date : August 12, 2008		
Liquid		Measured SAR (mW/g)		Target	Deviation [%]	Limit [%]
Medium	Temp. [°C]	1g SAR	Normalized to 1 W			
Head 900 MHz	23.0	2.56	10.24	10.9	-6.06	± 10
Ambient Conditions : 22°C 73%		Depth of Liquid : 15.0 cm		Date : August 13, 2008		
Body 900 MHz	22.0	2.81	11.24	11.1	+1.26	± 10
System Validation Dipole : D1800V2, S/N: 2d038						
Ambient Conditions : 22°C 72%		Depth of Liquid : 15.0 cm		Date : August 7, 2008		
Head 1800 MHz	22.0	9.26	37.04	37.7	-1.75	± 10
Ambient Conditions : 22°C 70%		Depth of Liquid : 15.0 cm		Date : August 11, 2008		
Body 1800 MHz	22.0	9.69	38.76	38.9	-0.36	± 10
NOTES :						
1. The results were normalized to 1 W forward power.						
2. The target SAR values of SPEAG validation dipoles are given in the calibration data.						
3. Please refer to attachment for the result presentation in plot format.						

A.3 SAR Measurement Data

A.3.1 WCDMA 850 MHz (Band-V) Band

A.3.1.1 Left Side – open style

CONFIDENTIAL							
Cheek/Touch Position				Ear/Tilt Position			
WCDMA Band-V (Duty Cycle: 100 %, Crest Factor: 1)						Date : August 12, 2008	
Test Position	Frequency		Tx Power [dBm]	Power Drift [dB]	Limit [mW/g]	SAR (1g) [mW/g]	Tissue Temp. [°C]
	Channel	MHz					
Cheek/Touch	4132	826.40	--	--	1.6	**	--
	4182	836.40	23.36	0.026		0.227	23.0
	4233	846.60	--	--		**	--
Ear/Tilt	4132	826.40	--	--	1.6	**	--
	4182	836.40	23.36	-0.014		0.074	23.0
	4233	846.60	--	--		**	--
NOTES : 1. Depth of Liquid : 15.0 cm 2. Transmitter power was measured at the antenna-conducted terminal. 3. The SAR result marked at ** is optional, because the SAR measured at the middle channel for that configuration is at least 3.0 dB lower than the SAR limit. 4. Please refer to attachment for the result presentation in plot format.							

A.3.1.2 Right Side – open style

CONFIDENTIAL							
Cheek/Touch Position				Ear/Tilt Position			

WCDMA Band-V (Duty Cycle: 100 %, Crest Factor: 1)					Date : August 12, 2008		
Test Position	Frequency		Tx Power [dBm]	Power Drift [dB]	Limit [mW/g]	SAR (1g) [mW/g]	Tissue Temp. [°C]
	Channel	MHz					
Cheek/Touch	4132	826.40	23.60	-0.055	1.6	0.217	23.0
	4182	836.40	23.36	0.003		0.235	23.0
	4233	846.60	23.27	-0.052		0.250	23.0
Ear/Tilt	4132	826.40	--	--	1.6	**	--
	4182	836.40	23.36	0.009		0.079	23.0
	4233	846.60	--	--		**	--

NOTES :

1. Depth of Liquid : 15.0 cm
2. Transmitter power was measured at the antenna-conducted terminal.
3. The SAR result marked at ** is optional, because the SAR measured at the middle channel for that configuration is at least 3.0 dB lower than the SAR limit.
4. Please refer to attachment for the result presentation in plot format.

A.3.1.3 Left Side – swivel style

<i>CONFIDENTIAL</i>							
Cheek/Touch Position				Ear/Tilt Position			
WCDMA Band-V (Duty Cycle: 100 %, Crest Factor: 1)						Date : August 12, 2008	
Test Position	Frequency		Tx Power [dBm]	Power Drift [dB]	Limit [mW/g]	SAR (1g) [mW/g]	Tissue Temp. [°C]
	Channel	MHz					
Cheek/Touch	4132	826.40	--	--	1.6	**	--
	4182	836.40	23.36	-0.021		0.186	23.0
	4233	846.60	--	--		**	--
Ear/Tilt	4132	826.40	--	--	1.6	**	--
	4182	836.40	23.36	0.003		0.115	23.0
	4233	846.60	--	--		**	--
NOTES : 1. Depth of Liquid : 15.0 cm 2. Transmitter power was measured at the antenna-conducted terminal. 3. The SAR result marked at ** is optional, because the SAR measured at the middle channel for that configuration is at least 3.0 dB lower than the SAR limit. 4. Please refer to attachment for the result presentation in plot format.							

A.3.1.4 Right Side – swivel style

CONFIDENTIAL							
Cheek/Touch Position				Ear/Tilt Position			
WCDMA Band-V (Duty Cycle: 100 %, Crest Factor: 1)					Date : August 12, 2008		
Test Position	Frequency		Tx Power [dBm]	Power Drift [dB]	Limit [mW/g]	SAR (1g) [mW/g]	Tissue Temp. [°C]
	Channel	MHz					
Cheek/Touch	4132	826.40	--	--	1.6	**	--
	4182	836.40	23.36	-0.005		0.215	23.0
	4233	846.60	--	--		**	--
Ear/Tilt	4132	826.40	--	--	1.6	**	--
	4182	836.40	23.36	-0.012		0.119	23.0
	4233	846.60	--	--		**	--
NOTES : 1. Depth of Liquid : 15.0 cm 2. Transmitter power was measured at the antenna-conducted terminal. 3. The SAR result marked at ** is optional, because the SAR measured at the middle channel for that configuration is at least 3.0 dB lower than the SAR limit. 4. Please refer to attachment for the result presentation in plot format.							

A.3.1.5 Body-worn Position – close style

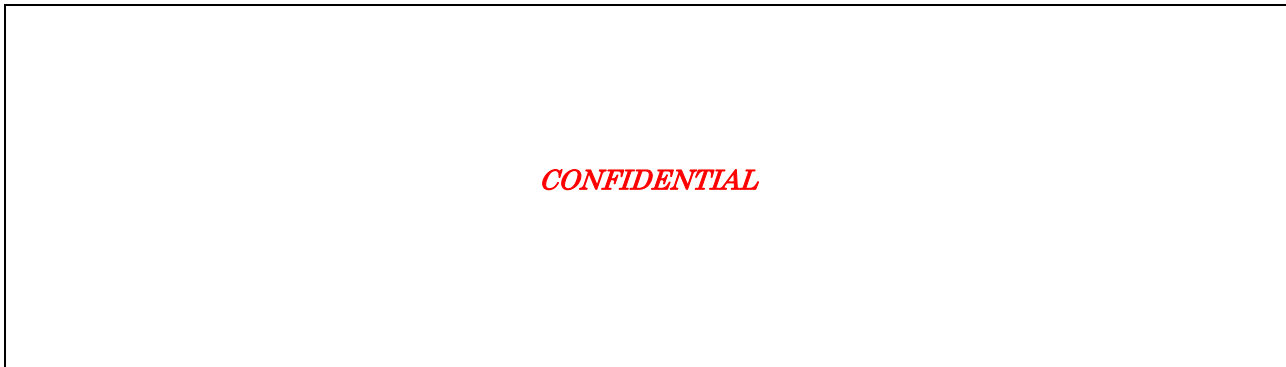

CONFIDENTIAL

WCDMA Band-V (Duty Cycle: 100 %, Crest Factor: 1)					Date : August 13, 2008		
Separation Distance	Frequency		Tx Power [dBm]	Power Drift [dB]	Limit [mW/g]	SAR (1g) [mW/g]	Tissue Temp. [°C]
	Channel	MHz					
1.5 cm	4132	826.40	23.60	-0.053	1.6	0.329	22.0
	4182	836.40	23.36	-0.028		0.312	22.0
	4233	846.60	23.27	-0.003		0.309	22.0

- NOTES :
1. Depth of Liquid : 15.0 cm
 2. Transmitter power was measured at the antenna-conducted terminal.
 3. The earphone wire connected to the EUT to simulate hand-free operation in a body-worn configuration.
 4. Please refer to attachment for the result presentation in plot format.

A.3.1.6 Body-worn Position – viewer style

CONFIDENTIAL

WCDMA Band-V (Duty Cycle: 100 %, Crest Factor: 1)						Date : August 13, 2008	
Separation Distance	Frequency		Tx Power [dBm]	Power Drift [dB]	Limit [mW/g]	SAR (1g) [mW/g]	Tissue Temp. [°C]
	Channel	MHz					
1.5 cm	4132	826.40	--	--	1.6	**	--
	4182	836.40	23.36	-0.055		0.270	22.0
	4233	846.60	--	--		**	--

NOTES :

1. Depth of Liquid : 15.0 cm
2. Transmitter power was measured at the antenna-conducted terminal.
3. The earphone wire connected to the EUT to simulate hand-free operation in a body-worn configuration.
4. The SAR result marked at ** is optional, because the SAR measured at the middle channel for that configuration is at least 3.0 dB lower than the SAR limit.
5. Please refer to attachment for the result presentation in plot format.

A.3.2 PCS 1900 MHz Band

A.3.2.1 Left Side – open style

<i>CONFIDENTIAL</i>	
Cheek/Touch Position	Ear/Tilt Position

GSM 1900 (Duty Cycle: 12.5 %, Crest Factor: 8)				Date : August 7, 2008			
Test Position	Frequency		Tx Power [dBm]	Power Drift [dB]	Limit [mW/g]	SAR (1g) [mW/g]	Tissue Temp. [°C]
	Channel	MHz					
Cheek/Touch	0512	1850.20	29.50	-0.025	1.6	0.281	22.0
	0661	1880.00	29.29	-0.069		0.310	22.0
	0810	1909.80	29.26	-0.048		0.362	22.0
Ear/Tilt	0512	1850.20	--	--	1.6	**	--
	0661	1880.00	29.29	-0.087		0.161	22.0
	0810	1909.80	--	--		**	--

NOTES :

1. Depth of Liquid : 15.0 cm
2. Transmitter power was measured at the antenna-conducted terminal.
3. The SAR result marked at ** is optional, because the SAR measured at the middle channel for that configuration is at least 3.0 dB lower than the SAR limit.
4. Please refer to attachment for the result presentation in plot format.

A.3.2.2 Right Side – open style

<i>CONFIDENTIAL</i>							
Cheek/Touch Position				Ear/Tilt Position			
GSM 1900 (Duty Cycle: 12.5 %, Crest Factor: 8)						Date : August 7, 2008	
Test Position	Frequency		Tx Power [dBm]	Power Drift [dB]	Limit [mW/g]	SAR (1g) [mW/g]	Tissue Temp. [°C]
	Channel	MHz					
Cheek/Touch	0512	1850.20	--	--	1.6	**	--
	0661	1880.00	29.29	-0.049		0.193	22.0
	0810	1909.80	--	--		**	--
Ear/Tilt	0512	1850.20	--	--	1.6	**	--
	0661	1880.00	29.29	-0.005		0.152	22.0
	0810	1909.80	--	--		**	--
NOTES : 1. Depth of Liquid : 15.0 cm 2. Transmitter power was measured at the antenna-conducted terminal. 3. The SAR result marked at ** is optional, because the SAR measured at the middle channel for that configuration is at least 3.0 dB lower than the SAR limit. 4. Please refer to attachment for the result presentation in plot format.							

A.3.2.3 Left Side – swivel style

CONFIDENTIAL							
Cheek/Touch Position				Ear/Tilt Position			
GSM 1900 (Duty Cycle: 12.5 %, Crest Factor: 8)						Date : August 7, 2008	
Test Position	Frequency		Tx Power [dBm]	Power Drift [dB]	Limit [mW/g]	SAR (1g) [mW/g]	Tissue Temp. [°C]
	Channel	MHz					
Cheek/Touch	0512	1850.20	--	--	1.6	**	--
	0661	1880.00	29.29	-0.024		0.299	22.0
	0810	1909.80	--	--		**	--
Ear/Tilt	0512	1850.20	--	--	1.6	**	--
	0661	1880.00	29.29	-0.050		0.135	22.0
	0810	1909.80	--	--		**	--
NOTES : 1. Depth of Liquid : 15.0 cm 2. Transmitter power was measured at the antenna-conducted terminal. 3. The SAR result marked at ** is optional, because the SAR measured at the middle channel for that configuration is at least 3.0 dB lower than the SAR limit. 4. Please refer to attachment for the result presentation in plot format.							

A.3.2.4 Right Side – swivel style

CONFIDENTIAL							
Cheek/Touch Position				Ear/Tilt Position			

GSM 1900 (Duty Cycle: 12.5 %, Crest Factor: 8)					Date : August 7, 2008		
Test Position	Frequency		Tx Power [dBm]	Power Drift [dB]	Limit [mW/g]	SAR (1g) [mW/g]	Tissue Temp. [°C]
	Channel	MHz					
Cheek/Touch	0512	1850.20	--	--	1.6	**	--
	0661	1880.00	29.29	-0.028		0.286	22.0
	0810	1909.80	--	--		**	--
Ear/Tilt	0512	1850.20	--	--	1.6	**	--
	0661	1880.00	29.29	-0.006		0.188	22.0
	0810	1909.80	--	--		**	--

- NOTES :
1. Depth of Liquid : 15.0 cm
 2. Transmitter power was measured at the antenna-conducted terminal.
 3. The SAR result marked at ** is optional, because the SAR measured at the middle channel for that configuration is at least 3.0 dB lower than the SAR limit.
 4. Please refer to attachment for the result presentation in plot format.

A.3.2.5 Body-worn Position – close style

CONFIDENTIAL

GSM 1900 (Duty Cycle: 12.5 %, Crest Factor: 8)							Date : August 11, 2008	
Separation Distance	Frequency		Tx Power [dBm]	Power Drift [dB]	Limit [mW/g]	SAR (1g) [mW/g]	Tissue Temp. [°C]	
	Channel	MHz						
1.5 cm	0512	1850.20	29.50	-0.011	1.6	0.339	22.0	
	0661	1880.00	29.29	-0.081		0.322	22.0	
	0810	1909.80	29.26	-0.046		0.301	22.0	
GSM 1900 GSM+GPRS (Duty Cycle: 12.5 %, Crest Factor: 8)								
1.5 cm	0512	1850.20	--	--	1.6	**	--	
	0661	1880.00	29.31	-0.014		0.302	22.0	
	0810	1909.80	--	--		**	--	

NOTES :

1. Depth of Liquid : 15.0 cm
2. Transmitter power was measured at the antenna-conducted terminal.
3. The SAR result marked at ** is optional, because the SAR measured at the middle channel for that configuration is at least 3.0 dB lower than the SAR limit.
4. The earphone wire connected to the EUT to simulate hand-free operation in a body-worn configuration.
5. Please refer to attachment for the result presentation in plot format.

A.3.2.6 Body-worn Position – viewer style

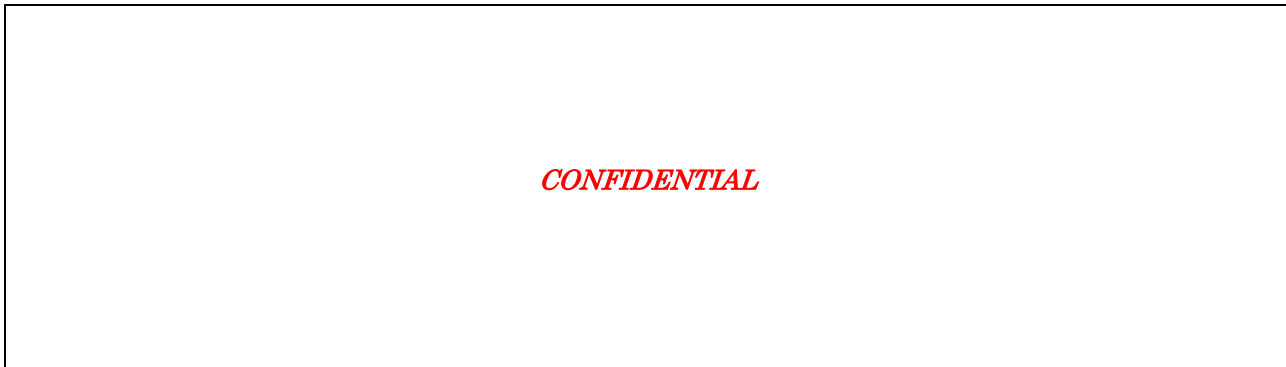

GSM 1900 (Duty Cycle: 12.5 %, Crest Factor: 8) Date : August 11, 2008

Separation Distance	Frequency		Tx Power [dBm]	Power Drift [dB]	Limit [mW/g]	SAR (1g) [mW/g]	Tissue Temp. [°C]
	Channel	MHz					
1.5 cm	0512	1850.20	--	--	1.6	**	--
	0661	1880.00	29.29	-0.093		0.278	22.0
	0810	1909.80	--	--		**	--

GSM 1900 GSM+GPRS (Duty Cycle: 12.5 %, Crest Factor: 8)

1.5 cm	0512	1850.20	--	--	1.6	**	--
	0661	1880.00	29.31	-0.006		0.264	22.0
	0810	1909.80	--	--		**	--

- NOTES :
1. Depth of Liquid : 15.0 cm
 2. Transmitter power was measured at the antenna-conducted terminal.
 3. The SAR result marked at ** is optional, because the SAR measured at the middle channel for that configuration is at least 3.0 dB lower than the SAR limit.
 4. The earphone wire connected to the EUT to simulate hand-free operation in a body-worn configuration.
 5. Please refer to attachment for the result presentation in plot format.

Appendix B: Test Instruments

Type	Model	Manufacturer	ID No.	Last Cal.	Interval
E-Field Probe	ET3DV6	SPEAG	S-2	2007/11	1 Year
DAE	DAE3 V1	SPEAG	S-3	2007/11	1 Year
Robot	RX60L	SPEAG	S-7	N/A	N/A
Probe Alignment Unit	LB1RX60L	SPEAG	S-13	N/A	N/A
Network Analyzer	8719ET	Agilent	B-53	2007/10	1 Year
Dielectric Probe Kit	85070D	Agilent	B-54	N/A	N/A
900MHz Dipole	D900V2	SPEAG	S-4	2007/11	1 Year
1800MHz Dipole	D1800V2	SPEAG	S-5	2007/11	1 Year
Signal Generator	E8257D	Agilent	B-39	2008/7	1 Year
RF Amplifier	A0840-3833-R	R&K	A-34	N/A	N/A
Low Pass Filter	LSM1000-4BA	LARK	D-90	2007/11	1 Year
Low Pass Filter	LSM2200-4BA	LARK	D-91	2007/11	1 Year
Universal Telecommunication Tester	CMU200	Rohde&Schwarz	B-21	2008/4	1 Year
Power Meter	E4417A	Agilent	B-51	2008/6	1 Year
Power Sensor	E9300B	Agilent	B-32	2008/6	1 Year
Power Sensor	E9323A	Agilent	B-59	2008/6	1 Year
Attenuator	4T-10	Weinschel	D-73	2008/6	1 Year
Attenuator	4T-10	Weinschel	D-74	2008/6	1 Year

Appendix C: Attachments

Exhibit	Contents	No. of page(s)
1	System Validation Plots	4
2-1	SAR Test Plots (WCDMA 850 MHz)	16
2-2	SAR Test Plots (PCS 1900 MHz)	18
3	Dosimetric E-Field Probe – ET3DV6, S/N: 1679	9
4-1	System Validation Dipole – D900V2, S/N: 153	9
4-2	System Validation Dipole – D1800V2, S/N: 2d038	9