

**ELECTROMAGNETIC EMISSIONS
COMPLIANCE REPORT**

FCC Applicant: Murata Manufacturing Co., Ltd.
1-10-1, Higashikotari, Nagaokakyo-shi, Kyoto 617-8555 Japan

FCC Manufacturer: Murata Manufacturing Co., Ltd.
1-10-1, Higashikotari, Nagaokakyo-shi, Kyoto 617-8555 Japan

ISED Applicant: Murata Manufacturing Co., Ltd.
1-10-1, Higashikotari, Nagaokakyo-shi, Kyoto 617-8555 Japan

ISED Manufacturer: Murata Manufacturing Co., Ltd.
1-10-1, Higashikotari, Nagaokakyo-shi, Kyoto 617-8555 Japan

Product Name: Communication Module

Brand Name: muRata

Model No.: LBEE5ZZ1XL, LBEE5ZZ2XS

Model Difference: Refer to section 1.8

Report Number: E2/2022/10038

FCC ID VPYLBEE5ZZ1XL

IC: 772C-LBEE5ZZ1XL

Date of EUT Received: January 11, 2022

Date of Test: January 19, 2022~ June 29, 2022

Issue Date: June 30, 2022

Approved By _____

Jay Lin

We hereby certify that:

The above equipment was tested by SGS Taiwan Ltd. Central RF Lab The test data, data evaluation, test procedures, and equipment configurations shown in this report were made in accordance with the procedures given in ANSI C63.10:2013 and the energy emitted by the sample EUT comply with FCC rule part §15.247, ISED RSS-247.

The results of this report relate only to the sample identified in this report.

Unless otherwise stated the results shown in this test report refer only to the sample(s) tested and such sample(s) are retained for 90 days only.

除非另有說明，此報告結果僅對測試之樣品負責，同時此樣品僅保留90天。本報告未經本公司書面許可，不可部份複製。

This document is issued by the Company subject to its General Conditions of Service printed overleaf, available on request or accessible at <http://www.sgs.com.tw/Terms-and-Conditions> and for electronic format documents, subject to Terms and Conditions for Electronic Documents at <http://www.sgs.com.tw/Terms-and-Conditions>. Attention is drawn to the limitation of liability, indemnification and jurisdiction issues defined therein. Any holder of this document is advised that information contained hereon reflects the Company's findings at the time of its intervention only and within the limits of Client's instructions, if any. The Company's sole responsibility is to its Client and this document does not exonerate parties to a transaction from exercising all their rights and obligations under the transaction documents. This document cannot be reproduced except in full, without prior written approval of the Company. Any unauthorized alteration, forgery or falsification of the content or appearance of this document is unlawful and offenders may be prosecuted to the fullest extent of the law.

Revision History					
Report Number	Revision	Description	Issue Date	Revised By	Remark
E2/2022/10038	00	Original.	June 20, 2022	Yami Kuo	*
E2/2022/10038	01	Revised chapter 10.	June 30, 2022	Yami Kuo	*

Note:

- 1、The remark "*" indicates modification of the report upon requests from certification body.
- 2、Variant information of model numbers is provided by the applicant, please refer to section 1.8 of this report for details.
Test results of this report are applicable to the sample EUT(s) received and variant models are assessed as electrically identical, no further tests are required for the variant.

Unless otherwise stated the results shown in this test report refer only to the sample(s) tested and such sample(s) are retained for 90 days only.

除非另有說明，此報告結果僅對測試之樣品負責，同時此樣品僅保留90天。本報告未經本公司書面許可，不可部份複製。

This document is issued by the Company subject to its General Conditions of Service printed overleaf, available on request or accessible at <http://www.sgs.com.tw/Terms-and-Conditions> and for electronic format documents, subject to Terms and Conditions for Electronic Documents at <http://www.sgs.com.tw/Terms-and-Conditions>. Attention is drawn to the limitation of liability, indemnification and jurisdiction issues defined therein. Any holder of this document is advised that information contained hereon reflects the Company's findings at the time of its intervention only and within the limits of Client's instructions, if any. The Company's sole responsibility is to its Client and this document does not exonerate parties to a transaction from exercising all their rights and obligations under the transaction documents. This document cannot be reproduced except in full, without prior written approval of the Company. Any unauthorized alteration, forgery or falsification of the content or appearance of this document is unlawful and offenders may be prosecuted to the fullest extent of the law.

Table of Contents

1	GENERAL INFORMATION	4
2	SYSTEM TEST CONFIGURATION	8
3	SUMMARY OF TEST RESULTS	11
4	DESCRIPTION OF TEST MODES	12
5	MEASUREMENT UNCERTAINTY	16
6	MEASUREMENT EQUIPMENT USED	17
7	CONDUCTED EMISSION TEST	20
8	PEAK OUTPUT POWER MEASUREMENT	24
9	EMISSION BANDWIDTH MEASUREMENT	51
10	CONDUCTED BAND EDGES AND SPURIOUS EMISSION MEASUREMENT	71
11	RADIATED BANDEDGE AND SPURIOUS EMISSION MEASUREMENT	91
12	POWER SPECTRAL DENSITY	175
13	ANTENNA REQUIREMENT	187

Unless otherwise stated the results shown in this test report refer only to the sample(s) tested and such sample(s) are retained for 90 days only.

除非另有說明，此報告結果僅對測試之樣品負責，同時此樣品僅保留90天。本報告未經本公司書面許可，不可部份複製。

This document is issued by the Company subject to its General Conditions of Service printed overleaf, available on request or accessible at <http://www.sgs.com.tw/Terms-and-Conditions> and for electronic format documents, subject to Terms and Conditions for Electronic Documents at <http://www.sgs.com.tw/Terms-and-Conditions>. Attention is drawn to the limitation of liability, indemnification and jurisdiction issues defined therein. Any holder of this document is advised that information contained hereon reflects the Company's findings at the time of its intervention only and within the limits of Client's instructions, if any. The Company's sole responsibility is to its Client and this document does not exonerate parties to a transaction from exercising all their rights and obligations under the transaction documents. This document cannot be reproduced except in full, without prior written approval of the Company. Any unauthorized alteration, forgery or falsification of the content or appearance of this document is unlawful and offenders may be prosecuted to the fullest extent of the law.

1 GENERAL INFORMATION

1.1 Product Description

Product Name:	Communication Module
Brand Name:	muRata
Model No.:	LBEE5ZZ1XL, LBEE5ZZ2XS
Model Differerce	Refer to section 1.8
Hardware Version:	1
Firmware Version:	17.80.200.204
EUT Series No.:	1XL: Sample. No2
Power Supply:	3.3Vdc, 1.8Vdc
Test Software (Name/Version)	Tera Term V4.105 / Dut labtool v2.0.0.85

1.2 RF Specification

WLAN 2.4GHz

Wi-Fi	Frequency Range	Channels	Rated Power in dBm (Peak)	Modulation Technology
802.11b	2412~2462	11	25.51	DSSS
802.11g	2412~2462	11	27.64	OFDM
802.11n20	2412~2462	11	27.62	OFDM
802.11n40	2422~2452	7	27.28	OFDM
802.11ac20	2412~2462	11	27.51	OFDM
802.11ac40	2422~2452	7	27.16	OFDM
802.11ax20	2412~2462	11	27.56	OFDMA
802.11ax40	2422~2452	7	27.22	OFDMA
Modulation type:		CCK, DQPSK, DBPSK for DSSS		
		256 QAM, 64QAM, 16QAM, QPSK, BPSK for OFDM		
		1024 QAM, 256 QAM, 64QAM, 16QAM, QPSK, BPSK for OFDMA		
Data Rate:		802.11 b: 1/2/5.5/11 Mbps		
		802.11 g: 6/9/12/18/24/36/48/54 Mbps		
		802.11 n_20MHz: 6.5 - 144.4Mbps		
		802.11 n_40MHz: 13.5 - 300Mbps		
		802.11 ac_20MHz: 6.5 - 173.3Mbps		
		802.11 ac_40MHz: 13.5 - 400Mbps		
		802.11 ax_20MHz: 0.4 - 286.8Mbps		
		802.11 ax_40MHz: 0.4 - 573.5Mbps		

Unless otherwise stated the results shown in this test report refer only to the sample(s) tested and such sample(s) are retained for 90 days only.

除非另有說明，此報告結果僅對測試之樣品負責，同時此樣品僅保留90天。本報告未經本公司書面許可，不可部份複製。

This document is issued by the Company subject to its General Conditions of Service printed overleaf, available on request or accessible at <http://www.sgs.com.tw/Terms-and-Conditions> and for electronic format documents, subject to Terms and Conditions for Electronic Documents at <http://www.sgs.com.tw/Terms-and-Conditions>. Attention is drawn to the limitation of liability, indemnification and jurisdiction issues defined therein. Any holder of this document is advised that information contained hereon reflects the Company's findings at the time of its intervention only and within the limits of Client's instructions, if any. The Company's sole responsibility is to its Client and this document does not exonerate parties to a transaction from exercising all their rights and obligations under the transaction documents. This document cannot be reproduced except in full, without prior written approval of the Company. Any unauthorized alteration, forgery or falsification of the content or appearance of this document is unlawful and offenders may be prosecuted to the fullest extent of the law.

WLAN 2.4GHz for IC

Wi-Fi	Frequency Range	Channels	Rated Power in dBm (Avg)	Rated Power in dBm (EIRP)	Modulation Technology
802.11b	2412~2462	11	22.91	29.12	DSSS
802.11g	2412~2462	11	21.91	28.12	OFDM
802.11n20	2412~2462	11	20.96	27.17	OFDM
802.11n40	2422~2452	7	18.94	25.15	OFDM
802.11ac20	2412~2462	11	20.87	27.08	OFDM
802.11ac40	2422~2452	7	18.87	25.08	OFDM
802.11ax20	2412~2462	11	20.94	27.15	OFDMA
802.11ax40	2422~2452	7	18.97	25.18	OFDMA
Modulation type:		CCK, DQPSK, DBPSK for DSSS			
		256 QAM, 64QAM, 16QAM, QPSK, BPSK for OFDM			
		1024 QAM, 256 QAM, 64QAM, 16QAM, QPSK, BPSK for OFDMA			
Data Rate:		802.11 b: 1/2/5.5/11 Mbps			
		802.11 g: 6/9/12/18/24/36/48/54 Mbps			
		802.11 n_20MHz: 6.5 - 144.4Mbps			
		802.11 n_40MHz: 13.5 - 300Mbps			
		802.11 ac_20MHz: 6.5 - 173.3Mbps			
		802.11 ac_40MHz: 13.5 - 400Mbps			
		802.11 ax_20MHz: 0.4 - 286.8Mbps			
		802.11 ax_40MHz: 0.4 - 573.5Mbps			

1.3 Antenna Designation

Antenna Type	Freq. (MHz)	Peak Antenna Gain (dBi)	Directional Gain (dBi)
Dipole	2412-2462	3.2	6.21

Note:

1. Pre-scanned was done on the above antennas, measurements were demonstrated by using the antenna with the highest gain as the worst case scenarios.
2. Antenna information is provided by the applicant.

Unless otherwise stated the results shown in this test report refer only to the sample(s) tested and such sample(s) are retained for 90 days only.

除非另有說明，此報告結果僅對測試之樣品負責，同時此樣品僅保留90天。本報告未經本公司書面許可，不可部份複製。

This document is issued by the Company subject to its General Conditions of Service printed overleaf, available on request or accessible at <http://www.sgs.com.tw/Terms-and-Conditions> and for electronic format documents, subject to Terms and Conditions for Electronic Documents at <http://www.sgs.com.tw/Terms-and-Conditions>. Attention is drawn to the limitation of liability, indemnification and jurisdiction issues defined therein. Any holder of this document is advised that information contained hereon reflects the Company's findings at the time of its intervention only and within the limits of Client's instructions, if any. The Company's sole responsibility is to its Client and this document does not exonerate parties to a transaction from exercising all their rights and obligations under the transaction documents. This document cannot be reproduced except in full, without prior written approval of the Company. Any unauthorized alteration, forgery or falsification of the content or appearance of this document is unlawful and offenders may be prosecuted to the fullest extent of the law.

1.4 Test Methodology of Applied Standards

- FCC Part 15, Subpart C §15.247
- FCC KDB 558074 D01 15.247 Meas Guidance v05r02
- FCC KDB 662911 D01 Multiple Transmitter Output v02r01
- RSS-247 issue 2 Feb. 2017
- RSS-Gen, Issue 5 (Amendment 2, February 2021)
- ANSI C63.10:2013

1.5 Test Facility

Laboratory	Test Site Address	Test Site Name	FCC Designation number	IC CAB identifier
SGS Taiwan Ltd. Central RF Lab. (TAF code 3702)	No.134, Wu Kung Road, New Taipei Industrial Park, Wuku District, New Taipei City, Taiwan.	SAC 1	TW0027	TW3702
		SAC 3		
		Conduction 1		
		Conducted 1		
		Conducted 2		
		Conducted 3		
		Conducted 4		
		Conducted 5		
	Conducted 6			
	No.2, Keji 1st Rd., Guishan District, Taoyuan City, Taiwan 333	Conduction C	TW0028	
		SAC C		
		SAC D		
		SAC G		
		Conducted A		
		Conducted B		
		Conducted C		
		Conducted D		
		Conducted E		
		Conducted F		
		Conducted G		
Note: Test site name is remarked on the equipment list in each section of this report as an indication where measurements occurred in specific test site and address.				

1.6 Special Accessories

There are no special accessories used while test was conducted.

1.7 Equipment Modifications

There was no modification incorporated into the EUT.

Unless otherwise stated the results shown in this test report refer only to the sample(s) tested and such sample(s) are retained for 90 days only.

除非另有說明，此報告結果僅對測試之樣品負責，同時此樣品僅保留90天。本報告未經本公司書面許可，不可部份複製。

This document is issued by the Company subject to its General Conditions of Service printed overleaf, available on request or accessible at <http://www.sgs.com.tw/Terms-and-Conditions> and for electronic format documents, subject to Terms and Conditions for Electronic Documents at <http://www.sgs.com.tw/Terms-and-Conditions>. Attention is drawn to the limitation of liability, indemnification and jurisdiction issues defined therein. Any holder of this document is advised that information contained hereon reflects the Company's findings at the time of its intervention only and within the limits of Client's instructions, if any. The Company's sole responsibility is to its Client and this document does not exonerate parties to a transaction from exercising all their rights and obligations under the transaction documents. This document cannot be reproduced except in full, without prior written approval of the Company. Any unauthorized alteration, forgery or falsification of the content or appearance of this document is unlawful and offenders may be prosecuted to the fullest extent of the law.

1.8 Model Difference

LBEE5ZZ1XL has a dedicated antenna port for BT.

LBEE5ZZ2XS BT shares same antenna port with WLAN.

Some passive components are different between models as below.

LBEE5ZZ1XL	LBEE5ZZ2XS
C 336 No mounted	C336 mounted
C337 mounted	C337 No mounted
L310 mounted	L310 No mounted

Unless otherwise stated the results shown in this test report refer only to the sample(s) tested and such sample(s) are retained for 90 days only.

除非另有說明，此報告結果僅對測試之樣品負責，同時此樣品僅保留90天。本報告未經本公司書面許可，不可部份複製。

This document is issued by the Company subject to its General Conditions of Service printed overleaf, available on request or accessible at <http://www.sgs.com.tw/Terms-and-Conditions> and for electronic format documents, subject to Terms and Conditions for Electronic Documents at <http://www.sgs.com.tw/Terms-and-Conditions>. Attention is drawn to the limitation of liability, indemnification and jurisdiction issues defined therein. Any holder of this document is advised that information contained hereon reflects the Company's findings at the time of its intervention only and within the limits of Client's instructions, if any. The Company's sole responsibility is to its Client and this document does not exonerate parties to a transaction from exercising all their rights and obligations under the transaction documents. This document cannot be reproduced except in full, without prior written approval of the Company. Any unauthorized alteration, forgery or falsification of the content or appearance of this document is unlawful and offenders may be prosecuted to the fullest extent of the law.

2 SYSTEM TEST CONFIGURATION

2.1 EUT Configuration

The EUT configuration for testing is installed on RF field strength measurement to meet the Commissions requirement and operating in a manner which intends to maximize its emission characteristics in a continuous normal application.

2.2 EUT Exercise

An engineering test mode (software/firmware) that applicant provided was utilized to manipulate the EUT into transmit, selection of the test channel, and modulation scheme.

2.3 Test Procedure

2.3.1 Conducted Emissions

The EUT is a placed on a table which is 0.8 m above ground plane. Conducted emissions from the EUT measured in the frequency range between 0.15 MHz and 30MHz. The CISPR Quasi-Peak and Average detector mode is employed. The two LISNs provide 50uH/50 ohm of coupling impedance for the measuring instrument. Both lines of the power mains connected to the EUT were checked for maximum conducted interference.

2.3.2 Conducted Test (RF)

The active antenna port of the unlicensed wireless device is connected to the spectrum analyzer with attenuator to protect the instrumentation. If a second antenna port is available, it is tested at one operating frequency, with other port(s) appropriately terminated, to verify it has similar output characteristics as the fully tested port.

2.3.3 Radiated Emissions

The EUT is a placed on a turn table. For emissions testing at or below 1 GHz, the table height shall be 0.8 m above the reference ground plane. For emission measurements above 1 GHz, the table height shall be 1.5 m. The turn table shall rotate 360 degrees to determine the position of maximum emission level. EUT is set 3m away from the receiving antenna which varied from 1m to 4m to find out the highest emission. And also, each emission was to be maximized by changing the polarization of receiving antenna both horizontal and vertical. In order to find out the max. emission, the relative positions of this transmitter (EUT) was rotated through three orthogonal axes and measurement procedures for electric field radiated emissions above 1 GHz the EUT measurement is to be made "while keeping the antenna in the 'cone of radiation' from that area and pointed at the area both in azimuth and elevation, with polarization oriented for maximum response." is still within the 3dB illumination BW of the measurement antenna.

Unless otherwise stated the results shown in this test report refer only to the sample(s) tested and such sample(s) are retained for 90 days only.

除非另有說明，此報告結果僅對測試之樣品負責，同時此樣品僅保留90天。本報告未經本公司書面許可，不可部份複製。

This document is issued by the Company subject to its General Conditions of Service printed overleaf, available on request or accessible at <http://www.sgs.com.tw/Terms-and-Conditions> and for electronic format documents, subject to Terms and Conditions for Electronic Documents at <http://www.sgs.com.tw/Terms-and-Conditions>. Attention is drawn to the limitation of liability, indemnification and jurisdiction issues defined therein. Any holder of this document is advised that information contained hereon reflects the Company's findings at the time of its intervention only and within the limits of Client's instructions, if any. The Company's sole responsibility is to its Client and this document does not exonerate parties to a transaction from exercising all their rights and obligations under the transaction documents. This document cannot be reproduced except in full, without prior written approval of the Company. Any unauthorized alteration, forgery or falsification of the content or appearance of this document is unlawful and offenders may be prosecuted to the fullest extent of the law.

2.4 Measurement Results Explanation Example

2.4.1 Radiated Emission Test Sites For Measurements From 9 kHz To 30 MHz

Radiated emission below 30MHz is measured in a 9m*6m*6m semi-anechoic chamber, the measurements correspond to those obtained at an open-field test site.

There is a comparison data of both open-field test site and semi-Anechoic chamber, and the result came out very similar.

2.4.2 For all conducted test items:

The offset level is set in the spectrum analyzer to compensate the RF cable loss and attenuation factor between EUT conducted port and spectrum analyzer. With the offset compensation, the spectrum analyzer reading level is exactly EUT RF output level.

2.5 Test Configuration

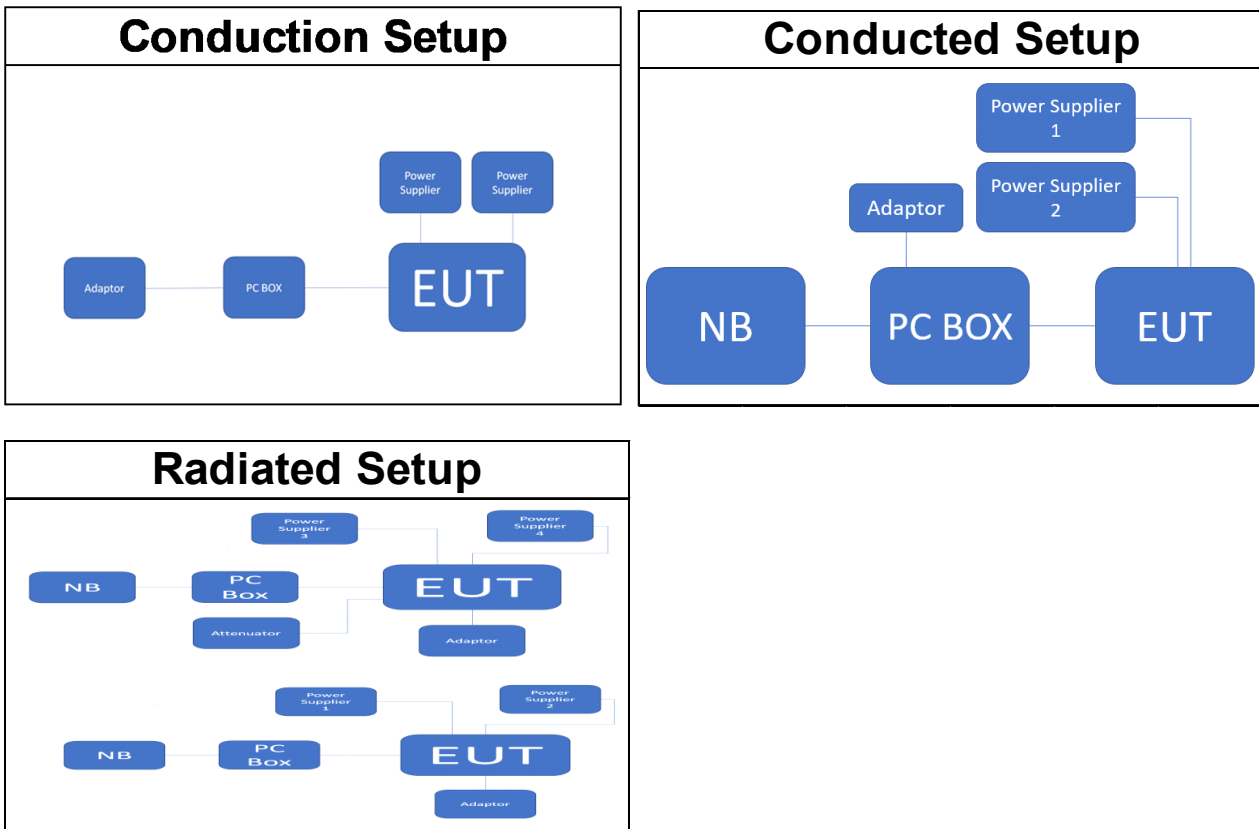

Unless otherwise stated the results shown in this test report refer only to the sample(s) tested and such sample(s) are retained for 90 days only.

除非另有說明，此報告結果僅對測試之樣品負責，同時此樣品僅保留90天。本報告未經本公司書面許可，不可部份複製。

This document is issued by the Company subject to its General Conditions of Service printed overleaf, available on request or accessible at <http://www.sgs.com.tw/Terms-and-Conditions> and for electronic format documents, subject to Terms and Conditions for Electronic Documents at <http://www.sgs.com.tw/Terms-and-Conditions>. Attention is drawn to the limitation of liability, indemnification and jurisdiction issues defined therein. Any holder of this document is advised that information contained hereon reflects the Company's findings at the time of its intervention only and within the limits of Client's instructions, if any. The Company's sole responsibility is to its Client and this document does not exonerate parties to a transaction from exercising all their rights and obligations under the transaction documents. This document cannot be reproduced except in full, without prior written approval of the Company. Any unauthorized alteration, forgery or falsification of the content or appearance of this document is unlawful and offenders may be prosecuted to the fullest extent of the law.

2.6 Control Unit(s)

Conducted Emission Test Site: Conducted D					
EQUIPMENT TYPE	MFR	MODEL NUMBER	SERIAL NUMBER	LAST CAL.	CAL DUE.
Notebook	Lenovo	T420	S0012599	N/A	N/A
Notebook	Lenovo	L420	S0011721	N/A	N/A

Radiated Emission Test Site: SAC D					
EQUIPMENT TYPE	MFR	MODEL NUMBER	SERIAL NUMBER	LAST CAL.	CAL DUE.
LAN Cable	向聯	VPH-02	1500021123	N.C.R	N.C.R
LAN Cable	INVAX	IVX011	N/A	N.C.R	N.C.R
Notebook	Lenovo	T470	P0001293	N/A	N/A
Notebook	Lenovo	T420	S0012599	N/A	N/A
Adapter	APD	NB-65B19	N/A	N/A	N/A
Adapter	FSP	FSP065-REBN2	H6081012364	N.C.R	N.C.R

Unless otherwise stated the results shown in this test report refer only to the sample(s) tested and such sample(s) are retained for 90 days only.

除非另有說明，此報告結果僅對測試之樣品負責，同時此樣品僅保留90天。本報告未經本公司書面許可，不可部份複製。

This document is issued by the Company subject to its General Conditions of Service printed overleaf, available on request or accessible at <http://www.sgs.com.tw/Terms-and-Conditions> and for electronic format documents, subject to Terms and Conditions for Electronic Documents at <http://www.sgs.com.tw/Terms-and-Conditions>. Attention is drawn to the limitation of liability, indemnification and jurisdiction issues defined therein. Any holder of this document is advised that information contained hereon reflects the Company's findings at the time of its intervention only and within the limits of Client's instructions, if any. The Company's sole responsibility is to its Client and this document does not exonerate parties to a transaction from exercising all their rights and obligations under the transaction documents. This document cannot be reproduced except in full, without prior written approval of the Company. Any unauthorized alteration, forgery or falsification of the content or appearance of this document is unlawful and offenders may be prosecuted to the fullest extent of the law.

3 SUMMARY OF TEST RESULTS

FCC Rules	ISED Rules	Description Of Test	Result
§15.207(a)	RSS-Gen §8.8	AC Power Line Conducted Emission	Compliant
§15.247(b) (3)	RSS-247 §5.4 d	Peak Output Power	Compliant
§15.247(a)(2)	RSS-247 §5.2 a RSS-Gen §6.7	Emission Bandwidth	Compliant
§15.205 §15.209 §15.247(d)	RSS-247 §5.5 RSS-Gen §8.9 RSS-Gen §8.10 RSS-Gen §6.13	Radiated & Conducted Band Edge and Spurious Emission	Compliant
§15.247(e)	RSS-247 §5.2 b	Power Spectral Density	Compliant
§15.203	N/A	Antenna Requirement	Compliant

Unless otherwise stated the results shown in this test report refer only to the sample(s) tested and such sample(s) are retained for 90 days only.

除非另有說明，此報告結果僅對測試之樣品負責，同時此樣品僅保留90天。本報告未經本公司書面許可，不可部份複製。

This document is issued by the Company subject to its General Conditions of Service printed overleaf, available on request or accessible at <http://www.sgs.com.tw/Terms-and-Conditions> and for electronic format documents, subject to Terms and Conditions for Electronic Documents at <http://www.sgs.com.tw/Terms-and-Conditions>. Attention is drawn to the limitation of liability, indemnification and jurisdiction issues defined therein. Any holder of this document is advised that information contained hereon reflects the Company's findings at the time of its intervention only and within the limits of Client's instructions, if any. The Company's sole responsibility is to its Client and this document does not exonerate parties to a transaction from exercising all their rights and obligations under the transaction documents. This document cannot be reproduced except in full, without prior written approval of the Company. Any unauthorized alteration, forgery or falsification of the content or appearance of this document is unlawful and offenders may be prosecuted to the fullest extent of the law.

4 DESCRIPTION OF TEST MODES

4.1 Operatin Frequencies

Modulation of 20MHz nominal bandwidth

CHANNEL	FREQUENCY (MHz)
1	2412
2	2417
3	2422
4	2427
5	2432
6	2437
7	2442
8	2447
9	2452
10	2457
11	2462

Modulation of 40MHz nominal bandwidth

CHANNEL	FREQUENCY (MHz)
3	2422
4	2427
5	2432
6	2437
7	2442
8	2447
9	2452

Unless otherwise stated the results shown in this test report refer only to the sample(s) tested and such sample(s) are retained for 90 days only.

除非另有說明，此報告結果僅對測試之樣品負責，同時此樣品僅保留90天。本報告未經本公司書面許可，不可部份複製。

This document is issued by the Company subject to its General Conditions of Service printed overleaf, available on request or accessible at <http://www.sgs.com.tw/Terms-and-Conditions> and for electronic format documents, subject to Terms and Conditions for Electronic Documents at <http://www.sgs.com.tw/Terms-and-Conditions>. Attention is drawn to the limitation of liability, indemnification and jurisdiction issues defined therein. Any holder of this document is advised that information contained hereon reflects the Company's findings at the time of its intervention only and within the limits of Client's instructions, if any. The Company's sole responsibility is to its Client and this document does not exonerate parties to a transaction from exercising all their rights and obligations under the transaction documents. This document cannot be reproduced except in full, without prior written approval of the Company. Any unauthorized alteration, forgery or falsification of the content or appearance of this document is unlawful and offenders may be prosecuted to the fullest extent of the law.

4.2 The Worst Test Modes and Channel Details

1. The EUT has been tested under operating condition.
2. Test program used to control the EUT for staying in continuous transmitting and receiving mode is programmed.
3. Investigation has been done on all the possible configurations for searching the worst case.

The gevin UE is pre-scanned among below modes.

Modulation		Transmission Chain							Single Transmission Spatial	Multi Transmission Spatial			
v	802.11 b	v	Ch0	v	Ch1		Ch2		Ch3		1TX	v	2TX
v	802.11 g	v	Ch0	v	Ch1		Ch2		Ch3		1TX	v	2TX
v	802.11 n	v	Ch0	v	Ch1		Ch2		Ch3		SISO	v	MIMO
v	802.11 ax	v	Ch0	v	Ch1		Ch2		Ch3		SISO	v	MIMO

4. Therefore, below summary is the modes of test configuration that yield the highest reading and generate the highest emission chosen to carry out the relevantly mandatory test items.
5. Observations have been done for 802.11 ax available RU configurations below and found that the lowest, highest and Full RU results higher emissions. Only one RU can be enabled at any given time.

Unless otherwise stated the results shown in this test report refer only to the sample(s) tested and such sample(s) are retained for 90 days only.

除非另有說明，此報告結果僅對測試之樣品負責，同時此樣品僅保留90天。本報告未經本公司書面許可，不可部份複製。

This document is issued by the Company subject to its General Conditions of Service printed overleaf, available on request or accessible at <http://www.sgs.com.tw/Terms-and-Conditions> and for electronic format documents, subject to Terms and Conditions for Electronic Documents at <http://www.sgs.com.tw/Terms-and-Conditions>. Attention is drawn to the limitation of liability, indemnification and jurisdiction issues defined therein. Any holder of this document is advised that information contained hereon reflects the Company's findings at the time of its intervention only and within the limits of Client's instructions, if any. The Company's sole responsibility is to its Client and this document does not exonerate parties to a transaction from exercising all their rights and obligations under the transaction documents. This document cannot be reproduced except in full, without prior written approval of the Company. Any unauthorized alteration, forgery or falsification of the content or appearance of this document is unlawful and offenders may be prosecuted to the fullest extent of the law.

802.11ax		20MHz				802.11ax		40MHz			
RU type		26-tone RU		52-tone RU		RU type		26-tone RU		52-tone RU	
RU index and subcarrier range	RU0	[-121: -96]	RU37	[-121: -70]	RU index and subcarrier range	RU0	[-243: -218]	RU37	[-243: -192]		
	RU1	[-95: -70]	RU38	[-68: -17]		RU1	[-217: -192]	RU38	[-189: -138]		
	RU2	[-68: -43]	RU39	[17: 68]		RU2	[-189: -164]	RU39	[-109: -58]		
	RU3	[-42: -17]	RU40	[70: 121]		RU3	[-163: -138]	RU40	[-55: -4]		
	RU4	[-16: -4, 4, 16]	RU41	N/A		RU4	[-136: -111]	RU41	[4: 55]		
	RU5	[17: 42]	RU42	N/A		RU5	[-109: -84]	RU42	[58: 109]		
	RU6	[43: 68]	RU43	N/A		RU6	[-83: -58]	RU43	[138: 189]		
	RU7	[70: 95]	RU44	N/A		RU7	[-55: -30]	RU44	[192: 243]		
	RU8	[96: 121]	RU45	N/A		RU8	[-29: -4]	RU45	N/A		
	RU9	N/A	RU46	N/A		RU9	[4: 29]	RU46	N/A		
	RU10	N/A	RU47	N/A		RU10	[30: 55]	RU47	N/A		
	RU11	N/A	RU48	N/A		RU11	[58: 83]	RU48	N/A		
	RU12	N/A	RU49	N/A		RU12	[84: 109]	RU49	N/A		
	RU13	N/A	RU50	N/A		RU13	[111: 136]	RU50	N/A		
	RU14	N/A	RU51	N/A		RU14	[138: 163]	RU51	N/A		
	RU15	N/A	RU52	N/A		RU15	[164: 189]	RU52	N/A		
	RU16	N/A				RU16	[192: 217]				
	RU17	N/A	106-tone RU			RU17	[218: 243]	106-tone RU			
	RU18	N/A	RU53	[-122: -17]		RU18	N/A	RU53	[-243: -138]		
	RU19	N/A	RU54	[17: 122]		RU19	N/A	RU54	[-109: -4]		
	RU20	N/A	RU55	N/A		RU20	N/A	RU55	[4: 109]		
	RU21	N/A	RU56	N/A		RU21	N/A	RU56	[138: 243]		
	RU22	N/A	RU57	N/A		RU22	N/A	RU57	N/A		
	RU23	N/A	RU58	N/A		RU23	N/A	RU58	N/A		
	RU24	N/A	RU59	N/A		RU24	N/A	RU59	N/A		
	RU25	N/A	RU60	N/A		RU25	N/A	RU60	N/A		
	RU26	N/A				RU26	N/A				
	RU27	N/A	242-tone RU			RU27	N/A	242-tone RU			
	RU28	N/A	RU61	[-122: -2, 2:122]		RU28	N/A	RU61	[-244: -3]		
	RU29	N/A	RU62	N/A		RU29	N/A	RU62	[3: 244]		
	RU30	N/A	RU63	N/A		RU30	N/A	RU63	N/A		
	RU31	N/A	RU64	N/A		RU31	N/A	RU64	N/A		
	RU32	N/A				RU32	N/A				
	RU33	N/A				RU33	N/A	484-tone RU			
	RU34	N/A				RU34	N/A	RU65	[-244: -3, 3: 244]		
	RU35	N/A				RU35	N/A	RU66	N/A		
RU36	N/A			RU36	N/A						

Unless otherwise stated the results shown in this test report refer only to the sample(s) tested and such sample(s) are retained for 90 days only.

除非另有說明，此報告結果僅對測試之樣品負責，同時此樣品僅保留90天。本報告未經本公司書面許可，不可部份複製。

This document is issued by the Company subject to its General Conditions of Service printed overleaf, available on request or accessible at <http://www.sgs.com.tw/Terms-and-Conditions> and for electronic format documents, subject to Terms and Conditions for Electronic Documents at <http://www.sgs.com.tw/Terms-and-Conditions>. Attention is drawn to the limitation of liability, indemnification and jurisdiction issues defined therein. Any holder of this document is advised that information contained hereon reflects the Company's findings at the time of its intervention only and within the limits of Client's instructions, if any. The Company's sole responsibility is to its Client and this document does not exonerate parties to a transaction from exercising all their rights and obligations under the transaction documents. This document cannot be reproduced except in full, without prior written approval of the Company. Any unauthorized alteration, forgery or falsification of the content or appearance of this document is unlawful and offenders may be prosecuted to the fullest extent of the law.

Conducted					
MODE	AVAILABLE CHANNEL	TESTED CHANNEL	MODULATION	DATA RATE (Mbps)	ANTENNA PORT
802.11b	1 to 11	1,2,6,10,11	DSSS	1	2TX
802.11g	1 to 11	1,2,6,10,11	OFDM	6	2TX
802.11n (HT20)	1 to 11	1,2,6,10,11	OFDM	MCS8	MIMO
802.11n (HT40)	3 to 9	3,4,6,8,9	OFDM	MCS8	MIMO
802.11ax (HE20)	1 to 11	1,2,6,10,11	OFDMA	MCS0	MIMO
802.11ax (HE40)	3 to 9	3,4,6,8,9	OFDMA	MCS0	MIMO

RADIATED EMISSION TEST (BELOW 1 GHz)					
MODE	AVAILABLE CHANNEL	TESTED CHANNEL	MODULATION	DATA RATE (Mbps)	ANTENNA PORT
802.11g	1 to 11	1,6,11	OFDM	6	2TX

RADIATED EMISSION TEST (ABOVE 1 GHz)					
MODE	AVAILABLE CHANNEL	TESTED CHANNEL	MODULATION	DATA RATE (Mbps)	ANTENNA PORT
802.11b	1 to 11	1,2,6,10,11	DSSS	1	2TX
802.11g	1 to 11	1,2,6,10,11	OFDM	6	2TX
802.11n (HT20)	1 to 11	1,2,6,10,11	OFDM	MCS8	MIMO
802.11n (HT40)	3 to 9	3,4,6,8,9	OFDM	MCS8	MIMO
802.11ax (HE20)	1 to 11	1,2,6,10,11	OFDMA	MCS0	MIMO
802.11ax (HE40)	3 to 9	3,4,6,8,9	OFDMA	MCS0	MIMO

Note:

The field strength of radiated emission was measured as the EUT positioned in different orthogonal planes (E1/E2/H) based on actual usage of the EUT to pre-scan the emissions for determining the worst case scenario.

Unless otherwise stated the results shown in this test report refer only to the sample(s) tested and such sample(s) are retained for 90 days only.

除非另有說明，此報告結果僅對測試之樣品負責，同時此樣品僅保留90天。本報告未經本公司書面許可，不可部份複製。

This document is issued by the Company subject to its General Conditions of Service printed overleaf, available on request or accessible at <http://www.sgs.com.tw/Terms-and-Conditions> and for electronic format documents, subject to Terms and Conditions for Electronic Documents at <http://www.sgs.com.tw/Terms-and-Conditions>. Attention is drawn to the limitation of liability, indemnification and jurisdiction issues defined therein. Any holder of this document is advised that information contained hereon reflects the Company's findings at the time of its intervention only and within the limits of Client's instructions, if any. The Company's sole responsibility is to its Client and this document does not exonerate parties to a transaction from exercising all their rights and obligations under the transaction documents. This document cannot be reproduced except in full, without prior written approval of the Company. Any unauthorized alteration, forgery or falsification of the content or appearance of this document is unlawful and offenders may be prosecuted to the fullest extent of the law.

5 MEASUREMENT UNCERTAINTY

Test Items	Uncertainty
AC Power Line Conducted Emission	+/- 2.34 dB
Output Power measurement	+/- 1 dB
Emission Bandwidth	+/- 1.53 Hz
Undesignable radiated emission measurement	+/- 1.68 dB
Peak Power Density	+/- 1.62 dB
Temperature	+/- 0.4 °C
Humidity	+/- 3.5 %
DC / AC Power Source	+/- 1 %

Radiated Spurious Emission Measurement Uncertainty			
Polarization: Vertical	+/-	2.57 dB	9kHz~30MHz
	+/-	4.85 dB	30MHz - 1000MHz
	+/-	4.45 dB	1GHz - 18GHz
	+/-	4.24 dB	18GHz - 40GHz
Polarization: Horizontal	+/-	2.57 dB	9kHz~30MHz
	+/-	4.37 dB	30MHz - 1000MHz
	+/-	4.45 dB	1GHz - 18GHz
	+/-	4.24 dB	18GHz - 40GHz

Note:

1. This uncertainty represents an expanded uncertainty expressed at approximately the 95% confidence level using a coverage factor of k=2.
2. The conformity assessment statement in this report is based solely on the test results, measurement uncertainty is excluded.

Unless otherwise stated the results shown in this test report refer only to the sample(s) tested and such sample(s) are retained for 90 days only.

除非另有說明，此報告結果僅對測試之樣品負責，同時此樣品僅保留90天。本報告未經本公司書面許可，不可部份複製。

This document is issued by the Company subject to its General Conditions of Service printed overleaf, available on request or accessible at <http://www.sgs.com.tw/Terms-and-Conditions> and for electronic format documents, subject to Terms and Conditions for Electronic Documents at <http://www.sgs.com.tw/Terms-and-Conditions>. Attention is drawn to the limitation of liability, indemnification and jurisdiction issues defined therein. Any holder of this document is advised that information contained hereon reflects the Company's findings at the time of its intervention only and within the limits of Client's instructions, if any. The Company's sole responsibility is to its Client and this document does not exonerate parties to a transaction from exercising all their rights and obligations under the transaction documents. This document cannot be reproduced except in full, without prior written approval of the Company. Any unauthorized alteration, forgery or falsification of the content or appearance of this document is unlawful and offenders may be prosecuted to the fullest extent of the law.

6 MEASUREMENT EQUIPMENT USED

6.1 Emission from AC power line

AC Power-Line Conducted Emission Test Site: Conduction C					
EQUIPMENT TYPE	MFR	MODEL NUMBER	SERIAL NUMBER	LAST CAL.	CAL DUE.
LISN	SCHWARZBECK Mess- Elektronik	NSLK8127	974	04/19/2021	04/18/2022
LISN	SCHWARZBECK Mess- Elektronik	NSLK8127	974	04/13/2022	04/12/2023
EMI Test Receiver	R&S	ESCI	101342	04/28/2021	04/27/2022
EMI Test Receiver	R&S	ESCI	101342	04/25/2022	04/24/2023
DC Power Supply	Gwinstek	SPS-3610	GEV856769	08/04/2021	08/03/2022
DC Power Supply	DHA	DPS-3003	9411005787	08/20/2021	08/19/2022
Coaxial Cable	EC Lab	RF-HY-CAB- 250	RF-HY-CAB- 250-01	03/27/2022	03/26/2023
Pulse Limiter	EC Lab	VTSD 9561F- N	04/29/1901	03/27/2022	03/26/2023
Test Software	audix	e3	E3 20923 SGS Ver.9 (C)	N.C.R	N.C.R

Unless otherwise stated the results shown in this test report refer only to the sample(s) tested and such sample(s) are retained for 90 days only.

除非另有說明，此報告結果僅對測試之樣品負責，同時此樣品僅保留90天。本報告未經本公司書面許可，不可部份複製。

This document is issued by the Company subject to its General Conditions of Service printed overleaf, available on request or accessible at <http://www.sgs.com.tw/Terms-and-Conditions> and for electronic format documents, subject to Terms and Conditions for Electronic Documents at <http://www.sgs.com.tw/Terms-and-Conditions>. Attention is drawn to the limitation of liability, indemnification and jurisdiction issues defined therein. Any holder of this document is advised that information contained hereon reflects the Company's findings at the time of its intervention only and within the limits of Client's instructions, if any. The Company's sole responsibility is to its Client and this document does not exonerate parties to a transaction from exercising all their rights and obligations under the transaction documents. This document cannot be reproduced except in full, without prior written approval of the Company. Any unauthorized alteration, forgery or falsification of the content or appearance of this document is unlawful and offenders may be prosecuted to the fullest extent of the law.

6.2 Conducted Measurement

Conducted Emission Test Site: Conducted D					
EQUIPMENT TYPE	MFR	MODEL NUMBER	SERIAL NUMBER	LAST CAL.	CAL DUE.
Spectrum Analyzer	KEYSIGHT	N9010B	MY59071574	06/25/2021	06/24/2022
Power Meter	Anritsu	ML2496A	1512003	07/27/2021	07/26/2022
Power Sensor	Anritsu	MA2411B	1339378	07/27/2021	07/26/2022
Power Sensor	Anritsu	MA2411B	1339379	07/27/2021	07/26/2022
DC Power Supply	Agilent	E3640A	MY53130054	09/30/2021	09/29/2022
DC Power Supply	Agilent	E3640A	MY53140006	05/28/2021	05/27/2022
DC Power Supply	Agilent	E3640A	MY53140006	05/16/2022	05/15/2023
DC Power Supply	HOLA	DP-3003	D7070035	05/28/2021	05/27/2022
DC Power Supply	HOLA	DP-3003	D7070035	06/09/2022	06/08/2023
DC Power Supply	Gwinstek	SPS-3610	GEV856767	09/29/2021	09/28/2022
Attenuator	Marvelous	MVE2213-10	RF13	11/18/2021	11/17/2022
Attenuator	Marvelous	WATT-218FS-10	RF15	11/18/2021	11/17/2022
Attenuator	KEYSIGHT	8494B	TH60075424	05/07/2021	05/06/2022
Attenuator	KEYSIGHT	8494B	TH60075424	05/06/2022	05/05/2023
Coupler	narda	MDC2044-20	RF36	11/18/2021	11/17/2022
DC Block	PASTERNAK	PE8210	RF158	11/18/2021	11/17/2022
Splitter	Marvelous Microwave	MVE8576	RF256	11/18/2021	11/17/2022
RF Switch	E-INSTRUMENT TECH LTD	ETF-1801	EC2100175	09/10/2021	09/09/2022
Coaxial Cables	Woken	00100A1F2A196C	RF62	11/18/2021	11/17/2022
Coaxial Cables	Woken	00100A1F2A196C	RF64	11/18/2021	11/17/2022
Coaxial Cables	Woken	00100A1F1A185C	RF71	11/18/2021	11/17/2022

Unless otherwise stated the results shown in this test report refer only to the sample(s) tested and such sample(s) are retained for 90 days only.

除非另有說明，此報告結果僅對測試之樣品負責，同時此樣品僅保留90天。本報告未經本公司書面許可，不可部份複製。

This document is issued by the Company subject to its General Conditions of Service printed overleaf, available on request or accessible at <http://www.sgs.com.tw/Terms-and-Conditions> and for electronic format documents, subject to Terms and Conditions for Electronic Documents at <http://www.sgs.com.tw/Terms-and-Conditions>. Attention is drawn to the limitation of liability, indemnification and jurisdiction issues defined therein. Any holder of this document is advised that information contained hereon reflects the Company's findings at the time of its intervention only and within the limits of Client's instructions, if any. The Company's sole responsibility is to its Client and this document does not exonerate parties to a transaction from exercising all their rights and obligations under the transaction documents. This document cannot be reproduced except in full, without prior written approval of the Company. Any unauthorized alteration, forgery or falsification of the content or appearance of this document is unlawful and offenders may be prosecuted to the fullest extent of the law.

6.3 Radiated Measurement

Radiated Emission Test Site: SAC D					
EQUIPMENT TYPE	MFR	MODEL NUMBER	SERIAL NUMBER	LAST CAL.	CAL DUE.
Broadband Antenna	SCHWARZBECK	VULB 9168	9168-617	11/12/2021	11/11/2022
Horn Antenna	Schwarzbeck	BBHA9170	185	08/06/2021	08/05/2022
Horn Antenna	Schwarzbeck	BBHA9120D	1341	06/04/2021	06/03/2022
Loop Antenna	ETS.LINDGREN	6502	143303	05/07/2021	05/06/2022
Loop Antenna	ETS.LINDGREN	6502	148045	09/29/2021	09/28/2022
3m Site NSA	SGS	966 chamber D	N/A	07/12/2021	07/11/2022
Test Software	audix	e3	E3 20923 SGS Ver.9 (C)	N.C.R	N.C.R
Spectrum Analyzer	KEYSIGHT	N9010A	MY57120200	03/24/2021	03/23/2022
Spectrum Analyzer	KEYSIGHT	N9010A	MY57120200	03/24/2022	03/23/2023
Pre-Amplifier	EMC Instruments	EMC184045B	980135	10/27/2021	10/26/2022
Pre-Amplifier	EMC Instruments	EMC9135	980234	11/18/2021	11/17/2022
Pre-Amplifier	EMC Instruments	EMC12630SE	980273	11/18/2021	11/17/2022
Attenuator	KEYSIGHT	8494B	TH60075424	05/07/2021	05/06/2022
Attenuator	KEYSIGHT	8494B	TH60075424	05/07/2022	05/06/2023
DC Power Supply	Gwinstek	SPS-3610	GEV856769	08/04/2021	08/03/2022
DC Power Supply	DHA	DPS-3003	9411005787	08/20/2021	08/19/2022
DC Power Supply	Agilent	E3640A	MY53140006	05/28/2021	05/27/2022
DC Power Supply	Agilent	E3640A	MY53140006	05/28/2022	05/27/2023
DC Power Supply	Agilent	E3640A	MY53170008	09/18/2021	09/17/2022
Coaxial Cable	Huber+Suhner	RG 214/U	W21.01	11/18/2021	11/17/2022
Coaxial Cable	Huber Suhner	EMC106-SM-SM-7200	150703	11/18/2021	11/17/2022
Coaxial Cable	Huber Suhner	SUCOFLEX 104	MY17413/4	11/18/2021	11/17/2022
Attenuator	Marvelous	WATT-218FS-10	RF17	11/18/2021	11/17/2022

NOTE: N.C.R refers to Not Calibrated Required.

Unless otherwise stated the results shown in this test report refer only to the sample(s) tested and such sample(s) are retained for 90 days only.

除非另有說明，此報告結果僅對測試之樣品負責，同時此樣品僅保留90天。本報告未經本公司書面許可，不可部份複製。

This document is issued by the Company subject to its General Conditions of Service printed overleaf, available on request or accessible at <http://www.sgs.com.tw/Terms-and-Conditions> and for electronic format documents, subject to Terms and Conditions for Electronic Documents at <http://www.sgs.com.tw/Terms-and-Conditions>. Attention is drawn to the limitation of liability, indemnification and jurisdiction issues defined therein. Any holder of this document is advised that information contained hereon reflects the Company's findings at the time of its intervention only and within the limits of Client's instructions, if any. The Company's sole responsibility is to its Client and this document does not exonerate parties to a transaction from exercising all their rights and obligations under the transaction documents. This document cannot be reproduced except in full, without prior written approval of the Company. Any unauthorized alteration, forgery or falsification of the content or appearance of this document is unlawful and offenders may be prosecuted to the fullest extent of the law.

7 CONDUCTED EMISSION TEST

7.1 Standard Applicable

Frequency range within 150kHz to 30MHz shall not exceed the Limit table as below.

Frequency range MHz	Limits (dBuV)	
	Quasi-peak	Average
0.15 to 0.50	66 to 56	56 to 46
0.50 to 5	56	46
5 to 30	60	50

Note

- 1.The lower limit shall apply at the transition frequencies
- 2.The limit decreases linearly with the logarithm of the frequency in the range 0.15 MHz to 0.50 MHz.

7.2 EUT Setup

1. The conducted emission tests were performed in the test site, using the setup in accordance with the ANSI C63.10:2013.
2. The AC/DC Power adaptor of EUT was plug-in LISN. The EUT was placed flushed with the rear of the table.
3. The LISN was connected with 120Vac/60Hz power source.

7.3 Test Setup

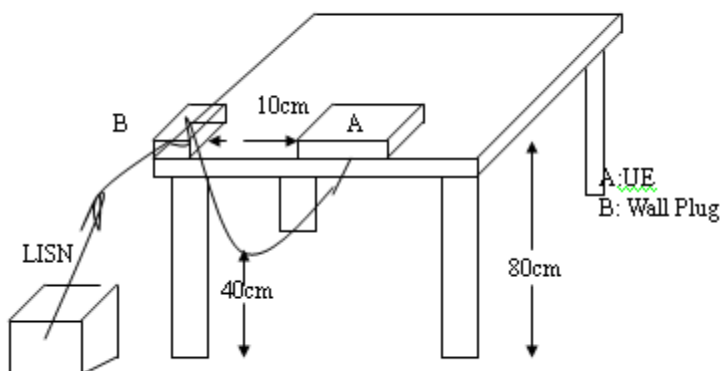

Unless otherwise stated the results shown in this test report refer only to the sample(s) tested and such sample(s) are retained for 90 days only.

除非另有說明，此報告結果僅對測試之樣品負責，同時此樣品僅保留90天。本報告未經本公司書面許可，不可部份複製。

This document is issued by the Company subject to its General Conditions of Service printed overleaf, available on request or accessible at <http://www.sgs.com.tw/Terms-and-Conditions> and for electronic format documents, subject to Terms and Conditions for Electronic Documents at <http://www.sgs.com.tw/Terms-and-Conditions>. Attention is drawn to the limitation of liability, indemnification and jurisdiction issues defined therein. Any holder of this document is advised that information contained hereon reflects the Company's findings at the time of its intervention only and within the limits of Client's instructions, if any. The Company's sole responsibility is to its Client and this document does not exonerate parties to a transaction from exercising all their rights and obligations under the transaction documents. This document cannot be reproduced except in full, without prior written approval of the Company. Any unauthorized alteration, forgery or falsification of the content or appearance of this document is unlawful and offenders may be prosecuted to the fullest extent of the law.

7.4 Measurement Procedure

1. The EUT was placed on a table which is 0.8m above ground plane.
2. Maximum procedure was performed on the six highest emissions to ensure EUT compliance.
3. Repeat above procedures until all phases of power being supplied by given UE are completed.

7.5 Measurement Result

Note: Refer to next page for measurement data and plots.

Note2: The * reveals the worst-case results that closet to the limit.

Unless otherwise stated the results shown in this test report refer only to the sample(s) tested and such sample(s) are retained for 90 days only.

除非另有說明，此報告結果僅對測試之樣品負責，同時此樣品僅保留90天。本報告未經本公司書面許可，不可部份複製。

This document is issued by the Company subject to its General Conditions of Service printed overleaf, available on request or accessible at <http://www.sgs.com.tw/Terms-and-Conditions> and for electronic format documents, subject to Terms and Conditions for Electronic Documents at <http://www.sgs.com.tw/Terms-and-Conditions>. Attention is drawn to the limitation of liability, indemnification and jurisdiction issues defined therein. Any holder of this document is advised that information contained hereon reflects the Company's findings at the time of its intervention only and within the limits of Client's instructions, if any. The Company's sole responsibility is to its Client and this document does not exonerate parties to a transaction from exercising all their rights and obligations under the transaction documents. This document cannot be reproduced except in full, without prior written approval of the Company. Any unauthorized alteration, forgery or falsification of the content or appearance of this document is unlawful and offenders may be prosecuted to the fullest extent of the law.

AC POWER LINE CONDUCTED EMISSION TEST DATA

Report Number	:E2/2022/10038	Test Site	:Conduction C
Test Mode	:2.4G	Test Date	:2022-04-01
Power	:120V/60Hz	Temp./Humi.	:20.8/63
Probe	:L1	Engineer	:Jack Tseng
Note:	: Adapter:FSP0065-REBN2		

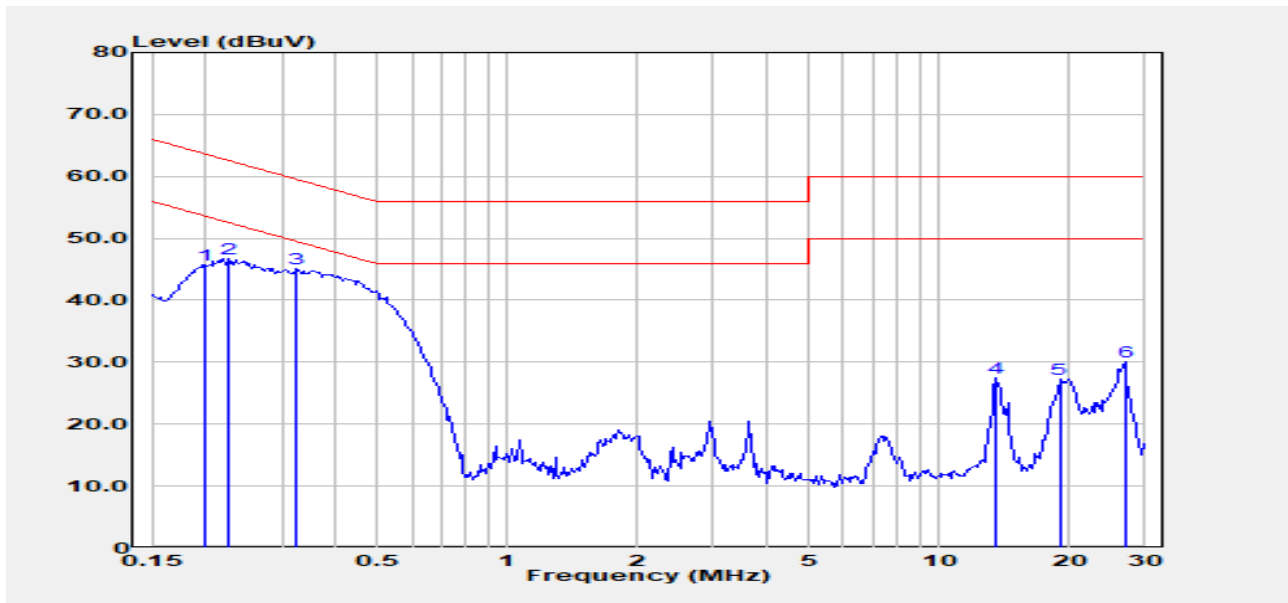

Freq. MHz	Detector Mode PK/QP/AV	Spectrum Reading Level dBμV	Factor dB	Actual FS dBμV	Limit dBμV	Margin dB
0.200	Peak	35.54	10.27	45.81	63.62	-17.82
0.227	Peak	36.38	10.28	46.66	62.57	-15.91
0.325	Peak	34.80	10.29	45.09	59.57	-14.48
13.551	Peak	16.62	10.75	27.38	60.00	-32.62
19.021	Peak	16.34	10.85	27.20	60.00	-32.80
26.984	Peak	19.01	11.05	30.06	60.00	-29.94

Unless otherwise stated the results shown in this test report refer only to the sample(s) tested and such sample(s) are retained for 90 days only.

除非另有說明，此報告結果僅對測試之樣品負責，同時此樣品僅保留90天。本報告未經本公司書面許可，不可部份複製。

This document is issued by the Company subject to its General Conditions of Service printed overleaf, available on request or accessible at <http://www.sgs.com.tw/Terms-and-Conditions> and for electronic format documents, subject to Terms and Conditions for Electronic Documents at <http://www.sgs.com.tw/Terms-and-Conditions>. Attention is drawn to the limitation of liability, indemnification and jurisdiction issues defined therein. Any holder of this document is advised that information contained hereon reflects the Company's findings at the time of its intervention only and within the limits of Client's instructions, if any. The Company's sole responsibility is to its Client and this document does not exonerate parties to a transaction from exercising all their rights and obligations under the transaction documents. This document cannot be reproduced except in full, without prior written approval of the Company. Any unauthorized alteration, forgery or falsification of the content or appearance of this document is unlawful and offenders may be prosecuted to the fullest extent of the law.

Report Number	:E2/2022/10038	Test Site	:Conduction C
Test Mode	:2.4G	Test Date	:2022-04-01
Power	:120V/60Hz	Temp./Humi.	:20.8/63
Probe	:N	Engineer	:Jack Tseng
Note:	: Adapter:FSP0065-REBN2		

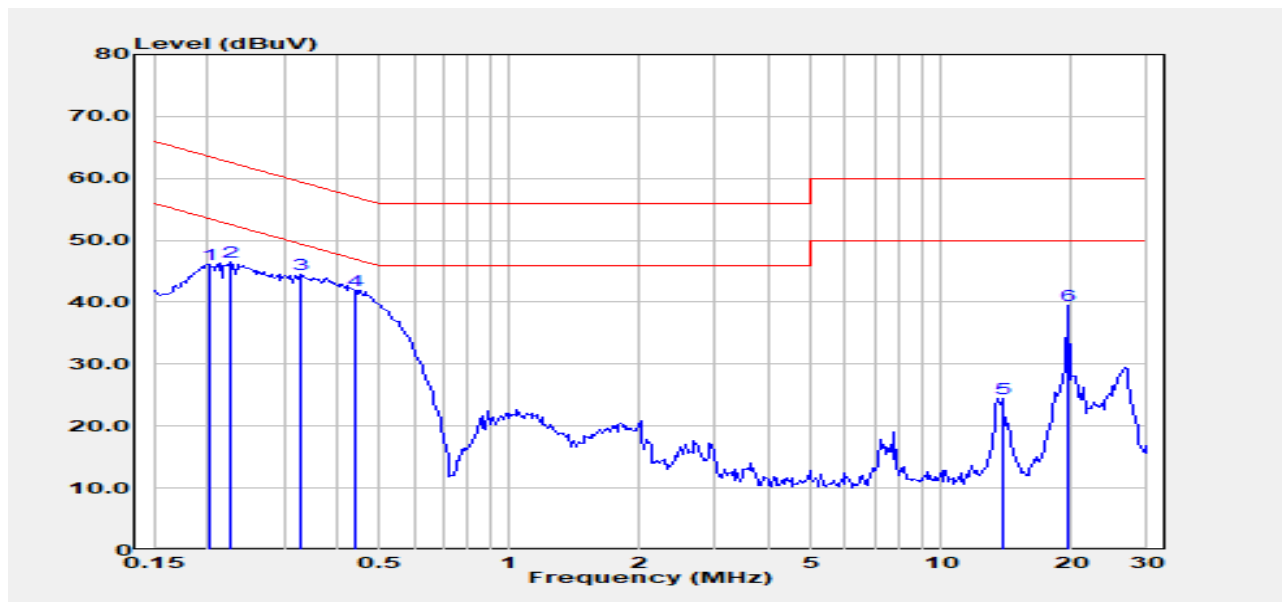

Freq. MHz	Detector Mode	Spectrum Reading Level dB μ V	Factor dB	Actual FS dB μ V	Limit dB μ V	Margin dB
0.202	Peak	35.80	10.27	46.07	63.54	-17.47
0.224	Peak	36.32	10.27	46.59	62.66	-16.06
0.329	Peak	34.16	10.29	44.45	59.49	-15.04
0.437	Peak	31.70	10.30	42.00	57.11	-15.11
13.841	Peak	13.80	10.72	24.51	60.00	-35.49
19.635	Peak	28.74	10.83	39.57	60.00	-20.43

Unless otherwise stated the results shown in this test report refer only to the sample(s) tested and such sample(s) are retained for 90 days only.

除非另有說明，此報告結果僅對測試之樣品負責，同時此樣品僅保留90天。本報告未經本公司書面許可，不可部份複製。

This document is issued by the Company subject to its General Conditions of Service printed overleaf, available on request or accessible at <http://www.sgs.com.tw/Terms-and-Conditions> and for electronic format documents, subject to Terms and Conditions for Electronic Documents at <http://www.sgs.com.tw/Terms-and-Conditions>. Attention is drawn to the limitation of liability, indemnification and jurisdiction issues defined therein. Any holder of this document is advised that information contained hereon reflects the Company's findings at the time of its intervention only and within the limits of Client's instructions, if any. The Company's sole responsibility is to its Client and this document does not exonerate parties to a transaction from exercising all their rights and obligations under the transaction documents. This document cannot be reproduced except in full, without prior written approval of the Company. Any unauthorized alteration, forgery or falsification of the content or appearance of this document is unlawful and offenders may be prosecuted to the fullest extent of the law.

8 PEAK OUTPUT POWER MEASUREMENT

8.1 Standard Applicable

8.2 Duty Cycle

Pre-analysis Check: While conducting average power measurement, duty cycle of each mode shall be checked to ensure its duty cycle in order to compensate for the loss due to insufficient ratio of duty cycle.

All duty cycle is pre-scanned, and result as obtained below shows only the most representative ones where duty cycle is conducted as the given transmission with given virtual operation that expresses the percentage.

8.3 Output Power

For systems using digital modulation in the 2400-2483.5 MHz bands, the limit for peak output power is 1Watt and the e.i.r.p. shall not exceed 4 W.

If the transmitting antenna of directional gain greater than 6dBi are used the peak output power form the intentional radiator shall be reduced below the above stated value by the amount in dB that the directional gain of the Antenna exceeds 6dBi.

In case of point-to-point operation, the limit has to be reduced by 1dB for every 3dB that the directional gain of Antenna exceeds 6dBi.

Note:

As per section F. 2). e). (ii) of FCC KDB 662911 D01

If antenna gains are not equal and each transmit antenna is driven by only one spatial stream, directional gain may be calculated by either of the following formulas.

$$DirectionalGain = 10 \cdot \log \left[\frac{\sum_{j=1}^{N_{SS}} \left\{ \sum_{k=1}^{N_{ANT}} g_{j,k} \right\}^2}{N_{ANT}} \right]$$

where

Each antenna is driven by no more than one spatial stream;

NSS = the number of independent spatial streams of data;

NANT = the total number of antennas

$g_{j,k} = 10^{Gk/20}$ if the kth antenna is being fed by spatial stream j, or zero if it is not;

Unless otherwise stated the results shown in this test report refer only to the sample(s) tested and such sample(s) are retained for 90 days only.

除非另有說明，此報告結果僅對測試之樣品負責，同時此樣品僅保留90天。本報告未經本公司書面許可，不可部份複製。

This document is issued by the Company subject to its General Conditions of Service printed overleaf, available on request or accessible at <http://www.sgs.com.tw/Terms-and-Conditions> and for electronic format documents, subject to Terms and Conditions for Electronic Documents at <http://www.sgs.com.tw/Terms-and-Conditions>. Attention is drawn to the limitation of liability, indemnification and jurisdiction issues defined therein. Any holder of this document is advised that information contained hereon reflects the Company's findings at the time of its intervention only and within the limits of Client's instructions, if any. The Company's sole responsibility is to its Client and this document does not exonerate parties to a transaction from exercising all their rights and obligations under the transaction documents. This document cannot be reproduced except in full, without prior written approval of the Company. Any unauthorized alteration, forgery or falsification of the content or appearance of this document is unlawful and offenders may be prosecuted to the fullest extent of the law.

G_k is the gain in dBi of the kth antenna.

The antenna gain is greater than 6 dBi, therefore the power limit attenuation has been applied in the test results.

8.4 Test Setup

8.4.1 Duty Cycle

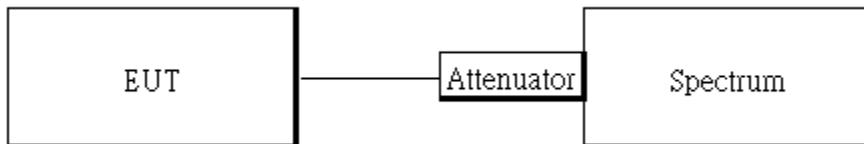

8.4.2 Output Power:

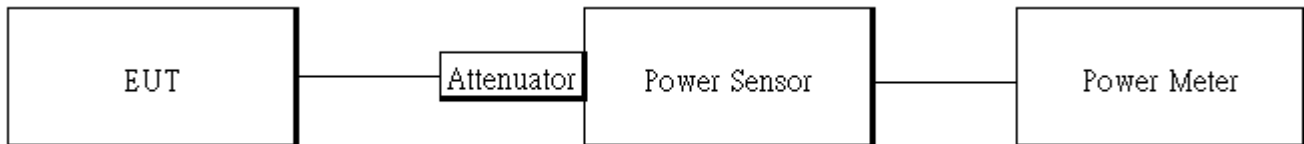

8.5 Measurement Procedure

8.5.1 Duty Cycle:

1. Set span = Zero
2. RBW = 8MHz
3. VBW = 8MHz,
4. Detector = Peak

8.5.2 Output Power

1. Place the EUT on the table and set it in transmitting mode.
2. The testing follows the Measurement Procedure of FCC KDB 558074 D01 DTS Meas. Guidance .
3. Remove the antenna from the EUT and then connect a low loss RF cable from the antenna port to the power meter.

Power Meter:

It is used as the auxiliary test equipment to conduct the output power measurement.

4. Record the max. Reading as observed from Spectrum or Power Meter.
5. MIMO mode: offset is set with “measure and add 10 Log (N)” to measurement for MIMO mode. Offset = cable loss + 10 log (N), where N is number of transmitting antenna, cable loss is specified below.

*** Note: The duty cycle factor and below is compensated to obtain the maximum value of measurement in average.**

Unless otherwise stated the results shown in this test report refer only to the sample(s) tested and such sample(s) are retained for 90 days only.

除非另有說明，此報告結果僅對測試之樣品負責，同時此樣品僅保留90天。本報告未經本公司書面許可，不可部份複製。

This document is issued by the Company subject to its General Conditions of Service printed overleaf, available on request or accessible at <http://www.sgs.com.tw/Terms-and-Conditions> and for electronic format documents, subject to Terms and Conditions for Electronic Documents at <http://www.sgs.com.tw/Terms-and-Conditions>. Attention is drawn to the limitation of liability, indemnification and jurisdiction issues defined therein. Any holder of this document is advised that information contained hereon reflects the Company's findings at the time of its intervention only and within the limits of Client's instructions, if any. The Company's sole responsibility is to its Client and this document does not exonerate parties to a transaction from exercising all their rights and obligations under the transaction documents. This document cannot be reproduced except in full, without prior written approval of the Company. Any unauthorized alteration, forgery or falsification of the content or appearance of this document is unlawful and offenders may be prosecuted to the fullest extent of the law.

8.6 Measurement Result

8.6.1 Duty Cycle:

	Duty Cycle (%) = Ton / (Ton+Toff)	Duty Factor (dB) =10*log (1/Duty Cycle)	1/T (kHz)	VBW setting (kHz)
802.11b	99.86	0.01	0.12	0.01
802.11g	98.96	0.05	0.70	0.01
802.11n_20	97.88	0.09	1.45	2.00
802.11n_40	95.96	0.18	2.81	3.00
802.11ac_20	97.90	0.09	1.43	2.00
802.11ac_40	96.00	0.18	2.78	3.00
802.11ax_20	97.37	0.12	1.80	2.00
802.11ax_40	95.33	0.21	3.27	4.00

Unless otherwise stated the results shown in this test report refer only to the sample(s) tested and such sample(s) are retained for 90 days only.

除非另有說明，此報告結果僅對測試之樣品負責，同時此樣品僅保留90天。本報告未經本公司書面許可，不可部份複製。

This document is issued by the Company subject to its General Conditions of Service printed overleaf, available on request or accessible at <http://www.sgs.com.tw/Terms-and-Conditions> and for electronic format documents, subject to Terms and Conditions for Electronic Documents at <http://www.sgs.com.tw/Terms-and-Conditions>. Attention is drawn to the limitation of liability, indemnification and jurisdiction issues defined therein. Any holder of this document is advised that information contained hereon reflects the Company's findings at the time of its intervention only and within the limits of Client's instructions, if any. The Company's sole responsibility is to its Client and this document does not exonerate parties to a transaction from exercising all their rights and obligations under the transaction documents. This document cannot be reproduced except in full, without prior written approval of the Company. Any unauthorized alteration, forgery or falsification of the content or appearance of this document is unlawful and offenders may be prosecuted to the fullest extent of the law.

8.6.2 Duty Cycle test plots

802.11b_20MHz_Chain0_2412MHz

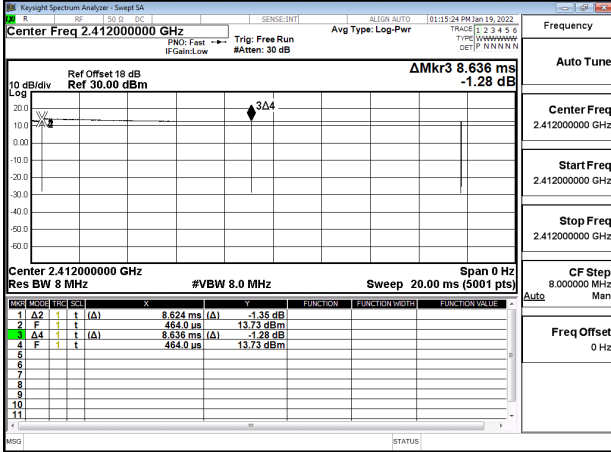

802.11n_40MHz_Chain0_2422MHz

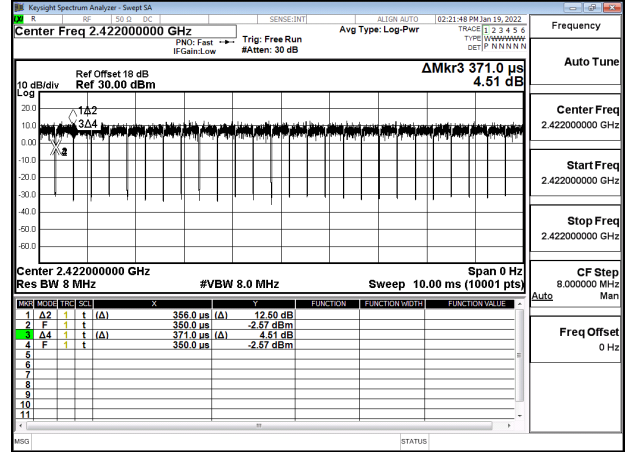

802.11g_20MHz_Chain0_2412MHz

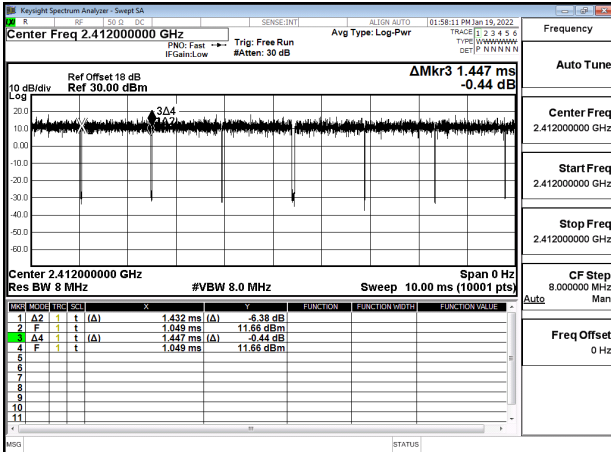

802.11ac_20MHz_Chain0_2412MHz

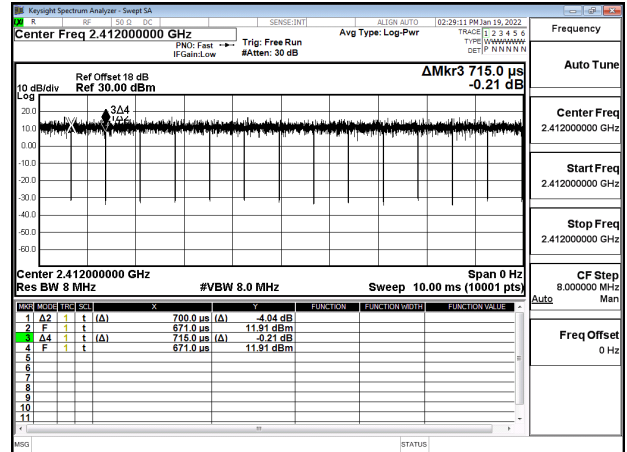

802.11n_20MHz_Chain0_2412MHz

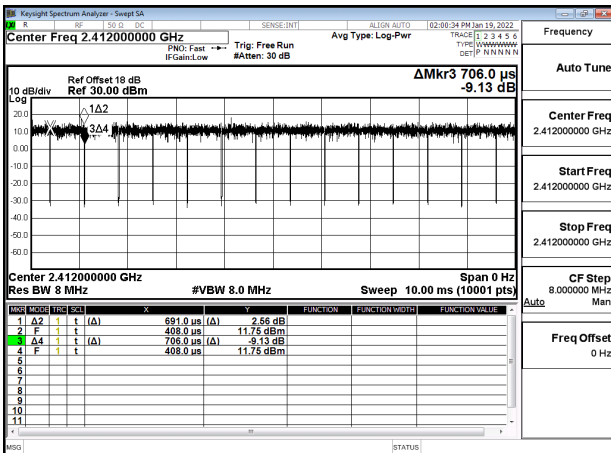

802.11ac_40MHz_Chain0_2422MHz

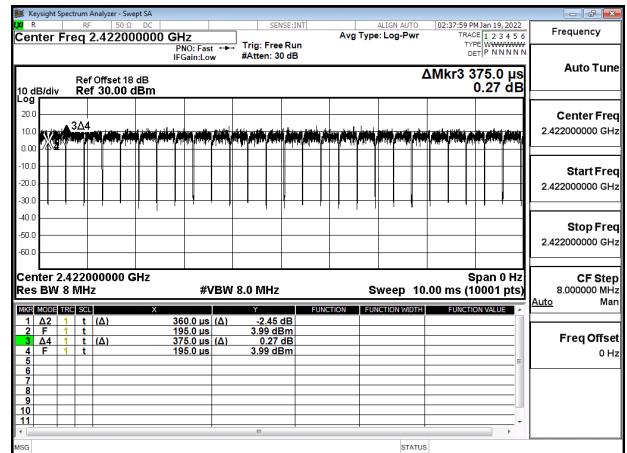

Unless otherwise stated the results shown in this test report refer only to the sample(s) tested and such sample(s) are retained for 90 days only.

除非另有說明，此報告結果僅對測試之樣品負責，同時此樣品僅保留90天。本報告未經本公司書面許可，不可部份複製。

This document is issued by the Company subject to its General Conditions of Service printed overleaf, available on request or accessible at <http://www.sgs.com.tw/Terms-and-Conditions> and for electronic format documents, subject to Terms and Conditions for Electronic Documents at <http://www.sgs.com.tw/Terms-and-Conditions>. Attention is drawn to the limitation of liability, indemnification and jurisdiction issues defined therein. Any holder of this document is advised that information contained herein reflects the Company's findings at the time of its intervention only and within the limits of Client's instructions, if any. The Company's sole responsibility is to its Client and this document does not exonerate parties to a transaction from exercising all their rights and obligations under the transaction documents. This document cannot be reproduced except in full, without prior written approval of the Company. Any unauthorized alteration, forgery or falsification of the content or appearance of this document is unlawful and offenders may be prosecuted to the fullest extent of the law.

802.11ax_20MHz_Chain0_2412MHz

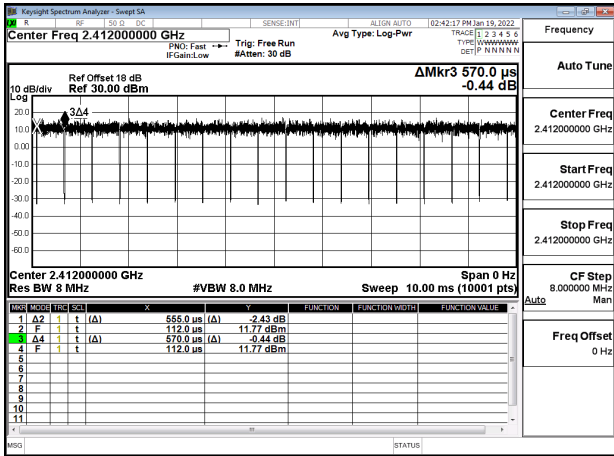

802.11ax_40MHz_Chain0_2422MHz

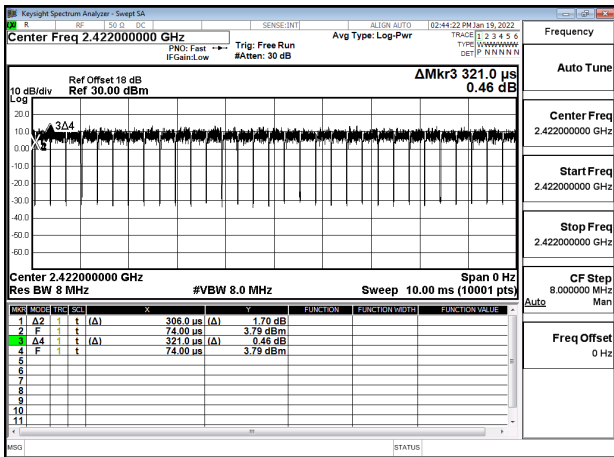

Unless otherwise stated the results shown in this test report refer only to the sample(s) tested and such sample(s) are retained for 90 days only.

除非另有說明，此報告結果僅對測試之樣品負責，同時此樣品僅保留90天。本報告未經本公司書面許可，不可部份複製。

This document is issued by the Company subject to its General Conditions of Service printed overleaf, available on request or accessible at <http://www.sgs.com.tw/Terms-and-Conditions> and for electronic format documents, subject to Terms and Conditions for Electronic Documents at <http://www.sgs.com.tw/Terms-and-Conditions>. Attention is drawn to the limitation of liability, indemnification and jurisdiction issues defined therein. Any holder of this document is advised that information contained hereon reflects the Company's findings at the time of its intervention only and within the limits of Client's instructions, if any. The Company's sole responsibility is to its Client and this document does not exonerate parties to a transaction from exercising all their rights and obligations under the transaction documents. This document cannot be reproduced except in full, without prior written approval of the Company. Any unauthorized alteration, forgery or falsification of the content or appearance of this document is unlawful and offenders may be prosecuted to the fullest extent of the law.

8.6.3 Output Power

802.11b Ch0						
CH	Freq. (MHz)	Data Rate	Power set	Peak Output Power (dBm)	Limit (dBm)	RESULT
1	2412	1	16	18.52	30.00	PASS
2	2417	1	20	22.40	30.00	PASS
6	2437	1	19.5	22.26	30.00	PASS
10	2457	1	20	22.42	30.00	PASS
11	2462	1	15.5	18.31	30.00	PASS
802.11b Ch0						
CH	Freq. (MHz)	Data Rate	Power set	Max. Avg. Output include tune up tolerance Power (dBm)	Limit (dBm)	RESULT
1	2412	1	16	15.76	30.00	PASS
2	2417	1	20	19.88	30.00	PASS
6	2437	1	19.5	19.78	30.00	PASS
10	2457	1	20	19.84	30.00	PASS
11	2462	1	15.5	15.74	30.00	PASS
802.11b Ch1						
CH	Freq. (MHz)	Data Rate	Power set	Peak Output Power (dBm)	Limit (dBm)	RESULT
1	2412	1	16	18.31	30.00	PASS
2	2417	1	20	22.15	30.00	PASS
6	2437	1	19.5	22.01	30.00	PASS
10	2457	1	20	22.17	30.00	PASS
11	2462	1	15.5	18.05	30.00	PASS
802.11b Ch1						
CH	Freq. (MHz)	Data Rate	Power set	Max. Avg. Output include tune up tolerance Power (dBm)	Limit (dBm)	RESULT
1	2412	1	16	15.69	30.00	PASS
2	2417	1	20	19.76	30.00	PASS
6	2437	1	19.5	19.63	30.00	PASS
10	2457	1	20	19.73	30.00	PASS
11	2462	1	15.5	15.63	30.00	PASS

Unless otherwise stated the results shown in this test report refer only to the sample(s) tested and such sample(s) are retained for 90 days only.

除非另有說明，此報告結果僅對測試之樣品負責，同時此樣品僅保留90天。本報告未經本公司書面許可，不可部份複製。

This document is issued by the Company subject to its General Conditions of Service printed overleaf, available on request or accessible at <http://www.sgs.com.tw/Terms-and-Conditions> and for electronic format documents, subject to Terms and Conditions for Electronic Documents at <http://www.sgs.com.tw/Terms-and-Conditions>. Attention is drawn to the limitation of liability, indemnification and jurisdiction issues defined therein. Any holder of this document is advised that information contained hereon reflects the Company's findings at the time of its intervention only and within the limits of Client's instructions, if any. The Company's sole responsibility is to its Client and this document does not exonerate parties to a transaction from exercising all their rights and obligations under the transaction documents. This document cannot be reproduced except in full, without prior written approval of the Company. Any unauthorized alteration, forgery or falsification of the content or appearance of this document is unlawful and offenders may be prosecuted to the fullest extent of the law.

802.11b_2TX								
CH	Freq. (MHz)	Data Rate	Power set	Peak Output Power		Total Peak Output Power (dBm)	Limit (dBm)	RESULT
				CH 0	CH 1			
1	2412	1	16	18.66	18.32	21.50	29.79	PASS
2	2417	1	20	22.43	22.14	25.30	29.79	PASS
6	2437	1	20	22.67	22.33	25.51	29.79	PASS
10	2457	1	20	22.51	21.97	25.26	29.79	PASS
11	2462	1	16	18.75	18.33	21.56	29.79	PASS

802.11b_2TX								
CH	Freq. (MHz)	Data Rate	Power set	Avg. Output Power (dBm)		Max. Avg. Output include tune up tolerance Power (dBm)	Limit (dBm)	RESULT
				CH 0	CH 1			
1	2412	1	16	15.85	15.68	18.79	29.79	PASS
2	2417	1	20	20.06	19.72	22.91	29.79	PASS
6	2437	1	20	19.93	19.71	22.84	29.79	PASS
10	2457	1	20	19.96	19.80	22.90	29.79	PASS
11	2462	1	16	15.91	15.75	18.85	29.79	PASS

802.11g Ch0							
CH	Freq. (MHz)	Data Rate	Power set	Peak Output Power (dBm)		Limit (dBm)	RESULT
1	2412	6	11.5	20.94		30.00	PASS
2	2417	6	19	25.12		30.00	PASS
6	2437	6	18.5	25.04		30.00	PASS
10	2457	6	19	24.99		30.00	PASS
11	2462	6	11.5	20.79		30.00	PASS

802.11g Ch0							
CH	Freq. (MHz)	Data Rate	Power set	Max. Avg. Output include tune up tolerance Power (dBm)		Limit (dBm)	RESULT
1	2412	6	11.5	11.83		30.00	PASS
2	2417	6	19	18.82		30.00	PASS
6	2437	6	18.5	18.79		30.00	PASS
10	2457	6	19	18.76		30.00	PASS
11	2462	6	11.5	11.77		30.00	PASS

Unless otherwise stated the results shown in this test report refer only to the sample(s) tested and such sample(s) are retained for 90 days only.

除非另有說明，此報告結果僅對測試之樣品負責，同時此樣品僅保留90天。本報告未經本公司書面許可，不可部份複製。

This document is issued by the Company subject to its General Conditions of Service printed overleaf, available on request or accessible at <http://www.sgs.com.tw/Terms-and-Conditions> and for electronic format documents, subject to Terms and Conditions for Electronic Documents at <http://www.sgs.com.tw/Terms-and-Conditions>. Attention is drawn to the limitation of liability, indemnification and jurisdiction issues defined therein. Any holder of this document is advised that information contained hereon reflects the Company's findings at the time of its intervention only and within the limits of Client's instructions, if any. The Company's sole responsibility is to its Client and this document does not exonerate parties to a transaction from exercising all their rights and obligations under the transaction documents. This document cannot be reproduced except in full, without prior written approval of the Company. Any unauthorized alteration, forgery or falsification of the content or appearance of this document is unlawful and offenders may be prosecuted to the fullest extent of the law.

802.11g Ch1						
CH	Freq. (MHz)	Data Rate	Power set	Peak Output Power (dBm)	Limit (dBm)	RESULT
1	2412	6	11.5	20.65	30.00	PASS
2	2417	6	19	24.84	30.00	PASS
6	2437	6	18.5	24.81	30.00	PASS
10	2457	6	19	24.73	30.00	PASS
11	2462	6	11.5	20.52	30.00	PASS

802.11g Ch1						
CH	Freq. (MHz)	Data Rate	Power set	Max. Avg. Output include tune up tolerance Power (dBm)	Limit (dBm)	RESULT
1	2412	6	11.5	11.69	30.00	PASS
2	2417	6	19	18.70	30.00	PASS
6	2437	6	18.5	18.66	30.00	PASS
10	2457	6	19	18.64	30.00	PASS
11	2462	6	11.5	11.65	30.00	PASS

802.11g_2TX								
CH	Freq. (MHz)	Data Rate	Power set	Peak Output Power		Total Peak Output Power (dBm)	Limit (dBm)	RESULT
				CH 0	CH 1			
1	2412	6	12	21.76	21.52	24.65	29.79	PASS
2	2417	6	18.5	24.53	24.73	27.64	29.79	PASS
6	2437	6	18.5	24.52	24.71	27.63	29.79	PASS
10	2457	6	19	24.73	24.50	27.63	29.79	PASS
11	2462	6	12	21.20	21.12	24.17	29.79	PASS

802.11g_2TX								
CH	Freq. (MHz)	Data Rate	Power set	Avg. Output Power (dBm)		Max. Avg. Output include tune up tolerance Power (dBm)	Limit (dBm)	RESULT
				CH 0	CH 1			
1	2412	6	12	11.87	11.73	14.86	29.79	PASS
2	2417	6	18.5	18.85	18.70	21.84	29.79	PASS
6	2437	6	18.5	18.89	18.75	21.88	29.79	PASS
10	2457	6	19	19.03	18.67	21.91	29.79	PASS
11	2462	6	12	11.84	11.71	14.84	29.79	PASS

Unless otherwise stated the results shown in this test report refer only to the sample(s) tested and such sample(s) are retained for 90 days only.

除非另有說明，此報告結果僅對測試之樣品負責，同時此樣品僅保留90天。本報告未經本公司書面許可，不可部份複製。

This document is issued by the Company subject to its General Conditions of Service printed overleaf, available on request or accessible at <http://www.sgs.com.tw/Terms-and-Conditions> and for electronic format documents, subject to Terms and Conditions for Electronic Documents at <http://www.sgs.com.tw/Terms-and-Conditions>. Attention is drawn to the limitation of liability, indemnification and jurisdiction issues defined therein. Any holder of this document is advised that information contained hereon reflects the Company's findings at the time of its intervention only and within the limits of Client's instructions, if any. The Company's sole responsibility is to its Client and this document does not exonerate parties to a transaction from exercising all their rights and obligations under the transaction documents. This document cannot be reproduced except in full, without prior written approval of the Company. Any unauthorized alteration, forgery or falsification of the content or appearance of this document is unlawful and offenders may be prosecuted to the fullest extent of the law.

802.11nHT_20M Ch0						
CH	Freq. (MHz)	Data Rate	Power set	Peak Output Power (dBm)	Limit (dBm)	RESULT
1	2412	MCS0	9.5	18.93	30.00	PASS
2	2417	MCS0	18	25.02	30.00	PASS
6	2437	MCS0	17.5	24.90	30.00	PASS
10	2457	MCS0	18	24.90	30.00	PASS
11	2462	MCS0	11.5	20.98	30.00	PASS
802.11nHT_20M Ch0						
CH	Freq. (MHz)	Data Rate	Power set	Max. Avg. Output include tune up tolerance Power (dBm)	Limit (dBm)	RESULT
1	2412	MCS0	9.5	9.84	30.00	PASS
2	2417	MCS0	18	17.80	30.00	PASS
6	2437	MCS0	17.5	17.86	30.00	PASS
10	2457	MCS0	18	17.83	30.00	PASS
11	2462	MCS0	11.5	11.77	30.00	PASS
802.11nHT_20M Ch1						
CH	Freq. (MHz)	Data Rate	Power set	Peak Output Power (dBm)	Limit (dBm)	RESULT
1	2412	MCS0	9.5	18.54	30.00	PASS
2	2417	MCS0	18	24.67	30.00	PASS
6	2437	MCS0	17.5	24.62	30.00	PASS
10	2457	MCS0	18	24.55	30.00	PASS
11	2462	MCS0	11.5	20.50	30.00	PASS
802.11nHT_20M Ch1						
CH	Freq. (MHz)	Data Rate	Power set	Max. Avg. Output include tune up tolerance Power (dBm)	Limit (dBm)	RESULT
1	2412	MCS0	9.5	9.71	30.00	PASS
2	2417	MCS0	18	17.67	30.00	PASS
6	2437	MCS0	17.5	17.71	30.00	PASS
10	2457	MCS0	18	17.76	30.00	PASS
11	2462	MCS0	11.5	11.65	30.00	PASS

Unless otherwise stated the results shown in this test report refer only to the sample(s) tested and such sample(s) are retained for 90 days only.

除非另有說明，此報告結果僅對測試之樣品負責，同時此樣品僅保留90天。本報告未經本公司書面許可，不可部份複製。

This document is issued by the Company subject to its General Conditions of Service printed overleaf, available on request or accessible at <http://www.sgs.com.tw/Terms-and-Conditions> and for electronic format documents, subject to Terms and Conditions for Electronic Documents at <http://www.sgs.com.tw/Terms-and-Conditions>. Attention is drawn to the limitation of liability, indemnification and jurisdiction issues defined therein. Any holder of this document is advised that information contained hereon reflects the Company's findings at the time of its intervention only and within the limits of Client's instructions, if any. The Company's sole responsibility is to its Client and this document does not exonerate parties to a transaction from exercising all their rights and obligations under the transaction documents. This document cannot be reproduced except in full, without prior written approval of the Company. Any unauthorized alteration, forgery or falsification of the content or appearance of this document is unlawful and offenders may be prosecuted to the fullest extent of the law.

802.11n_HT20M MIMO								
CH	Freq. (MHz)	Data Rate	Power set	Peak Output Power		Total Peak Output Power (dBm)	Limit (dBm)	RESULT
				CH 0	CH 1			
1	2412	MCS8	10	19.77	19.62	22.71	29.79	PASS
2	2417	MCS8	18	24.80	24.42	27.62	29.79	PASS
6	2437	MCS8	17.5	24.71	24.39	27.56	29.79	PASS
10	2457	MCS8	18	24.70	24.37	27.55	29.79	PASS
11	2462	MCS8	12	21.72	21.62	24.68	29.79	PASS

802.11n_HT20M MIMO								
CH	Freq. (MHz)	Data Rate	Power set	Avg. Output Power (dBm)		Max. Avg. Output include tune up tolerance Power (dBm)	Limit (dBm)	RESULT
				CH 0	CH 1			
1	2412	MCS8	10	9.84	9.74	12.89	29.79	PASS
2	2417	MCS8	18	17.86	17.78	20.92	29.79	PASS
6	2437	MCS8	17.5	17.84	17.75	20.90	29.79	PASS
10	2457	MCS8	18	17.92	17.80	20.96	29.79	PASS
11	2462	MCS8	12	11.90	11.74	14.92	29.79	PASS

802.11nHT_40M Ch0						
CH	Freq. (MHz)	Data Rate	Power set	Peak Output Power (dBm)	Limit (dBm)	RESULT
3	2422	MCS0	10.5	20.21	30.00	PASS
4	2427	MCS0	15.5	24.33	30.00	PASS
6	2437	MCS0	15.5	24.34	30.00	PASS
8	2447	MCS0	15.5	24.31	30.00	PASS
9	2452	MCS0	9.5	19.35	30.00	PASS

802.11nHT_40M Ch0						
CH	Freq. (MHz)	Data Rate	Power set	Max. Avg. Output include tune up tolerance Power (dBm)	Limit (dBm)	RESULT
3	2422	MCS0	10.5	10.85	30.00	PASS
4	2427	MCS0	15.5	15.84	30.00	PASS
6	2437	MCS0	15.5	15.88	30.00	PASS
8	2447	MCS0	15.5	15.92	30.00	PASS
9	2452	MCS0	9.5	9.82	30.00	PASS

Unless otherwise stated the results shown in this test report refer only to the sample(s) tested and such sample(s) are retained for 90 days only.

除非另有說明，此報告結果僅對測試之樣品負責，同時此樣品僅保留90天。本報告未經本公司書面許可，不可部份複製。

This document is issued by the Company subject to its General Conditions of Service printed overleaf, available on request or accessible at <http://www.sgs.com.tw/Terms-and-Conditions> and for electronic format documents, subject to Terms and Conditions for Electronic Documents at <http://www.sgs.com.tw/Terms-and-Conditions>. Attention is drawn to the limitation of liability, indemnification and jurisdiction issues defined therein. Any holder of this document is advised that information contained hereon reflects the Company's findings at the time of its intervention only and within the limits of Client's instructions, if any. The Company's sole responsibility is to its Client and this document does not exonerate parties to a transaction from exercising all their rights and obligations under the transaction documents. This document cannot be reproduced except in full, without prior written approval of the Company. Any unauthorized alteration, forgery or falsification of the content or appearance of this document is unlawful and offenders may be prosecuted to the fullest extent of the law.

802.11nHT_40M Ch1						
CH	Freq. (MHz)	Data Rate	Power set	Peak Output Power (dBm)	Limit (dBm)	RESULT
3	2422	MCS0	10.5	19.85	30.00	PASS
4	2427	MCS0	15.5	23.99	30.00	PASS
6	2437	MCS0	15.5	24.01	30.00	PASS
8	2447	MCS0	15.5	23.97	30.00	PASS
9	2452	MCS0	9.5	19.07	30.00	PASS
802.11nHT_40M Ch1						
CH	Freq. (MHz)	Data Rate	Power set	Max. Avg. Output include tune up tolerance Power (dBm)	Limit (dBm)	RESULT
3	2422	MCS0	10.5	10.73	30.00	PASS
4	2427	MCS0	15.5	15.71	30.00	PASS
6	2437	MCS0	15.5	15.80	30.00	PASS
8	2447	MCS0	15.5	15.84	30.00	PASS
9	2452	MCS0	9.5	9.69	30.00	PASS

802.11n_HT40M MIMO								
CH	Freq. (MHz)	Data Rate	Power set	Peak Output Power		Total Peak Output Power (dBm)	Limit (dBm)	RESULT
				CH 0	CH 1			
3	2422	MCS8	10.5	20.80	20.62	23.72	29.79	PASS
4	2427	MCS8	16	24.28	24.26	27.28	29.79	PASS
6	2437	MCS8	15.5	24.11	24.17	27.15	29.79	PASS
8	2447	MCS8	15.5	24.06	24.17	27.13	29.79	PASS
9	2452	MCS8	9	19.92	19.80	22.87	29.79	PASS
802.11n_HT40M MIMO								
CH	Freq. (MHz)	Data Rate	Power set	Avg. Output Power (dBm)		Max. Avg. Output include tune up tolerance Power (dBm)	Limit (dBm)	RESULT
				CH 0	CH 1			
3	2422	MCS8	10.5	10.74	10.64	13.88	29.79	PASS
4	2427	MCS8	16	15.76	15.65	18.90	29.79	PASS
6	2437	MCS8	15.5	15.79	15.69	18.93	29.79	PASS
8	2447	MCS8	15.5	15.82	15.68	18.94	29.79	PASS
9	2452	MCS8	9	9.82	9.66	12.93	29.79	PASS

Unless otherwise stated the results shown in this test report refer only to the sample(s) tested and such sample(s) are retained for 90 days only.

除非另有說明，此報告結果僅對測試之樣品負責，同時此樣品僅保留90天。本報告未經本公司書面許可，不可部份複製。

This document is issued by the Company subject to its General Conditions of Service printed overleaf, available on request or accessible at <http://www.sgs.com.tw/Terms-and-Conditions> and for electronic format documents, subject to Terms and Conditions for Electronic Documents at <http://www.sgs.com.tw/Terms-and-Conditions>. Attention is drawn to the limitation of liability, indemnification and jurisdiction issues defined therein. Any holder of this document is advised that information contained hereon reflects the Company's findings at the time of its intervention only and within the limits of Client's instructions, if any. The Company's sole responsibility is to its Client and this document does not exonerate parties to a transaction from exercising all their rights and obligations under the transaction documents. This document cannot be reproduced except in full, without prior written approval of the Company. Any unauthorized alteration, forgery or falsification of the content or appearance of this document is unlawful and offenders may be prosecuted to the fullest extent of the law.

802.11ac_VHT_20M Ch0						
CH	Freq. (MHz)	Data Rate	Power set	Peak Output Power (dBm)	Limit (dBm)	RESULT
1	2412	MCS0	9.5	21.29	30.00	PASS
2	2417	MCS0	18	24.85	30.00	PASS
6	2437	MCS0	17.5	24.75	30.00	PASS
10	2457	MCS0	18	24.81	30.00	PASS
11	2462	MCS0	11.5	20.89	30.00	PASS

802.11ac_VHT_20M Ch0						
CH	Freq. (MHz)	Data Rate	Power set	Max. Avg. Output include tune up tolerance Power (dBm)	Limit (dBm)	RESULT
1	2412	MCS0	9.5	9.81	30.00	PASS
2	2417	MCS0	18	17.77	30.00	PASS
6	2437	MCS0	17.5	17.79	30.00	PASS
10	2457	MCS0	18	17.81	30.00	PASS
11	2462	MCS0	11.5	11.73	30.00	PASS

802.11ac_VHT_20M Ch1						
CH	Freq. (MHz)	Data Rate	Power set	Peak Output Power (dBm)	Limit (dBm)	RESULT
1	2412	MCS0	9.5	20.82	30.00	PASS
2	2417	MCS0	18	24.51	30.00	PASS
6	2437	MCS0	17.5	24.34	30.00	PASS
10	2457	MCS0	18	24.42	30.00	PASS
11	2462	MCS0	11.5	20.59	30.00	PASS

802.11ac_VHT_20M Ch1						
CH	Freq. (MHz)	Data Rate	Power set	Max. Avg. Output include tune up tolerance Power (dBm)	Limit (dBm)	RESULT
1	2412	MCS0	9.5	9.66	30.00	PASS
2	2417	MCS0	18	17.63	30.00	PASS
6	2437	MCS0	17.5	17.61	30.00	PASS
10	2457	MCS0	18	17.70	30.00	PASS
11	2462	MCS0	11.5	11.60	30.00	PASS

Unless otherwise stated the results shown in this test report refer only to the sample(s) tested and such sample(s) are retained for 90 days only.

除非另有說明，此報告結果僅對測試之樣品負責，同時此樣品僅保留90天。本報告未經本公司書面許可，不可部份複製。

This document is issued by the Company subject to its General Conditions of Service printed overleaf, available on request or accessible at <http://www.sgs.com.tw/Terms-and-Conditions> and for electronic format documents, subject to Terms and Conditions for Electronic Documents at <http://www.sgs.com.tw/Terms-and-Conditions>. Attention is drawn to the limitation of liability, indemnification and jurisdiction issues defined therein. Any holder of this document is advised that information contained hereon reflects the Company's findings at the time of its intervention only and within the limits of Client's instructions, if any. The Company's sole responsibility is to its Client and this document does not exonerate parties to a transaction from exercising all their rights and obligations under the transaction documents. This document cannot be reproduced except in full, without prior written approval of the Company. Any unauthorized alteration, forgery or falsification of the content or appearance of this document is unlawful and offenders may be prosecuted to the fullest extent of the law.

802.11ac_VHT20M MIMO								
CH	Freq. (MHz)	Data Rate	Power set	Peak Output Power		Total Peak Output Power (dBm)	Limit (dBm)	RESULT
				CH 0	CH 1			
1	2412	MCS8	10	19.72	19.58	22.66	29.79	PASS
2	2417	MCS8	18	24.73	21.34	26.37	29.79	PASS
6	2437	MCS8	17.5	21.66	24.32	26.20	29.79	PASS
10	2457	MCS8	18	24.65	24.35	27.51	29.79	PASS
11	2462	MCS8	12	21.70	21.59	24.66	29.79	PASS

802.11ac_VHT20M MIMO								
CH	Freq. (MHz)	Data Rate	Power set	Avg. Output Power (dBm)		Max. Avg. Output include tune up tolerance Power (dBm)	Limit (dBm)	RESULT
				CH 0	CH 1			
1	2412	MCS8	10	9.81	9.69	12.85	29.79	PASS
2	2417	MCS8	18	17.79	17.69	20.84	29.79	PASS
6	2437	MCS8	17.5	17.81	17.72	20.87	29.79	PASS
10	2457	MCS8	18	17.80	17.67	20.84	29.79	PASS
11	2462	MCS8	12	11.77	11.64	14.81	29.79	PASS

802.11ac_VHT_40M Ch0						
CH	Freq. (MHz)	Data Rate	Power set	Peak Output Power (dBm)	Limit (dBm)	RESULT
3	2422	MCS0	10.5	20.11	30.00	PASS
4	2427	MCS0	15.5	24.27	30.00	PASS
6	2437	MCS0	15.5	24.30	30.00	PASS
8	2447	MCS0	15.5	24.24	30.00	PASS
9	2452	MCS0	9.5	19.25	30.00	PASS

802.11ac_VHT_40M Ch0						
CH	Freq. (MHz)	Data Rate	Power set	Max. Avg. Output include tune up tolerance Power (dBm)	Limit (dBm)	RESULT
3	2422	MCS0	10.5	10.80	30.00	PASS
4	2427	MCS0	15.5	15.79	30.00	PASS
6	2437	MCS0	15.5	15.84	30.00	PASS
8	2447	MCS0	15.5	15.82	30.00	PASS
9	2452	MCS0	9.5	9.76	30.00	PASS

Unless otherwise stated the results shown in this test report refer only to the sample(s) tested and such sample(s) are retained for 90 days only.

除非另有說明，此報告結果僅對測試之樣品負責，同時此樣品僅保留90天。本報告未經本公司書面許可，不可部份複製。

This document is issued by the Company subject to its General Conditions of Service printed overleaf, available on request or accessible at <http://www.sgs.com.tw/Terms-and-Conditions> and for electronic format documents, subject to Terms and Conditions for Electronic Documents at <http://www.sgs.com.tw/Terms-and-Conditions>. Attention is drawn to the limitation of liability, indemnification and jurisdiction issues defined therein. Any holder of this document is advised that information contained hereon reflects the Company's findings at the time of its intervention only and within the limits of Client's instructions, if any. The Company's sole responsibility is to its Client and this document does not exonerate parties to a transaction from exercising all their rights and obligations under the transaction documents. This document cannot be reproduced except in full, without prior written approval of the Company. Any unauthorized alteration, forgery or falsification of the content or appearance of this document is unlawful and offenders may be prosecuted to the fullest extent of the law.

802.11ac_VHT_40M Ch1						
CH	Freq. (MHz)	Data Rate	Power set	Peak Output Power (dBm)	Limit (dBm)	RESULT
3	2422	MCS0	10.5	19.71	30.00	PASS
4	2427	MCS0	15.5	23.85	30.00	PASS
6	2437	MCS0	15.5	23.94	30.00	PASS
8	2447	MCS0	15.5	23.85	30.00	PASS
9	2452	MCS0	9.5	18.86	30.00	PASS

802.11ac_VHT_40M Ch1						
CH	Freq. (MHz)	Data Rate	Power set	Max. Avg. Output include tune up tolerance Power (dBm)	Limit (dBm)	RESULT
3	2422	MCS0	10.5	10.68	30.00	PASS
4	2427	MCS0	15.5	15.68	30.00	PASS
6	2437	MCS0	15.5	15.75	30.00	PASS
8	2447	MCS0	15.5	15.76	30.00	PASS
9	2452	MCS0	9.5	9.63	30.00	PASS

802.11ac_VHT40M MIMO								
CH	Freq. (MHz)	Data Rate	Power set	Peak Output Power		Total Peak Output Power (dBm)	Limit (dBm)	RESULT
				CH 0	CH 1			
3	2422	MCS8	10.5	20.72	20.57	23.66	29.79	PASS
4	2427	MCS8	16	24.15	24.15	27.16	29.79	PASS
6	2437	MCS8	15.5	24.08	24.11	27.11	29.79	PASS
8	2447	MCS8	15.5	24.00	24.06	27.04	29.79	PASS
9	2452	MCS8	9	19.85	19.71	22.79	29.79	PASS

802.11ac_VHT40M MIMO								
CH	Freq. (MHz)	Data Rate	Power set	Avg. Output Power (dBm)		Max. Avg. Output include tune up tolerance Power (dBm)	Limit (dBm)	RESULT
				CH 0	CH 1			
3	2422	MCS8	10.5	10.72	10.61	13.86	29.79	PASS
4	2427	MCS8	16	15.72	15.59	18.85	29.79	PASS
6	2437	MCS8	15.5	15.74	15.62	18.87	29.79	PASS
8	2447	MCS8	15.5	15.73	15.61	18.86	29.79	PASS
9	2452	MCS8	9	9.75	9.63	12.88	29.79	PASS

Unless otherwise stated the results shown in this test report refer only to the sample(s) tested and such sample(s) are retained for 90 days only.

除非另有說明，此報告結果僅對測試之樣品負責，同時此樣品僅保留90天。本報告未經本公司書面許可，不可部份複製。

This document is issued by the Company subject to its General Conditions of Service printed overleaf, available on request or accessible at <http://www.sgs.com.tw/Terms-and-Conditions> and for electronic format documents, subject to Terms and Conditions for Electronic Documents at <http://www.sgs.com.tw/Terms-and-Conditions>. Attention is drawn to the limitation of liability, indemnification and jurisdiction issues defined therein. Any holder of this document is advised that information contained hereon reflects the Company's findings at the time of its intervention only and within the limits of Client's instructions, if any. The Company's sole responsibility is to its Client and this document does not exonerate parties to a transaction from exercising all their rights and obligations under the transaction documents. This document cannot be reproduced except in full, without prior written approval of the Company. Any unauthorized alteration, forgery or falsification of the content or appearance of this document is unlawful and offenders may be prosecuted to the fullest extent of the law.

802.11ax_HE_20M Ch0							
CH	Freq. (MHz)	Data Rate	RU Config	Power set	Peak Output Power (dBm)	Limit (dBm)	RESULT
1	2412	MCS0	full	9.5	19.37	30.00	PASS
			26/0	14	20.25	30.00	PASS
			52/37	14	20.33	30.00	PASS
			106/53	14	20.20	30.00	PASS
2	2417	MCS0	full	17.5	25.00	30.00	PASS
6	2437	MCS0	full	17	24.91	30.00	PASS
10	2457	MCS0	full	17.5	24.92	30.00	PASS
11	2462	MCS0	full	11.5	21.59	30.00	PASS
			26/8	15	21.55	30.00	PASS
			52/40	15	21.48	30.00	PASS
			106/54	15	21.44	30.00	PASS
802.11ax_HE_20M Ch0							
CH	Freq. (MHz)	Data Rate	RU Config	Power set	Max. Avg. Output include tune up tolerance Power (dBm)	Limit (dBm)	RESULT
1	2412	MCS0	full	9.5	9.80	30.00	PASS
			26/0	14	9.75	30.00	PASS
			52/37	14	9.69	30.00	PASS
			106/53	14	9.72	30.00	PASS
2	2417	MCS0	full	17.5	17.80	30.00	PASS
6	2437	MCS0	full	17	17.76	30.00	PASS
10	2457	MCS0	full	17.5	17.83	30.00	PASS
11	2462	MCS0	full	11.5	11.84	30.00	PASS
			26/8	15	11.81	30.00	PASS
			52/40	15	11.76	30.00	PASS
			106/54	15	11.79	30.00	PASS

Unless otherwise stated the results shown in this test report refer only to the sample(s) tested and such sample(s) are retained for 90 days only.

除非另有說明，此報告結果僅對測試之樣品負責，同時此樣品僅保留90天。本報告未經本公司書面許可，不可部份複製。

This document is issued by the Company subject to its General Conditions of Service printed overleaf, available on request or accessible at <http://www.sgs.com.tw/Terms-and-Conditions> and for electronic format documents, subject to Terms and Conditions for Electronic Documents at <http://www.sgs.com.tw/Terms-and-Conditions>. Attention is drawn to the limitation of liability, indemnification and jurisdiction issues defined therein. Any holder of this document is advised that information contained hereon reflects the Company's findings at the time of its intervention only and within the limits of Client's instructions, if any. The Company's sole responsibility is to its Client and this document does not exonerate parties to a transaction from exercising all their rights and obligations under the transaction documents. This document cannot be reproduced except in full, without prior written approval of the Company. Any unauthorized alteration, forgery or falsification of the content or appearance of this document is unlawful and offenders may be prosecuted to the fullest extent of the law.

802.11ax_HE_20M Ch1							
CH	Freq. (MHz)	Data Rate	RU Config	Power set	Peak Output Power (dBm)	Limit (dBm)	RESULT
1	2412	MCS0	full	9.5	19.25	30.00	PASS
			26/0	14	20.12	30.00	PASS
			52/37	14	20.23	30.00	PASS
			106/53	14	20.06	30.00	PASS
2	2417	MCS0	full	17.5	24.62	30.00	PASS
6	2437	MCS0	full	17	24.57	30.00	PASS
10	2457	MCS0	full	17.5	24.55	30.00	PASS
11	2462	MCS0	full	11.5	21.13	30.00	PASS
			26/8	15	21.43	30.00	PASS
			52/40	15	21.35	30.00	PASS
			106/54	15	21.31	30.00	PASS
802.11ax_HE_20M Ch1							
CH	Freq. (MHz)	Data Rate	RU Config	Power set	Max. Avg. Output include tune up tolerance Power (dBm)	Limit (dBm)	RESULT
1	2412	MCS0	full	9.5	9.63	30.00	PASS
			26/0	14	9.61	30.00	PASS
			52/37	14	9.56	30.00	PASS
			106/53	14	9.59	30.00	PASS
2	2417	MCS0	full	17.5	17.66	30.00	PASS
6	2437	MCS0	full	17	17.70	30.00	PASS
10	2457	MCS0	full	17.5	11.73	30.00	PASS
11	2462	MCS0	full	11.5	11.66	30.00	PASS
			26/8	15	11.64	30.00	PASS
			52/40	15	11.58	30.00	PASS
			106/54	15	11.61	30.00	PASS

Unless otherwise stated the results shown in this test report refer only to the sample(s) tested and such sample(s) are retained for 90 days only.

除非另有說明，此報告結果僅對測試之樣品負責，同時此樣品僅保留90天。本報告未經本公司書面許可，不可部份複製。

This document is issued by the Company subject to its General Conditions of Service printed overleaf, available on request or accessible at <http://www.sgs.com.tw/Terms-and-Conditions> and for electronic format documents, subject to Terms and Conditions for Electronic Documents at <http://www.sgs.com.tw/Terms-and-Conditions>. Attention is drawn to the limitation of liability, indemnification and jurisdiction issues defined therein. Any holder of this document is advised that information contained hereon reflects the Company's findings at the time of its intervention only and within the limits of Client's instructions, if any. The Company's sole responsibility is to its Client and this document does not exonerate parties to a transaction from exercising all their rights and obligations under the transaction documents. This document cannot be reproduced except in full, without prior written approval of the Company. Any unauthorized alteration, forgery or falsification of the content or appearance of this document is unlawful and offenders may be prosecuted to the fullest extent of the law.

802.11ax_HE20M MIMO									
CH	Freq. (MHz)	Data Rate	RU Config	Power set	Peak Output Power		Total Peak Output Power (dBm)	Limit (dBm)	RESULT
					CH 0	CH 1			
1	2412	MCS0	full	9.5	19.74	19.52	22.64	29.79	PASS
			26/0	13.5	20.45	20.08	23.28	29.79	PASS
			52/37	14	20.53	20.18	23.37	29.79	PASS
			106/53	14	20.39	20.02	23.22	29.79	PASS
2	2417	MCS0	full	17.5	24.74	24.36	27.56	29.79	PASS
6	2437	MCS0	full	17.5	24.73	24.36	27.56	29.79	PASS
10	2457	MCS0	full	17.5	24.65	24.36	27.52	29.79	PASS
11	2462	MCS0	full	11.5	21.77	21.54	24.67	29.79	PASS
			26/8	15.5	21.70	21.47	24.60	29.79	PASS
			52/40	15.5	21.66	21.40	24.54	29.79	PASS
			106/54	15.5	21.62	21.35	24.50	29.79	PASS
802.11ax_HE20M MIMO									
CH	Freq. (MHz)	Data Rate	RU Config	Power set	Avg. Output Power (dBm)		Max. Avg. Output include tune up tolerance Power (dBm)	Limit (dBm)	RESULT
					CH 0	CH 1			
1	2412	MCS0	full	9.5	9.90	9.63	12.90	29.79	PASS
			26/0	13.5	9.80	9.46	12.76	29.79	PASS
			52/37	14	9.85	9.55	12.83	29.79	PASS
			106/53	14	9.76	9.40	12.71	29.79	PASS
2	2417	MCS0	full	17.5	17.82	17.69	20.89	29.79	PASS
6	2437	MCS0	full	17.5	17.84	17.77	20.94	29.79	PASS
10	2457	MCS0	full	17.5	17.87	17.66	20.90	29.79	PASS
11	2462	MCS0	full	11.5	11.87	11.64	14.89	29.79	PASS
			26/8	15.5	11.80	11.54	14.80	29.79	PASS
			52/40	15.5	11.76	11.45	14.74	29.79	PASS
			106/54	15.5	11.67	11.38	14.66	29.79	PASS

Unless otherwise stated the results shown in this test report refer only to the sample(s) tested and such sample(s) are retained for 90 days only.

除非另有說明，此報告結果僅對測試之樣品負責，同時此樣品僅保留90天。本報告未經本公司書面許可，不可部份複製。

This document is issued by the Company subject to its General Conditions of Service printed overleaf, available on request or accessible at <http://www.sgs.com.tw/Terms-and-Conditions> and for electronic format documents, subject to Terms and Conditions for Electronic Documents at <http://www.sgs.com.tw/Terms-and-Conditions>. Attention is drawn to the limitation of liability, indemnification and jurisdiction issues defined therein. Any holder of this document is advised that information contained hereon reflects the Company's findings at the time of its intervention only and within the limits of Client's instructions, if any. The Company's sole responsibility is to its Client and this document does not exonerate parties to a transaction from exercising all their rights and obligations under the transaction documents. This document cannot be reproduced except in full, without prior written approval of the Company. Any unauthorized alteration, forgery or falsification of the content or appearance of this document is unlawful and offenders may be prosecuted to the fullest extent of the law.

802.11ax_HE_40M Ch0							
CH	Freq. (MHz)	Data Rate	RU Config	Power set	Peak Output Power (dBm)	Limit (dBm)	RESULT
3	2422	MCS0	full	10.5	20.80	30.00	PASS
			242/61	14.5	20.75	30.00	PASS
4	2427	MCS0	full	15.5	24.42	30.00	PASS
6	2437	MCS0	full	15	24.20	30.00	PASS
8	2447	MCS0	full	15	24.13	30.00	PASS
9	2452	MCS0	full	9.5	19.95	30.00	PASS
			242/62	12	19.25	30.00	PASS
802.11ax_HE_40M Ch0							
CH	Freq. (MHz)	Data Rate	RU Config	Power set	Max. Avg. Output include tune up tolerance Power (dBm)	Limit (dBm)	RESULT
3	2422	MCS0	full	10.5	10.85	30.00	PASS
			242/61	14.5	10.81	30.00	PASS
4	2427	MCS0	full	15.5	15.87	30.00	PASS
6	2437	MCS0	full	15	15.82	30.00	PASS
8	2447	MCS0	full	15	15.91	30.00	PASS
9	2452	MCS0	full	9.5	9.83	30.00	PASS
			242/62	12	8.28	30.00	PASS

Unless otherwise stated the results shown in this test report refer only to the sample(s) tested and such sample(s) are retained for 90 days only.

除非另有說明，此報告結果僅對測試之樣品負責，同時此樣品僅保留90天。本報告未經本公司書面許可，不可部份複製。

This document is issued by the Company subject to its General Conditions of Service printed overleaf, available on request or accessible at <http://www.sgs.com.tw/Terms-and-Conditions> and for electronic format documents, subject to Terms and Conditions for Electronic Documents at <http://www.sgs.com.tw/Terms-and-Conditions>. Attention is drawn to the limitation of liability, indemnification and jurisdiction issues defined therein. Any holder of this document is advised that information contained hereon reflects the Company's findings at the time of its intervention only and within the limits of Client's instructions, if any. The Company's sole responsibility is to its Client and this document does not exonerate parties to a transaction from exercising all their rights and obligations under the transaction documents. This document cannot be reproduced except in full, without prior written approval of the Company. Any unauthorized alteration, forgery or falsification of the content or appearance of this document is unlawful and offenders may be prosecuted to the fullest extent of the law.

802.11ax_HE_40M Ch1							
CH	Freq. (MHz)	Data Rate	RU Config	Power set	Peak Output Power (dBm)	Limit (dBm)	RESULT
3	2422	MCS0	full	10.5	20.62	30.00	PASS
			242/61	14.5	20.59	30.00	PASS
4	2427	MCS0	full	15.5	24.10	30.00	PASS
6	2437	MCS0	full	15	23.82	30.00	PASS
8	2447	MCS0	full	15	23.80	30.00	PASS
9	2452	MCS0	full	9.5	19.83	30.00	PASS
			242/62	12	19.14	30.00	PASS
802.11ax_HE_40M Ch1							
CH	Freq. (MHz)	Data Rate	RU Config	Power set	Max. Avg. Output include tune up tolerance Power (dBm)	Limit (dBm)	RESULT
3	2422	MCS0	full	10.5	10.63	30.00	PASS
			242/61	14.5	10.59	30.00	PASS
4	2427	MCS0	full	15.5	15.75	30.00	PASS
6	2437	MCS0	full	15	15.73	30.00	PASS
8	2447	MCS0	full	15	15.87	30.00	PASS
9	2452	MCS0	full	9.5	9.71	30.00	PASS
			242/62	12	8.13	30.00	PASS

Unless otherwise stated the results shown in this test report refer only to the sample(s) tested and such sample(s) are retained for 90 days only.

除非另有說明，此報告結果僅對測試之樣品負責，同時此樣品僅保留90天。本報告未經本公司書面許可，不可部份複製。

This document is issued by the Company subject to its General Conditions of Service printed overleaf, available on request or accessible at <http://www.sgs.com.tw/Terms-and-Conditions> and for electronic format documents, subject to Terms and Conditions for Electronic Documents at <http://www.sgs.com.tw/Terms-and-Conditions>. Attention is drawn to the limitation of liability, indemnification and jurisdiction issues defined therein. Any holder of this document is advised that information contained hereon reflects the Company's findings at the time of its intervention only and within the limits of Client's instructions, if any. The Company's sole responsibility is to its Client and this document does not exonerate parties to a transaction from exercising all their rights and obligations under the transaction documents. This document cannot be reproduced except in full, without prior written approval of the Company. Any unauthorized alteration, forgery or falsification of the content or appearance of this document is unlawful and offenders may be prosecuted to the fullest extent of the law.

802.11ax_HE40M MIMO									
CH	Freq. (MHz)	Data Rate	RU Config	Power set	Peak Output Power		Total Peak Output Power (dBm)	Limit (dBm)	RESULT
					CH 0	CH 1			
3	2422	MCS0	full	10.5	21.20	20.89	24.06	29.79	PASS
			242/6	14	21.11	20.75	23.94	29.79	PASS
4	2427	MCS0	full	15.5	24.23	24.19	27.22	29.79	PASS
6	2437	MCS0	full	15	24.02	23.86	26.95	29.79	PASS
8	2447	MCS0	full	15	23.87	23.97	26.93	29.79	PASS
9	2452	MCS0	full	9	19.71	19.59	22.66	29.79	PASS
			242/6	11.5	19.45	19.16	22.32	29.79	PASS

802.11ax_HE40M MIMO									
CH	Freq. (MHz)	Data Rate	RU Config	Power set	Avg. Output Power (dBm)		Max. Avg. Output include tune up tolerance Power (dBm)	Limit (dBm)	RESULT
					CH 0	CH 1			
3	2422	MCS0	full	10.5	10.81	10.62	13.94	29.79	PASS
			242/6	14	10.72	10.53	13.85	29.79	PASS
4	2427	MCS0	full	15.5	15.76	15.71	18.96	29.79	PASS
6	2437	MCS0	full	15	15.70	15.65	18.90	29.79	PASS
8	2447	MCS0	full	15	15.68	15.81	18.97	29.79	PASS
9	2452	MCS0	full	9	9.84	9.68	12.98	29.79	PASS
			242/6	11.5	8.21	8.09	11.37	29.79	PASS

Unless otherwise stated the results shown in this test report refer only to the sample(s) tested and such sample(s) are retained for 90 days only.

除非另有說明，此報告結果僅對測試之樣品負責，同時此樣品僅保留90天。本報告未經本公司書面許可，不可部份複製。

This document is issued by the Company subject to its General Conditions of Service printed overleaf, available on request or accessible at <http://www.sgs.com.tw/Terms-and-Conditions> and for electronic format documents, subject to Terms and Conditions for Electronic Documents at <http://www.sgs.com.tw/Terms-and-Conditions>. Attention is drawn to the limitation of liability, indemnification and jurisdiction issues defined therein. Any holder of this document is advised that information contained hereon reflects the Company's findings at the time of its intervention only and within the limits of Client's instructions, if any. The Company's sole responsibility is to its Client and this document does not exonerate parties to a transaction from exercising all their rights and obligations under the transaction documents. This document cannot be reproduced except in full, without prior written approval of the Company. Any unauthorized alteration, forgery or falsification of the content or appearance of this document is unlawful and offenders may be prosecuted to the fullest extent of the law.

802.11b Ch0							
CH	Freq. (MHz)	Data Rate	Avg. Output Power (dBm)	Antenna Gain (dBi)	EIRP (dBm)	Limit (dBm)	RESULT
1	2412	1	15.76	3.20	18.96	36	PASS
2	2417	1	19.88	3.20	23.08	36	PASS
6	2437	1	19.78	3.20	22.98	36	PASS
10	2457	1	19.84	3.20	23.04	36	PASS
11	2462	1	15.74	3.20	18.94	36	PASS

802.11b Ch1							
CH	Freq. (MHz)	Data Rate	Avg. Output Power (dBm)	Antenna Gain (dBi)	EIRP (dBm)	Limit (dBm)	RESULT
1	2412	1	15.69	3.20	18.89	36	PASS
2	2417	1	19.76	3.20	22.96	36	PASS
6	2437	1	19.63	3.20	22.83	36	PASS
10	2457	1	19.73	3.20	22.93	36	PASS
11	2462	1	15.63	3.20	18.83	36	PASS

802.11b_2TX									
CH	Freq. (MHz)	Data Rate	Avg. Output Power		Total Avg. Output Power (dBm)	Antenna Gain (dBi)	EIRP (dBm)	Limit (dBm)	RESULT
			CH 0	CH 1					
1	2412	1	15.85	15.68	18.79	6.21	25.00	36	PASS
2	2417	1	20.06	19.72	22.91	6.21	29.12	36	PASS
6	2437	1	19.93	19.71	22.84	6.21	29.05	36	PASS
10	2457	1	19.96	19.80	22.90	6.21	29.11	36	PASS
11	2462	1	15.91	15.75	18.85	6.21	25.06	36	PASS

802.11g Ch0							
CH	Freq. (MHz)	Data Rate	Avg. Output Power (dBm)	Antenna Gain (dBi)	EIRP (dBm)	Limit (dBm)	RESULT
1	2412	6	11.83	3.20	15.03	36	PASS
2	2417	6	18.82	3.20	22.02	36	PASS
6	2437	6	18.79	3.20	21.99	36	PASS
10	2457	6	18.76	3.20	21.96	36	PASS
11	2462	6	11.77	3.20	14.97	36	PASS

Unless otherwise stated the results shown in this test report refer only to the sample(s) tested and such sample(s) are retained for 90 days only.

除非另有說明，此報告結果僅對測試之樣品負責，同時此樣品僅保留90天。本報告未經本公司書面許可，不可部份複製。

This document is issued by the Company subject to its General Conditions of Service printed overleaf, available on request or accessible at <http://www.sgs.com.tw/Terms-and-Conditions> and for electronic format documents, subject to Terms and Conditions for Electronic Documents at <http://www.sgs.com.tw/Terms-and-Conditions>. Attention is drawn to the limitation of liability, indemnification and jurisdiction issues defined therein. Any holder of this document is advised that information contained hereon reflects the Company's findings at the time of its intervention only and within the limits of Client's instructions, if any. The Company's sole responsibility is to its Client and this document does not exonerate parties to a transaction from exercising all their rights and obligations under the transaction documents. This document cannot be reproduced except in full, without prior written approval of the Company. Any unauthorized alteration, forgery or falsification of the content or appearance of this document is unlawful and offenders may be prosecuted to the fullest extent of the law.

802.11g Ch1							
CH	Freq. (MHz)	Data Rate	Avg. Output Power (dBm)	Antenna Gain (dBi)	EIRP (dBm)	Limit (dBm)	RESULT
1	2412	6	11.69	3.20	14.89	36	PASS
2	2417	6	18.70	3.20	21.90	36	PASS
6	2437	6	18.66	3.20	21.86	36	PASS
10	2457	6	18.64	3.20	21.84	36	PASS
11	2462	6	11.65	3.20	14.85	36	PASS

802.11g_2TX									
CH	Freq. (MHz)	Data Rate	Avg. Output Power		Total Avg. Output Power (dBm)	Antenna Gain (dBi)	EIRP (dBm)	Limit (dBm)	RESULT
			CH 0	CH 1					
1	2412	6	11.87	11.73	14.86	6.21	21.07	36	PASS
2	2417	6	18.85	18.70	21.84	6.21	28.05	36	PASS
6	2437	6	18.89	18.75	21.88	6.21	28.09	36	PASS
10	2457	6	19.03	18.67	21.91	6.21	28.12	36	PASS
11	2462	6	11.84	11.71	14.84	6.21	21.05	36	PASS

802.11nHT_20M Ch0							
CH	Freq. (MHz)	Data Rate	Avg. Output Power (dBm)	Antenna Gain (dBi)	EIRP (dBm)	Limit (dBm)	RESULT
1	2412	MCS0	9.84	3.20	13.04	36	PASS
2	2417	MCS0	17.80	3.20	21.00	36	PASS
6	2437	MCS0	17.86	3.20	21.06	36	PASS
10	2457	MCS0	17.83	3.20	21.03	36	PASS
11	2462	MCS0	11.77	3.20	14.97	36	PASS

802.11nHT_20M Ch1							
CH	Freq. (MHz)	Data Rate	Avg. Output Power (dBm)	Antenna Gain (dBi)	EIRP (dBm)	Limit (dBm)	RESULT
1	2412	MCS0	9.71	3.20	12.91	36	PASS
2	2417	MCS0	17.67	3.20	20.87	36	PASS
6	2437	MCS0	17.71	3.20	20.91	36	PASS
10	2457	MCS0	17.76	3.20	20.96	36	PASS
11	2462	MCS0	11.65	3.20	14.85	36	PASS

Unless otherwise stated the results shown in this test report refer only to the sample(s) tested and such sample(s) are retained for 90 days only.

除非另有說明，此報告結果僅對測試之樣品負責，同時此樣品僅保留90天。本報告未經本公司書面許可，不可部份複製。

This document is issued by the Company subject to its General Conditions of Service printed overleaf, available on request or accessible at <http://www.sgs.com.tw/Terms-and-Conditions> and for electronic format documents, subject to Terms and Conditions for Electronic Documents at <http://www.sgs.com.tw/Terms-and-Conditions>. Attention is drawn to the limitation of liability, indemnification and jurisdiction issues defined therein. Any holder of this document is advised that information contained hereon reflects the Company's findings at the time of its intervention only and within the limits of Client's instructions, if any. The Company's sole responsibility is to its Client and this document does not exonerate parties to a transaction from exercising all their rights and obligations under the transaction documents. This document cannot be reproduced except in full, without prior written approval of the Company. Any unauthorized alteration, forgery or falsification of the content or appearance of this document is unlawful and offenders may be prosecuted to the fullest extent of the law.

802.11n_HT20M MIMO									
CH	Freq. (MHz)	Data Rate	Avg. Output Power		Total Avg. Output Power (dBm)	Antenna Gain (dBi)	EIRP (dBm)	Limit (dBm)	RESULT
			CH 0	CH 1					
1	2412	MCS8	9.84	9.74	12.89	6.21	19.10	36	PASS
2	2417	MCS8	17.86	17.78	20.92	6.21	27.13	36	PASS
6	2437	MCS8	17.84	17.75	20.90	6.21	27.11	36	PASS
10	2457	MCS8	17.92	17.80	20.96	6.21	27.17	36	PASS
11	2462	MCS8	11.90	11.74	14.92	6.21	21.13	36	PASS

802.11nHT_40M Ch0								
CH	Freq. (MHz)	Data Rate	Avg. Output Power (dBm)	Antenna Gain (dBi)	EIRP (dBm)	Limit (dBm)	RESULT	
3	2422	MCS0	10.85	3.20	14.05	36	PASS	
4	2427	MCS0	15.84	3.20	19.04	36	PASS	
6	2437	MCS0	15.88	3.20	19.08	36	PASS	
8	2447	MCS0	15.92	3.20	19.12	36	PASS	
9	2452	MCS0	9.82	3.20	13.02	36	PASS	

802.11nHT_40M Ch1								
CH	Freq. (MHz)	Data Rate	Avg. Output Power (dBm)	Antenna Gain (dBi)	EIRP (dBm)	Limit (dBm)	RESULT	
3	2422	MCS0	10.73	3.20	13.93	36	PASS	
4	2427	MCS0	15.71	3.20	18.91	36	PASS	
6	2437	MCS0	15.80	3.20	19.00	36	PASS	
8	2447	MCS0	15.84	3.20	19.04	36	PASS	
9	2452	MCS0	9.69	3.20	12.89	36	PASS	

802.11n_HT40M MIMO									
CH	Freq. (MHz)	Data Rate	Avg. Output Power		Total Avg. Output Power (dBm)	Antenna Gain (dBi)	EIRP (dBm)	Limit (dBm)	RESULT
			CH 0	CH 1					
3	2422	MCS8	10.74	10.64	13.88	6.21	20.09	36	PASS
4	2427	MCS8	15.76	15.65	18.90	6.21	25.11	36	PASS
6	2437	MCS8	15.79	15.69	18.93	6.21	25.14	36	PASS
8	2447	MCS8	15.82	15.68	18.94	6.21	25.15	36	PASS
9	2452	MCS8	9.82	9.66	12.93	6.21	19.14	36	PASS

Unless otherwise stated the results shown in this test report refer only to the sample(s) tested and such sample(s) are retained for 90 days only.

除非另有說明，此報告結果僅對測試之樣品負責，同時此樣品僅保留90天。本報告未經本公司書面許可，不可部份複製。

This document is issued by the Company subject to its General Conditions of Service printed overleaf, available on request or accessible at <http://www.sgs.com.tw/Terms-and-Conditions> and for electronic format documents, subject to Terms and Conditions for Electronic Documents at <http://www.sgs.com.tw/Terms-and-Conditions>. Attention is drawn to the limitation of liability, indemnification and jurisdiction issues defined therein. Any holder of this document is advised that information contained hereon reflects the Company's findings at the time of its intervention only and within the limits of Client's instructions, if any. The Company's sole responsibility is to its Client and this document does not exonerate parties to a transaction from exercising all their rights and obligations under the transaction documents. This document cannot be reproduced except in full, without prior written approval of the Company. Any unauthorized alteration, forgery or falsification of the content or appearance of this document is unlawful and offenders may be prosecuted to the fullest extent of the law.

802.11ac_VHT_20M Ch0							
CH	Freq. (MHz)	Data Rate	Avg. Output Power (dBm)	Antenna Gain (dBi)	EIRP (dBm)	Limit (dBm)	RESULT
1	2412	MCS0	9.81	3.20	13.01	36	PASS
2	2417	MCS0	17.77	3.20	20.97	36	PASS
6	2437	MCS0	17.79	3.20	20.99	36	PASS
10	2457	MCS0	17.81	3.20	21.01	36	PASS
11	2462	MCS0	11.73	3.20	14.93	36	PASS

802.11ac_VHT_20M Ch1							
CH	Freq. (MHz)	Data Rate	Avg. Output Power (dBm)	Antenna Gain (dBi)	EIRP (dBm)	Limit (dBm)	RESULT
1	2412	MCS0	9.66	3.20	12.86	36	PASS
2	2417	MCS0	17.63	3.20	20.83	36	PASS
6	2437	MCS0	17.61	3.20	20.81	36	PASS
10	2457	MCS0	17.70	3.20	20.90	36	PASS
11	2462	MCS0	11.60	3.20	14.80	36	PASS

802.11ac_VHT20M MIMO									
CH	Freq. (MHz)	Data Rate	Avg. Output Power		Total Avg. Output Power (dBm)	Antenna Gain (dBi)	EIRP (dBm)	Limit (dBm)	RESULT
			CH 0	CH 1					
1	2412	MCS8	9.81	9.69	12.85	6.21	19.06	36	PASS
2	2417	MCS8	17.79	17.69	20.84	6.21	27.05	36	PASS
6	2437	MCS8	17.81	17.72	20.87	6.21	27.08	36	PASS
10	2457	MCS8	17.80	17.67	20.84	6.21	27.05	36	PASS
11	2462	MCS8	11.77	11.64	14.81	6.21	21.02	36	PASS

802.11ac_VHT_40M Ch0							
CH	Freq. (MHz)	Data Rate	Avg. Output Power (dBm)	Antenna Gain (dBi)	EIRP (dBm)	Limit (dBm)	RESULT
3	2422	MCS0	10.80	3.20	14.00	36	PASS
4	2427	MCS0	15.79	3.20	18.99	36	PASS
6	2437	MCS0	15.84	3.20	19.04	36	PASS
8	2447	MCS0	15.82	3.20	19.02	36	PASS
9	2452	MCS0	9.76	3.20	12.96	36	PASS

Unless otherwise stated the results shown in this test report refer only to the sample(s) tested and such sample(s) are retained for 90 days only.

除非另有說明，此報告結果僅對測試之樣品負責，同時此樣品僅保留90天。本報告未經本公司書面許可，不可部份複製。

This document is issued by the Company subject to its General Conditions of Service printed overleaf, available on request or accessible at <http://www.sgs.com.tw/Terms-and-Conditions> and for electronic format documents, subject to Terms and Conditions for Electronic Documents at <http://www.sgs.com.tw/Terms-and-Conditions>. Attention is drawn to the limitation of liability, indemnification and jurisdiction issues defined therein. Any holder of this document is advised that information contained hereon reflects the Company's findings at the time of its intervention only and within the limits of Client's instructions, if any. The Company's sole responsibility is to its Client and this document does not exonerate parties to a transaction from exercising all their rights and obligations under the transaction documents. This document cannot be reproduced except in full, without prior written approval of the Company. Any unauthorized alteration, forgery or falsification of the content or appearance of this document is unlawful and offenders may be prosecuted to the fullest extent of the law.

802.11ac_VHT_40M Ch1							
CH	Freq. (MHz)	Data Rate	Avg. Output Power (dBm)	Antenna Gain (dBi)	EIRP (dBm)	Limit (dBm)	RESULT
3	2422	MCS0	10.68	3.20	13.88	36	PASS
4	2427	MCS0	15.68	3.20	18.88	36	PASS
6	2437	MCS0	15.75	3.20	18.95	36	PASS
8	2447	MCS0	15.76	3.20	18.96	36	PASS
9	2452	MCS0	9.63	3.20	12.83	36	PASS

802.11ac_VHT40M MIMO									
CH	Freq. (MHz)	Data Rate	Avg. Output Power		Total Avg. Output Power (dBm)	Antenna Gain (dBi)	EIRP (dBm)	Limit (dBm)	RESULT
			CH 0	CH 1					
3	2422	MCS8	10.72	10.61	13.86	6.21	20.07	36	PASS
4	2427	MCS8	15.72	15.59	18.85	6.21	25.06	36	PASS
6	2437	MCS8	15.74	15.62	18.87	6.21	25.08	36	PASS
8	2447	MCS8	15.73	15.61	18.86	6.21	25.07	36	PASS
9	2452	MCS8	9.75	9.63	12.88	6.21	19.09	36	PASS

802.11ax_HE_20M Ch0								
CH	Freq. (MHz)	Data Rate	RU Config	Avg. Output Power (dBm)	Antenna Gain (dBi)	EIRP (dBm)	Limit	RESULT
1	2412	MCS0	full	9.80	3.20	13.00	36	PASS
			26/0	9.75	3.20	12.95	36	PASS
			52/37	9.69	3.20	12.89	36	PASS
			106/53	9.72	3.20	12.92	36	PASS
2	2417	MCS0	full	17.80	3.20	21.00	36	PASS
6	2437	MCS0	full	17.76	3.20	20.96	36	PASS
10	2457	MCS0	full	17.83	3.20	21.03	36	PASS
11	2462	MCS0	full	11.84	3.20	15.04	36	PASS
			26/8	11.81	3.20	15.01	36	PASS
			52/40	11.76	3.20	14.96	36	PASS
			106/54	11.79	3.20	14.99	36	PASS

Unless otherwise stated the results shown in this test report refer only to the sample(s) tested and such sample(s) are retained for 90 days only.

除非另有說明，此報告結果僅對測試之樣品負責，同時此樣品僅保留90天。本報告未經本公司書面許可，不可部份複製。

This document is issued by the Company subject to its General Conditions of Service printed overleaf, available on request or accessible at <http://www.sgs.com.tw/Terms-and-Conditions> and for electronic format documents, subject to Terms and Conditions for Electronic Documents at <http://www.sgs.com.tw/Terms-and-Conditions>. Attention is drawn to the limitation of liability, indemnification and jurisdiction issues defined therein. Any holder of this document is advised that information contained hereon reflects the Company's findings at the time of its intervention only and within the limits of Client's instructions, if any. The Company's sole responsibility is to its Client and this document does not exonerate parties to a transaction from exercising all their rights and obligations under the transaction documents. This document cannot be reproduced except in full, without prior written approval of the Company. Any unauthorized alteration, forgery or falsification of the content or appearance of this document is unlawful and offenders may be prosecuted to the fullest extent of the law.

802.11ax_HE_20M Ch1								
CH	Freq. (MHz)	Data Rate	RU Config	Avg. Output Power (dBm)	Antenna Gain (dBi)	EIRP (dBm)	Limit	RESULT
1	2412	MCS0	full	9.63	3.20	12.83	36	PASS
			26/0	9.61	3.20	12.81	36	PASS
			52/37	9.56	3.20	12.76	36	PASS
			106/53	9.59	3.20	12.79	36	PASS
2	2417	MCS0	full	17.66	3.20	20.86	36	PASS
6	2437	MCS0	full	17.70	3.20	20.90	36	PASS
10	2457	MCS0	full	11.73	3.20	14.93	36	PASS
11	2462	MCS0	full	11.66	3.20	14.86	36	PASS
			26/8	11.64	3.20	14.84	36	PASS
			52/40	11.58	3.20	14.78	36	PASS
			106/54	11.61	3.20	14.81	36	PASS

802.11ax_HE20M MIMO										
CH	Freq. (MHz)	Data Rate	RU Config	Avg. Output Power		Total Avg. Output Power (dBm)	Antenna Gain (dBi)	EIRP (dBm)	Limit	RESULT
				CH 0	CH 1					
1	2412	MCS0	full	9.90	9.63	12.90	6.21	19.11	36	PASS
			26/0	9.80	9.46	12.76	6.21	18.97	36	PASS
			52/37	9.85	9.55	12.83	6.21	19.04	36	PASS
			106/53	9.76	9.40	12.71	6.21	18.92	36	PASS
2	2417	MCS0	full	17.82	17.69	20.89	6.21	27.10	36	PASS
6	2437	MCS0	full	17.84	17.77	20.94	6.21	27.15	36	PASS
10	2457	MCS0	full	17.87	17.66	20.90	6.21	27.11	36	PASS
11	2462	MCS0	full	11.87	11.64	14.89	6.21	21.10	36	PASS
			26/8	11.80	11.54	14.80	6.21	21.01	36	PASS
			52/40	11.76	11.45	14.74	6.21	20.95	36	PASS
			106/54	11.67	11.38	14.66	6.21	20.87	36	PASS

Unless otherwise stated the results shown in this test report refer only to the sample(s) tested and such sample(s) are retained for 90 days only.

除非另有說明，此報告結果僅對測試之樣品負責，同時此樣品僅保留90天。本報告未經本公司書面許可，不可部份複製。

This document is issued by the Company subject to its General Conditions of Service printed overleaf, available on request or accessible at <http://www.sgs.com.tw/Terms-and-Conditions> and for electronic format documents, subject to Terms and Conditions for Electronic Documents at <http://www.sgs.com.tw/Terms-and-Conditions>. Attention is drawn to the limitation of liability, indemnification and jurisdiction issues defined therein. Any holder of this document is advised that information contained hereon reflects the Company's findings at the time of its intervention only and within the limits of Client's instructions, if any. The Company's sole responsibility is to its Client and this document does not exonerate parties to a transaction from exercising all their rights and obligations under the transaction documents. This document cannot be reproduced except in full, without prior written approval of the Company. Any unauthorized alteration, forgery or falsification of the content or appearance of this document is unlawful and offenders may be prosecuted to the fullest extent of the law.

802.11ax_HE_40M Ch0								
CH	Freq. (MHz)	Data Rate	RU Config	Avg. Output Power (dBm)	Antenna Gain (dBi)	EIRP (dBm)	Limit	RESULT
3	2422	MCS0	full	10.85	3.20	14.05	36	PASS
			242/61	10.81	3.20	14.01	36	PASS
4	2427	MCS0	full	15.87	3.20	19.07	36	PASS
6	2437	MCS0	full	15.82	3.20	19.02	36	PASS
8	2447	MCS0	full	15.91	3.20	19.11	36	PASS
9	2452	MCS0	full	9.83	3.20	13.03	36	PASS
			242/62	8.28	3.20	11.48	36	PASS

802.11ax_HE_40M Ch1								
CH	Freq. (MHz)	Data Rate	RU Config	Avg. Output Power (dBm)	Antenna Gain (dBi)	EIRP (dBm)	Limit	RESULT
3	2422	MCS0	full	10.63	3.20	13.83	36	PASS
			242/61	10.59	3.20	13.79	36	PASS
4	2427	MCS0	full	15.75	3.20	18.95	36	PASS
6	2437	MCS0	full	15.73	3.20	18.93	36	PASS
8	2447	MCS0	full	15.87	3.20	19.07	36	PASS
9	2452	MCS0	full	9.71	3.20	12.91	36	PASS
			242/62	8.13	3.20	11.33	36	PASS

802.11ax_HE40M MIMO										
CH	Freq. (MHz)	Data Rate	RU Config	Avg. Output Power		Total Avg. Output Power (dBm)	Antenna Gain (dBi)	EIRP (dBm)	Limit	RESULT
				CH 0	CH 1					
3	2422	MCS0	full	10.81	10.62	13.94	6.21	20.15	36	PASS
			242/61	10.72	10.53	13.85	6.21	20.06	36	PASS
4	2427	MCS0	full	15.76	15.71	18.96	6.21	25.17	36	PASS
6	2437	MCS0	full	15.70	15.65	18.90	6.21	25.11	36	PASS
8	2447	MCS0	full	15.68	15.81	18.97	6.21	25.18	36	PASS
9	2452	MCS0	full	9.84	9.68	12.98	6.21	19.19	36	PASS
			242/62	8.21	8.09	11.37	6.21	17.58	36	PASS

Unless otherwise stated the results shown in this test report refer only to the sample(s) tested and such sample(s) are retained for 90 days only.

除非另有說明，此報告結果僅對測試之樣品負責，同時此樣品僅保留90天。本報告未經本公司書面許可，不可部份複製。

This document is issued by the Company subject to its General Conditions of Service printed overleaf, available on request or accessible at <http://www.sgs.com.tw/Terms-and-Conditions> and for electronic format documents, subject to Terms and Conditions for Electronic Documents at <http://www.sgs.com.tw/Terms-and-Conditions>. Attention is drawn to the limitation of liability, indemnification and jurisdiction issues defined therein. Any holder of this document is advised that information contained hereon reflects the Company's findings at the time of its intervention only and within the limits of Client's instructions, if any. The Company's sole responsibility is to its Client and this document does not exonerate parties to a transaction from exercising all their rights and obligations under the transaction documents. This document cannot be reproduced except in full, without prior written approval of the Company. Any unauthorized alteration, forgery or falsification of the content or appearance of this document is unlawful and offenders may be prosecuted to the fullest extent of the law.

9 EMISSION BANDWIDTH MEASUREMENT

9.1 Standard Applicable

The minimum 6 dB bandwidth shall be at least 500 kHz.

9.2 Test Setup

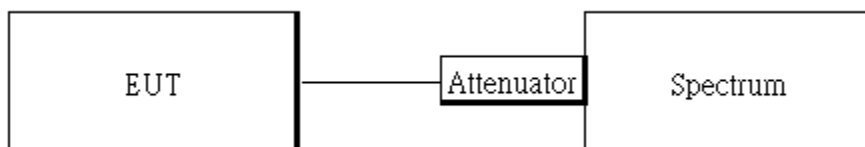

9.3 Measurement Procedure

1. Place the EUT on the table and set it in transmitting mode.
2. The testing follows the Measurement Procedure of FCC KDB 558074 D01 DTS Meas. Guidance .
3. Remove the antenna from the EUT and then connect a low loss RF cable from the antenna port to the spectrum analyzer.
4. Set the spectrum analyzer as
 RBW= 100kHz ,
 VBW = 3 X RBW,
 Span= 2 to 5 times of the OBW,
 Sweep=auto,
 Detector = Peak, and Max hold for -6dB Bandwidth test.
5. Set the spectrum analyzer as
 RBW= 1 % to 5% of 99% Bandwidth ,
 VBW ≥ 3 X RBW,
 Span= large enough to capture all products of the modulation process,
 Sweep=auto,
 Detector = Peak, and Max hold for 99% Bandwidth test.
6. Turn on the 99% bandwidth function, max reading.
7. Repeat above procedures until all test default channel is completed

9.4 6dB Bandwidth

802.11b Ch0

Freq. (MHz)	6dB BW (kHz)	Limit (kHz)	Result
2412	10090.00	≥ 500	PASS
2437	10090.00	≥ 500	PASS
2462	10100.00	≥ 500	PASS

Unless otherwise stated the results shown in this test report refer only to the sample(s) tested and such sample(s) are retained for 90 days only.

除非另有說明，此報告結果僅對測試之樣品負責，同時此樣品僅保留90天。本報告未經本公司書面許可，不可部份複製。

This document is issued by the Company subject to its General Conditions of Service printed overleaf, available on request or accessible at <http://www.sgs.com.tw/Terms-and-Conditions> and for electronic format documents, subject to Terms and Conditions for Electronic Documents at <http://www.sgs.com.tw/Terms-and-Conditions>. Attention is drawn to the limitation of liability, indemnification and jurisdiction issues defined therein. Any holder of this document is advised that information contained hereon reflects the Company's findings at the time of its intervention only and within the limits of Client's instructions, if any. The Company's sole responsibility is to its Client and this document does not exonerate parties to a transaction from exercising all their rights and obligations under the transaction documents. This document cannot be reproduced except in full, without prior written approval of the Company. Any unauthorized alteration, forgery or falsification of the content or appearance of this document is unlawful and offenders may be prosecuted to the fullest extent of the law.

802.11b Ch1

Freq. (MHz)	6dB BW (kHz)	Limit (kHz)	Result
2412	10100.00	≥ 500	PASS
2437	10100.00	≥ 500	PASS
2462	10100.00	≥ 500	PASS

802.11g Ch0

Freq. (MHz)	6dB BW (kHz)	Limit (kHz)	Result
2412	16400.00	≥ 500	PASS
2437	16400.00	≥ 500	PASS
2462	16410.00	≥ 500	PASS

802.11g Ch1

Freq. (MHz)	6dB BW (kHz)	Limit (kHz)	Result
2412	16390.00	≥ 500	PASS
2437	16400.00	≥ 500	PASS
2462	16400.00	≥ 500	PASS

802.11nHT_20M Ch0

Freq. (MHz)	6dB BW (kHz)	Limit (kHz)	Result
2412	17330.00	≥ 500	PASS
2437	17520.00	≥ 500	PASS
2462	17550.00	≥ 500	PASS

802.11nHT_20M Ch1

Freq. (MHz)	6dB BW (kHz)	Limit (kHz)	Result
2412	17570.00	≥ 500	PASS
2437	17600.00	≥ 500	PASS
2462	17590.00	≥ 500	PASS

802.11nHT_40M Ch0

Freq. (MHz)	6dB BW (kHz)	Limit (kHz)	Result
2422	35760.00	≥ 500	PASS
2437	35720.00	≥ 500	PASS
2452	35540.00	≥ 500	PASS

802.11nHT_40M Ch1

Freq. (MHz)	6dB BW (kHz)	Limit (kHz)	Result
2422	35510.00	≥ 500	PASS
2437	35500.00	≥ 500	PASS
2452	35360.00	≥ 500	PASS

Unless otherwise stated the results shown in this test report refer only to the sample(s) tested and such sample(s) are retained for 90 days only.

除非另有說明，此報告結果僅對測試之樣品負責，同時此樣品僅保留90天。本報告未經本公司書面許可，不可部份複製。

This document is issued by the Company subject to its General Conditions of Service printed overleaf, available on request or accessible at <http://www.sgs.com.tw/Terms-and-Conditions> and for electronic format documents, subject to Terms and Conditions for Electronic Documents at <http://www.sgs.com.tw/Terms-and-Conditions>. Attention is drawn to the limitation of liability, indemnification and jurisdiction issues defined therein. Any holder of this document is advised that information contained hereon reflects the Company's findings at the time of its intervention only and within the limits of Client's instructions, if any. The Company's sole responsibility is to its Client and this document does not exonerate parties to a transaction from exercising all their rights and obligations under the transaction documents. This document cannot be reproduced except in full, without prior written approval of the Company. Any unauthorized alteration, forgery or falsification of the content or appearance of this document is unlawful and offenders may be prosecuted to the fullest extent of the law.

802.11ax_HE_20M Ch0

Freq. (MHz)	RU Config	6dB BW (kHz)	Limit (kHz)	Result
2412	full	18400.00	≥ 500	PASS
2412	26/0	2014.00	≥ 500	PASS
2437	full	18430.00	≥ 500	PASS
2462	full	18560.00	≥ 500	PASS

802.11ax_HE_20M Ch1

Freq. (MHz)	RU Config	6dB BW (kHz)	Limit (kHz)	Result
2412	full	18220.00	≥ 500	PASS
2412	26/0	2023.00	≥ 500	PASS
2437	full	18360.00	≥ 500	PASS
2462	full	18250.00	≥ 500	PASS

802.11ax_HE_40M Ch0

Freq. (MHz)	RU Config	6dB BW (kHz)	Limit (kHz)	Result
2422	full	36950.00	≥ 500	PASS
2437	full	36820.00	≥ 500	PASS
2452	full	37040.00	≥ 500	PASS

802.11ax_HE_40M Ch1

Freq. (MHz)	RU Config	6dB BW (kHz)	Limit (kHz)	Result
2422	full	36970.00	≥ 500	PASS
2437	full	36730.00	≥ 500	PASS
2452	full	36590.00	≥ 500	PASS

Unless otherwise stated the results shown in this test report refer only to the sample(s) tested and such sample(s) are retained for 90 days only.

除非另有說明，此報告結果僅對測試之樣品負責，同時此樣品僅保留90天。本報告未經本公司書面許可，不可部份複製。

This document is issued by the Company subject to its General Conditions of Service printed overleaf, available on request or accessible at <http://www.sgs.com.tw/Terms-and-Conditions> and for electronic format documents, subject to Terms and Conditions for Electronic Documents at <http://www.sgs.com.tw/Terms-and-Conditions>. Attention is drawn to the limitation of liability, indemnification and jurisdiction issues defined therein. Any holder of this document is advised that information contained hereon reflects the Company's findings at the time of its intervention only and within the limits of Client's instructions, if any. The Company's sole responsibility is to its Client and this document does not exonerate parties to a transaction from exercising all their rights and obligations under the transaction documents. This document cannot be reproduced except in full, without prior written approval of the Company. Any unauthorized alteration, forgery or falsification of the content or appearance of this document is unlawful and offenders may be prosecuted to the fullest extent of the law.

802.11b_20MHz_Chain0_2412MHz

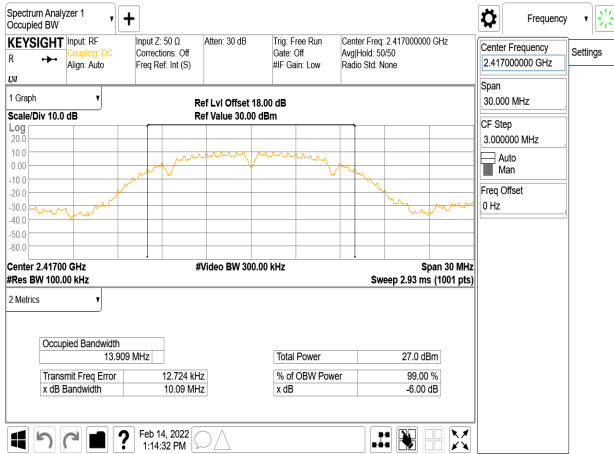

802.11b_20MHz_Chain1_2412MHz

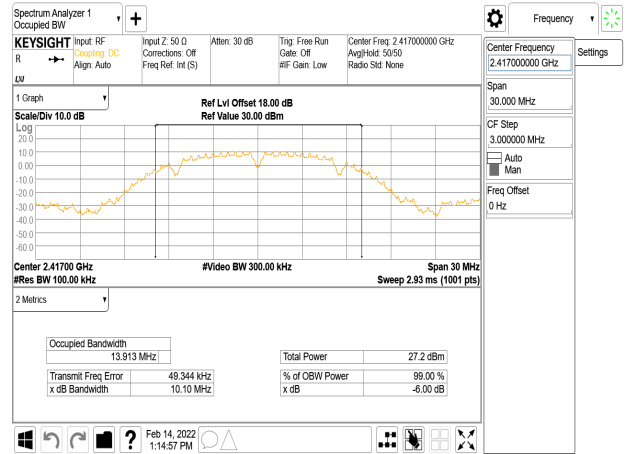

802.11b_20MHz_Chain0_2437MHz

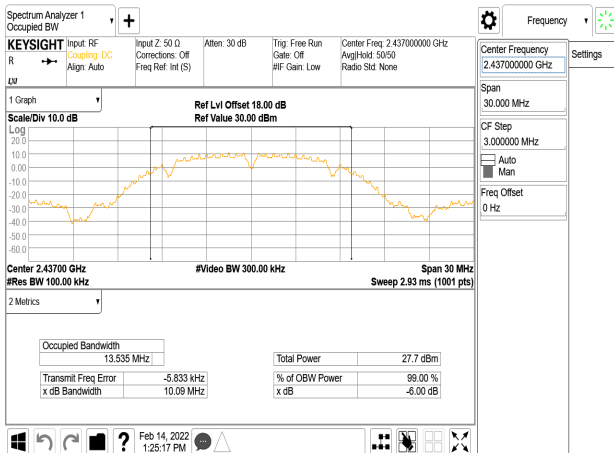

802.11b_20MHz_Chain1_2437MHz

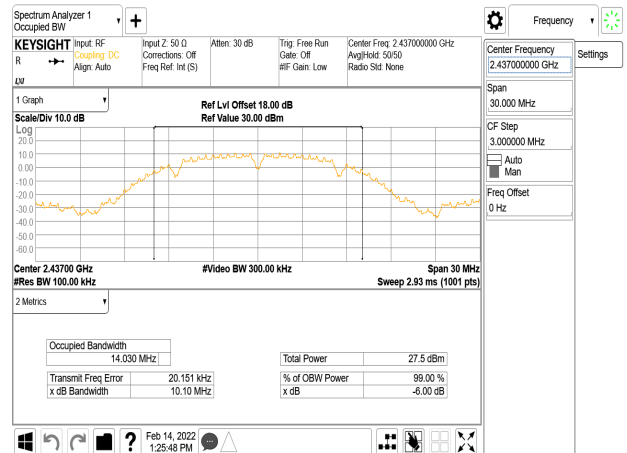

802.11b_20MHz_Chain0_2462MHz

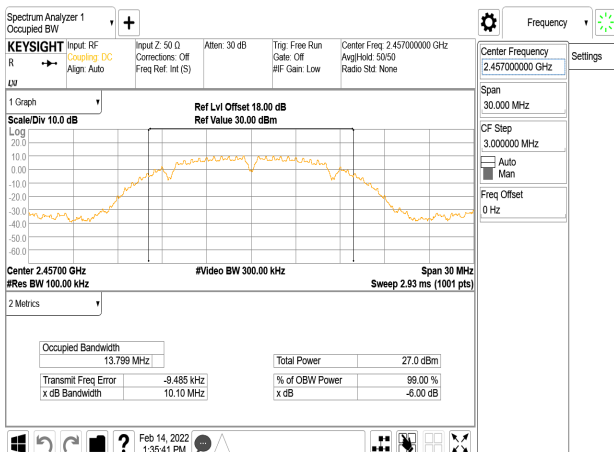

802.11b_20MHz_Chain1_2462MHz

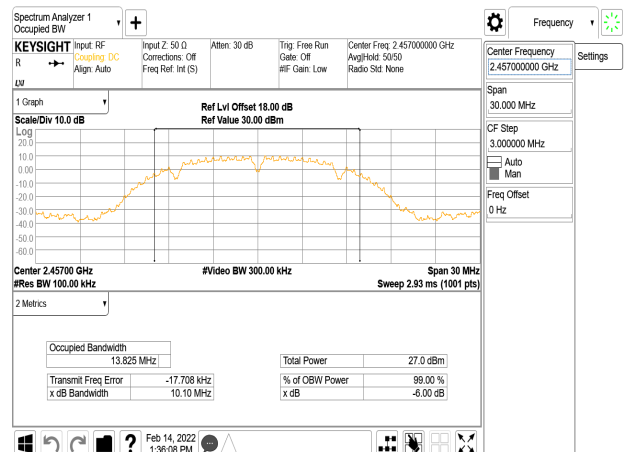

Unless otherwise stated the results shown in this test report refer only to the sample(s) tested and such sample(s) are retained for 90 days only.

除非另有說明，此報告結果僅對測試之樣品負責，同時此樣品僅保留90天。本報告未經本公司書面許可，不可部份複製。

This document is issued by the Company subject to its General Conditions of Service printed overleaf, available on request or accessible at <http://www.sgs.com.tw/Terms-and-Conditions> and for electronic format documents, subject to Terms and Conditions for Electronic Documents at <http://www.sgs.com.tw/Terms-and-Conditions>. Attention is drawn to the limitation of liability, indemnification and jurisdiction issues defined therein. Any holder of this document is advised that information contained hereon reflects the Company's findings at the time of its intervention only and within the limits of Client's instructions, if any. The Company's sole responsibility is to its Client and this document does not exonerate parties to a transaction from exercising all their rights and obligations under the transaction documents. This document cannot be reproduced except in full, without prior written approval of the Company. Any unauthorized alteration, forgery or falsification of the content or appearance of this document is unlawful and offenders may be prosecuted to the fullest extent of the law.

802.11g_20MHz_Chain0_2412MHz

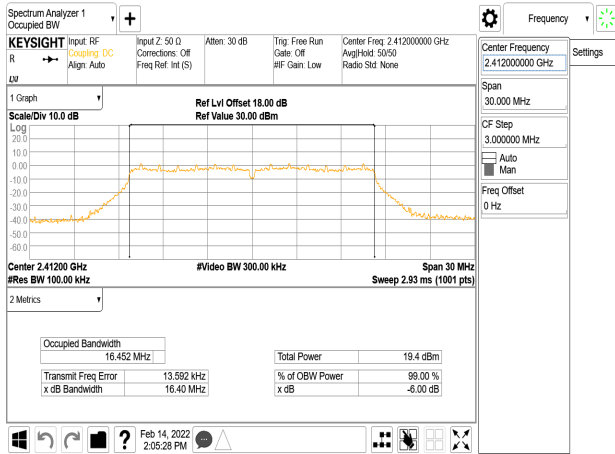

802.11g_20MHz_Chain1_2412MHz

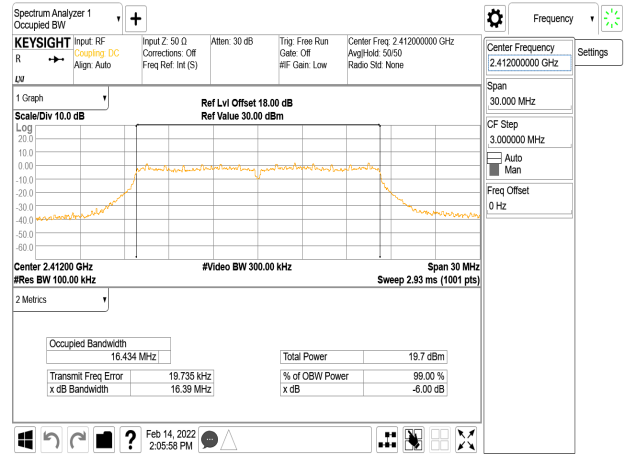

802.11g_20MHz_Chain0_2437MHz

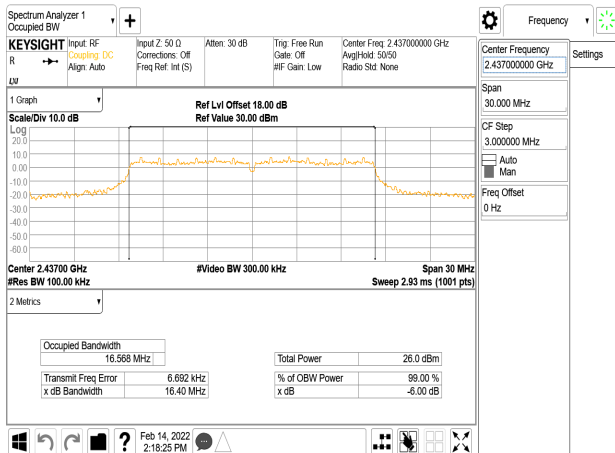

802.11g_20MHz_Chain1_2437MHz

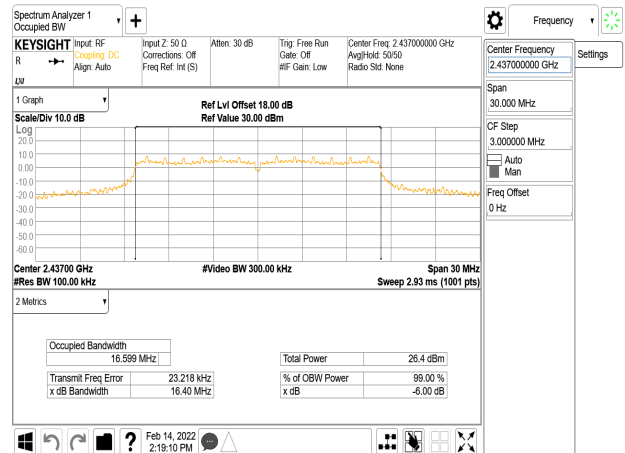

802.11g_20MHz_Chain0_2462MHz

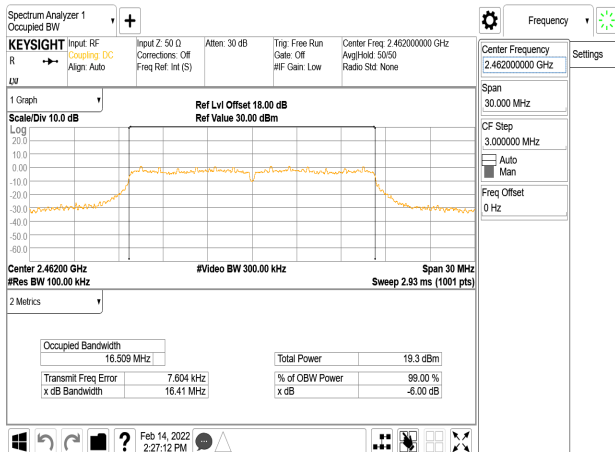

802.11g_20MHz_Chain1_2462MHz

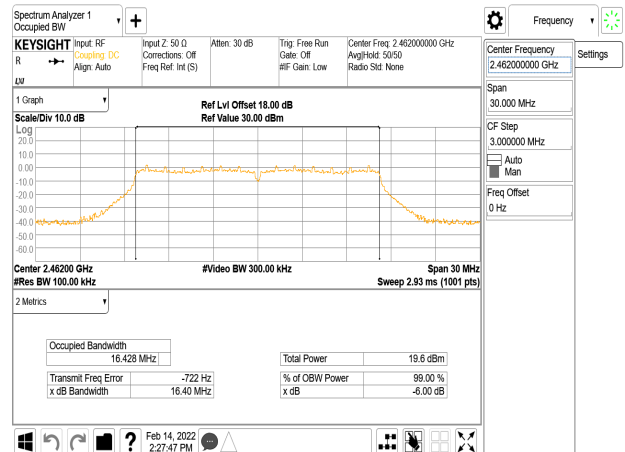

Unless otherwise stated the results shown in this test report refer only to the sample(s) tested and such sample(s) are retained for 90 days only.

除非另有說明，此報告結果僅對測試之樣品負責，同時此樣品僅保留90天。本報告未經本公司書面許可，不可部份複製。

This document is issued by the Company subject to its General Conditions of Service printed overleaf, available on request or accessible at <http://www.sgs.com.tw/Terms-and-Conditions> and for electronic format documents, subject to Terms and Conditions for Electronic Documents at <http://www.sgs.com.tw/Terms-and-Conditions>. Attention is drawn to the limitation of liability, indemnification and jurisdiction issues defined therein. Any holder of this document is advised that information contained herein reflects the Company's findings at the time of its intervention only and within the limits of Client's instructions, if any. The Company's sole responsibility is to its Client and this document does not exonerate parties to a transaction from exercising all their rights and obligations under the transaction documents. This document cannot be reproduced except in full, without prior written approval of the Company. Any unauthorized alteration, forgery or falsification of the content or appearance of this document is unlawful and offenders may be prosecuted to the fullest extent of the law.

802.11n_20MHz_Chain0_2412MHz

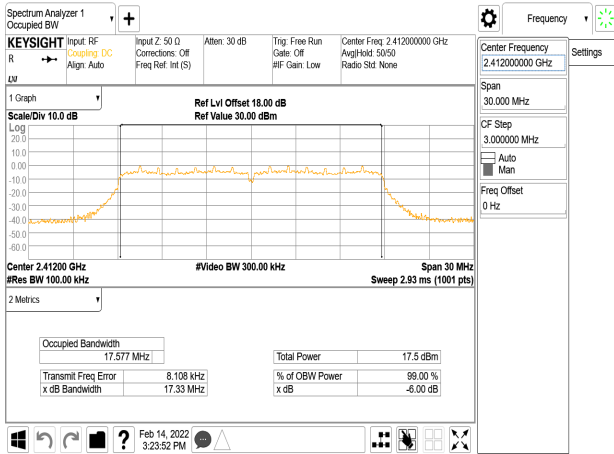

802.11n_20MHz_Chain1_2412MHz

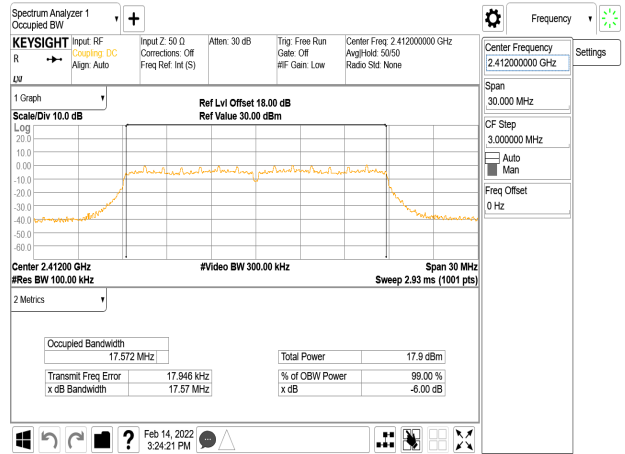

802.11n_20MHz_Chain0_2437MHz

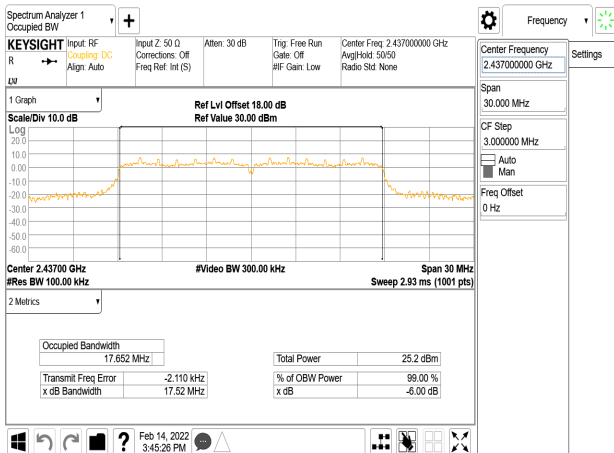

802.11n_20MHz_Chain1_2437MHz

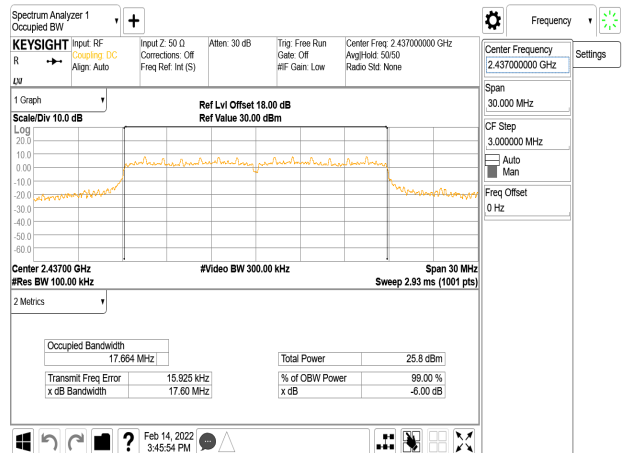

802.11n_20MHz_Chain0_2462MHz

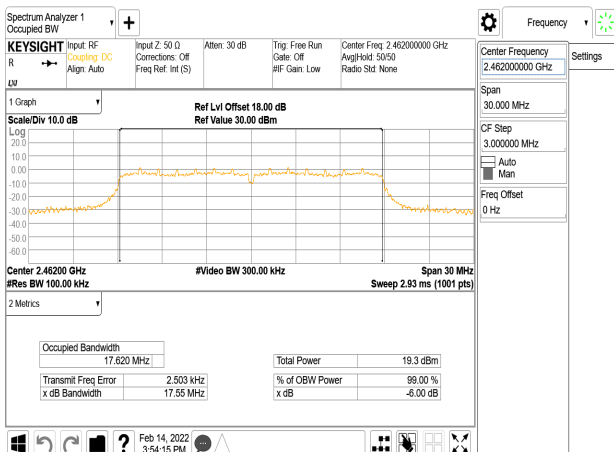

802.11n_20MHz_Chain1_2462MHz

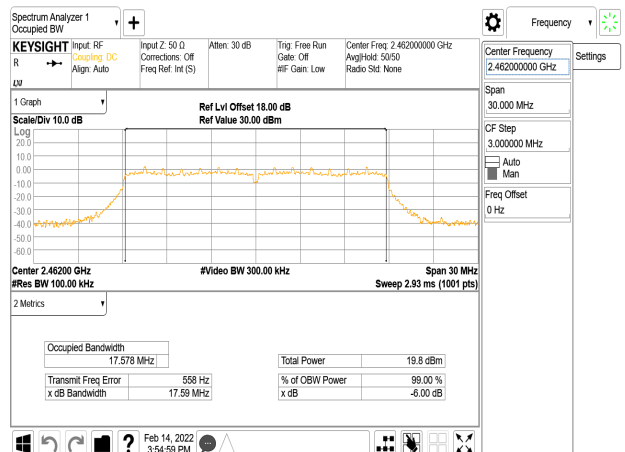

Unless otherwise stated the results shown in this test report refer only to the sample(s) tested and such sample(s) are retained for 90 days only.

除非另有說明，此報告結果僅對測試之樣品負責，同時此樣品僅保留90天。本報告未經本公司書面許可，不可部份複製。

This document is issued by the Company subject to its General Conditions of Service printed overleaf, available on request or accessible at <http://www.sgs.com.tw/Terms-and-Conditions> and for electronic format documents, subject to Terms and Conditions for Electronic Documents at <http://www.sgs.com.tw/Terms-and-Conditions>. Attention is drawn to the limitation of liability, indemnification and jurisdiction issues defined therein. Any holder of this document is advised that information contained herein reflects the Company's findings at the time of its intervention only and within the limits of Client's instructions, if any. The Company's sole responsibility is to its Client and this document does not exonerate parties to a transaction from exercising all their rights and obligations under the transaction documents. This document cannot be reproduced except in full, without prior written approval of the Company. Any unauthorized alteration, forgery or falsification of the content or appearance of this document is unlawful and offenders may be prosecuted to the fullest extent of the law.

802.11n_40MHz_Chain0_2422MHz

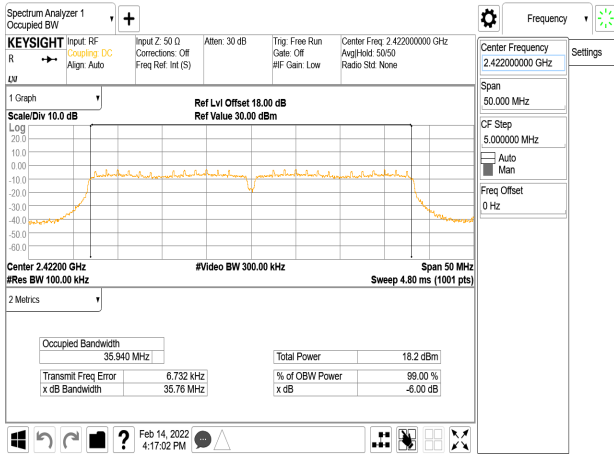

802.11n_40MHz_Chain1_2422MHz

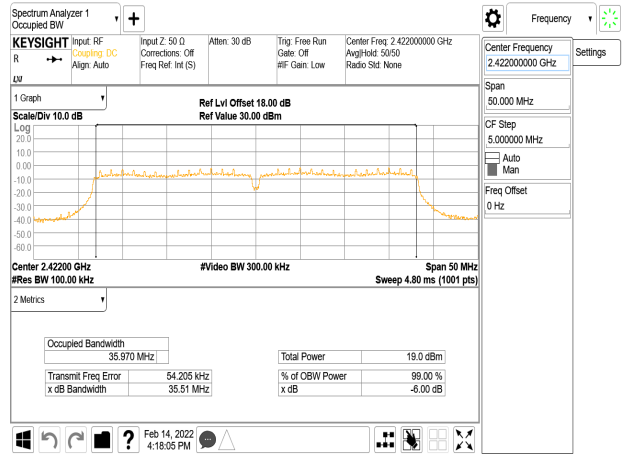

802.11n_40MHz_Chain0_2437MHz

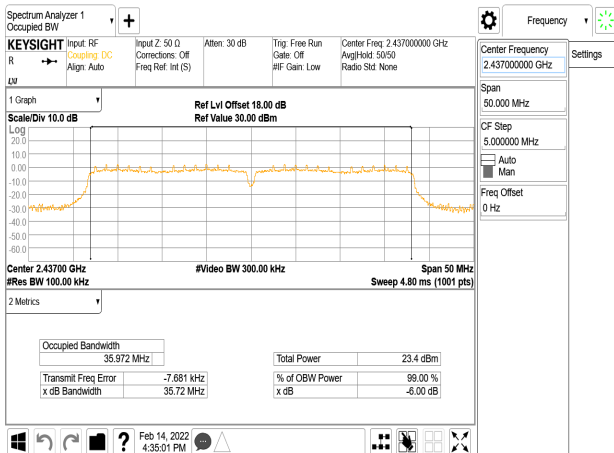

802.11n_40MHz_Chain1_2437MHz

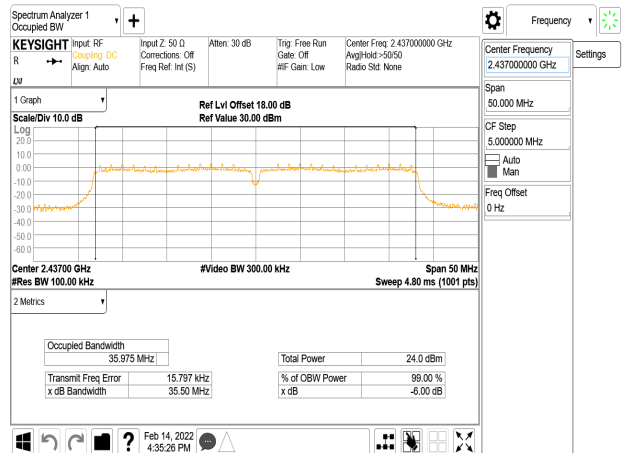

802.11n_40MHz_Chain0_2452MHz

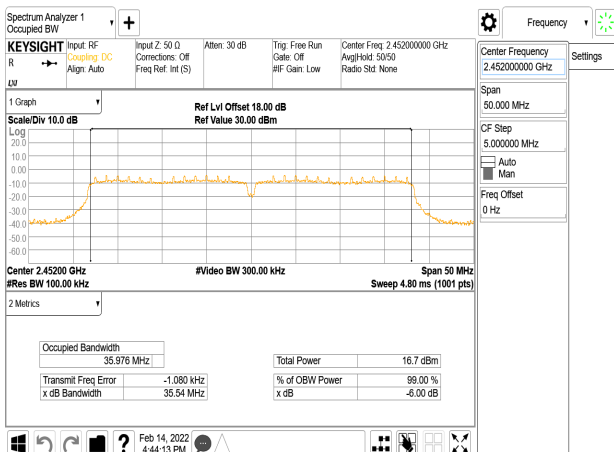

802.11n_40MHz_Chain1_2452MHz

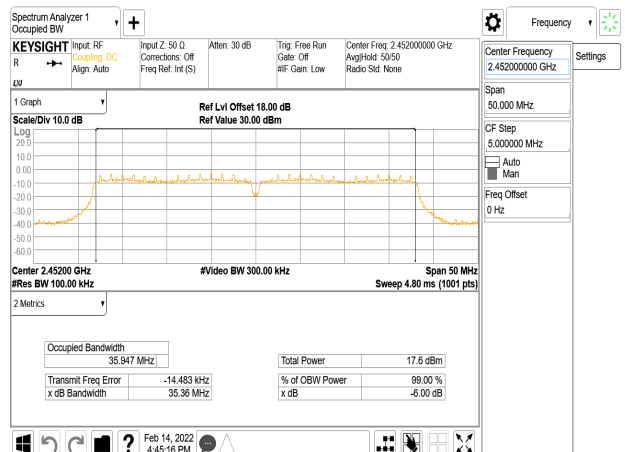

Unless otherwise stated the results shown in this test report refer only to the sample(s) tested and such sample(s) are retained for 90 days only.

除非另有說明，此報告結果僅對測試之樣品負責，同時此樣品僅保留90天。本報告未經本公司書面許可，不可部份複製。

This document is issued by the Company subject to its General Conditions of Service printed overleaf, available on request or accessible at <http://www.sgs.com.tw/Terms-and-Conditions> and for electronic format documents, subject to Terms and Conditions for Electronic Documents at <http://www.sgs.com.tw/Terms-and-Conditions>. Attention is drawn to the limitation of liability, indemnification and jurisdiction issues defined therein. Any holder of this document is advised that information contained hereon reflects the Company's findings at the time of its intervention only and within the limits of Client's instructions, if any. The Company's sole responsibility is to its Client and this document does not exonerate parties to a transaction from exercising all their rights and obligations under the transaction documents. This document cannot be reproduced except in full, without prior written approval of the Company. Any unauthorized alteration, forgery or falsification of the content or appearance of this document is unlawful and offenders may be prosecuted to the fullest extent of the law.

802.11ax_20MHz_Chain0_2412MHz

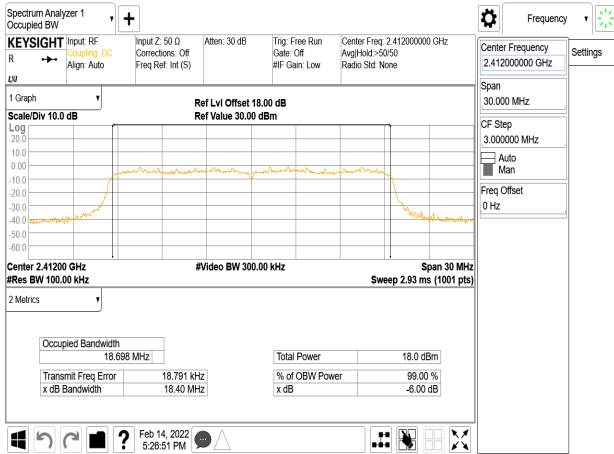

802.11ax_20MHz_Chain0_2462MHz

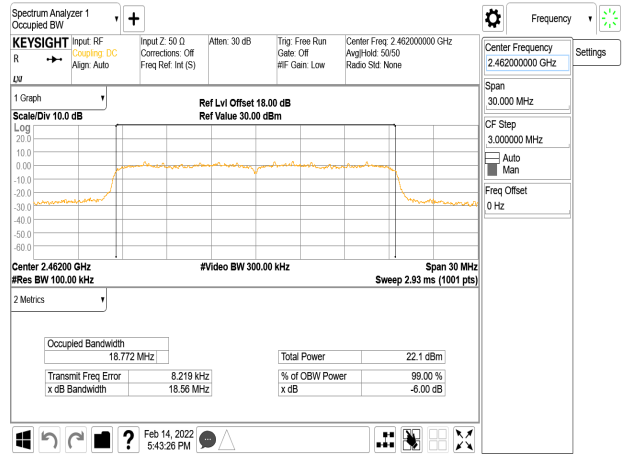

802.11ax_20MHz_Chain0_2412MHz_RU26_0

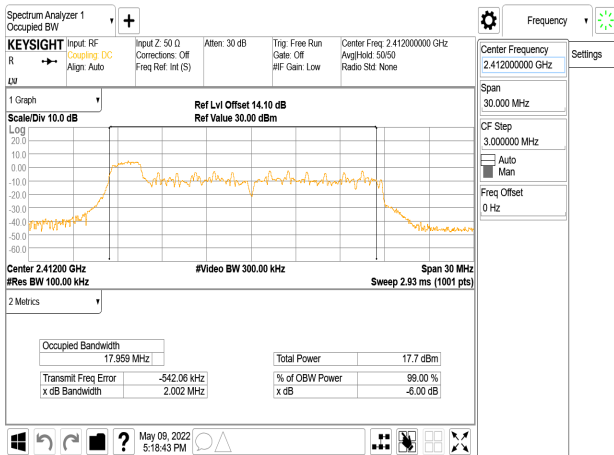

802.11ax_20MHz_Chain1_2412MHz

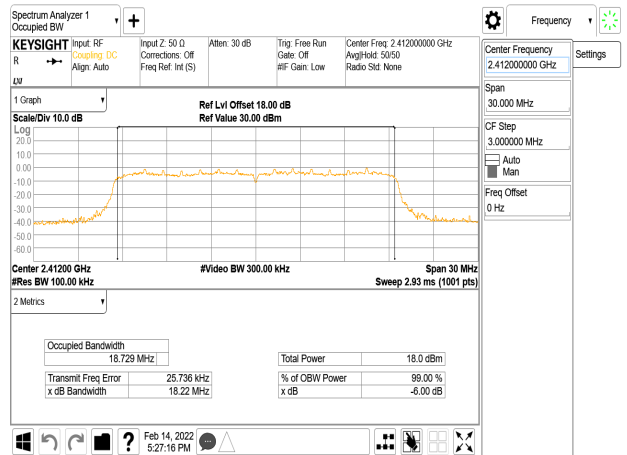

802.11ax_20MHz_Chain0_2437MHz

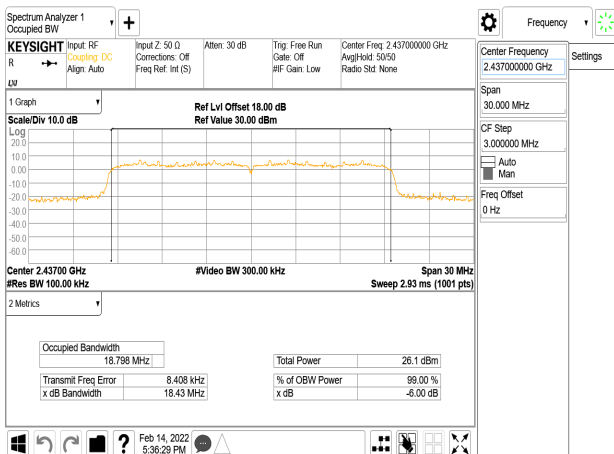

802.11ax_20MHz_Chain1_2412MHz_RU26_0

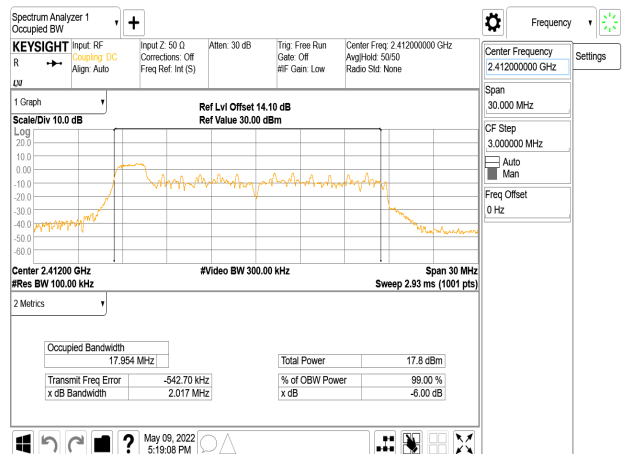

Unless otherwise stated the results shown in this test report refer only to the sample(s) tested and such sample(s) are retained for 90 days only.

除非另有說明，此報告結果僅對測試之樣品負責，同時此樣品僅保留90天。本報告未經本公司書面許可，不可部份複製。

This document is issued by the Company subject to its General Conditions of Service printed overleaf, available on request or accessible at <http://www.sgs.com.tw/Terms-and-Conditions> and for electronic format documents, subject to Terms and Conditions for Electronic Documents at <http://www.sgs.com.tw/Terms-and-Conditions>. Attention is drawn to the limitation of liability, indemnification and jurisdiction issues defined therein. Any holder of this document is advised that information contained herein reflects the Company's findings at the time of its intervention only and within the limits of Client's instructions, if any. The Company's sole responsibility is to its Client and this document does not exonerate parties to a transaction from exercising all their rights and obligations under the transaction documents. This document cannot be reproduced except in full, without prior written approval of the Company. Any unauthorized alteration, forgery or falsification of the content or appearance of this document is unlawful and offenders may be prosecuted to the fullest extent of the law.

802.11ax_20MHz_Chain1_2437MHz

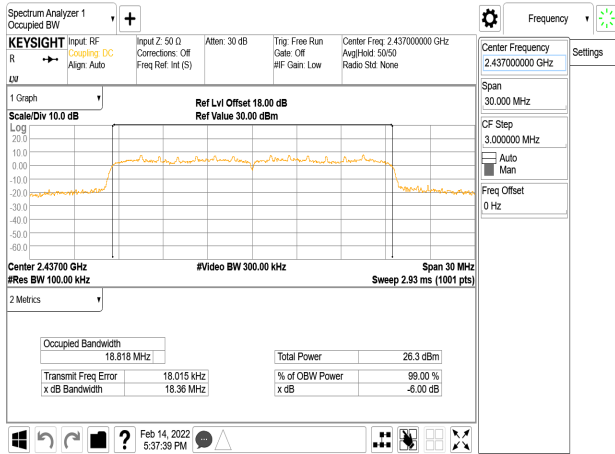

802.11ax_40MHz_Chain0_2437MHz

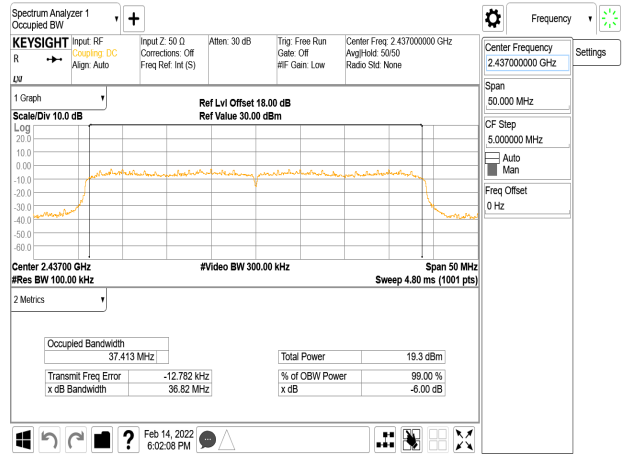

802.11ax_20MHz_Chain1_2462MHz

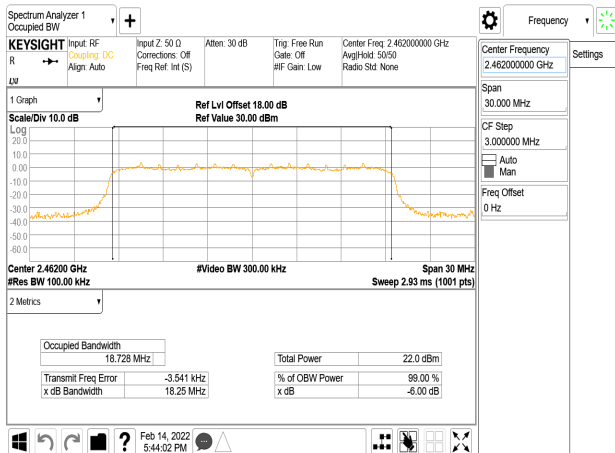

802.11ax_40MHz_Chain0_2452MHz

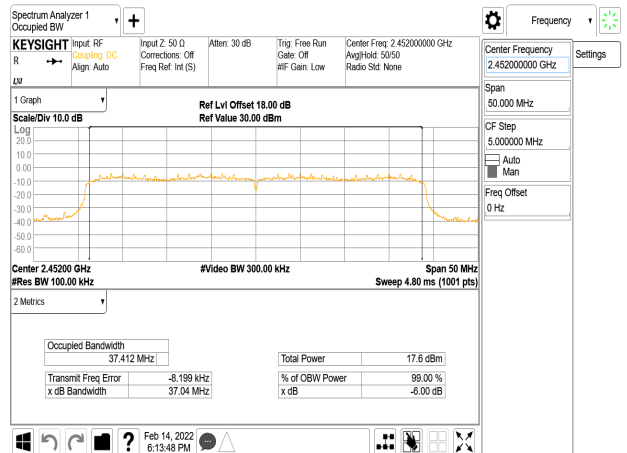

802.11ax_40MHz_Chain0_2422MHz

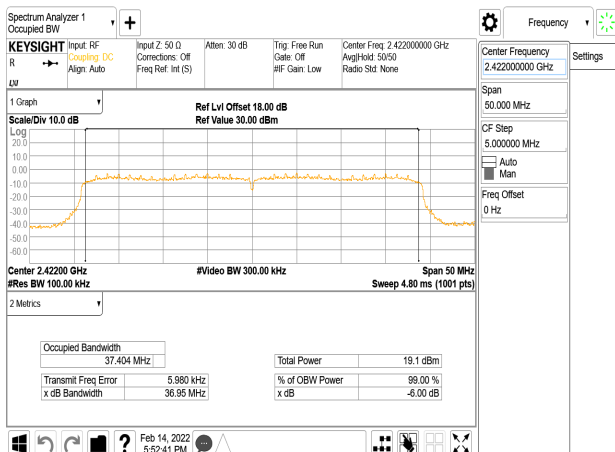

802.11ax_40MHz_Chain1_2422MHz

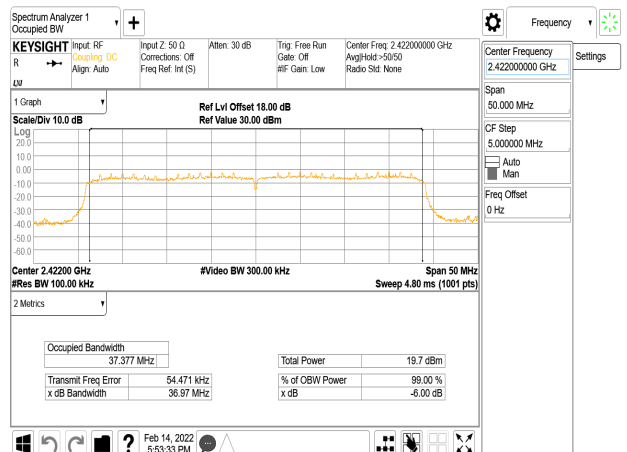

Unless otherwise stated the results shown in this test report refer only to the sample(s) tested and such sample(s) are retained for 90 days only.

除非另有說明，此報告結果僅對測試之樣品負責，同時此樣品僅保留90天。本報告未經本公司書面許可，不可部份複製。

This document is issued by the Company subject to its General Conditions of Service printed overleaf, available on request or accessible at <http://www.sgs.com.tw/Terms-and-Conditions> and for electronic format documents, subject to Terms and Conditions for Electronic Documents at <http://www.sgs.com.tw/Terms-and-Conditions>. Attention is drawn to the limitation of liability, indemnification and jurisdiction issues defined therein. Any holder of this document is advised that information contained hereon reflects the Company's findings at the time of its intervention only and within the limits of Client's instructions, if any. The Company's sole responsibility is to its Client and this document does not exonerate parties to a transaction from exercising all their rights and obligations under the transaction documents. This document cannot be reproduced except in full, without prior written approval of the Company. Any unauthorized alteration, forgery or falsification of the content or appearance of this document is unlawful and offenders may be prosecuted to the fullest extent of the law.

802.11ax_40MHz_Chain1_2437MHz

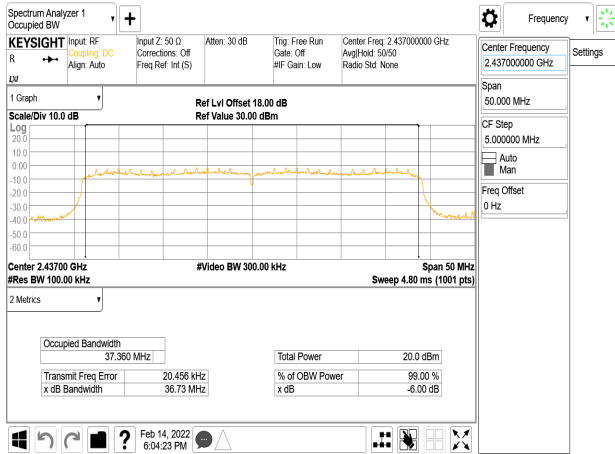

802.11ax_40MHz_Chain1_2452MHz

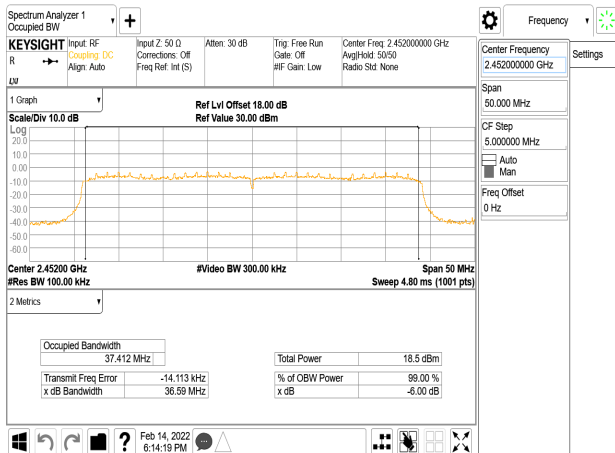

Unless otherwise stated the results shown in this test report refer only to the sample(s) tested and such sample(s) are retained for 90 days only.

除非另有說明，此報告結果僅對測試之樣品負責，同時此樣品僅保留90天。本報告未經本公司書面許可，不可部份複製。

This document is issued by the Company subject to its General Conditions of Service printed overleaf, available on request or accessible at <http://www.sgs.com.tw/Terms-and-Conditions> and for electronic format documents, subject to Terms and Conditions for Electronic Documents at <http://www.sgs.com.tw/Terms-and-Conditions>. Attention is drawn to the limitation of liability, indemnification and jurisdiction issues defined therein. Any holder of this document is advised that information contained hereon reflects the Company's findings at the time of its intervention only and within the limits of Client's instructions, if any. The Company's sole responsibility is to its Client and this document does not exonerate parties to a transaction from exercising all their rights and obligations under the transaction documents. This document cannot be reproduced except in full, without prior written approval of the Company. Any unauthorized alteration, forgery or falsification of the content or appearance of this document is unlawful and offenders may be prosecuted to the fullest extent of the law.

9.5 99% Bandwidth

802.11b Ch0

Freq. (MHz)	99% BW (MHz)
2412	13.924
2437	13.606
2462	13.266

802.11b Ch1

Freq. (MHz)	99% BW (MHz)
2412	13.963
2437	14.069
2462	13.886

802.11g Ch0

Freq. (MHz)	99% BW (MHz)
2412	16.745
2437	17.042
2462	16.822

802.11g Ch1

Freq. (MHz)	99% BW (MHz)
2412	16.664
2437	17.022
2462	16.651

802.11n_HT20M Ch0

Freq. (MHz)	99% BW (MHz)
2412	17.697
2437	17.911
2462	17.767

Unless otherwise stated the results shown in this test report refer only to the sample(s) tested and such sample(s) are retained for 90 days only.

除非另有說明，此報告結果僅對測試之樣品負責，同時此樣品僅保留90天。本報告未經本公司書面許可，不可部份複製。

This document is issued by the Company subject to its General Conditions of Service printed overleaf, available on request or accessible at <http://www.sgs.com.tw/Terms-and-Conditions> and for electronic format documents, subject to Terms and Conditions for Electronic Documents at <http://www.sgs.com.tw/Terms-and-Conditions>. Attention is drawn to the limitation of liability, indemnification and jurisdiction issues defined therein. Any holder of this document is advised that information contained hereon reflects the Company's findings at the time of its intervention only and within the limits of Client's instructions, if any. The Company's sole responsibility is to its Client and this document does not exonerate parties to a transaction from exercising all their rights and obligations under the transaction documents. This document cannot be reproduced except in full, without prior written approval of the Company. Any unauthorized alteration, forgery or falsification of the content or appearance of this document is unlawful and offenders may be prosecuted to the fullest extent of the law.

802.11n_HT20M Ch1

Freq. (MHz)	99% BW (MHz)
2412	17.66
2437	17.866
2462	17.665

802.11n_HT40M Ch0

Freq. (MHz)	99% BW (MHz)
2422	36.223
2437	36.261
2452	36.268

802.11n_HT40M Ch1

Freq. (MHz)	99% BW (MHz)
2422	36.118
2437	36.163
2452	36.157

802.11ax_HE20M Ch0

Freq. (MHz)	RU Config	99% BW (MHz)
2412	full	18.772
2412	26/0	18.152
2437	full	18.828
2462	full	18.804

802.11ax_HE20M Ch1

Freq. (MHz)	RU Config	99% BW (MHz)
2412	full	18.76
2412	26/0	18.174
2437	full	18.882
2462	full	18.778

Unless otherwise stated the results shown in this test report refer only to the sample(s) tested and such sample(s) are retained for 90 days only.

除非另有說明，此報告結果僅對測試之樣品負責，同時此樣品僅保留90天。本報告未經本公司書面許可，不可部份複製。

This document is issued by the Company subject to its General Conditions of Service printed overleaf, available on request or accessible at <http://www.sgs.com.tw/Terms-and-Conditions> and for electronic format documents, subject to Terms and Conditions for Electronic Documents at <http://www.sgs.com.tw/Terms-and-Conditions>. Attention is drawn to the limitation of liability, indemnification and jurisdiction issues defined therein. Any holder of this document is advised that information contained hereon reflects the Company's findings at the time of its intervention only and within the limits of Client's instructions, if any. The Company's sole responsibility is to its Client and this document does not exonerate parties to a transaction from exercising all their rights and obligations under the transaction documents. This document cannot be reproduced except in full, without prior written approval of the Company. Any unauthorized alteration, forgery or falsification of the content or appearance of this document is unlawful and offenders may be prosecuted to the fullest extent of the law.

802.11ax_HE40M Ch0

Freq. (MHz)	RU Config	99% BW (MHz)
2422	full	37.505
2437	full	37.517
2452	full	37.536

802.11ax_HE40M Ch1

Freq. (MHz)	RU Config	99% BW (MHz)
2422	full	37.48
2437	full	37.487
2452	full	37.49

Unless otherwise stated the results shown in this test report refer only to the sample(s) tested and such sample(s) are retained for 90 days only.

除非另有說明，此報告結果僅對測試之樣品負責，同時此樣品僅保留90天。本報告未經本公司書面許可，不可部份複製。

This document is issued by the Company subject to its General Conditions of Service printed overleaf, available on request or accessible at <http://www.sgs.com.tw/Terms-and-Conditions> and for electronic format documents, subject to Terms and Conditions for Electronic Documents at <http://www.sgs.com.tw/Terms-and-Conditions>. Attention is drawn to the limitation of liability, indemnification and jurisdiction issues defined therein. Any holder of this document is advised that information contained hereon reflects the Company's findings at the time of its intervention only and within the limits of Client's instructions, if any. The Company's sole responsibility is to its Client and this document does not exonerate parties to a transaction from exercising all their rights and obligations under the transaction documents. This document cannot be reproduced except in full, without prior written approval of the Company. Any unauthorized alteration, forgery or falsification of the content or appearance of this document is unlawful and offenders may be prosecuted to the fullest extent of the law.

802.11b_20MHz_Chain0_2412MHz

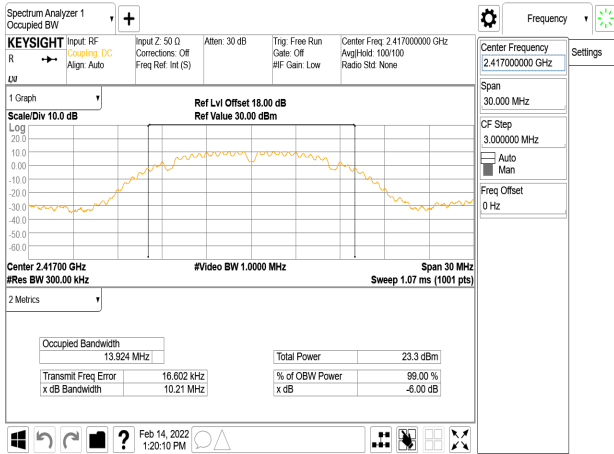

802.11b_20MHz_Chain1_2412MHz

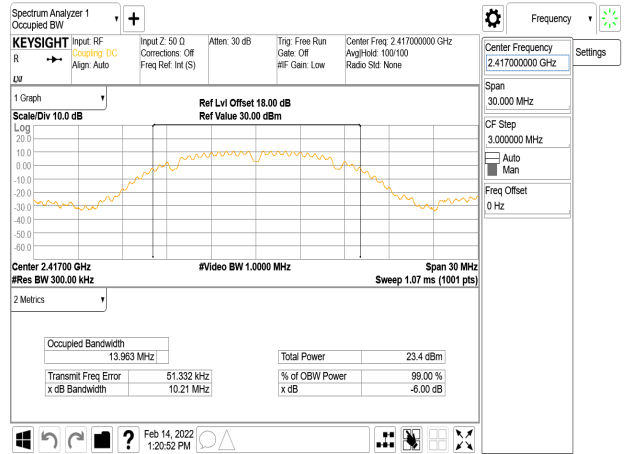

802.11b_20MHz_Chain0_2437MHz

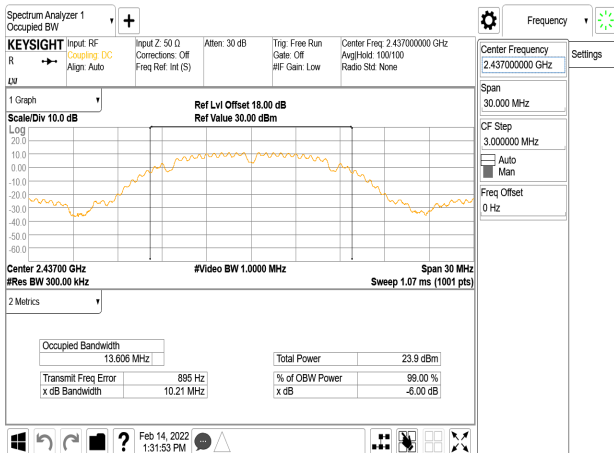

802.11b_20MHz_Chain1_2437MHz

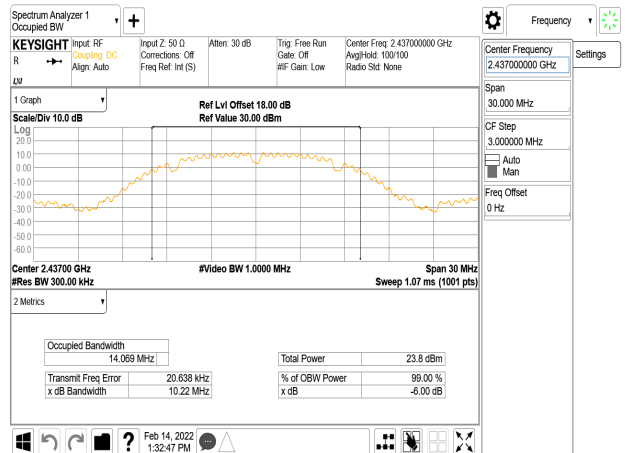

802.11b_20MHz_Chain0_2462MHz

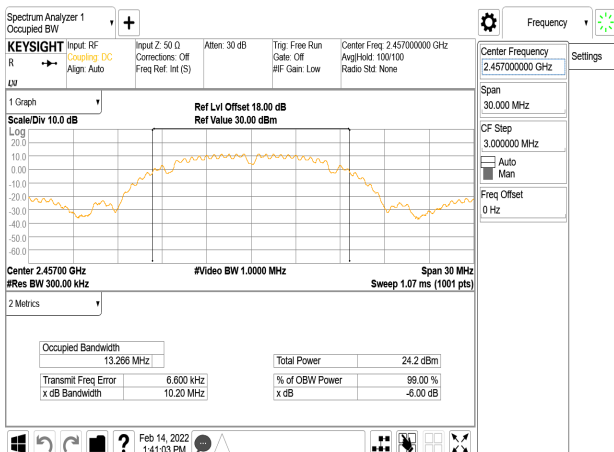

802.11b_20MHz_Chain1_2462MHz

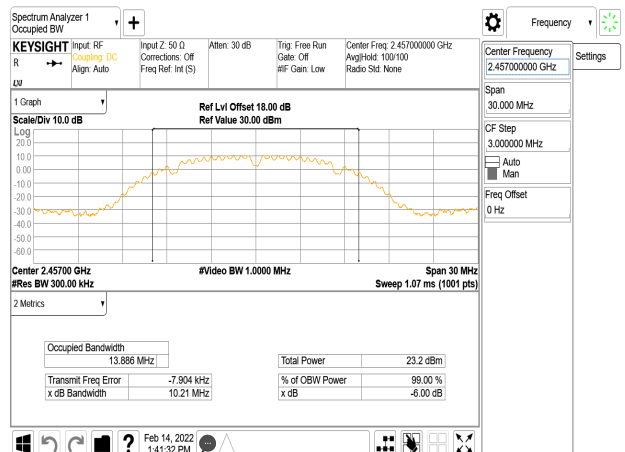

Unless otherwise stated the results shown in this test report refer only to the sample(s) tested and such sample(s) are retained for 90 days only.

除非另有說明，此報告結果僅對測試之樣品負責，同時此樣品僅保留90天。本報告未經本公司書面許可，不可部份複製。

This document is issued by the Company subject to its General Conditions of Service printed overleaf, available on request or accessible at <http://www.sgs.com.tw/Terms-and-Conditions> and for electronic format documents, subject to Terms and Conditions for Electronic Documents at <http://www.sgs.com.tw/Terms-and-Conditions>. Attention is drawn to the limitation of liability, indemnification and jurisdiction issues defined therein. Any holder of this document is advised that information contained hereon reflects the Company's findings at the time of its intervention only and within the limits of Client's instructions, if any. The Company's sole responsibility is to its Client and this document does not exonerate parties to a transaction from exercising all their rights and obligations under the transaction documents. This document cannot be reproduced except in full, without prior written approval of the Company. Any unauthorized alteration, forgery or falsification of the content or appearance of this document is unlawful and offenders may be prosecuted to the fullest extent of the law.

802.11g_20MHz_Chain0_2412MHz

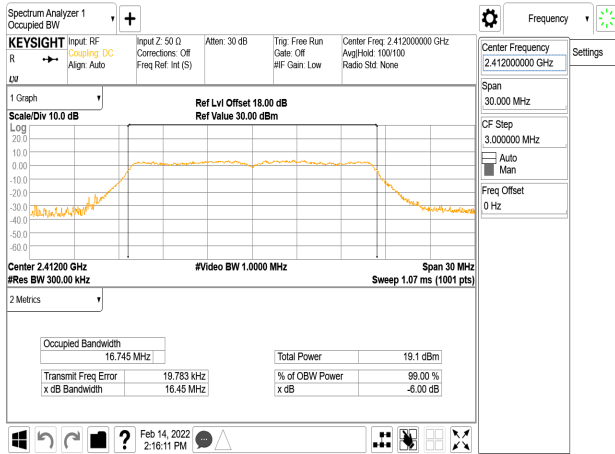

802.11g_20MHz_Chain1_2412MHz

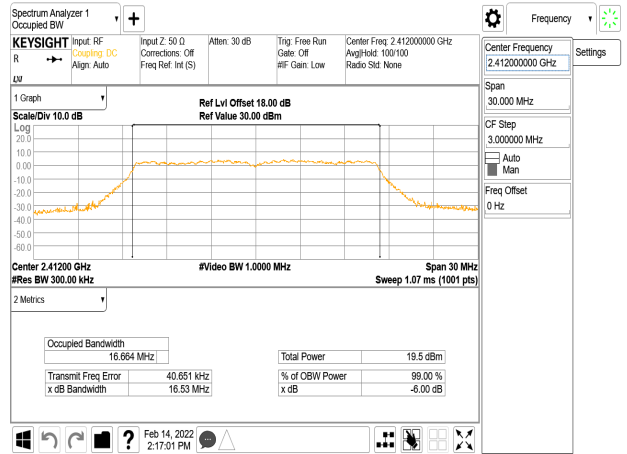

802.11g_20MHz_Chain0_2437MHz

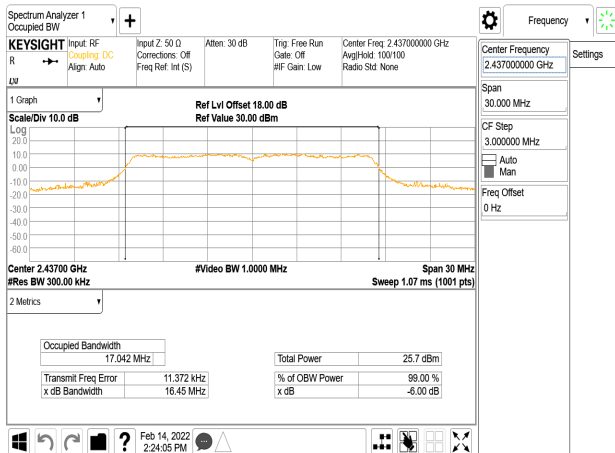

802.11g_20MHz_Chain1_2437MHz

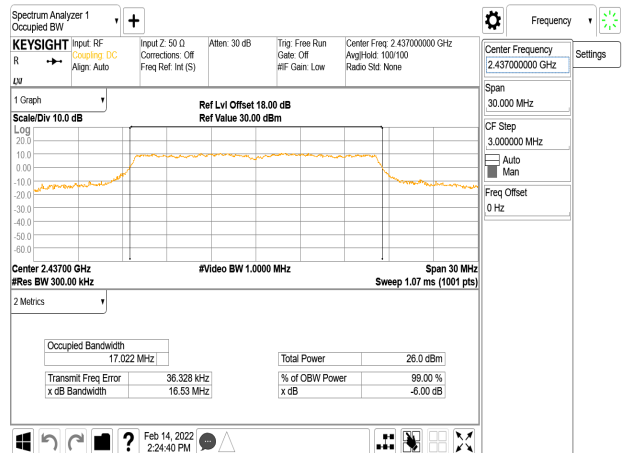

802.11g_20MHz_Chain0_2462MHz

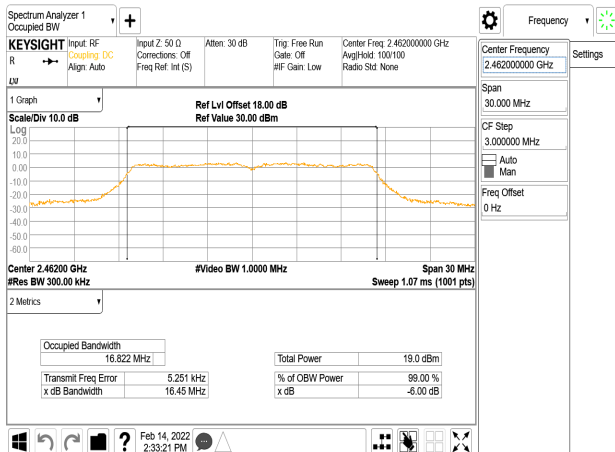

802.11g_20MHz_Chain1_2462MHz

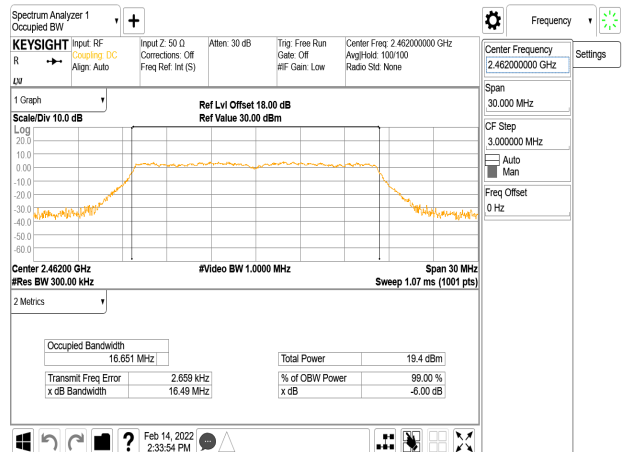

Unless otherwise stated the results shown in this test report refer only to the sample(s) tested and such sample(s) are retained for 90 days only.

除非另有說明，此報告結果僅對測試之樣品負責，同時此樣品僅保留90天。本報告未經本公司書面許可，不可部份複製。

This document is issued by the Company subject to its General Conditions of Service printed overleaf, available on request or accessible at <http://www.sgs.com.tw/Terms-and-Conditions> and for electronic format documents, subject to Terms and Conditions for Electronic Documents at <http://www.sgs.com.tw/Terms-and-Conditions>. Attention is drawn to the limitation of liability, indemnification and jurisdiction issues defined therein. Any holder of this document is advised that information contained hereon reflects the Company's findings at the time of its intervention only and within the limits of Client's instructions, if any. The Company's sole responsibility is to its Client and this document does not exonerate parties to a transaction from exercising all their rights and obligations under the transaction documents. This document cannot be reproduced except in full, without prior written approval of the Company. Any unauthorized alteration, forgery or falsification of the content or appearance of this document is unlawful and offenders may be prosecuted to the fullest extent of the law.