





RADIO TEST REPORT

Test Report No. 15169644H-A-R2

Customer	Murata Manufacturing Co., Ltd.
Description of EUT	W-LAN + Bluetooth Module
Model Number of EUT	1PJ
FCC ID	VPYLBEE5ZZ1PJ
Test Regulation	FCC Part 15 Subpart C
Test Result	Complied
Issue Date	April 3, 2024
Remarks	*Wireless LAN (2.4 GHz band) and Bluetooth Low Energy part(s) *Radiated Spurious Emission only *For Permissive Change

Representative Test Engineer	Approved By
	
Tomohisa Nakagawa Engineer	Takumi Shimada Engineer
 	
CERTIFICATE 5107.02	
<input type="checkbox"/> The testing in which "Non-accreditation" is displayed is outside the accreditation scopes in UL Japan, Inc.	
<input checked="" type="checkbox"/> There is no testing item of "Non-accreditation".	

Report Cover Page - Form-ULID-003532 (DCS:13-EM-F0429) Issue# 23.0

ANNOUNCEMENT

- This test report shall not be reproduced in full or partial, without the written approval of UL Japan, Inc.
- The results in this report apply only to the sample tested. (Laboratory was not involved in sampling.)
- This sample tested is in compliance with the limits of the above regulation.
- The test results in this test report are traceable to the national or international standards.
- This test report must not be used by the customer to claim product certification, approval, or endorsement by the A2LA accreditation body.
- This test report covers Radio technical requirements.
It does not cover administrative issues such as Manual or non-Radio test related Requirements. (if applicable)
- The all test items in this test report are conducted by UL Japan, Inc. Ise EMC Lab.
- The opinions and the interpretations to the result of the description in this report are outside scopes where UL Japan, Inc. has been accredited.
- The information provided by the customer for this report is identified in SECTION 1.
- The laboratory is not responsible for information provided by the customer which can impact the validity of the results.
- For test report(s) referred in this report, the latest version (including any revisions) is always referred.

REVISION HISTORY

Original Test Report No.: 15169644H-A

This report is a revised version of 15169644H-A-R1. 15169644H-A-R1 is replaced with this report.

Revision	Test Report No.	Date	Page Revised Contents
- (Original)	15169644H-A	March 8, 2024	-
1	15169644H-A-R1	April 2, 2024	SECTION 4: Operation of EUT during testing 4.1: Operating Mode(s) for WLAN -Addition of below explanatory note for power setting *The test was performed at higher power setting that is more stringent than the previous application (date of grant: May 24, 2021).
1	15169644H-A-R1	April 2, 2024	SECTION 4: Operation of EUT during testing 4.1: Operating Mode(s) for BT LE -Correction of power setting written in FW → minus_1dBfrom0_bdaddr_no tag33 153_minus0.3 (d9a957a8941bb09470601acc79fb579f)
1	15169644H-A-R1	April 2, 2024	SECTION 4: Operation of EUT during testing 4.2: Configuration and Peripherals -Replacement of configuration diagram -Correction of cable name of cable No.1 Signal and DC Cable → Signal Cable
2	15169644H-A-R2	April 3, 2024	SECTION 4: Operation of EUT during testing 4.2: Configuration and Peripherals -Replacement of configuration and peripherals.

Reference: Abbreviations (Including words undescribed in this report)

A2LA	The American Association for Laboratory Accreditation	ICES	Interference-Causing Equipment Standard
AC	Alternating Current	IEC	International Electrotechnical Commission
AFH	Adaptive Frequency Hopping	IEEE	Institute of Electrical and Electronics Engineers
AM	Amplitude Modulation	IF	Intermediate Frequency
Amp, AMP	Amplifier	ILAC	International Laboratory Accreditation Conference
ANSI	American National Standards Institute	ISED	Innovation, Science and Economic Development Canada
Ant, ANT	Antenna	ISO	International Organization for Standardization
AP	Access Point	JAB	Japan Accreditation Board
ASK	Amplitude Shift Keying	LAN	Local Area Network
Atten., ATT	Attenuator	LIMS	Laboratory Information Management System
AV	Average	MCS	Modulation and Coding Scheme
BPSK	Binary Phase-Shift Keying	MRA	Mutual Recognition Arrangement
BR	Bluetooth Basic Rate	N/A	Not Applicable
BT	Bluetooth	NIST	National Institute of Standards and Technology
BT LE	Bluetooth Low Energy	NS	No signal detect.
BW	BandWidth	NSA	Normalized Site Attenuation
Cal Int	Calibration Interval	NVLAP	National Voluntary Laboratory Accreditation Program
CCK	Complementary Code Keying	OBW	Occupied Band Width
Ch., CH	Channel	OFDM	Orthogonal Frequency Division Multiplexing
CISPR	Comite International Special des Perturbations Radioelectriques	P/M	Power meter
CW	Continuous Wave	PCB	Printed Circuit Board
DBPSK	Differential BPSK	PER	Packet Error Rate
DC	Direct Current	PHY	Physical Layer
D-factor	Distance factor	PK	Peak
DFS	Dynamic Frequency Selection	PN	Pseudo random Noise
DQPSK	Differential QPSK	PRBS	Pseudo-Random Bit Sequence
DSSS	Direct Sequence Spread Spectrum	PSD	Power Spectral Density
EDR	Enhanced Data Rate	QAM	Quadrature Amplitude Modulation
EIRP, e.i.r.p.	Equivalent Isotropically Radiated Power	QP	Quasi-Peak
EMC	ElectroMagnetic Compatibility	QPSK	Quadri-Phase Shift Keying
EMI	ElectroMagnetic Interference	RBW	Resolution Band Width
EN	European Norm	RDS	Radio Data System
ERP, e.r.p.	Effective Radiated Power	RE	Radio Equipment
EU	European Union	RF	Radio Frequency
EUT	Equipment Under Test	RMS	Root Mean Square
Fac.	Factor	RSS	Radio Standards Specifications
FCC	Federal Communications Commission	Rx	Receiving
FHSS	Frequency Hopping Spread Spectrum	SA, S/A	Spectrum Analyzer
FM	Frequency Modulation	SG	Signal Generator
Freq.	Frequency	SVSWR	Site-Voltage Standing Wave Ratio
FSK	Frequency Shift Keying	TR	Test Receiver
GFSK	Gaussian Frequency-Shift Keying	Tx	Transmitting
GNSS	Global Navigation Satellite System	VBW	Video BandWidth
GPS	Global Positioning System	Vert.	Vertical
Hori.	Horizontal	WLAN	Wireless LAN

CONTENTS	PAGE
SECTION 1: Customer Information	5
SECTION 2: Equipment Under Test (EUT).....	5
SECTION 3: Test Specification, Procedures & Results	6
SECTION 4: Operation of EUT during testing	9
SECTION 5: Radiated Spurious Emission.....	11
APPENDIX 1: Test Data	13
Radiated Spurious Emission.....	14
APPENDIX 2: Test Instruments	31
APPENDIX 3: Photographs of Test Setup	32
Radiated Spurious Emission.....	32
Worst Case Position	33

SECTION 1: Customer Information

Company Name	Murata Manufacturing Co., Ltd.
Address	1-10-1 Higashikotari, Nagaokakyo-shi, Kyoto 617-8555 Japan
Telephone Number	+81-50-1737-2801
Contact Person	Kenji Hayashikoshi

The information provided by the customer is as follows;

- Customer, Description of EUT, Model Number of EUT, FCC ID on the cover and other relevant pages
- Operating/Test Mode(s) (Mode(s)) on all the relevant pages
- SECTION 1: Customer Information
- SECTION 2: Equipment Under Test (EUT) other than the Receipt Date and Test Date
- SECTION 4: Operation of EUT during testing

SECTION 2: Equipment Under Test (EUT)

2.1 Identification of EUT

Description	W-LAN + Bluetooth Module
Model Number	1PJ
Serial Number	Refer to SECTION 4.2
Condition	Production prototype (Not for Sale: This sample is equivalent to mass-produced items.)
Modification	No Modification by the test lab
Receipt Date	February 16, 2024
Test Date	February 19, 2024

2.2 Product Description

General Specification

Rating	Typ: DC 3.3 V / Min: DC 3.135 V / Max: DC 3.465 V
--------	---

Radio Specification

WLAN (IEEE802.11b/11g/11n-20)

Equipment Type	Transceiver
Frequency of Operation	2412 MHz to 2462 MHz
Type of Modulation	DSSS, OFDM
Antenna Gain	1.6 dBi

Bluetooth (Low Energy)

Equipment Type	Transceiver
Frequency of Operation	2402 MHz to 2480 MHz
Type of Modulation	GFSK
Antenna Gain	1.6 dBi

* WLAN and Bluetooth do not transmit simultaneously.

SECTION 3: Test Specification, Procedures & Results

3.1 Test Specification

Test Specification	FCC Part 15 Subpart C The latest version on the first day of the testing period
Title	FCC 47 CFR Part 15 Radio Frequency Device Subpart C Intentional Radiators Section 15.207 Conducted limits Section 15.247 Operation within the bands 902-928 MHz, 2400-2483.5 MHz, and 5725-5850 MHz

3.2 Procedures and Results

Item	Test Procedure	Specification	Worst Margin	Results	Remarks
Spurious Emission Restricted Band Edges	FCC: KDB 558074 D01 15.247 Meas Guidance v05r02 ISED: RSS-Gen 6.13	FCC: Section 15.247(d) ISED: RSS-247 5.5 RSS-Gen 8.9 RSS-Gen 8.10	3.0 dB 4880.0 MHz, AV, Vertical	Complied	Radiated (above 30 MHz) *1)
<p>Note: UL Japan, Inc.'s EMI Work Procedures: Work Instructions-ULID-003591 and Work Instructions-ULID-003593. * In case any questions arise about test procedure, ANSI C63.10: 2013 is also referred.</p> <p>*1) Radiated test was selected over 30 MHz based on section 15.247(d) and KDB 558074 D01 15.247 Meas Guidance v05r02 8.5 and 8.6.</p>					

FCC Part 15.31 (e)

This EUT provides the stable voltage constantly to RF Module regardless of input voltage. Therefore, this EUT complies with the requirement.

FCC Part 15.203 Antenna requirement

The antenna is not removable from the EUT. Therefore, the equipment complies with the antenna requirement of Section 15.203.

3.3 Addition to Standard

No addition, exclusion nor deviation has been made from the standard.

3.4 Uncertainty

Measurement uncertainty is not taken into account when stating conformity with a specified requirement. Note: When margins obtained from test results are less than the measurement uncertainty, the test results may exceed the limit.

The following uncertainties have been calculated to provide a confidence level of 95 % using a coverage factor $k = 2$.

Radiated emission

Measurement distance	Frequency range		Unit	Calculated Uncertainty (+/-)
3 m	9 kHz to 30 MHz		dB	3.3
10 m			dB	3.1
3 m	30 MHz to 200 MHz	Horizontal	dB	4.8
		Vertical	dB	5.0
	200 MHz to 1000 MHz	Horizontal	dB	5.1
		Vertical	dB	6.2
10 m	30 MHz to 200 MHz	Horizontal	dB	4.8
		Vertical	dB	4.8
	200 MHz to 1000 MHz	Horizontal	dB	4.9
		Vertical	dB	5.0
3 m	1 GHz to 6 GHz	Test Receiver	dB	5.1
		Spectrum Analyzer	dB	4.9
	6 GHz to 18 GHz	Test Receiver	dB	5.4
		Spectrum Analyzer	dB	5.2
1 m	10 GHz to 18 GHz	Spectrum analyzer	dB	5.0
	18 GHz to 26.5 GHz	Spectrum analyzer	dB	5.6
	26.5 GHz to 40 GHz	Spectrum analyzer	dB	4.9
0.5 m	26.5 GHz to 40 GHz	Spectrum analyzer	dB	4.9
10 m	1 GHz to 18 GHz	Test Receiver	dB	5.4

3.5 Test Location

UL Japan, Inc. Ise EMC Lab.

4383-326 Asama-cho, Ise-shi, Mie-ken 516-0021 Japan

Telephone: +81-596-24-8999

A2LA Certificate Number: 5107.02 / FCC Test Firm Registration Number: 884919

ISED Lab Company Number: 2973C / CAB identifier: JP0002

Test site	Width x Depth x Height (m)	Size of reference ground plane (m) / horizontal conducting plane	Other rooms	Maximum measurement distance
No.1 semi-anechoic chamber	19.2 x 11.2 x 7.7	7.0 x 6.0	No.1 Power source room	10 m
No.2 semi-anechoic chamber	7.5 x 5.8 x 5.2	4.0 x 4.0	-	3 m
No.3 semi-anechoic chamber	12.0 x 8.5 x 5.9	6.8 x 5.75	No.3 Preparation room	3 m
No.3 shielded room	4.0 x 6.0 x 2.7	N/A	-	-
No.4 semi-anechoic chamber	12.0 x 8.5 x 5.9	6.8 x 5.75	No.4 Preparation room	3 m
No.4 shielded room	4.0 x 6.0 x 2.7	N/A	-	-
No.5 semi-anechoic chamber	6.0 x 6.0 x 3.9	6.0 x 6.0	-	-
No.5 measurement room	6.4 x 6.4 x 3.0	6.4 x 6.4	-	-
No.6 shielded room	4.0 x 4.5 x 2.7	4.0 x 4.5	-	-
No.6 measurement room	4.75 x 5.4 x 3.0	4.75 x 4.15	-	-
No.7 shielded room	4.7 x 7.5 x 2.7	4.7 x 7.5	-	-
No.8 measurement room	3.1 x 5.0 x 2.7	3.1 x 5.0	-	-
No.9 measurement room	8.8 x 4.6 x 2.8	2.4 x 2.4	-	-
No.10 shielded room	3.8 x 2.8 x 2.8	3.8 x 2.8	-	-
No.11 measurement room	4.0 x 3.4 x 2.5	N/A	-	-
No.12 measurement room	2.6 x 3.4 x 2.5	N/A	-	-
Large Chamber	16.9 x 22.1 x 10.17	16.9 x 22.1	-	10 m
Small Chamber	5.3 x 6.69 x 3.59	5.3 x 6.69	-	-

3.6 Test Data, Test Instruments, and Test Set Up

Refer to APPENDIX.

SECTION 4: Operation of EUT during testing

4.1 Operating Mode(s)

[WLAN]

Mode	Remarks*
IEEE 802.11b (11b)	1 Mbps, PN9
IEEE 802.11n 20 MHz BW (11n-20)	MCS 0, PN9
*The worst condition was determined based on the test result of Maximum Peak Output Power (Mid Channel)	
Power of the EUT was set by the software as follows; Power Setting: 9.70 dBm *The test was performed at higher power setting that is more stringent than the previous application (date of grant: May 24, 2021). Software: Qualcomm Radio Control Toolkit 3.0.276.0 (Date: February 19, 2024, Storage location: Driven by connected PC)	
*This setting of software is the worst case. Any conditions under the normal use do not exceed the condition of setting. In addition, end users cannot change the settings of the output power of the product. Test operating mode was determined as follows according to "Section 1 of 6 802.11 a/b/g/n testing - Managing Complex Regulatory Approvals - " of TCB Council Workshop October 2009.	

*The Details of Operating Mode(s)

Test Item	Operating Mode	Tested Frequency
Radiated Spurious Emission (Below 1 GHz)	Tx 11n-20 *1)	2437 MHz
Radiated Spurious Emission (Above 1 GHz)	Tx 11b *2) Tx 11n-20	2412 MHz 2437 MHz 2462 MHz
*1) The mode was tested as a representative, because it had the highest power at antenna terminal test. *2) Since 11g and 11n-20 have the same modulation method and no differences in transmitting specification, test was performed on the representative mode that had the highest peak output power		

[BT LE]

Mode	Remarks*
Bluetooth Low Energy (BT LE)	Maximum Packet Size, PRBS9
*Power of the EUT was set by the software as follows; Power Setting: minus_1dBfrom0_bdaddr_no tag33 153_minus0.3 (d9a957a8941bb09470601acc79fb579f) Software: Qualcomm Radio Control Toolkit 3.0.276.0 (Date: February 19, 2024, Storage location: Driven by connected PC)	
*This setting of software is the worst case. Any conditions under the normal use do not exceed the condition of setting. In addition, end users cannot change the settings of the output power of the product.	

*The Details of Operating Mode(s)

Test Item	Operating Mode	Tested Frequency
Radiated Spurious Emission (Below 1 GHz)	Tx BT LE *1)	2440 MHz
Radiated Spurious Emission (Above 1 GHz),	Tx BT LE	2402 MHz 2440 MHz 2480 MHz
*1) Spurious emissions for frequencies below 1 GHz were limited to the channel that had the highest power during the antenna terminal test, as preliminary testing indicated that changing the operating frequency had no significant impact on the emissions in those frequency bands.		

4.2 Configuration and Peripherals

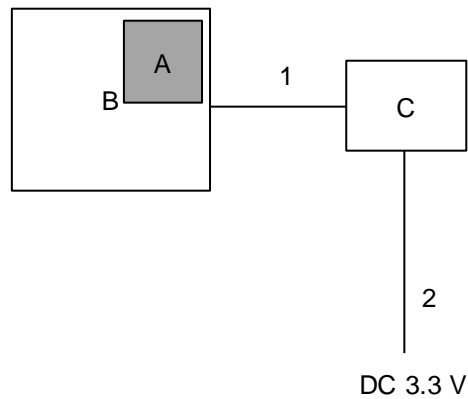

* Cabling and setup(s) were taken into consideration and test data was taken under worse case conditions.

Description of EUT and Support Equipment

No.	Item	Model number	Serial Number	Manufacturer	Remarks
A	W-LAN + Bluetooth Module	1PJ	dc:fe:23:6a:ae (MAC address)	Murata Manufacturing Co., Ltd.	EUT
B	Jig board	D28	-	Murata Manufacturing Co., Ltd.	-
C	Jig board	P2ML11420	-	Murata Manufacturing Co., Ltd.	-

List of Cables Used

No.	Name	Length (m)	Shield		Remarks
			Cable	Connector	
1	Signal Cable	0.1	Unshielded	Unshielded	-
2	DC Cable	3.0	Unshielded	Unshielded	-

SECTION 5: Radiated Spurious Emission

Test Procedure

It was measured based on "8.5 and 8.6 of KDB 558074 D01 15.247 Meas Guidance v05r02".

[For below 1 GHz]

EUT was placed on a urethane platform of nominal size, 0.5 m by 1.0 m, raised 0.8 m above the conducting ground plane. The Radiated Electric Field Strength has been measured in a Semi Anechoic Chamber with a ground plane.

[For above 1 GHz]

EUT was placed on a urethane platform of nominal size, 0.5 m by 0.5 m, raised 1.5 m above the conducting ground plane. The Radiated Electric Field Strength has been measured in a Semi Anechoic Chamber with absorbent materials lined on a ground plane. Test antenna was aimed at the EUT for receiving the maximum signal and always kept within the illumination area of the 3 dB beamwidth of the antenna.

The height of the measuring antenna varied between 1 m and 4 m and EUT was rotated a full revolution in order to obtain the maximum value of the electric field strength.

The measurements were performed for both vertical and horizontal antenna polarization with the Test Receiver, or the Spectrum Analyzer.

The measurements were made with the following detector function of the test receiver and the Spectrum analyzer (in linear mode).

The test was made with the detector (RBW/VBW) in the following table.

When using Spectrum analyzer, the test was made with adjusting span to zero by using peak hold.

Test Antennas are used as below;

Frequency	30 MHz to 200 MHz	200 MHz to 1 GHz	Above 1 GHz
Antenna Type	Biconical	Logperiodic	Horn

In any 100 kHz bandwidth outside the restricted band in which the spread spectrum intentional radiator is operating, the radio frequency power that is produced by the intentional radiator confirmed 20 dB below that in the 100 kHz bandwidth within the band that contains the highest level of the desired power, based on a radiated measurement.

20 dBc was applied to the frequency over the limit of FCC 15.209 / Table 4 of RSS-Gen 8.9(ISED) and outside the restricted band of FCC15.205 / Table 6 of RSS-Gen 8.10 (ISED).

Frequency	Below 1 GHz	Above 1 GHz		20 dBc
Instrument Used	Test Receiver	Spectrum Analyzer		Spectrum Analyzer
Detector	QP	PK	AV	PK
IF Bandwidth	BW 120 kHz	RBW: 1 MHz VBW: 3 MHz	For WLAN RBW: 1 MHz VBW: 1/T Detector: Power Averaging (RMS) For BT LE RBW: 1 MHz VBW: 3 MHz Detector: Power Averaging (RMS) Trace : 100 trace Duty Factor was added to The results.	RBW: 100 kHz VBW: 300 kHz

Figure 2: Test Setup

Below 1 GHz

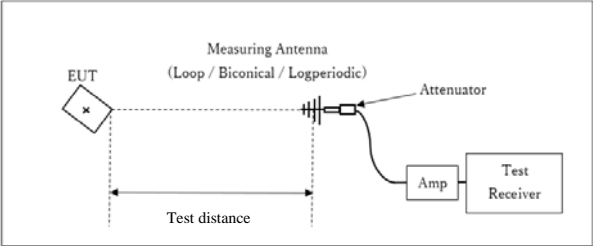

* : Center of turn table

Test Distance: 3 m

1 GHz to 6 GHz

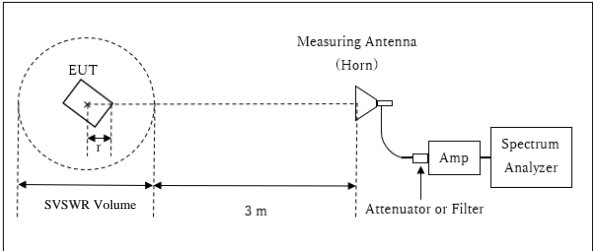

r : Radius of an outer periphery of EUT
 * : Center of turn table

Distance Factor: $20 \times \log (3.95 \text{ m} / 3.0 \text{ m}) = 2.39 \text{ dB}$
 * Test Distance: $(3 + \text{SVSWR Volume} / 2) - r = 3.95 \text{ m}$

SVSWR Volume : 2.0 m
 (SVSWR Volume has been calibrated based on CISPR 16-1-4.)
 r = 0.05 m

6 GHz to 10 GHz

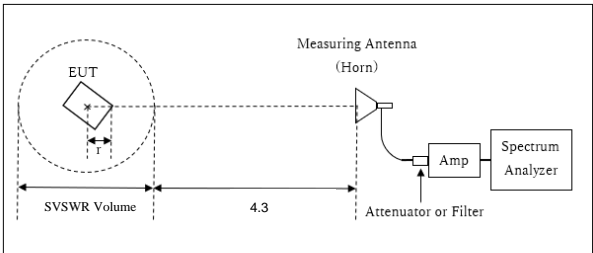

r : Radius of an outer periphery of EUT
 * : Center of turn table

Distance Factor: $20 \times \log (4.95 \text{ m} / 3.0 \text{ m}) = 4.35 \text{ dB}$
 * Test Distance: $(4.3 + \text{SVSWR Volume} / 2) - r = 4.95 \text{ m}$

SVSWR Volume : 1.4 m
 (SVSWR Volume has been calibrated based on CISPR 16-1-4.)
 r = 0.05 m

10 GHz to 26.5 GHz

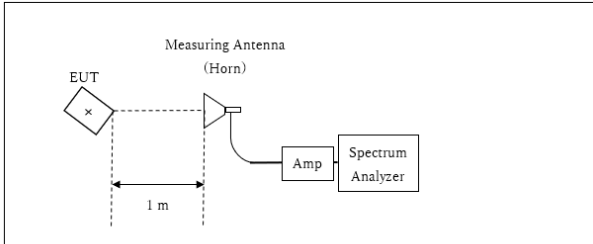

* : Center of turn table

Distance Factor: $20 \times \log (1.0 \text{ m} / 3.0 \text{ m}) = -9.5 \text{ dB}$
 *Test Distance: 1 m

The carrier level and noise levels were confirmed at each position of X, Y and Z axes of EUT to see the position of maximum noise, and the test was made at the position that has the maximum noise.

Test results are rounded off and limit are rounded down, so some differences might be observed.

Measurement Range : 30 MHz to 26.5 GHz
 Test Data : APPENDIX
 Test Result : Pass

APPENDIX 1: Test Data

Duty confirmation

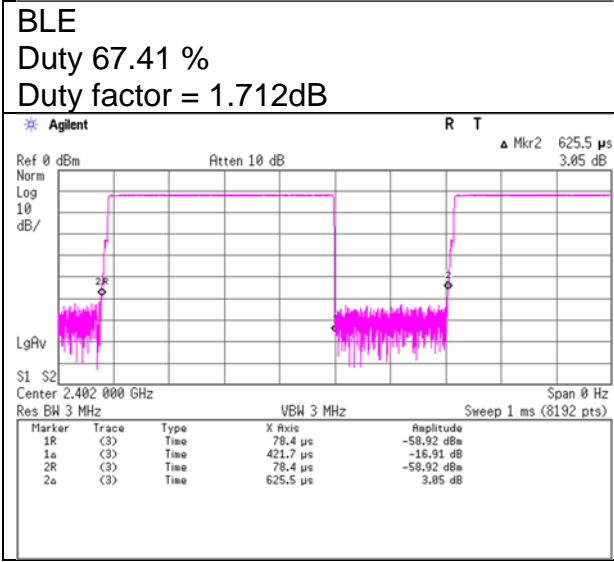
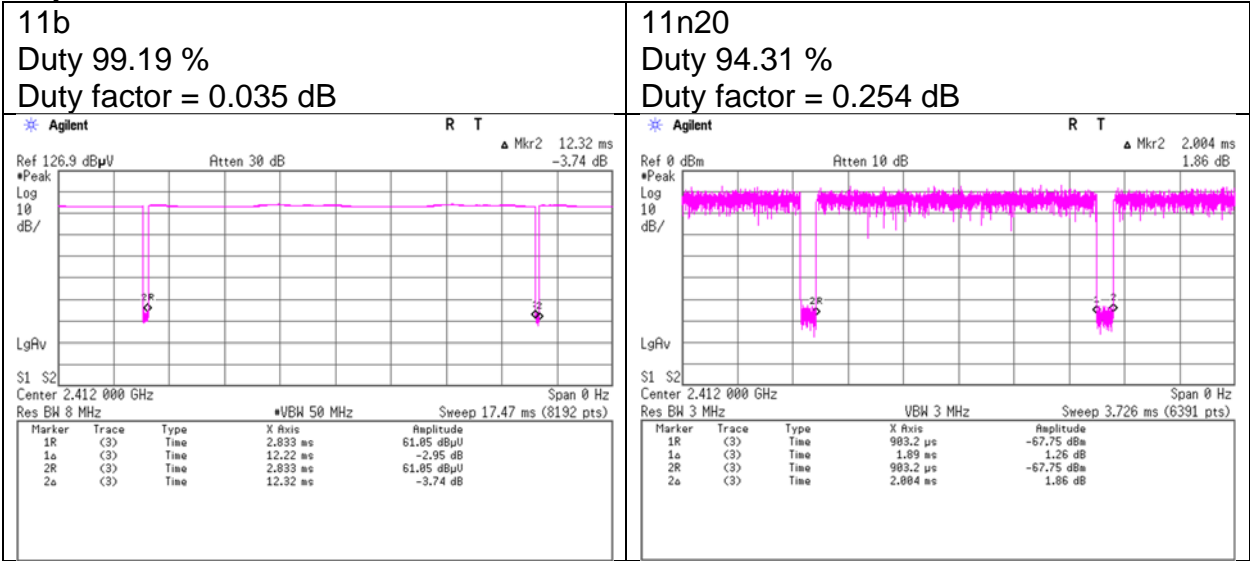

Radiated Spurious Emission

Test place	Ise EMC Lab.	No.3
Semi Anechoic Chamber	No.3	No.3
Date	February 18, 2024	February 19, 2024
Temperature / Humidity	23 deg. C / 50 % RH	20 deg. C / 60 % RH
Engineer	Tomohisa Nakagawa	Tetsuro Yoshida
Mode	(1 GHz to 10 GHz)	(10 GHz to 26.5 GHz)
	Tx 11b 2412 MHz	

Polarity	Frequency	Reading (QP / PK)	Reading (AV)	Ant. Factor	Loss	Gain	Duty Factor	Result (QP / PK)	Result (AV)	Limit (QP / PK)	Limit (AV)	Margin (QP / PK)	Margin (AV)	Remark
[Hori/Vert]	[MHz]	[dBuV]	[dBuV]	[dB/m]	[dB]	[dB]	[dB]	[dBuV/m]	[dBuV/m]	[dBuV/m]	[dBuV/m]	[dB]	[dB]	
Hori.	2390.0	53.0	44.9	27.5	5.4	32.4	-	53.5	45.4	73.9	53.9	20.4	8.5	
Hori.	4824.0	40.5	33.5	31.4	7.6	31.4	-	48.0	41.1	73.9	53.9	25.9	12.9	Floor noise
Hori.	7236.0	35.4	29.3	35.7	10.8	32.3	-	49.5	43.4	73.9	53.9	24.4	10.5	Floor noise
Hori.	9648.0	35.5	28.3	35.8	11.5	33.0	-	49.9	42.6	73.9	53.9	24.0	11.3	Floor noise
Vert.	2390.0	51.1	42.6	27.5	5.4	32.4	-	51.6	43.1	73.9	53.9	22.3	10.8	
Vert.	4824.0	40.9	33.1	31.4	7.6	31.4	-	48.4	40.7	73.9	53.9	25.5	13.2	Floor noise
Vert.	7236.0	36.2	29.6	35.7	10.8	32.3	-	50.3	43.7	73.9	53.9	23.6	10.2	Floor noise
Vert.	9648.0	35.5	29.2	35.8	11.5	33.0	-	49.8	43.5	73.9	53.9	24.1	10.4	Floor noise

Result (QP / PK) = Reading + Ant Factor + Loss (Cable+Attenuator+Filter+Distance factor(above 1 GHz)) - Gain(Amplifier)
 Result (AV)= Reading + Ant Factor + Loss (Cable+Attenuator+Filter+Distance factor(above 1 GHz)) - Gain(Amplifier) + Duty factor
 *Other frequency noises omitted in this report were not seen or had enough margin (more than 20 dB).
 *QP detector was used up to 1GHz.

20dBc Data Sheet

Polarity	Frequency	Reading (PK)	Ant Factor	Loss	Gain	Result	Limit	Margin	Remark
[Hori/Vert]	[MHz]	[dBuV]	[dB/m]	[dB]	[dB]	[dBuV/m]	[dBuV/m]	[dB]	
Hori.	2412.0	98.5	27.5	5.4	32.4	99.0	-	-	Carrier
Hori.	2400.0	44.7	27.5	5.4	32.4	45.2	79.0	33.8	
Vert.	2412.0	98.4	27.5	5.4	32.4	98.9	-	-	Carrier
Vert.	2400.0	42.9	27.5	5.4	32.4	43.4	78.9	35.5	

Result = Reading + Ant Factor + Loss (Cable+Attenuator+Filter+Distance factor(above 1 GHz)) - Gain(Amplifier)
 Distance factor:
 1 GHz - 6 GHz 20log (3.95 m / 3.0 m) = 2.39 dB
 6 GHz - 10 GHz 20log (4.3 m / 3.0 m) = 4.35 dB
 10 GHz - 26.5 GHz 20log (1.0 m / 3.0 m) = -9.5 dB

**Radiated Spurious Emission
 (Reference Plot for band-edge)**

Test place	Ise EMC Lab.
Semi Anechoic Chamber	No.3
Date	February 18, 2024
Temperature / Humidity	23 deg. C / 50 % RH
Engineer	Tomohisa Nakagawa
	(1 GHz to 6 GHz)
Mode	Tx 11b 2412 MHz

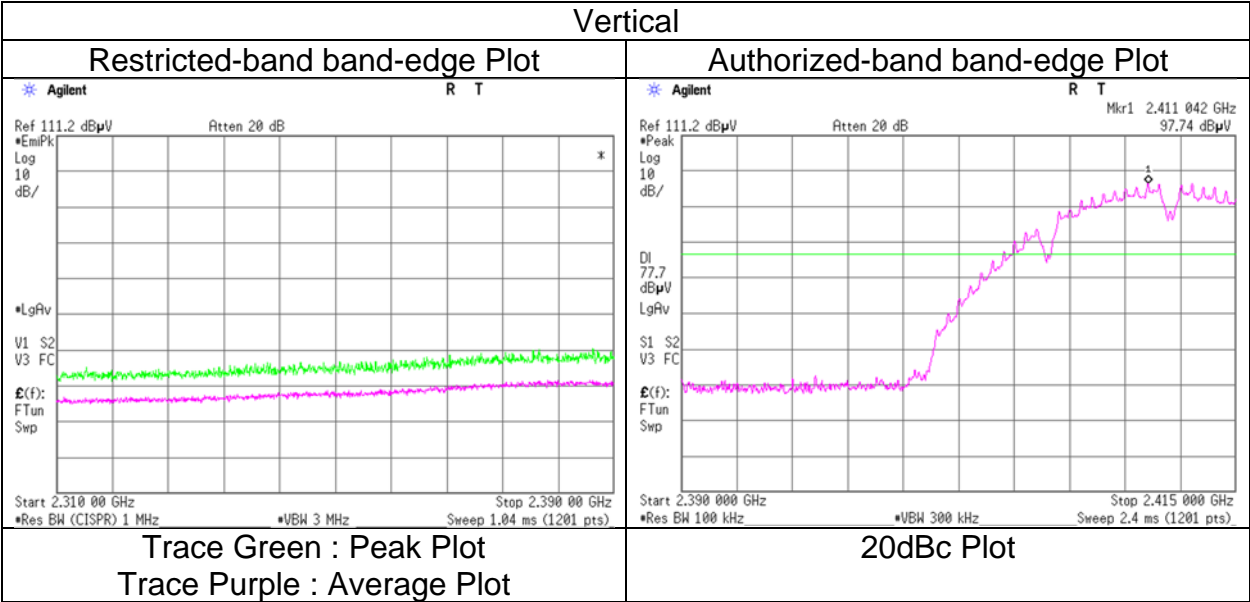
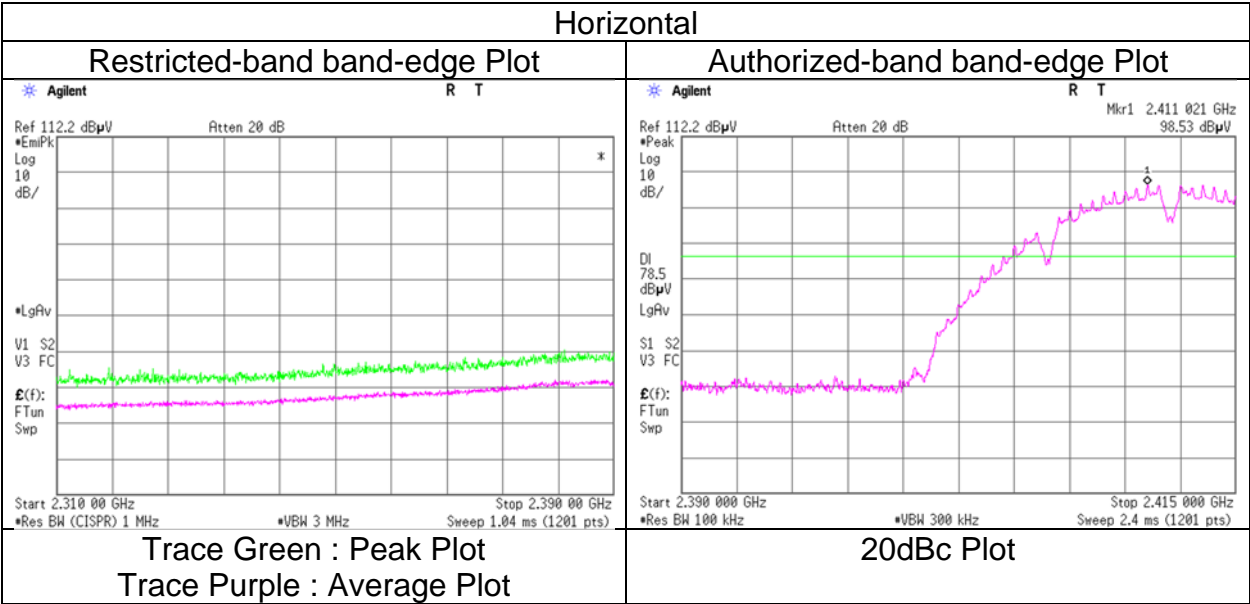

* The measurement was conducted for a sufficiently long enough time to detect any possible spurious emissions.
 Final result of restricted band edge and authorized band edge were shown in tabular data.

Radiated Spurious Emission

Test place	Ise EMC Lab.	
Semi Anechoic Chamber	No.3	No.3
Date	February 18, 2024	February 19, 2024
Temperature / Humidity	23 deg. C / 50 % RH	20 deg. C / 60 % RH
Engineer	Tomohisa Nakagawa	Tetsuro Yoshida
	(1 GHz to 10 GHz)	(10 GHz to 26.5 GHz)
Mode	Tx 11b 2437 MHz	

Polarity	Frequency	Reading (QP / PK)	Reading (AV)	Ant. Factor	Loss	Gain	Duty Factor	Result (QP / PK)	Result (AV)	Limit (QP / PK)	Limit (AV)	Margin (QP / PK)	Margin (AV)	Remark
[Hori/Vert]	[MHz]	[dBuV]	[dBuV]	[dB/m]	[dB]	[dB]	[dB]	[dBuV/m]	[dBuV/m]	[dBuV/m]	[dBuV/m]	[dB]	[dB]	
Hori.	4874.0	40.4	34.2	31.4	7.6	31.4	-	47.9	41.7	73.9	53.9	26.0	12.2	Floor noise
Hori.	7311.0	36.5	29.1	35.6	10.8	32.3	-	50.6	43.2	73.9	53.9	23.3	10.7	Floor noise
Hori.	9748.0	35.7	29.1	36.0	11.6	33.0	-	50.3	43.7	73.9	53.9	23.6	10.2	Floor noise
Vert.	4874.0	40.9	34.6	31.4	7.6	31.4	-	48.5	42.2	73.9	53.9	25.5	11.7	Floor noise
Vert.	7311.0	36.0	29.0	35.6	10.8	32.3	-	50.1	43.2	73.9	53.9	23.8	10.8	Floor noise
Vert.	9748.0	35.0	29.0	36.0	11.6	33.0	-	49.5	43.6	73.9	53.9	24.4	10.3	Floor noise

Result (QP / PK) = Reading + Ant Factor + Loss (Cable+Attenuator+Filter+Distance factor(above 1 GHz)) - Gain(Amplifier)
 Result (AV) = Reading + Ant Factor + Loss (Cable+Attenuator+Filter+Distance factor(above 1 GHz)) - Gain(Amplifier) + Duty factor
 *Other frequency noises omitted in this report were not seen or had enough margin (more than 20 dB).
 *QP detector was used up to 1GHz.

Distance factor:	1 GHz - 6 GHz	20log (3.95 m / 3.0 m) = 2.39 dB
	6 GHz - 10 GHz	20log (4.3 m / 3.0 m) = 4.35 dB
	10 GHz - 26.5 GHz	20log (1.0 m / 3.0 m) = -9.5 dB

Radiated Spurious Emission

Test place	Ise EMC Lab.	
Semi Anechoic Chamber	No.3	No.3
Date	February 18, 2024	February 19, 2024
Temperature / Humidity	23 deg. C / 50 % RH	20 deg. C / 60 % RH
Engineer	Tomohisa Nakagawa	Tetsuro Yoshida
Mode	(1 GHz to 10 GHz)	(10 GHz to 26.5 GHz)
	Tx 11b 2462 MHz	

Polarity	Frequency	Reading (QP / PK)	Reading (AV)	Ant. Factor	Loss	Gain	Duty Factor	Result (QP / PK)	Result (AV)	Limit (QP / PK)	Limit (AV)	Margin (QP / PK)	Margin (AV)	Remark
[Hori/Vert]	[MHz]	[dBuV]	[dBuV]	[dB/m]	[dB]	[dB]	[dB]	[dBuV/m]	[dBuV/m]	[dBuV/m]	[dBuV/m]	[dB]	[dB]	
Hori.	2483.5	52.6	43.2	27.4	5.5	32.4	-	53.0	43.7	73.9	53.9	20.9	10.2	
Hori.	3282.8	42.0	36.2	28.3	5.9	32.0	-	44.3	38.4	73.9	53.9	29.6	15.5	
Hori.	4924.0	39.6	33.5	31.5	7.6	31.4	-	47.3	41.1	73.9	53.9	26.6	12.8	Floor noise
Hori.	7386.0	36.0	30.0	35.6	10.9	32.4	-	50.1	44.0	73.9	53.9	23.8	9.9	Floor noise
Hori.	9848.0	36.1	29.9	36.2	11.6	33.0	-	50.9	44.6	73.9	53.9	23.0	9.3	Floor noise
Vert.	2483.5	51.6	43.0	27.4	5.5	32.4	-	52.0	43.5	73.9	53.9	21.9	10.4	
Vert.	3282.8	42.0	35.1	28.3	5.9	32.0	-	44.2	37.3	73.9	53.9	29.7	16.6	
Vert.	4924.0	40.1	33.0	31.5	7.6	31.4	-	47.7	40.6	73.9	53.9	26.2	13.3	Floor noise
Vert.	7386.0	36.2	30.1	35.6	10.9	32.4	-	50.3	44.1	73.9	53.9	23.6	9.8	Floor noise
Vert.	9848.0	35.5	30.3	36.2	11.6	33.0	-	50.2	45.1	73.9	53.9	23.7	8.9	Floor noise

Result (QP / PK) = Reading + Ant Factor + Loss (Cable+Attenuator+Filter+Distance factor(above 1 GHz)) - Gain(Amplifier)
 Result (AV)= Reading + Ant Factor + Loss (Cable+Attenuator+Filter+Distance factor(above 1 GHz)) - Gain(Amplifier) + Duty factor
 *Other frequency noises omitted in this report were not seen or had enough margin (more than 20 dB).
 *QP detector was used up to 1GHz.

Distance factor: 1 GHz - 6 GHz 20log (3.95 m / 3.0 m) = 2.39 dB
 6 GHz - 10 GHz 20log (4.3 m / 3.0 m) = 4.35 dB
 10 GHz - 26.5 GHz 20log (1.0 m / 3.0 m) = -9.5 dB

**Radiated Spurious Emission
(Reference Plot for band-edge)**

Test place
Semi Anechoic Chamber
Date
Temperature / Humidity
Engineer

Mode

Ise EMC Lab.
No.3
February 18, 2024
23 deg. C / 50 % RH
Tomohisa Nakagawa
(1 GHz to 6 GHz)
Tx 11b 2462 MHz

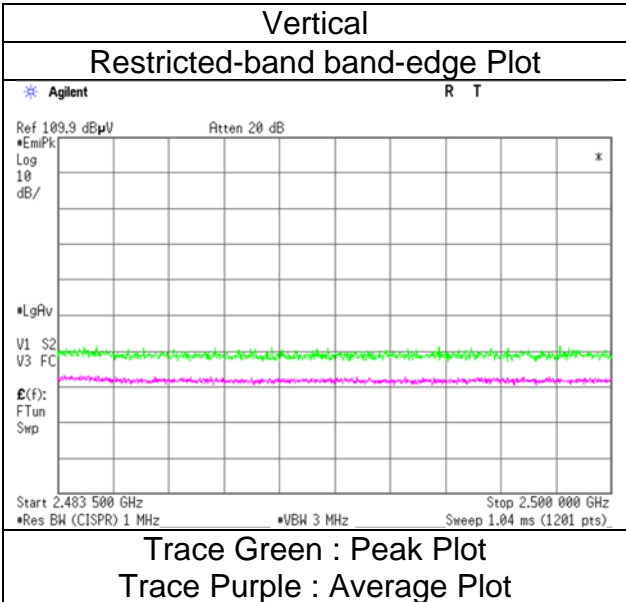
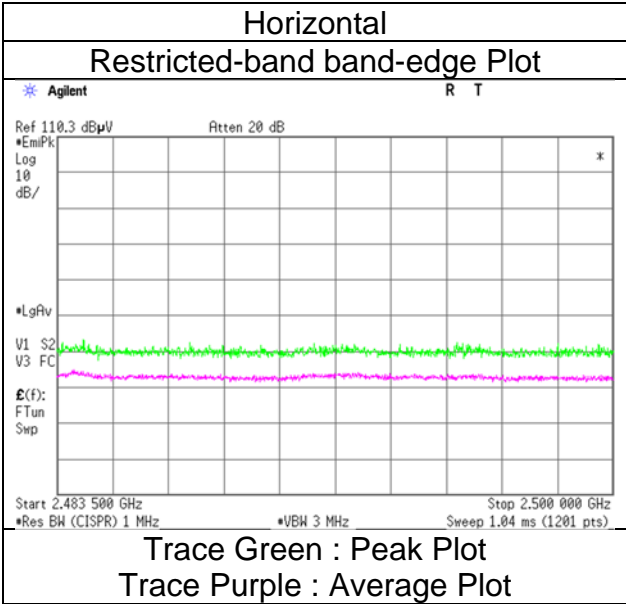

* The measurement was conducted for a sufficiently long enough time to detect any possible spurious emissions.
Final result of restricted band edge was shown in tabular data.

Radiated Spurious Emission

Test place	Ise EMC Lab.	No.3
Semi Anechoic Chamber	No.3	No.3
Date	February 18, 2024	February 19, 2024
Temperature / Humidity	23 deg. C / 50 % RH	20 deg. C / 60 % RH
Engineer	Tomohisa Nakagawa	Tetsuro Yoshida
Mode	(1 GHz to 10 GHz) Tx 11n-20 2412 MHz	(10 GHz to 26.5 GHz)

Polarity	Frequency	Reading (QP / PK)	Reading (AV)	Ant. Factor	Loss	Gain	Duty Factor	Result (QP / PK)	Result (AV)	Limit (QP / PK)	Limit (AV)	Margin (QP / PK)	Margin (AV)	Remark
[Hori/Vert]	[MHz]	[dBuV]	[dBuV]	[dB/m]	[dB]	[dB]	[dB]	[dBuV/m]	[dBuV/m]	[dBuV/m]	[dBuV/m]	[dB]	[dB]	
Hori.	2390.0	55.0	44.7	27.5	5.4	32.4	0.3	55.5	45.5	73.9	53.9	18.5	8.4	*1)
Hori.	4824.0	39.5	33.3	31.4	7.6	31.4	-	47.0	40.8	73.9	53.9	26.9	13.1	Floor noise
Hori.	7236.0	35.7	29.9	35.7	10.8	32.3	-	49.8	44.0	73.9	53.9	24.1	9.9	Floor noise
Hori.	9648.0	36.0	29.6	35.8	11.5	33.0	-	50.4	44.0	73.9	53.9	23.5	10.0	Floor noise
Vert.	2390.0	51.2	42.6	27.5	5.4	32.4	0.3	51.7	43.4	73.9	53.9	22.2	10.5	*1)
Vert.	4824.0	40.7	30.6	31.4	7.6	31.4	-	48.2	38.1	73.9	53.9	25.7	15.8	Floor noise
Vert.	7236.0	36.4	29.6	35.7	10.8	32.3	-	50.5	43.7	73.9	53.9	23.4	10.2	Floor noise
Vert.	9648.0	35.8	30.1	35.8	11.5	33.0	-	50.1	44.4	73.9	53.9	23.8	9.5	Floor noise

Result (QP / PK) = Reading + Ant Factor + Loss (Cable+Attenuator+Filter+Distance factor(above 1 GHz)) - Gain(Amplifier)
 Result (AV)= Reading + Ant Factor + Loss (Cable+Attenuator+Filter+Distance factor(above 1 GHz)) - Gain(Amplifier) + Duty factor
 *Other frequency noises omitted in this report were not seen or had enough margin (more than 20 dB).
 *QP detector was used up to 1GHz.
 *1) Not Out of Band emission(Leakage Power)

20dBc Data Sheet

Polarity	Frequency	Reading (PK)	Ant Factor	Loss	Gain	Result	Limit	Margin	Remark
[Hori/Vert]	[MHz]	[dBuV]	[dB/m]	[dB]	[dB]	[dBuV/m]	[dBuV/m]	[dB]	
Hori.	2412.0	96.0	27.5	5.4	32.4	96.5	-	-	Carrier
Hori.	2400.0	57.4	27.5	5.4	32.4	57.9	76.5	18.6	
Vert.	2412.0	95.1	27.5	5.4	32.4	95.6	-	-	Carrier
Vert.	2400.0	54.7	27.5	5.4	32.4	55.2	75.6	20.4	

Result = Reading + Ant Factor + Loss (Cable+Attenuator+Filter+Distance factor(above 1 GHz)) - Gain(Amplifier)

Distance factor:
 1 GHz - 6 GHz 20log (3.95 m / 3.0 m) = 2.39 dB
 6 GHz - 10 GHz 20log (4.3 m / 3.0 m) = 4.35 dB
 10 GHz - 26.5 GHz 20log (1.0 m / 3.0 m) = -9.5 dB

Radiated Spurious Emission (Reference Plot for band-edge)

Test place	Ise EMC Lab.
Semi Anechoic Chamber	No.3
Date	February 18, 2024
Temperature / Humidity	23 deg. C / 50 % RH
Engineer	Tomohisa Nakagawa
	(1 GHz to 10 GHz)
Mode	Tx 11n-20 2412 MHz

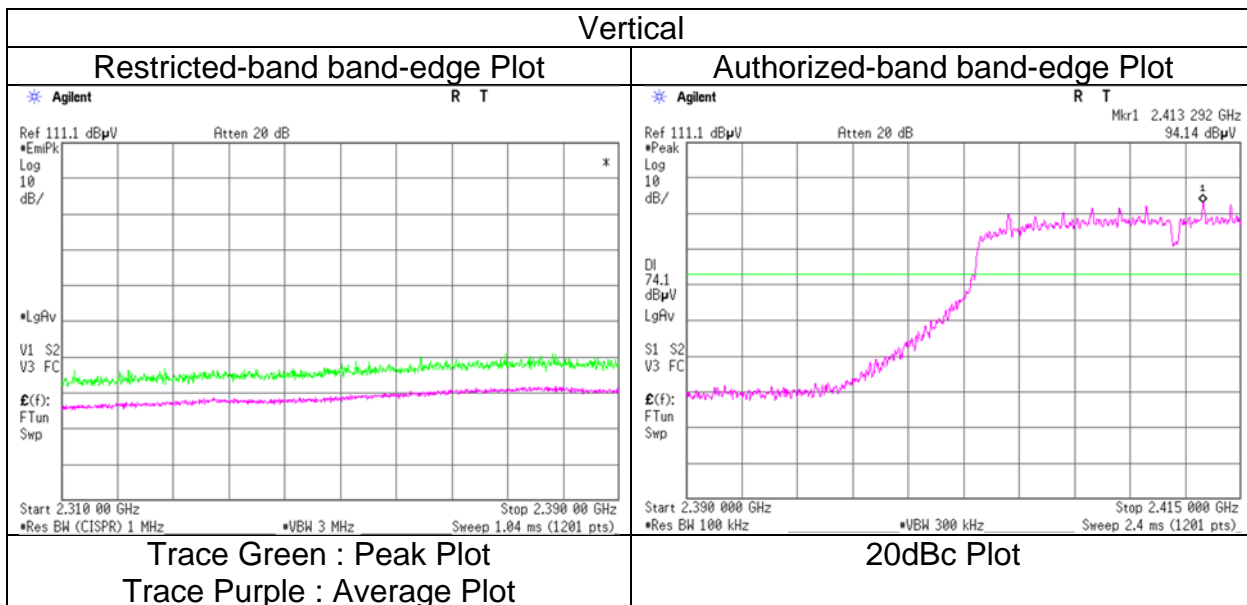
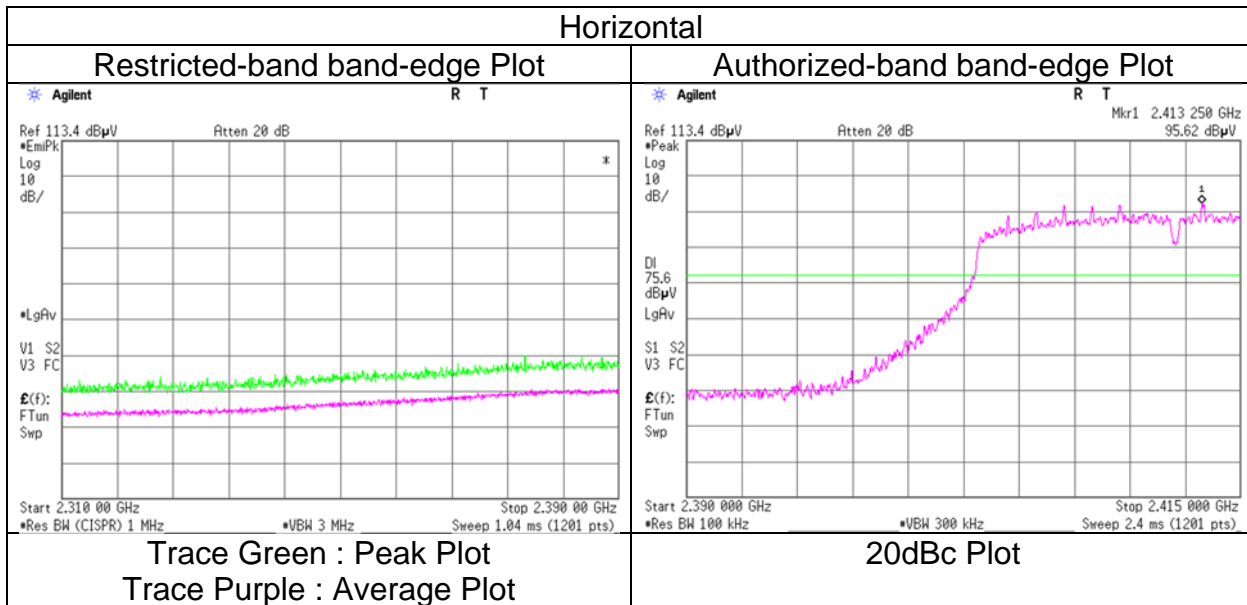

* The measurement was conducted for a sufficiently long enough time to detect any possible spurious emissions.
Final result of restricted band edge and authorized band edge were shown in tabular data.

Radiated Spurious Emission

Test place	Ise EMC Lab.	No.3
Semi Anechoic Chamber	No.3	No.3
Date	February 18, 2024	February 19, 2024
Temperature / Humidity	23 deg. C / 50 % RH	20 deg. C / 60 % RH
Engineer	Tomohisa Nakagawa	Tetsuro Yoshida
Mode	(1 GHz to 10 GHz)	(10 GHz to 26.5 GHz, Below 1 GHz)
	Tx 11n-20 2437 MHz	

Polarity	Frequency	Reading (QP / PK)	Reading (AV)	Ant. Factor	Loss	Gain	Duty Factor	Result (QP / PK)	Result (AV)	Limit (QP / PK)	Limit (AV)	Margin (QP / PK)	Margin (AV)	Remark
[Hori/Vert]	[MHz]	[dBuV]	[dBuV]	[dB/m]	[dB]	[dB]	[dB]	[dBuV/m]	[dBuV/m]	[dBuV/m]	[dBuV/m]	[dB]	[dB]	
Hori.	50.1	22.7	-	9.9	7.2	32.2	-	7.7	-	40.0	-	32.3	-	
Hori.	68.8	22.6	-	9.0	7.5	32.2	-	7.0	-	40.0	-	33.0	-	
Hori.	112.8	29.3	-	10.6	8.0	32.1	-	15.9	-	43.5	-	27.7	-	
Hori.	137.6	25.3	-	11.7	8.3	32.1	-	13.2	-	43.5	-	30.3	-	
Hori.	368.8	21.4	-	15.0	10.1	32.0	-	14.6	-	46.0	-	31.4	-	Floor noise
Hori.	469.7	21.4	-	17.0	10.8	32.0	-	17.2	-	46.0	-	28.8	-	Floor noise
Hori.	4874.0	40.7	33.6	31.4	7.6	31.4	-	48.3	41.2	73.9	53.9	25.6	12.7	Floor noise
Hori.	7311.0	36.0	29.6	35.6	10.8	32.3	-	50.1	43.7	73.9	53.9	23.8	10.2	Floor noise
Hori.	9748.0	37.0	29.2	36.0	11.6	33.0	-	51.5	43.8	73.9	53.9	22.4	10.1	Floor noise
Vert.	50.1	30.8	-	9.9	7.2	32.2	-	15.8	-	40.0	-	24.2	-	
Vert.	68.8	29.0	-	9.0	7.5	32.2	-	13.4	-	40.0	-	26.6	-	
Vert.	112.8	31.4	-	10.6	8.0	32.1	-	18.0	-	43.5	-	25.6	-	
Vert.	137.6	31.9	-	11.7	8.3	32.1	-	19.8	-	43.5	-	23.7	-	
Vert.	368.8	21.6	-	15.0	10.1	32.0	-	14.8	-	46.0	-	31.2	-	Floor noise
Vert.	469.7	21.3	-	17.0	10.8	32.0	-	17.1	-	46.0	-	28.9	-	Floor noise
Vert.	4874.0	40.1	32.5	31.4	7.6	31.4	-	47.6	40.0	73.9	53.9	26.3	13.9	Floor noise
Vert.	7311.0	36.2	29.5	35.6	10.8	32.3	-	50.3	43.6	73.9	53.9	23.6	10.3	Floor noise
Vert.	9748.0	35.9	30.2	36.0	11.6	33.0	-	50.5	44.8	73.9	53.9	23.4	9.1	Floor noise

Result (QP / PK) = Reading + Ant Factor + Loss (Cable+Attenuator+Filter+Distance factor(above 1 GHz)) - Gain(Amplifier)
 Result (AV)= Reading + Ant Factor + Loss (Cable+Attenuator+Filter+Distance factor(above 1 GHz)) - Gain(Amplifier) + Duty factor
 *Other frequency noises omitted in this report were not seen or had enough margin (more than 20 dB).
 *QP detector was used up to 1GHz.

Distance factor: 1 GHz - 6 GHz 20log (3.95 m / 3.0 m) = 2.39 dB
 6 GHz - 10 GHz 20log (4.3 m / 3.0 m) = 4.35 dB
 10 GHz - 26.5 GHz 20log (1.0 m / 3.0 m) = -9.5 dB

Radiated Spurious Emission

Test place	Ise EMC Lab.	No.3
Semi Anechoic Chamber	No.3	No.3
Date	February 18, 2024	February 19, 2024
Temperature / Humidity	23 deg. C / 50 % RH	20 deg. C / 60 % RH
Engineer	Tomohisa Nakagawa	Tetsuro Yoshida
	(1 GHz to 10 GHz)	(10 GHz to 26.5 GHz)
Mode	Tx 11n-20 2462 MHz	

Polarity	Frequency	Reading	Reading	Ant.	Loss	Gain	Duty	Result	Result	Limit	Limit	Margin	Margin	Remark
[Hori/Vert]	[MHz]	(QP / PK)	(AV)	Factor	[dB]	[dB]	Factor	(QP / PK)	(AV)	(QP / PK)	(AV)	(QP / PK)	(AV)	
		[dBuV]	[dBuV]	[dB/m]			[dB]	[dBuV/m]	[dBuV/m]	[dBuV/m]	[dBuV/m]	[dB]	[dB]	
Hori.	2483.5	52.2	43.8	27.4	5.5	32.4	0.3	52.6	44.5	73.9	53.9	21.3	9.4	*1)
Hori.	3282.8	42.6	37.2	28.3	5.9	32.0	0.3	44.8	39.7	73.9	53.9	29.1	14.2	
Hori.	4924.0	41.1	33.3	31.5	7.6	31.4	-	48.8	41.0	73.9	53.9	25.1	12.9	Floor noise
Hori.	7386.0	35.7	29.2	35.6	10.9	32.4	-	49.7	43.3	73.9	53.9	24.2	10.6	Floor noise
Hori.	9848.0	35.7	29.2	36.2	11.6	33.0	-	50.4	44.0	73.9	53.9	23.5	9.9	Floor noise
Vert.	2483.5	50.3	41.6	27.4	5.5	32.4	0.3	50.7	42.3	73.9	53.9	23.2	11.6	*1)
Vert.	3282.8	44.0	37.0	28.3	5.9	32.0	0.3	46.3	39.5	73.9	53.9	27.6	14.4	
Vert.	4924.0	39.2	31.8	31.5	7.6	31.4	-	46.8	39.5	73.9	53.9	27.1	14.4	Floor noise
Vert.	7386.0	35.8	29.5	35.6	10.9	32.4	-	49.8	43.5	73.9	53.9	24.1	10.4	Floor noise
Vert.	9848.0	36.2	29.5	36.2	11.6	33.0	-	51.0	44.3	73.9	53.9	22.9	9.7	Floor noise

Result (QP / PK) = Reading + Ant Factor + Loss (Cable+Attenuator+Filter+Distance factor(above 1 GHz)) - Gain(Amplifier)
 Result (AV) = Reading + Ant Factor + Loss (Cable+Attenuator+Filter+Distance factor(above 1 GHz)) - Gain(Amplifier) + Duty factor
 *Other frequency noises omitted in this report were not seen or had enough margin (more than 20 dB).
 *QP detector was used up to 1 GHz.
 *1) Not Out of Band emission(Leakage Power)

Distance factor:	1 GHz - 6 GHz	20log (3.95 m / 3.0 m) = 2.39 dB
	6 GHz - 10 GHz	20log (4.3 m / 3.0 m) = 4.35 dB
	10 GHz - 26.5 GHz	20log (1.0 m / 3.0 m) = -9.5 dB

Radiated Spurious Emission (Reference Plot for band-edge)

Test place
Semi Anechoic Chamber
Date
Temperature / Humidity
Engineer

Mode

Ise EMC Lab.
No.3
February 18, 2024
23 deg. C / 50 % RH
Tomohisa Nakagawa
(1 GHz to 10 GHz)
Tx 11n-20 2462 MHz

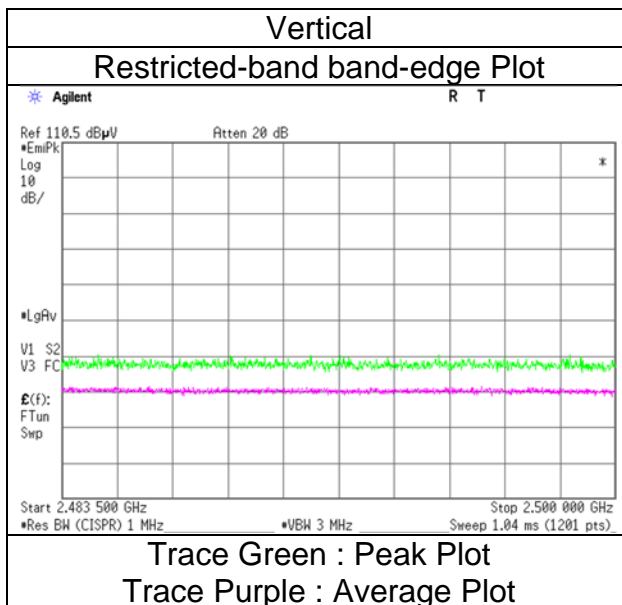
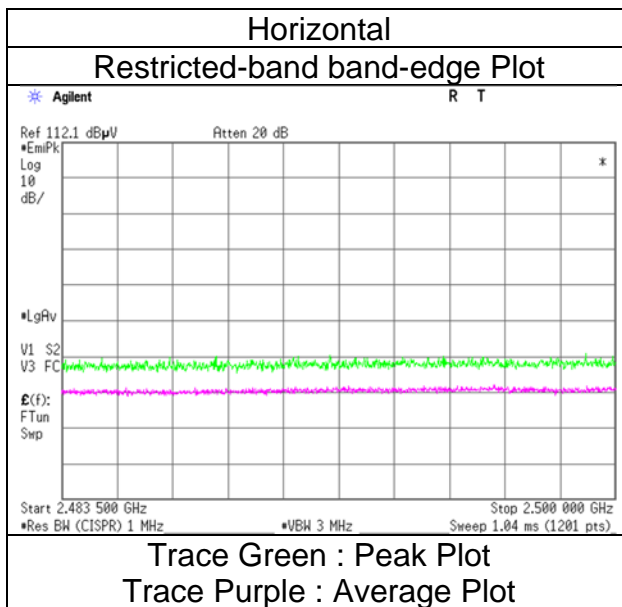

* The measurement was conducted for a sufficiently long enough time to detect any possible spurious emissions.
Final result of restricted band edge was shown in tabular data.

Radiated Spurious Emission

Test place	Ise EMC Lab.	No.3
Semi Anechoic Chamber	No.3	No.3
Date	February 18, 2024	February 19, 2024
Temperature / Humidity	23 deg. C / 50 % RH	20 deg. C / 60 % RH
Engineer	Tomohisa Nakagawa	Tetsuro Yoshida
	(1 GHz to 10 GHz)	(10 GHz to 26.5 GHz)
Mode	Tx BT LE 2402 MHz	

Polarity	Frequency	Reading	Reading	Ant.	Loss	Gain	Duty	Result	Result	Limit	Limit	Margin	Margin	Remark
[Hori/Vert]	[MHz]	(QP / PK)	(AV)	Factor	[dB]	[dB]	Factor	(QP / PK)	(AV)	(QP / PK)	(AV)	(QP / PK)	(AV)	
		[dBuV]	[dBuV]	[dB/m]			[dB]	[dBuV/m]	[dBuV/m]	[dBuV/m]	[dBuV/m]	[dB]	[dB]	
Hori.	2390.0	48.2	35.4	27.5	5.4	32.4	1.7	48.7	37.6	73.9	53.9	25.2	16.3	*1)
Hori.	4804.0	47.3	37.6	31.4	7.6	31.4	1.7	54.8	46.8	73.9	53.9	19.1	7.1	
Hori.	7206.0	36.0	29.6	35.6	10.8	32.3	-	50.1	43.7	73.9	53.9	23.8	10.2	Floor noise
Hori.	9608.0	35.6	29.6	35.7	11.5	32.9	-	49.8	43.8	73.9	53.9	24.1	10.1	Floor noise
Vert.	2390.0	46.9	35.6	27.5	5.4	32.4	1.7	47.4	37.8	73.9	53.9	26.5	16.1	*1)
Vert.	4804.0	46.4	37.7	31.4	7.6	31.4	1.7	53.9	47.0	73.9	53.9	20.0	6.9	
Vert.	7206.0	36.2	29.9	35.6	10.8	32.3	-	50.2	44.0	73.9	53.9	23.7	9.9	Floor noise
Vert.	9608.0	36.0	28.5	35.7	11.5	32.9	-	50.2	42.7	73.9	53.9	23.7	11.2	Floor noise

Result (QP / PK) = Reading + Ant Factor + Loss (Cable+Attenuator+Filter+Distance factor(above 1 GHz)) - Gain(Amplifier)

Result (AV)= Reading + Ant Factor + Loss (Cable+Attenuator+Filter+Distance factor(above 1 GHz)) - Gain(Amplifier) + Duty factor

*Other frequency noises omitted in this report were not seen or had enough margin (more than 20 dB).

*QP detector was used up to 1GHz.

*1) Not Out of Band emission(Leakage Power)

20dBc Data Sheet

Polarity	Frequency	Reading	Ant	Loss	Gain	Result	Limit	Margin	Remark
[Hori/Vert]	[MHz]	(PK)	Factor	[dB]	[dB]	[dBuV/m]	[dBuV/m]	[dB]	
		[dBuV]	[dB/m]						
Hori.	2402.0	101.1	27.5	5.4	32.4	101.6	-	-	Carrier
Hori.	2400.0	45.8	27.5	5.4	32.4	46.3	81.6	35.3	
Vert.	2402.0	101.0	27.5	5.4	32.4	101.5	-	-	Carrier
Vert.	2400.0	45.4	27.5	5.4	32.4	45.9	81.5	35.6	

Result = Reading + Ant Factor + Loss (Cable+Attenuator+Filter+Distance factor(above 1 GHz)) - Gain(Amplifier)

Distance factor: 1 GHz - 6 GHz 20log (3.95 m / 3.0 m) = 2.39 dB

6 GHz - 10 GHz 20log (4.3 m / 3.0 m) = 4.35 dB

10 GHz - 26.5 GHz 20log (1.0 m / 3.0 m) = -9.5 dB

Radiated Spurious Emission (Reference Plot for band-edge)

Test place	Ise EMC Lab.
Semi Anechoic Chamber	No.3
Date	February 18, 2024
Temperature / Humidity	23 deg. C / 50 % RH
Engineer	Tomohisa Nakagawa
	(1 GHz to 6 GHz)
Mode	Tx BT LE 2402 MHz

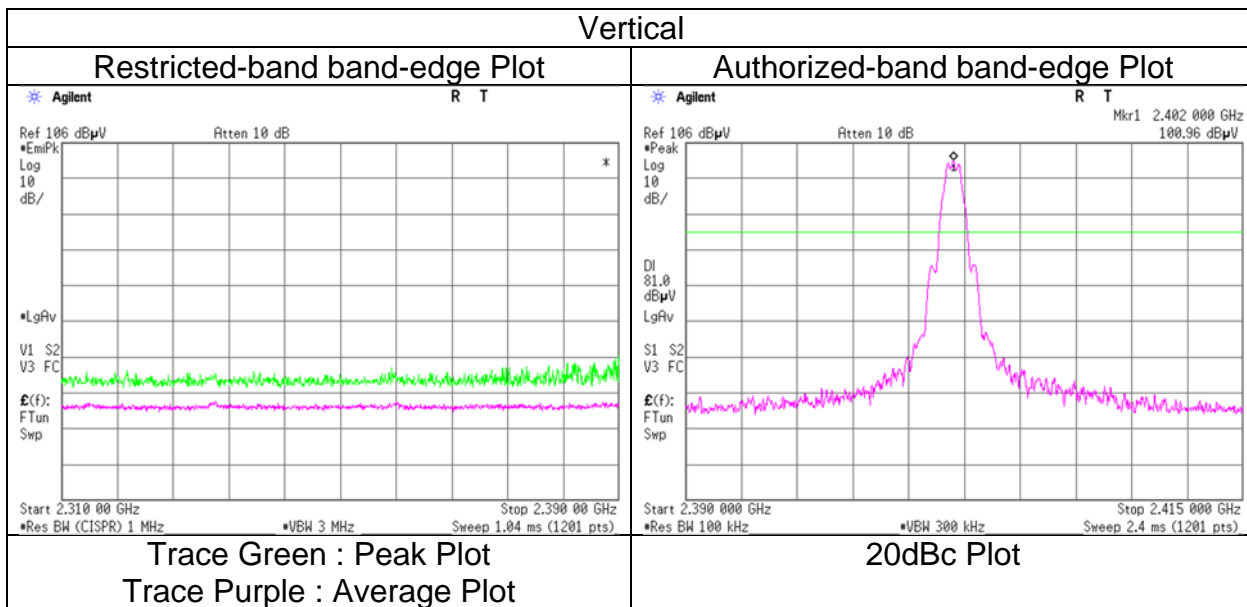
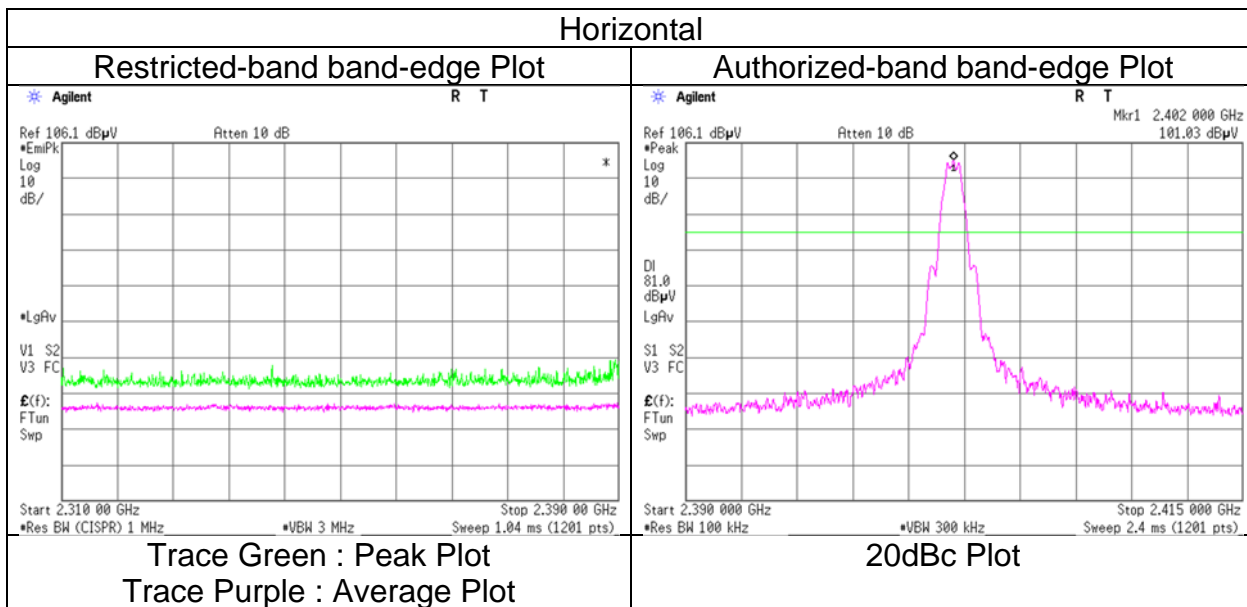

* The measurement was conducted for a sufficiently long enough time to detect any possible spurious emissions.
Final result of restricted band edge and authorized band edge were shown in tabular data.

Radiated Spurious Emission

Test place	Ise EMC Lab.	No.3
Semi Anechoic Chamber	No.3	No.3
Date	February 18, 2024	February 19, 2024
Temperature / Humidity	23 deg. C / 50 % RH	20 deg. C / 60 % RH
Engineer	Tomohisa Nakagawa	Tetsuro Yoshida
Mode	(1 GHz to 10 GHz)	(10 GHz to 26.5 GHz, Below 1 GHz)
	Tx BT LE 2440 MHz	

Polarity	Frequency	Reading (QP / PK)	Reading (AV)	Ant. Factor	Loss	Gain	Duty Factor	Result (QP / PK)	Result (AV)	Limit (QP / PK)	Limit (AV)	Margin (QP / PK)	Margin (AV)	Remark
[Hori/Vert]	[MHz]	[dBuV]	[dBuV]	[dB/m]	[dB]	[dB]	[dB]	[dBuV/m]	[dBuV/m]	[dBuV/m]	[dBuV/m]	[dB]	[dB]	
Hori.	52.4	25.7	-	9.7	7.3	32.2	-	10.5	-	40.0	-	29.5	-	
Hori.	61.4	24.4	-	9.2	7.4	32.2	-	8.8	-	40.0	-	31.2	-	
Hori.	88.5	26.3	-	9.4	7.8	32.1	-	11.4	-	43.5	-	32.1	-	
Hori.	276.8	21.4	-	13.2	9.5	32.0	-	12.1	-	46.0	-	33.9	-	Floor noise
Hori.	408.1	21.3	-	16.0	10.4	32.0	-	15.7	-	46.0	-	30.3	-	Floor noise
Hori.	493.6	21.4	-	17.6	10.9	32.0	-	17.9	-	46.0	-	28.1	-	Floor noise
Hori.	4880.0	47.2	41.0	31.4	7.6	31.4	1.7	54.8	50.3	73.9	53.9	19.1	3.6	
Hori.	7320.0	35.8	29.4	35.6	10.8	32.3	-	49.9	43.5	73.9	53.9	24.0	10.4	Floor noise
Hori.	9760.0	35.5	28.7	36.0	11.6	33.0	-	50.1	43.3	73.9	53.9	23.8	10.6	Floor noise
Vert.	52.4	27.0	-	9.7	7.3	32.2	-	11.8	-	40.0	-	28.2	-	
Vert.	61.4	27.5	-	9.2	7.4	32.2	-	11.9	-	40.0	-	28.1	-	
Vert.	88.5	26.9	-	9.4	7.8	32.1	-	12.0	-	43.5	-	31.5	-	
Vert.	276.8	21.3	-	13.2	9.5	32.0	-	12.0	-	46.0	-	34.0	-	Floor noise
Vert.	408.1	21.3	-	16.0	10.4	32.0	-	15.7	-	46.0	-	30.3	-	Floor noise
Vert.	493.6	21.4	-	17.6	10.9	32.0	-	17.9	-	46.0	-	28.1	-	Floor noise
Vert.	4880.0	46.7	41.6	31.4	7.6	31.4	1.7	54.2	50.9	73.9	53.9	19.7	3.0	
Vert.	7320.0	35.8	30.8	35.6	10.8	32.3	-	50.0	44.9	73.9	53.9	24.0	9.0	Floor noise
Vert.	9760.0	35.8	28.7	36.0	11.6	33.0	-	50.4	43.2	73.9	53.9	23.5	10.7	Floor noise

Result (QP / PK) = Reading + Ant Factor + Loss (Cable+Attenuator+Filter+Distance factor(above 1 GHz)) - Gain(Amplifier)
 Result (AV) = Reading + Ant Factor + Loss (Cable+Attenuator+Filter+Distance factor(above 1 GHz)) - Gain(Amplifier) + Duty factor
 *Other frequency noises omitted in this report were not seen or had enough margin (more than 20 dB).
 *QP detector was used up to 1GHz.

Distance factor: 1 GHz - 6 GHz 20log (3.95 m / 3.0 m) = 2.39 dB
 6 GHz - 10 GHz 20log (4.3 m / 3.0 m) = 4.35 dB
 10 GHz - 26.5 GHz 20log (1.0 m / 3.0 m) = -9.5 dB

Radiated Spurious Emission

Test place	Ise EMC Lab.	No.3
Semi Anechoic Chamber	No.3	No.3
Date	February 18, 2024	February 19, 2024
Temperature / Humidity	23 deg. C / 50 % RH	20 deg. C / 60 % RH
Engineer	Tomohisa Nakagawa	Tetsuro Yoshida
Mode	(1 GHz to 10 GHz)	(10 GHz to 26.5 GHz)
	Tx BT LE 2480 MHz	

Polarity	Frequency	Reading (QP / PK)	Reading (AV)	Ant. Factor	Loss	Gain	Duty Factor	Result (QP / PK)	Result (AV)	Limit (QP / PK)	Limit (AV)	Margin (QP / PK)	Margin (AV)	Remark
[Hori/Vert]	[MHz]	[dBuV]	[dBuV]	[dB/m]	[dB]	[dB]	[dB]	[dBuV/m]	[dBuV/m]	[dBuV/m]	[dBuV/m]	[dB]	[dB]	
Hori.	2483.5	57.1	44.4	27.4	5.5	32.4	1.7	57.5	46.6	73.9	53.9	16.4	7.3	*1)
Hori.	4960.0	47.8	40.2	31.6	7.6	31.4	1.7	55.5	49.6	73.9	53.9	18.4	4.3	
Hori.	7440.0	36.9	29.0	35.5	10.9	32.4	1.7	50.9	44.7	73.9	53.9	23.0	9.2	
Hori.	9920.0	35.6	29.6	36.2	11.6	33.1	1.7	50.4	46.0	73.9	53.9	23.5	7.9	
Vert.	2483.5	55.9	40.8	27.4	5.5	32.4	1.7	56.4	43.0	73.9	53.9	17.5	10.9	*1)
Vert.	4960.0	46.1	40.1	31.6	7.6	31.4	1.7	53.9	49.5	73.9	53.9	20.0	4.4	
Vert.	7440.0	36.6	30.2	35.5	10.9	32.4	1.7	50.6	45.9	73.9	53.9	23.3	8.0	
Vert.	9920.0	36.2	29.3	36.2	11.6	33.1	1.7	51.0	45.8	73.9	53.9	22.9	8.1	

Result (QP / PK) = Reading + Ant Factor + Loss (Cable+Attenuator+Filter+Distance factor(above 1 GHz)) - Gain(Amplifier)
 Result (AV)= Reading + Ant Factor + Loss (Cable+Attenuator+Filter+Distance factor(above 1 GHz)) - Gain(Amplifier) + Duty factor
 *Other frequency noises omitted in this report were not seen or had enough margin (more than 20 dB).
 *QP detector was used up to 1GHz.
 *1) Not Out of Band emission(Leakage Power)

Distance factor: 1 GHz - 6 GHz 20log (3.95 m / 3.0 m) = 2.39 dB
 6 GHz - 10 GHz 20log (4.3 m / 3.0 m) = 4.35 dB
 10 GHz - 26.5 GHz 20log (1.0 m / 3.0 m) = -9.5 dB

**Radiated Spurious Emission
 (Reference Plot for band-edge)**

Test place
 Semi Anechoic Chamber
 Date
 Temperature / Humidity
 Engineer
 Mode

Ise EMC Lab.
 No.3
 February 18, 2024
 23 deg. C / 50 % RH
 Tomohisa Nakagawa
 (1 GHz to 6 GHz)
 Tx BT LE 2480 MHz

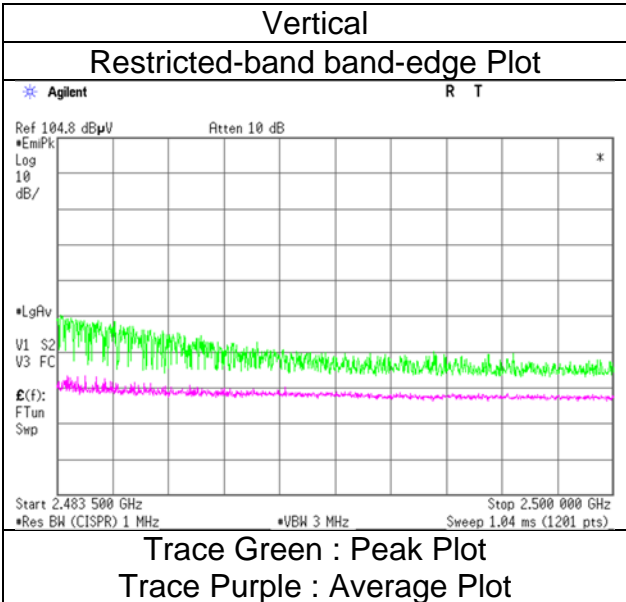
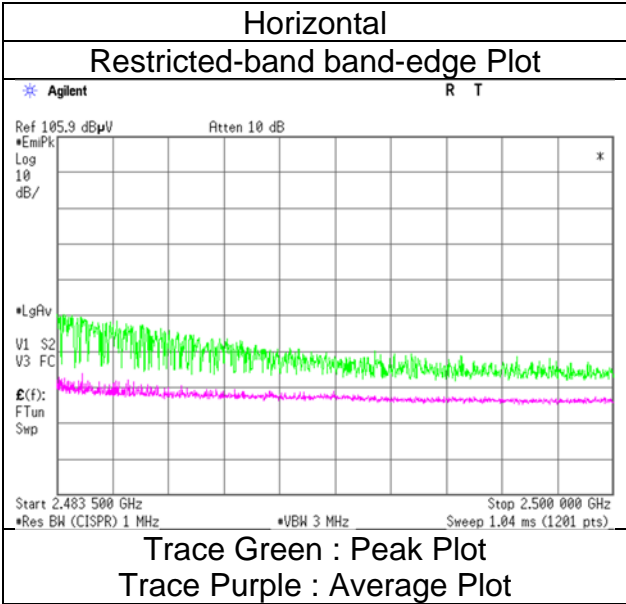

* The measurement was conducted for a sufficiently long enough time to detect any possible spurious emissions.
 Final result of restricted band edge was shown in tabular data.

Radiated Spurious Emission
(Plot data, Worst case mode for Maximum Peak Output Power)

Test place
 Semi Anechoic Chamber
 Date
 Temperature / Humidity
 Engineer
 Mode

Ise EMC Lab.
 No.3
 February 18, 2024
 23 deg. C / 50 % RH
 Tomohisa Nakagawa
 (1 GHz to 10 GHz)
 Tx 11n-20 2437 MHz

No.3
 February 19, 2024
 20 deg. C / 60 % RH
 Tetsuro Yoshida
 (10 GHz to 26.5 GHz, Below 1 GHz)

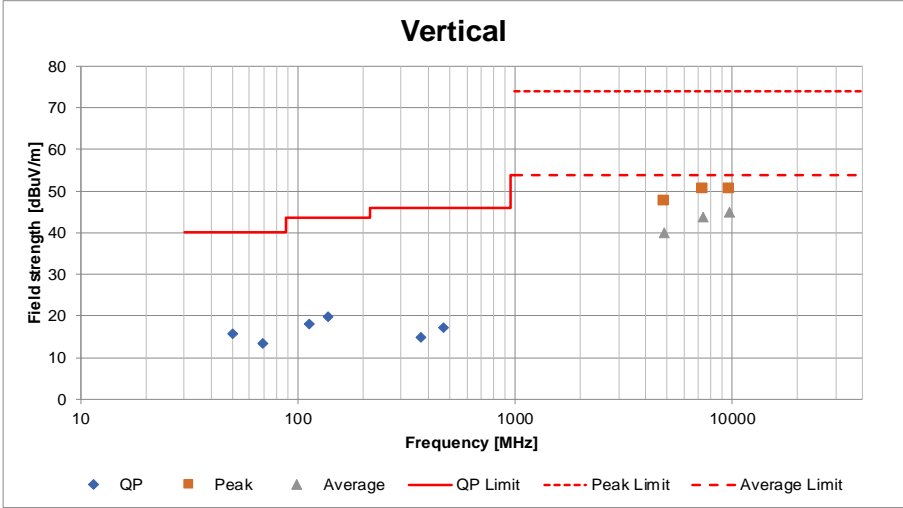
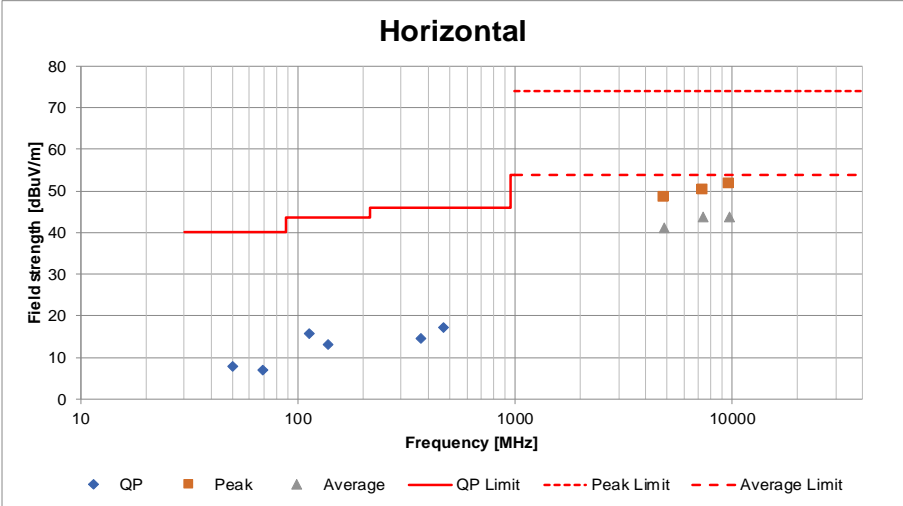

*These plots data contain sufficient number to show the trend of characteristic features for EUT.

Radiated Spurious Emission
(Plot data, Worst case mode for Maximum Peak Output Power)

Test place	Ise EMC Lab.	No.3
Semi Anechoic Chamber	No.3	No.3
Date	February 18, 2024	February 19, 2024
Temperature / Humidity	23 deg. C / 50 % RH	20 deg. C / 60 % RH
Engineer	Tomohisa Nakagawa	Tetsuro Yoshida
Mode	(1 GHz to 10 GHz) Tx BT LE 2440 MHz	(10 GHz to 26.5 GHz, Below 1 GHz)

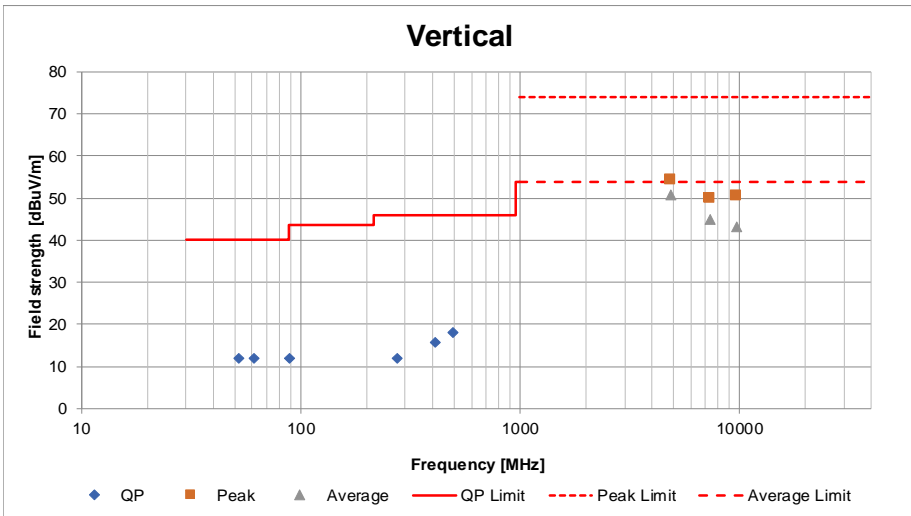
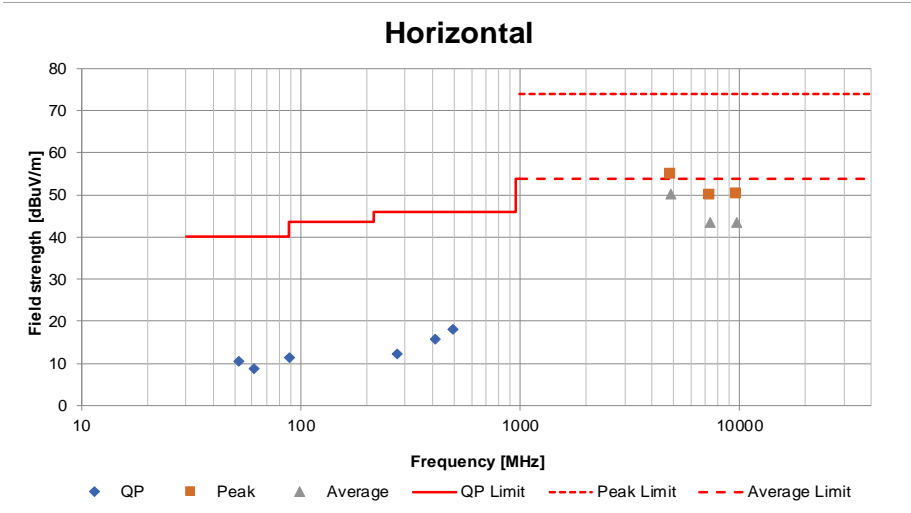

*These plots data contain sufficient number to show the trend of characteristic features for EUT.

APPENDIX 2: Test Instruments

Test Equipment

Test Item	LIMS ID	Description	Manufacturer	Model	Serial	Last Calibration Date	Cal Int
RE	141266	Log periodic Antenna(200-1000MHz)	Schwarzbeck Mess-Elektronik OHG	VUSLP9111B	9111B-191	08/10/2023	12
RE	141296	High Pass Filter 3.5-18.0GHz	UL Japan	HPF SELECTOR	002	09/01/2023	12
RE	141323	Coaxial cable	UL Japan	-	-	09/10/2023	12
RE	141507	Horn Antenna 1-18GHz	Schwarzbeck Mess-Elektronik OHG	BBHA9120D	258	11/20/2023	12
RE	141513	Horn Antenna 15-40GHz	Schwarzbeck Mess-Elektronik OHG	BBHA9170	BBHA9170306	07/19/2023	12
RE	141532	DIGITAL HiTESTER	HIOKI E.E. CORPORATION	3805	051201197	01/31/2024	12
RE	141554	Thermo-Hygrometer	CUSTOM. Inc	CTH-201	1301	-	-
RE	141580	MicroWave System Amplifier	Keysight Technologies Inc	83017A	MY39500779	03/08/2023	12
RE	141582	Pre Amplifier	SONOMA INSTRUMENT	310	260834	02/07/2023	12
RE	141901	Spectrum Analyzer	Keysight Technologies Inc	E4440A	MY48250080	01/26/2024	12
RE	141950	EMI Test Receiver	Rohde & Schwarz	ESU26	100412	11/20/2023	12
RE	142008	AC3_Semi Anechoic Chamber (NSA)	TDK	Semi Anechoic Chamber 3m	DA-10005	12/11/2023	24
RE	142013	AC3_Semi Anechoic Chamber (SVSWR)	TDK	Semi Anechoic Chamber 3m	DA-10005	10/18/2023	12
RE	142183	Measure	KOMELON	KMC-36	-	10/20/2023	12
RE	142314	Attenuator	Pasternack Enterprises	PE7390-6	D/C 1504	06/23/2023	12
RE	178648	EMI measurement program	TSJ (Techno Science Japan)	TEPTO-DV	-	-	-
RE	197990	Biconical Antenna	Schwarzbeck Mess-Elektronik OHG	VHBB 9124 + BBA 9106	01365	11/29/2023	12
RE	234602	Microwave Cable	Huber+Suhner	SF126E/11PC35/11PC35/1000M,5000M	537063/126E / 537074/126E	03/16/2023	12
RE	238713	Double Ridge Horn Antenna	Schwarzbeck Mess-Elektronik OHG	BBHA 9120 C	688	08/10/2023	12
RE	244709	Thermo-Hygrometer	HIOKI E.E. CORPORATION	LR5001	231202103	01/25/2024	12

*Hyphens for Last Calibration Date and Cal Int (month) are instruments that Calibration is not required (e.g. software), or instruments checked in advance before use.

The expiration date of the calibration is the end of the expired month.

As for some calibrations performed after the tested dates, those test equipment have been controlled by means of an unbroken chains of calibrations.

All equipment is calibrated with valid calibrations. Each measurement data is traceable to the national or international standards.

Test item:

RE: Radiated Emission