

FCC Measurement/Technical Report on W-LAN + Bluetooth Module

1PJ

FCC ID: VPYLBEE5ZZ1PJ
IC: 772C-LBEE5ZZ1PJ

Test Report Reference: MDE_JABIL_2006_FCC_07

Test Laboratory:

7layers GmbH
Borsigstrasse 11
40880 Ratingen
Germany



Deutsche
Akkreditierungsstelle
D-PL-12140-01-01
D-PL-12140-01-02
D-PL-12140-01-03

Note:

The following test results relate only to the devices specified in this document. This report shall not be reproduced in parts without the written approval of the test laboratory.

7layers GmbH
Borsigstraße 11
40880 Ratingen, Germany
T +49 (0) 2102 749 0
F +49 (0) 2102 749 350

Geschäftsführer/
Managing Directors:
Frank Spiller
Bernhard Retka
Alexandre Norré-Oudard

Registergericht/registered:
Düsseldorf HRB 75554
USt-Id.-Nr./VAT-No. DE203159652
Steuer-Nr./TAX-No. 147/5869/0385

*a Bureau Veritas
Group Company*

www.7layers.com

Table of Contents

1	Applied Standards and Test Summary	3
1.1	Applied Standards	3
1.2	FCC-IC Correlation Table	4
1.3	Measurement Summary	5
2	Revision History / Signatures	7
3	Administrative Data	8
3.1	Testing Laboratory	8
3.2	Project Data	8
3.3	Applicant Data	8
3.4	Manufacturer Data	9
4	Test object Data	10
4.1	General EUT Description	10
4.2	EUT Main components	11
4.3	Ancillary Equipment	11
4.4	Auxiliary Equipment	12
4.5	EUT Setups	12
4.6	Operating Modes / Test Channels	13
4.7	Product labelling	13
5	Test Results	14
5.1	Peak Power Output	14
5.2	Transmitter Spurious Radiated Emissions	18
5.3	Band Edge Compliance Conducted	32
5.4	Band Edge Compliance Radiated	37
6	Test Equipment	43
7	Antenna Factors, Cable Loss and Sample Calculations	46
7.1	LISN R&S ESH3-Z5 (150 kHz – 30 MHz)	46
7.2	Antenna R&S HFH2-Z2 (9 kHz – 30 MHz)	47
7.3	Antenna R&S HL562 (30 MHz – 1 GHz)	48
7.4	Antenna R&S HF907 (1 GHz – 18 GHz)	49
7.5	Antenna EMCO 3160-09 (18 GHz – 26.5 GHz)	50
7.6	Antenna EMCO 3160-10 (26.5 GHz – 40 GHz)	51
8	Measurement Uncertainties	52
9	Photo Report	53

1 APPLIED STANDARDS AND TEST SUMMARY

1.1 APPLIED STANDARDS

Type of Authorization

Certification for an Intentional Radiator.

Applicable FCC Rules

Prepared in accordance with the requirements of FCC Rules and Regulations as listed in 47 CFR Ch.1 Parts 2 and 15 (10-1-20 Edition). The following subparts are applicable to the results in this test report.

Part 2, Subpart J - Equipment Authorization Procedures, Certification

Part 15, Subpart C – Intentional Radiators

§ 15.201 Equipment authorization requirement

§ 15.207 Conducted limits

§ 15.209 Radiated emission limits; general requirements

§ 15.247 Operation within the bands 902-928 MHz, 2400-2483.5 MHz

Note:

The tests were selected and performed with reference to the FCC Public Notice "Guidance for Compliance Measurements on Digital Transmission System, Frequency Hopping Spread Spectrum System, and Hybrid System Devices Operating under Section 15.247 of the FCC Rules, 558074 D01 15.247 Meas Guidance v05r02, 2019-04-02". ANSI C63.10-2013 is applied.

1.2 FCC-IC CORRELATION TABLE

Correlation of measurement requirements for DTS (e.g. WLAN 2.4 GHz, BT LE) equipment from FCC and IC

DTS equipment

Measurement	FCC reference	IC reference
Conducted emissions on AC Mains	§ 15.207	RSS-Gen Issue 5: 8.8
Occupied bandwidth	§ 15.247 (a) (2)	RSS-247 Issue 2: 5.2 (a)
Peak conducted output power	§ 15.247 (b) (3), (4)	RSS-247 Issue 2: 5.4 (d)
Transmitter spurious RF conducted emissions	§ 15.247 (d)	RSS-Gen Issue 5: 6.13 / 8.9/8.10; RSS-247 Issue 2: 5.5
Transmitter spurious radiated emissions	§ 15.247 (d); § 15.209 (a)	RSS-Gen Issue 5: 6.13 / 8.9/8.10; RSS-247 Issue 2: 5.5
Band edge compliance	§ 15.247 (d)	RSS-247 Issue 2: 5.5
Power density	§ 15.247 (e)	RSS-247 Issue 2: 5.2 (b)
Antenna requirement	§ 15.203 / 15.204	RSS-Gen Issue 5: 8.3
Receiver spurious emissions	-	-

1.3 MEASUREMENT SUMMARY

47 CFR CHAPTER I FCC PART 15 Subpart C §15.247 § 15.247 (b) (3)

Peak Power Output

The measurement was performed according to ANSI C63.10, chapter 11.9.1.3

Final Result

OP-Mode	Setup	Date	FCC	IC
Radio Technology, Operating Frequency, Measurement method				
Bluetooth LE 1 Mbps, high, conducted	S01_AB01	2022-01-12	Passed	Passed
Bluetooth LE 1 Mbps, low, conducted	S01_AB01	2022-01-12	Passed	Passed
Bluetooth LE 1 Mbps, mid, conducted	S01_AB01	2022-01-12	Passed	Passed
WLAN b, high, conducted	S01_AC01	2022-01-12	Passed	Passed
WLAN b, low, conducted	S01_AC01	2022-01-12	Passed	Passed
WLAN g, high, conducted	S01_AC01	2022-01-12	Passed	Passed
WLAN g, low, conducted	S01_AC01	2022-01-12	Passed	Passed

47 CFR CHAPTER I FCC PART 15 Subpart C §15.247 § 15.247 (d)

Transmitter Spurious Radiated Emissions

The measurement was performed according to ANSI C63.10, chapter 6.4, 6.5, 6.6.5

Final Result

OP-Mode	Setup	Date	FCC	IC
Radio Technology, Operating Frequency, Measurement range				
Bluetooth LE 1 Mbps, high, 1 GHz - 26 GHz	S01_AE01	2022-01-30	Passed	Passed
WLAN b, high, 1 GHz - 26 GHz	S01_AD01	2022-01-17	Passed	Passed
WLAN b, high, 30 MHz - 1 GHz	S01_AD01	2022-02-06	Passed	Passed
WLAN b, high, 9 kHz - 30 MHz	S01_AD01	2022-02-08	Passed	Passed
WLAN b, low, 1 GHz - 26 GHz	S01_AD01	2022-01-14	Passed	Passed
WLAN b, low, 30 MHz - 1 GHz	S01_AD01	2022-02-06	Passed	Passed
WLAN g, high, 1 GHz - 26 GHz Remark: 1-8GHz	S01_AD01	2022-01-24	Passed	Passed
WLAN g, high, 30 MHz - 1 GHz	S01_AD01	2022-02-08	Passed	Passed
WLAN g, high, 9 kHz - 30 MHz	S01_AD01	2022-02-06	Passed	Passed
WLAN g, low, 1 GHz - 26 GHz Remark: 1-8GHz	S01_AD01	2022-01-24	Passed	Passed
WLAN g, low, 30 MHz - 1 GHz	S01_AD01	2022-02-06	Passed	Passed

47 CFR CHAPTER I FCC PART 15 Subpart C §15.247 § 15.247 (d)

Band Edge Compliance Conducted

The measurement was performed according to ANSI C63.10, chapter 11.11

Final Result

OP-Mode Radio Technology, Operating Frequency, Band Edge	Setup	Date	FCC	IC
WLAN b, high, high	S01_AC01	2022-01-12	Passed	Passed
WLAN b, low, low	S01_AC01	2022-01-12	Passed	Passed
WLAN g, high, high	S01_AC01	2022-01-12	Passed	Passed
WLAN g, low, low	S01_AC01	2022-01-12	Passed	Passed

47 CFR CHAPTER I FCC PART 15 Subpart C §15.247 § 15.247 (d)

Band Edge Compliance Radiated

The measurement was performed according to ANSI C63.10, chapter 6.6.5

Final Result

OP-Mode Radio Technology, Operating Frequency, Band Edge	Setup	Date	FCC	IC
Bluetooth LE 1 Mbps, high, high	S01_AE01	2022-01-30	Passed	Passed
WLAN b, high, high	S01_AD01	2022-01-17	Passed	Passed
WLAN g, high, high	S01_AD01	2022-01-24	Passed	Passed

N/A: Not applicable

N/P: Not performed

2 REVISION HISTORY / SIGNATURES

Report version control			
Version	Release date	Change Description	Version validity
initial	2022-08-03	--	valid

COMMENT:

According to the applicant not all required tests were performed.
This is a spot check report.

The module was measured within the final end product, which was used as an evaluation board for executing the tests.

This report is a replacement of the report with reference:
MDE_JABIL_2006_FCC_02_rev01

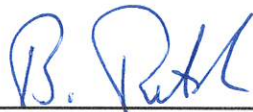

(responsible for accreditation scope)
Dipl.-Ing. Bernhard Retka

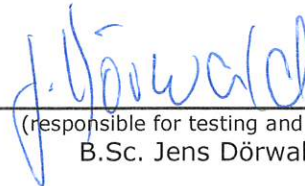

(responsible for testing and report)
B.Sc. Jens Dörwald



7 layers GmbH, Borsigstr. 11
40880 Ratingen, Germany
Phone +49 (0)2102 749 0

3 ADMINISTRATIVE DATA

3.1 TESTING LABORATORY

Company Name: 7layers GmbH
Address: Borsigstr. 11
40880 Ratingen
Germany

The test facility is accredited by the following accreditation organisation:

Laboratory accreditation no: DAKKS D-PL-12140-01-01 | -02 | -03
FCC Designation Number: DE0015
FCC Test Firm Registration: 929146
ISED CAB Identifier: DE0007; ISED#: 3699A

Responsible for accreditation scope: Dipl.-Ing. Bernhard Retka

Report Template Version: 2021-09-09

3.2 PROJECT DATA

Responsible for testing and report: B.Sc. Jens Dörwald
Employees who performed the tests: documented internally at 7Layers
Date of Report: 2022-08-03
Testing Period: 2022-01-12 to 2022-02-08

3.3 APPLICANT DATA

Company Name: Murata Manufacturing Co., Ltd.
Address: 10-1, Higashikotari 1-chome,
Nagaokakyo-shi, Kyoto 617-8555,
Japan
Contact Person:

3.4 MANUFACTURER DATA

Company Name: Please see Applicant Data

Address:

Contact Person:

4 TEST OBJECT DATA

4.1 GENERAL EUT DESCRIPTION

Kind of Device product description	W-LAN + Bluetooth Module
Product name	W-LAN + Bluetooth Module
Type	1PJ
Declared EUT data by the supplier	
Voltage Type	DC
Voltage Level	3.3 V
Antenna / Gain	Integral / 2.8 dBi
Tested Modulation Type	BT LE: GFSK WLAN: WLANb: DSSS, WLANg,n: OFDM
General product description	The EUT is a W-LAN + Bluetooth module
Specific product description for the EUT	In the 2.4 GHz ISM band, the EUT supports Bluetooth Classic, Bluetooth Low Energy and WLAN modes b/g/n in 20 MHz Bandwidth. Relevant for this test report is the Bluetooth Low Energy and WLAN transceiver.
EUT ports (connected cables during testing):	Enclosure DC
Tested datarates	BT LE: 1 Mbps WLAN: WLAN b: 1 Mbps, WLAN g: 6 Mbps
Special software and power settings used for testing	Software "QRCT" provided by applicant used for setting test modes.

4.2 EUT MAIN COMPONENTS

Sample Name	Sample Code	Description
EUT ab01	DE1102015ab01	Conducted sample
Sample Parameter	Value	
Serial No.	J213430017	
HW Version	UART	
SW Version	234500024538167	
Comment	BT LE test mode sample with temporary antenna connector	

Sample Name	Sample Code	Description
EUT ae01	DE1102015ae01	Radiated sample
Sample Parameter	Value	
Serial No.	J213430005	
HW Version	-	
SW Version	234500024538185	
Comment	BT LE test mode sample	

Sample Name	Sample Code	Description
EUT ac01	DE1102015ac01	Conducted sample
Sample Parameter	Value	
Serial No.	J213430006	
HW Version	UART	
SW Version	234500024538162	
Comment	WLAN test mode sample with temporary antenna connector	

Sample Name	Sample Code	Description
EUT ad01	DE1102015ad01	Radiated sample
Sample Parameter	Value	
Serial No.	J213430009	
HW Version	UART	
SW Version	234500024538168	
Comment	WLAN test mode sample	

NOTE: The short description is used to simplify the identification of the EUT in this test report.

4.3 ANCILLARY EQUIPMENT

For the purposes of this test report, ancillary equipment is defined as equipment which is used in conjunction with the EUT to provide operational and control features to the EUT. It is necessary to configure the system in a typical fashion, as a customer would normally use it. But nevertheless Ancillary Equipment can influence the test results.

Device	Details (Manufacturer, Type Model, OUT Code)	Description
-	-	-

4.4 AUXILIARY EQUIPMENT

For the purposes of this test report, auxiliary equipment is defined as equipment which is used temporarily to enable operational and control features especially used for the tests of the EUT which is not used during normal operation or equipment that is used during the tests in combination with the EUT but is not subject of this test report. It is necessary to configure the system in a typical fashion, as a customer would normally use it. But nevertheless Auxiliary Equipment can influence the test results.

Device	Details (Manufacturer, Type Model, HW, SW, S/N)	Description
-	-	-

4.5 EUT SETUPS

This chapter describes the combination of EUTs and equipment used for testing. The rationale for selecting the EUTs, ancillary and auxiliary equipment and interconnecting cables, is to test a representative configuration meeting the requirements of the referenced standards.

Setup	Combination of EUTs	Description and Rationale
S01_AB01	EUT ab01,	Conducted Setup for BT LE
S01_AE01	EUT ae01,	Radiated Setup for BT LE
S01_AC01	EUT ac01,	Conducted Setup for WLAN
S01_AD01	EUT ad01,	Radiated Setup for WLAN

4.6 OPERATING MODES / TEST CHANNELS

This chapter describes the operating modes of the EUTs used for testing.

WLAN
20 MHz Test Channels:
Channel:
Frequency [MHz]

2.4 GHz ISM		
2400 - 2483.5 MHz		
low	mid	high
1	6	11
2412	2437	2462

BT LE Test Channels:
Channel:
Frequency [MHz]

2.4 GHz ISM		
2400 - 2483.5 MHz		
low	mid	high
0	19	39
2402	2440	2480

4.7 PRODUCT LABELLING

4.7.1 FCC ID LABEL

Please refer to the documentation of the applicant.

4.7.2 LOCATION OF THE LABEL ON THE EUT

Please refer to the documentation of the applicant.

5 TEST RESULTS

5.1 PEAK POWER OUTPUT

Standard **FCC Part 15 Subpart C**

The test was performed according to:

ANSI C63.10, chapter 11.9.1.3

5.1.1 TEST DESCRIPTION

DTS EQUIPMENT:

The Equipment Under Test (EUT) was set up to perform the output power measurements. The results recorded were measured with the modulation which produces the worst-case (highest) output power.

Maximum peak conducted output power (e.g. Bluetooth Low Energy):

The EUT was connected to the test system as described in the block diagram below. The complete attenuation of the measurement path is known and considered. The reference level of the spectrum analyser was set higher than the output power of the EUT.

Analyser settings:

- Resolution Bandwidth (RBW): \geq DTS bandwidth
- Video Bandwidth (VBW): \geq 3 times RBW or maximum of analyzer
- Span: \geq 3 times RBW
- Trace: Maxhold
- Sweeps: Till stable (min. 300, max. 15000)
- Sweeptime: Auto
- Detector: Peak

Maximum conducted average output power (e.g. WLAN):

The EUT was connected to the test system as described in the block diagram below. The complete attenuation of the measurement path is known and considered. Measurement is performed using the gated RF average power meter integrated in the OSP 120 module OSP-B157W8 with signal bandwidth >300 MHz.

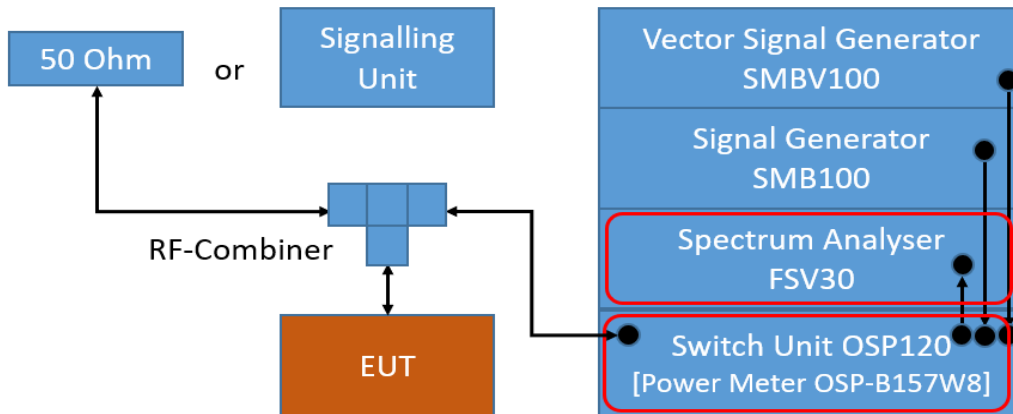

TS8997; Output Power

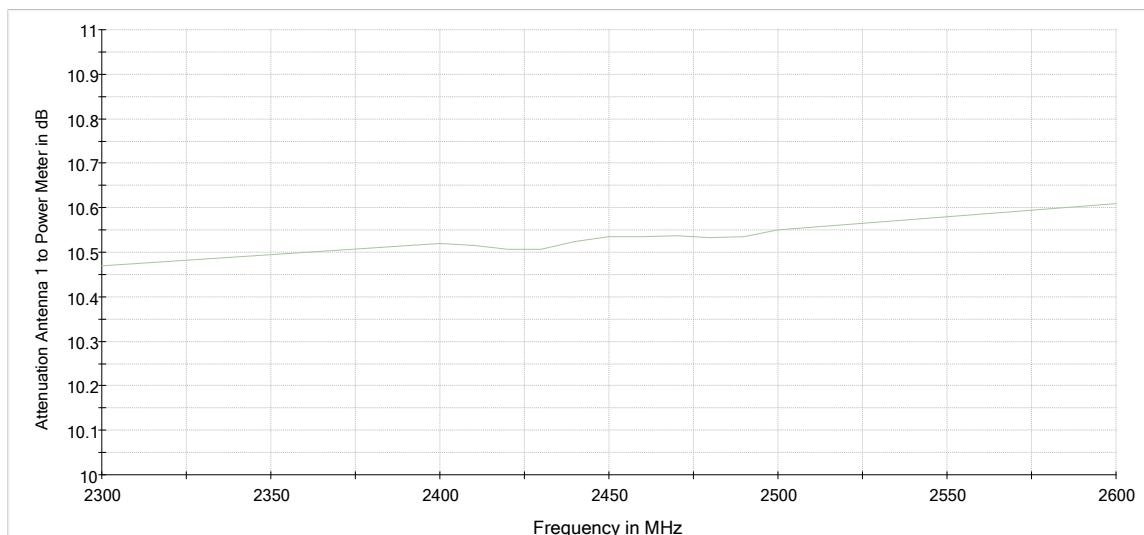

Attenuation of the measurement path to Power Meter

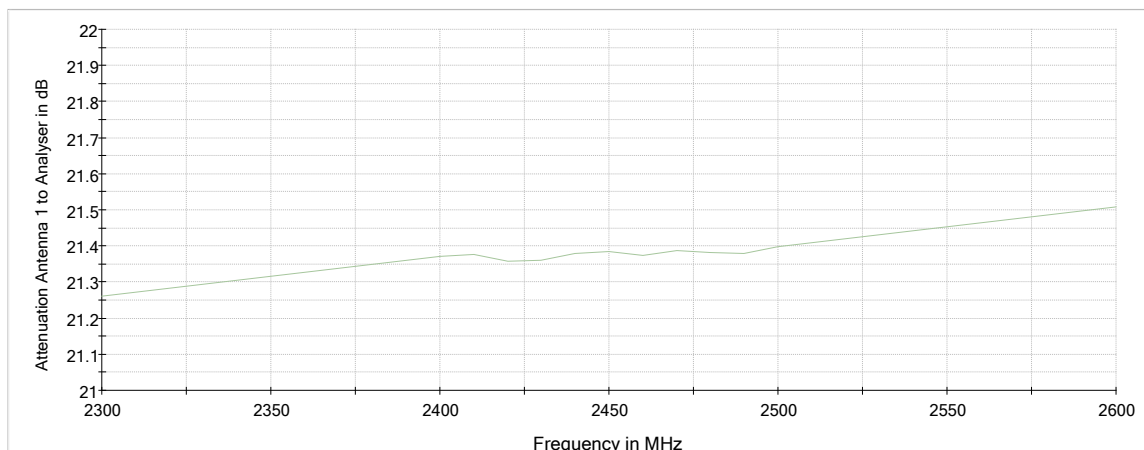

Attenuation of the measurement path to Analyser

5.1.2 TEST REQUIREMENTS / LIMITS

DTS devices:

FCC Part 15, Subpart C, §15.247 (b) (3)

For systems using digital modulation techniques in the 902-928 MHz, 2400-2483.5 MHz and 5725-5850 MHz bands: 1 watt.

==> Maximum conducted peak output power: 30 dBm (excluding antenna gain, if antennas with directional gains that do not exceed 6 dBi are used).

Frequency Hopping Systems:

FCC Part 15, Subpart C, §15.247 (b) (1)

For frequency hopping systems operating in the 2400-2483.5 MHz band employing at least 75 non-overlapping hopping channels, and all frequency hopping systems in the 5725-5850 MHz band: 1 watt. For all other frequency hopping systems in the 2400-2483.5 MHz band: 0.125 watts.

FCC Part 15, Subpart C, §15.247 (b) (2)

For frequency hopping systems operating in the 902-928 MHz band: 1 watt for systems employing at least 50 hopping channels; and, 0.25 watts for systems employing less than 50 hopping channels, but at least 25 hopping channels, as permitted under paragraph (a)(1)(i) of this section.

Used conversion factor: Limit (dBm) = 10 log (Limit (W)/1mW)

5.1.3 TEST PROTOCOL

Ambient temperature: 26 °C
 Air Pressure: 1019 hPa
 Humidity: 40 %

BT LE 1 Mbit/s

Setup	Channel No.	Frequency [MHz]	Peak Power [dBm]	Limit [dBm]	Margin to Limit [dB]	E.I.R.P [dBm]
S01_AB01	0	2402	-3.6	30.0	33.6	-0.8
S01_AB01	19	2440	-2.9	30.0	32.9	-0.1
S01_AB01	39	2480	-3.7	30.0	33.7	-0.9

WLAN b-Mode; 20 MHz; 1 Mbit/s

Setup	Channel No.	Frequency [MHz]	Maximum Average Power [dBm]	Limit [dBm]	Margin to Limit [dB]	E.I.R.P [dBm]
S01_AC01	1	2412	17.5	30.0	12.5	20.3
S01_AC01	11	2462	17.8	30.0	12.2	20.6

WLAN g-Mode; 20 MHz; 6 Mbit/s

Setup	Channel No.	Frequency [MHz]	Maximum Average Power [dBm]	Limit [dBm]	Margin to Limit [dB]	E.I.R.P [dBm]
S01_AC01	1	2412	16.0	30.0	14.0	18.8
S01_AC01	11	2462	16.4	30.0	13.6	19.2

Remark: Please see next sub-clause for the measurement plot.

No plots are provided for WLAN since measurement is performed with power meter.

5.1.4 MEASUREMENT PLOT (EXAMPLE PLOT, SHOWING WORST CASE, IF APPLICABLE)

Radio Technology = Bluetooth LE 1 Mbps, Operating Frequency = mid, Measurement method = conducted (S01_AB01)

Result

DUT Frequency (MHz)	Peak Power (dBm)	Limit Max (dBm)	Result
2440.000000	-2.9	30.0	PASS

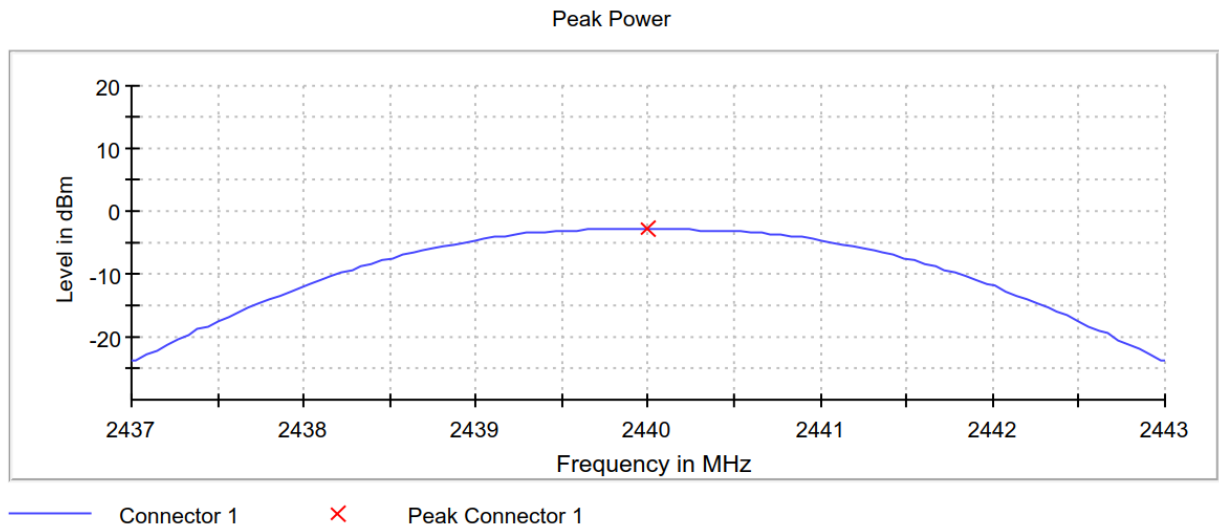

5.1.5 TEST EQUIPMENT USED

- R&S TS8997

5.2 TRANSMITTER SPURIOUS RADIATED EMISSIONS

Standard **FCC Part 15 Subpart C**

The test was performed according to:

ANSI C63.10, chapter 6.4, 6.5, 6.6.5

5.2.1 TEST DESCRIPTION

The test set-up was made in accordance to the general provisions of ANSI C63.10 in a typical installation configuration. The measurements were performed according the following sub-chapters of ANSI C63.10:

- < 30 MHz: Chapter 6.4
- 30 MHz – 1 GHz: Chapter 6.5
- > 1 GHz: Chapter 6.6 (procedure according 6.6.5 used)

The measurement procedure is implemented into the EMI test software EMC32 from R&S. Exploratory tests are performed at 3 orthogonal axes to determine the worst-case orientation of a body-worn or handheld EUT. The final test on all kind of EUTs is also performed at 3 axes. A pre-check is performed while the EUT is powered.

Below 1 GHz:

The Equipment Under Test (EUT) was set up on a non-conductive table in the semi-anechoic chamber. The influence of the EUT support table that is used between 30–1000 MHz was evaluated.

1. Measurement up to 30 MHz

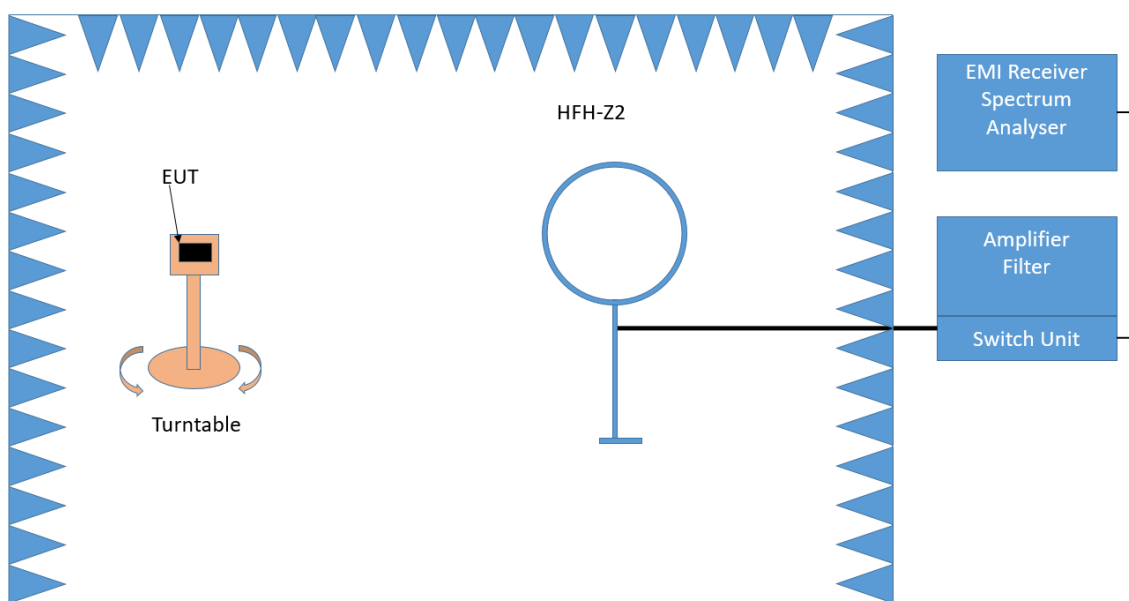

Test Setup; Spurious Emission Radiated (SAC), 9 kHz – 30 MHz

The Loop antenna HFH2-Z2 is used.

Step 1: pre measurement

- Anechoic chamber
- Antenna distance: 3 m
- Antenna height: 1 m
- Detector: Peak-Maxhold
- Frequency range: 0.009 - 0.15 MHz and 0.15 - 30 MHz
- Frequency steps: 0.05 kHz and 2.25 kHz
- IF-Bandwidth: 0.2 kHz and 9 kHz
- Measuring time / Frequency step: 100 ms (FFT-based)

Intention of this step is, to determine the radiated EMI-profile of the EUT. Afterwards the relevant emissions for the final measurement are identified.

Step 2: final measurement

For the relevant emissions determined in step 1, an additional measurement with the following settings will be performed. Intention of this step is to find the maximum emission level.

- Detector: Quasi-Peak (9 kHz - 150 kHz, Peak / Average 150 kHz- 30 MHz)
- Frequency range: 0.009 - 30 MHz
- Frequency steps: measurement at frequencies detected in step 1
- IF-Bandwidth: 0.2 - 10 kHz
- Measuring time / Frequency step: 1 s

2. Measurement above 30 MHz and up to 1 GHz

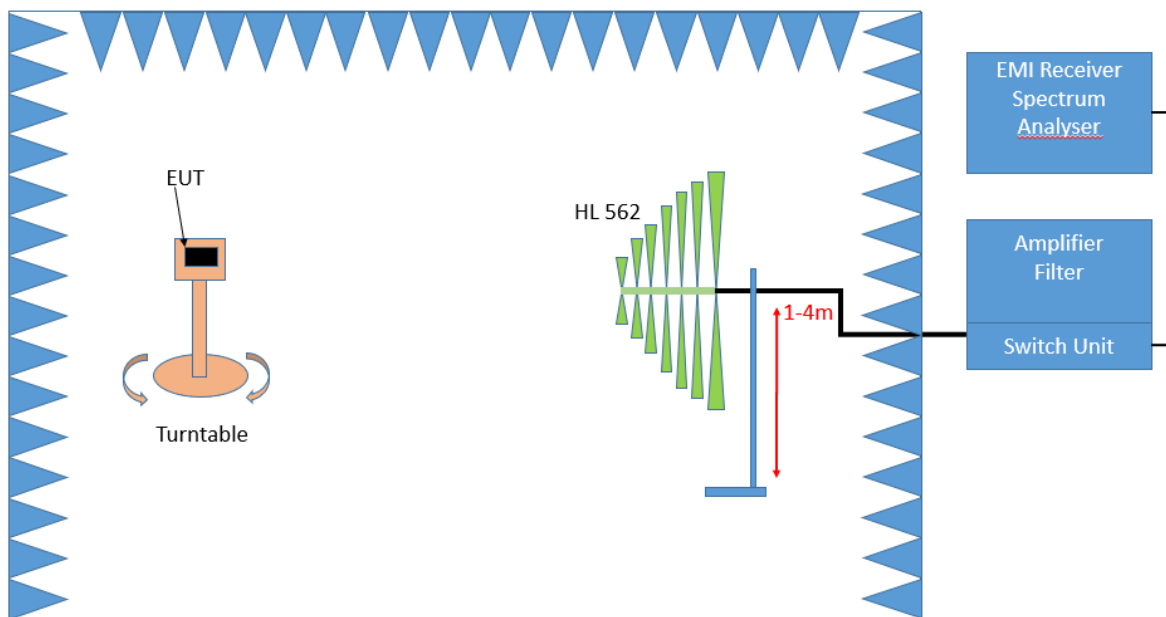

Test Setup; Spurious Emission Radiated (SAC), 30 MHz- 1GHz

Step 1: Preliminary scan

This is a preliminary test to identify the highest amplitudes relative to the limit.

Settings for step 1:

- Antenna distance: 3 m
- Detector: Peak-Maxhold / Quasipeak (FFT-based)
- Frequency range: 30 – 1000 MHz
- Frequency steps: 30 kHz
- IF-Bandwidth: 120 kHz
- Measuring time / Frequency step: 100 ms
- Turntable angle range: -180° to 90°
- Turntable step size: 90°
- Height variation range: 1 – 4 m
- Height variation step size: 1.5 m
- Polarisation: Horizontal + Vertical

Intention of this step is, to determine the radiated EMI-profile of the EUT. Afterwards the relevant emissions for the final measurement are identified.

Step 2: Adjustment measurement

In this step the accuracy of the turntable azimuth and antenna height will be improved. This is necessary to find out the maximum value of every frequency.

For each frequency, which was determined the turntable azimuth and antenna height will be adjusted. The turntable azimuth will slowly vary by $\pm 45^{\circ}$ around this value. During this action, the value of emission is continuously measured. The turntable azimuth at the highest emission will be recorded and adjusted. In this position, the antenna height will also slowly vary by ± 100 cm around the antenna height determined. During this action, the value of emission is also continuously measured. The antenna height of the highest emission will also be recorded and adjusted.

- Detector: Peak – Maxhold
- Measured frequencies: in step 1 determined frequencies
- IF – Bandwidth: 120 kHz
- Measuring time: 100 ms
- Turntable angle range: 360°
- Height variation range: 1 – 4 m
- Antenna Polarisation: max. value determined in step 1

Step 3: Final measurement with QP detector

With the settings determined in step 2, the final measurement will be performed:

EMI receiver settings for step 3:

- Detector: Quasi-Peak (< 1 GHz)
- Measured frequencies: in step 1 determined frequencies
- IF – Bandwidth: 120 kHz
- Measuring time: 1 s

After the measurement a plot will be generated which contains a diagram with the results of the preliminary scan and a chart with the frequencies and values of the results of the final measurement.

Above 1 GHz:

The Equipment Under Test (EUT) was set up on a non-conductive support (tilt device) at 1.5 m height in the fully-anechoic chamber.

All steps were performed with one height (1.5 m) of the receiving antenna only.

3. Measurement above 1 GHz

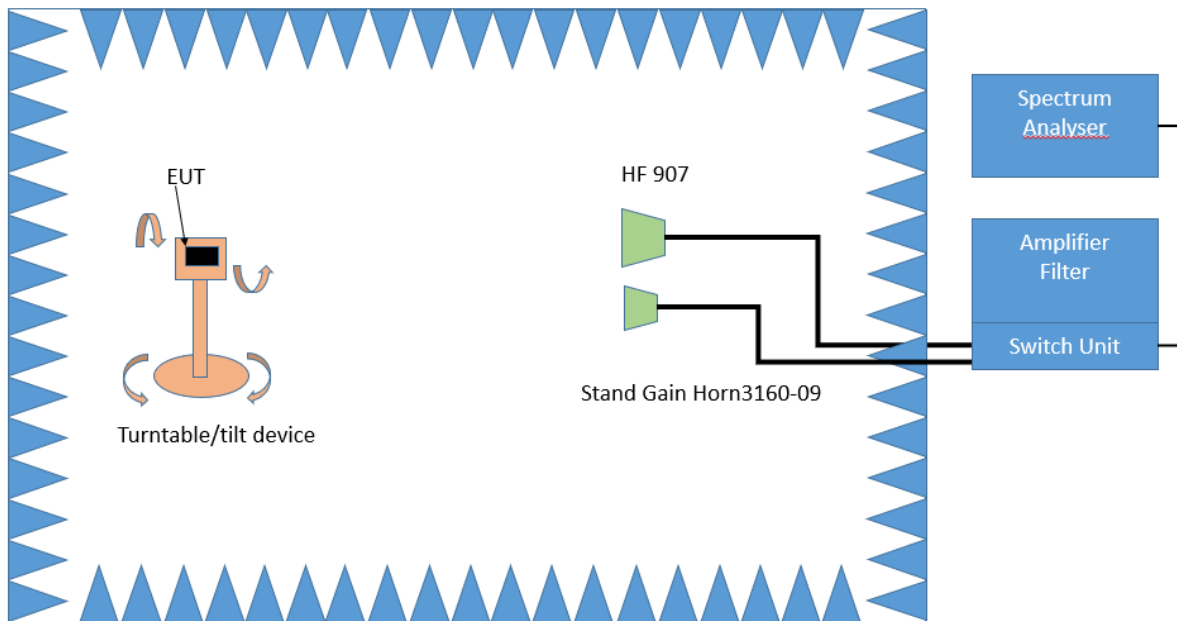

Test Setup; Spurious Emission Radiated (FAC), 1 GHz-26.5 GHz

Step 1:

The EUT is turned during the preliminary measurement across the elevation axis, with a step size of 90 °.

The turn table step size (azimuth angle) for the preliminary measurement is 45 °.

Spectrum analyser settings:

- Detector: Peak, Average
- RBW = 1 MHz
- VBW = 3 MHz

Step 2:

The turn table azimuth will slowly vary by $\pm 22.5^\circ$.

The elevation angle will slowly vary by $\pm 45^\circ$

Spectrum analyser settings:

- Detector: Peak

Step 3:

Spectrum analyser settings for step 3:

- Detector: Peak / CISPR Average
- Measured frequencies: in step 1 determined frequencies
- RBW = 1 MHz
- VBW = 3 MHz
- Measuring time: 1 s

5.2.2 TEST REQUIREMENTS / LIMITS

FCC Part 15, Subpart C, §15.247 (d)

... In addition, radiated emissions which fall in the restricted bands, as defined in Section 15.205(a), must also comply with the radiated emission limits specified in Section 15.209(a) (see Section 15.205(c)).

FCC Part 15, Subpart C, §15.209, Radiated Emission Limits

Frequency in MHz	Limit ($\mu\text{V}/\text{m}$)	Measurement distance (m)	Limits ($\text{dB}\mu\text{V}/\text{m}$)
0.009 – 0.49	2400/F(kHz)@300m	3	(48.5 – 13.8)@300m
0.49 – 1.705	24000/F(kHz)@30m	3	(33.8 – 23.0)@30m
1.705 – 30	30@30m	3	29.5@30m

The measured values are corrected with an inverse linear distance extrapolation factor (40 dB/decade) according FCC 15.31 (2).

Frequency in MHz	Limit ($\mu\text{V}/\text{m}$)	Measurement distance (m)	Limits ($\text{dB}\mu\text{V}/\text{m}$)
30 – 88	100@3m	3	40.0@3m
88 – 216	150@3m	3	43.5@3m
216 – 960	200@3m	3	46.0@3m
960 - 26000	500@3m	3	54.0@3m
26000 - 40000	500@3m	1	54.0@3m

The measured values above 26 GHz are corrected with an inverse linear distance extrapolation factor (20 dB/decade).

§15.35(b) ..., there is also a limit on the radio frequency emissions, as measured using instrumentation with a peak detector function, corresponding to 20 dB above the maximum permitted average limit....

Used conversion factor: $\text{Limit (dB}\mu\text{V}/\text{m)} = 20 \log (\text{Limit } (\mu\text{V}/\text{m})/1\mu\text{V}/\text{m})$

5.2.3 TEST PROTOCOL

Ambient temperature: 26 °C
 Air Pressure: 1006 hPa
 Humidity: 42 %

BT LE 1 Mbit/s
 Applied duty cycle correction (AV): 0 dB

Setup	Ch. Center Freq. [MHz]	Spurious Freq. [MHz]	Spurious Level [dBµV/m]	Detector	RBW [kHz]	Limit [dBµV/m]	Margin to Limit [dB]	Limit Type
S01_AE01	2480	-	-	-	-	-	>10	RB

WLAN b-Mode; 20 MHz; 1 Mbit/s
 Applied duty cycle correction (AV): 0 dB

Setup	Ch. Center Freq. [MHz]	Spurious Freq. [MHz]	Spurious Level [dBµV/m]	Detector	RBW [kHz]	Limit [dBµV/m]	Margin to Limit [dB]	Limit Type
S01_AD01	2412	-	-	-	-	-	>10	RB
S01_AD01	2437	-	-	-	-	-	>10	RB
S01_AD01	2462	-	-	-	-	-	>10	RB

WLAN g-Mode; 20 MHz; 6 Mbit/s
 Applied duty cycle correction (AV): 0 dB

Ch. No.	Ch. Center Freq. [MHz]	Spurious Freq. [MHz]	Spurious Level [dBµV/m]	Detector	RBW [kHz]	Limit [dBµV/m]	Margin to Limit [dB]	Limit Type
S01_AD01	2412	-	-	-	-	-	>10	RB
S01_AD01	2437	-	-	-	-	-	>10	RB
S01_AD01	2462	-	-	-	-	-	>10	RB

Remark: Please see next sub-clause for the measurement plot.

5.2.4 MEASUREMENT PLOT (EXAMPLE PLOT, SHOWING WORST CASE, IF APPLICABLE)

Radio Technology = WLAN b, Operating Frequency = high, Measurement range = 9 kHz - 30 MHz (S01_AD01)

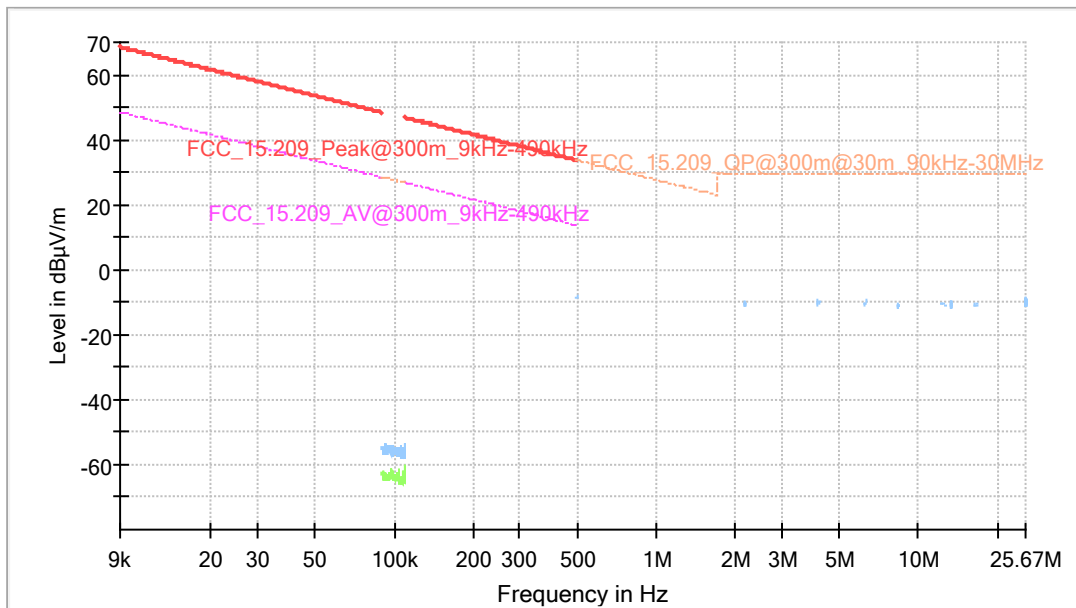

Final Result

Frequency (MHz)	MaxPeak (dBµV/m)	Limit (dBµV/m)	Margin (dB)	Meas. Time (ms)	Bandwidth (kHz)	Height (cm)	Azimuth (deg)	Corr. (dB/m)
---	---	---	---	---	---	---	---	---

Radio Technology = WLAN g, Operating Frequency = high, Measurement range =
 9 kHz - 30 MHz
 (S01_AD01)

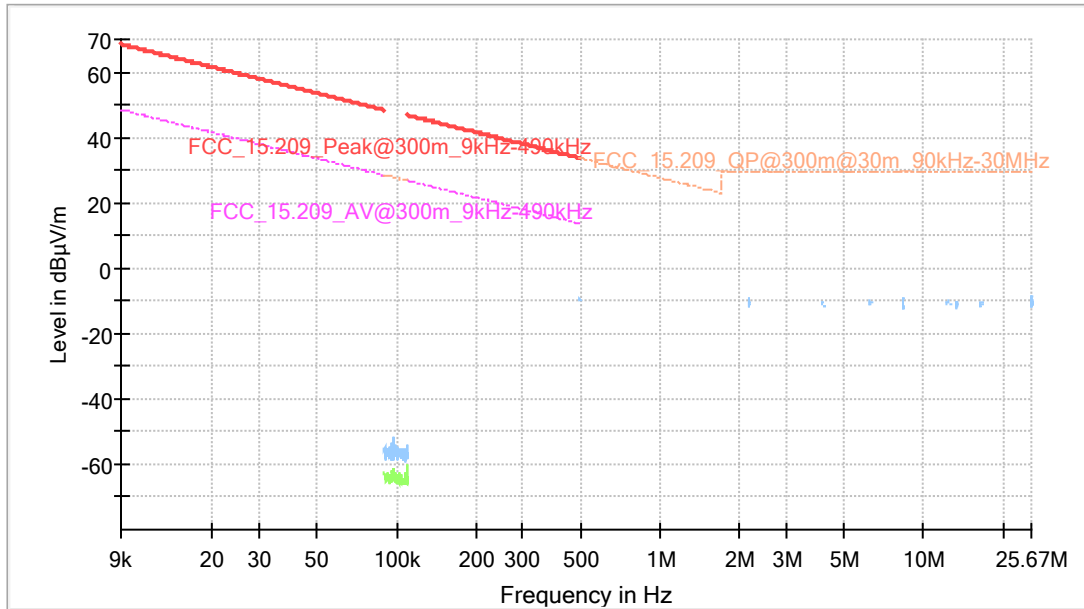

Final Result

Frequency (MHz)	MaxPeak (dBµV/m)	Limit (dBµV/m)	Margin (dB)	Meas. Time (ms)	Bandwidth (kHz)	Height (cm)	Azimuth (deg)	Corr. (dB/m)
---	---	---	---	---	---	---	---	---

Radio Technology = Bluetooth LE 1 Mbps, Operating Frequency = high, Measurement range =
1 GHz - 26 GHz
(S01_AE01)

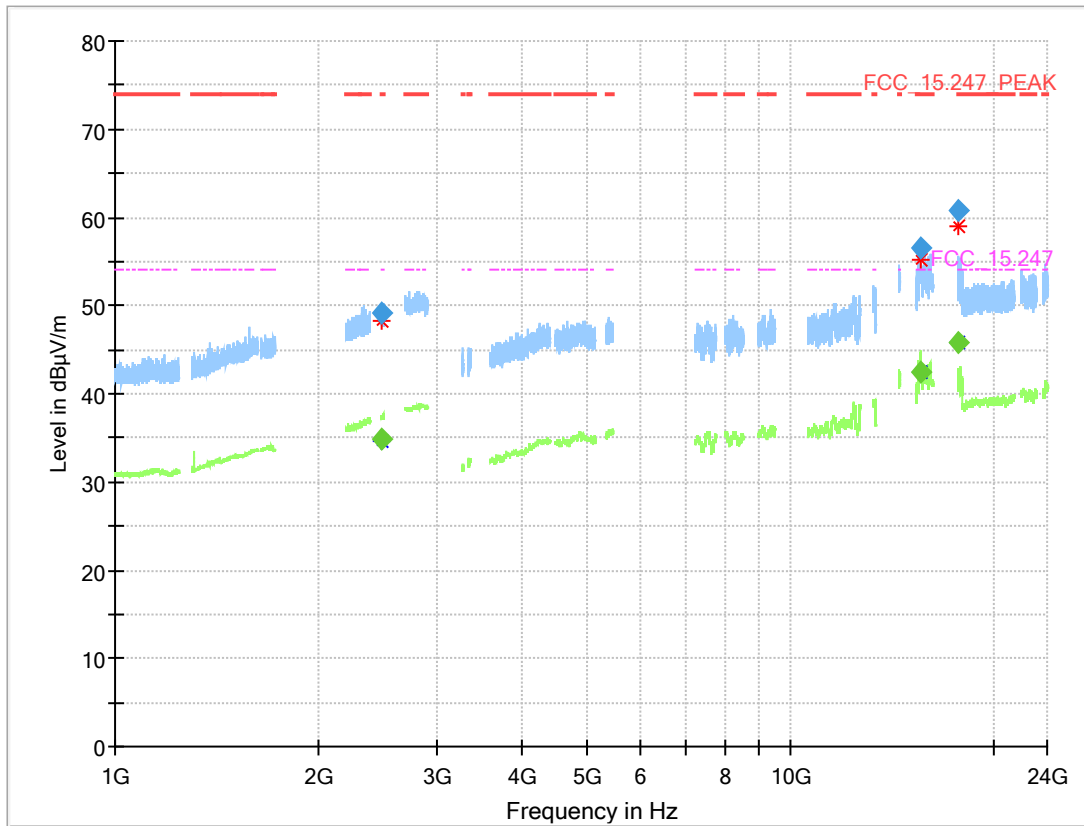

Radio Technology = WLAN b, Operating Frequency = high, Measurement range =
1 GHz - 26 GHz
(S01_AD01)

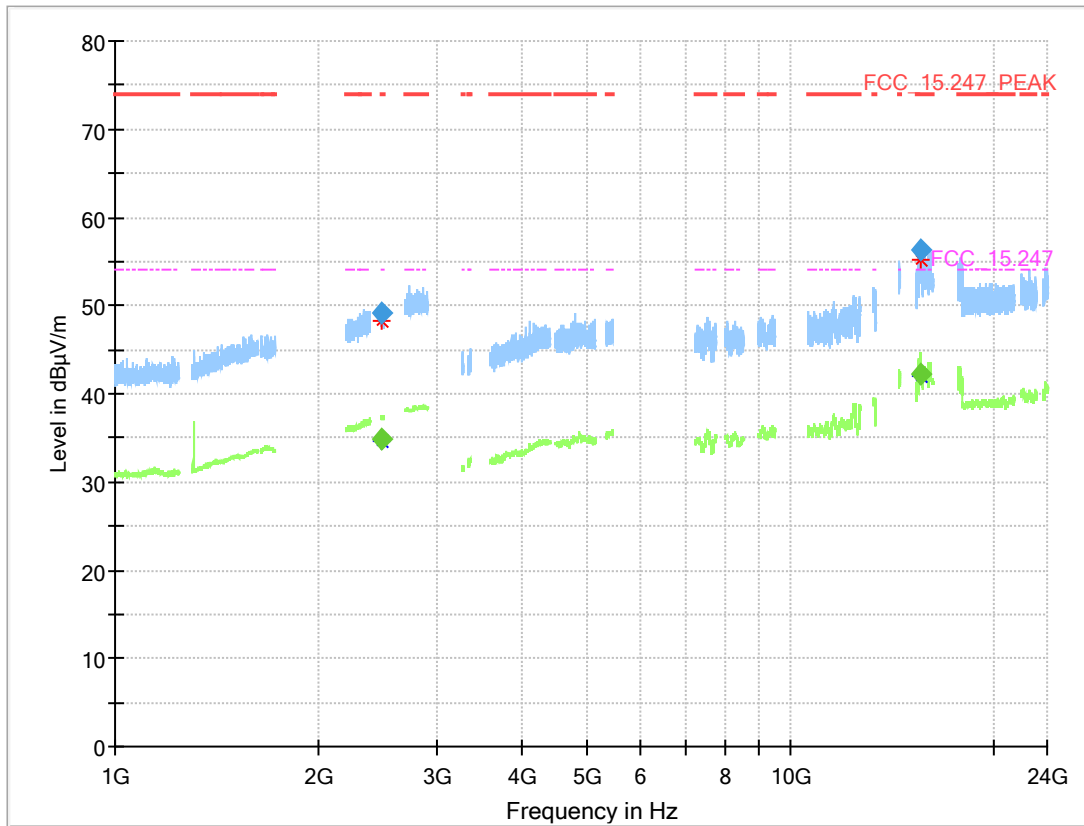

Radio Technology = WLAN b, Operating Frequency = low, Measurement range =
1 GHz - 26 GHz
(S01_AD01)

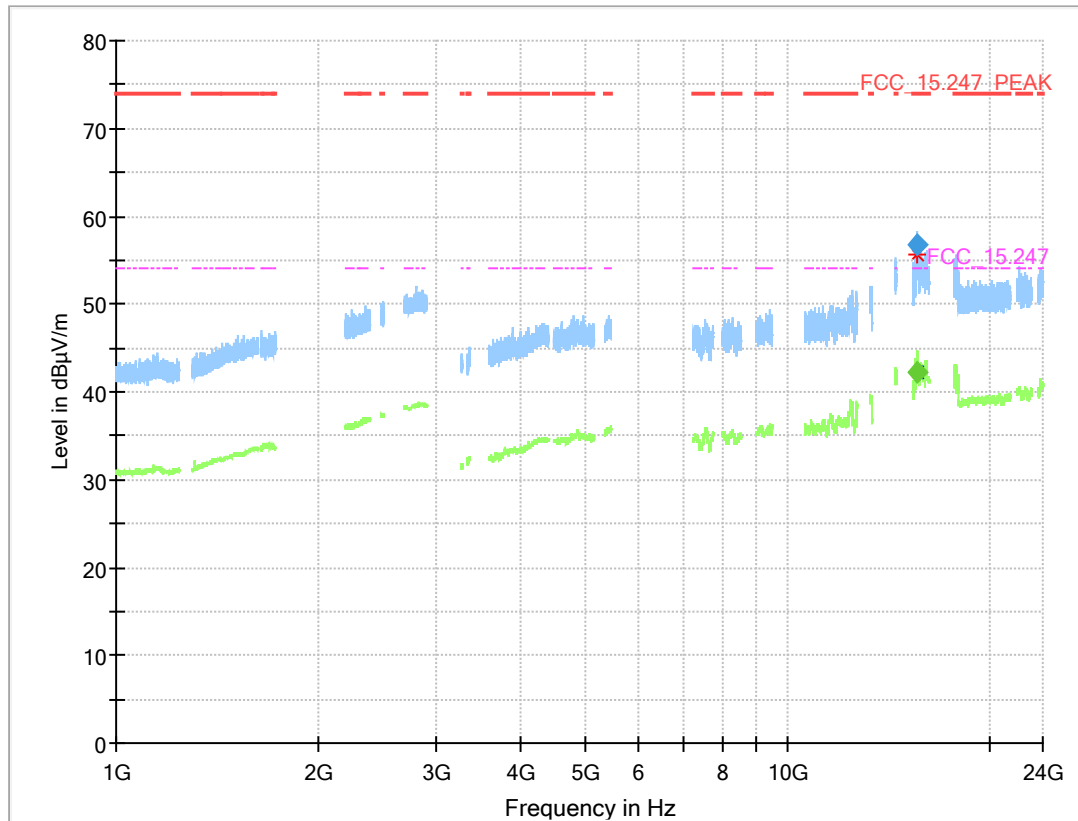

Radio Technology = WLAN b, Operating Frequency = high, Measurement range =
30 MHz - 1 GHz
(S01_AD01)

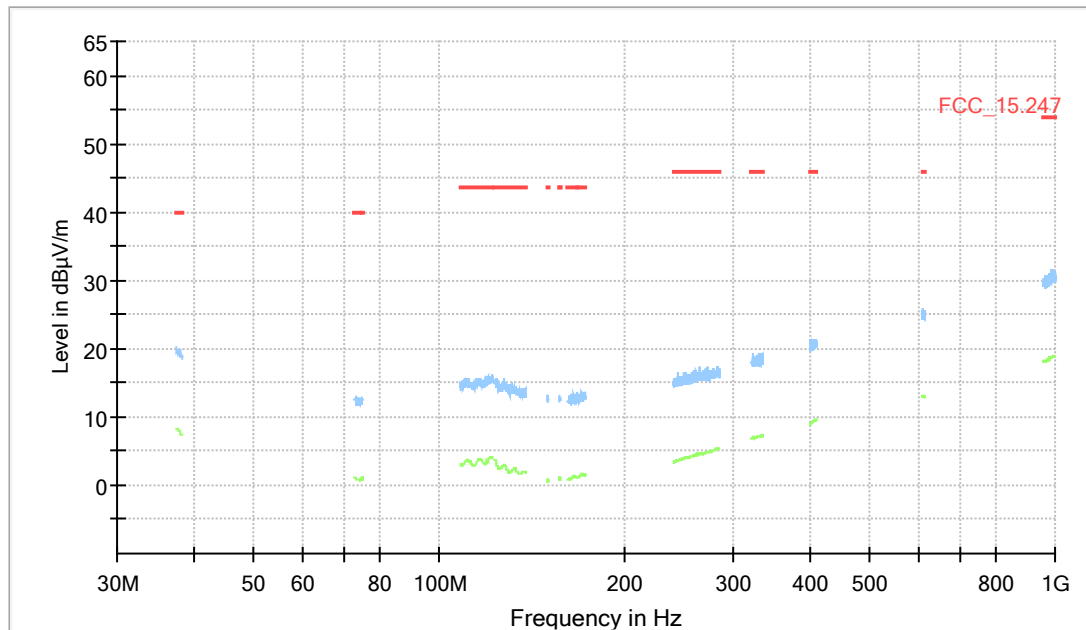

Radio Technology = WLAN g, Operating Frequency = high, Measurement range =
1 GHz - 8 GHz
(S01_AD01)

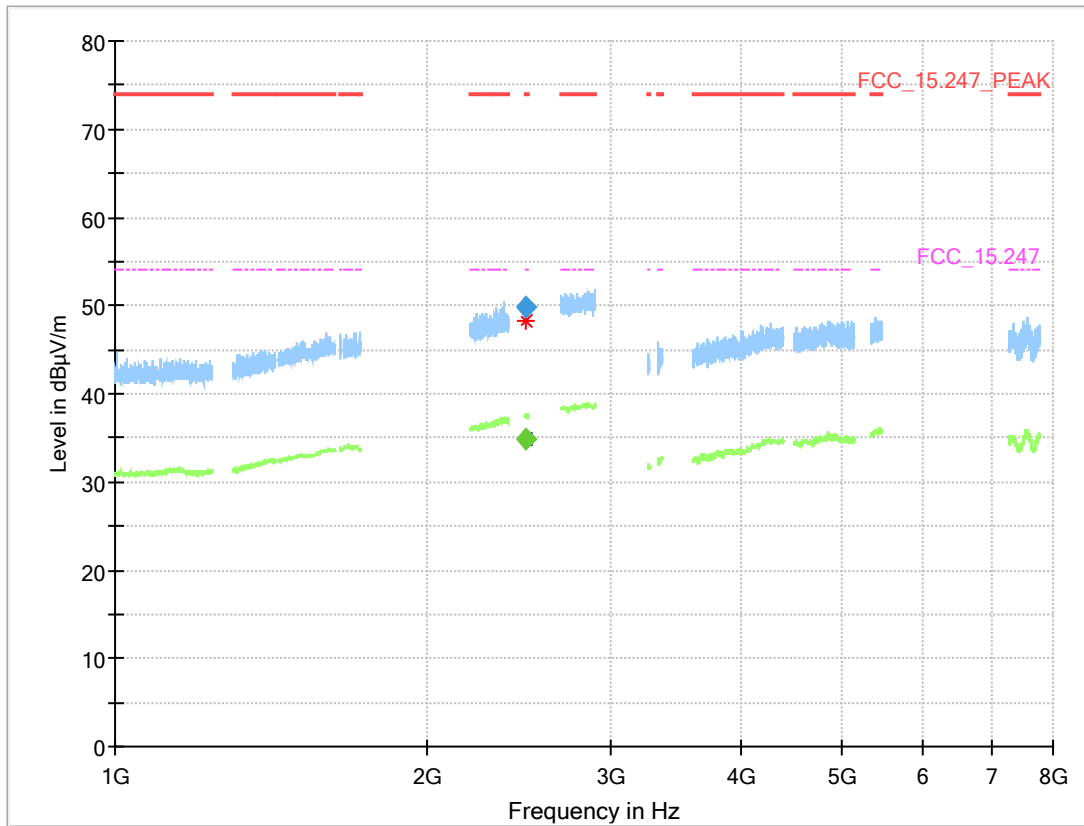

Radio Technology = WLAN g, Operating Frequency = low, Measurement range =
1 GHz - 8 GHz
(S01_AD01)

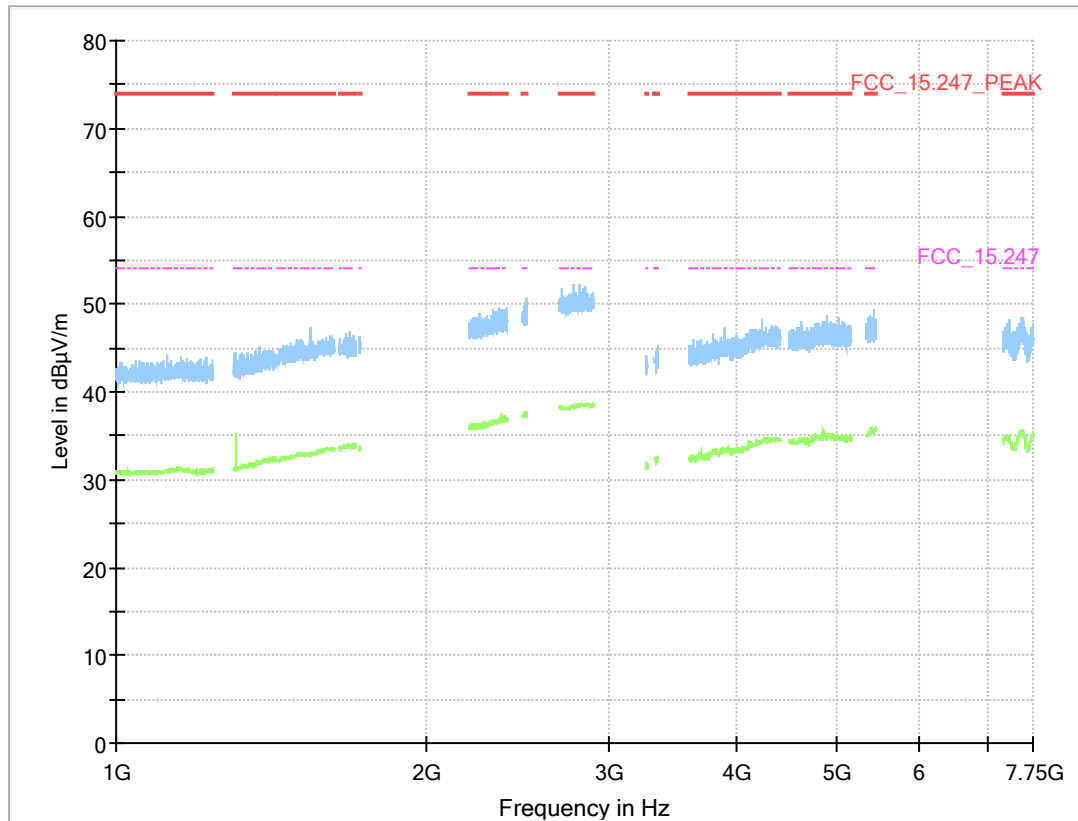

5.2.5 TEST EQUIPMENT USED

- Radiated Emissions

5.3 BAND EDGE COMPLIANCE CONDUCTED

Standard **FCC Part 15 Subpart C**

The test was performed according to:
ANSI C63.10, chapter 11.11

5.3.1 TEST DESCRIPTION

For the conducted measurement, the Equipment Under Test (EUT) is placed in a shielded room. The reference power was measured in the test case "Spurious RF Conducted Emissions".

The EUT was connected to the test system as described in the block diagram below. The complete attenuation of the measurement path is known and considered.

Analyser settings:

- Lower Band Edge:
Measured range: 2310.0 MHz to 2483.5 MHz
Upper Band Edge
Measured range: 2400.0 MHz to 2500 MHz
- Detector: Peak
- Resolution Bandwidth (RBW): 100 kHz
- Video Bandwidth (VBW): 300 kHz
- Sweptime: Auto
- Sweeps: Till stable (min. 300, max. 15000)
- Trace: Maxhold

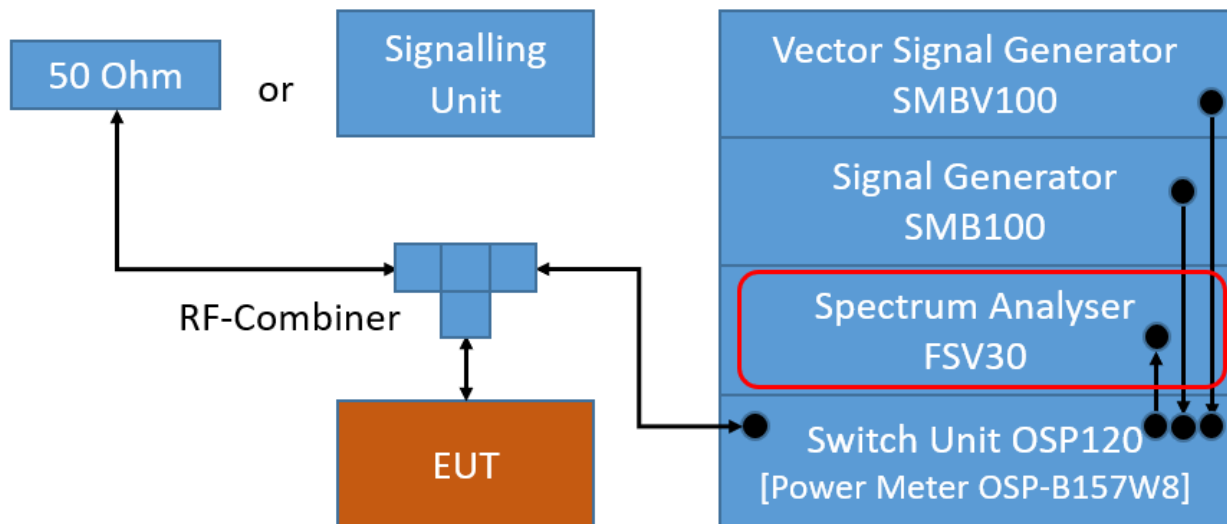

TS8997; Band Edge Conducted

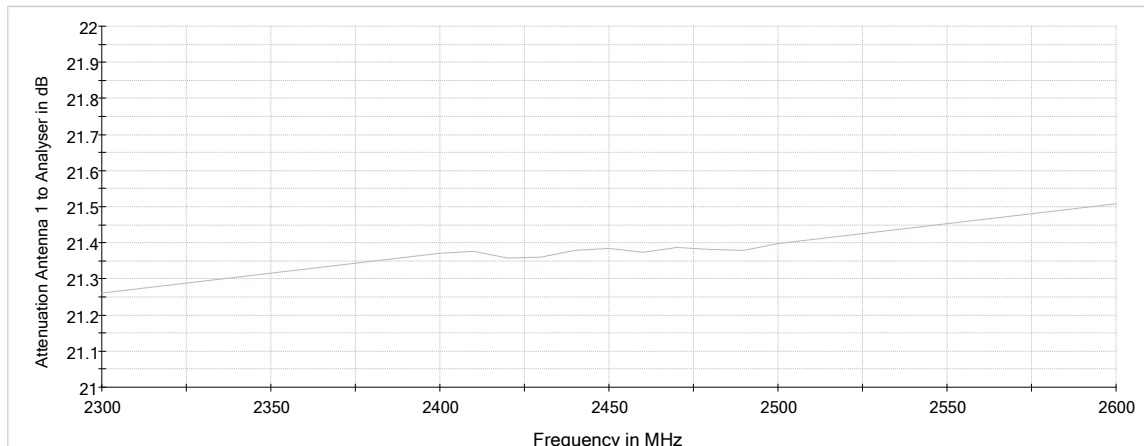

Attenuation of the measurement path

5.3.2 TEST REQUIREMENTS / LIMITS

FCC Part 15.247 (d)

“In any 100 kHz bandwidth outside the frequency band in which the spread spectrum or digitally modulated intentional radiator is operating, the radio frequency power that is produced by the intentional radiator shall be at least 20 dB below that in the 100 kHz bandwidth within the band that contains the highest level of the desired power, based on either an RF conducted or a radiated measurement, provided the transmitter demonstrates compliance with the peak conducted power limits. ...

If the transmitter complies with the conducted power limits based on the use of RMS averaging over a time interval, as permitted under paragraph (b)(3) of this section, the attenuation required under this paragraph shall be 30 dB instead of 20 dB. Attenuation below the general limits specified in Section 15.209(a) is not required. In addition, radiated emissions which fall in the restricted bands, as defined in Section 15.205(a), must also comply with the radiated emission limits specified in Section 15.209(a) (see Section 15.205(c)).”

For the conducted measurement the RF power at the band edge shall be “at least 20 dB below that in the 100 kHz bandwidth within the band that contains the highest level of the desired power...”

5.3.3 TEST PROTOCOL

Ambient temperature: 26 °C
 Air Pressure: 1019 hPa
 Humidity: 40 %

WLAN b-Mode; 20 MHz; 1 Mbit/s

Channel No.	Channel Center Frequency [MHz]	Band Edge Freq. [MHz]	Spurious Level [dBm]	Detector	RBW [kHz]	Ref. Level [dBm]	Limit [dBm]	Margin to Limit [dB]
1	2412	2400.0	-38.1	PEAK	100	-	-20.4	17.7
11	2462	2483.5	-48.7	PEAK	100	-	-20.0	28.7

WLAN g-Mode; 20 MHz; 6 Mbit/s

Channel No.	Channel Center Frequency [MHz]	Band Edge Freq. [MHz]	Spurious Level [dBm]	Detector	RBW [kHz]	Ref. Level [dBm]	Limit [dBm]	Margin to Limit [dB]
1	2412	2400.0	-28.8	PEAK	100	-	-24.5	4.3
11	2462	2483.5	-42.3	PEAK	100	-	-24.1	18.2

Remark: Please see next sub-clause for the measurement plot.

5.3.4 MEASUREMENT PLOT (EXAMPLE PLOT, SHOWING WORST CASE, IF APPLICABLE)

Radio Technology = WLAN b, Operating Frequency = low, Band Edge = low (S01_AC01)

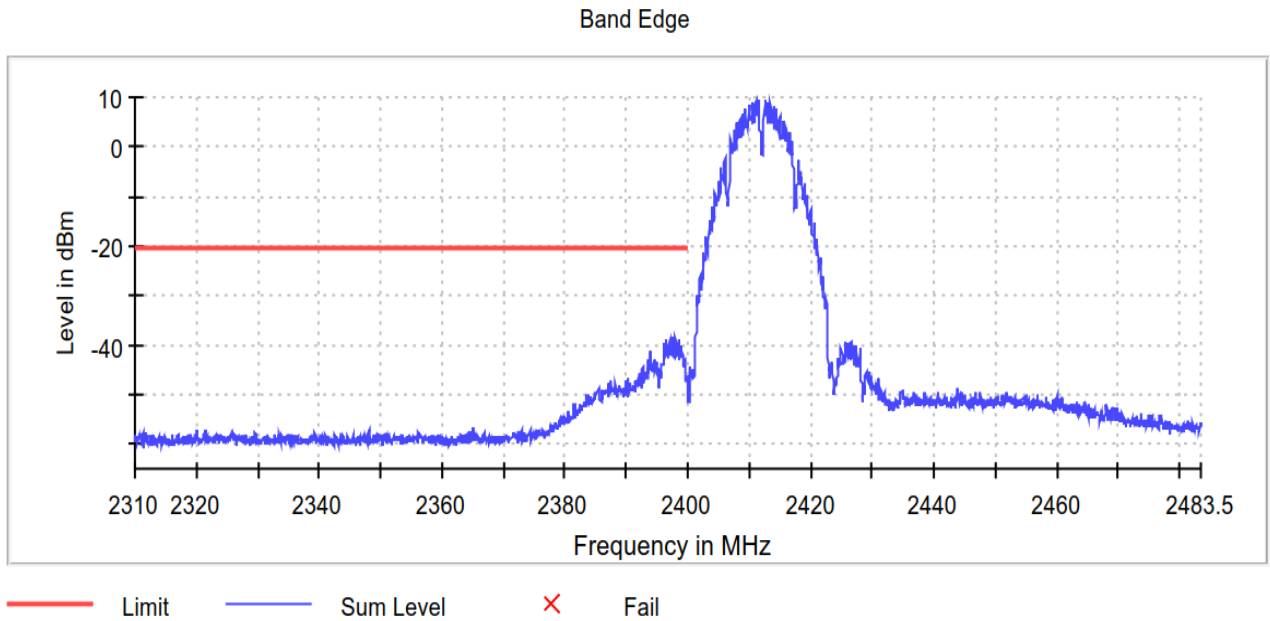

Radio Technology = WLAN b, Operating Frequency = high, Band Edge = high (S01_AC01)

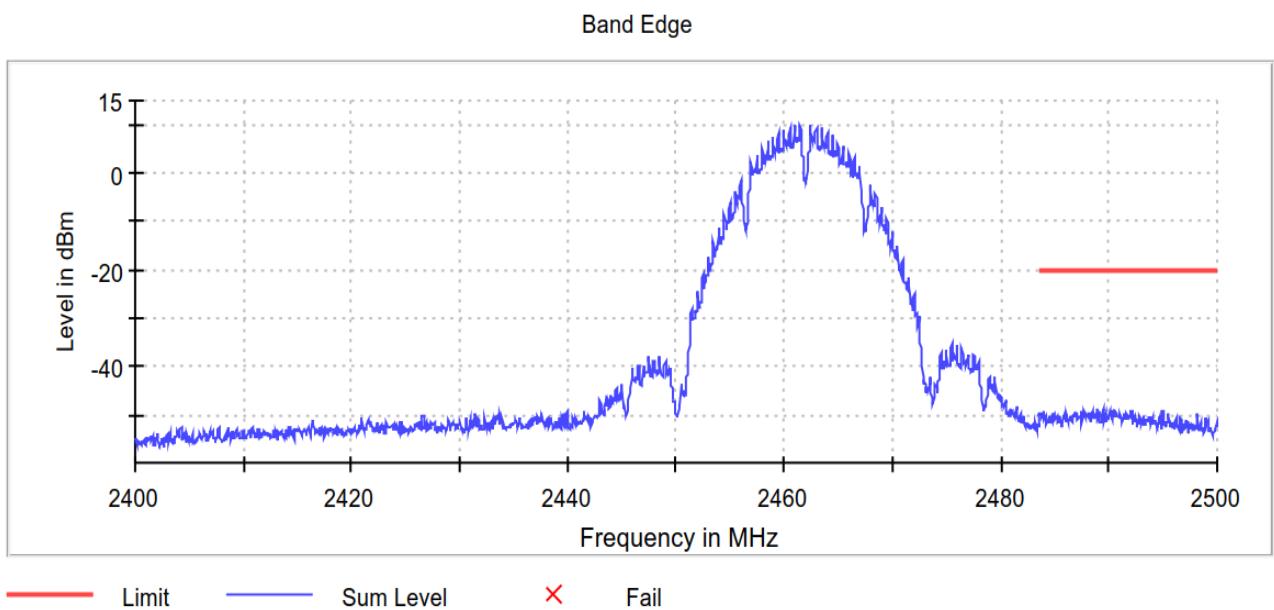

Radio Technology = WLAN g, Operating Frequency = low, Band Edge = low
(S01_AC01)

Band Edge

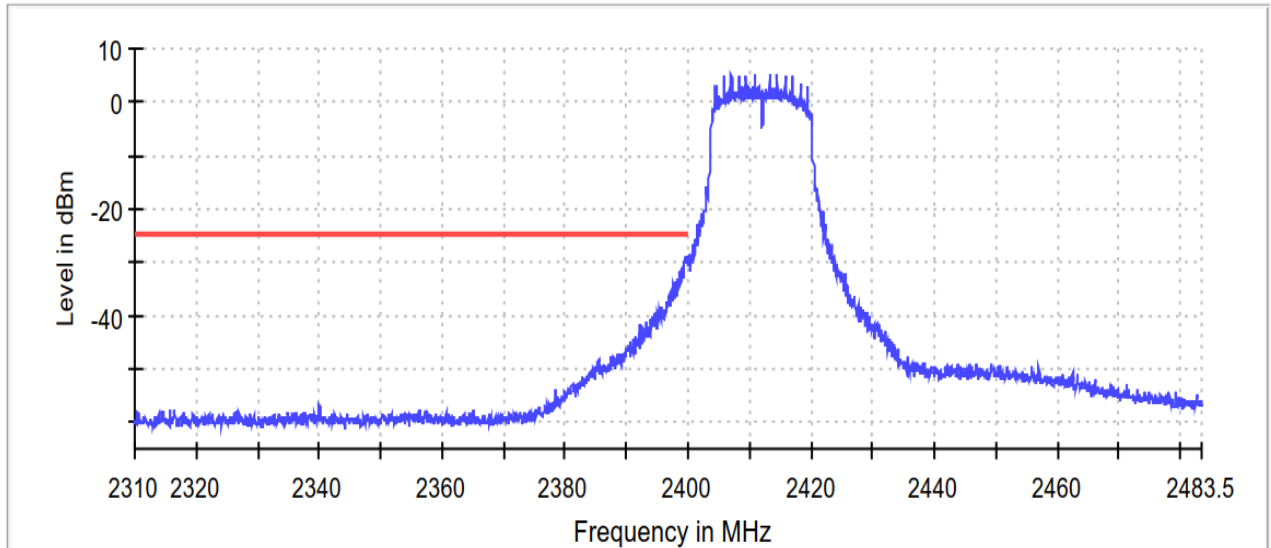

— Limit — Sum Level × Fail

Radio Technology = WLAN g, Operating Frequency = high, Band Edge = high
(S01_AC01)

Band Edge

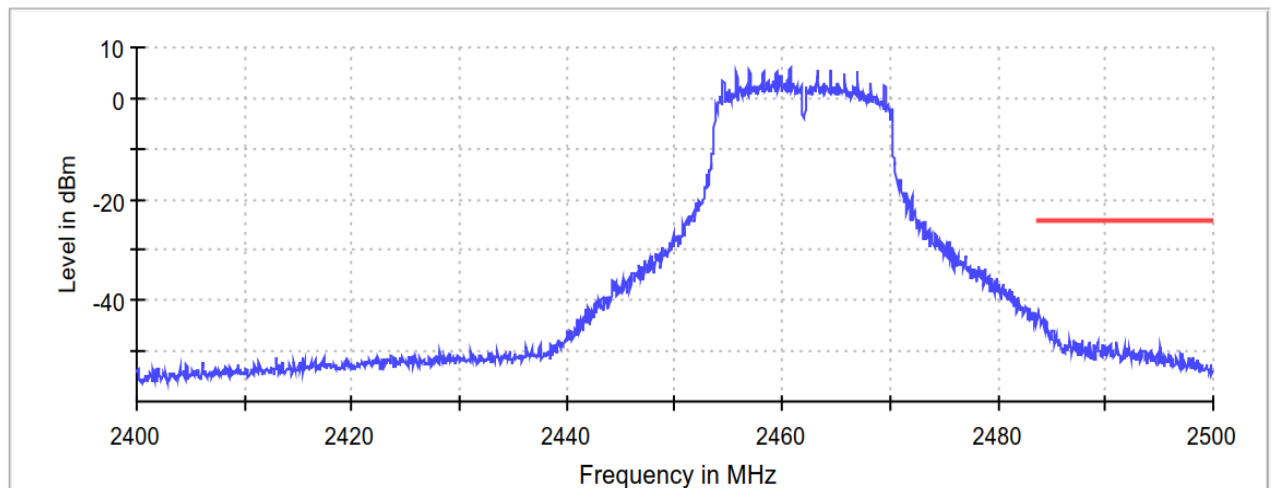

— Limit — Sum Level × Fail

5.3.5 TEST EQUIPMENT USED

- R&S TS8997

5.4 BAND EDGE COMPLIANCE RADIATED

Standard **FCC Part 15 Subpart C**

The test was performed according to:

ANSI C63.10, chapter 6.6.5

5.4.1 TEST DESCRIPTION

The test set-up was made in accordance to the general provisions of ANSI C63.10 in a typical installation configuration. The measurements were performed according the following sub-chapter of ANSI C63.10:

- Chapter 6.10.5

The Equipment Under Test (EUT) was set up on a non-conductive support (tilt device) at 1.5 m height in the fully-anechoic chamber.

All steps were performed with one height (1.5 m) of the receiving antenna only (procedure according ANSI C63.10, chapter 6.6.5).

3. Measurement above 1 GHz

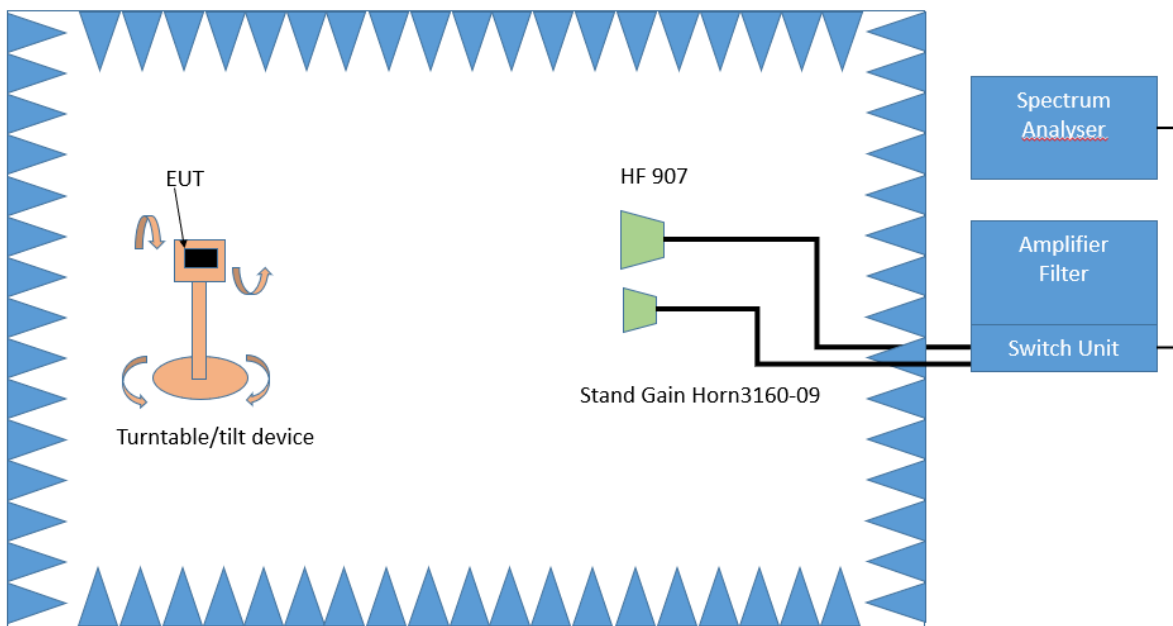

Test Setup; Spurious Emission Radiated (FAC), 1 GHz-26.5 GHz

Step 1:

The EUT is turned during the preliminary measurement across the elevation axis, with a step size of 90 °.

The turn table step size (azimuth angle) for the preliminary measurement is 45 °.

Spectrum analyser settings:

- Detector: Peak, Average
- RBW = 1 MHz
- VBW = 3 MHz

Step 2:

The turn table azimuth will slowly vary by $\pm 22.5^\circ$.

The elevation angle will slowly vary by $\pm 45^\circ$

Spectrum analyser settings:

- Detector: Peak

Step 3:

Spectrum analyser settings for step 3:

- Detector: Peak / CISPR Average
- Measured frequencies: in step 1 determined frequencies
- RBW = 1 MHz
- VBW = 3 MHz
- Measuring time: 1 s

5.4.2 TEST REQUIREMENTS / LIMITS

For band edges connected to a restricted band, the limits are specified in Section 15.209(a)

FCC Part 15, Subpart C, §15.209, Radiated Emission Limits

Frequency in MHz	Limit ($\mu\text{V}/\text{m}$)	Measurement distance (m)	Limits ($\text{dB}\mu\text{V}/\text{m}$)
0.009 – 0.49	2400/F(kHz)@300m	3	(48.5 – 13.8)@300m
0.49 – 1.705	24000/F(kHz)@30m	3	(33.8 – 23.0)@30m
1.705 – 30	30@30m	3	29.5@30m

The measured values are corrected with an inverse linear distance extrapolation factor (40 dB/decade) according FCC 15.31 (2).

Frequency in MHz	Limit ($\mu\text{V}/\text{m}$)	Measurement distance (m)	Limits ($\text{dB}\mu\text{V}/\text{m}$)
30 – 88	100@3m	3	40.0@3m
88 – 216	150@3m	3	43.5@3m
216 – 960	200@3m	3	46.0@3m
960 – 26000	500@3m	3	54.0@3m
26000 – 40000	500@3m	1	54.0@3m

The measured values above 26 GHz are corrected with an inverse linear distance extrapolation factor (20 dB/decade).

§15.35(b) ..., there is also a limit on the radio frequency emissions, as measured using instrumentation with a peak detector function, corresponding to 20 dB above the maximum permitted average limit....

Used conversion factor: $\text{Limit (dB}\mu\text{V}/\text{m)} = 20 \log (\text{Limit } (\mu\text{V}/\text{m})/1\mu\text{V}/\text{m})$

5.4.3 TEST PROTOCOL

Ambient temperature: 26 °C
 Air Pressure: 1006 hPa
 Humidity: 42 %
 BT LE 1 Mbit/s
 Applied duty cycle correction (AV): 0 dB

Setup	Ch. Center Freq. [MHz]	Band Edge Freq. [MHz]	Spurious Level [dBμV/m]	Detector	RBW [kHz]	Limit [dBμV/m]	Margin to Limit [dB]
S01_AE01	2480	2483.5	49.2	PEAK	1000	74.0	24.8
S01_AE01	2480	2483.5	34.8	AV	1000	54.0	19.2

WLAN b-Mode; 20 MHz; 1 Mbit/s
 Applied duty cycle correction (AV): 0 dB

Setup	Ch. Center Freq. [MHz]	Band Edge Freq. [MHz]	Spurious Level [dBμV/m]	Detector	RBW [kHz]	Limit [dBμV/m]	Margin to Limit [dB]
S01_AD01	2462	2483.5	49.2	PEAK	1000	74.0	24.8
S01_AD01	2462	2483.5	34.8	AV	1000	54.0	19.2

WLAN g-Mode; 20 MHz; 6 Mbit/s
 Applied duty cycle correction (AV): 0 dB

Setup	Ch. Center Freq. [MHz]	Band Edge Freq. [MHz]	Spurious Level [dBμV/m]	Detector	RBW [kHz]	Limit [dBμV/m]	Margin to Limit [dB]
S01_AD01	2462	2483.5	49.8	PEAK	1000	74.0	24.2
S01_AD01	2462	2483.5	34.9	AV	1000	54.0	19.1

Remark: Please see next sub-clause for the measurement plot.

5.4.4 MEASUREMENT PLOT (EXAMPLE PLOT, SHOWING WORST CASE, IF APPLICABLE)

Radio Technology = Bluetooth LE 1 Mbps, Operating Frequency = high, Band Edge = high (S01_AE01)

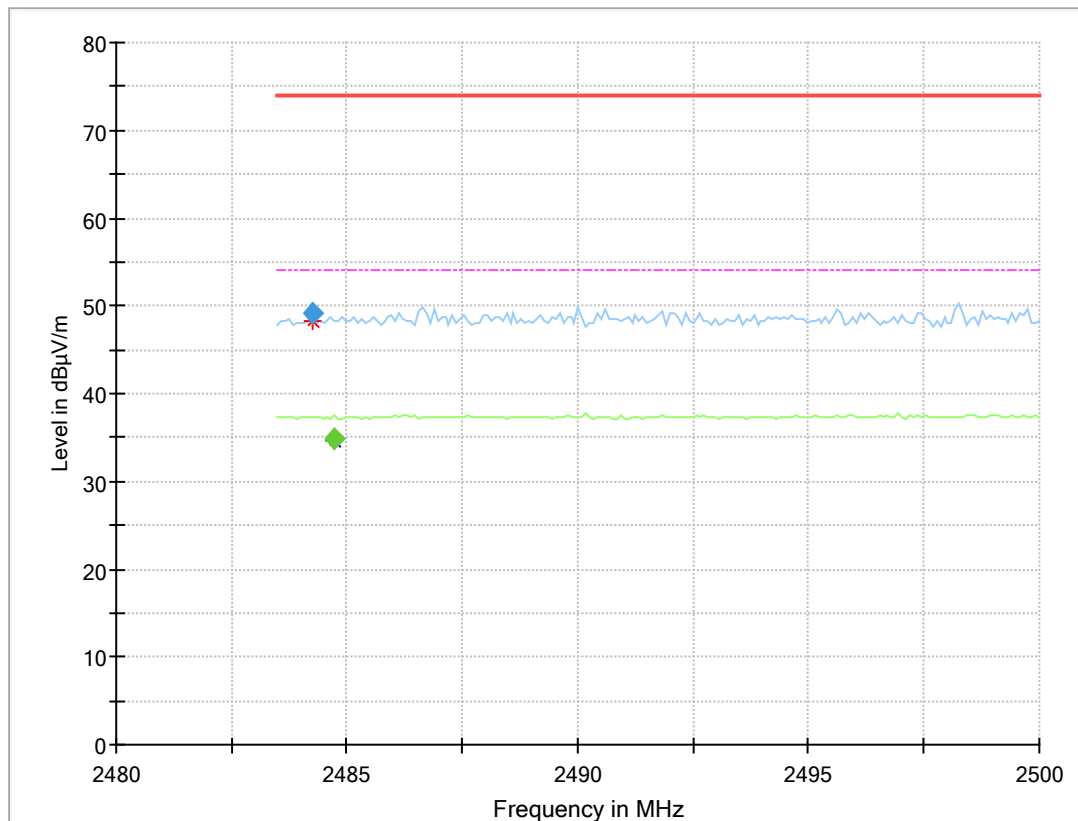

Final Result

Frequency (MHz)	MaxPeak (dBµV/m)	CAverage (dBµV/m)	Limit (dBµV/m)	Margin (dB)	Meas. Time (ms)	Bandwidth (kHz)	Height (cm)	Pol	Azimuth (deg)	Elevation (deg)	Corr. (dB/m)
2484.243	49.2	---	74.00	24.79	1000.0	1000.000	150.0	V	-38.0	15.0	5.3
2484.738	---	34.8	54.00	19.16	1000.0	1000.000	150.0	V	-131.0	-12.0	5.3

Radio Technology = WLAN b, Operating Frequency = high, Band Edge = high
(S01_AD01)

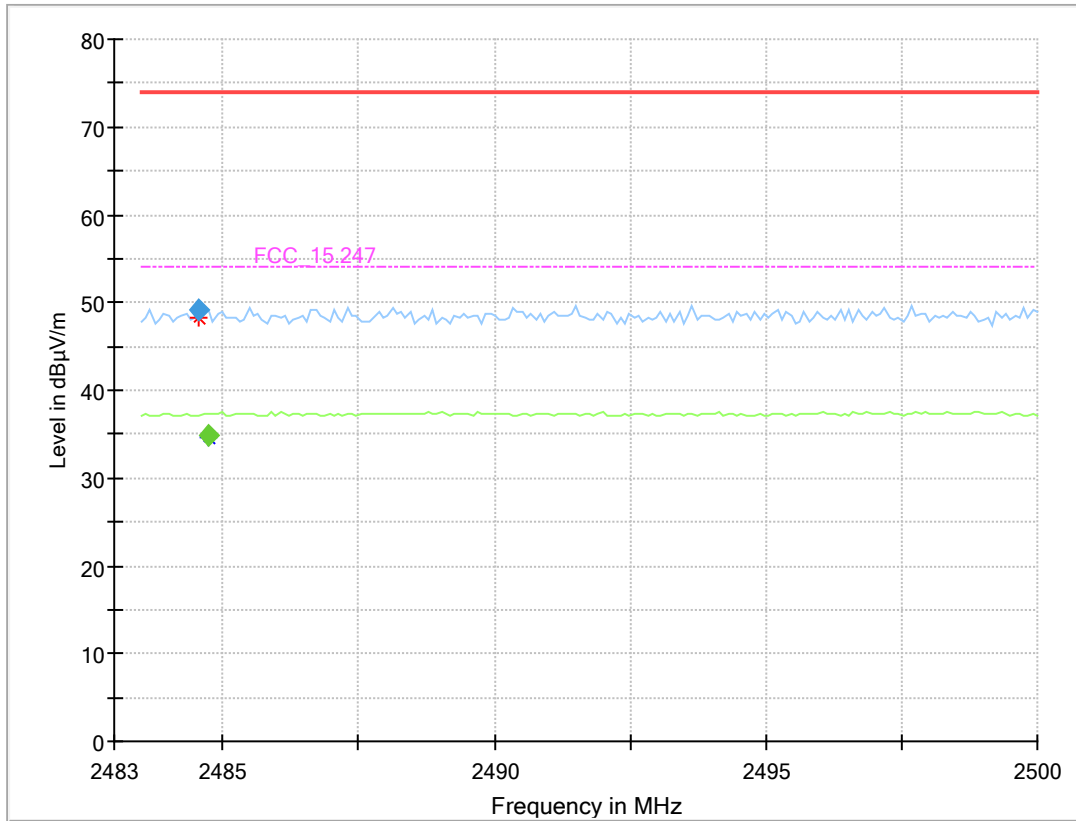

Final Result

Frequency (MHz)	MaxPeak (dBµV/m)	CAverage (dBµV/m)	Limit (dBµV/m)	Margin (dB)	Meas. Time (ms)	Bandwidth (kHz)	Height (cm)	Pol	Azimuth (deg)	Elevation (deg)	Corr. (dB/m)
2484.573	49.2	---	74.00	24.76	1000.0	1000.000	150.0	H	79.0	-10.0	5.3
2484.738	---	34.8	54.00	19.22	1000.0	1000.000	150.0	V	-11.0	75.0	5.3

Radio Technology = WLAN g, Operating Frequency = high, Band Edge = high
(S01_AD01)

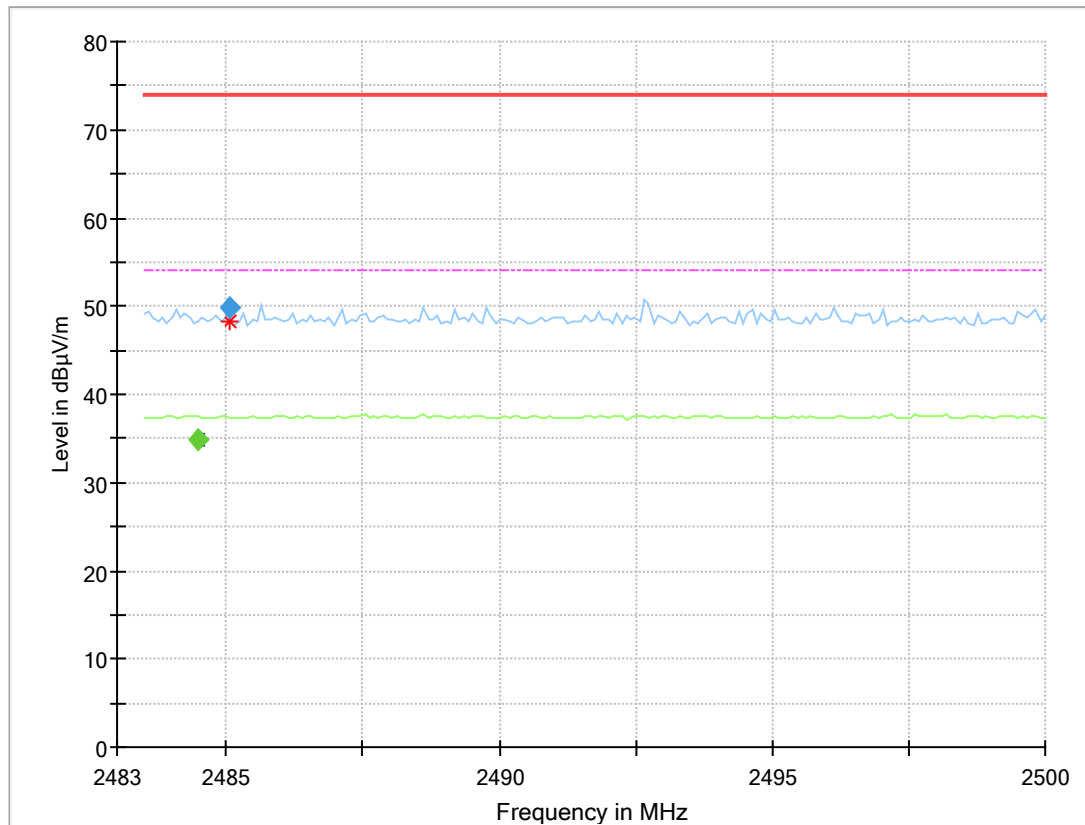

Final Result

Frequency (MHz)	MaxPeak (dBµV/m)	CAverage (dBµV/m)	Limit (dBµV/m)	Margin (dB)	Meas. Time (ms)	Bandwidth (kHz)	Height (cm)	Pol	Azimuth (deg)	Elevation (deg)	Corr. (dB/m)
2484.490	---	34.9	54.00	19.06	1000.0	1000.000	150.0	H	-147.0	90.0	5.3
2485.068	49.8	---	74.00	24.21	1000.0	1000.000	150.0	V	161.0	105.0	5.3

5.4.5 TEST EQUIPMENT USED

- Radiated Emissions

6 TEST EQUIPMENT

- 1 R&S TS8997
2.4 and 5 GHz Bands Conducted Test Lab

Ref.No.	Device Name	Description	Manufacturer	Serial Number	Last Calibration	Calibration Due
1.1	MFS	Rubidium Frequency Normal MFS	Datum GmbH	002	2021-11	2022-11
1.2	SMB100A	Signal Generator 9 kHz - 6 GHz	Rohde & Schwarz	107695	2021-06	2024-06
1.3	FSV30	Signal Analyzer 10 Hz - 30 GHz	Rohde & Schwarz	103005	2020-05	2022-05
1.4	Opus10 THI (8152.00)	T/H Logger 15	Lufft Mess- und Regeltechnik GmbH	13985	2021-08	2023-08
1.5	NGSM 32/10	Power Supply	Rohde & Schwarz GmbH & Co. KG	3456	2022-01	2024-01
1.6	Opus10 THI (8152.00)	T/H Logger 14	Lufft Mess- und Regeltechnik GmbH	13993	2021-08	2023-08
1.7	SMBV100A	Vector Signal Generator 9 kHz - 6 GHz	Rohde & Schwarz	259291	2019-11	2022-11
1.8	OSP120	Contains Power Meter and Switching Unit OSP-B157W8	Rohde & Schwarz	101158	2021-06	2024-06

- 2 Radiated Emissions
Lab to perform radiated emission tests

Ref.No.	Device Name	Description	Manufacturer	Serial Number	Last Calibration	Calibration Due
2.1	MFS	Rubidium Frequency Normal MFS	Datum GmbH	002	2021-11	2022-11
2.2	Opus10 TPR (8253.00)	T/P Logger 13	Lufft Mess- und Regeltechnik GmbH	13936	2021-10	2023-10
2.3	ESW44	EMI Receiver / Spectrum Analyzer	Rohde & Schwarz GmbH & Co. KG	101603	2022-01	2024-01
2.4	Anechoic Chamber 01	SAC/FAR, 10.58 m x 6.38 m x 6.00 m	Frankonia	none	2021-04	2023-04
2.5	HL 562 ULTRALOG	Biconical-log-per antenna (30 MHz - 3 GHz) with HL 562E biconicals	Rohde & Schwarz GmbH & Co. KG	830547/003	2021-09	2024-09
2.6	AMF-7D00101800-30-10P-R	Broadband Amplifier 100 MHz - 18 GHz	Miteq		N/A	N/A
2.7	ASP 1.2/1.8-10 kg	Antenna Mast	Maturo GmbH	-	N/A	N/A

Ref.No.	Device Name	Description	Manufacturer	Serial Number	Last Calibration	Calibration Due
2.8	Anechoic Chamber 03	FAR, 8.80m x 4.60m x 4.05m (l x w x h)	Albatross Projects	P26971-647-001-PRB	2021-04	2023-04
2.9	Fluke 177	Digital Multimeter 03 (Multimeter)	Fluke Europe B.V.	86670383	2020-04	2022-04
2.10	JS4-18002600-32-5P	Broadband Amplifier 18 GHz - 26 GHz	Miteq	849785		
2.11	FSW 43	Spectrum Analyzer	Rohde & Schwarz	103779	2021-06	2023-06
2.12	EP 1200/B, NA/B1	AC Source, Amplifier with integrated variable Oscillator	Spitzenberger & Spies GmbH & Co. KG	B6278	N/A	N/A
2.13	3160-09	Standard Gain / Pyramidal Horn Antenna 26.5 GHz	EMCO Elektronik GmbH	00083069	N/A	N/A
2.14	WHKX 7.0/18G-8SS	High Pass Filter	Wainwright Instruments GmbH	09	N/A	N/A
2.15	DS 420S	Turn Table 2 m diameter	HD GmbH	420/573/99	N/A	N/A
2.16	JS4-00102600-42-5A	Broadband Amplifier 30 MHz - 26 GHz	Miteq	619368	N/A	N/A
2.17	TT 1.5 WI	Turn Table	Maturo GmbH	-	N/A	N/A
2.18	HL 562 ULTRALOG	Biconical-log-per Antenna (30 MHz - 3 GHz)	Rohde & Schwarz GmbH & Co. KG	100609	2019-05	2022-05
2.19	MA4985-XP-ET	Bore Sight Antenna Mast	innco systems GmbH	none	N/A	N/A
2.20	JUN-AIR Mod. 6-15	Air Compressor	JUN-AIR Deutschland GmbH	612582	N/A	N/A
2.21	5HC3500/18000-1.2-KK	High Pass Filter	Trilithic	200035008	N/A	N/A
2.22	HFH2-Z2	Loop Antenna + 3 Axis Tripod	Rohde & Schwarz GmbH & Co. KG	829324/006	2021-01	2024-01
2.23	SB4-100.OLD20-3T/10 Airwin 2 x 1.5 kW	Air compressor (oil-free)	airWin Kompressoren UG	901/00503	N/A	N/A
2.24	JS4-00101800-35-5P	Broadband Amplifier 30 MHz - 18 GHz	Miteq	896037	N/A	N/A
2.25	AS 620 P	Antenna Mast (pneumatic polarisation)	HD GmbH	620/37	N/A	N/A
2.26	TD1.5-10kg	EUT Tilt Device (Rohacell)	Maturo GmbH	TD1.5-10kg/024/3790709	N/A	N/A
2.27	HF 907-2	Double-ridged horn	Rohde & Schwarz	102817	2019-04	2022-04
2.28	PAS 2.5 - 10 kg	Antenna Mast	Maturo GmbH	-	N/A	N/A

Ref.No.	Device Name	Description	Manufacturer	Serial Number	Last Calibration	Calibration Due
2.29	AFS42-00101800-25-S-42	Broadband Amplifier 25 MHz - 18 GHz	Miteq	2035324	N/A	N/A
2.30	AM 4.0	Antenna Mast 4 m	Maturo GmbH	AM4.0/180/11920513	N/A	N/A
2.31	HF 907	Double-ridged horn	Rohde & Schwarz	102444	2021-09	2024-09

The calibration interval is the time interval between "Last Calibration" and "Calibration Due"

7 ANTENNA FACTORS, CABLE LOSS AND SAMPLE CALCULATIONS

This chapter contains the antenna factors with their corresponding path loss of the used measurement path for all antennas as well as the insertion loss of the LISN.

7.1 LISN R&S ESH3-Z5 (150 KHZ – 30 MHZ)

Frequency MHz	Corr. dB	LISN insertion loss ESH3- Z5 dB	cable loss (incl. 10 dB atten- uator) dB
0.15	10.1	0.1	10.0
5	10.3	0.1	10.2
7	10.5	0.2	10.3
10	10.5	0.2	10.3
12	10.7	0.3	10.4
14	10.7	0.3	10.4
16	10.8	0.4	10.4
18	10.9	0.4	10.5
20	10.9	0.4	10.5
22	11.1	0.5	10.6
24	11.1	0.5	10.6
26	11.2	0.5	10.7
28	11.2	0.5	10.7
30	11.3	0.5	10.8

Sample calculation

$$U_{\text{LISN}} (\text{dB } \mu\text{V}) = U (\text{dB } \mu\text{V}) + \text{Corr. (dB)}$$

U = Receiver reading

LISN Insertion loss = Voltage Division Factor of LISN

Corr. = sum of single correction factors of used LISN, cables, switch units (if used)

Linear interpolation will be used for frequencies in between the values in the table.

7.2 ANTENNA R&S HFH2-Z2 (9 KHZ – 30 MHZ)

Frequency MHz	AF HFH-Z2) dB (1/m)	Corr. dB	cable loss 1 (inside chamber) dB	cable loss 2 (outside chamber) dB	cable loss 3 (switch unit) dB	cable loss 4 (to receiver) dB	distance corr. (-40 dB/ decade) dB	d _{Limit} (meas. distance (limit) m	d _{used} (meas. distance (used) m
0.009	20.50	-79.6	0.1	0.1	0.1	0.1	-80	300	3
0.01	20.45	-79.6	0.1	0.1	0.1	0.1	-80	300	3
0.015	20.37	-79.6	0.1	0.1	0.1	0.1	-80	300	3
0.02	20.36	-79.6	0.1	0.1	0.1	0.1	-80	300	3
0.025	20.38	-79.6	0.1	0.1	0.1	0.1	-80	300	3
0.03	20.32	-79.6	0.1	0.1	0.1	0.1	-80	300	3
0.05	20.35	-79.6	0.1	0.1	0.1	0.1	-80	300	3
0.08	20.30	-79.6	0.1	0.1	0.1	0.1	-80	300	3
0.1	20.20	-79.6	0.1	0.1	0.1	0.1	-80	300	3
0.2	20.17	-79.6	0.1	0.1	0.1	0.1	-80	300	3
0.3	20.14	-79.6	0.1	0.1	0.1	0.1	-80	300	3
0.49	20.12	-79.6	0.1	0.1	0.1	0.1	-80	300	3
0.490001	20.12	-39.6	0.1	0.1	0.1	0.1	-40	30	3
0.5	20.11	-39.6	0.1	0.1	0.1	0.1	-40	30	3
0.8	20.10	-39.6	0.1	0.1	0.1	0.1	-40	30	3
1	20.09	-39.6	0.1	0.1	0.1	0.1	-40	30	3
2	20.08	-39.6	0.1	0.1	0.1	0.1	-40	30	3
3	20.06	-39.6	0.1	0.1	0.1	0.1	-40	30	3
4	20.05	-39.5	0.2	0.1	0.1	0.1	-40	30	3
5	20.05	-39.5	0.2	0.1	0.1	0.1	-40	30	3
6	20.02	-39.5	0.2	0.1	0.1	0.1	-40	30	3
8	19.95	-39.5	0.2	0.1	0.1	0.1	-40	30	3
10	19.83	-39.4	0.2	0.1	0.2	0.1	-40	30	3
12	19.71	-39.4	0.2	0.1	0.2	0.1	-40	30	3
14	19.54	-39.4	0.2	0.1	0.2	0.1	-40	30	3
16	19.53	-39.3	0.3	0.1	0.2	0.1	-40	30	3
18	19.50	-39.3	0.3	0.1	0.2	0.1	-40	30	3
20	19.57	-39.3	0.3	0.1	0.2	0.1	-40	30	3
22	19.61	-39.3	0.3	0.1	0.2	0.1	-40	30	3
24	19.61	-39.3	0.3	0.1	0.2	0.1	-40	30	3
26	19.54	-39.3	0.3	0.1	0.2	0.1	-40	30	3
28	19.46	-39.2	0.3	0.1	0.3	0.1	-40	30	3
30	19.73	-39.1	0.4	0.1	0.3	0.1	-40	30	3

Sample calculation

$$E \text{ (dB } \mu\text{V/m)} = U \text{ (dB } \mu\text{V)} + AF \text{ (dB 1/m)} + Corr. \text{ (dB)}$$

U = Receiver reading

AF = Antenna factor

Corr. = sum of single correction factors of used cables, switch unit, distance correction, amplifier (if applicable)

distance correction = $-40 * \text{LOG} (d_{\text{Limit}} / d_{\text{used}})$

Linear interpolation will be used for frequencies in between the values in the table.

Table shows an extract of values

7.3 ANTENNA R&S HL562 (30 MHz – 1 GHz)

($d_{Limit} = 3\text{ m}$)

Frequency	AF R&S HL562	Corr.
MHz	dB (1/m)	dB
30	18.6	0.6
50	6.0	0.9
100	9.7	1.2
150	7.9	1.6
200	7.6	1.9
250	9.5	2.1
300	11.0	2.3
350	12.4	2.6
400	13.6	2.9
450	14.7	3.1
500	15.6	3.2
550	16.3	3.5
600	17.2	3.5
650	18.1	3.6
700	18.5	3.6
750	19.1	4.1
800	19.6	4.1
850	20.1	4.4
900	20.8	4.7
950	21.1	4.8
1000	21.6	4.9

cable loss 1 (inside chamber)	cable loss 2 (outside chamber)	cable loss 3 (switch unit)	cable loss 4 (to receiver)	distance corr. (-20 dB/ decade)	d_{Limit} (meas. distance (limit))	d_{used} (meas. distance (used))
dB	dB	dB	dB	dB	m	m
0.29	0.04	0.23	0.02	0.0	3	3
0.39	0.09	0.32	0.08	0.0	3	3
0.56	0.14	0.47	0.08	0.0	3	3
0.73	0.20	0.59	0.12	0.0	3	3
0.84	0.21	0.70	0.11	0.0	3	3
0.98	0.24	0.80	0.13	0.0	3	3
1.04	0.26	0.89	0.15	0.0	3	3
1.18	0.31	0.96	0.13	0.0	3	3
1.28	0.35	1.03	0.19	0.0	3	3
1.39	0.38	1.11	0.22	0.0	3	3
1.44	0.39	1.20	0.19	0.0	3	3
1.55	0.46	1.24	0.23	0.0	3	3
1.59	0.43	1.29	0.23	0.0	3	3
1.67	0.34	1.35	0.22	0.0	3	3
1.67	0.42	1.41	0.15	0.0	3	3
1.87	0.54	1.46	0.25	0.0	3	3
1.90	0.46	1.51	0.25	0.0	3	3
1.99	0.60	1.56	0.27	0.0	3	3
2.14	0.60	1.63	0.29	0.0	3	3
2.22	0.60	1.66	0.33	0.0	3	3
2.23	0.61	1.71	0.30	0.0	3	3

($d_{Limit} = 10\text{ m}$)

30	18.6	-9.9
50	6.0	-9.6
100	9.7	-9.2
150	7.9	-8.8
200	7.6	-8.6
250	9.5	-8.3
300	11.0	-8.1
350	12.4	-7.9
400	13.6	-7.6
450	14.7	-7.4
500	15.6	-7.2
550	16.3	-7.0
600	17.2	-6.9
650	18.1	-6.9
700	18.5	-6.8
750	19.1	-6.3
800	19.6	-6.3
850	20.1	-6.0
900	20.8	-5.8
950	21.1	-5.6
1000	21.6	-5.6

0.29	0.04	0.23	0.02	-10.5	10	3
0.39	0.09	0.32	0.08	-10.5	10	3
0.56	0.14	0.47	0.08	-10.5	10	3
0.73	0.20	0.59	0.12	-10.5	10	3
0.84	0.21	0.70	0.11	-10.5	10	3
0.98	0.24	0.80	0.13	-10.5	10	3
1.04	0.26	0.89	0.15	-10.5	10	3
1.18	0.31	0.96	0.13	-10.5	10	3
1.28	0.35	1.03	0.19	-10.5	10	3
1.39	0.38	1.11	0.22	-10.5	10	3
1.44	0.39	1.20	0.19	-10.5	10	3
1.55	0.46	1.24	0.23	-10.5	10	3
1.59	0.43	1.29	0.23	-10.5	10	3
1.67	0.34	1.35	0.22	-10.5	10	3
1.67	0.42	1.41	0.15	-10.5	10	3
1.87	0.54	1.46	0.25	-10.5	10	3
1.90	0.46	1.51	0.25	-10.5	10	3
1.99	0.60	1.56	0.27	-10.5	10	3
2.14	0.60	1.63	0.29	-10.5	10	3
2.22	0.60	1.66	0.33	-10.5	10	3
2.23	0.61	1.71	0.30	-10.5	10	3

Sample calculation

$$E \text{ (dB } \mu\text{V/m)} = U \text{ (dB } \mu\text{V)} + \text{AF (dB 1/m)} + \text{Corr. (dB)}$$

U = Receiver reading

AF = Antenna factor

Corr. = sum of single correction factors of used cables, switch unit, distance correction, amplifier (if applicable)

distance correction = $-20 * \text{LOG} (d_{Limit} / d_{used})$

Linear interpolation will be used for frequencies in between the values in the table.

Tables show an extract of values.

7.4 ANTENNA R&S HF907 (1 GHZ – 18 GHZ)

Frequency	AF R&S HF907	Corr.
MHz	dB (1/m)	dB
1000	24.4	-19.4
2000	28.5	-17.4
3000	31.0	-16.1
4000	33.1	-14.7
5000	34.4	-13.7
6000	34.7	-12.7
7000	35.6	-11.0

cable loss 1 (relay + cable inside chamber)	cable loss 2 (outside chamber)	cable loss 3 (switch unit, attenuator & pre-amp)	cable loss 4 (to receiver)
dB	dB	dB	dB
0.99	0.31	-21.51	0.79
1.44	0.44	-20.63	1.38
1.87	0.53	-19.85	1.33
2.41	0.67	-19.13	1.31
2.78	0.86	-18.71	1.40
2.74	0.90	-17.83	1.47
2.82	0.86	-16.19	1.46

Frequency	AF R&S HF907	Corr.
MHz	dB (1/m)	dB
3000	31.0	-23.4
4000	33.1	-23.3
5000	34.4	-21.7
6000	34.7	-21.2
7000	35.6	-19.8

cable loss 1 (relay inside chamber)	cable loss 2 (inside chamber)	cable loss 3 (outside chamber)	cable loss 4 (switch unit, attenuator & pre-amp)	cable loss 5 (to receiver)	used for FCC 15.247
dB	dB	dB	dB	dB	
0.47	1.87	0.53	-27.58	1.33	
0.56	2.41	0.67	-28.23	1.31	
0.61	2.78	0.86	-27.35	1.40	
0.58	2.74	0.90	-26.89	1.47	
0.66	2.82	0.86	-25.58	1.46	

Frequency	AF R&S HF907	Corr.
MHz	dB (1/m)	dB
7000	35.6	-57.3
8000	36.3	-56.3
9000	37.1	-55.3
10000	37.5	-56.2
11000	37.5	-55.3
12000	37.6	-53.7
13000	38.2	-53.5
14000	39.9	-56.3
15000	40.9	-54.1
16000	41.3	-54.1
17000	42.8	-54.4
18000	44.2	-54.7

cable loss 1 (relay inside chamber)	cable loss 2 (High Pass)	cable loss 3 (pre-amp)	cable loss 4 (inside chamber)	cable loss 5 (outside chamber)	cable loss 6 (to receiver)
dB	dB	dB	dB	dB	dB
0.56	1.28	-62.72	2.66	0.94	1.46
0.69	0.71	-61.49	2.84	1.00	1.53
0.68	0.65	-60.80	3.06	1.09	1.60
0.70	0.54	-61.91	3.28	1.20	1.67
0.80	0.61	-61.40	3.43	1.27	1.70
0.84	0.42	-59.70	3.53	1.26	1.73
0.83	0.44	-59.81	3.75	1.32	1.83
0.91	0.53	-63.03	3.91	1.40	1.77
0.98	0.54	-61.05	4.02	1.44	1.83
1.23	0.49	-61.51	4.17	1.51	1.85
1.36	0.76	-62.36	4.34	1.53	2.00
1.70	0.53	-62.88	4.41	1.55	1.91

Sample calculation

$$E \text{ (dB } \mu\text{V/m)} = U \text{ (dB } \mu\text{V)} + \text{AF (dB 1/m)} + \text{Corr. (dB)}$$

U = Receiver reading

AF = Antenna factor

Corr. = sum of single correction factors of used cables, switch unit, distance correction, amplifier (if applicable)

Linear interpolation will be used for frequencies in between the values in the table.

Tables show an extract of values.

7.5 ANTENNA EMCO 3160-09 (18 GHZ – 26.5 GHZ)

Frequency MHz	AF EMCO 3160-09 dB (1/m)	Corr. dB
18000	40.2	-23.5
18500	40.2	-23.2
19000	40.2	-22.0
19500	40.3	-21.3
20000	40.3	-20.3
20500	40.3	-19.9
21000	40.3	-19.1
21500	40.3	-19.1
22000	40.3	-18.7
22500	40.4	-19.0
23000	40.4	-19.5
23500	40.4	-19.3
24000	40.4	-19.8
24500	40.4	-19.5
25000	40.4	-19.3
25500	40.5	-20.4
26000	40.5	-21.3
26500	40.5	-21.1

cable loss 1 (inside chamber) dB	cable loss 2 (pre- amp) dB	cable loss 3 (inside chamber) dB	cable loss 4 (switch unit) dB	cable loss 5 (to receiver) dB
0.72	-35.85	6.20	2.81	2.65
0.69	-35.71	6.46	2.76	2.59
0.76	-35.44	6.69	3.15	2.79
0.74	-35.07	7.04	3.11	2.91
0.72	-34.49	7.30	3.07	3.05
0.78	-34.46	7.48	3.12	3.15
0.87	-34.07	7.61	3.20	3.33
0.90	-33.96	7.47	3.28	3.19
0.89	-33.57	7.34	3.35	3.28
0.87	-33.66	7.06	3.75	2.94
0.88	-33.75	6.92	3.77	2.70
0.90	-33.35	6.99	3.52	2.66
0.88	-33.99	6.88	3.88	2.58
0.91	-33.89	7.01	3.93	2.51
0.88	-33.00	6.72	3.96	2.14
0.89	-34.07	6.90	3.66	2.22
0.86	-35.11	7.02	3.69	2.28
0.90	-35.20	7.15	3.91	2.36

Sample calculation

$$E \text{ (dB } \mu\text{V/m)} = U \text{ (dB } \mu\text{V)} + AF \text{ (dB 1/m)} + Corr. \text{ (dB)}$$

U = Receiver reading

AF = Antenna factor

Corr. = sum of single correction factors of used cables, switch unit, distance correction, amplifier (if applicable)

Linear interpolation will be used for frequencies in between the values in the table.

Table shows an extract of values.

7.6 ANTENNA EMCO 3160-10 (26.5 GHZ – 40 GHZ)

Frequency GHz	AF EMCO 3160-10 dB (1/m)	Corr. dB	cable loss 1 (inside chamber) dB	cable loss 2 (outside chamber) dB	cable loss 3 (switch unit) dB	cable loss 4 (to receiver) dB	distance corr. (-20 dB/ decade) dB	d _{Limit} (meas. distance (limit)) m	d _{used} (meas. distance (used)) m
26.5	43.4	-11.2	4.4				-9.5	3	1.0
27.0	43.4	-11.2	4.4				-9.5	3	1.0
28.0	43.4	-11.1	4.5				-9.5	3	1.0
29.0	43.5	-11.0	4.6				-9.5	3	1.0
30.0	43.5	-10.9	4.7				-9.5	3	1.0
31.0	43.5	-10.8	4.7				-9.5	3	1.0
32.0	43.5	-10.7	4.8				-9.5	3	1.0
33.0	43.6	-10.7	4.9				-9.5	3	1.0
34.0	43.6	-10.6	5.0				-9.5	3	1.0
35.0	43.6	-10.5	5.1				-9.5	3	1.0
36.0	43.6	-10.4	5.1				-9.5	3	1.0
37.0	43.7	-10.3	5.2				-9.5	3	1.0
38.0	43.7	-10.2	5.3				-9.5	3	1.0
39.0	43.7	-10.2	5.4				-9.5	3	1.0
40.0	43.8	-10.1	5.5				-9.5	3	1.0

Sample calculation

$$E \text{ (dB } \mu\text{V/m)} = U \text{ (dB } \mu\text{V)} + \text{AF (dB 1/m)} + \text{Corr. (dB)}$$

U = Receiver reading

AF = Antenna factor

Corr. = sum of single correction factors of used cables, switch unit, distance correction, amplifier (if applicable)

Linear interpolation will be used for frequencies in between the values in the table.

distance correction = $-20 * \text{LOG} (d_{\text{Limit}} / d_{\text{used}})$

Linear interpolation will be used for frequencies in between the values in the table.

Table shows an extract of values.

8 MEASUREMENT UNCERTAINTIES

Test Case	Parameter	Uncertainty
AC Power Line	Power	± 3.4 dB
Field Strength of spurious radiation	Power	± 5.5 dB
6 dB / 26 dB / 99% Bandwidth	Power Frequency	± 2.9 dB ± 11.2 kHz
Conducted Output Power	Power	± 2.2 dB
Band Edge Compliance	Power Frequency	± 2.2 dB ± 11.2 kHz
Frequency Stability	Frequency	± 25 Hz
Power Spectral Density	Power	± 2.2 dB

The measurement uncertainties for all parameters are calculated with an expansion factor (coverage factor) $k = 1.96$. This means, that the true value is in the corresponding interval with a probability of 95 %.

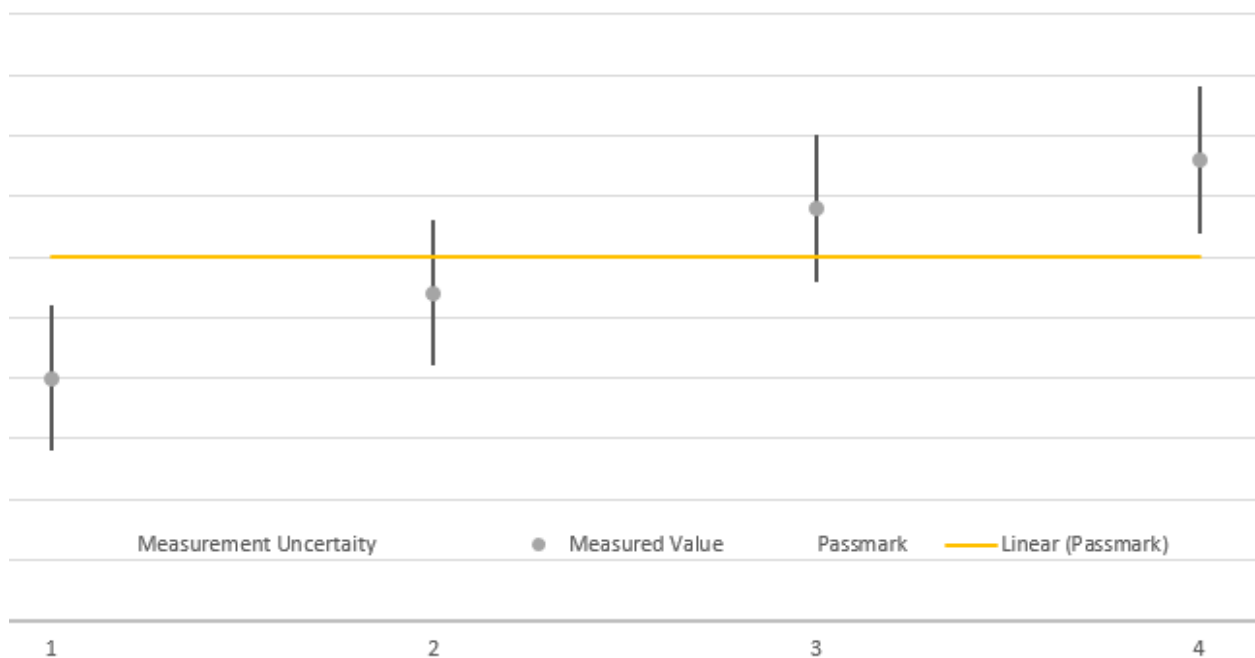

The verdicts in this test report are given according the above diagram:

Case	Measured Value	Uncertainty Range	Verdict
1	below pass mark	below pass mark	Passed
2	below pass mark	within pass mark	Passed
3	above pass mark	within pass mark	Failed
4	above pass mark	above pass mark	Failed

That means, the laboratory applies, as decision rule (see ISO/IEC 17025:2017), the so called shared risk principle.

9 PHOTO REPORT

Please see separate photo report.