

**ELECTROMAGNETIC EMISSIONS  
COMPLIANCE REPORT**

**Applicant:** Murata Manufacturing Co., Ltd.  
1-10-1 Higashikotari, Nagaokakyo-shi, Kyoto 617-8555 Japan

**Manufacturer:** Murata Manufacturing Co., Ltd.  
1-10-1 Higashikotari, Nagaokakyo-shi, Kyoto 617-8555 Japan

**Product Name:** Communication Module

**Brand Name:** muRata

**Model No.:** LBEE5WV2GF

**Report Number:** TERF2404000927E2

**FCC ID** VPYLBEE5WV2GF

**IC:** 772C-LBEE5WV2GF

**Date of EUT Received:** Feb. 21, 2024

**Date of Test:** Apr. 10, 2024~May 13, 2024

**Issue Date:** Jun. 04, 2024

Approved By \_\_\_\_\_

**Aken Huang**

**We hereby certify that:**

The above equipment was tested by SGS Taiwan Ltd. Central RF Lab The test data, data evaluation, test procedures, and equipment configurations shown in this report were made in accordance with the procedures given in ANSI C63.10:2013 and the energy emitted by the sample EUT comply with FCC rule part §15.407, ISED RSS-247.

The results of this report relate only to the sample identified in this report.

Unless otherwise stated the results shown in this test report refer only to the sample(s) tested and such sample(s) are retained for 90 days only.

除非另有說明，此報告結果僅對測試之樣品負責，同時此樣品僅保留90天。本報告未經本公司書面許可，不可部份複製。

This document is issued by the Company subject to its General Conditions of Service printed overleaf, available on request or accessible at <http://www.sgs.com.tw/Terms-and-Conditions> and for electronic format documents, subject to Terms and Conditions for Electronic Documents at <http://www.sgs.com.tw/Terms-and-Conditions>. Attention is drawn to the limitation of liability, indemnification and jurisdiction issues defined therein. Any holder of this document is advised that information contained hereon reflects the Company's findings at the time of its intervention only and within the limits of Client's instructions, if any. The Company's sole responsibility is to its Client and this document does not exonerate parties to a transaction from exercising all their rights and obligations under the transaction documents. This document cannot be reproduced except in full, without prior written approval of the Company. Any unauthorized alteration, forgery or falsification of the content or appearance of this document is unlawful and offenders may be prosecuted to the fullest extent of the law.

Revision History					
Report Number	Revision	Description	Issue Date	Revised By	Remark
TERF2404000927E2	00	Original.	Jun. 04, 2024	Yami Kuo	

**Note:**

- 1、The remark "\*" indicates modification of the report upon requests from certification body.

Unless otherwise stated the results shown in this test report refer only to the sample(s) tested and such sample(s) are retained for 90 days only.

除非另有說明，此報告結果僅對測試之樣品負責，同時此樣品僅保留90天。本報告未經本公司書面許可，不可部份複製。

This document is issued by the Company subject to its General Conditions of Service printed overleaf, available on request or accessible at <http://www.sgs.com.tw/Terms-and-Conditions> and for electronic format documents, subject to Terms and Conditions for Electronic Documents at <http://www.sgs.com.tw/Terms-and-Conditions>. Attention is drawn to the limitation of liability, indemnification and jurisdiction issues defined therein. Any holder of this document is advised that information contained hereon reflects the Company's findings at the time of its intervention only and within the limits of Client's instructions, if any. The Company's sole responsibility is to its Client and this document does not exonerate parties to a transaction from exercising all their rights and obligations under the transaction documents. This document cannot be reproduced except in full, without prior written approval of the Company. Any unauthorized alteration, forgery or falsification of the content or appearance of this document is unlawful and offenders may be prosecuted to the fullest extent of the law.

SGS Taiwan Ltd.

No.134,Wu Kung Road, New Taipei Industrial Park, Wuku District, New Taipei City, Taiwan/新北市五股區新北產業園區五工路 134 號

台灣檢驗科技股份有限公司

t (886-2) 2299-3279

f (886-2) 2298-0488

[www.sgs.com.tw](http://www.sgs.com.tw)

Member of SGS Group

## Contents

<b>1</b>	<b>GENERAL INFORMATION .....</b>	<b>4</b>
<b>2</b>	<b>SYSTEM TEST CONFIGURATION.....</b>	<b>7</b>
<b>3</b>	<b>SUMMARY OF TEST RESULT .....</b>	<b>10</b>
<b>4</b>	<b>DESCRIPTION OF TEST MODES.....</b>	<b>11</b>
<b>5</b>	<b>MEASUREMENT UNCERTAINTY .....</b>	<b>14</b>
<b>6</b>	<b>MEASUREMENT EQUIPMENT USED .....</b>	<b>15</b>
<b>7</b>	<b>CONDUCTED EMISSION TEST .....</b>	<b>17</b>
<b>8</b>	<b>EMISSION BANDWIDTH MEASUREMENT .....</b>	<b>21</b>
<b>9</b>	<b>MAXIMUM CONDUCTED OUTPUT POWER MEASUREMENT .....</b>	<b>36</b>
<b>10</b>	<b>MAXIMUM POWER SPECTRAL DENSITY .....</b>	<b>46</b>
<b>11</b>	<b>UNDESIRABLE RADIATED EMISSION MEASUREMENT .....</b>	<b>56</b>
<b>12</b>	<b>TRANSMISSION IN THE ABSENCE OF DATA.....</b>	<b>232</b>
<b>13</b>	<b>ANTENNA REQUIREMENT.....</b>	<b>233</b>

Unless otherwise stated the results shown in this test report refer only to the sample(s) tested and such sample(s) are retained for 90 days only.

除非另有說明，此報告結果僅對測試之樣品負責，同時此樣品僅保留90天。本報告未經本公司書面許可，不可部份複製。

This document is issued by the Company subject to its General Conditions of Service printed overleaf, available on request or accessible at <http://www.sgs.com.tw/Terms-and-Conditions> and for electronic format documents, subject to Terms and Conditions for Electronic Documents at <http://www.sgs.com.tw/Terms-and-Conditions>. Attention is drawn to the limitation of liability, indemnification and jurisdiction issues defined therein. Any holder of this document is advised that information contained hereon reflects the Company's findings at the time of its intervention only and within the limits of Client's instructions, if any. The Company's sole responsibility is to its Client and this document does not exonerate parties to a transaction from exercising all their rights and obligations under the transaction documents. This document cannot be reproduced except in full, without prior written approval of the Company. Any unauthorized alteration, forgery or falsification of the content or appearance of this document is unlawful and offenders may be prosecuted to the fullest extent of the law.

SGS Taiwan Ltd.

No.134,Wu Kung Road, New Taipei Industrial Park, Wuku District, New Taipei City, Taiwan/新北市五股區新北產業園區五工路 134 號

台灣檢驗科技股份有限公司

t (886-2) 2299-3279

f (886-2) 2298-0488

[www.sgs.com.tw](http://www.sgs.com.tw)

Member of SGS Group

## 1 GENERAL INFORMATION

### 1.1 Product Description

Product Name:	Communication Module
Brand Name:	muRata
Model No.:	LBEE5WV2GF
Hardware Version:	N/A
Firmware Version:	1.1.1.1
EUT Series No.:	NO.2
Power Supply:	3.3Vdc, 1.8Vdc
Test Software (Name/Version)	Broadcom Blue Tool V2.0.2.9

### 1.2 Modulation & Data Rate

Modulation type:	64QAM, 16QAM, QPSK, BPSK for OFDM in 802.11a,11n
	256QAM, 64QAM, 16QAM, QPSK, BPSK for OFDM in 802.11ac
Transition Rate:	802.11 a: 6 - 54 Mbps
	802.11 n_HT20: up to 72.2 Mbps
	802.11 ac_VHT20: up to 86.7 Mbps

### 1.3 Antenna Designation

Antenna Type	Supplier	Antenna Part No.	Freq. (MHz)	Peak Antenna Gain (dBi)
dipole	Unictron	WT32D1-KX	5150-5850	0.8
	Taoglas	FXP830.07.0100C		1.5
	KAVX	W3P35x8W04		1.8
	Inventek	W2.4-5P-U		<b>1.98</b>
monopole	Murata	Type2GF_Antenna		1.2
	Murata	Type1LV_Antenna		<b>2</b>

**Note:**

1. Pre-scanned was done on the above antennas, measurements were demonstrated by using the antenna with the highest gain as the worst case scenarios.
2. Antenna information is provided by the applicant.

Unless otherwise stated the results shown in this test report refer only to the sample(s) tested and such sample(s) are retained for 90 days only.

除非另有說明，此報告結果僅對測試之樣品負責，同時此樣品僅保留90天。本報告未經本公司書面許可，不可部份複製。

This document is issued by the Company subject to its General Conditions of Service printed overleaf, available on request or accessible at <http://www.sgs.com.tw/Terms-and-Conditions>, and for electronic format documents, subject to Terms and Conditions for Electronic Documents at <http://www.sgs.com.tw/Terms-and-Conditions>. Attention is drawn to the limitation of liability, indemnification and jurisdiction issues defined therein. Any holder of this document is advised that information contained hereon reflects the Company's findings at the time of its intervention only and within the limits of Client's instructions, if any. The Company's sole responsibility is to its Client and this document does not exonerate parties to a transaction from exercising all their rights and obligations under the transaction documents. This document cannot be reproduced except in full, without prior written approval of the Company. Any unauthorized alteration, forgery or falsification of the content or appearance of this document is unlawful and offenders may be prosecuted to the fullest extent of the law.

1.4 FCC

Wi-Fi	Frequency Range	Channels	Rated Power(Avg) (dBm) (Worst Case)	Modulation Technology
802.11a/ 802.11n_HT20/ 802.11ac_VHT20	5180~5240	4	17.78 dBm	OFDM
	5260~5320	4	17.87 dBm	OFDM
	5500~5720	12	17.92 dBm	OFDM
	5745-5825	5	17.85 dBm	OFDM

1.5 ISED

Wi-Fi	Frequency Range	Channels	EIRP/Avg	Rated Power(EIRP/Avg) (dBm) (Worst Case)	Modulation Technology
802.11a/ 802.11n_HT20/ 802.11ac_VHT20	5180~5240	4	EIRP	19.78 dBm	OFDM
	5260~5320	4	Avg	17.87 dBm	OFDM
	5500~5700	8	Avg	17.92 dBm	OFDM
	5720 (U-NII 2C)	1	Avg	16.42 dBm	OFDM
	5720 (U-NII 3)	1	Avg	12.70 dBm	OFDM
	5745-5825	5	Avg	17.85 dBm	OFDM

Unless otherwise stated the results shown in this test report refer only to the sample(s) tested and such sample(s) are retained for 90 days only.

除非另有說明，此報告結果僅對測試之樣品負責，同時此樣品僅保留90天。本報告未經本公司書面許可，不可部份複製。

This document is issued by the Company subject to its General Conditions of Service printed overleaf, available on request or accessible at <http://www.sgs.com.tw/Terms-and-Conditions>, and for electronic format documents, subject to Terms and Conditions for Electronic Documents at <http://www.sgs.com.tw/Terms-and-Conditions>. Attention is drawn to the limitation of liability, indemnification and jurisdiction issues defined therein. Any holder of this document is advised that information contained hereon reflects the Company's findings at the time of its intervention only and within the limits of Client's instructions, if any. The Company's sole responsibility is to its Client and this document does not exonerate parties to a transaction from exercising all their rights and obligations under the transaction documents. This document cannot be reproduced except in full, without prior written approval of the Company. Any unauthorized alteration, forgery or falsification of the content or appearance of this document is unlawful and offenders may be prosecuted to the fullest extent of the law.

**1.6 Test Methodology of Applied Standards**

FCC Part 15, Subpart E §15.407  
 FCC KDB 789033 D02 General UNII Test Procedures New Rules v02r01  
 RSS-247 issue 3 Aug. 2023  
 RSS-Gen, Issue 5 April 2018, Amendment 2 (February 2021)  
 ANSI C63.10:2013

**1.7 Test Facility**

Laboratory	Test Site Address	Test Site Name	FCC Designation number	IC CAB identifier
SGS Taiwan Ltd. Central RF Lab. (TAF code 3702)	No.134, Wu Kung Road, New Taipei Industrial Park, Wuku District, New Taipei City, Taiwan.	SAC 1	TW0027	TW3702
		SAC 2		
		SAC 3		
		Conduction 1		
		Conducted 1		
		Conducted 2		
		Conducted 3		
		Conducted 4		
		Conducted 5		
	Conducted 6			
	No.2, Keji 1st Rd., Guishan District, Taoyuan City, Taiwan 333	Conduction C	TW0028	
		SAC C		
		SAC D		
		SAC G		
		Conducted A		
		Conducted B		
		Conducted C		
		Conducted D		
		Conducted E		
Conducted F				
Conducted G				

**Note:** Test site name is remarked on the equipment list in each section of this report as an indication where measurements occurred in specific test site and address.

**1.8 Special Accessories**

There are no special accessories used while test was conducted.

**1.9 Equipment Modifications**

There was no modification incorporated into the EUT.

Unless otherwise stated the results shown in this test report refer only to the sample(s) tested and such sample(s) are retained for 90 days only.

除非另有說明，此報告結果僅對測試之樣品負責，同時此樣品僅保留90天。本報告未經本公司書面許可，不可部份複製。

This document is issued by the Company subject to its General Conditions of Service printed overleaf, available on request or accessible at <http://www.sgs.com.tw/Terms-and-Conditions>, and for electronic format documents, subject to Terms and Conditions for Electronic Documents at <http://www.sgs.com.tw/Terms-and-Conditions>. Attention is drawn to the limitation of liability, indemnification and jurisdiction issues defined therein. Any holder of this document is advised that information contained hereon reflects the Company's findings at the time of its intervention only and within the limits of Client's instructions, if any. The Company's sole responsibility is to its Client and this document does not exonerate parties to a transaction from exercising all their rights and obligations under the transaction documents. This document cannot be reproduced except in full, without prior written approval of the Company. Any unauthorized alteration, forgery or falsification of the content or appearance of this document is unlawful and offenders may be prosecuted to the fullest extent of the law.

## 2 SYSTEM TEST CONFIGURATION

### 2.1 EUT Configuration

The EUT configuration for testing is installed on RF field strength measurement to meet the Commissions requirement and operating in a manner which intends to maximize its emission characteristics in a continuous normal application.

### 2.2 EUT Exercise

An engineering test mode (software/firmware) that applicant provided was utilized to manipulate the EUT into transmit, selection of the test channel, and modulation scheme.

### 2.3 Test Procedure

#### 2.3.1 Conducted Emissions

The EUT is placed on a table which is 0.8 m above ground plane. Conducted emissions from the EUT measured in the frequency range between 0.15 MHz and 30MHz. The CISPR Quasi-Peak and Average detector mode is employed. The two LISNs provide 50uH/50 ohm of coupling impedance for the measuring instrument. Both lines of the power mains connected to the EUT were checked for maximum conducted interference.

#### 2.3.2 Conducted Test (RF)

The active antenna port of the unlicensed wireless device is connected to the spectrum analyzer with attenuator to protect the instrumentation. If a second antenna port is available, it is tested at one operating frequency, with other port(s) appropriately terminated, to verify it has similar output characteristics as the fully tested port.

#### 2.3.3 Radiated Emissions

The EUT is placed on a turn table. For emissions testing at or below 1 GHz, the table height shall be 0.8 m above the reference ground plane. For emission measurements above 1 GHz, the table height shall be 1.5 m. The turn table shall rotate 360 degrees to determine the position of maximum emission level. EUT is set 3m away from the receiving antenna which varied from 1m to 4m to find out the highest emission. And also, each emission was to be maximized by changing the polarization of receiving antenna both horizontal and vertical. In order to find out the max. emission, the relative positions of this transmitter (EUT) was rotated through three orthogonal axes and measurement procedures for electric field radiated emissions above 1 GHz the EUT measurement is to be made "while keeping the antenna in the 'cone of radiation' from that area and pointed at the area both in azimuth and elevation, with polarization oriented for maximum response." is still within the 3dB illumination BW of the measurement antenna.

Unless otherwise stated the results shown in this test report refer only to the sample(s) tested and such sample(s) are retained for 90 days only.

除非另有說明，此報告結果僅對測試之樣品負責，同時此樣品僅保留90天。本報告未經本公司書面許可，不可部份複製。

This document is issued by the Company subject to its General Conditions of Service printed overleaf, available on request or accessible at <http://www.sgs.com.tw/Terms-and-Conditions>, and for electronic format documents, subject to Terms and Conditions for Electronic Documents at <http://www.sgs.com.tw/Terms-and-Conditions>. Attention is drawn to the limitation of liability, indemnification and jurisdiction issues defined therein. Any holder of this document is advised that information contained hereon reflects the Company's findings at the time of its intervention only and within the limits of Client's instructions, if any. The Company's sole responsibility is to its Client and this document does not exonerate parties to a transaction from exercising all their rights and obligations under the transaction documents. This document cannot be reproduced except in full, without prior written approval of the Company. Any unauthorized alteration, forgery or falsification of the content or appearance of this document is unlawful and offenders may be prosecuted to the fullest extent of the law.

## 2.4 Measurement Results Explanation Example

### 2.4.1 Radiated Emission Test Sites For Measurements From 9 kHz To 30 MHz

Radiated emission below 30MHz is measured in a 9m\*6m\*6m semi-anechoic chamber, the measurements correspond to those obtained at an open-field test site.

There is a comparison data of both open-field test site and semi-Anechoic chamber, and the result came out very similar.

### 2.4.2 For all conducted test items:

The offset level is set in the spectrum analyzer to compensate the RF cable loss and attenuation factor between EUT conducted port and spectrum analyzer. With the offset compensation, the spectrum analyzer reading level is exactly EUT RF output level.

Unless otherwise stated the results shown in this test report refer only to the sample(s) tested and such sample(s) are retained for 90 days only.

除非另有說明，此報告結果僅對測試之樣品負責，同時此樣品僅保留90天。本報告未經本公司書面許可，不可部份複製。

This document is issued by the Company subject to its General Conditions of Service printed overleaf, available on request or accessible at <http://www.sgs.com.tw/Terms-and-Conditions> and for electronic format documents, subject to Terms and Conditions for Electronic Documents at <http://www.sgs.com.tw/Terms-and-Conditions>. Attention is drawn to the limitation of liability, indemnification and jurisdiction issues defined therein. Any holder of this document is advised that information contained hereon reflects the Company's findings at the time of its intervention only and within the limits of Client's instructions, if any. The Company's sole responsibility is to its Client and this document does not exonerate parties to a transaction from exercising all their rights and obligations under the transaction documents. This document cannot be reproduced except in full, without prior written approval of the Company. Any unauthorized alteration, forgery or falsification of the content or appearance of this document is unlawful and offenders may be prosecuted to the fullest extent of the law.



## 2.5 Test Configuration

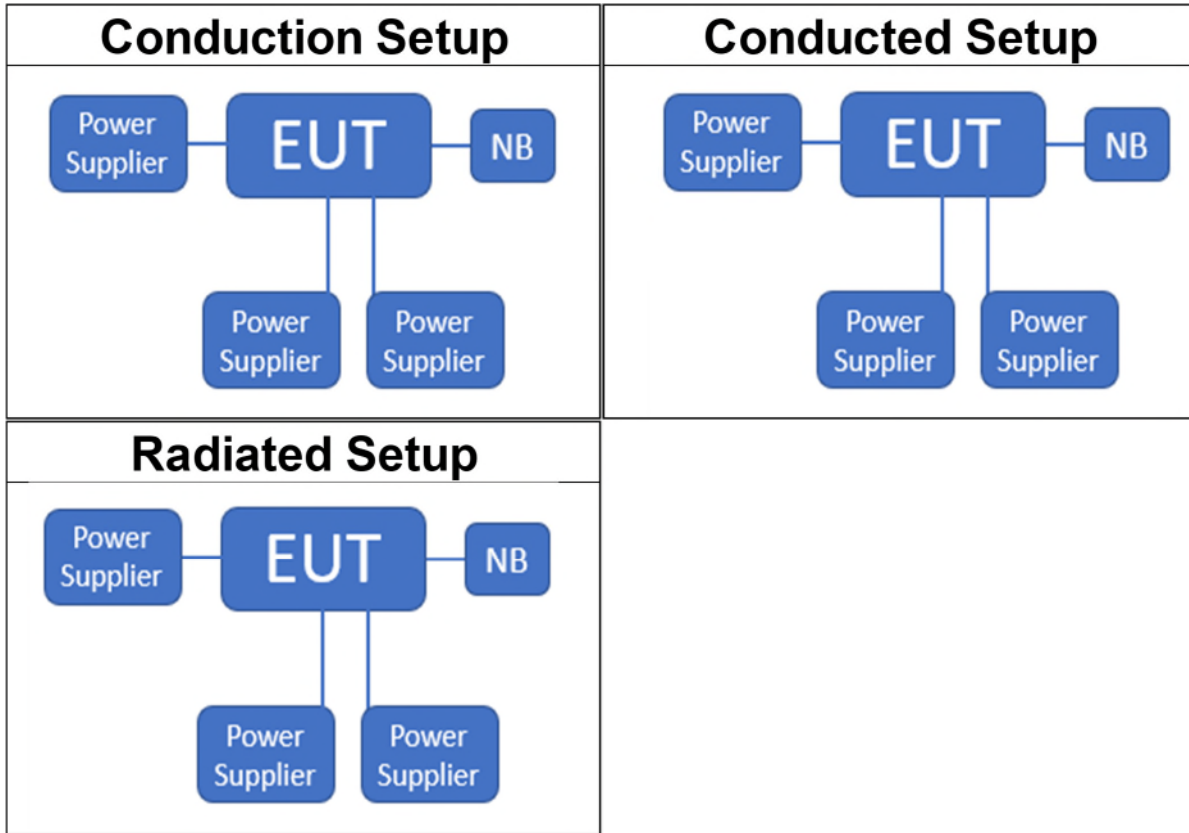

## 2.6 Control Unit(s)

AC Power-Line Conducted Emission Test Site: Conduction C					
EQUIPMENT TYPE	MFR	MODEL NUMBER	SERIAL NUMBER	LAST CAL.	CAL DUE.
Notebook	Lenovo	L480	P0002332	N/A	N/A

Conducted Emission Test Site: Conducted C					
EQUIPMENT TYPE	MFR	MODEL NUMBER	SERIAL NUMBER	LAST CAL.	CAL DUE.
Notebook	Lenovo	T14	P0003332	N/A	N/A

Radiated Emission Test Site: SAC G					
EQUIPMENT TYPE	MFR	MODEL NUMBER	SERIAL NUMBER	LAST CAL.	CAL DUE.
Notebook	Lenovo	L480	P0002332	N/A	N/A

Unless otherwise stated the results shown in this test report refer only to the sample(s) tested and such sample(s) are retained for 90 days only.

除非另有說明，此報告結果僅對測試之樣品負責，同時此樣品僅保留90天。本報告未經本公司書面許可，不可部份複製。

This document is issued by the Company subject to its General Conditions of Service printed overleaf, available on request or accessible at <http://www.sgs.com.tw/Terms-and-Conditions>, and for electronic format documents, subject to Terms and Conditions for Electronic Documents at <http://www.sgs.com.tw/Terms-and-Conditions>. Attention is drawn to the limitation of liability, indemnification and jurisdiction issues defined therein. Any holder of this document is advised that information contained hereon reflects the Company's findings at the time of its intervention only and within the limits of Client's instructions, if any. The Company's sole responsibility is to its Client and this document does not exonerate parties to a transaction from exercising all their rights and obligations under the transaction documents. This document cannot be reproduced except in full, without prior written approval of the Company. Any unauthorized alteration, forgery or falsification of the content or appearance of this document is unlawful and offenders may be prosecuted to the fullest extent of the law.

### 3 SUMMARY OF TEST RESULT

FCC Rules	ISED Rules	Description Of Test	Result
§15.207	RSS-Gen §8.8	AC Power Line Conducted Emission	Compliant
§15.407(e)	RSS-Gen §6.7	Emission Bandwidth	Compliant
§15.407(a)	RSS-247 §6.2.1~4 (1) RSS-247 §6.2.5 (2)	Maximum Conducted Output Power	Compliant
§15.407(a)	RSS-247 §6.2.1~ 4 (1) RSS-247 §6.2.5 (2)	Power Spectral Density	Compliant
§15.205 §15.209 §15.407(b)	RSS-247 §6.2.1~3 (2) §6.2.4 (3) RSS-247 §6.2.5 (3)	Undesirable Radiated Emissions	Compliant
§15.407(c)	RSS-247 §6.4	Transmission in case of Absence of Information	Compliant
§15.203	N/A	Antenna Requirement	Compliant

Unless otherwise stated the results shown in this test report refer only to the sample(s) tested and such sample(s) are retained for 90 days only.

除非另有說明，此報告結果僅對測試之樣品負責，同時此樣品僅保留90天。本報告未經本公司書面許可，不可部份複製。

This document is issued by the Company subject to its General Conditions of Service printed overleaf, available on request or accessible at <http://www.sgs.com.tw/Terms-and-Conditions> and for electronic format documents, subject to Terms and Conditions for Electronic Documents at <http://www.sgs.com.tw/Terms-and-Conditions>. Attention is drawn to the limitation of liability, indemnification and jurisdiction issues defined therein. Any holder of this document is advised that information contained hereon reflects the Company's findings at the time of its intervention only and within the limits of Client's instructions, if any. The Company's sole responsibility is to its Client and this document does not exonerate parties to a transaction from exercising all their rights and obligations under the transaction documents. This document cannot be reproduced except in full, without prior written approval of the Company. Any unauthorized alteration, forgery or falsification of the content or appearance of this document is unlawful and offenders may be prosecuted to the fullest extent of the law.

## 4 DESCRIPTION OF TEST MODES

### 4.1 Operating Frequencies

UNII-1 5150 MHz ~ 5250MHz		UNII-2A 5250 MHz ~ 5350MHz	
20MHz		20MHz	
CH	Freq. (MHz)	CH	Freq. (MHz)
36	5180	52	5260
40	5200	56	5280
44	5220	60	5300
48	5240	64	5320

UNII-2C 5470 MHz ~ 5725MHz		UNII-3 5725 MHz ~ 5850MHz	
20MHz		20MHz	
CH	Freq. (MHz)	CH	Freq. (MHz)
100	5500	149	5745
104	5520	153	5765
108	5540	157	5785
112	5560	161	5805
116	5580	165	5825
120	5600		
124	5620		
128	5640		
132	5660		
136	5680		
140	5700		
144	5720		

Unless otherwise stated the results shown in this test report refer only to the sample(s) tested and such sample(s) are retained for 90 days only.

除非另有說明，此報告結果僅對測試之樣品負責，同時此樣品僅保留90天。本報告未經本公司書面許可，不可部份複製。

This document is issued by the Company subject to its General Conditions of Service printed overleaf, available on request or accessible at <http://www.sgs.com.tw/Terms-and-Conditions> and for electronic format documents, subject to Terms and Conditions for Electronic Documents at <http://www.sgs.com.tw/Terms-and-Conditions>. Attention is drawn to the limitation of liability, indemnification and jurisdiction issues defined therein. Any holder of this document is advised that information contained hereon reflects the Company's findings at the time of its intervention only and within the limits of Client's instructions, if any. The Company's sole responsibility is to its Client and this document does not exonerate parties to a transaction from exercising all their rights and obligations under the transaction documents. This document cannot be reproduced except in full, without prior written approval of the Company. Any unauthorized alteration, forgery or falsification of the content or appearance of this document is unlawful and offenders may be prosecuted to the fullest extent of the law.

#### 4.2 The Worst Test Modes and Channel Details

1. The EUT has been tested under operating condition.
2. Test program used to control the EUT for staying in continuous transmitting mode is programmed.
3. Investigation has been done on all the possible configurations for searching the worst case. The given UE is pre-scanned among below modes.

Modulation	Transmission Chain				Single Transmission Spatial	Multiple Transmission Spatial
<input checked="" type="checkbox"/> 802.11 a	<input checked="" type="checkbox"/> Ch0	<input type="checkbox"/> Ch1	<input type="checkbox"/> Ch2	<input type="checkbox"/> Ch3	<input checked="" type="checkbox"/> 1TX	<input type="checkbox"/> 2TX
<input checked="" type="checkbox"/> 802.11 n	<input checked="" type="checkbox"/> Ch0	<input type="checkbox"/> Ch1	<input type="checkbox"/> Ch2	<input type="checkbox"/> Ch3	<input checked="" type="checkbox"/> 1TX	<input type="checkbox"/> 2TX
<input checked="" type="checkbox"/> 802.11 ac	<input checked="" type="checkbox"/> Ch0	<input type="checkbox"/> Ch1	<input type="checkbox"/> Ch2	<input type="checkbox"/> Ch3	<input checked="" type="checkbox"/> 1TX	<input type="checkbox"/> 2TX
<input type="checkbox"/> 802.11 ax	<input type="checkbox"/> Ch0	<input type="checkbox"/> Ch1	<input type="checkbox"/> Ch2	<input type="checkbox"/> Ch3	<input type="checkbox"/> 1TX	<input type="checkbox"/> 2TX

4. Therefore, below summary is the modes of test configuration that yield the highest reading and generate the highest emission chosen to carry out the relevantly mandatory test items.

Unless otherwise stated the results shown in this test report refer only to the sample(s) tested and such sample(s) are retained for 90 days only.

除非另有說明，此報告結果僅對測試之樣品負責，同時此樣品僅保留90天。本報告未經本公司書面許可，不可部份複製。

This document is issued by the Company subject to its General Conditions of Service printed overleaf, available on request or accessible at <http://www.sgs.com.tw/Terms-and-Conditions> and for electronic format documents, subject to Terms and Conditions for Electronic Documents at <http://www.sgs.com.tw/Terms-and-Conditions>. Attention is drawn to the limitation of liability, indemnification and jurisdiction issues defined therein. Any holder of this document is advised that information contained hereon reflects the Company's findings at the time of its intervention only and within the limits of Client's instructions, if any. The Company's sole responsibility is to its Client and this document does not exonerate parties to a transaction from exercising all their rights and obligations under the transaction documents. This document cannot be reproduced except in full, without prior written approval of the Company. Any unauthorized alteration, forgery or falsification of the content or appearance of this document is unlawful and offenders may be prosecuted to the fullest extent of the law.

CONDUCTED TEST						
MODE	FREQUENCY BAND (MHz)	AVAILABLE CHANNEL	TESTED CHANNEL	MODULATION	DATA RATE (Mbps)	ANTENNA PORT
802.11a	5180~5240	36 to 48	36,44,48	OFDM	6	ch0
	5260~5320	52 to 64	52,60,64			
	5500~5720	100 to 144	100,116,140,144			
	5745~5825	149 to 165	149,157,165			
802.11n_HT20	5180~5240	36 to 48	36,44,48	OFDM	MCS0	ch0
	5260~5320	52 to 64	52,60,64			
	5500~5720	100 to 144	100,116,140,144			
	5745~5825	149 to 165	149,157,165			
TRANSMIT RADIATED EMISSION TEST (BELOW 1 GHz)						
MODE	FREQUENCY BAND (MHz)	AVAILABLE CHANNEL	TESTED CHANNEL	MODULATION	DATA RATE (Mbps)	ANTENNA PORT
802.11a	5180~5240	36 to 48	44	OFDM	6	ch0
	5260~5320	52 to 64	60			
	5500~5720	100 to 144	116			
	5745~5825	149 to 165	157			
TRANSMIT RADIATED EMISSION TEST (ABOVE 1 GHz)						
MODE	FREQUENCY BAND (MHz)	AVAILABLE CHANNEL	TESTED CHANNEL	MODULATION	DATA RATE (Mbps)	ANTENNA PORT
802.11a	5180~5240	36 to 48	36,44,48	OFDM	6	ch0
	5260~5320	52 to 64	52,60,64			
	5500~5720	100 to 144	100,116,140,144			
	5745~5825	149 to 165	149,157,165			
802.11n_HT20	5180~5240	36 to 48	36,44,48	OFDM	MCS0	ch0
	5260~5320	52 to 64	52,60,64			
	5500~5720	100 to 144	100,116,140,144			
	5745~5825	149 to 165	149,157,165			

**Note:**

The field strength of radiated emission was measured as the EUT positioned in different orthogonal planes (E1/E2/H) based on actual usage of the EUT to pre-scan the emissions for determining the worst case scenario.

Unless otherwise stated the results shown in this test report refer only to the sample(s) tested and such sample(s) are retained for 90 days only.

除非另有說明，此報告結果僅對測試之樣品負責，同時此樣品僅保留90天。本報告未經本公司書面許可，不可部份複製。

This document is issued by the Company subject to its General Conditions of Service printed overleaf, available on request or accessible at <http://www.sgs.com.tw/Terms-and-Conditions>, and for electronic format documents, subject to Terms and Conditions for Electronic Documents at <http://www.sgs.com.tw/Terms-and-Conditions>. Attention is drawn to the limitation of liability, indemnification and jurisdiction issues defined therein. Any holder of this document is advised that information contained hereon reflects the Company's findings at the time of its intervention only and within the limits of Client's instructions, if any. The Company's sole responsibility is to its Client and this document does not exonerate parties to a transaction from exercising all their rights and obligations under the transaction documents. This document cannot be reproduced except in full, without prior written approval of the Company. Any unauthorized alteration, forgery or falsification of the content or appearance of this document is unlawful and offenders may be prosecuted to the fullest extent of the law.

## 5 MEASUREMENT UNCERTAINTY

Test Items	Uncertainty
AC Power Line Conducted Emission	+/- 1.54 dB
Output Power measurement	+/- 0.97 dB
Emission Bandwidth	+/- 1.38 Hz
Conducted emission measurement	+/- 0.77 dB
Peak Power Density	+/- 0.61 dB
Temperature	+/- 0.6 °C
Humidity	+/- 3 %
DC / AC Power Source	+/- 1 %

Radiated Spurious Emission Measurement Uncertainty			
Polarization: Vertical	+/-	1.89 dB	9kHz~30MHz
	+/-	4.15 dB	30MHz - 1000MHz
	+/-	3.43 dB	1GHz - 18GHz
	+/-	3.86 dB	18GHz - 40GHz
Polarization: Horizontal	+/-	1.89 dB	9kHz~30MHz
	+/-	4.02 dB	30MHz - 1000MHz
	+/-	3.43 dB	1GHz - 18GHz
	+/-	3.86 dB	18GHz - 40GHz
Radiated Spurious Emission	+/-	2 dB	33GHz-50GHz
	+/-	1.59 dB	50GHz-60GHz
	+/-	1.7 dB	60GHz-90GHz
	+/-	1.64 dB	90GHz-140GHz
	+/-	3.83 dB	140GHz-220GHz

### Note:

1. This uncertainty represents an expanded uncertainty expressed at approximately the 95% confidence level using a coverage factor of k=2.
2. The conformity assessment statement in this report is based solely on the test results, measurement uncertainty is excluded.

Unless otherwise stated the results shown in this test report refer only to the sample(s) tested and such sample(s) are retained for 90 days only.

除非另有說明，此報告結果僅對測試之樣品負責，同時此樣品僅保留90天。本報告未經本公司書面許可，不可部份複製。

This document is issued by the Company subject to its General Conditions of Service printed overleaf, available on request or accessible at <http://www.sgs.com.tw/Terms-and-Conditions> and for electronic format documents, subject to Terms and Conditions for Electronic Documents at <http://www.sgs.com.tw/Terms-and-Conditions>. Attention is drawn to the limitation of liability, indemnification and jurisdiction issues defined therein. Any holder of this document is advised that information contained herein reflects the Company's findings at the time of its intervention only and within the limits of Client's instructions, if any. The Company's sole responsibility is to its Client and this document does not exonerate parties to a transaction from exercising all their rights and obligations under the transaction documents. This document cannot be reproduced except in full, without prior written approval of the Company. Any unauthorized alteration, forgery or falsification of the content or appearance of this document is unlawful and offenders may be prosecuted to the fullest extent of the law.

## 6 MEASUREMENT EQUIPMENT USED

### 6.1 Emission from AC power line

AC Power-Line Conducted Emission Test Site: Conduction C					
EQUIPMENT TYPE	MFR	MODEL NUMBER	SERIAL NUMBER	LAST CAL.	CAL DUE.
DC Power Supply	Agilent	E3640A	MY53170008	09/01/2023	08/31/2024
DC Power Supply	Gwinstek	SPS-3610	GEW902165	01/17/2024	01/16/2025
DC Power Supply	Gwinstek	SPS-3610	GEV856767	10/02/2023	10/01/2024
LISN	SCHWARZBECK Mess-Elektronik	NSLK8127	974	06/19/2023	06/18/2024
EMI Test Receiver	R&S	ESCI	101342	04/29/2024	04/28/2025
Coaxial Cable	EC Lab	RF-HY-CAB-250	RF-HY-CAB-250-01	03/27/2024	03/26/2025
Pulse Limiter	EC Lab	VTSD 9561F-N	485	03/27/2024	03/26/2025
Test Software	audix	e3	E3 20923 SGS Ver.9 ( C )	N.C.R	N.C.R

### 6.2 Conducted Measurement

Conducted Emission Test Site: Conducted C					
EQUIPMENT TYPE	MFR	MODEL NUMBER	SERIAL NUMBER	LAST CAL.	CAL DUE.
Spectrum Analyzer	KEYSIGHT	N9010B	MY59071573	05/23/2023	05/22/2024
Power Meter	Anritsu	ML2496A	2138002	08/31/2023	08/30/2024
Power Sensor	Anritsu	MA2411B	1911390	08/31/2023	08/30/2024
Power Sensor	Anritsu	MA2411B	1911398	08/31/2023	08/30/2024
DC Power Supply	Agilent	E3640A	MY53140006	05/18/2023	05/17/2024
DC Power Supply	HOLA	DP-3003	D7070035	06/12/2023	06/11/2024
DC Power Supply	Gwinstek	SPS-3610	GEV856769	08/04/2023	08/03/2024
Test Software	SGS Taiwan	Radio Test Software	Ver.21	N.C.R	N.C.R
Attenuator	Woken	WATT-218FS-10	RF18	11/15/2023	11/14/2024
Attenuator	Woken	WATT-218FS-10	RF19	11/15/2023	11/14/2024
DC Block	PASTERNAK	PE8210	RF155	11/15/2023	11/14/2024

Unless otherwise stated the results shown in this test report refer only to the sample(s) tested and such sample(s) are retained for 90 days only.

除非另有說明，此報告結果僅對測試之樣品負責，同時此樣品僅保留90天。本報告未經本公司書面許可，不可部份複製。

This document is issued by the Company subject to its General Conditions of Service printed overleaf, available on request or accessible at <http://www.sgs.com.tw/Terms-and-Conditions>, and for electronic format documents, subject to Terms and Conditions for Electronic Documents at <http://www.sgs.com.tw/Terms-and-Conditions>. Attention is drawn to the limitation of liability, indemnification and jurisdiction issues defined therein. Any holder of this document is advised that information contained hereon reflects the Company's findings at the time of its intervention only and within the limits of Client's instructions, if any. The Company's sole responsibility is to its Client and this document does not exonerate parties to a transaction from exercising all their rights and obligations under the transaction documents. This document cannot be reproduced except in full, without prior written approval of the Company. Any unauthorized alteration, forgery or falsification of the content or appearance of this document is unlawful and offenders may be prosecuted to the fullest extent of the law.

6.3 Radiated Measurement

Radiated Emission Test Site: SAC G					
EQUIPMENT TYPE	MFR	MODEL NUMBER	SERIAL NUMBER	LAST CAL.	CAL DUE.
Broadband Antenna	SCHWARZBECK	VULB 9168	1208	07/21/2023	07/20/2024
Horn Antenna	Schwarzbeck	BBHA9170	185	08/21/2023	08/20/2024
Horn Antenna	RF SPIN	DRH18-E	210105A18E	04/12/2024	04/11/2025
Active Loop Antenna	COM-POWER	AL-130R	10160105	12/04/2023	12/03/2024
3m Site NSA	SGS	966 chamber G	N/A	03/30/2024	03/29/2025
Spectrum Analyzer	KEYSIGHT	N9010A	MY51440113	07/17/2023	07/16/2024
Test Software	audix	e3	E3 20923 SGS Ver.9 ( C )	N.C.R	N.C.R
DC Power Supply	Agilent	E3640A	MY53170008	09/01/2023	08/31/2024
DC Power Supply	Gwinstek	SPS-3610	GEW902165	01/17/2024	01/16/2025
DC Power Supply	Gwinstek	SPS-3610	GEV856767	10/02/2023	10/01/2024
Pre-Amplifier	EMC Instruments	EMC18405SEE	980881	11/15/2023	11/14/2024
Pre-Amplifier	EMC Instruments	EMC330N	980781	03/13/2024	03/12/2025
Pre-Amplifier	EMC Instruments	EMC118A45SE	981030	03/13/2024	03/12/2025
Coaxial Cable	EMC Instruments	EMCCFD400-NM-NM-8000-5000-2000	210216 、 210217 、 210218	03/13/2024	03/12/2025
Coaxial Cable	EMC Instruments	EMC104-SM-SM-8000-5000-5000	210219 、 210220 、 210221	03/13/2024	03/12/2025

**NOTE:** N.C.R refers to Not Calibrated Required.

Unless otherwise stated the results shown in this test report refer only to the sample(s) tested and such sample(s) are retained for 90 days only.

除非另有說明，此報告結果僅對測試之樣品負責，同時此樣品僅保留90天。本報告未經本公司書面許可，不可部份複製。

This document is issued by the Company subject to its General Conditions of Service printed overleaf, available on request or accessible at <http://www.sgs.com.tw/Terms-and-Conditions> and for electronic format documents, subject to Terms and Conditions for Electronic Documents at <http://www.sgs.com.tw/Terms-and-Conditions>. Attention is drawn to the limitation of liability, indemnification and jurisdiction issues defined therein. Any holder of this document is advised that information contained hereon reflects the Company's findings at the time of its intervention only and within the limits of Client's instructions, if any. The Company's sole responsibility is to its Client and this document does not exonerate parties to a transaction from exercising all their rights and obligations under the transaction documents. This document cannot be reproduced except in full, without prior written approval of the Company. Any unauthorized alteration, forgery or falsification of the content or appearance of this document is unlawful and offenders may be prosecuted to the fullest extent of the law.



## 7 CONDUCTED EMISSION TEST

### 7.1 Standard Applicable

Frequency range within 150 kHz to 30 MHz shall not exceed the Limit table as below.

Frequency range MHz	Limits (dBuV)	
	Quasi-peak	Average
0.15 to 0.50	66 to 56	56 to 46
0.50 to 5	56	46
5 to 30	60	50

Note

- 1.The lower limit shall apply at the transition frequencies
- 2.The limit decreases linearly with the logarithm of the frequency in the range 0.15 MHz to 0.50 MHz.

### 7.2 EUT Setup:

1. The conducted emission tests were performed in the test site, using the setup in accordance with the ANSI C63.10:2013.
2. The AC/DC Power adaptor of EUT was plug-in LISN. The EUT was placed flushed with the rear of the table.
3. The LISN was connected with 120Vac/60Hz power source.

### 7.3 Test SET-UP

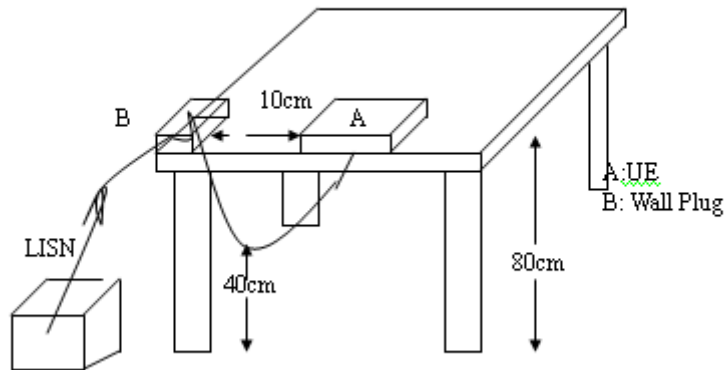

### 7.4 Measurement Procedure

1. The EUT was placed on a table which is 0.8m above ground plane.
2. Maximum procedure was performed on the six highest emissions to ensure EUT compliance.
3. Repeat above procedures until all phases of power being supplied by given UE are completed.

Unless otherwise stated the results shown in this test report refer only to the sample(s) tested and such sample(s) are retained for 90 days only.

除非另有說明，此報告結果僅對測試之樣品負責，同時此樣品僅保留90天。本報告未經本公司書面許可，不可部份複製。

This document is issued by the Company subject to its General Conditions of Service printed overleaf, available on request or accessible at <http://www.sgs.com.tw/Terms-and-Conditions> and for electronic format documents, subject to Terms and Conditions for Electronic Documents at <http://www.sgs.com.tw/Terms-and-Conditions>. Attention is drawn to the limitation of liability, indemnification and jurisdiction issues defined therein. Any holder of this document is advised that information contained herein reflects the Company's findings at the time of its intervention only and within the limits of Client's instructions, if any. The Company's sole responsibility is to its Client and this document does not exonerate parties to a transaction from exercising all their rights and obligations under the transaction documents. This document cannot be reproduced except in full, without prior written approval of the Company. Any unauthorized alteration, forgery or falsification of the content or appearance of this document is unlawful and offenders may be prosecuted to the fullest extent of the law.



## 7.5 Measurement Result

Note: Refer to next page for measurement data and plots.

Note2: The \* reveals the worst-case results that closest to the limit.

Unless otherwise stated the results shown in this test report refer only to the sample(s) tested and such sample(s) are retained for 90 days only.  
除非另有說明，此報告結果僅對測試之樣品負責，同時此樣品僅保留90天。本報告未經本公司書面許可，不可部份複製。

This document is issued by the Company subject to its General Conditions of Service printed overleaf, available on request or accessible at <http://www.sgs.com.tw/Terms-and-Conditions> and for electronic format documents, subject to Terms and Conditions for Electronic Documents at <http://www.sgs.com.tw/Terms-and-Conditions>. Attention is drawn to the limitation of liability, indemnification and jurisdiction issues defined therein. Any holder of this document is advised that information contained hereon reflects the Company's findings at the time of its intervention only and within the limits of Client's instructions, if any. The Company's sole responsibility is to its Client and this document does not exonerate parties to a transaction from exercising all their rights and obligations under the transaction documents. This document cannot be reproduced except in full, without prior written approval of the Company. Any unauthorized alteration, forgery or falsification of the content or appearance of this document is unlawful and offenders may be prosecuted to the fullest extent of the law.

SGS Taiwan Ltd.

No.134,Wu Kung Road, New Taipei Industrial Park, Wuku District, New Taipei City, Taiwan/新北市五股區新北產業園區五工路 134 號

台灣檢驗科技股份有限公司

t (886-2) 2299-3279

f (886-2) 2298-0488

[www.sgs.com.tw](http://www.sgs.com.tw)

Member of SGS Group

### AC POWER LINE CONDUCTED EMISSION TEST DATA

Report Number	:TERF2404000927E2	Test Site	:Conduction C
Test Mode	:5G	Test Date	:2024-05-14
Power	:120V/60Hz	Temp./Humi.	:21.5°C/54%
Probe	:L1	Engineer	:Temo Chen

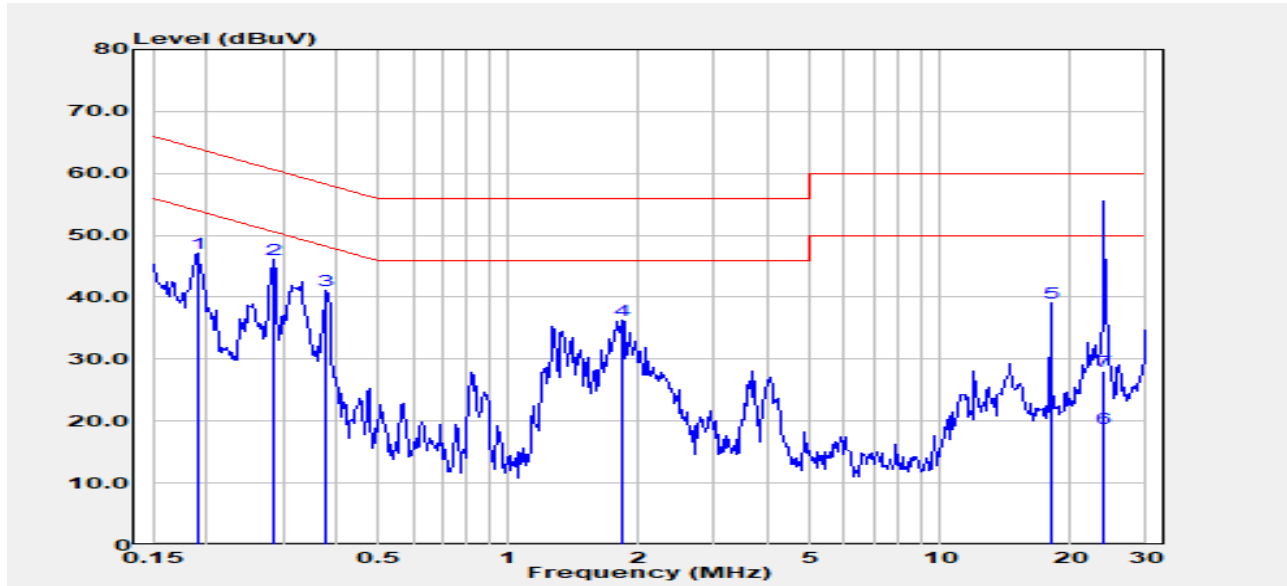

Freq. MHz	Detector Mode PK/QP/AV	Spectrum Reading Level dBμV	Factor dB	Actual FS dBμV	Limit dBμV	Margin dB
0.190	Peak	36.44	10.68	47.13	64.03	-16.90
0.286	Peak	35.52	10.66	46.18	60.64	-14.46
0.378	Peak	30.38	10.65	41.02	58.31	-17.29
1.836	Peak	25.52	10.77	36.29	56.00	-19.71
18.025	Peak	27.93	11.12	39.05	60.00	-20.95
24.057	Average	7.70	11.25	18.95	50.00	-31.05
24.057	QP	16.90	11.25	28.15	60.00	-31.85

Unless otherwise stated the results shown in this test report refer only to the sample(s) tested and such sample(s) are retained for 90 days only.

除非另有說明，此報告結果僅對測試之樣品負責，同時此樣品僅保留90天。本報告未經本公司書面許可，不可部份複製。

This document is issued by the Company subject to its General Conditions of Service printed overleaf, available on request or accessible at <http://www.sgs.com.tw/Terms-and-Conditions> and for electronic format documents, subject to Terms and Conditions for Electronic Documents at <http://www.sgs.com.tw/Terms-and-Conditions>. Attention is drawn to the limitation of liability, indemnification and jurisdiction issues defined therein. Any holder of this document is advised that information contained hereon reflects the Company's findings at the time of its intervention only and within the limits of Client's instructions, if any. The Company's sole responsibility is to its Client and this document does not exonerate parties to a transaction from exercising all their rights and obligations under the transaction documents. This document cannot be reproduced except in full, without prior written approval of the Company. Any unauthorized alteration, forgery or falsification of the content or appearance of this document is unlawful and offenders may be prosecuted to the fullest extent of the law.

Report Number	:TERF2404000927E2	Test Site	:Conduction C
Test Mode	:5G	Test Date	:2024-05-14
Power	:120V/60Hz	Temp./Humi.	:21.5°C/54%
Probe	:N	Engineer	:Temo Chen

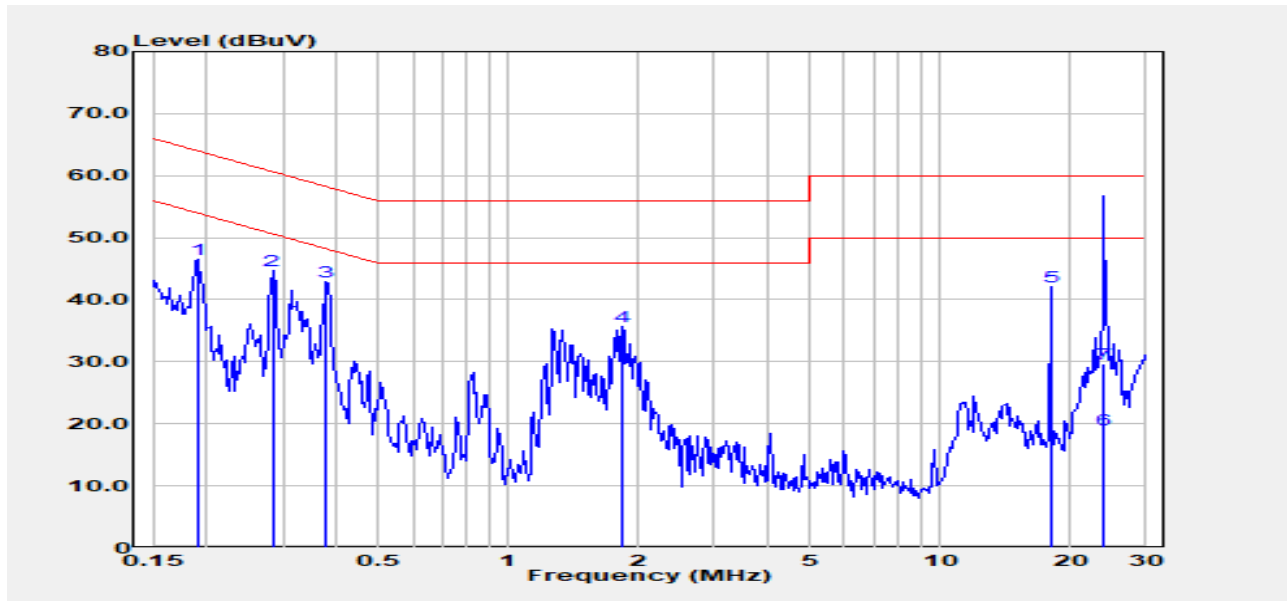

Freq. MHz	Detector Mode PK/QP/AV	Spectrum Reading Level dBμV	Factor dB	Actual FS dBμV	Limit dBμV	Margin dB
0.190	Peak	35.92	10.67	46.59	64.03	-17.44
0.284	Peak	34.06	10.65	44.71	60.71	-16.00
0.378	Peak	32.22	10.63	42.84	58.31	-15.47
1.836	Peak	24.85	10.76	35.61	56.00	-20.39
18.025	Peak	30.91	11.21	42.12	60.00	-17.88
24.057	Average	7.60	11.36	18.96	50.00	-31.04
24.057	QP	18.30	11.36	29.66	60.00	-30.34

Unless otherwise stated the results shown in this test report refer only to the sample(s) tested and such sample(s) are retained for 90 days only.

除非另有說明，此報告結果僅對測試之樣品負責，同時此樣品僅保留90天。本報告未經本公司書面許可，不可部份複製。

This document is issued by the Company subject to its General Conditions of Service printed overleaf, available on request or accessible at <http://www.sgs.com.tw/Terms-and-Conditions> and for electronic format documents, subject to Terms and Conditions for Electronic Documents at <http://www.sgs.com.tw/Terms-and-Conditions>. Attention is drawn to the limitation of liability, indemnification and jurisdiction issues defined therein. Any holder of this document is advised that information contained hereon reflects the Company's findings at the time of its intervention only and within the limits of Client's instructions, if any. The Company's sole responsibility is to its Client and this document does not exonerate parties to a transaction from exercising all their rights and obligations under the transaction documents. This document cannot be reproduced except in full, without prior written approval of the Company. Any unauthorized alteration, forgery or falsification of the content or appearance of this document is unlawful and offenders may be prosecuted to the fullest extent of the law.

## 8 EMISSION BANDWIDTH MEASUREMENT

### 8.1 Standard Applicable

There is no limit bandwidth for U-NII-1, U-NII-2-A and U-NII-2-C.  
The minimum of 6dB Bandwidth measurement is 0.5 MHz for U-NII-3.

### 8.2 Test Setup

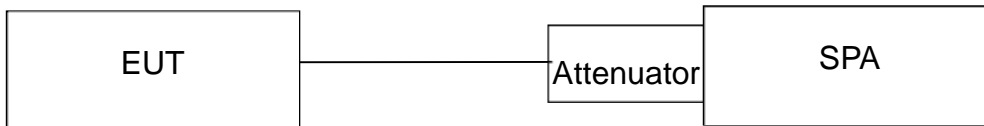

### 8.3 Measurement Procedure

1. Place the EUT on the table and set it in transmitting mode.
2. The testing follows FCC KDB 789033 D02 General UNII Test Procedures New Rules.
3. Remove the antenna from the EUT and then connect a low loss RF cable from the Antenna port to the spectrum analyzer.
  - 3.a. 26dB Band width Measurement: Set the spectrum analyzer as 1% of emission BW  
Sweep=auto,  
Detector = Peak,  
Trace Mode = Max Hold,  
Manually readjust RBW until the RBW/EBW ratio is 1% based on EBW as observed on the result of pre-sequence measurement.
  - 3.b. Mark the peak frequency and -26dB (upper and lower) frequency.
4. Repeat the procedures as list above until all test default channels (low, middle, and high) are completed.
5. Minimum Emission Bandwidth for the band 5.725-5.850GHz.
  - a. Set the spectrum analyzer as  
RBW = 100 kHz,  
VBW = 3\*RBW,  
Span = large enough to capture all products of the modulation process,  
Detector=Peak,  
Sweep=auto
  - b. Mark the peak frequency and -6dB (upper and lower) frequency.
6. For 99% Bandwidth: Set the spectrum analyzer as  
RBW = 1%,  
VBW = 3\*RBW,  
Span = large enough to capture all products of the modulation process,  
Detector=Sample,  
Sweep=auto.
7. Turn on the 99% bandwidth function, max reading.
8. Repeat above procedures until all frequency of interest measured was complete.

Unless otherwise stated the results shown in this test report refer only to the sample(s) tested and such sample(s) are retained for 90 days only.

除非另有說明，此報告結果僅對測試之樣品負責，同時此樣品僅保留90天。本報告未經本公司書面許可，不可部份複製。

This document is issued by the Company subject to its General Conditions of Service printed overleaf, available on request or accessible at <http://www.sgs.com.tw/Terms-and-Conditions>, and for electronic format documents, subject to Terms and Conditions for Electronic Documents at <http://www.sgs.com.tw/Terms-and-Conditions>. Attention is drawn to the limitation of liability, indemnification and jurisdiction issues defined therein. Any holder of this document is advised that information contained hereon reflects the Company's findings at the time of its intervention only and within the limits of Client's instructions, if any. The Company's sole responsibility is to its Client and this document does not exonerate parties to a transaction from exercising all their rights and obligations under the transaction documents. This document cannot be reproduced except in full, without prior written approval of the Company. Any unauthorized alteration, forgery or falsification of the content or appearance of this document is unlawful and offenders may be prosecuted to the fullest extent of the law.

## 8.4 Measurement Result

### 8.4.1 FCC Occupied Bandwidth

#### 802.11a\_Ch0

Freq. (MHz)	26dB BW (MHz)	10 Log (B) (dB)
5180	20.95	13.210
5220	21.31	13.290
5240	21.09	13.240
5260	21.34	13.290
5300	21.16	13.260
5320	21.09	13.240
5500	21.30	13.280
5580	21.20	13.260
5700	21.18	13.260
5720(U-NII 2C)	17.55	12.440
5720(U-NII 3)	7.55	8.780

#### 802.11a\_Ch0

Freq. (MHz)	6dB BW (MHz)	10 Log (B) (dB)
5745	16.43	12.160
5785	16.37	12.140
5825	16.36	12.140

#### 802.11a\_Ch0

Freq. (MHz)	Measured Freq. (MHz)	Limit (MHz)
5240	5248.395569	< 5250
5745	5736.689761	> 5725

Unless otherwise stated the results shown in this test report refer only to the sample(s) tested and such sample(s) are retained for 90 days only.  
 除非另有說明，此報告結果僅對測試之樣品負責，同時此樣品僅保留90天。本報告未經本公司書面許可，不可部份複製。

This document is issued by the Company subject to its General Conditions of Service printed overleaf, available on request or accessible at <http://www.sgs.com.tw/Terms-and-Conditions> and for electronic format documents, subject to Terms and Conditions for Electronic Documents at <http://www.sgs.com.tw/Terms-and-Conditions>. Attention is drawn to the limitation of liability, indemnification and jurisdiction issues defined therein. Any holder of this document is advised that information contained hereon reflects the Company's findings at the time of its intervention only and within the limits of Client's instructions, if any. The Company's sole responsibility is to its Client and this document does not exonerate parties to a transaction from exercising all their rights and obligations under the transaction documents. This document cannot be reproduced except in full, without prior written approval of the Company. Any unauthorized alteration, forgery or falsification of the content or appearance of this document is unlawful and offenders may be prosecuted to the fullest extent of the law.

802.11n\_HT20\_Ch0

Freq. (MHz)	26dB BW (MHz)	10 Log (B) (dB)
5180	21.52	13.330
5220	21.40	13.300
5240	21.31	13.290
5260	21.54	13.330
5300	21.45	13.310
5320	21.23	13.270
5500	21.32	13.290
5580	21.63	13.350
5700	21.17	13.260
5720(U-NII 2C)	17.17	12.350
5720(U-NII 3)	7.16	8.550

802.11n\_HT20\_Ch0

Freq. (MHz)	6dB BW (MHz)	10 Log (B) (dB)
5745	17.65	12.470
5785	17.61	12.460
5825	17.35	12.390

802.11n\_HT20\_Ch0

Freq. (MHz)	Measured Freq. (MHz)	Limit (MHz)
5240	5248.944259	< 5250
5745	5736.102913	> 5725

Unless otherwise stated the results shown in this test report refer only to the sample(s) tested and such sample(s) are retained for 90 days only.  
 除非另有說明，此報告結果僅對測試之樣品負責，同時此樣品僅保留90天。本報告未經本公司書面許可，不可部份複製。

This document is issued by the Company subject to its General Conditions of Service printed overleaf, available on request or accessible at <http://www.sgs.com.tw/Terms-and-Conditions> and for electronic format documents, subject to Terms and Conditions for Electronic Documents at <http://www.sgs.com.tw/Terms-and-Conditions>. Attention is drawn to the limitation of liability, indemnification and jurisdiction issues defined therein. Any holder of this document is advised that information contained hereon reflects the Company's findings at the time of its intervention only and within the limits of Client's instructions, if any. The Company's sole responsibility is to its Client and this document does not exonerate parties to a transaction from exercising all their rights and obligations under the transaction documents. This document cannot be reproduced except in full, without prior written approval of the Company. Any unauthorized alteration, forgery or falsification of the content or appearance of this document is unlawful and offenders may be prosecuted to the fullest extent of the law.

802.11a\_20MHz\_Chain0\_5180MHz

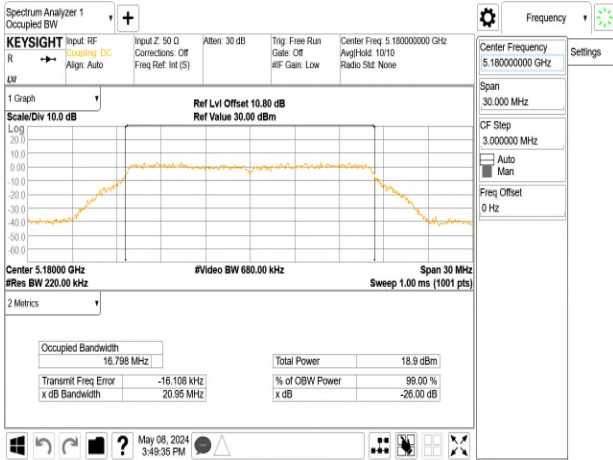

802.11a\_20MHz\_Chain0\_5260MHz

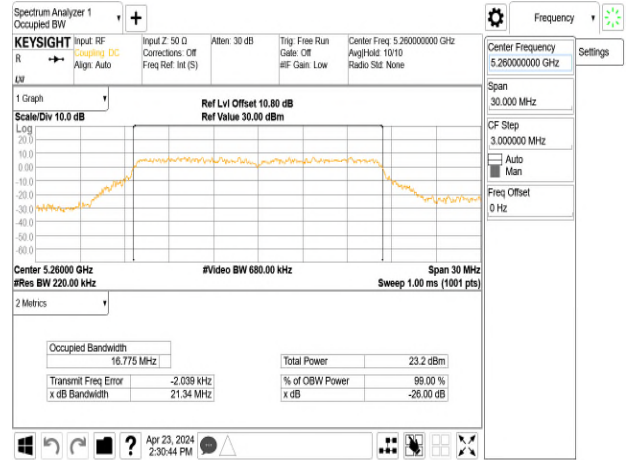

802.11a\_20MHz\_Chain0\_5220MHz

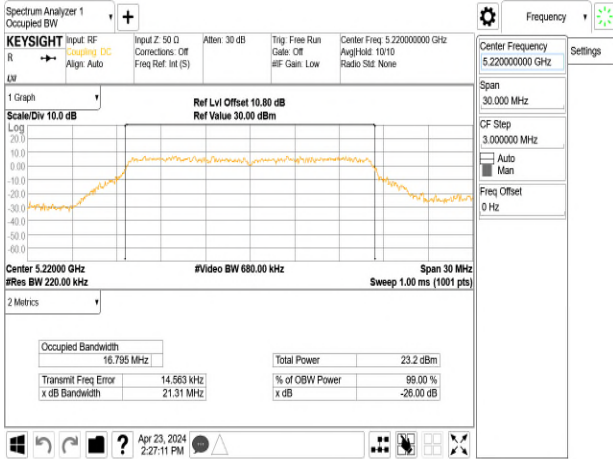

802.11a\_20MHz\_Chain0\_5300MHz

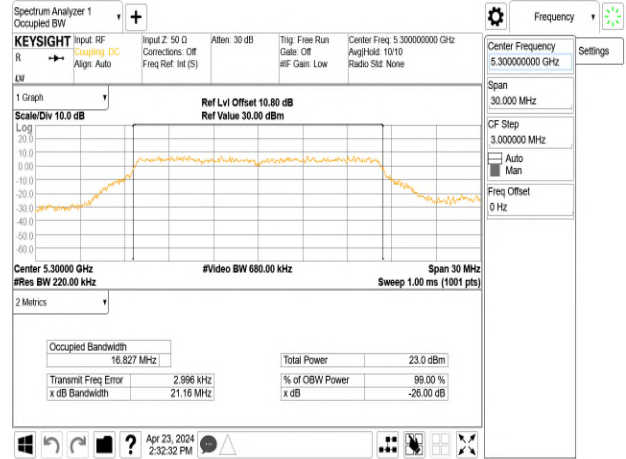

802.11a\_20MHz\_Chain0\_5240MHz



802.11a\_20MHz\_Chain0\_5320MHz

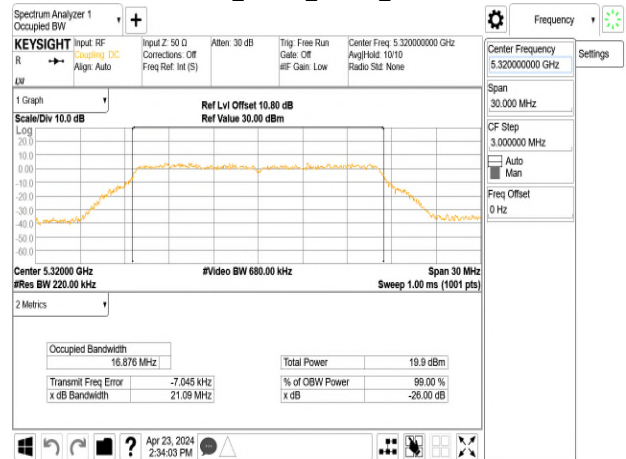

Unless otherwise stated the results shown in this test report refer to the sample(s) tested and such sample(s) are retained for 90 days only.

除非另有說明，此報告結果僅對測試之樣品負責，同時此樣品僅保留90天。本報告未經本公司書面許可，不可部份複製。

This document is issued by the Company subject to its General Conditions of Service printed overleaf, available on request or accessible at <http://www.sgs.com.tw/Terms-and-Conditions>, and for electronic format documents, subject to Terms and Conditions for Electronic Documents at <http://www.sgs.com.tw/Terms-and-Conditions>. Attention is drawn to the limitation of liability, indemnification and jurisdiction issues defined therein. Any holder of this document is advised that information contained hereon reflects the Company's findings at the time of its intervention only and within the limits of Client's instructions, if any. The Company's sole responsibility is to its Client and this document does not exonerate parties to a transaction from exercising all their rights and obligations under the transaction documents. This document cannot be reproduced except in full, without prior written approval of the Company. Any unauthorized alteration, forgery or falsification of the content or appearance of this document is unlawful and offenders may be prosecuted to the fullest extent of the law.



802.11a\_20MHz\_Chain0\_5500MHz

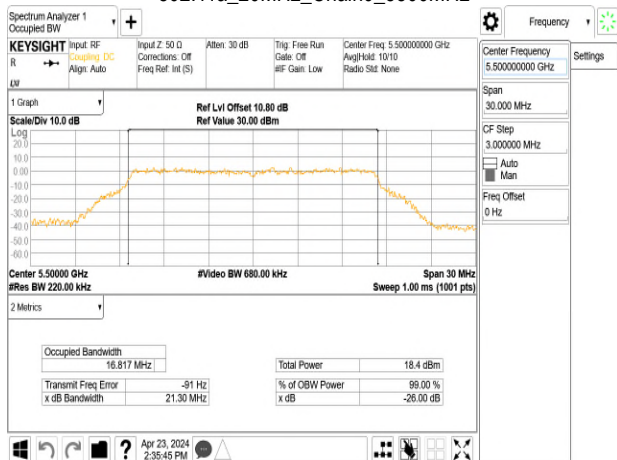

802.11a\_20MHz\_Chain0\_5720MHz

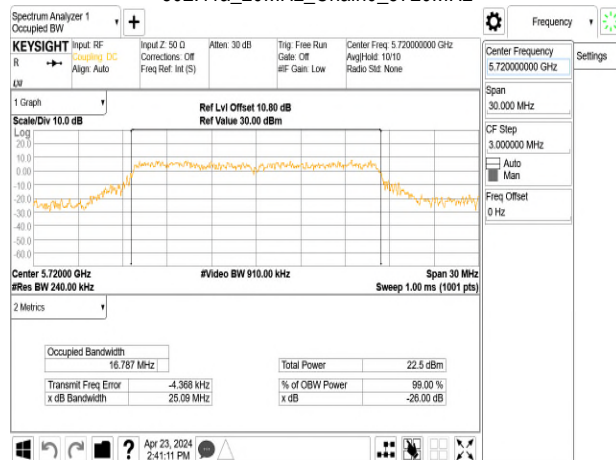

802.11a\_20MHz\_Chain0\_5580MHz

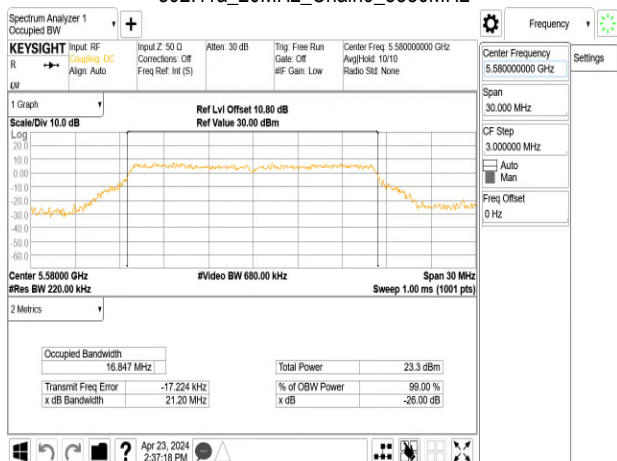

802.11a\_20MHz\_Chain0\_5745MHz



802.11a\_20MHz\_Chain0\_5700MHz

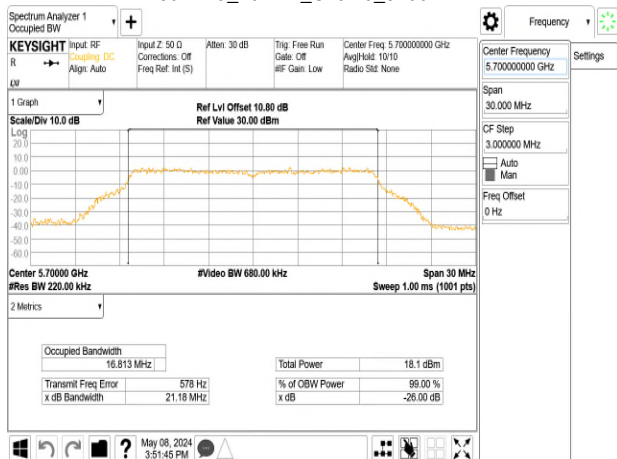

802.11a\_20MHz\_Chain0\_5785MHz

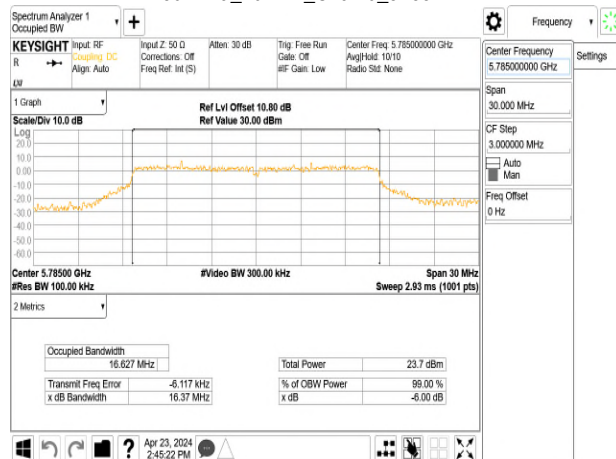

Unless otherwise stated the results shown in this test report refer only to the sample(s) tested and such sample(s) are retained for 90 days only.

除非另有說明，此報告結果僅對測試之樣品負責，同時此樣品僅保留90天。本報告未經本公司書面許可，不可部份複製。

This document is issued by the Company subject to its General Conditions of Service printed overleaf, available on request or accessible at <http://www.sgs.com.tw/Terms-and-Conditions> and for electronic format documents, subject to Terms and Conditions for Electronic Documents at <http://www.sgs.com.tw/Terms-and-Conditions>. Attention is drawn to the limitation of liability, indemnification and jurisdiction issues defined therein. Any holder of this document is advised that information contained hereon reflects the Company's findings at the time of its intervention only and within the limits of Client's instructions, if any. The Company's sole responsibility is to its Client and this document does not exonerate parties to a transaction from exercising all their rights and obligations under the transaction documents. This document cannot be reproduced except in full, without prior written approval of the Company. Any unauthorized alteration, forgery or falsification of the content or appearance of this document is unlawful and offenders may be prosecuted to the fullest extent of the law.

802.11a\_20MHz\_Chain0\_5825MHz

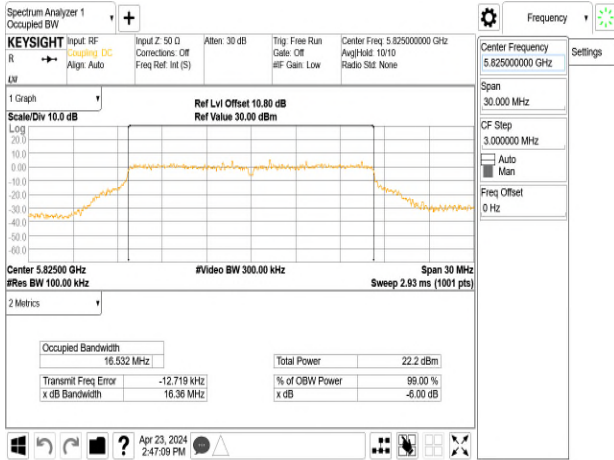

802.11n\_20MHz\_Chain0\_5240MHz

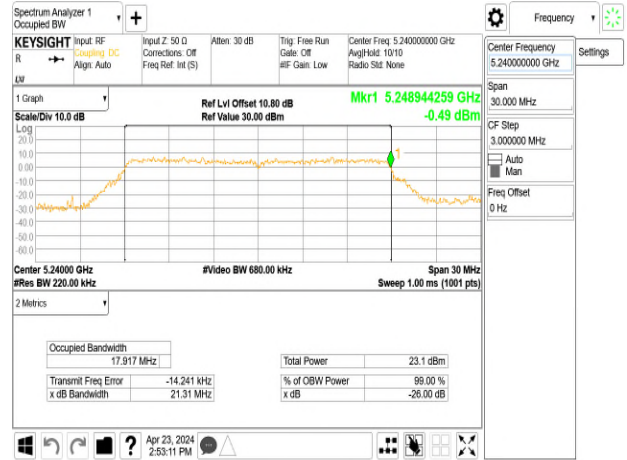

802.11n\_20MHz\_Chain0\_5180MHz

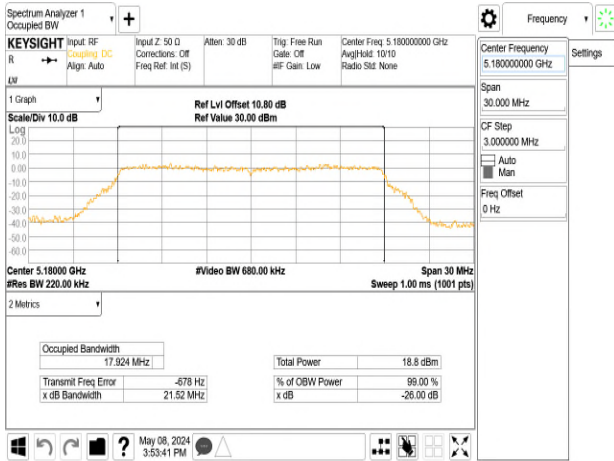

802.11n\_20MHz\_Chain0\_5260MHz

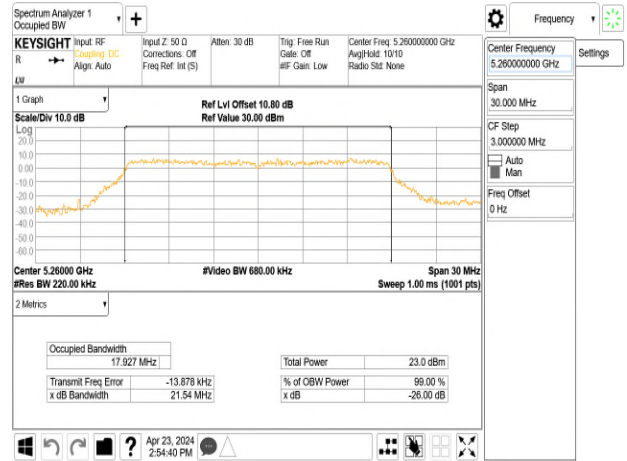

802.11n\_20MHz\_Chain0\_5220MHz

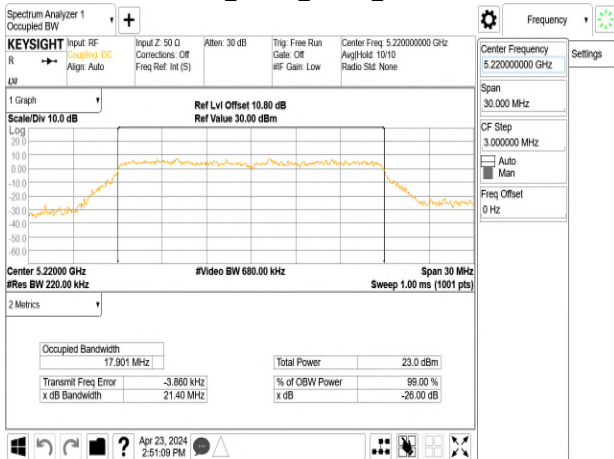

802.11n\_20MHz\_Chain0\_5300MHz

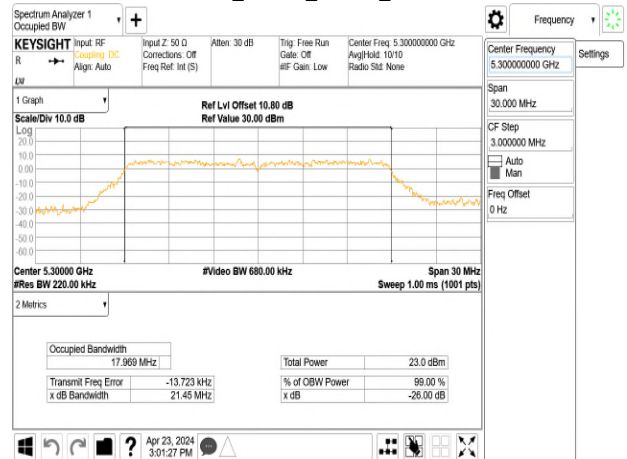

Unless otherwise stated the results shown in this test report refer only to the sample(s) tested and such sample(s) are retained for 90 days only.

除非另有說明，此報告結果僅對測試之樣品負責，同時此樣品僅保留90天。本報告未經本公司書面許可，不可部份複製。

This document is issued by the Company subject to its General Conditions of Service printed overleaf, available on request or accessible at <http://www.sgs.com.tw/Terms-and-Conditions>, and for electronic format documents, subject to Terms and Conditions for Electronic Documents at <http://www.sgs.com.tw/Terms-and-Conditions>. Attention is drawn to the limitation of liability, indemnification and jurisdiction issues defined therein. Any holder of this document is advised that information contained hereon reflects the Company's findings at the time of its intervention only and within the limits of Client's instructions, if any. The Company's sole responsibility is to its Client and this document does not exonerate parties to a transaction from exercising all their rights and obligations under the transaction documents. This document cannot be reproduced except in full, without prior written approval of the Company. Any unauthorized alteration, forgery or falsification of the content or appearance of this document is unlawful and offenders may be prosecuted to the fullest extent of the law.

802.11n\_20MHz\_Chain0\_5320MHz

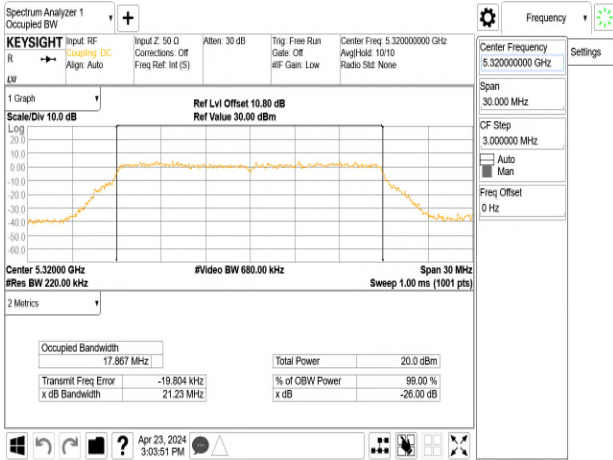

802.11n\_20MHz\_Chain0\_5700MHz

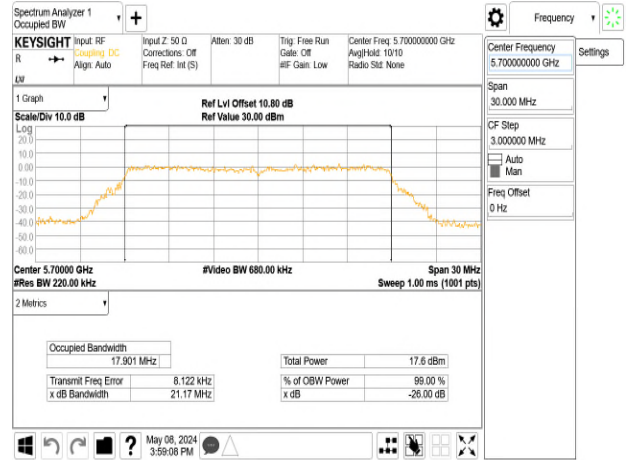

802.11n\_20MHz\_Chain0\_5500MHz

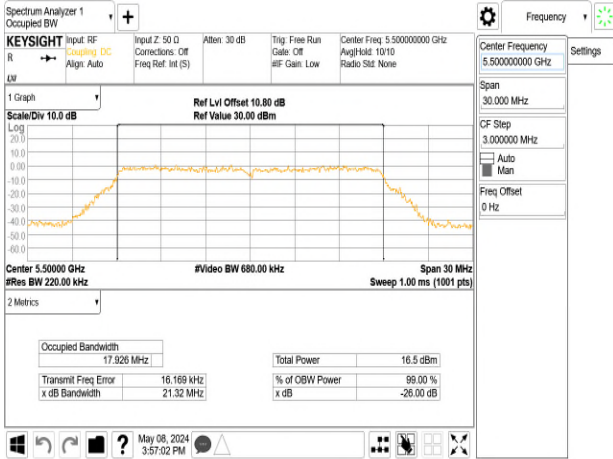

802.11n\_20MHz\_Chain0\_5720MHz

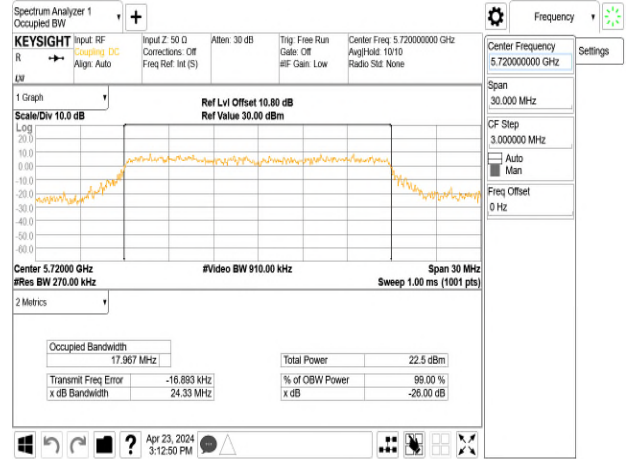

802.11n\_20MHz\_Chain0\_5580MHz

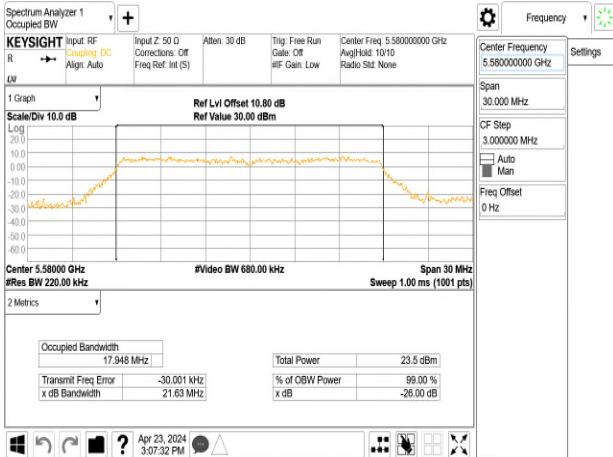

802.11n\_20MHz\_Chain0\_5745MHz



Unless otherwise stated the results shown in this test report refer only to the sample(s) tested and such sample(s) are retained for 90 days only.

除非另有說明，此報告結果僅對測試之樣品負責，同時此樣品僅保留90天。本報告未經本公司書面許可，不可部份複製。

This document is issued by the Company subject to its General Conditions of Service printed overleaf, available on request or accessible at <http://www.sgs.com.tw/Terms-and-Conditions>, and for electronic format documents, subject to Terms and Conditions for Electronic Documents at <http://www.sgs.com.tw/Terms-and-Conditions>. Attention is drawn to the limitation of liability, indemnification and jurisdiction issues defined therein. Any holder of this document is advised that information contained hereon reflects the Company's findings at the time of its intervention only and within the limits of Client's instructions, if any. The Company's sole responsibility is to its Client and this document does not exonerate parties to a transaction from exercising all their rights and obligations under the transaction documents. This document cannot be reproduced except in full, without prior written approval of the Company. Any unauthorized alteration, forgery or falsification of the content or appearance of this document is unlawful and offenders may be prosecuted to the fullest extent of the law.



802.11n\_20MHz\_Chain0\_5785MHz

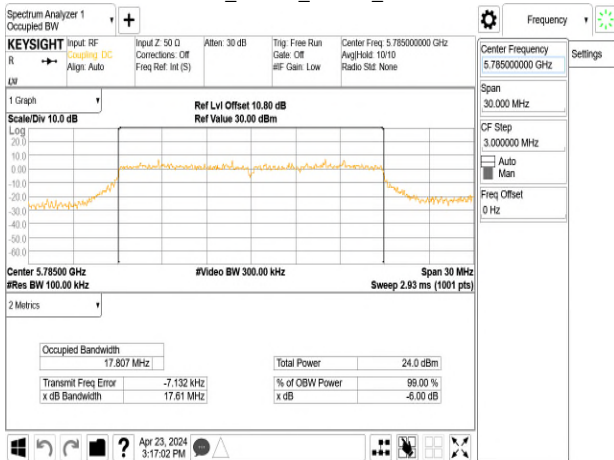

802.11n\_20MHz\_Chain0\_5825MHz

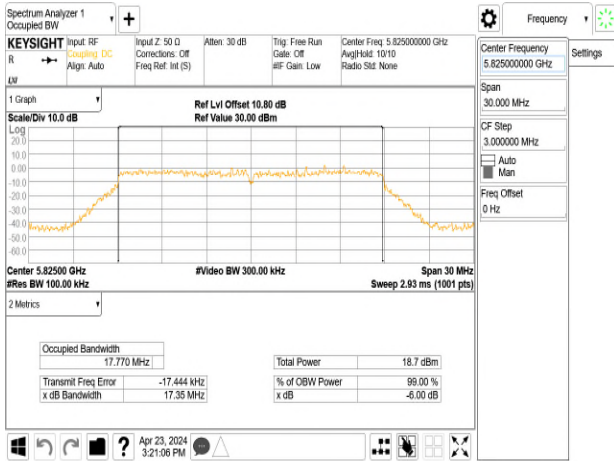

Unless otherwise stated the results shown in this test report refer only to the sample(s) tested and such sample(s) are retained for 90 days only.

除非另有說明，此報告結果僅對測試之樣品負責，同時此樣品僅保留90天。本報告未經本公司書面許可，不可部份複製。

This document is issued by the Company subject to its General Conditions of Service printed overleaf, available on request or accessible at <http://www.sgs.com.tw/Terms-and-Conditions> and for electronic format documents, subject to Terms and Conditions for Electronic Documents at <http://www.sgs.com.tw/Terms-and-Conditions>. Attention is drawn to the limitation of liability, indemnification and jurisdiction issues defined therein. Any holder of this document is advised that information contained hereon reflects the Company's findings at the time of its intervention only and within the limits of Client's instructions, if any. The Company's sole responsibility is to its Client and this document does not exonerate parties to a transaction from exercising all their rights and obligations under the transaction documents. This document cannot be reproduced except in full, without prior written approval of the Company. Any unauthorized alteration, forgery or falsification of the content or appearance of this document is unlawful and offenders may be prosecuted to the fullest extent of the law.

8.4.2 ISED Occupied Bandwidth

802.11a\_Ch0

Frequency (MHz)	99% BW (MHz)	10 Log (B) (dB)
5180	16.758	12.240
5220	16.779	12.250
5240	16.852	12.270
5260	16.767	12.240
5300	16.807	12.250
5320	16.724	12.230
5500	16.737	12.240
5580	16.781	12.250
5700	16.810	12.260
5720(U-NII 2C)	13.460	11.290
5720(U-NII 3)	3.460	5.390

802.11a\_Ch0

Frequency (MHz)	99% BW (MHz)	6dB BW (MHz)
5745	16.875	16.430
5785	16.903	16.470
5825	16.753	16.440

Unless otherwise stated the results shown in this test report refer only to the sample(s) tested and such sample(s) are retained for 90 days only.

除非另有說明，此報告結果僅對測試之樣品負責，同時此樣品僅保留90天。本報告未經本公司書面許可，不可部份複製。

This document is issued by the Company subject to its General Conditions of Service printed overleaf, available on request or accessible at <http://www.sgs.com.tw/Terms-and-Conditions> and for electronic format documents, subject to Terms and Conditions for Electronic Documents at <http://www.sgs.com.tw/Terms-and-Conditions>. Attention is drawn to the limitation of liability, indemnification and jurisdiction issues defined therein. Any holder of this document is advised that information contained hereon reflects the Company's findings at the time of its intervention only and within the limits of Client's instructions, if any. The Company's sole responsibility is to its Client and this document does not exonerate parties to a transaction from exercising all their rights and obligations under the transaction documents. This document cannot be reproduced except in full, without prior written approval of the Company. Any unauthorized alteration, forgery or falsification of the content or appearance of this document is unlawful and offenders may be prosecuted to the fullest extent of the law.

802.11n\_HT20\_Ch0

Frequency (MHz)	99% BW (MHz)	10 Log (B) (dB)
5180	17.860	12.520
5220	17.890	12.530
5240	17.922	12.530
5260	17.956	12.540
5300	17.869	12.520
5320	17.884	12.520
5500	17.875	12.520
5580	17.913	12.530
5700	17.896	12.530
5720(U-NII 2C)	13.998	11.460
5720(U-NII 3)	3.998	6.020

802.11n\_HT20\_Ch0

Frequency (MHz)	99% BW (MHz)	6dB BW (MHz)
5745	17.932	17.630
5785	17.981	17.660
5825	17.876	17.670

Unless otherwise stated the results shown in this test report refer only to the sample(s) tested and such sample(s) are retained for 90 days only.  
 除非另有說明，此報告結果僅對測試之樣品負責，同時此樣品僅保留90天。本報告未經本公司書面許可，不可部份複製。

This document is issued by the Company subject to its General Conditions of Service printed overleaf, available on request or accessible at <http://www.sgs.com.tw/Terms-and-Conditions> and for electronic format documents, subject to Terms and Conditions for Electronic Documents at <http://www.sgs.com.tw/Terms-and-Conditions>. Attention is drawn to the limitation of liability, indemnification and jurisdiction issues defined therein. Any holder of this document is advised that information contained hereon reflects the Company's findings at the time of its intervention only and within the limits of Client's instructions, if any. The Company's sole responsibility is to its Client and this document does not exonerate parties to a transaction from exercising all their rights and obligations under the transaction documents. This document cannot be reproduced except in full, without prior written approval of the Company. Any unauthorized alteration, forgery or falsification of the content or appearance of this document is unlawful and offenders may be prosecuted to the fullest extent of the law.

802.11a\_20MHz\_Chain0\_5180MHz

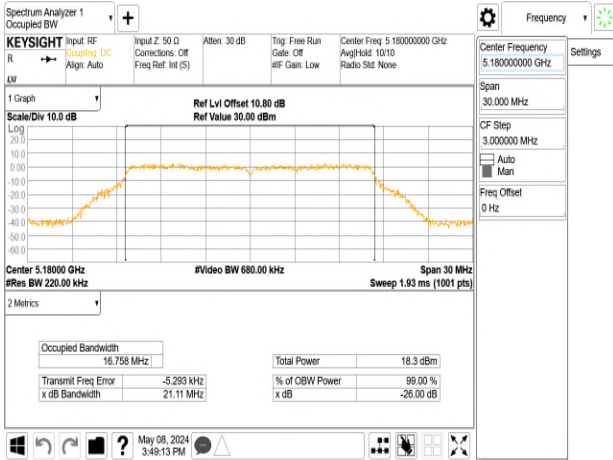

802.11a\_20MHz\_Chain0\_5260MHz

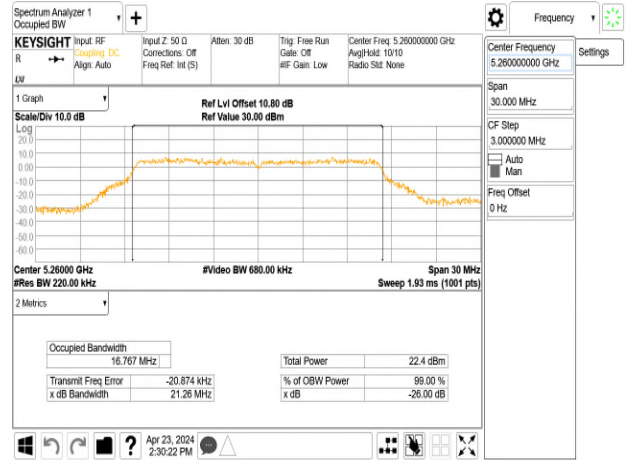

802.11a\_20MHz\_Chain0\_5220MHz

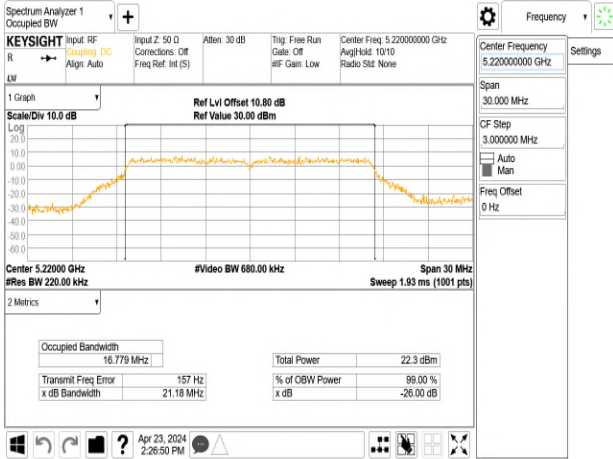

802.11a\_20MHz\_Chain0\_5300MHz

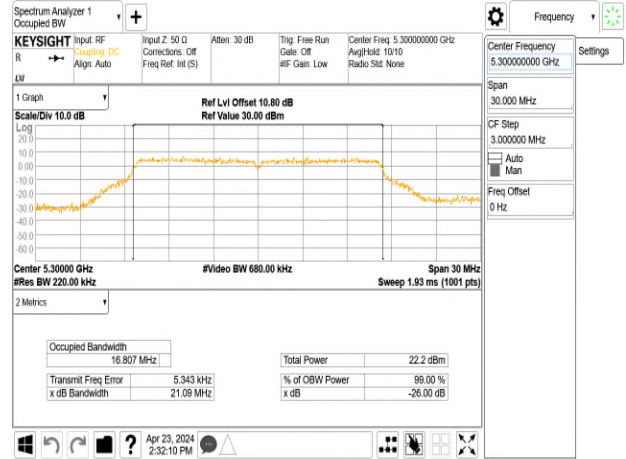

802.11a\_20MHz\_Chain0\_5240MHz

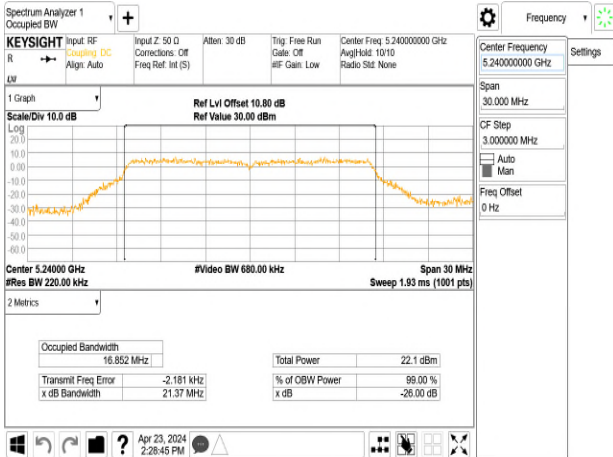

802.11a\_20MHz\_Chain0\_5320MHz

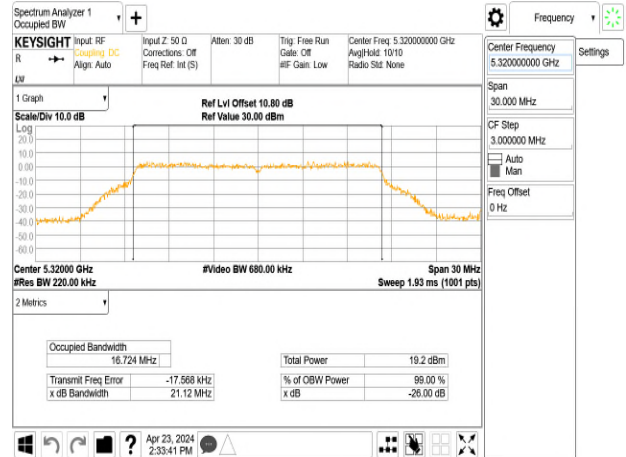

Unless otherwise stated the results shown in this test report refer only to the sample(s) tested and such sample(s) are retained for 90 days only.

除非另有說明，此報告結果僅對測試之樣品負責，同時此樣品僅保留90天。本報告未經本公司書面許可，不可部份複製。

This document is issued by the Company subject to its General Conditions of Service printed overleaf, available on request or accessible at <http://www.sgs.com.tw/Terms-and-Conditions> and for electronic format documents, subject to Terms and Conditions for Electronic Documents at <http://www.sgs.com.tw/Terms-and-Conditions>. Attention is drawn to the limitation of liability, indemnification and jurisdiction issues defined therein. Any holder of this document is advised that information contained hereon reflects the Company's findings at the time of its intervention only and within the limits of Client's instructions, if any. The Company's sole responsibility is to its Client and this document does not exonerate parties to a transaction from exercising all their rights and obligations under the transaction documents. This document cannot be reproduced except in full, without prior written approval of the Company. Any unauthorized alteration, forgery or falsification of the content or appearance of this document is unlawful and offenders may be prosecuted to the fullest extent of the law.

802.11a\_20MHz\_Chain0\_5500MHz

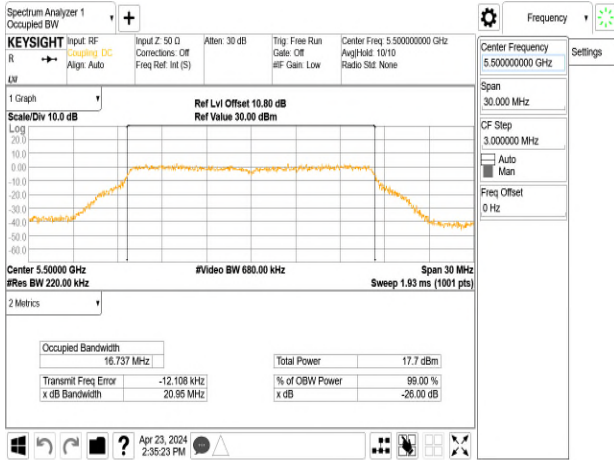

802.11a\_20MHz\_Chain0\_5720MHz

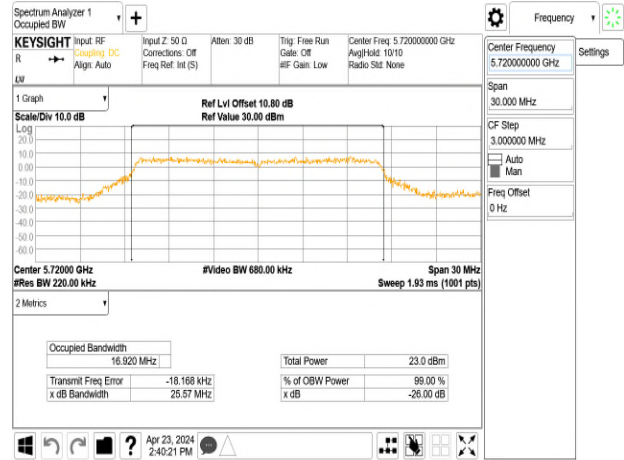

802.11a\_20MHz\_Chain0\_5580MHz

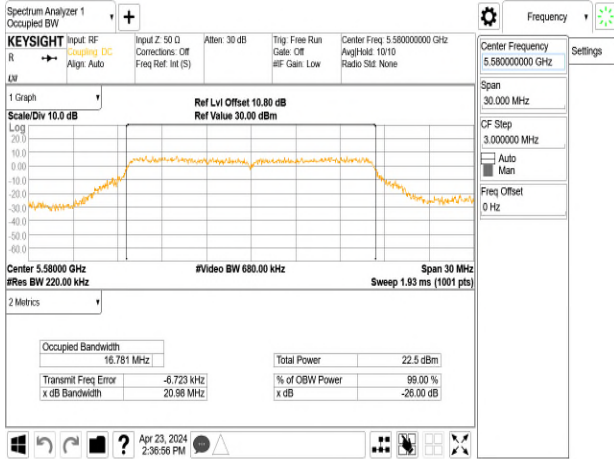

802.11a\_20MHz\_Chain0\_5745MHz

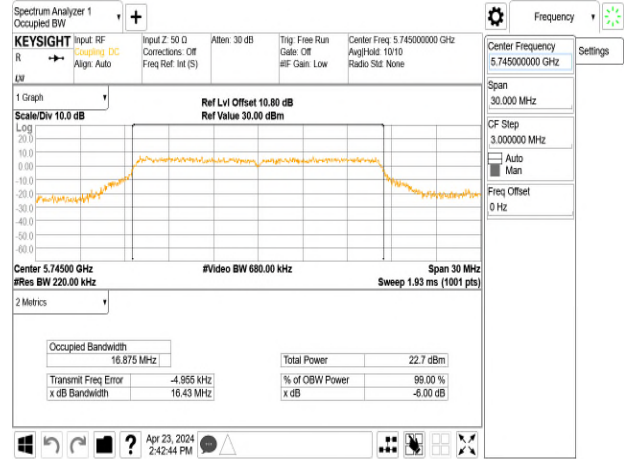

802.11a\_20MHz\_Chain0\_5700MHz

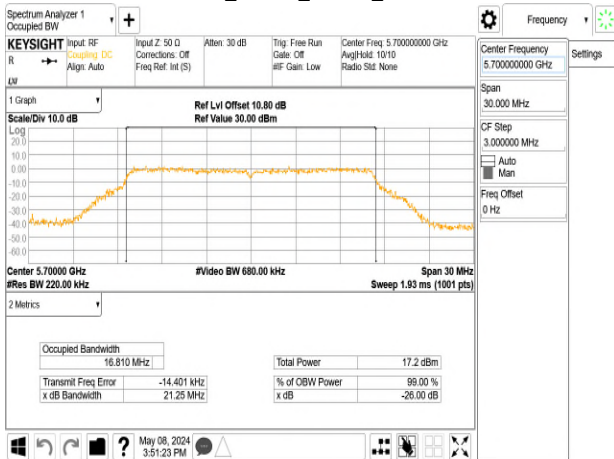

802.11a\_20MHz\_Chain0\_5785MHz

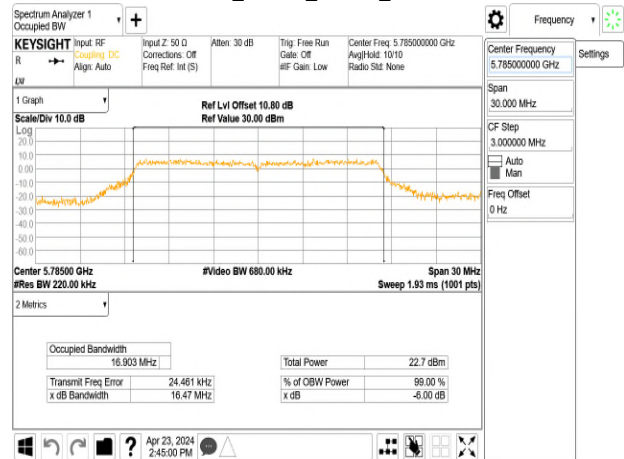

Unless otherwise stated the results shown in this test report refer only to the sample(s) tested and such sample(s) are retained for 90 days only.

除非另有說明，此報告結果僅對測試之樣品負責，同時此樣品僅保留90天。本報告未經本公司書面許可，不可部份複製。

This document is issued by the Company subject to its General Conditions of Service printed overleaf, available on request or accessible at <http://www.sgs.com.tw/Terms-and-Conditions>, and for electronic format documents, subject to Terms and Conditions for Electronic Documents at <http://www.sgs.com.tw/Terms-and-Conditions>. Attention is drawn to the limitation of liability, indemnification and jurisdiction issues defined therein. Any holder of this document is advised that information contained hereon reflects the Company's findings at the time of its intervention only and within the limits of Client's instructions, if any. The Company's sole responsibility is to its Client and this document does not exonerate parties to a transaction from exercising all their rights and obligations under the transaction documents. This document cannot be reproduced except in full, without prior written approval of the Company. Any unauthorized alteration, forgery or falsification of the content or appearance of this document is unlawful and offenders may be prosecuted to the fullest extent of the law.



802.11a\_20MHz\_Chain0\_5825MHz

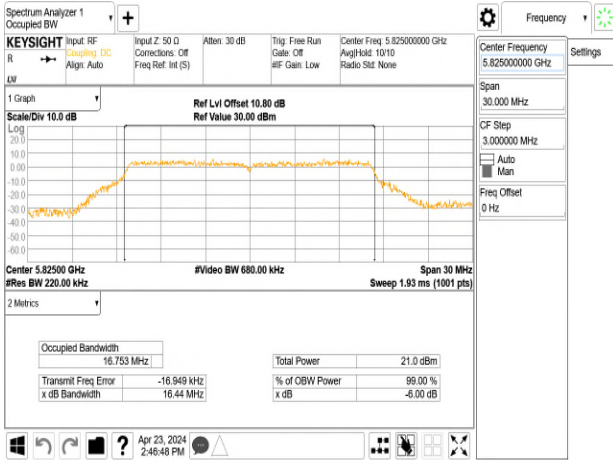

802.11n\_20MHz\_Chain0\_5240MHz

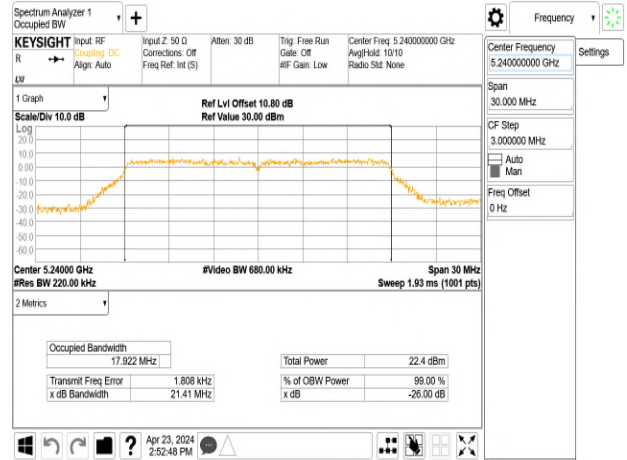

802.11n\_20MHz\_Chain0\_5180MHz

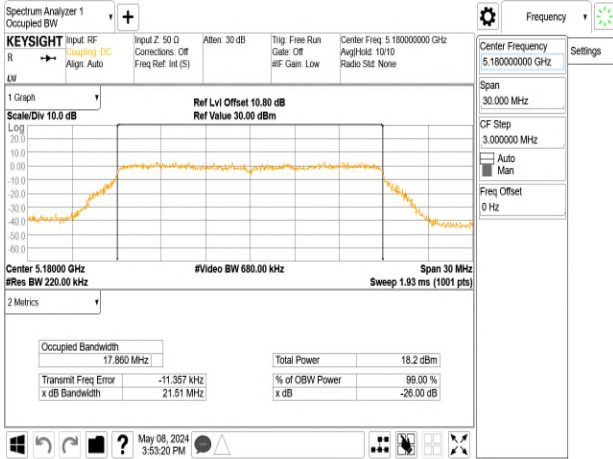

802.11n\_20MHz\_Chain0\_5260MHz

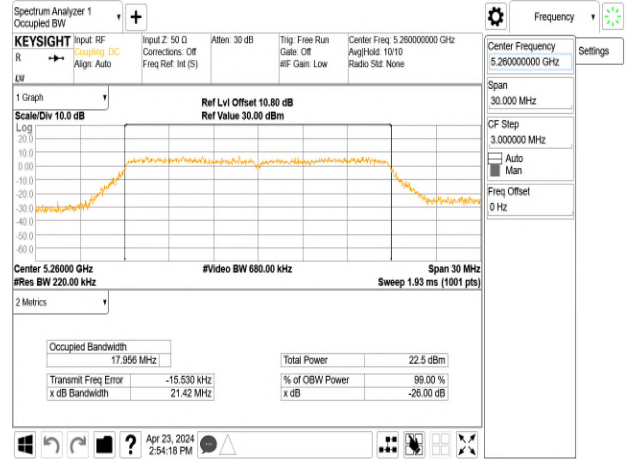

802.11n\_20MHz\_Chain0\_5220MHz

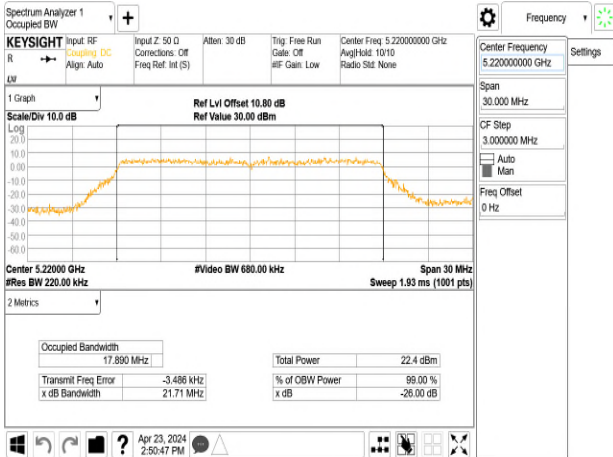

802.11n\_20MHz\_Chain0\_5300MHz

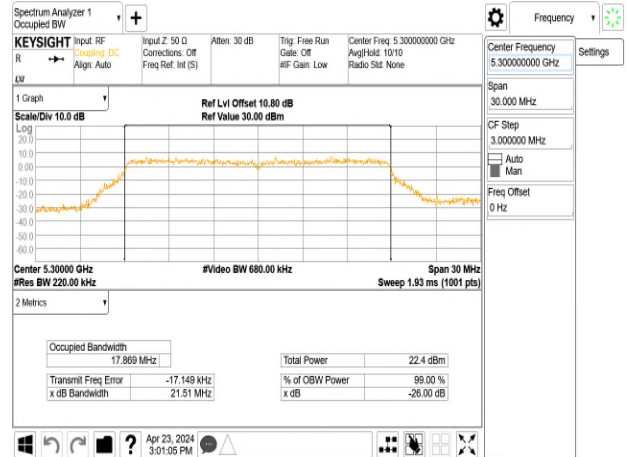

Unless otherwise stated the results shown in this test report refer only to the sample(s) tested and such sample(s) are retained for 90 days only.

除非另有說明，此報告結果僅對測試之樣品負責，同時此樣品僅保留90天。本報告未經本公司書面許可，不可部份複製。

This document is issued by the Company subject to its General Conditions of Service printed overleaf, available on request or accessible at <http://www.sgs.com.tw/Terms-and-Conditions>, and for electronic format documents, subject to Terms and Conditions for Electronic Documents at <http://www.sgs.com.tw/Terms-and-Conditions>. Attention is drawn to the limitation of liability, indemnification and jurisdiction issues defined therein. Any holder of this document is advised that information contained hereon reflects the Company's findings at the time of its intervention only and within the limits of Client's instructions, if any. The Company's sole responsibility is to its Client and this document does not exonerate parties to a transaction from exercising all their rights and obligations under the transaction documents. This document cannot be reproduced except in full, without prior written approval of the Company. Any unauthorized alteration, forgery or falsification of the content or appearance of this document is unlawful and offenders may be prosecuted to the fullest extent of the law.

802.11n\_20MHz\_Chain0\_5320MHz

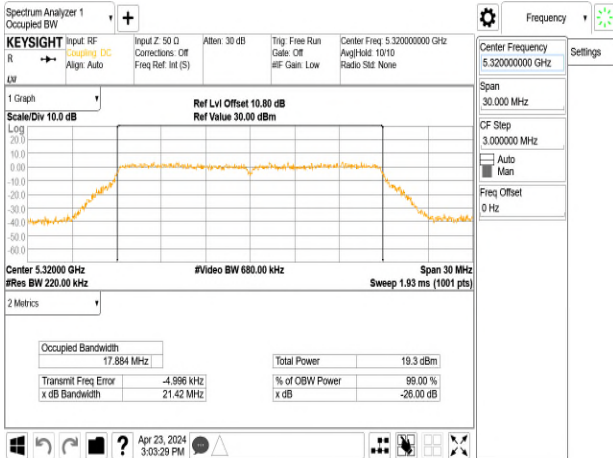

802.11n\_20MHz\_Chain0\_5700MHz

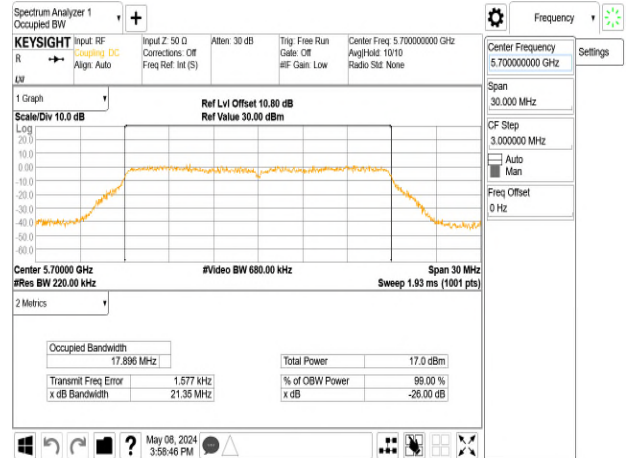

802.11n\_20MHz\_Chain0\_5500MHz

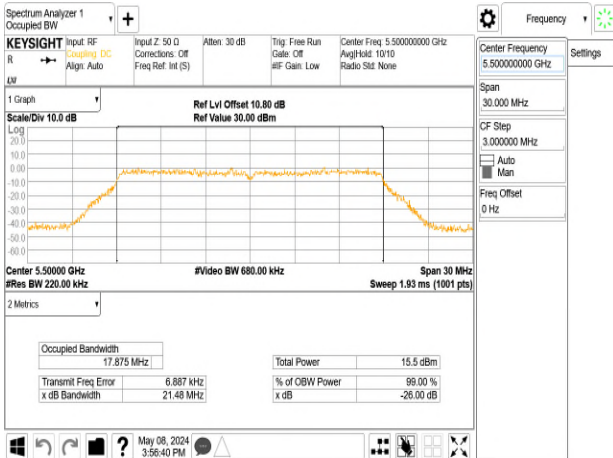

802.11n\_20MHz\_Chain0\_5720MHz

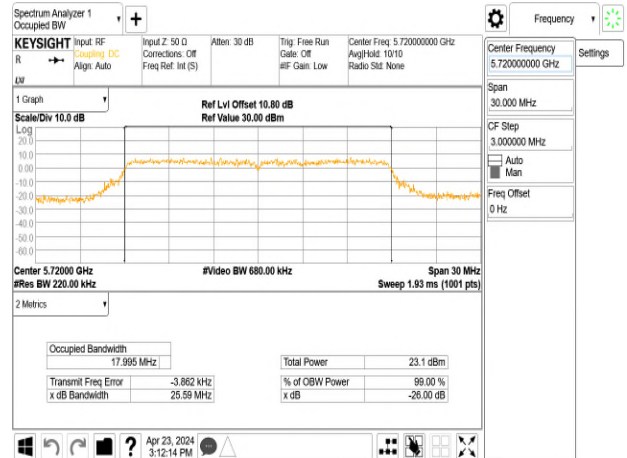

802.11n\_20MHz\_Chain0\_5580MHz

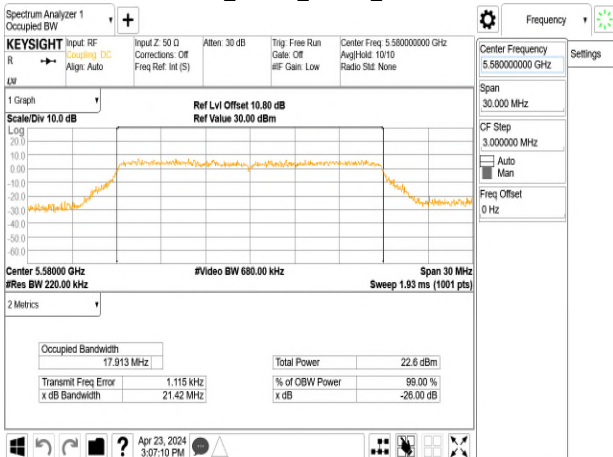

802.11n\_20MHz\_Chain0\_5745MHz

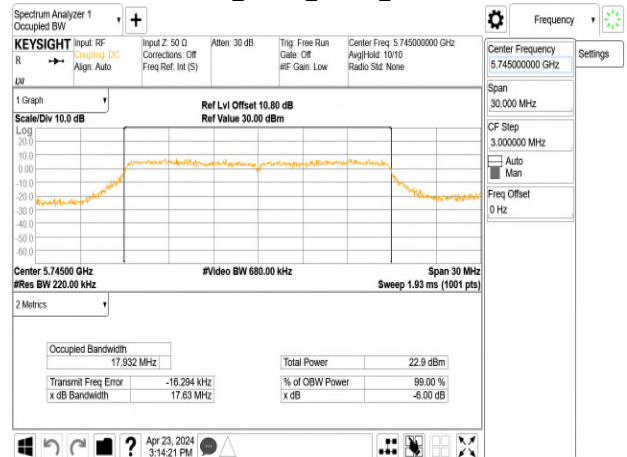

Unless otherwise stated the results shown in this test report refer only to the sample(s) tested and such sample(s) are retained for 90 days only.

除非另有說明，此報告結果僅對測試之樣品負責，同時此樣品僅保留90天。本報告未經本公司書面許可，不可部份複製。

This document is issued by the Company subject to its General Conditions of Service printed overleaf, available on request or accessible at <http://www.sgs.com.tw/Terms-and-Conditions>, and for electronic format documents, subject to Terms and Conditions for Electronic Documents at <http://www.sgs.com.tw/Terms-and-Conditions>. Attention is drawn to the limitation of liability, indemnification and jurisdiction issues defined therein. Any holder of this document is advised that information contained hereon reflects the Company's findings at the time of its intervention only and within the limits of Client's instructions, if any. The Company's sole responsibility is to its Client and this document does not exonerate parties to a transaction from exercising all their rights and obligations under the transaction documents. This document cannot be reproduced except in full, without prior written approval of the Company. Any unauthorized alteration, forgery or falsification of the content or appearance of this document is unlawful and offenders may be prosecuted to the fullest extent of the law.

802.11n\_20MHz\_Chain0\_5785MHz

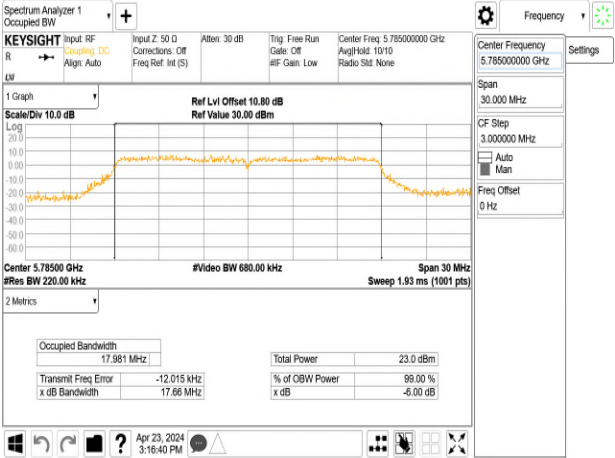

802.11n\_20MHz\_Chain0\_5825MHz

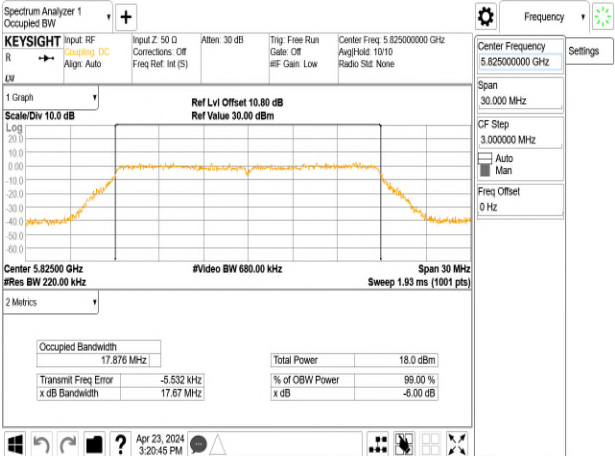

Unless otherwise stated the results shown in this test report refer only to the sample(s) tested and such sample(s) are retained for 90 days only.

除非另有說明，此報告結果僅對測試之樣品負責，同時此樣品僅保留90天。本報告未經本公司書面許可，不可部份複製。

This document is issued by the Company subject to its General Conditions of Service printed overleaf, available on request or accessible at <http://www.sgs.com.tw/Terms-and-Conditions>, and for electronic format documents, subject to Terms and Conditions for Electronic Documents at <http://www.sgs.com.tw/Terms-and-Conditions>. Attention is drawn to the limitation of liability, indemnification and jurisdiction issues defined therein. Any holder of this document is advised that information contained hereon reflects the Company's findings at the time of its intervention only and within the limits of Client's instructions, if any. The Company's sole responsibility is to its Client and this document does not exonerate parties to a transaction from exercising all their rights and obligations under the transaction documents. This document cannot be reproduced except in full, without prior written approval of the Company. Any unauthorized alteration, forgery or falsification of the content or appearance of this document is unlawful and offenders may be prosecuted to the fullest extent of the law.

## 9 MAXIMUM CONDUCTED OUTPUT POWER MEASUREMENT

### 9.1 Standard Applicable

#### 9.1.1 Duty Cycle

Pre-analysis Check: While conducting average power measurement, duty cycle of each mode shall be checked to ensure its duty cycle in order to compensate for the loss due to insufficient ratio of duty cycle.

All duty cycle is pre-scanned, and result as obtained below shows only the most representative ones where duty cycle is conducted as the given transmission with given virtual operation that expresses the percentage.

Unless otherwise stated the results shown in this test report refer only to the sample(s) tested and such sample(s) are retained for 90 days only.

除非另有說明，此報告結果僅對測試之樣品負責，同時此樣品僅保留90天。本報告未經本公司書面許可，不可部份複製。

This document is issued by the Company subject to its General Conditions of Service printed overleaf, available on request or accessible at <http://www.sgs.com.tw/Terms-and-Conditions> and for electronic format documents, subject to Terms and Conditions for Electronic Documents at <http://www.sgs.com.tw/Terms-and-Conditions>. Attention is drawn to the limitation of liability, indemnification and jurisdiction issues defined therein. Any holder of this document is advised that information contained hereon reflects the Company's findings at the time of its intervention only and within the limits of Client's instructions, if any. The Company's sole responsibility is to its Client and this document does not exonerate parties to a transaction from exercising all their rights and obligations under the transaction documents. This document cannot be reproduced except in full, without prior written approval of the Company. Any unauthorized alteration, forgery or falsification of the content or appearance of this document is unlawful and offenders may be prosecuted to the fullest extent of the law.

9.1.2 FCC

Band	EUT CATEGORY		e-CRF Title 47 §15.407			
			Conducted Output Power	EIRP	TPC	Antenna Directional Gain Requirements
U-NII-1		Fixed point-to-point	1 Watt(30dBm)	Not required	Not required	23dBi
		Outdoor AP	1 Watt(30dBm)	Elevation angle above 30 degrees 125mW (21dBm)	Not required	6dBi
		Indoor AP	1 Watt(30dBm)	Not required	Not required	6dBi
	V	Other	250mW(23.98dBm)	Not required	Not required	6dBi
U-NII-2A	V	Other	250mW(23.98dBm) or 11dBm+10 log B	Not required	When EIRP >500mW At least 6dB below EIRP 1W (30dBm)	6dBi
U-NII-2C	V	Other	250mW(23.98dBm) or 11dBm+10 log B	Not required		6dBi
U-NII-3	V	Other	1 Watt(30dBm)	Not required	Not required	6dBi
		Fixed point-to-point	1 Watt(30dBm)	Not required	Not required	Not required
U-NII-4		Indoor AP (a channel spans 5725~5850 and 5850~5895MHz)	Not required	36dBm	Not required	Not required
		indoor client (a channel spans 5725~5850 and 5850~5895MHz)	Not required	30dBm	Not required	Not required
		subordinate device	Not required	36dBm	Not required	Not required

1. If transmitting antennas of directional gain greater than the antenna requirements column, the Maximum transmit power shall be reduced by the amount in dB that the direction-al gain of the antenna.

2. For the 10 log B, B is the 26 dB emission bandwidth.

Unless otherwise stated the results shown in this test report refer only to the sample(s) tested and such sample(s) are retained for 90 days only.

除非另有說明，此報告結果僅對測試之樣品負責，同時此樣品僅保留90天。本報告未經本公司書面許可，不可部份複製。

This document is issued by the Company subject to its General Conditions of Service printed overleaf, available on request or accessible at <http://www.sgs.com.tw/Terms-and-Conditions> and for electronic format documents, subject to Terms and Conditions for Electronic Documents at <http://www.sgs.com.tw/Terms-and-Conditions>. Attention is drawn to the limitation of liability, indemnification and jurisdiction issues defined therein. Any holder of this document is advised that information contained hereon reflects the Company's findings at the time of its intervention only and within the limits of Client's instructions, if any. The Company's sole responsibility is to its Client and this document does not exonerate parties to a transaction from exercising all their rights and obligations under the transaction documents. This document cannot be reproduced except in full, without prior written approval of the Company. Any unauthorized alteration, forgery or falsification of the content or appearance of this document is unlawful and offenders may be prosecuted to the fullest extent of the law.



9.1.3 ISED

FREQUENCY BAND (MHz)	EUT CATEGORY		RSS-247 §6.2.1~6.2.4		
			EIRP	Conducted Output Power	TPC
5150~5250		OEM devices installed in vehicles	30 mW or $1.76 + 10 \log_{10}B$	N/A	At least 3dB below 30mW EIRP
	V	Other device	200 mW or $10 + 10 \log_{10}B$ dBm	N/A	N/A
5250~5350		OEM devices installed in vehicles	30 mW or $1.76 + 10 \log_{10}B$	N/A	At least 3dB below 30mW EIRP
	V	Other device	1.0 W or $17 + 10 \log_{10}B$ dBm	250 mW or $11 + 10 \log_{10}B$	EIRP >500mW, at least 6dB below 1W EIRP
		Outdoor Fixed with EIRP>200mW	$-13$ dBW/MHz for $0^\circ \leq \theta < 8^\circ$ $-13 - 0.716 (\theta - 8)$ dBW/MHz for $8^\circ \leq \theta < 40^\circ$ $-35.9 - 1.22 (\theta - 40)$ dBW/MHz for $40^\circ \leq \theta \leq 45^\circ$ $-42$ dBW/MHz for $\theta > 45^\circ$	N/A	EIRP >500mW, at least 6dB below 1W EIRP
5470-5600 and 5650-5725	V	All	1.0 W or $17 + 10 \log_{10}B$ dBm	250 mW or $11 + 10 \log_{10}B$	EIRP >500mW, at least 6dB below 1W EIRP
5725~5850	V	All	N/A	1 W	N/A

1 For equipment operating in the band 5725-5850 MHz, If transmitting antennas of directional gain greater than 6 dBi are used, the Maximum transmit power shall be reduced by the amount in dB that the directional gain of the antenna exceeds 6 dBi.  
2. For the 10 log B, B is the 99% emission bandwidth.

9.2 Test Setup

9.2.1 Duty Cycle

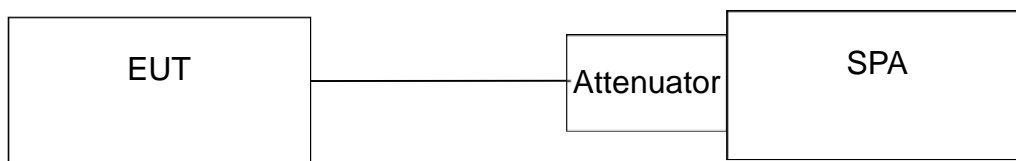

9.2.2 Output Power

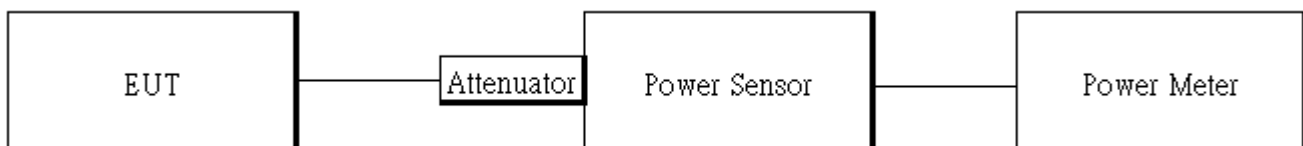

Unless otherwise stated the results shown in this test report refer only to the sample(s) tested and such sample(s) are retained for 90 days only.

除非另有說明，此報告結果僅對測試之樣品負責，同時此樣品僅保留90天。本報告未經本公司書面許可，不可部份複製。  
This document is issued by the Company subject to its General Conditions of Service printed overleaf, available on request or accessible at <http://www.sgs.com.tw/Terms-and-Conditions>, and for electronic format documents, subject to Terms and Conditions for Electronic Documents at <http://www.sgs.com.tw/Terms-and-Conditions>. Attention is drawn to the limitation of liability, indemnification and jurisdiction issues defined therein. Any holder of this document is advised that information contained hereon reflects the Company's findings at the time of its intervention only and within the limits of Client's instructions, if any. The Company's sole responsibility is to its Client and this document does not exonerate parties to a transaction from exercising all their rights and obligations under the transaction documents. This document cannot be reproduced except in full, without prior written approval of the Company. Any unauthorized alteration, forgery or falsification of the content or appearance of this document is unlawful and offenders may be prosecuted to the fullest extent of the law.

### 9.3 Measurement Procedure

#### 9.3.1 Duty Cycle Measurements

1. Set span = Zero
2. RBW = 8MHz
3. VBW = 8MHz,
4. Detector = Peak

#### 9.3.2 Output Power Measurements

1. Place the EUT on the table and set it in transmitting mode.
2. The testing follows FCC KDB 789033 D02 General UNII Test Procedures New Rules .
3. Remove the antenna from the EUT and then connect a low loss RF cable from the antenna port to the power meter
4. Power Meter is used as the auxiliary test equipment to conduct the output power measurement.
5. Record the max. reading and add 10 log(1/duty cycle).
6. Repeat above procedures until all frequency (low, middle, and high channel) measured were complete.

The antenna gain is not greater than 6 dBi. Therefore, reduction of power is not required.

### 9.4 Duty Cycle Measurement Result

Mode	Duty Cycle (%) =Ton / (Ton+Toff)	Duty Factor (dB) =10*log ( 1/Duty Cycle )	1/T (kHz)	VBW setting (kHz)
802.11a	98.07	0.08	0.70	0.01
802.11n_20	98.09	0.08	0.75	0.01
802.11ac_20	97.96	0.09	0.74	1.00

Unless otherwise stated the results shown in this test report refer only to the sample(s) tested and such sample(s) are retained for 90 days only.  
除非另有說明，此報告結果僅對測試之樣品負責，同時此樣品僅保留90天。本報告未經本公司書面許可，不可部份複製。

This document is issued by the Company subject to its General Conditions of Service printed overleaf, available on request or accessible at <http://www.sgs.com.tw/Terms-and-Conditions> and for electronic format documents, subject to Terms and Conditions for Electronic Documents at <http://www.sgs.com.tw/Terms-and-Conditions>. Attention is drawn to the limitation of liability, indemnification and jurisdiction issues defined therein. Any holder of this document is advised that information contained hereon reflects the Company's findings at the time of its intervention only and within the limits of Client's instructions, if any. The Company's sole responsibility is to its Client and this document does not exonerate parties to a transaction from exercising all their rights and obligations under the transaction documents. This document cannot be reproduced except in full, without prior written approval of the Company. Any unauthorized alteration, forgery or falsification of the content or appearance of this document is unlawful and offenders may be prosecuted to the fullest extent of the law.

802.11a\_20MHz\_Chain0\_5180MHz

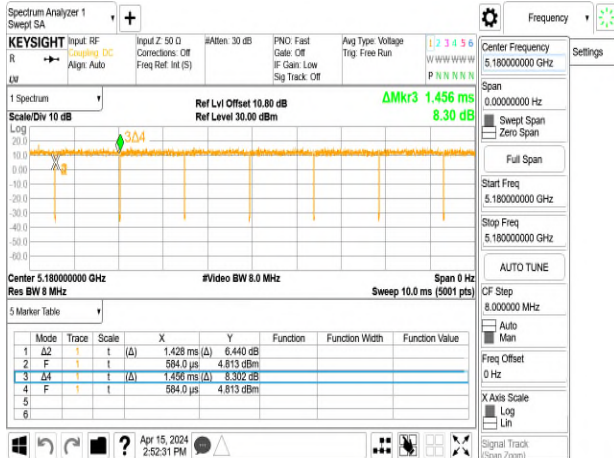

802.11n\_20MHz\_Chain0\_5180MHz

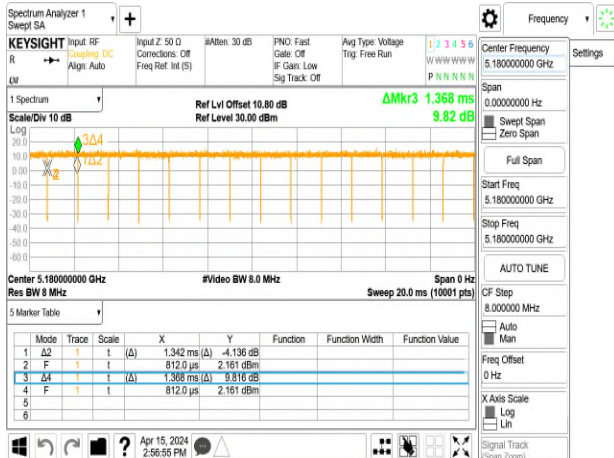

802.11ac\_20MHz\_Chain0\_5180MHz



Unless otherwise stated the results shown in this test report refer only to the sample(s) tested and such sample(s) are retained for 90 days only.

除非另有說明，此報告結果僅對測試之樣品負責，同時此樣品僅保留90天。本報告未經本公司書面許可，不可部份複製。

This document is issued by the Company subject to its General Conditions of Service printed overleaf, available on request or accessible at <http://www.sgs.com.tw/Terms-and-Conditions>, and for electronic format documents, subject to Terms and Conditions for Electronic Documents at <http://www.sgs.com.tw/Terms-and-Conditions>. Attention is drawn to the limitation of liability, indemnification and jurisdiction issues defined therein. Any holder of this document is advised that information contained hereon reflects the Company's findings at the time of its intervention only and within the limits of Client's instructions, if any. The Company's sole responsibility is to its Client and this document does not exonerate parties to a transaction from exercising all their rights and obligations under the transaction documents. This document cannot be reproduced except in full, without prior written approval of the Company. Any unauthorized alteration, forgery or falsification of the content or appearance of this document is unlawful and offenders may be prosecuted to the fullest extent of the law.



## 9.5 Output Power Measurement Result

### 9.5.1 FCC Output power

#### 802.11a\_Ch0

CH	Frequency (MHz)	Data Rate	Power Setting	TOTAL POWER (mW)	TOTAL POWER (dBm)	REQUIRED LIMIT (dBm)	RESULT
36	5180	6	57	24.517	13.89	23.98	PASS
44	5220	6	73	59.905	<b>17.77</b>	23.98	PASS
48	5240	6	73	59.630	17.75	23.98	PASS
52	5260	6	73	60.878	<b>17.84</b>	23.98	PASS
60	5300	6	73	60.320	17.80	23.98	PASS
64	5320	6	62	30.301	14.81	23.98	PASS
100	5500	6	55	19.430	12.88	23.98	PASS
116	5580	6	72	62.010	<b>17.92</b>	23.98	PASS
140	5700	6	54	19.791	12.96	23.98	PASS
144	5720(U-NII 2C)	6	75	43.263	16.36	23.98	PASS
144	5720 (U-NII 3)	6	75	18.605	12.70	30	PASS
149	5745	6	79	60.320	17.80	30	PASS
157	5785	6	79	61.019	<b>17.85</b>	30	PASS
165	5825	6	74	38.678	15.87	30	PASS

#### 802.11n\_HT20\_Ch0

CH	Frequency (MHz)	Data Rate	Power Setting	TOTAL POWER (mW)	TOTAL POWER (dBm)	REQUIRED LIMIT (dBm)	RESULT
36	5180	MCS0	56	24.910	13.96	23.98	PASS
44	5220	MCS0	73	59.755	17.76	23.98	PASS
48	5240	MCS0	73	60.031	<b>17.78</b>	23.98	PASS
52	5260	MCS0	73	61.288	<b>17.87</b>	23.98	PASS
60	5300	MCS0	73	60.586	17.82	23.98	PASS
64	5320	MCS0	62	30.576	14.85	23.98	PASS
100	5500	MCS0	46	12.370	10.92	23.98	PASS
116	5580	MCS0	72	61.713	<b>17.90</b>	23.98	PASS
140	5700	MCS0	53	19.560	12.91	23.98	PASS
144	5720(U-NII 2C)	MCS0	75	43.841	16.42	23.98	PASS
144	5720 (U-NII 3)	MCS0	75	18.300	12.62	30	PASS
149	5745	MCS0	79	60.586	<b>17.82</b>	30	PASS
157	5785	MCS0	79	60.169	17.79	30	PASS
165	5825	MCS0	63	24.682	13.92	30	PASS

Unless otherwise stated the results shown in this test report refer only to the sample(s) tested and such sample(s) are retained for 90 days only.

除非另有說明，此報告結果僅對測試之樣品負責，同時此樣品僅保留90天。本報告未經本公司書面許可，不可部份複製。

This document is issued by the Company subject to its General Conditions of Service printed overleaf, available on request or accessible at <http://www.sgs.com.tw/Terms-and-Conditions> and for electronic format documents, subject to Terms and Conditions for Electronic Documents at <http://www.sgs.com.tw/Terms-and-Conditions>. Attention is drawn to the limitation of liability, indemnification and jurisdiction issues defined therein. Any holder of this document is advised that information contained hereon reflects the Company's findings at the time of its intervention only and within the limits of Client's instructions, if any. The Company's sole responsibility is to its Client and this document does not exonerate parties to a transaction from exercising all their rights and obligations under the transaction documents. This document cannot be reproduced except in full, without prior written approval of the Company. Any unauthorized alteration, forgery or falsification of the content or appearance of this document is unlawful and offenders may be prosecuted to the fullest extent of the law.

802.11ac\_VHT20\_Ch0

CH	Frequency (MHz)	Data Rate	Power Setting	TOTAL POWER (mW)	TOTAL POWER (dBm)	REQUIRED LIMIT (dBm)	RESULT
36	5180	MCS0	56	24.489	13.89	23.98	PASS
44	5220	MCS0	73	57.819	17.62	23.98	PASS
48	5240	MCS0	73	59.152	<b>17.72</b>	23.98	PASS
52	5260	MCS0	73	60.252	<b>17.80</b>	23.98	PASS
60	5300	MCS0	73	59.425	17.74	23.98	PASS
64	5320	MCS0	62	29.852	14.75	23.98	PASS
100	5500	MCS0	46	12.189	10.86	23.98	PASS
116	5580	MCS0	72	60.099	<b>17.79</b>	23.98	PASS
140	5700	MCS0	53	19.363	12.87	23.98	PASS
144	5720(U-NII 2C)	MCS0	75	42.410	16.27	23.98	PASS
144	5720 (U-NII 3)	MCS0	75	17.703	12.48	30	PASS
149	5745	MCS0	79	59.837	<b>17.77</b>	30	PASS
157	5785	MCS0	79	58.610	17.68	30	PASS
165	5825	MCS0	63	24.320	13.86	30	PASS

Unless otherwise stated the results shown in this test report refer only to the sample(s) tested and such sample(s) are retained for 90 days only.

除非另有說明，此報告結果僅對測試之樣品負責，同時此樣品僅保留90天。本報告未經本公司書面許可，不可部份複製。

This document is issued by the Company subject to its General Conditions of Service printed overleaf, available on request or accessible at <http://www.sgs.com.tw/Terms-and-Conditions> and for electronic format documents, subject to Terms and Conditions for Electronic Documents at <http://www.sgs.com.tw/Terms-and-Conditions>. Attention is drawn to the limitation of liability, indemnification and jurisdiction issues defined therein. Any holder of this document is advised that information contained hereon reflects the Company's findings at the time of its intervention only and within the limits of Client's instructions, if any. The Company's sole responsibility is to its Client and this document does not exonerate parties to a transaction from exercising all their rights and obligations under the transaction documents. This document cannot be reproduced except in full, without prior written approval of the Company. Any unauthorized alteration, forgery or falsification of the content or appearance of this document is unlawful and offenders may be prosecuted to the fullest extent of the law.

## 9.5.2 ISED Conducted output power and EIRP

## 802.11a\_Ch0

CH	Frequency (MHz)	TOTAL POWER (mW)	TOTAL POWER (dBm)	REQUIRED LIMIT (dBm)	RESULT
52	5260	<b>60.878</b>	<b>17.84</b>	23.24	PASS
60	5300	60.320	17.80	23.25	PASS
64	5320	30.301	14.81	23.23	PASS
100	5500	19.430	12.88	23.24	PASS
116	5580	<b>62.010</b>	<b>17.92</b>	23.25	PASS
140	5700	19.791	12.96	23.26	PASS
144	5720(U-NII 2C)	43.263	16.36	22.29	PASS
144	5720 (U-NII 3)	18.605	12.70	30	PASS
149	5745	60.320	17.80	30	PASS
157	5785	<b>61.019</b>	<b>17.85</b>	30	PASS
165	5825	38.678	15.87	30	PASS

## 802.11n\_HT20\_Ch0

CH	Frequency (MHz)	TOTAL POWER (mW)	TOTAL POWER (dBm)	REQUIRED LIMIT (dBm)	RESULT
52	5260	<b>61.288</b>	<b>17.87</b>	23.54	PASS
60	5300	60.586	17.82	23.52	PASS
64	5320	30.576	14.85	23.52	PASS
100	5500	12.370	10.92	23.52	PASS
116	5580	<b>61.713</b>	<b>17.90</b>	23.53	PASS
140	5700	19.560	12.91	23.53	PASS
144	5720(U-NII 2C)	43.841	16.42	22.46	PASS
144	5720 (U-NII 3)	18.300	12.62	30	PASS
149	5745	<b>60.586</b>	<b>17.82</b>	30	PASS
157	5785	60.169	17.79	30	PASS
165	5825	24.682	13.92	30	PASS

Unless otherwise stated the results shown in this test report refer only to the sample(s) tested and such sample(s) are retained for 90 days only.

除非另有說明，此報告結果僅對測試之樣品負責，同時此樣品僅保留90天。本報告未經本公司書面許可，不可部份複製。

This document is issued by the Company subject to its General Conditions of Service printed overleaf, available on request or accessible at <http://www.sgs.com.tw/Terms-and-Conditions> and for electronic format documents, subject to Terms and Conditions for Electronic Documents at <http://www.sgs.com.tw/Terms-and-Conditions>. Attention is drawn to the limitation of liability, indemnification and jurisdiction issues defined therein. Any holder of this document is advised that information contained hereon reflects the Company's findings at the time of its intervention only and within the limits of Client's instructions, if any. The Company's sole responsibility is to its Client and this document does not exonerate parties to a transaction from exercising all their rights and obligations under the transaction documents. This document cannot be reproduced except in full, without prior written approval of the Company. Any unauthorized alteration, forgery or falsification of the content or appearance of this document is unlawful and offenders may be prosecuted to the fullest extent of the law.

802.11ac\_VHT20\_Ch0

CH	Frequency (MHz)	TOTAL POWER (mW)	TOTAL POWER (dBm)	REQUIRED LIMIT (dBm)	RESULT
52	5260	<b>60.252</b>	<b>17.80</b>	23.54	PASS
60	5300	59.425	17.74	23.52	PASS
64	5320	29.852	14.75	23.52	PASS
100	5500	12.189	10.86	23.52	PASS
116	5580	<b>60.099</b>	<b>17.79</b>	23.53	PASS
140	5700	19.363	12.87	23.53	PASS
144	5720(U-NII 2C)	42.410	16.27	22.46	PASS
144	5720 (U-NII 3)	17.703	12.48	30	PASS
149	5745	<b>59.837</b>	<b>17.77</b>	30	PASS
157	5785	58.610	17.68	30	PASS
165	5825	24.320	13.86	30	PASS

Unless otherwise stated the results shown in this test report refer only to the sample(s) tested and such sample(s) are retained for 90 days only.

除非另有說明，此報告結果僅對測試之樣品負責，同時此樣品僅保留90天。本報告未經本公司書面許可，不可部份複製。

This document is issued by the Company subject to its General Conditions of Service printed overleaf, available on request or accessible at <http://www.sgs.com.tw/Terms-and-Conditions> and for electronic format documents, subject to Terms and Conditions for Electronic Documents at <http://www.sgs.com.tw/Terms-and-Conditions>. Attention is drawn to the limitation of liability, indemnification and jurisdiction issues defined therein. Any holder of this document is advised that information contained hereon reflects the Company's findings at the time of its intervention only and within the limits of Client's instructions, if any. The Company's sole responsibility is to its Client and this document does not exonerate parties to a transaction from exercising all their rights and obligations under the transaction documents. This document cannot be reproduced except in full, without prior written approval of the Company. Any unauthorized alteration, forgery or falsification of the content or appearance of this document is unlawful and offenders may be prosecuted to the fullest extent of the law.

802.11a\_Ch0

CH	Frequency (MHz)	TOTAL POWER (dBm)	Antenna Gain (dBi)	EIRP (mW)	EIRP (dBm)	REQUIRED LIMIT (dBm)	RESULT
36	5180	13.89	2.00	38.815	15.89	22.24	PASS
44	5220	<b>17.77</b>	2.00	<b>94.842</b>	<b>19.77</b>	22.25	PASS
48	5240	17.75	2.00	94.406	19.75	22.27	PASS
52	5260	<b>17.84</b>	2.00	<b>96.383</b>	<b>19.84</b>	29.24	PASS
60	5300	17.80	2.00	95.499	19.80	29.25	PASS
64	5320	14.81	2.00	47.973	16.81	29.23	PASS
100	5500	12.88	2.00	30.761	14.88	29.24	PASS
116	5580	<b>17.92</b>	2.00	<b>98.175</b>	<b>19.92</b>	29.25	PASS
140	5700	<b>12.96</b>	2.00	<b>31.333</b>	<b>14.96</b>	29.26	PASS

802.11n\_HT20\_Ch0

CH	Frequency (MHz)	TOTAL POWER (dBm)	Antenna Gain (dBi)	EIRP (mW)	EIRP (dBm)	REQUIRED LIMIT (dBm)	RESULT
36	5180	13.96	2.00	39.446	15.96	22.52	PASS
44	5220	17.76	2.00	94.624	19.76	22.53	PASS
48	5240	<b>17.78</b>	2.00	<b>95.060</b>	<b>19.78</b>	22.53	PASS
52	5260	<b>17.87</b>	2.00	<b>97.051</b>	<b>19.87</b>	29.54	PASS
60	5300	17.82	2.00	95.940	19.82	29.52	PASS
64	5320	14.85	2.00	48.417	16.85	29.52	PASS
100	5500	10.92	2.00	19.588	12.92	29.52	PASS
116	5580	<b>17.90</b>	2.00	<b>97.724</b>	<b>19.90</b>	29.53	PASS
140	5700	<b>12.91</b>	2.00	<b>30.974</b>	<b>14.91</b>	29.53	PASS

802.11ac\_VHT20\_Ch0

CH	Frequency (MHz)	TOTAL POWER (dBm)	Antenna Gain (dBi)	EIRP (mW)	EIRP (dBm)	REQUIRED LIMIT (dBm)	RESULT
36	5180	13.89	2.00	38.815	15.89	22.52	PASS
44	5220	17.62	2.00	91.622	19.62	22.53	PASS
48	5240	<b>17.72</b>	2.00	<b>93.756</b>	<b>19.72</b>	22.53	PASS
52	5260	<b>17.80</b>	2.00	<b>95.499</b>	<b>19.80</b>	29.54	PASS
60	5300	17.74	2.00	94.189	19.74	29.52	PASS
64	5320	14.75	2.00	47.315	16.75	29.52	PASS
100	5500	10.86	2.00	19.320	12.86	29.52	PASS
116	5580	<b>17.79</b>	2.00	<b>95.280</b>	<b>19.79</b>	29.53	PASS
140	5700	<b>12.87</b>	2.00	<b>30.690</b>	<b>14.87</b>	29.53	PASS

Unless otherwise stated the results shown in this test report refer only to the sample(s) tested and such sample(s) are retained for 90 days only.

除非另有說明，此報告結果僅對測試之樣品負責，同時此樣品僅保留90天。本報告未經本公司書面許可，不可部份複製。

This document is issued by the Company subject to its General Conditions of Service printed overleaf, available on request or accessible at <http://www.sgs.com.tw/Terms-and-Conditions> and for electronic format documents, subject to Terms and Conditions for Electronic Documents at <http://www.sgs.com.tw/Terms-and-Conditions>. Attention is drawn to the limitation of liability, indemnification and jurisdiction issues defined therein. Any holder of this document is advised that information contained hereon reflects the Company's findings at the time of its intervention only and within the limits of Client's instructions, if any. The Company's sole responsibility is to its Client and this document does not exonerate parties to a transaction from exercising all their rights and obligations under the transaction documents. This document cannot be reproduced except in full, without prior written approval of the Company. Any unauthorized alteration, forgery or falsification of the content or appearance of this document is unlawful and offenders may be prosecuted to the fullest extent of the law.

## 10 MAXIMUM POWER SPECTRAL DENSITY

### 10.1 FCC Standard

Operation Bands	EUT CATEGORY		e-CRF Title 47 §15.407 Power Spectral Density	Antenna Directional Gain Requirements
U-NII-1		Outdoor Access Point (Master)	1. 17dBm/ MHz 2. EIRP<=125mW(21dBm) at any elevation angle > 30°	6dBi
		Indoor Access Point (Master)	17dBm / MHz	6dBi
		Fixed point-to-point Access Ponit	17dBm / MHz	23dBi
	V	Client device	11dBm / MHz	6dBi
U-NII-2A	V	All	11dBm / MHz	6dBi
U-NII-2C	V	All	11dBm / MHz	6dBi
U-NII-3	V	All	30dBm / 500kHz	6dBi
U-NII-4		Indoor AP	20dBm / MHz e.i.r.p.	Not required
		indoor client	14dBm / MHz e.i.r.p.	Not required
		subordinate device	20dBm / MHz e.i.r.p.	Not required
<p>If transmitting antennas of directional gain greater than the antenna requirements column, the Maximum transmit power shall be reduced by the amount in dB that the direction-al gain of the antenna.</p>				

Unless otherwise stated the results shown in this test report refer only to the sample(s) tested and such sample(s) are retained for 90 days only.

除非另有說明，此報告結果僅對測試之樣品負責，同時此樣品僅保留90天。本報告未經本公司書面許可，不可部份複製。

This document is issued by the Company subject to its General Conditions of Service printed overleaf, available on request or accessible at <http://www.sgs.com.tw/Terms-and-Conditions> and for electronic format documents, subject to Terms and Conditions for Electronic Documents at <http://www.sgs.com.tw/Terms-and-Conditions>. Attention is drawn to the limitation of liability, indemnification and jurisdiction issues defined therein. Any holder of this document is advised that information contained hereon reflects the Company's findings at the time of its intervention only and within the limits of Client's instructions, if any. The Company's sole responsibility is to its Client and this document does not exonerate parties to a transaction from exercising all their rights and obligations under the transaction documents. This document cannot be reproduced except in full, without prior written approval of the Company. Any unauthorized alteration, forgery or falsification of the content or appearance of this document is unlawful and offenders may be prosecuted to the fullest extent of the law.

### 10.2 ISED Standard

FREQUENCY BAND (MHz)	EUT CATEGORY		RSS-247 §6.2.1~6.2.4	
			EIRP Density	Power Density
5150~5250		OEM devices installed in vehicles	N/A	N/A
	V	Other device	10 dBm/MHz	N/A
5250~5350		OEM devices installed in vehicles	N/A	N/A
	V	Other device	N/A	11 dBm/MHz
5470-5600 and 5650-5725	V	All	N/A	11 dBm/MHz
5725~5850	V	All	N/A	30 dBm/500kHz

For equipment operating in the band 5725-5850 MHz, If transmitting antennas of directional gain greater than 6 dBi are used, the Maximum transmit power shall be reduced by the amount in dB that the directional gain of the antenna exceeds 6 dBi.

### 10.3 Test Setup

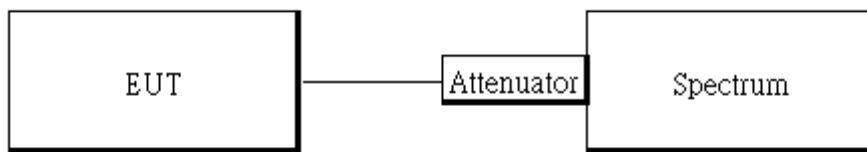

Unless otherwise stated the results shown in this test report refer only to the sample(s) tested and such sample(s) are retained for 90 days only.

除非另有說明，此報告結果僅對測試之樣品負責，同時此樣品僅保留90天。本報告未經本公司書面許可，不可部份複製。

This document is issued by the Company subject to its General Conditions of Service printed overleaf, available on request or accessible at <http://www.sgs.com.tw/Terms-and-Conditions> and for electronic format documents, subject to Terms and Conditions for Electronic Documents at <http://www.sgs.com.tw/Terms-and-Conditions>. Attention is drawn to the limitation of liability, indemnification and jurisdiction issues defined therein. Any holder of this document is advised that information contained hereon reflects the Company's findings at the time of its intervention only and within the limits of Client's instructions, if any. The Company's sole responsibility is to its Client and this document does not exonerate parties to a transaction from exercising all their rights and obligations under the transaction documents. This document cannot be reproduced except in full, without prior written approval of the Company. Any unauthorized alteration, forgery or falsification of the content or appearance of this document is unlawful and offenders may be prosecuted to the fullest extent of the law.



## 10.4 Measurement Procedure

1. Place the EUT on the table and set it in transmitting mode.
2. The testing follows FCC KDB 789033 D02 General UNII Test Procedures New Rules .
3. Remove the antenna from the EUT and then connect a low loss RF cable from the antenna port to Spectrum.
4. **For U-NII1, U-NII-2A, U-NII-2C Band:**  
Set RBW=1MHz, VBW=3MHz, where span is enough to capture the entire bandwidth, Sweep time = Auto (1001 pts), Detector = power averaging (rms), if available. Otherwise, use sample detector mode, traces 100 sweeps of video averaging. (SA-2 with the omission of procedure x, the integration with 26dB EBW bandwidth)  
**For U-NII-3 Band:**  
Set RBW=300kHz, VBW=1MHz, where span is enough to capture the entire bandwidth, Sweep time = Auto, detector = RMS or sample, traces 100 sweeps of video averaging.  
In addition, measurement bandwidth of Maximum PSD is specified in 500 kHz, add  $10 \log(500 \text{ kHz/RBW})$  to the measured result.
5. Use the cursor on spectrum to peak search the highest level of trace
6. (1)Duty cycle  $\geq 98\%$  : Record the max. reading.  
(2)Duty cycle  $< 98\%$  : Record the max. reading and add  $10 \log(1/\text{duty cycle})$ .
7. Repeat above procedures until all default test channel (low, middle, and high) was complete.

The antenna gain is not greater than 6 dBi. Therefore, reduction of power is not required.

Unless otherwise stated the results shown in this test report refer only to the sample(s) tested and such sample(s) are retained for 90 days only.  
除非另有說明，此報告結果僅對測試之樣品負責，同時此樣品僅保留90天。本報告未經本公司書面許可，不可部份複製。

This document is issued by the Company subject to its General Conditions of Service printed overleaf, available on request or accessible at <http://www.sgs.com.tw/Terms-and-Conditions>, and for electronic format documents, subject to Terms and Conditions for Electronic Documents at <http://www.sgs.com.tw/Terms-and-Conditions>. Attention is drawn to the limitation of liability, indemnification and jurisdiction issues defined therein. Any holder of this document is advised that information contained hereon reflects the Company's findings at the time of its intervention only and within the limits of Client's instructions, if any. The Company's sole responsibility is to its Client and this document does not exonerate parties to a transaction from exercising all their rights and obligations under the transaction documents. This document cannot be reproduced except in full, without prior written approval of the Company. Any unauthorized alteration, forgery or falsification of the content or appearance of this document is unlawful and offenders may be prosecuted to the fullest extent of the law.

## 10.5 Measurement Result

POWER DENSITY 802.11a MODE						
Frequency (MHz)	Ch0 meas PSD (dBm/MHz)	Duty Factor (dB)	Maxmum Corr'd PSD(dBm/MHz)		Limit	Margin (dB)
5180	3.189	0.00	3.19		11.00 dBm/MHz	-7.81
5220	7.143	0.00	7.14		11.00 dBm/MHz	-3.86
5240	6.852	0.00	6.85		11.00 dBm/MHz	-4.15
5260	6.959	0.00	6.96		11.00 dBm/MHz	-4.04
5300	6.643	0.00	6.64		11.00 dBm/MHz	-4.36
5320	3.435	0.00	3.44		11.00 dBm/MHz	-7.57
5500	1.838	0.00	1.84		11.00 dBm/MHz	-9.16
5580	6.944	0.00	6.94		11.00 dBm/MHz	-4.06
5700	1.984	0.00	1.98		11.00 dBm/MHz	-9.02
5720 (U-NII 2C)	7.226	0.00	7.23		11.00 dBm/MHz	-3.77
Frequency (MHz)	Ch0 meas PSD (dBm/300kHz)	Duty Factor (dB)	10log (500kHz/RBW) Factor(dB)	Maxmum Corr'd PSD (dBm/500kHz)	Limit	Margin (dB)
5720 (U-NII 3)	2.232	0.00	2.22	4.45	30.00 dBm/500kHz	-25.55
5745	1.852	0.00	2.22	4.07	30.00 dBm/500kHz	-25.93
5785	2.326	0.00	2.22	4.55	30.00 dBm/500kHz	-25.45
5825	0.429	0.00	2.22	2.65	30.00 dBm/500kHz	-27.35
POWER DENSITY 802.11n HT20 MODE						
Frequency (MHz)	Ch0 meas PSD (dBm/MHz)	Duty Factor (dB)	Maxmum Corr'd PSD(dBm/MHz)		Limit	Margin (dB)
5180	2.652	0.00	2.65		11.00 dBm/MHz	-8.35
5220	6.642	0.00	6.64		11.00 dBm/MHz	-4.36
5240	6.560	0.00	6.56		11.00 dBm/MHz	-4.44
5260	6.504	0.00	6.50		11.00 dBm/MHz	-4.50
5300	6.155	0.00	6.16		11.00 dBm/MHz	-4.85
5320	3.329	0.00	3.33		11.00 dBm/MHz	-7.67
5500	-0.030	0.00	-0.03		11.00 dBm/MHz	-11.03
5580	6.871	0.00	6.87		11.00 dBm/MHz	-4.13
5700	1.381	0.00	1.38		11.00 dBm/MHz	-9.62
5720 (U-NII 2C)	7.181	0.00	7.18		11.00 dBm/MHz	-3.82
Frequency (MHz)	Ch0 meas PSD (dBm/300kHz)	Duty Factor (dB)	10log (500kHz/RBW) Factor(dB)	Maxmum Corr'd PSD (dBm/500kHz)	Limit	Margin (dB)
5720 (U-NII 3)	2.113	0.00	2.22	4.33	30.00 dBm/500kHz	-25.67
5745	1.792	0.00	2.22	4.01	30.00 dBm/500kHz	-25.99
5785	2.148	0.00	2.22	4.37	30.00 dBm/500kHz	-25.63
5825	-3.049	0.00	2.22	-0.83	30.00 dBm/500kHz	-30.83

Unless otherwise stated the results shown in this test report refer only to the sample(s) tested and such sample(s) are retained for 90 days only.

除非另有說明，此報告結果僅對測試之樣品負責，同時此樣品僅保留90天。本報告未經本公司書面許可，不可部份複製。

This document is issued by the Company subject to its General Conditions of Service printed overleaf, available on request or accessible at <http://www.sgs.com.tw/Terms-and-Conditions>, and for electronic format documents, subject to Terms and Conditions for Electronic Documents at <http://www.sgs.com.tw/Terms-and-Conditions>. Attention is drawn to the limitation of liability, indemnification and jurisdiction issues defined therein. Any holder of this document is advised that information contained hereon reflects the Company's findings at the time of its intervention only and within the limits of Client's instructions, if any. The Company's sole responsibility is to its Client and this document does not exonerate parties to a transaction from exercising all their rights and obligations under the transaction documents. This document cannot be reproduced except in full, without prior written approval of the Company. Any unauthorized alteration, forgery or falsification of the content or appearance of this document is unlawful and offenders may be prosecuted to the fullest extent of the law.

EIRP spectral density 802.11a MODE					
Freq. (MHz)	PSD (dBm)	Ant. Gain (dBi)	EIRP PSD (dBm)	Limit (dBm)	Margin (dB)
5180	3.189	2.00	5.19	10	-4.81
5220	7.143	2.00	9.14	10	-0.86
5240	6.852	2.00	8.85	10	-1.15
EIRP spectral density 802.11n HT20 MODE					
Freq. (MHz)	PSD (dBm)	Ant. Gain (dBi)	EIRP PSD (dBm)	Limit (dBm)	Margin (dB)
5180	2.652	2.00	4.65	10	-5.35
5220	6.642	2.00	8.64	10	-1.36
5240	6.560	2.00	8.56	10	-1.44

Unless otherwise stated the results shown in this test report refer only to the sample(s) tested and such sample(s) are retained for 90 days only.

除非另有說明，此報告結果僅對測試之樣品負責，同時此樣品僅保留90天。本報告未經本公司書面許可，不可部份複製。

This document is issued by the Company subject to its General Conditions of Service printed overleaf, available on request or accessible at <http://www.sgs.com.tw/Terms-and-Conditions> and for electronic format documents, subject to Terms and Conditions for Electronic Documents at <http://www.sgs.com.tw/Terms-and-Conditions>. Attention is drawn to the limitation of liability, indemnification and jurisdiction issues defined therein. Any holder of this document is advised that information contained hereon reflects the Company's findings at the time of its intervention only and within the limits of Client's instructions, if any. The Company's sole responsibility is to its Client and this document does not exonerate parties to a transaction from exercising all their rights and obligations under the transaction documents. This document cannot be reproduced except in full, without prior written approval of the Company. Any unauthorized alteration, forgery or falsification of the content or appearance of this document is unlawful and offenders may be prosecuted to the fullest extent of the law.

802.11a\_20MHz\_Chain0\_5180MHz



802.11a\_20MHz\_Chain0\_5260MHz



802.11a\_20MHz\_Chain0\_5220MHz



802.11a\_20MHz\_Chain0\_5300MHz



802.11a\_20MHz\_Chain0\_5240MHz



802.11a\_20MHz\_Chain0\_5320MHz

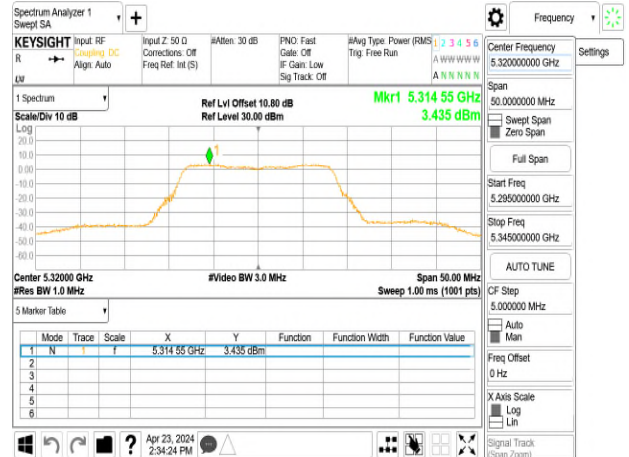

Unless otherwise stated the results shown in this test report refer only to the sample(s) tested and such sample(s) are retained for 90 days only.

除非另有說明，此報告結果僅對測試之樣品負責，同時此樣品僅保留90天。本報告未經本公司書面許可，不可部份複製。

This document is issued by the Company subject to its General Conditions of Service printed overleaf, available on request or accessible at <http://www.sgs.com.tw/Terms-and-Conditions> and for electronic format documents, subject to Terms and Conditions for Electronic Documents at <http://www.sgs.com.tw/Terms-and-Conditions>. Attention is drawn to the limitation of liability, indemnification and jurisdiction issues defined therein. Any holder of this document is advised that information contained hereon reflects the Company's findings at the time of its intervention only and within the limits of Client's instructions, if any. The Company's sole responsibility is to its Client and this document does not exonerate parties to a transaction from exercising all their rights and obligations under the transaction documents. This document cannot be reproduced except in full, without prior written approval of the Company. Any unauthorized alteration, forgery or falsification of the content or appearance of this document is unlawful and offenders may be prosecuted to the fullest extent of the law.



802.11a\_20MHz\_Chain0\_5500MHz



802.11a\_20MHz\_Chain0\_5720MHz\_UNII 2C



802.11a\_20MHz\_Chain0\_5580MHz



802.11a\_20MHz\_Chain0\_5720MHz\_UNII 3



802.11a\_20MHz\_Chain0\_5700MHz



802.11a\_20MHz\_Chain0\_5745MHz



Unless otherwise stated the results shown in this test report refer only to the sample(s) tested and such sample(s) are retained for 90 days only.

除非另有說明，此報告結果僅對測試之樣品負責，同時此樣品僅保留90天。本報告未經本公司書面許可，不可部份複製。

This document is issued by the Company subject to its General Conditions of Service printed overleaf, available on request or accessible at <http://www.sgs.com.tw/Terms-and-Conditions>, and for electronic format documents, subject to Terms and Conditions for Electronic Documents at <http://www.sgs.com.tw/Terms-and-Conditions>. Attention is drawn to the limitation of liability, indemnification and jurisdiction issues defined therein. Any holder of this document is advised that information contained hereon reflects the Company's findings at the time of its intervention only and within the limits of Client's instructions, if any. The Company's sole responsibility is to its Client and this document does not exonerate parties to a transaction from exercising all their rights and obligations under the transaction documents. This document cannot be reproduced except in full, without prior written approval of the Company. Any unauthorized alteration, forgery or falsification of the content or appearance of this document is unlawful and offenders may be prosecuted to the fullest extent of the law.

802.11a\_20MHz\_Chain0\_5785MHz



802.11n\_20MHz\_Chain0\_5220MHz



802.11a\_20MHz\_Chain0\_5825MHz



802.11n\_20MHz\_Chain0\_5240MHz



802.11n\_20MHz\_Chain0\_5180MHz



802.11n\_20MHz\_Chain0\_5260MHz

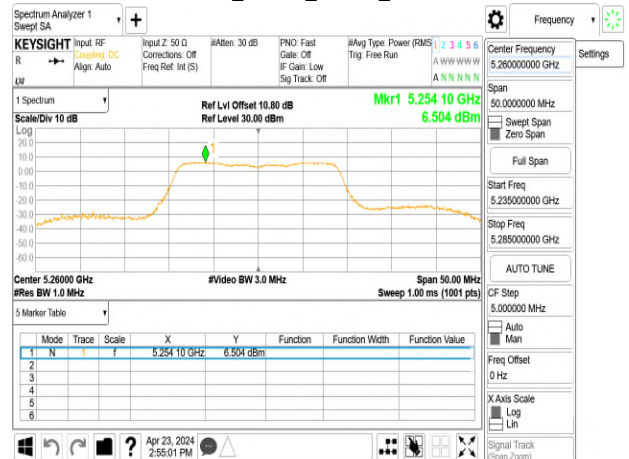

Unless otherwise stated the results shown in this test report refer only to the sample(s) tested and such sample(s) are retained for 90 days only.

除非另有說明，此報告結果僅對測試之樣品負責，同時此樣品僅保留90天。本報告未經本公司書面許可，不可部份複製。

This document is issued by the Company subject to its General Conditions of Service printed overleaf, available on request or accessible at <http://www.sgs.com.tw/Terms-and-Conditions>, and for electronic format documents, subject to Terms and Conditions for Electronic Documents at <http://www.sgs.com.tw/Terms-and-Conditions>. Attention is drawn to the limitation of liability, indemnification and jurisdiction issues defined therein. Any holder of this document is advised that information contained hereon reflects the Company's findings at the time of its intervention only and within the limits of Client's instructions, if any. The Company's sole responsibility is to its Client and this document does not exonerate parties to a transaction from exercising all their rights and obligations under the transaction documents. This document cannot be reproduced except in full, without prior written approval of the Company. Any unauthorized alteration, forgery or falsification of the content or appearance of this document is unlawful and offenders may be prosecuted to the fullest extent of the law.



802.11n\_20MHz\_Chain0\_5300MHz



802.11n\_20MHz\_Chain0\_5580MHz



802.11n\_20MHz\_Chain0\_5320MHz

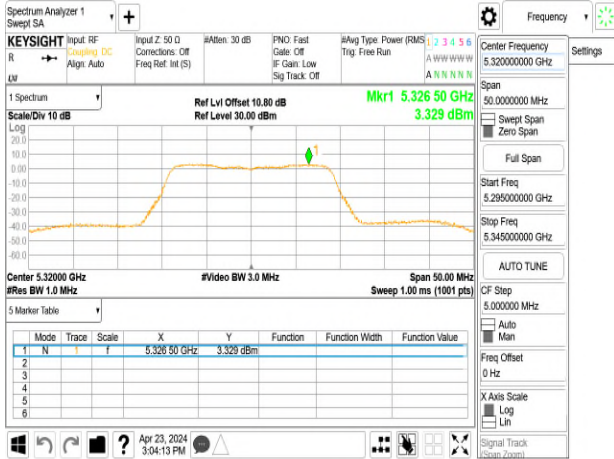

802.11n\_20MHz\_Chain0\_5700MHz



802.11n\_20MHz\_Chain0\_5500MHz

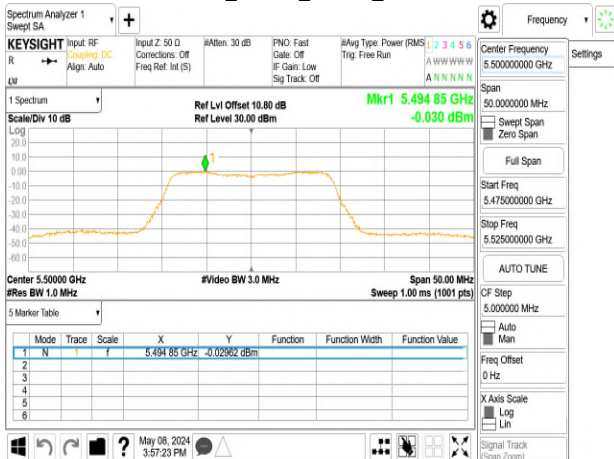

802.11n\_20MHz\_Chain0\_5720MHz\_UNII 2C



Unless otherwise stated the results shown in this test report refer only to the sample(s) tested and such sample(s) are retained for 90 days only.

除非另有說明，此報告結果僅對測試之樣品負責，同時此樣品僅保留90天。本報告未經本公司書面許可，不可部份複製。

This document is issued by the Company subject to its General Conditions of Service printed overleaf, available on request or accessible at <http://www.sgs.com.tw/Terms-and-Conditions>, and for electronic format documents, subject to Terms and Conditions for Electronic Documents at <http://www.sgs.com.tw/Terms-and-Conditions>. Attention is drawn to the limitation of liability, indemnification and jurisdiction issues defined therein. Any holder of this document is advised that information contained hereon reflects the Company's findings at the time of its intervention only and within the limits of Client's instructions, if any. The Company's sole responsibility is to its Client and this document does not exonerate parties to a transaction from exercising all their rights and obligations under the transaction documents. This document cannot be reproduced except in full, without prior written approval of the Company. Any unauthorized alteration, forgery or falsification of the content or appearance of this document is unlawful and offenders may be prosecuted to the fullest extent of the law.



802.11n\_20MHz\_Chain0\_5720MHz\_UNII 3



802.11n\_20MHz\_Chain0\_5785MHz

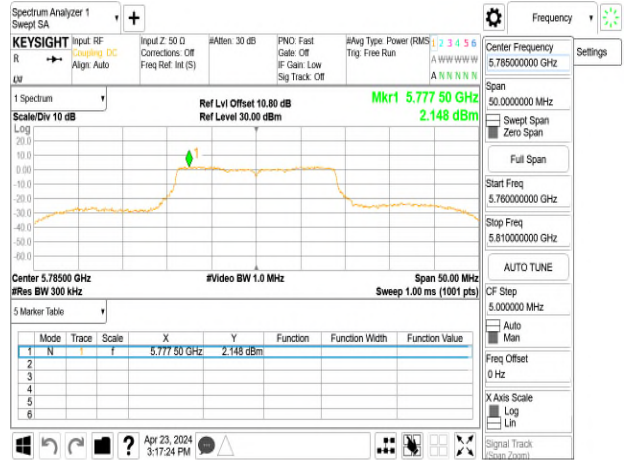

802.11n\_20MHz\_Chain0\_5745MHz



802.11n\_20MHz\_Chain0\_5825MHz



Unless otherwise stated the results shown in this test report refer only to the sample(s) tested and such sample(s) are retained for 90 days only.

除非另有說明，此報告結果僅對測試之樣品負責，同時此樣品僅保留90天。本報告未經本公司書面許可，不可部份複製。

This document is issued by the Company subject to its General Conditions of Service printed overleaf, available on request or accessible at <http://www.sgs.com.tw/Terms-and-Conditions>, and for electronic format documents, subject to Terms and Conditions for Electronic Documents at <http://www.sgs.com.tw/Terms-and-Conditions>. Attention is drawn to the limitation of liability, indemnification and jurisdiction issues defined therein. Any holder of this document is advised that information contained hereon reflects the Company's findings at the time of its intervention only and within the limits of Client's instructions, if any. The Company's sole responsibility is to its Client and this document does not exonerate parties to a transaction from exercising all their rights and obligations under the transaction documents. This document cannot be reproduced except in full, without prior written approval of the Company. Any unauthorized alteration, forgery or falsification of the content or appearance of this document is unlawful and offenders may be prosecuted to the fullest extent of the law.

## 11 UNDESIRABLE RADIATED EMISSION MEASUREMENT

### 11.1 Standard Applicable

$EIRP = (E \cdot d)^2 / 30$ , where  $E$  is the field strength in V/m,  $d$  is the measurement distance (3m),  $EIRP$  is the equivalent isotropically radiated power in Watts.

#### 11.1.1 5150~5850 MHz

Applicable to	Operation Freq. (MHz)	EIRP		Field Strength @ 3m (dBμV/m)
		Freq. (MHz)	Limits (dBm/MHz)	
15.407(b)(1) RSS-247 §6.2.1.2	5150~5250	f ≤ 5150 f ≥ 5350	PK: -27	PK: 68.2
15.407(b)(2) RSS-247 §6.2.2.2	5250~5350			
15.407(b)(3) RSS-247 §6.2.3.2	5475~5725	f ≤ 5470 f ≥ 5725		
15.407(b)(4)(i) RSS-247 §6.2.4.3	5725~5850	at 75 MHz or more above or below the band edge	PK:-27	PK: 68.2
		increasing linearly from 75~25MHz above or below the band edge	PK:-27~10	PK: 68.2~105.2
		increasing linearly from 25~5MHz above or below the band edge	PK:10~15.6	PK: 105.2~110.8
		increasing linearly from 5~0 MHz above or below the band edge	PK: 15.6~27	PK:110.8~122.2

#### 11.1.2 Spurious Emission

Unwanted spurious emissions which fall in the restricted bands must comply with the radiated emission limits specified as below table:

Frequency (MHz)	Field strength (microvolts/meter)	Distance (meters)
0.009-0.490	2400/F(kHz)	300
0.490-1.705	24000/F(kHz)	30
1.705-30	30	30
30-88	100	3
88-216	150	3
216-960	200	3
Above 960	500	3

**Note:**

- The lower limit shall apply at the transition frequencies.

Unless otherwise stated the results shown in this test report refer only to the sample(s) tested and such sample(s) are retained for 90 days only.

除非另有說明，此報告結果僅對測試之樣品負責，同時此樣品僅保留90天。本報告未經本公司書面許可，不可部份複製。

This document is issued by the Company subject to its General Conditions of Service printed overleaf, available on request or accessible at <http://www.sgs.com.tw/Terms-and-Conditions> and for electronic format documents, subject to Terms and Conditions for Electronic Documents at <http://www.sgs.com.tw/Terms-and-Conditions>. Attention is drawn to the limitation of liability, indemnification and jurisdiction issues defined therein. Any holder of this document is advised that information contained hereon reflects the Company's findings at the time of its intervention only and within the limits of Client's instructions, if any. The Company's sole responsibility is to its Client and this document does not exonerate parties to a transaction from exercising all their rights and obligations under the transaction documents. This document cannot be reproduced except in full, without prior written approval of the Company. Any unauthorized alteration, forgery or falsification of the content or appearance of this document is unlawful and offenders may be prosecuted to the fullest extent of the law.

11.2 Test Setup

(A) Radiated Emission Test Set-Up, Frequency Below 30MHz.

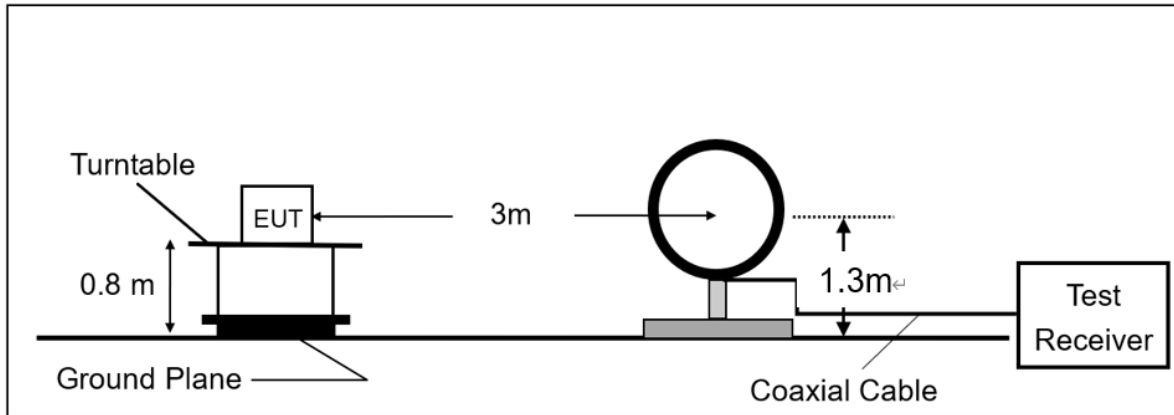

(B) Radiated Emission Test Set-Up, Frequency From 30MHz to 1000MHz

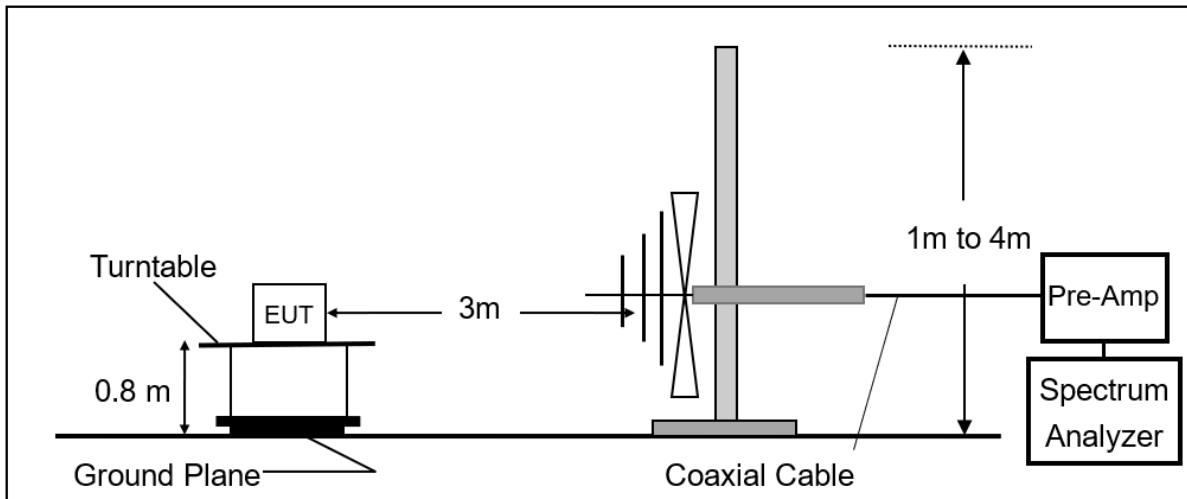

(C) Radiated Emission Test Set-Up, Frequency Above 1GHz

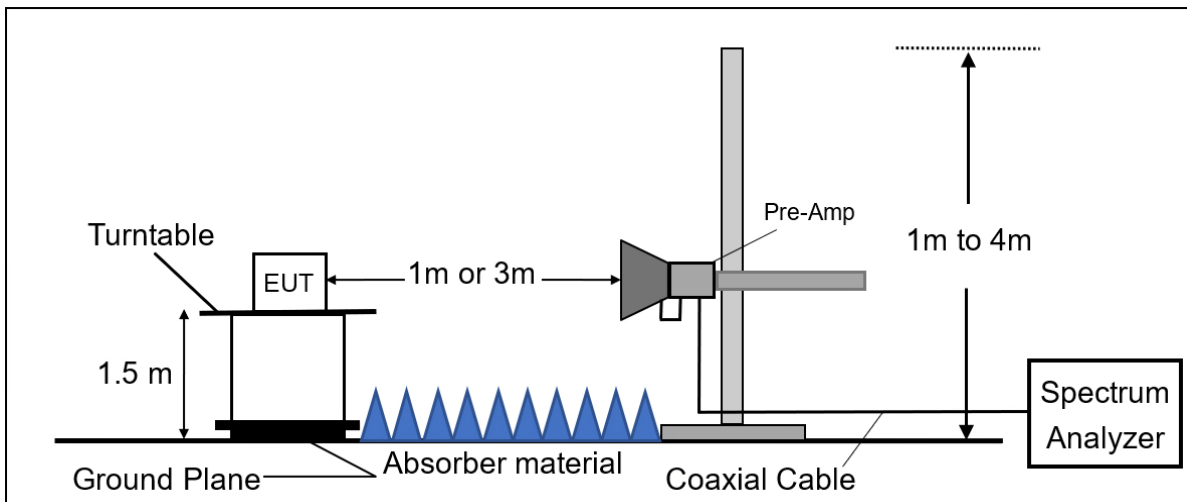

Unless otherwise stated the results shown in this test report refer only to the sample(s) tested and such sample(s) are retained for 90 days only.

除非另有說明，此報告結果僅對測試之樣品負責，同時此樣品僅保留90天。本報告未經本公司書面許可，不可部份複製。

This document is issued by the Company subject to its General Conditions of Service printed overleaf, available on request or accessible at <http://www.sgs.com.tw/Terms-and-Conditions> and for electronic format documents, subject to Terms and Conditions for Electronic Documents at <http://www.sgs.com.tw/Terms-and-Conditions>. Attention is drawn to the limitation of liability, indemnification and jurisdiction issues defined therein. Any holder of this document is advised that information contained herein reflects the Company's findings at the time of its intervention only and within the limits of Client's instructions, if any. The Company's sole responsibility is to its Client and this document does not exonerate parties to a transaction from exercising all their rights and obligations under the transaction documents. This document cannot be reproduced except in full, without prior written approval of the Company. Any unauthorized alteration, forgery or falsification of the content or appearance of this document is unlawful and offenders may be prosecuted to the fullest extent of the law.

### 11.3 Measurement Procedure

1. The testing follows FCC KDB 789033 D02.
2. The EUT was placed on a turn table with 0.8m for frequency < 1GHz and 1.5m for frequency > 1GHz above ground plane.
3. The turn table shall rotate 360 degrees to determine the position of maximum emission level.
4. EUT is set 3m away from the receiving antenna which varied from 1m to 4m to find out the highest emissions.
5. Set the spectrum analyzer as RBW=100 kHz and VBW=300 kHz for Peak Detector (PK) at frequency between 30MHz and 1 GHz
6. Use receiver mode as RBW=120 kHz for Quasi-peak (QP) at frequency between 30MHz and 1 GHz.
7. Set the spectrum analyzer as RBW=1 MHz, VBW=3 MHz for Maximum Emission Measurements at frequency above 1 GHz.
8. Set the spectrum analyzer as RBW=1 MHz, VBW=10 Hz (Duty cycle > 98%) or VBW ≥ 1/T (Duty cycle < 98%) for Average Emission Measurements at frequency above 1 GHz.
9. When measurement procedures for electric field radiated emissions above 1 GHz the EUT measurement is to be made “while keeping the antenna in the ‘cone of radiation’ from that area and pointed at the area both in azimuth and elevation, with polarization oriented for maximum response.” is still within the 3dB illumination BW of the measurement antenna.
10. Maximum procedure was performed on the six highest emissions to ensure EUT compliance.
11. And also, each emission was to be maximized by changing the polarization of receiving antenna both horizontal and vertical.
12. Repeat above procedures until all frequency measured were complete.

Unless otherwise stated the results shown in this test report refer only to the sample(s) tested and such sample(s) are retained for 90 days only.  
除非另有說明，此報告結果僅對測試之樣品負責，同時此樣品僅保留90天。本報告未經本公司書面許可，不可部份複製。

This document is issued by the Company subject to its General Conditions of Service printed overleaf, available on request or accessible at <http://www.sgs.com.tw/Terms-and-Conditions> and for electronic format documents, subject to Terms and Conditions for Electronic Documents at <http://www.sgs.com.tw/Terms-and-Conditions>. Attention is drawn to the limitation of liability, indemnification and jurisdiction issues defined therein. Any holder of this document is advised that information contained hereon reflects the Company's findings at the time of its intervention only and within the limits of Client's instructions, if any. The Company's sole responsibility is to its Client and this document does not exonerate parties to a transaction from exercising all their rights and obligations under the transaction documents. This document cannot be reproduced except in full, without prior written approval of the Company. Any unauthorized alteration, forgery or falsification of the content or appearance of this document is unlawful and offenders may be prosecuted to the fullest extent of the law.

### 11.4 Field Strength Calculation

The field strength is calculated by adding the Antenna Factor and Cable Factor and subtracting the Amplifier Gain and Duty Cycle Correction Factor (if any) from the measured reading. The basic equation with a sample calculation is as follows:

$$FS = RA + AF + CL - AG$$

**Where** *FS* = Field Strength

*CL* = Cable Attenuation Factor (Cable Loss)

*RA* = Reading Amplitude

*AG* = Amplifier Gain

*AF* = Antenna Factor

The limit of the emission level is expressed in dBuV/m, which converts  $20 \cdot \log(uV/m)$

*Actual FS(dBuV/m) = SPA. Reading level(dBuV) + Factor(dB)*

*Factor(dB) = Antenna Factor(dBuV/m) + Cable Loss(dB) – Pre\_Amplifier Gain(dB)*

### 11.5 Test Results of Radiated Spurious Emissions from 9 kHz to 30 MHz

The low frequency, which started from 9 kHz to 30MHz, was pre-scanned and the result which was 20dB lower than the limit per 15.31(o) & RSS-GEN §6.13.2 was not reported.

Unless otherwise stated the results shown in this test report refer only to the sample(s) tested and such sample(s) are retained for 90 days only.

除非另有說明，此報告結果僅對測試之樣品負責，同時此樣品僅保留90天。本報告未經本公司書面許可，不可部份複製。

This document is issued by the Company subject to its General Conditions of Service printed overleaf, available on request or accessible at <http://www.sgs.com.tw/Terms-and-Conditions> and for electronic format documents, subject to Terms and Conditions for Electronic Documents at <http://www.sgs.com.tw/Terms-and-Conditions>. Attention is drawn to the limitation of liability, indemnification and jurisdiction issues defined therein. Any holder of this document is advised that information contained hereon reflects the Company's findings at the time of its intervention only and within the limits of Client's instructions, if any. The Company's sole responsibility is to its Client and this document does not exonerate parties to a transaction from exercising all their rights and obligations under the transaction documents. This document cannot be reproduced except in full, without prior written approval of the Company. Any unauthorized alteration, forgery or falsification of the content or appearance of this document is unlawful and offenders may be prosecuted to the fullest extent of the law.

## 11.6 Radiated Spurious Emission Measurement Result

### 11.6.1 Spurious Emission

dipole

Report Number	:TERF2404000927E2	Test Site	:SAC G Chamber
Operation Mode	:802.11a	Test Date	:2024-05-13
Test Frequency	:5220 MHz	Temp./Humi.	:21.8°C/56%
Test Mode	:Tx	Antenna Pol.	:Vertical
EUT Pol	:E2 Plane	Engineer	:Temo Chen

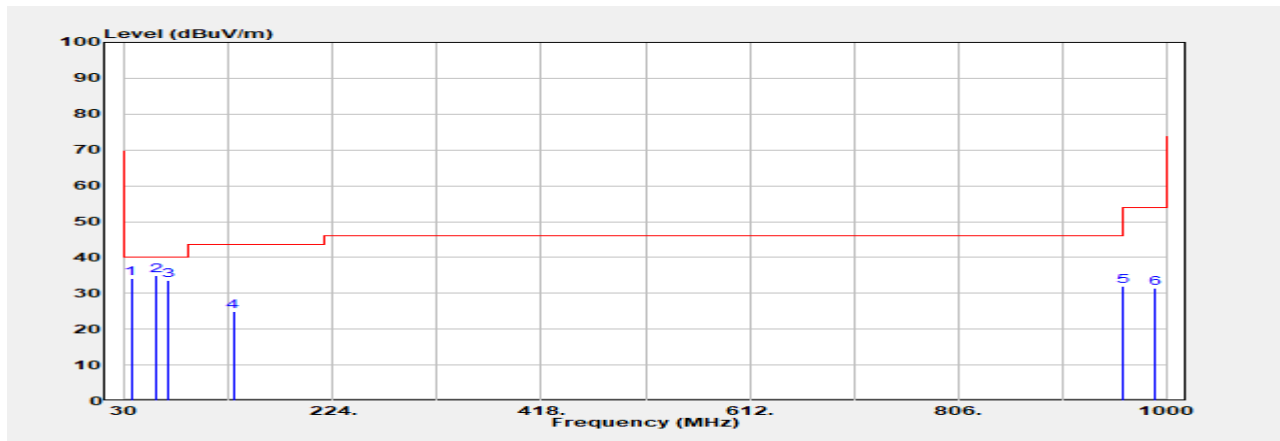

Freq. MHz	Detector Mode PK/QP/AVG	Spectrum Reading Level dBμV	Factor dB	Actual FS dBμV/m	Limit @3m dBμV/m	Margin dB
35.820	QP	48.30	-14.25	34.05	40.00	-5.95
59.100	QP	48.10	-13.02	35.08	40.00	-4.92
70.740	QP	48.70	-14.99	33.71	40.00	-6.29
130.880	QP	39.40	-14.52	24.88	43.50	-18.62
959.260	Peak	30.91	1.05	31.96	46.00	-14.04
990.300	Peak	30.58	0.80	31.38	54.00	-22.62

Unless otherwise stated the results shown in this test report refer only to the sample(s) tested and such sample(s) are retained for 90 days only.

除非另有說明，此報告結果僅對測試之樣品負責，同時此樣品僅保留90天。本報告未經本公司書面許可，不可部份複製。

This document is issued by the Company subject to its General Conditions of Service printed overleaf, available on request or accessible at <http://www.sgs.com.tw/Terms-and-Conditions> and for electronic format documents, subject to Terms and Conditions for Electronic Documents at <http://www.sgs.com.tw/Terms-and-Conditions>. Attention is drawn to the limitation of liability, indemnification and jurisdiction issues defined therein. Any holder of this document is advised that information contained hereon reflects the Company's findings at the time of its intervention only and within the limits of Client's instructions, if any. The Company's sole responsibility is to its Client and this document does not exonerate parties to a transaction from exercising all their rights and obligations under the transaction documents. This document cannot be reproduced except in full, without prior written approval of the Company. Any unauthorized alteration, forgery or falsification of the content or appearance of this document is unlawful and offenders may be prosecuted to the fullest extent of the law.

Report Number :TERF2404000927E2  
 Operation Mode :802.11a  
 Test Frequency :5220 MHz  
 Test Mode :Tx  
 EUT Pol :E2 Plane

Test Site :SAC G Chamber  
 Test Date :2024-05-13  
 Temp./Humi. :21.8°C/56%  
 Antenna Pol. :Horizontal  
 Engineer :Temo Chen

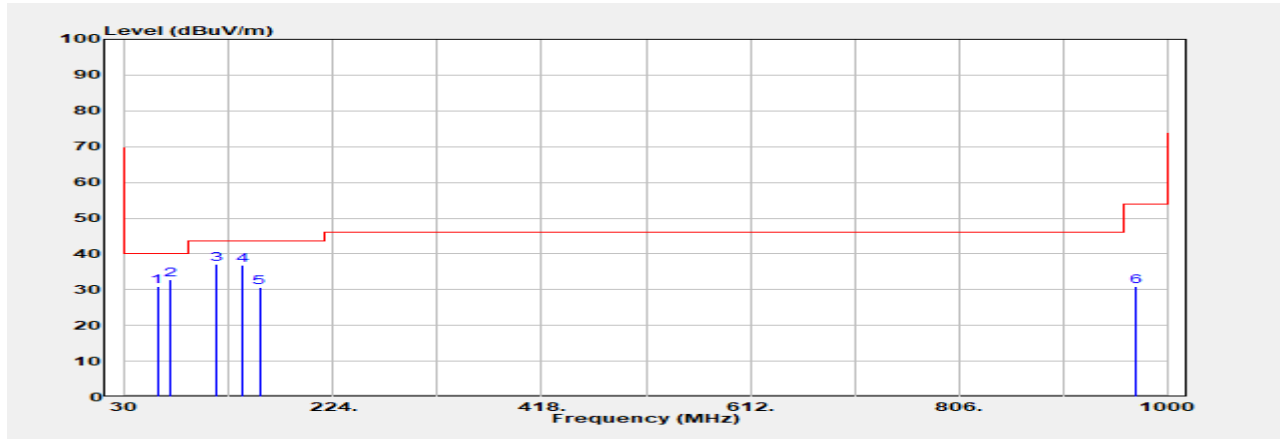

Freq. MHz	Detector Mode PK/QP/AVG	Spectrum Reading Level dBμV	Factor dB	Actual FS dBμV/m	Limit @3m dBμV/m	Margin dB
60.070	Peak	43.88	-12.95	30.93	40.00	-9.07
72.680	Peak	48.28	-15.45	32.83	40.00	-7.17
114.390	Peak	53.08	-15.94	37.13	43.50	-6.37
138.640	Peak	50.46	-13.63	36.83	43.50	-6.67
155.130	Peak	43.07	-12.57	30.50	43.50	-13.00
970.900	Peak	29.68	1.26	30.95	54.00	-23.05

Unless otherwise stated the results shown in this test report refer only to the sample(s) tested and such sample(s) are retained for 90 days only.

除非另有說明，此報告結果僅對測試之樣品負責，同時此樣品僅保留90天。本報告未經本公司書面許可，不可部份複製。

This document is issued by the Company subject to its General Conditions of Service printed overleaf, available on request or accessible at <http://www.sgs.com.tw/Terms-and-Conditions> and for electronic format documents, subject to Terms and Conditions for Electronic Documents at <http://www.sgs.com.tw/Terms-and-Conditions>. Attention is drawn to the limitation of liability, indemnification and jurisdiction issues defined therein. Any holder of this document is advised that information contained hereon reflects the Company's findings at the time of its intervention only and within the limits of Client's instructions, if any. The Company's sole responsibility is to its Client and this document does not exonerate parties to a transaction from exercising all their rights and obligations under the transaction documents. This document cannot be reproduced except in full, without prior written approval of the Company. Any unauthorized alteration, forgery or falsification of the content or appearance of this document is unlawful and offenders may be prosecuted to the fullest extent of the law.



Report Number :TERF2404000927E2  
 Operation Mode :802.11a  
 Test Frequency :5300 MHz  
 Test Mode :Tx  
 EUT Pol :E2 Plane

Test Site :SAC G Chamber  
 Test Date :2024-05-13  
 Temp./Humi. :21.8°C/56%  
 Antenna Pol. :Vertical  
 Engineer :Temo Chen

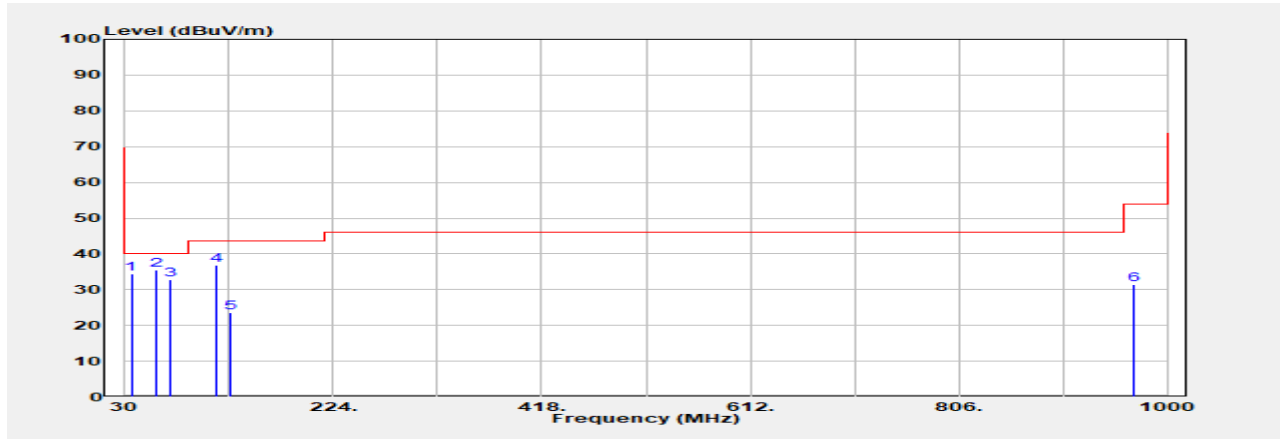

Freq. MHz	Detector Mode PK/QP/AVG	Spectrum Reading Level dBμV	Factor dB	Actual FS dBμV/m	Limit @3m dBμV/m	Margin dB
35.820	QP	48.60	-14.25	34.35	40.00	-5.65
59.100	QP	48.50	-13.02	35.48	40.00	-4.52
72.680	QP	48.30	-15.45	32.85	40.00	-7.15
115.360	Peak	52.68	-15.95	36.73	43.50	-6.77
128.940	QP	38.40	-14.83	23.57	43.50	-19.93
969.930	Peak	30.18	1.30	31.48	54.00	-22.52

Unless otherwise stated the results shown in this test report refer only to the sample(s) tested and such sample(s) are retained for 90 days only.

除非另有說明，此報告結果僅對測試之樣品負責，同時此樣品僅保留90天。本報告未經本公司書面許可，不可部份複製。

This document is issued by the Company subject to its General Conditions of Service printed overleaf, available on request or accessible at <http://www.sgs.com.tw/Terms-and-Conditions> and for electronic format documents, subject to Terms and Conditions for Electronic Documents at <http://www.sgs.com.tw/Terms-and-Conditions>. Attention is drawn to the limitation of liability, indemnification and jurisdiction issues defined therein. Any holder of this document is advised that information contained hereon reflects the Company's findings at the time of its intervention only and within the limits of Client's instructions, if any. The Company's sole responsibility is to its Client and this document does not exonerate parties to a transaction from exercising all their rights and obligations under the transaction documents. This document cannot be reproduced except in full, without prior written approval of the Company. Any unauthorized alteration, forgery or falsification of the content or appearance of this document is unlawful and offenders may be prosecuted to the fullest extent of the law.

Report Number :TERF2404000927E2  
 Operation Mode :802.11a  
 Test Frequency :5300 MHz  
 Test Mode :Tx  
 EUT Pol :E2 Plane

Test Site :SAC G Chamber  
 Test Date :2024-05-13  
 Temp./Humi. :21.8°C/56%  
 Antenna Pol. :Horizontal  
 Engineer :Temo Chen

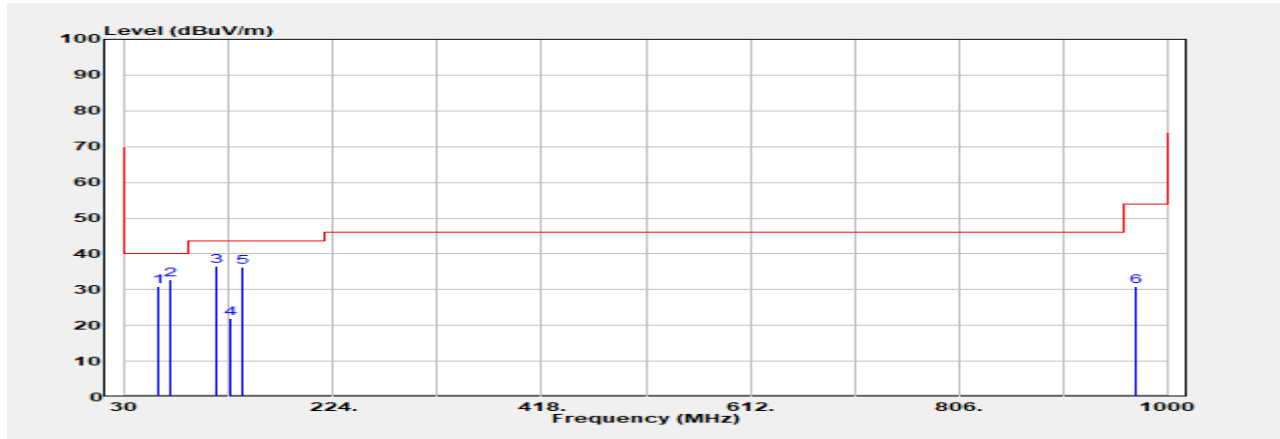

Freq. MHz	Detector Mode PK/QP/AVG	Spectrum Reading Level dBμV	Factor dB	Actual FS dBμV/m	Limit @3m dBμV/m	Margin dB
61.040	Peak	44.11	-13.24	30.87	40.00	-9.13
72.680	Peak	48.21	-15.45	32.77	40.00	-7.23
115.360	Peak	52.62	-15.95	36.68	43.50	-6.82
128.940	QP	36.80	-14.83	21.97	43.50	-21.53
138.640	Peak	49.99	-13.63	36.36	43.50	-7.14
970.900	Peak	29.70	1.26	30.96	54.00	-23.04

Unless otherwise stated the results shown in this test report refer only to the sample(s) tested and such sample(s) are retained for 90 days only.

除非另有說明，此報告結果僅對測試之樣品負責，同時此樣品僅保留90天。本報告未經本公司書面許可，不可部份複製。

This document is issued by the Company subject to its General Conditions of Service printed overleaf, available on request or accessible at <http://www.sgs.com.tw/Terms-and-Conditions> and for electronic format documents, subject to Terms and Conditions for Electronic Documents at <http://www.sgs.com.tw/Terms-and-Conditions>. Attention is drawn to the limitation of liability, indemnification and jurisdiction issues defined therein. Any holder of this document is advised that information contained hereon reflects the Company's findings at the time of its intervention only and within the limits of Client's instructions, if any. The Company's sole responsibility is to its Client and this document does not exonerate parties to a transaction from exercising all their rights and obligations under the transaction documents. This document cannot be reproduced except in full, without prior written approval of the Company. Any unauthorized alteration, forgery or falsification of the content or appearance of this document is unlawful and offenders may be prosecuted to the fullest extent of the law.

Report Number :TERF2404000927E2  
 Operation Mode :802.11a  
 Test Frequency :5580 MHz  
 Test Mode :Tx  
 EUT Pol :E2 Plane

Test Site :SAC G Chamber  
 Test Date :2024-05-13  
 Temp./Humi. :21.8°C/56%  
 Antenna Pol. :Vertical  
 Engineer :Temo Chen

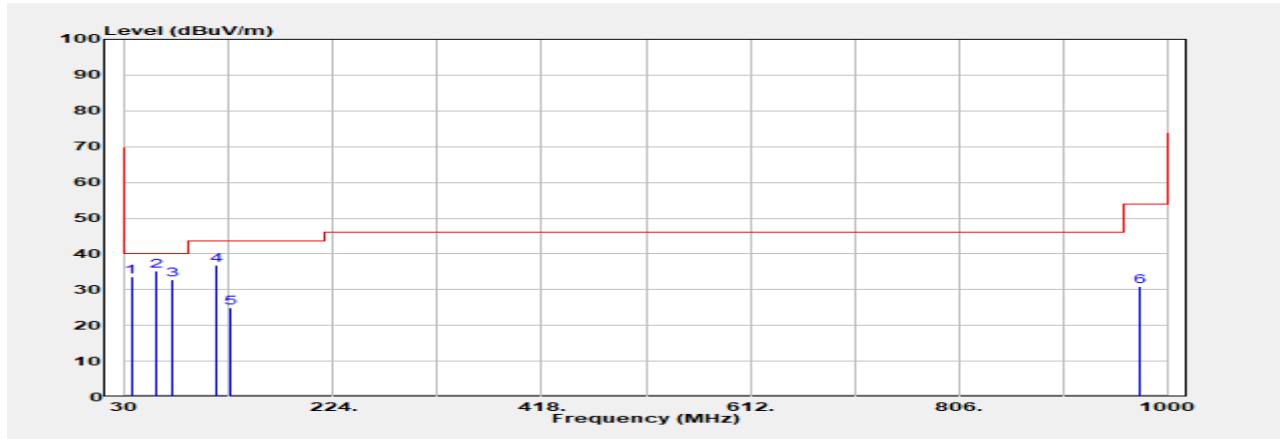

Freq. MHz	Detector Mode PK/QP/AVG	Spectrum Reading Level dBμV	Factor dB	Actual FS dBμV/m	Limit @3m dBμV/m	Margin dB
35.820	QP	47.90	-14.25	33.65	40.00	-6.35
59.100	QP	48.20	-13.02	35.18	40.00	-4.82
73.650	QP	48.50	-15.80	32.70	40.00	-7.30
115.360	Peak	52.83	-15.95	36.88	43.50	-6.62
128.940	QP	39.70	-14.83	24.87	43.50	-18.63
974.780	Peak	29.74	1.08	30.82	54.00	-23.18

Unless otherwise stated the results shown in this test report refer only to the sample(s) tested and such sample(s) are retained for 90 days only.

除非另有說明，此報告結果僅對測試之樣品負責，同時此樣品僅保留90天。本報告未經本公司書面許可，不可部份複製。

This document is issued by the Company subject to its General Conditions of Service printed overleaf, available on request or accessible at <http://www.sgs.com.tw/Terms-and-Conditions> and for electronic format documents, subject to Terms and Conditions for Electronic Documents at <http://www.sgs.com.tw/Terms-and-Conditions>. Attention is drawn to the limitation of liability, indemnification and jurisdiction issues defined therein. Any holder of this document is advised that information contained hereon reflects the Company's findings at the time of its intervention only and within the limits of Client's instructions, if any. The Company's sole responsibility is to its Client and this document does not exonerate parties to a transaction from exercising all their rights and obligations under the transaction documents. This document cannot be reproduced except in full, without prior written approval of the Company. Any unauthorized alteration, forgery or falsification of the content or appearance of this document is unlawful and offenders may be prosecuted to the fullest extent of the law.

Report Number :TERF2404000927E2  
 Operation Mode :802.11a  
 Test Frequency :5580 MHz  
 Test Mode :Tx  
 EUT Pol :E2 Plane

Test Site :SAC G Chamber  
 Test Date :2024-05-13  
 Temp./Humi. :21.8°C/56%  
 Antenna Pol. :Horizontal  
 Engineer :Temo Chen

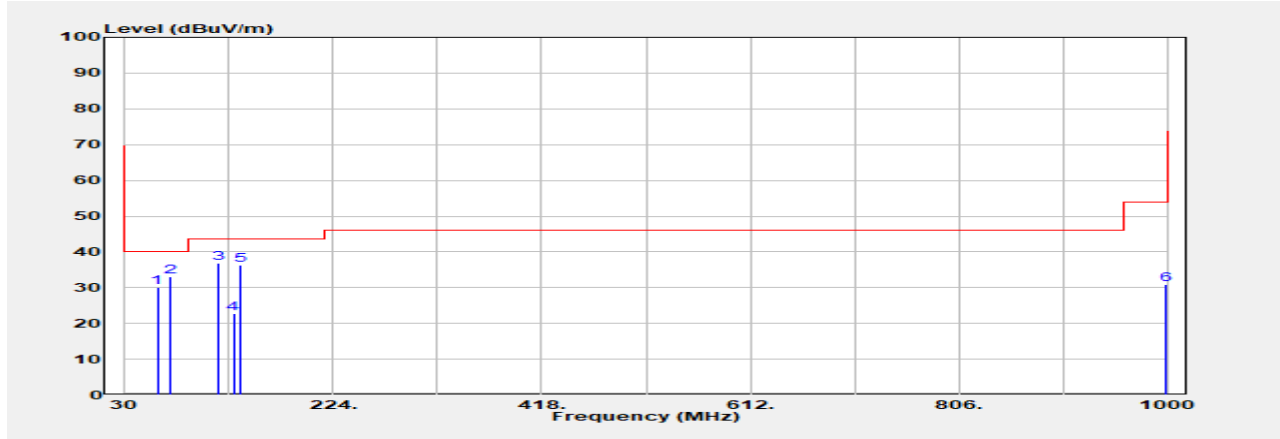

Freq. MHz	Detector Mode PK/QP/AVG	Spectrum Reading Level dB $\mu$ V	Factor dB	Actual FS dB $\mu$ V/m	Limit @3m dB $\mu$ V/m	Margin dB
60.070	Peak	43.07	-12.95	30.11	40.00	-9.89
72.680	Peak	48.64	-15.45	33.19	40.00	-6.81
116.330	Peak	52.70	-15.88	36.81	43.50	-6.69
130.880	QP	37.20	-14.52	22.68	43.50	-20.82
137.670	Peak	50.04	-13.78	36.26	43.50	-7.24
999.030	Peak	30.09	0.71	30.80	54.00	-23.20

Unless otherwise stated the results shown in this test report refer only to the sample(s) tested and such sample(s) are retained for 90 days only.

除非另有說明，此報告結果僅對測試之樣品負責，同時此樣品僅保留90天。本報告未經本公司書面許可，不可部份複製。

This document is issued by the Company subject to its General Conditions of Service printed overleaf, available on request or accessible at <http://www.sgs.com.tw/Terms-and-Conditions> and for electronic format documents, subject to Terms and Conditions for Electronic Documents at <http://www.sgs.com.tw/Terms-and-Conditions>. Attention is drawn to the limitation of liability, indemnification and jurisdiction issues defined therein. Any holder of this document is advised that information contained hereon reflects the Company's findings at the time of its intervention only and within the limits of Client's instructions, if any. The Company's sole responsibility is to its Client and this document does not exonerate parties to a transaction from exercising all their rights and obligations under the transaction documents. This document cannot be reproduced except in full, without prior written approval of the Company. Any unauthorized alteration, forgery or falsification of the content or appearance of this document is unlawful and offenders may be prosecuted to the fullest extent of the law.

Report Number :TERF2404000927E2  
 Operation Mode :802.11a  
 Test Frequency :5785 MHz  
 Test Mode :Tx  
 EUT Pol :E2 Plane

Test Site :SAC G Chamber  
 Test Date :2024-05-13  
 Temp./Humi. :21.8°C/56%  
 Antenna Pol. :Vertical  
 Engineer :Temo Chen

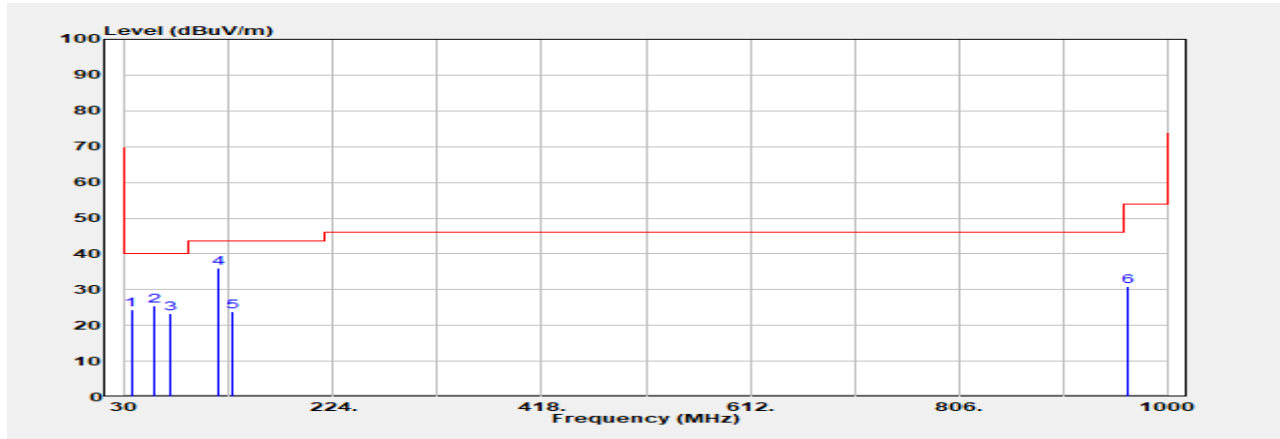

Freq. MHz	Detector Mode PK/QP/AVG	Spectrum Reading Level dBμV	Factor dB	Actual FS dBμV/m	Limit @3m dBμV/m	Margin dB
35.820	QP	38.70	-14.25	24.45	40.00	-15.55
58.130	QP	38.40	-12.95	25.45	40.00	-14.55
71.710	QP	38.50	-15.08	23.42	40.00	-16.58
116.330	Peak	51.99	-15.88	36.11	43.50	-7.39
129.910	QP	38.40	-14.64	23.76	43.50	-19.74
963.140	Peak	29.89	1.08	30.97	54.00	-23.03

Unless otherwise stated the results shown in this test report refer only to the sample(s) tested and such sample(s) are retained for 90 days only.

除非另有說明，此報告結果僅對測試之樣品負責，同時此樣品僅保留90天。本報告未經本公司書面許可，不可部份複製。

This document is issued by the Company subject to its General Conditions of Service printed overleaf, available on request or accessible at <http://www.sgs.com.tw/Terms-and-Conditions> and for electronic format documents, subject to Terms and Conditions for Electronic Documents at <http://www.sgs.com.tw/Terms-and-Conditions>. Attention is drawn to the limitation of liability, indemnification and jurisdiction issues defined therein. Any holder of this document is advised that information contained hereon reflects the Company's findings at the time of its intervention only and within the limits of Client's instructions, if any. The Company's sole responsibility is to its Client and this document does not exonerate parties to a transaction from exercising all their rights and obligations under the transaction documents. This document cannot be reproduced except in full, without prior written approval of the Company. Any unauthorized alteration, forgery or falsification of the content or appearance of this document is unlawful and offenders may be prosecuted to the fullest extent of the law.

Report Number :TERF2404000927E2  
 Operation Mode :802.11a  
 Test Frequency :5785 MHz  
 Test Mode :Tx  
 EUT Pol :E2 Plane

Test Site :SAC G Chamber  
 Test Date :2024-05-13  
 Temp./Humi. :21.8°C/56%  
 Antenna Pol. :Horizontal  
 Engineer :Temo Chen

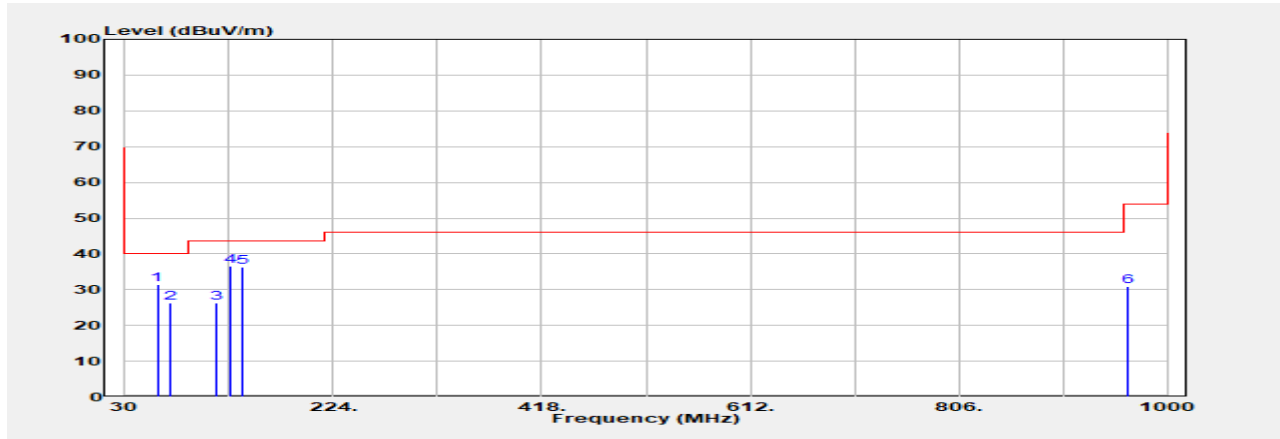

Freq. MHz	Detector Mode PK/QP/AVG	Spectrum Reading Level dBμV	Factor dB	Actual FS dBμV/m	Limit @3m dBμV/m	Margin dB
60.070	Peak	44.31	-12.95	31.36	40.00	-8.64
71.710	QP	41.30	-15.08	26.22	40.00	-13.78
115.360	QP	42.30	-15.95	26.35	43.50	-17.15
127.970	Peak	51.63	-14.93	36.70	43.50	-6.80
138.640	Peak	50.07	-13.63	36.43	43.50	-7.07
963.140	Peak	29.80	1.08	30.87	54.00	-23.13

Unless otherwise stated the results shown in this test report refer only to the sample(s) tested and such sample(s) are retained for 90 days only.

除非另有說明，此報告結果僅對測試之樣品負責，同時此樣品僅保留90天。本報告未經本公司書面許可，不可部份複製。

This document is issued by the Company subject to its General Conditions of Service printed overleaf, available on request or accessible at <http://www.sgs.com.tw/Terms-and-Conditions> and for electronic format documents, subject to Terms and Conditions for Electronic Documents at <http://www.sgs.com.tw/Terms-and-Conditions>. Attention is drawn to the limitation of liability, indemnification and jurisdiction issues defined therein. Any holder of this document is advised that information contained hereon reflects the Company's findings at the time of its intervention only and within the limits of Client's instructions, if any. The Company's sole responsibility is to its Client and this document does not exonerate parties to a transaction from exercising all their rights and obligations under the transaction documents. This document cannot be reproduced except in full, without prior written approval of the Company. Any unauthorized alteration, forgery or falsification of the content or appearance of this document is unlawful and offenders may be prosecuted to the fullest extent of the law.

Report Number :TERF2404000927E2  
 Operation Mode :802.11a  
 Test Frequency :5180 MHz  
 Test Mode :Tx  
 EUT Pol :E2 Plane

Test Site :SAC G Chamber  
 Test Date :2024-04-24  
 Temp./Humi. :22.1°C/57%  
 Antenna Pol. :Vertical  
 Engineer :Temo Chen

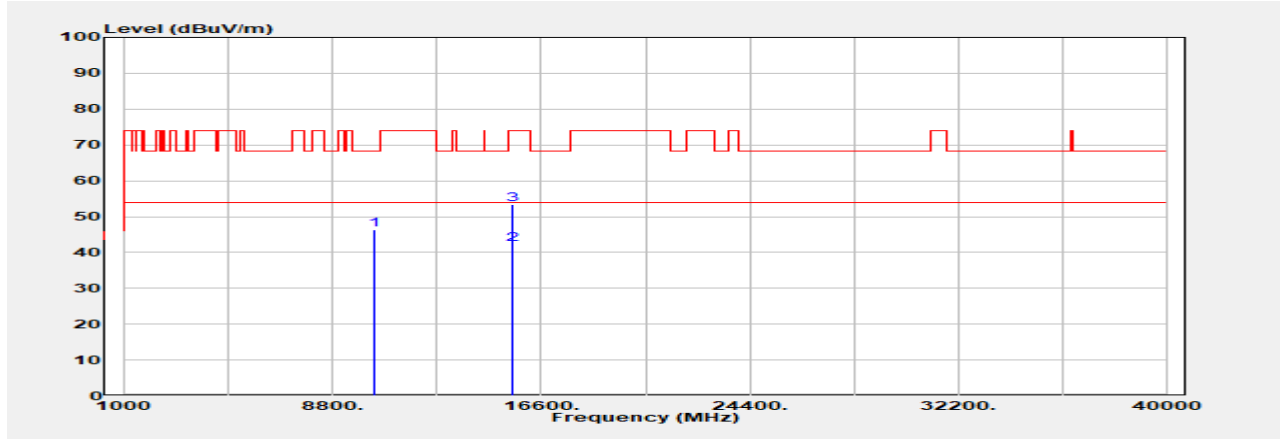

Freq. MHz	Detector Mode PK/QP/AVG	Spectrum Reading Level dBμV	Factor dB	Actual FS dBμV/m	Limit @3m dBμV/m	Margin dB
10360.000	Peak	36.63	9.70	46.33	68.20	-21.87
15540.000	Average	30.07	12.28	42.35	54.00	-11.65
15540.000	Peak	41.20	12.28	53.48	74.00	-20.52

Unless otherwise stated the results shown in this test report refer only to the sample(s) tested and such sample(s) are retained for 90 days only.

除非另有說明，此報告結果僅對測試之樣品負責，同時此樣品僅保留90天。本報告未經本公司書面許可，不可部份複製。

This document is issued by the Company subject to its General Conditions of Service printed overleaf, available on request or accessible at <http://www.sgs.com.tw/Terms-and-Conditions> and for electronic format documents, subject to Terms and Conditions for Electronic Documents at <http://www.sgs.com.tw/Terms-and-Conditions>. Attention is drawn to the limitation of liability, indemnification and jurisdiction issues defined therein. Any holder of this document is advised that information contained hereon reflects the Company's findings at the time of its intervention only and within the limits of Client's instructions, if any. The Company's sole responsibility is to its Client and this document does not exonerate parties to a transaction from exercising all their rights and obligations under the transaction documents. This document cannot be reproduced except in full, without prior written approval of the Company. Any unauthorized alteration, forgery or falsification of the content or appearance of this document is unlawful and offenders may be prosecuted to the fullest extent of the law.



Report Number :TERF2404000927E2  
 Operation Mode :802.11a  
 Test Frequency :5180 MHz  
 Test Mode :Tx  
 EUT Pol :E2 Plane

Test Site :SAC G Chamber  
 Test Date :2024-04-24  
 Temp./Humi. :22.1°C/57%  
 Antenna Pol. :Horizontal  
 Engineer :Temo Chen

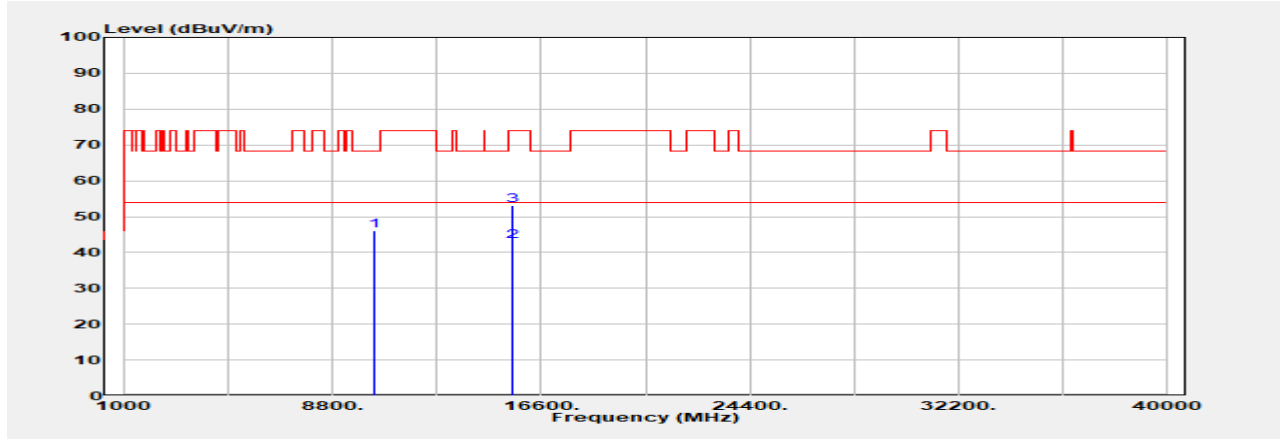

Freq. MHz	Detector Mode PK/QP/AVG	Spectrum Reading Level dB $\mu$ V	Factor dB	Actual FS dB $\mu$ V/m	Limit @3m dB $\mu$ V/m	Margin dB
10360.000	Peak	36.47	9.70	46.17	68.20	-22.03
15540.000	Average	30.93	12.28	43.21	54.00	-10.79
15540.000	Peak	40.84	12.28	53.11	74.00	-20.89

Unless otherwise stated the results shown in this test report refer only to the sample(s) tested and such sample(s) are retained for 90 days only.

除非另有說明，此報告結果僅對測試之樣品負責，同時此樣品僅保留90天。本報告未經本公司書面許可，不可部份複製。

This document is issued by the Company subject to its General Conditions of Service printed overleaf, available on request or accessible at <http://www.sgs.com.tw/Terms-and-Conditions> and for electronic format documents, subject to Terms and Conditions for Electronic Documents at <http://www.sgs.com.tw/Terms-and-Conditions>. Attention is drawn to the limitation of liability, indemnification and jurisdiction issues defined therein. Any holder of this document is advised that information contained hereon reflects the Company's findings at the time of its intervention only and within the limits of Client's instructions, if any. The Company's sole responsibility is to its Client and this document does not exonerate parties to a transaction from exercising all their rights and obligations under the transaction documents. This document cannot be reproduced except in full, without prior written approval of the Company. Any unauthorized alteration, forgery or falsification of the content or appearance of this document is unlawful and offenders may be prosecuted to the fullest extent of the law.

Report Number :TERF2404000927E2  
 Operation Mode :802.11a  
 Test Frequency :5220 MHz  
 Test Mode :Tx  
 EUT Pol :E2 Plane

Test Site :SAC G Chamber  
 Test Date :2024-04-24  
 Temp./Humi. :22.1°C/57%  
 Antenna Pol. :Vertical  
 Engineer :Temo Chen

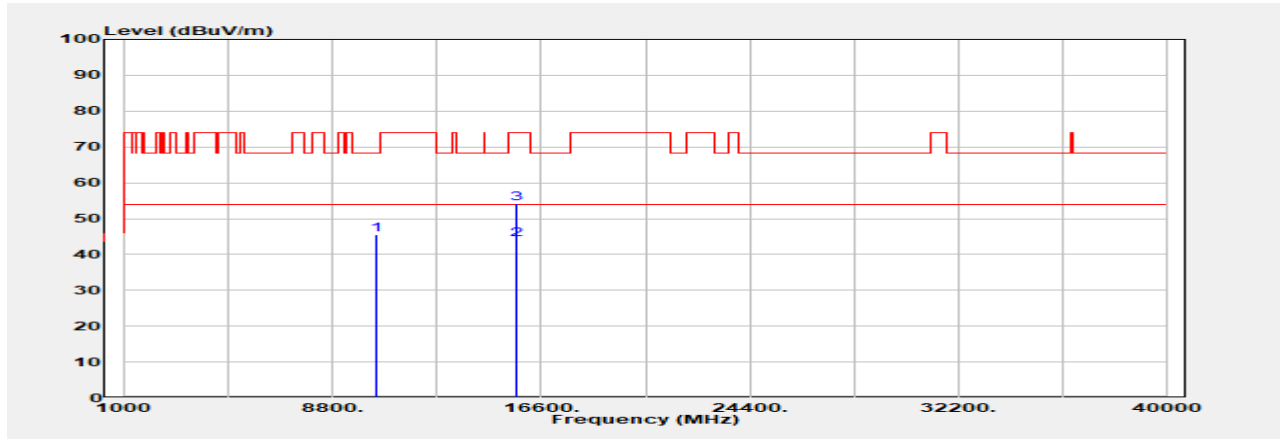

Freq. MHz	Detector Mode PK/QP/AVG	Spectrum Reading Level dBμV	Factor dB	Actual FS dBμV/m	Limit @3m dBμV/m	Margin dB
10440.000	Peak	35.80	9.68	45.48	68.20	-22.72
15660.000	Average	31.10	13.00	44.10	54.00	-9.90
15660.000	Peak	41.15	13.00	54.15	74.00	-19.85

Unless otherwise stated the results shown in this test report refer only to the sample(s) tested and such sample(s) are retained for 90 days only.

除非另有說明，此報告結果僅對測試之樣品負責，同時此樣品僅保留90天。本報告未經本公司書面許可，不可部份複製。

This document is issued by the Company subject to its General Conditions of Service printed overleaf, available on request or accessible at <http://www.sgs.com.tw/Terms-and-Conditions> and for electronic format documents, subject to Terms and Conditions for Electronic Documents at <http://www.sgs.com.tw/Terms-and-Conditions>. Attention is drawn to the limitation of liability, indemnification and jurisdiction issues defined therein. Any holder of this document is advised that information contained hereon reflects the Company's findings at the time of its intervention only and within the limits of Client's instructions, if any. The Company's sole responsibility is to its Client and this document does not exonerate parties to a transaction from exercising all their rights and obligations under the transaction documents. This document cannot be reproduced except in full, without prior written approval of the Company. Any unauthorized alteration, forgery or falsification of the content or appearance of this document is unlawful and offenders may be prosecuted to the fullest extent of the law.

Report Number :TERF2404000927E2  
 Operation Mode :802.11a  
 Test Frequency :5220 MHz  
 Test Mode :Tx  
 EUT Pol :E2 Plane

Test Site :SAC G Chamber  
 Test Date :2024-04-24  
 Temp./Humi. :22.1°C/57%  
 Antenna Pol. :Horizontal  
 Engineer :Temo Chen

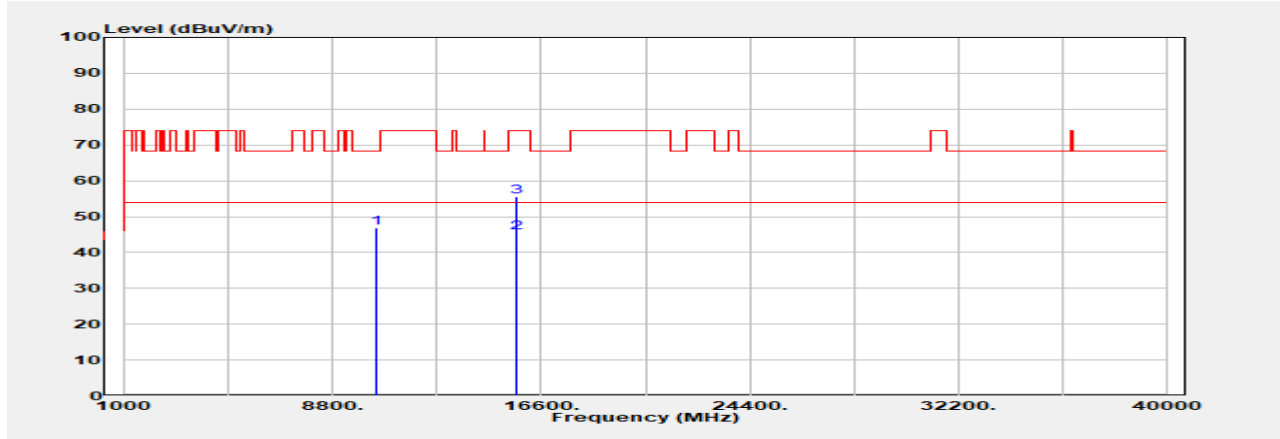

Freq. MHz	Detector Mode PK/QP/AVG	Spectrum Reading Level dB $\mu$ V	Factor dB	Actual FS dB $\mu$ V/m	Limit @3m dB $\mu$ V/m	Margin dB
10440.000	Peak	37.32	9.68	47.00	68.20	-21.20
15660.000	Average	32.52	13.00	45.52	54.00	-8.48
15660.000	Peak	42.67	13.00	55.67	74.00	-18.33

Unless otherwise stated the results shown in this test report refer only to the sample(s) tested and such sample(s) are retained for 90 days only.

除非另有說明，此報告結果僅對測試之樣品負責，同時此樣品僅保留90天。本報告未經本公司書面許可，不可部份複製。

This document is issued by the Company subject to its General Conditions of Service printed overleaf, available on request or accessible at <http://www.sgs.com.tw/Terms-and-Conditions> and for electronic format documents, subject to Terms and Conditions for Electronic Documents at <http://www.sgs.com.tw/Terms-and-Conditions>. Attention is drawn to the limitation of liability, indemnification and jurisdiction issues defined therein. Any holder of this document is advised that information contained hereon reflects the Company's findings at the time of its intervention only and within the limits of Client's instructions, if any. The Company's sole responsibility is to its Client and this document does not exonerate parties to a transaction from exercising all their rights and obligations under the transaction documents. This document cannot be reproduced except in full, without prior written approval of the Company. Any unauthorized alteration, forgery or falsification of the content or appearance of this document is unlawful and offenders may be prosecuted to the fullest extent of the law.

Report Number :TERF2404000927E2  
 Operation Mode :802.11a  
 Test Frequency :5240 MHz  
 Test Mode :Tx  
 EUT Pol :E2 Plane

Test Site :SAC G Chamber  
 Test Date :2024-04-24  
 Temp./Humi. :22.1°C/57%  
 Antenna Pol. :Vertical  
 Engineer :Temo Chen

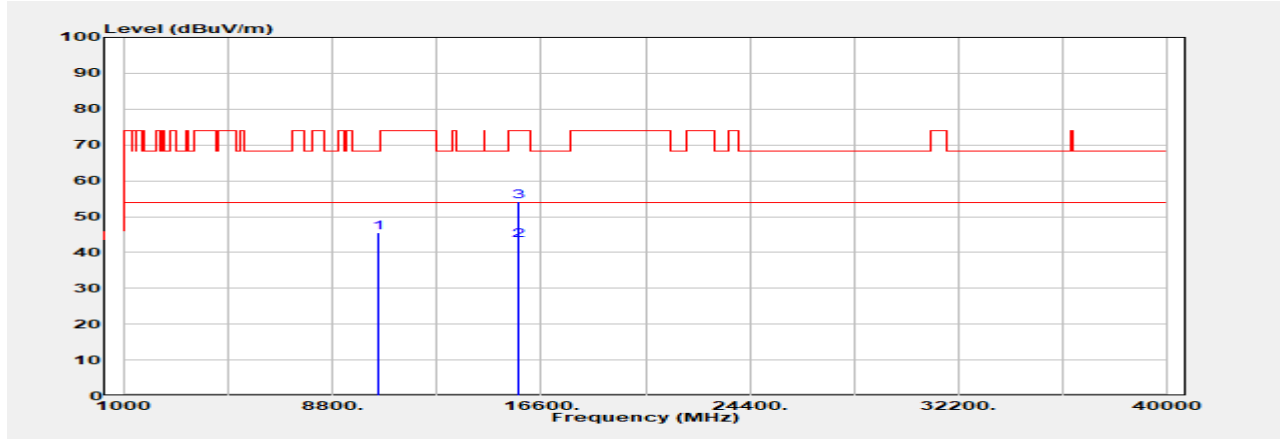

Freq. MHz	Detector Mode PK/QP/AVG	Spectrum Reading Level dB $\mu$ V	Factor dB	Actual FS dB $\mu$ V/m	Limit @3m dB $\mu$ V/m	Margin dB
10480.000	Peak	36.30	9.31	45.61	68.20	-22.59
15720.000	Average	29.94	13.49	43.43	54.00	-10.57
15720.000	Peak	40.81	13.49	54.30	74.00	-19.70

Unless otherwise stated the results shown in this test report refer only to the sample(s) tested and such sample(s) are retained for 90 days only.

除非另有說明，此報告結果僅對測試之樣品負責，同時此樣品僅保留90天。本報告未經本公司書面許可，不可部份複製。

This document is issued by the Company subject to its General Conditions of Service printed overleaf, available on request or accessible at <http://www.sgs.com.tw/Terms-and-Conditions> and for electronic format documents, subject to Terms and Conditions for Electronic Documents at <http://www.sgs.com.tw/Terms-and-Conditions>. Attention is drawn to the limitation of liability, indemnification and jurisdiction issues defined therein. Any holder of this document is advised that information contained hereon reflects the Company's findings at the time of its intervention only and within the limits of Client's instructions, if any. The Company's sole responsibility is to its Client and this document does not exonerate parties to a transaction from exercising all their rights and obligations under the transaction documents. This document cannot be reproduced except in full, without prior written approval of the Company. Any unauthorized alteration, forgery or falsification of the content or appearance of this document is unlawful and offenders may be prosecuted to the fullest extent of the law.

Report Number :TERF2404000927E2  
 Operation Mode :802.11a  
 Test Frequency :5240 MHz  
 Test Mode :Tx  
 EUT Pol :E2 Plane

Test Site :SAC G Chamber  
 Test Date :2024-04-24  
 Temp./Humi. :22.1°C/57%  
 Antenna Pol. :Horizontal  
 Engineer :Temo Chen

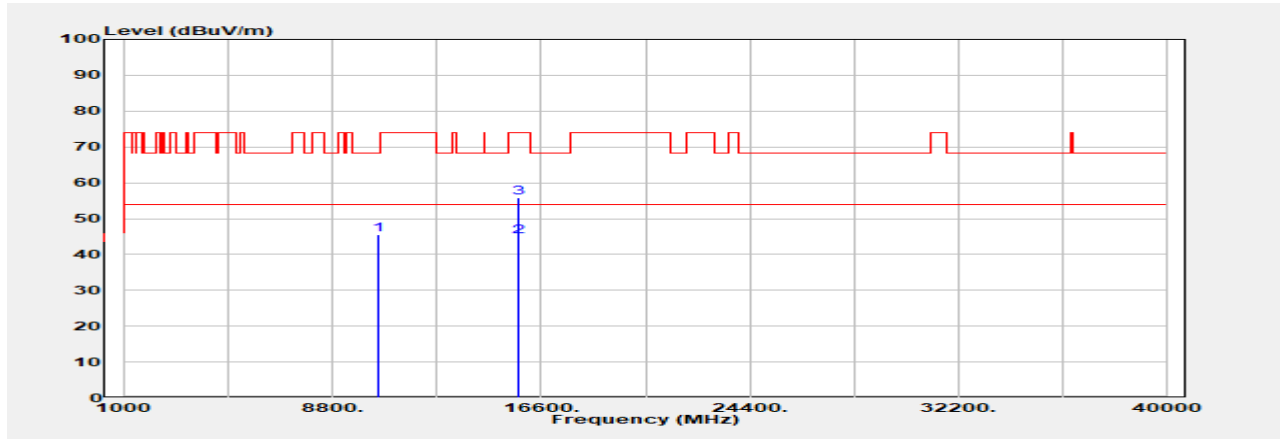

Freq. MHz	Detector Mode PK/QP/AVG	Spectrum Reading Level dB $\mu$ V	Factor dB	Actual FS dB $\mu$ V/m	Limit @3m dB $\mu$ V/m	Margin dB
10480.000	Peak	36.30	9.31	45.62	68.20	-22.58
15720.000	Average	31.55	13.49	45.04	54.00	-8.96
15720.000	Peak	42.33	13.49	55.83	74.00	-18.17

Unless otherwise stated the results shown in this test report refer only to the sample(s) tested and such sample(s) are retained for 90 days only.

除非另有說明，此報告結果僅對測試之樣品負責，同時此樣品僅保留90天。本報告未經本公司書面許可，不可部份複製。

This document is issued by the Company subject to its General Conditions of Service printed overleaf, available on request or accessible at <http://www.sgs.com.tw/Terms-and-Conditions> and for electronic format documents, subject to Terms and Conditions for Electronic Documents at <http://www.sgs.com.tw/Terms-and-Conditions>. Attention is drawn to the limitation of liability, indemnification and jurisdiction issues defined therein. Any holder of this document is advised that information contained hereon reflects the Company's findings at the time of its intervention only and within the limits of Client's instructions, if any. The Company's sole responsibility is to its Client and this document does not exonerate parties to a transaction from exercising all their rights and obligations under the transaction documents. This document cannot be reproduced except in full, without prior written approval of the Company. Any unauthorized alteration, forgery or falsification of the content or appearance of this document is unlawful and offenders may be prosecuted to the fullest extent of the law.

Report Number :TERF2404000927E2  
 Operation Mode :802.11a  
 Test Frequency :5260 MHz  
 Test Mode :Tx  
 EUT Pol :E2 Plane

Test Site :SAC G Chamber  
 Test Date :2024-04-24  
 Temp./Humi. :22.1°C/57%  
 Antenna Pol. :Vertical  
 Engineer :Temo Chen

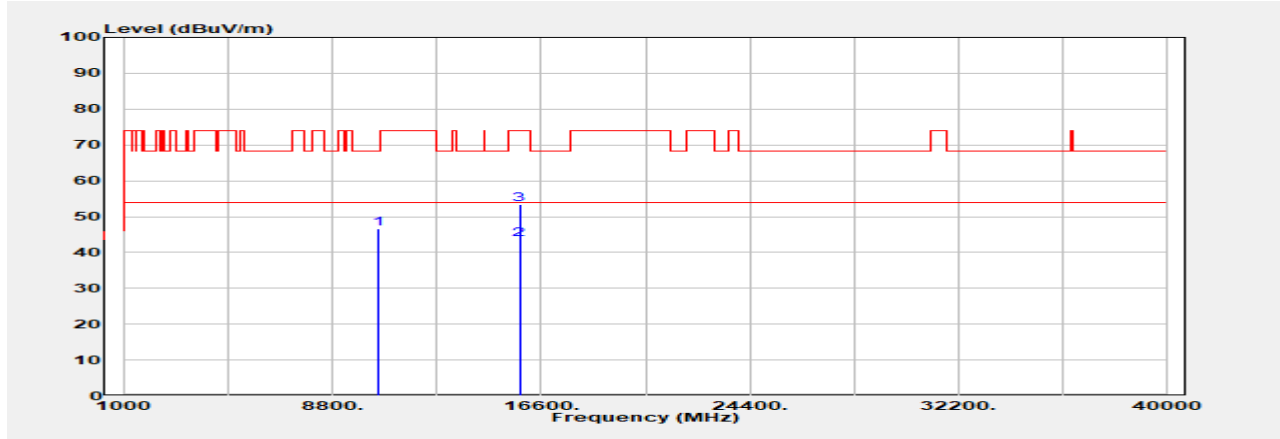

Freq. MHz	Detector Mode PK/QP/AVG	Spectrum Reading Level dB $\mu$ V	Factor dB	Actual FS dB $\mu$ V/m	Limit @3m dB $\mu$ V/m	Margin dB
10520.000	Peak	37.25	9.25	46.50	68.20	-21.70
15780.000	Average	30.48	13.08	43.56	54.00	-10.44
15780.000	Peak	40.35	13.08	53.43	74.00	-20.57

Unless otherwise stated the results shown in this test report refer only to the sample(s) tested and such sample(s) are retained for 90 days only.

除非另有說明，此報告結果僅對測試之樣品負責，同時此樣品僅保留90天。本報告未經本公司書面許可，不可部份複製。

This document is issued by the Company subject to its General Conditions of Service printed overleaf, available on request or accessible at <http://www.sgs.com.tw/Terms-and-Conditions> and for electronic format documents, subject to Terms and Conditions for Electronic Documents at <http://www.sgs.com.tw/Terms-and-Conditions>. Attention is drawn to the limitation of liability, indemnification and jurisdiction issues defined therein. Any holder of this document is advised that information contained hereon reflects the Company's findings at the time of its intervention only and within the limits of Client's instructions, if any. The Company's sole responsibility is to its Client and this document does not exonerate parties to a transaction from exercising all their rights and obligations under the transaction documents. This document cannot be reproduced except in full, without prior written approval of the Company. Any unauthorized alteration, forgery or falsification of the content or appearance of this document is unlawful and offenders may be prosecuted to the fullest extent of the law.



Report Number :TERF2404000927E2  
 Operation Mode :802.11a  
 Test Frequency :5260 MHz  
 Test Mode :Tx  
 EUT Pol :E2 Plane

Test Site :SAC G Chamber  
 Test Date :2024-04-24  
 Temp./Humi. :22.1°C/57%  
 Antenna Pol. :Horizontal  
 Engineer :Temo Chen

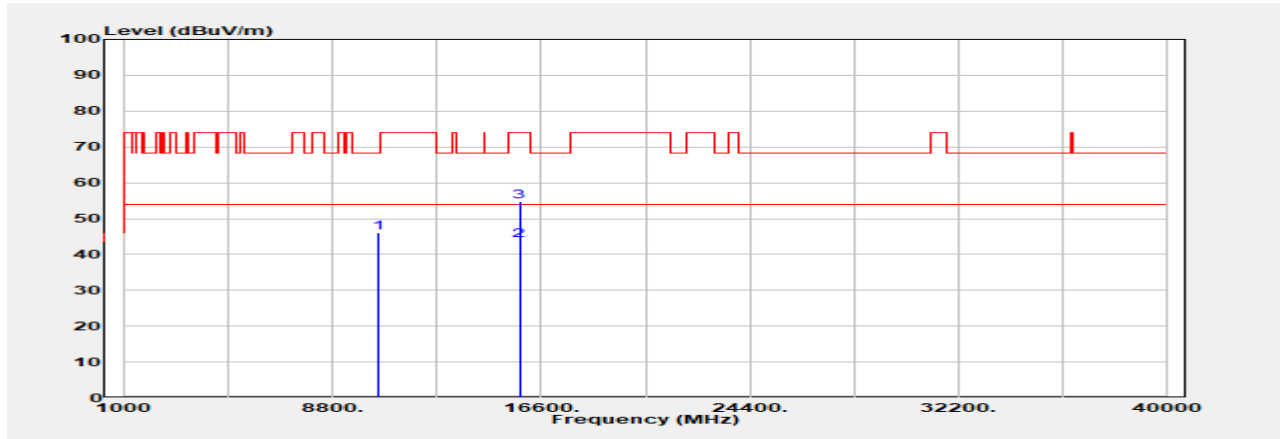

Freq. MHz	Detector Mode PK/QP/AVG	Spectrum Reading Level dB $\mu$ V	Factor dB	Actual FS dB $\mu$ V/m	Limit @3m dB $\mu$ V/m	Margin dB
10520.000	Peak	36.72	9.25	45.97	68.20	-22.23
15780.000	Average	30.94	13.08	44.01	54.00	-9.99
15780.000	Peak	41.53	13.08	54.61	74.00	-19.39

Unless otherwise stated the results shown in this test report refer only to the sample(s) tested and such sample(s) are retained for 90 days only.

除非另有說明，此報告結果僅對測試之樣品負責，同時此樣品僅保留90天。本報告未經本公司書面許可，不可部份複製。

This document is issued by the Company subject to its General Conditions of Service printed overleaf, available on request or accessible at <http://www.sgs.com.tw/Terms-and-Conditions> and for electronic format documents, subject to Terms and Conditions for Electronic Documents at <http://www.sgs.com.tw/Terms-and-Conditions>. Attention is drawn to the limitation of liability, indemnification and jurisdiction issues defined therein. Any holder of this document is advised that information contained hereon reflects the Company's findings at the time of its intervention only and within the limits of Client's instructions, if any. The Company's sole responsibility is to its Client and this document does not exonerate parties to a transaction from exercising all their rights and obligations under the transaction documents. This document cannot be reproduced except in full, without prior written approval of the Company. Any unauthorized alteration, forgery or falsification of the content or appearance of this document is unlawful and offenders may be prosecuted to the fullest extent of the law.

Report Number :TERF2404000927E2  
 Operation Mode :802.11a  
 Test Frequency :5300 MHz  
 Test Mode :Tx  
 EUT Pol :E2 Plane

Test Site :SAC G Chamber  
 Test Date :2024-04-24  
 Temp./Humi. :22.1°C/57%  
 Antenna Pol. :Vertical  
 Engineer :Temo Chen

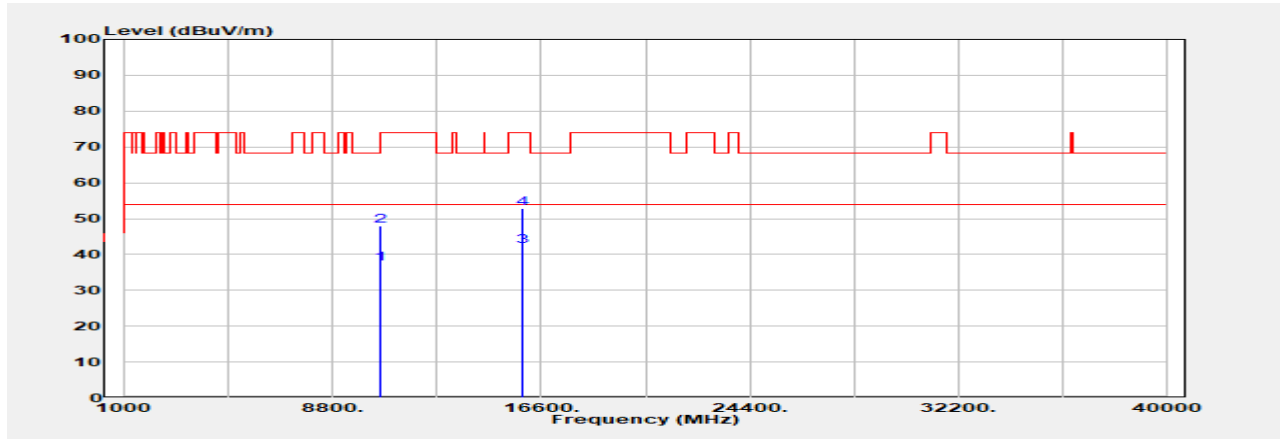

Freq. MHz	Detector Mode PK/QP/AVG	Spectrum Reading Level dB $\mu$ V	Factor dB	Actual FS dB $\mu$ V/m	Limit @3m dB $\mu$ V/m	Margin dB
10600.000	Average	27.68	9.74	37.42	54.00	-16.58
10600.000	Peak	38.26	9.74	48.00	74.00	-26.00
15900.000	Average	29.39	12.95	42.34	54.00	-11.66
15900.000	Peak	39.76	12.95	52.71	74.00	-21.29

Unless otherwise stated the results shown in this test report refer only to the sample(s) tested and such sample(s) are retained for 90 days only.

除非另有說明，此報告結果僅對測試之樣品負責，同時此樣品僅保留90天。本報告未經本公司書面許可，不可部份複製。

This document is issued by the Company subject to its General Conditions of Service printed overleaf, available on request or accessible at <http://www.sgs.com.tw/Terms-and-Conditions> and for electronic format documents, subject to Terms and Conditions for Electronic Documents at <http://www.sgs.com.tw/Terms-and-Conditions>. Attention is drawn to the limitation of liability, indemnification and jurisdiction issues defined therein. Any holder of this document is advised that information contained hereon reflects the Company's findings at the time of its intervention only and within the limits of Client's instructions, if any. The Company's sole responsibility is to its Client and this document does not exonerate parties to a transaction from exercising all their rights and obligations under the transaction documents. This document cannot be reproduced except in full, without prior written approval of the Company. Any unauthorized alteration, forgery or falsification of the content or appearance of this document is unlawful and offenders may be prosecuted to the fullest extent of the law.

Report Number :TERF2404000927E2  
 Operation Mode :802.11a  
 Test Frequency :5300 MHz  
 Test Mode :Tx  
 EUT Pol :E2 Plane

Test Site :SAC G Chamber  
 Test Date :2024-04-24  
 Temp./Humi. :22.1°C/57%  
 Antenna Pol. :Horizontal  
 Engineer :Temo Chen

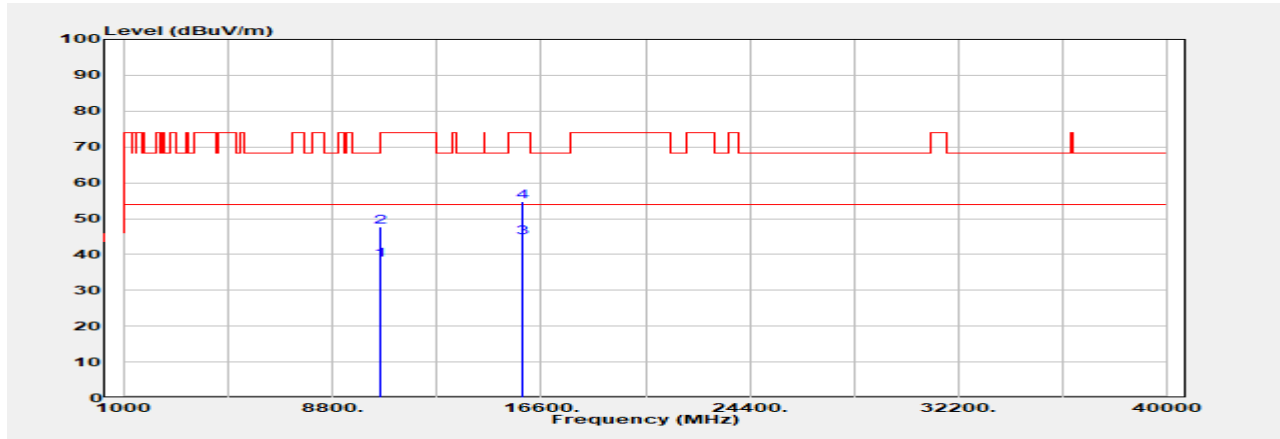

Freq. MHz	Detector Mode PK/QP/AVG	Spectrum Reading Level dBμV	Factor dB	Actual FS dBμV/m	Limit @3m dBμV/m	Margin dB
10600.000	Average	28.74	9.74	38.48	54.00	-15.52
10600.000	Peak	37.85	9.74	47.59	74.00	-26.41
15900.000	Average	31.73	12.95	44.68	54.00	-9.32
15900.000	Peak	41.78	12.95	54.73	74.00	-19.27

Unless otherwise stated the results shown in this test report refer only to the sample(s) tested and such sample(s) are retained for 90 days only.

除非另有說明，此報告結果僅對測試之樣品負責，同時此樣品僅保留90天。本報告未經本公司書面許可，不可部份複製。

This document is issued by the Company subject to its General Conditions of Service printed overleaf, available on request or accessible at <http://www.sgs.com.tw/Terms-and-Conditions> and for electronic format documents, subject to Terms and Conditions for Electronic Documents at <http://www.sgs.com.tw/Terms-and-Conditions>. Attention is drawn to the limitation of liability, indemnification and jurisdiction issues defined therein. Any holder of this document is advised that information contained hereon reflects the Company's findings at the time of its intervention only and within the limits of Client's instructions, if any. The Company's sole responsibility is to its Client and this document does not exonerate parties to a transaction from exercising all their rights and obligations under the transaction documents. This document cannot be reproduced except in full, without prior written approval of the Company. Any unauthorized alteration, forgery or falsification of the content or appearance of this document is unlawful and offenders may be prosecuted to the fullest extent of the law.

Report Number :TERF2404000927E2  
 Operation Mode :802.11a  
 Test Frequency :5320 MHz  
 Test Mode :Tx  
 EUT Pol :E2 Plane

Test Site :SAC G Chamber  
 Test Date :2024-04-25  
 Temp./Humi. :23.0°C/59%  
 Antenna Pol. :Vertical  
 Engineer :Temo Chen

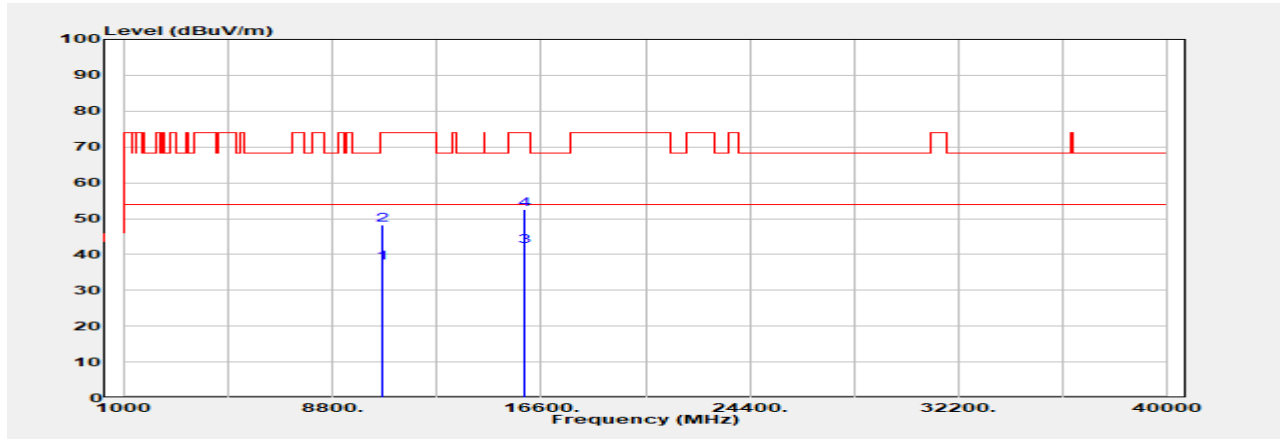

Freq. MHz	Detector Mode PK/QP/AVG	Spectrum Reading Level dB $\mu$ V	Factor dB	Actual FS dB $\mu$ V/m	Limit @3m dB $\mu$ V/m	Margin dB
10640.000	Average	27.87	9.74	37.61	54.00	-16.39
10640.000	Peak	38.52	9.74	48.26	74.00	-25.74
15960.000	Average	29.85	12.50	42.35	54.00	-11.65
15960.000	Peak	40.02	12.50	52.52	74.00	-21.48

Unless otherwise stated the results shown in this test report refer only to the sample(s) tested and such sample(s) are retained for 90 days only.

除非另有說明，此報告結果僅對測試之樣品負責，同時此樣品僅保留90天。本報告未經本公司書面許可，不可部份複製。

This document is issued by the Company subject to its General Conditions of Service printed overleaf, available on request or accessible at <http://www.sgs.com.tw/Terms-and-Conditions> and for electronic format documents, subject to Terms and Conditions for Electronic Documents at <http://www.sgs.com.tw/Terms-and-Conditions>. Attention is drawn to the limitation of liability, indemnification and jurisdiction issues defined therein. Any holder of this document is advised that information contained hereon reflects the Company's findings at the time of its intervention only and within the limits of Client's instructions, if any. The Company's sole responsibility is to its Client and this document does not exonerate parties to a transaction from exercising all their rights and obligations under the transaction documents. This document cannot be reproduced except in full, without prior written approval of the Company. Any unauthorized alteration, forgery or falsification of the content or appearance of this document is unlawful and offenders may be prosecuted to the fullest extent of the law.

Report Number :TERF2404000927E2  
 Operation Mode :802.11a  
 Test Frequency :5320 MHz  
 Test Mode :Tx  
 EUT Pol :E2 Plane

Test Site :SAC G Chamber  
 Test Date :2024-04-25  
 Temp./Humi. :23.0°C/59%  
 Antenna Pol. :Horizontal  
 Engineer :Temo Chen

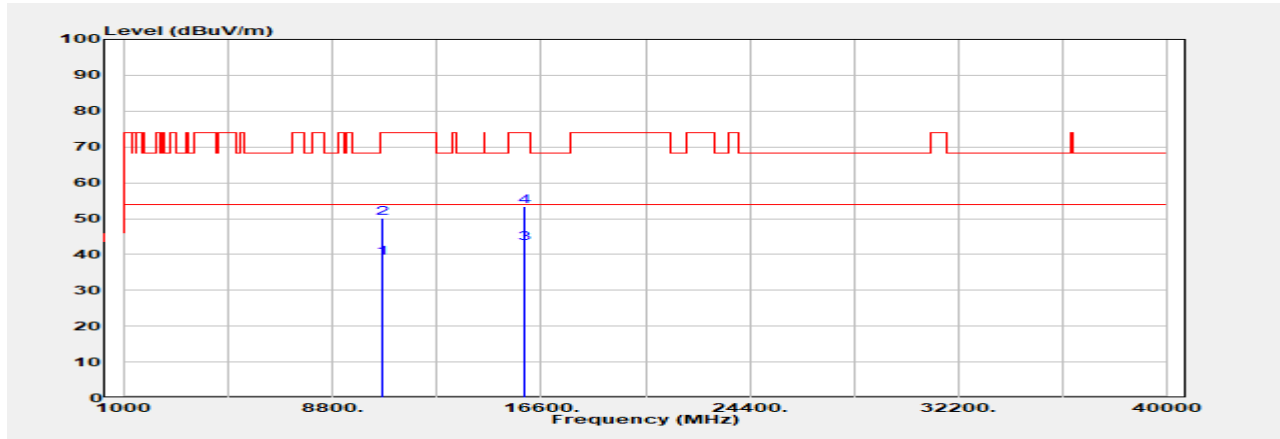

Freq. MHz	Detector Mode PK/QP/AVG	Spectrum Reading Level dBμV	Factor dB	Actual FS dBμV/m	Limit @3m dBμV/m	Margin dB
10640.000	Average	29.22	9.74	38.95	54.00	-15.05
10640.000	Peak	40.32	9.74	50.06	74.00	-23.94
15960.000	Average	30.51	12.50	43.01	54.00	-10.99
15960.000	Peak	40.88	12.50	53.38	74.00	-20.62

Unless otherwise stated the results shown in this test report refer only to the sample(s) tested and such sample(s) are retained for 90 days only.

除非另有說明，此報告結果僅對測試之樣品負責，同時此樣品僅保留90天。本報告未經本公司書面許可，不可部份複製。

This document is issued by the Company subject to its General Conditions of Service printed overleaf, available on request or accessible at <http://www.sgs.com.tw/Terms-and-Conditions> and for electronic format documents, subject to Terms and Conditions for Electronic Documents at <http://www.sgs.com.tw/Terms-and-Conditions>. Attention is drawn to the limitation of liability, indemnification and jurisdiction issues defined therein. Any holder of this document is advised that information contained hereon reflects the Company's findings at the time of its intervention only and within the limits of Client's instructions, if any. The Company's sole responsibility is to its Client and this document does not exonerate parties to a transaction from exercising all their rights and obligations under the transaction documents. This document cannot be reproduced except in full, without prior written approval of the Company. Any unauthorized alteration, forgery or falsification of the content or appearance of this document is unlawful and offenders may be prosecuted to the fullest extent of the law.

Report Number :TERF2404000927E2  
 Operation Mode :802.11a  
 Test Frequency :5500 MHz  
 Test Mode :Tx  
 EUT Pol :E2 Plane

Test Site :SAC G Chamber  
 Test Date :2024-04-25  
 Temp./Humi. :23.0°C/59%  
 Antenna Pol. :Vertical  
 Engineer :Temo Chen

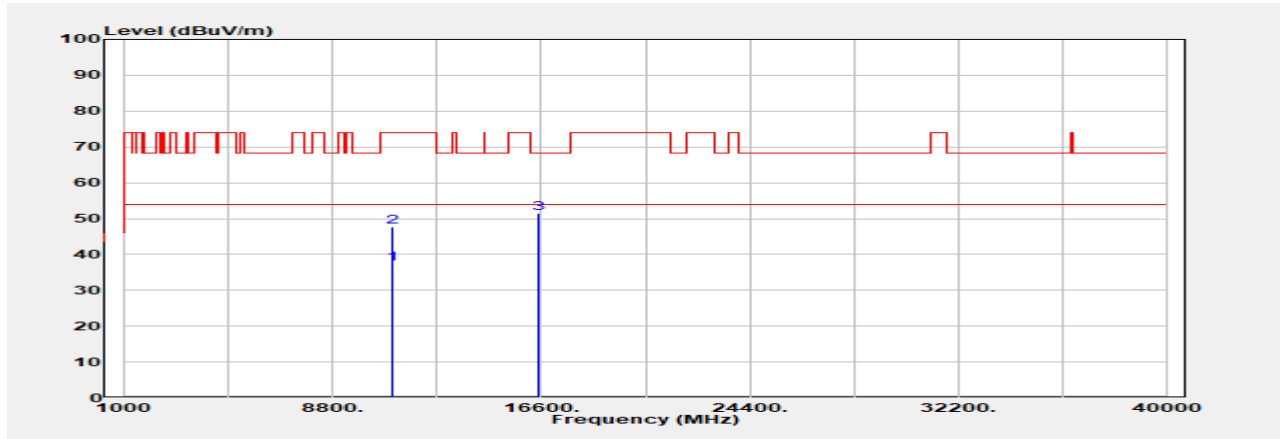

Freq. MHz	Detector Mode PK/QP/AVG	Spectrum Reading Level dB $\mu$ V	Factor dB	Actual FS dB $\mu$ V/m	Limit @3m dB $\mu$ V/m	Margin dB
11000.000	Average	27.35	10.07	37.42	54.00	-16.58
11000.000	Peak	37.67	10.07	47.74	74.00	-26.26
16500.000	Peak	38.90	12.65	51.55	68.20	-16.65

Unless otherwise stated the results shown in this test report refer only to the sample(s) tested and such sample(s) are retained for 90 days only.

除非另有說明，此報告結果僅對測試之樣品負責，同時此樣品僅保留90天。本報告未經本公司書面許可，不可部份複製。

This document is issued by the Company subject to its General Conditions of Service printed overleaf, available on request or accessible at <http://www.sgs.com.tw/Terms-and-Conditions> and for electronic format documents, subject to Terms and Conditions for Electronic Documents at <http://www.sgs.com.tw/Terms-and-Conditions>. Attention is drawn to the limitation of liability, indemnification and jurisdiction issues defined therein. Any holder of this document is advised that information contained hereon reflects the Company's findings at the time of its intervention only and within the limits of Client's instructions, if any. The Company's sole responsibility is to its Client and this document does not exonerate parties to a transaction from exercising all their rights and obligations under the transaction documents. This document cannot be reproduced except in full, without prior written approval of the Company. Any unauthorized alteration, forgery or falsification of the content or appearance of this document is unlawful and offenders may be prosecuted to the fullest extent of the law.

Report Number :TERF2404000927E2  
 Operation Mode :802.11a  
 Test Frequency :5500 MHz  
 Test Mode :Tx  
 EUT Pol :E2 Plane

Test Site :SAC G Chamber  
 Test Date :2024-04-25  
 Temp./Humi. :23.0°C/59%  
 Antenna Pol. :Horizontal  
 Engineer :Temo Chen

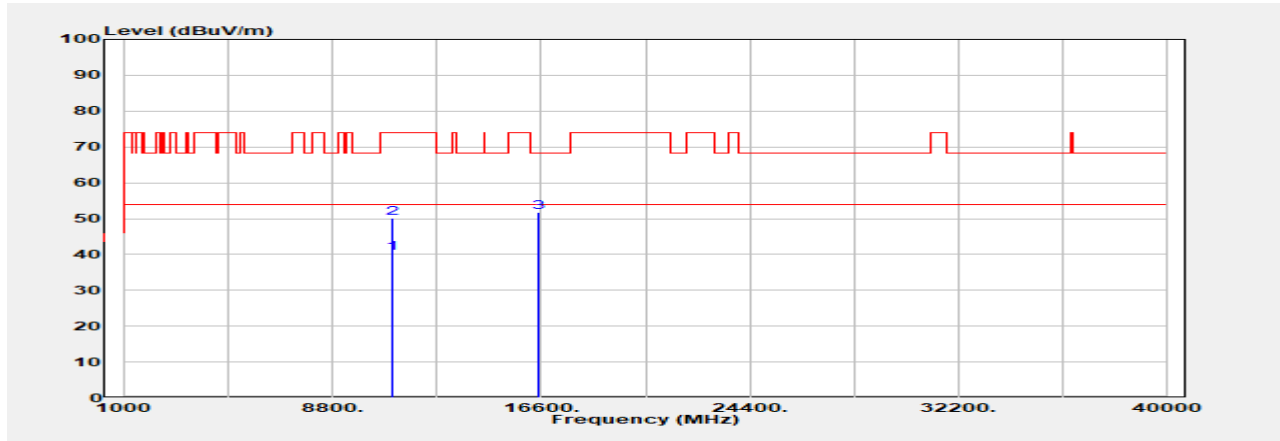

Freq. MHz	Detector Mode PK/QP/AVG	Spectrum Reading Level dB $\mu$ V	Factor dB	Actual FS dB $\mu$ V/m	Limit @3m dB $\mu$ V/m	Margin dB
11000.000	Average	30.18	10.07	40.25	54.00	-13.75
11000.000	Peak	40.11	10.07	50.18	74.00	-23.82
16500.000	Peak	39.06	12.65	51.71	68.20	-16.49

Unless otherwise stated the results shown in this test report refer only to the sample(s) tested and such sample(s) are retained for 90 days only.

除非另有說明，此報告結果僅對測試之樣品負責，同時此樣品僅保留90天。本報告未經本公司書面許可，不可部份複製。

This document is issued by the Company subject to its General Conditions of Service printed overleaf, available on request or accessible at <http://www.sgs.com.tw/Terms-and-Conditions> and for electronic format documents, subject to Terms and Conditions for Electronic Documents at <http://www.sgs.com.tw/Terms-and-Conditions>. Attention is drawn to the limitation of liability, indemnification and jurisdiction issues defined therein. Any holder of this document is advised that information contained hereon reflects the Company's findings at the time of its intervention only and within the limits of Client's instructions, if any. The Company's sole responsibility is to its Client and this document does not exonerate parties to a transaction from exercising all their rights and obligations under the transaction documents. This document cannot be reproduced except in full, without prior written approval of the Company. Any unauthorized alteration, forgery or falsification of the content or appearance of this document is unlawful and offenders may be prosecuted to the fullest extent of the law.



Report Number :TERF2404000927E2  
 Operation Mode :802.11a  
 Test Frequency :5580 MHz  
 Test Mode :Tx  
 EUT Pol :E2 Plane

Test Site :SAC G Chamber  
 Test Date :2024-04-25  
 Temp./Humi. :23.0°C/59%  
 Antenna Pol. :Vertical  
 Engineer :Temo Chen

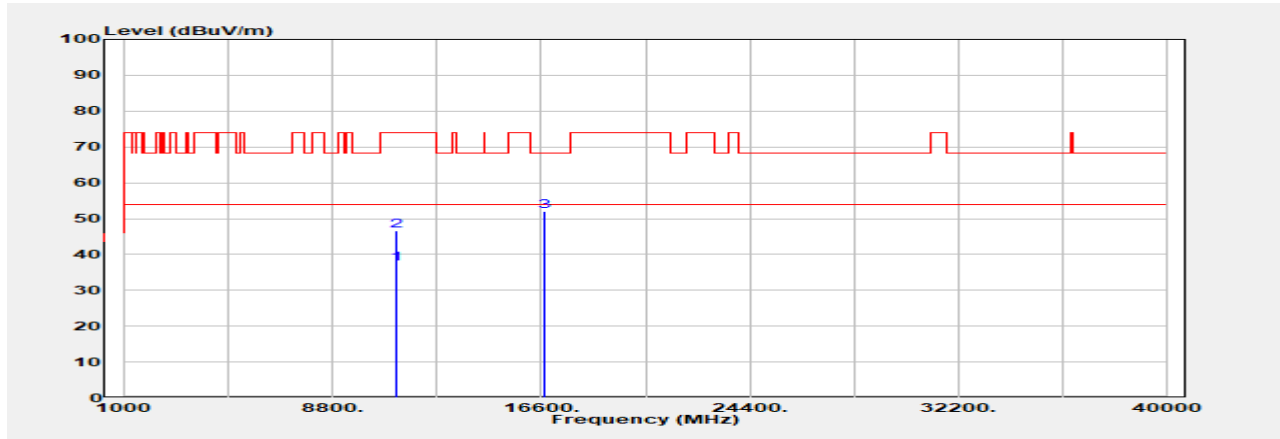

Freq. MHz	Detector Mode PK/QP/AVG	Spectrum Reading Level dB $\mu$ V	Factor dB	Actual FS dB $\mu$ V/m	Limit @3m dB $\mu$ V/m	Margin dB
11160.000	Average	27.52	9.90	37.42	54.00	-16.58
11160.000	Peak	36.66	9.90	46.56	74.00	-27.44
16740.000	Peak	39.64	12.28	51.92	68.20	-16.28

Unless otherwise stated the results shown in this test report refer only to the sample(s) tested and such sample(s) are retained for 90 days only.

除非另有說明，此報告結果僅對測試之樣品負責，同時此樣品僅保留90天。本報告未經本公司書面許可，不可部份複製。

This document is issued by the Company subject to its General Conditions of Service printed overleaf, available on request or accessible at <http://www.sgs.com.tw/Terms-and-Conditions> and for electronic format documents, subject to Terms and Conditions for Electronic Documents at <http://www.sgs.com.tw/Terms-and-Conditions>. Attention is drawn to the limitation of liability, indemnification and jurisdiction issues defined therein. Any holder of this document is advised that information contained hereon reflects the Company's findings at the time of its intervention only and within the limits of Client's instructions, if any. The Company's sole responsibility is to its Client and this document does not exonerate parties to a transaction from exercising all their rights and obligations under the transaction documents. This document cannot be reproduced except in full, without prior written approval of the Company. Any unauthorized alteration, forgery or falsification of the content or appearance of this document is unlawful and offenders may be prosecuted to the fullest extent of the law.

Report Number :TERF2404000927E2  
 Operation Mode :802.11a  
 Test Frequency :5580 MHz  
 Test Mode :Tx  
 EUT Pol :E2 Plane

Test Site :SAC G Chamber  
 Test Date :2024-04-25  
 Temp./Humi. :23.0°C/59%  
 Antenna Pol. :Horizontal  
 Engineer :Temo Chen

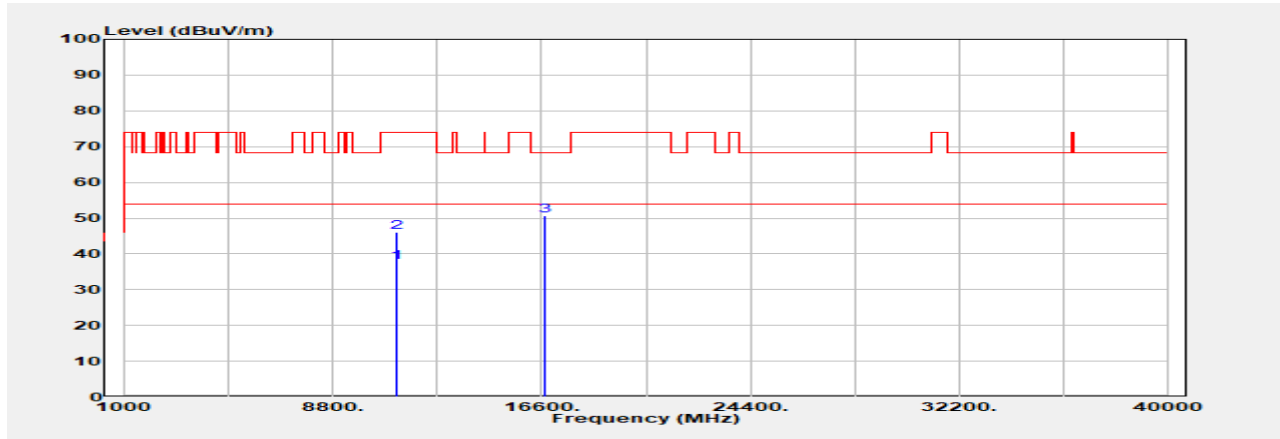

Freq. MHz	Detector Mode PK/QP/AVG	Spectrum Reading Level dBμV	Factor dB	Actual FS dBμV/m	Limit @3m dBμV/m	Margin dB
11160.000	Average	27.82	9.90	37.72	54.00	-16.28
11160.000	Peak	36.07	9.90	45.96	74.00	-28.04
16740.000	Peak	38.44	12.28	50.72	68.20	-17.48

Unless otherwise stated the results shown in this test report refer only to the sample(s) tested and such sample(s) are retained for 90 days only.

除非另有說明，此報告結果僅對測試之樣品負責，同時此樣品僅保留90天。本報告未經本公司書面許可，不可部份複製。

This document is issued by the Company subject to its General Conditions of Service printed overleaf, available on request or accessible at <http://www.sgs.com.tw/Terms-and-Conditions> and for electronic format documents, subject to Terms and Conditions for Electronic Documents at <http://www.sgs.com.tw/Terms-and-Conditions>. Attention is drawn to the limitation of liability, indemnification and jurisdiction issues defined therein. Any holder of this document is advised that information contained hereon reflects the Company's findings at the time of its intervention only and within the limits of Client's instructions, if any. The Company's sole responsibility is to its Client and this document does not exonerate parties to a transaction from exercising all their rights and obligations under the transaction documents. This document cannot be reproduced except in full, without prior written approval of the Company. Any unauthorized alteration, forgery or falsification of the content or appearance of this document is unlawful and offenders may be prosecuted to the fullest extent of the law.

Report Number :TERF2404000927E2  
 Operation Mode :802.11a  
 Test Frequency :5700 MHz  
 Test Mode :Tx  
 EUT Pol :E2 Plane

Test Site :SAC G Chamber  
 Test Date :2024-04-25  
 Temp./Humi. :23.0°C/59%  
 Antenna Pol. :Vertical  
 Engineer :Temo Chen

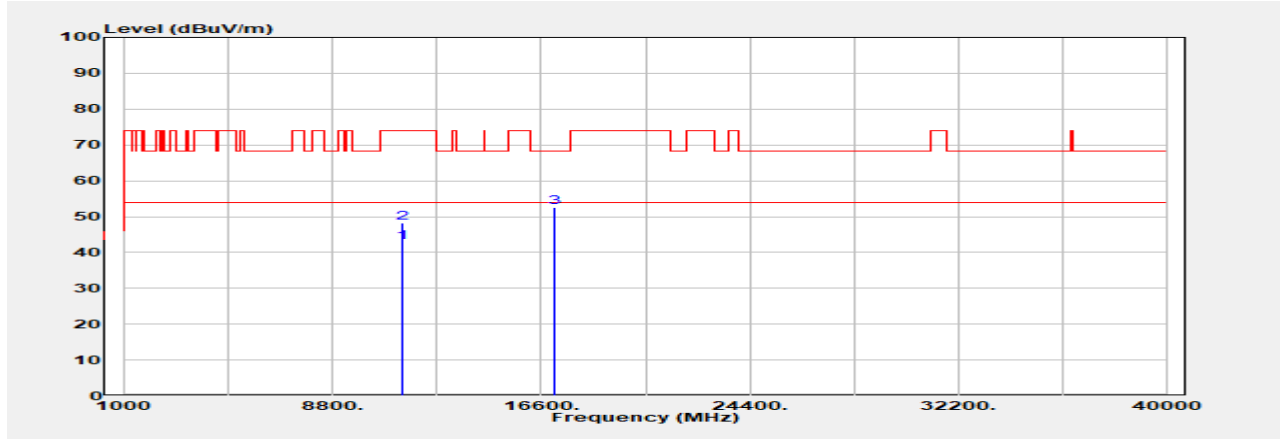

Freq. MHz	Detector Mode PK/QP/AVG	Spectrum Reading Level dBμV	Factor dB	Actual FS dBμV/m	Limit @3m dBμV/m	Margin dB
11400.000	Average	30.72	12.22	42.94	54.00	-11.06
11400.000	Peak	36.05	12.22	48.27	74.00	-25.73
17100.000	Peak	40.28	12.32	52.60	68.20	-15.60

Unless otherwise stated the results shown in this test report refer only to the sample(s) tested and such sample(s) are retained for 90 days only.

除非另有說明，此報告結果僅對測試之樣品負責，同時此樣品僅保留90天。本報告未經本公司書面許可，不可部份複製。

This document is issued by the Company subject to its General Conditions of Service printed overleaf, available on request or accessible at <http://www.sgs.com.tw/Terms-and-Conditions> and for electronic format documents, subject to Terms and Conditions for Electronic Documents at <http://www.sgs.com.tw/Terms-and-Conditions>. Attention is drawn to the limitation of liability, indemnification and jurisdiction issues defined therein. Any holder of this document is advised that information contained hereon reflects the Company's findings at the time of its intervention only and within the limits of Client's instructions, if any. The Company's sole responsibility is to its Client and this document does not exonerate parties to a transaction from exercising all their rights and obligations under the transaction documents. This document cannot be reproduced except in full, without prior written approval of the Company. Any unauthorized alteration, forgery or falsification of the content or appearance of this document is unlawful and offenders may be prosecuted to the fullest extent of the law.

Report Number :TERF2404000927E2  
 Operation Mode :802.11a  
 Test Frequency :5700 MHz  
 Test Mode :Tx  
 EUT Pol :E2 Plane

Test Site :SAC G Chamber  
 Test Date :2024-04-25  
 Temp./Humi. :23.0°C/59%  
 Antenna Pol. :Horizontal  
 Engineer :Temo Chen

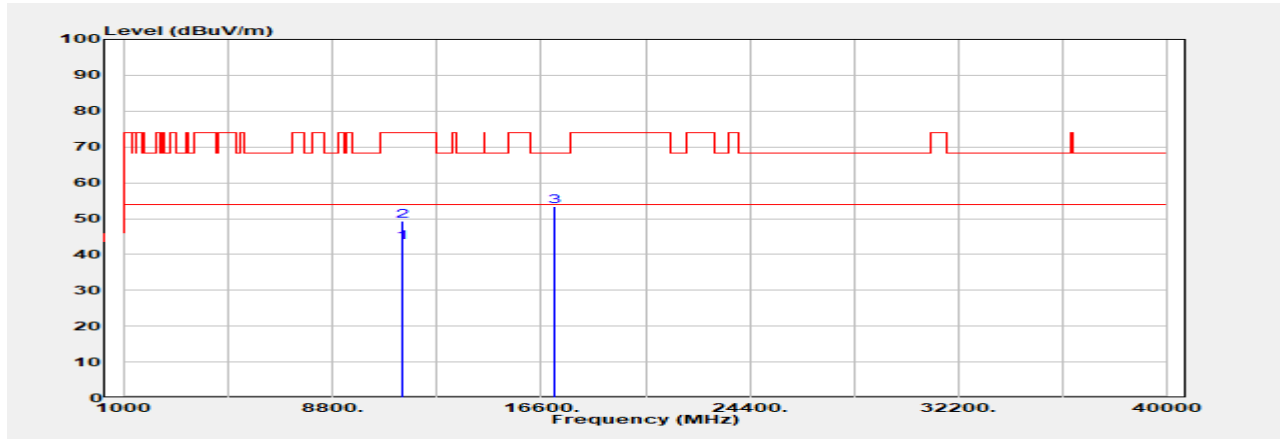

Freq. MHz	Detector Mode PK/QP/AVG	Spectrum Reading Level dBμV	Factor dB	Actual FS dBμV/m	Limit @3m dBμV/m	Margin dB
11400.000	Average	31.26	12.22	43.48	54.00	-10.52
11400.000	Peak	37.12	12.22	49.34	74.00	-24.66
17100.000	Peak	40.99	12.32	53.31	68.20	-14.89

Unless otherwise stated the results shown in this test report refer only to the sample(s) tested and such sample(s) are retained for 90 days only.

除非另有說明，此報告結果僅對測試之樣品負責，同時此樣品僅保留90天。本報告未經本公司書面許可，不可部份複製。

This document is issued by the Company subject to its General Conditions of Service printed overleaf, available on request or accessible at <http://www.sgs.com.tw/Terms-and-Conditions> and for electronic format documents, subject to Terms and Conditions for Electronic Documents at <http://www.sgs.com.tw/Terms-and-Conditions>. Attention is drawn to the limitation of liability, indemnification and jurisdiction issues defined therein. Any holder of this document is advised that information contained hereon reflects the Company's findings at the time of its intervention only and within the limits of Client's instructions, if any. The Company's sole responsibility is to its Client and this document does not exonerate parties to a transaction from exercising all their rights and obligations under the transaction documents. This document cannot be reproduced except in full, without prior written approval of the Company. Any unauthorized alteration, forgery or falsification of the content or appearance of this document is unlawful and offenders may be prosecuted to the fullest extent of the law.

Report Number :TERF2404000927E2

Test Site :SAC G Chamber

Operation Mode :802.11a

Test Date :2024-04-25

Test Frequency :5720 MHz

Temp./Humi. :23.0°C/59%

Test Mode :Tx

Antenna Pol. :Vertical

EUT Pol :E2 Plane

Engineer :Temo Chen

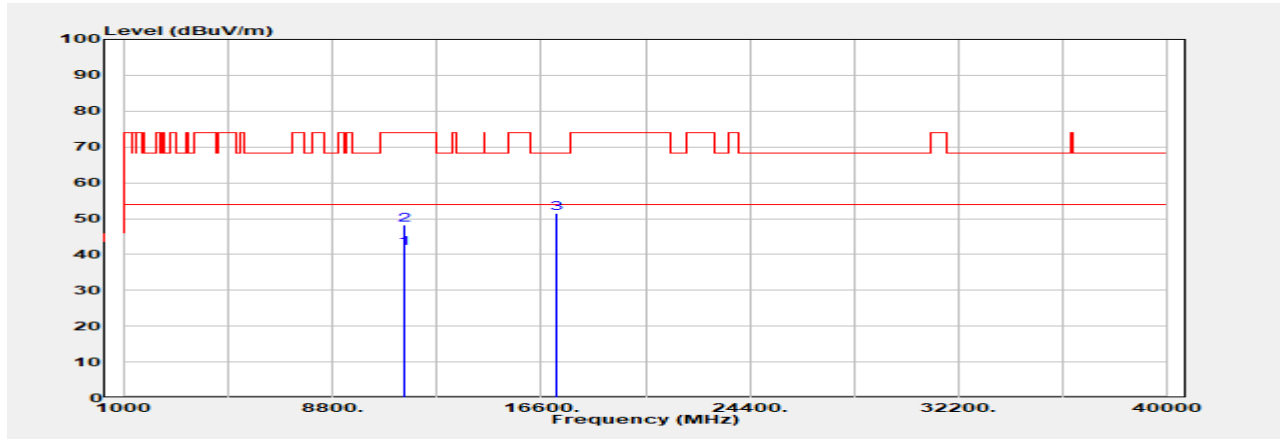

Freq. MHz	Detector Mode PK/QP/AVG	Spectrum Reading Level dBμV	Factor dB	Actual FS dBμV/m	Limit @3m dBμV/m	Margin dB
11440.000	Average	30.45	11.39	41.84	54.00	-12.16
11440.000	Peak	36.83	11.39	48.21	74.00	-25.79
17160.000	Peak	39.54	11.94	51.48	68.20	-16.72

Unless otherwise stated the results shown in this test report refer only to the sample(s) tested and such sample(s) are retained for 90 days only.

除非另有說明，此報告結果僅對測試之樣品負責，同時此樣品僅保留90天。本報告未經本公司書面許可，不可部份複製。

This document is issued by the Company subject to its General Conditions of Service printed overleaf, available on request or accessible at <http://www.sgs.com.tw/Terms-and-Conditions> and for electronic format documents, subject to Terms and Conditions for Electronic Documents at <http://www.sgs.com.tw/Terms-and-Conditions>. Attention is drawn to the limitation of liability, indemnification and jurisdiction issues defined therein. Any holder of this document is advised that information contained hereon reflects the Company's findings at the time of its intervention only and within the limits of Client's instructions, if any. The Company's sole responsibility is to its Client and this document does not exonerate parties to a transaction from exercising all their rights and obligations under the transaction documents. This document cannot be reproduced except in full, without prior written approval of the Company. Any unauthorized alteration, forgery or falsification of the content or appearance of this document is unlawful and offenders may be prosecuted to the fullest extent of the law.

Report Number :TERF2404000927E2	Test Site :SAC G Chamber
Operation Mode :802.11a	Test Date :2024-04-25
Test Frequency :5720 MHz	Temp./Humi. :23.0°C/59%
Test Mode :Tx	Antenna Pol. :Horizontal
EUT Pol :E2 Plane	Engineer :Temo Chen

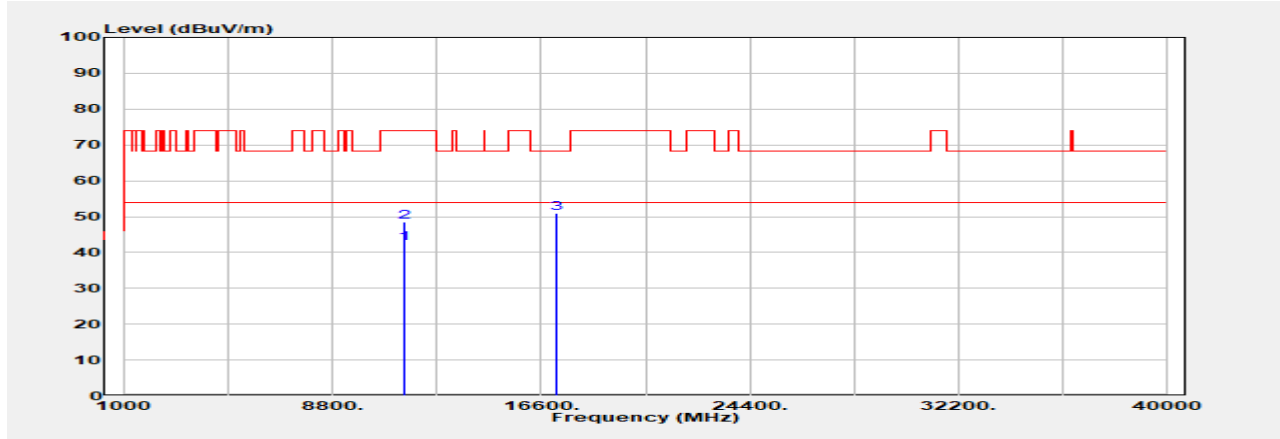

Freq. MHz	Detector Mode PK/QP/AVG	Spectrum Reading Level dBμV	Factor dB	Actual FS dBμV/m	Limit @3m dBμV/m	Margin dB
11440.000	Average	31.19	11.39	42.58	54.00	-11.42
11440.000	Peak	37.01	11.39	48.40	74.00	-25.60
17160.000	Peak	39.00	11.94	50.95	68.20	-17.25

Unless otherwise stated the results shown in this test report refer only to the sample(s) tested and such sample(s) are retained for 90 days only.

除非另有說明，此報告結果僅對測試之樣品負責，同時此樣品僅保留90天。本報告未經本公司書面許可，不可部份複製。

This document is issued by the Company subject to its General Conditions of Service printed overleaf, available on request or accessible at <http://www.sgs.com.tw/Terms-and-Conditions> and for electronic format documents, subject to Terms and Conditions for Electronic Documents at <http://www.sgs.com.tw/Terms-and-Conditions>. Attention is drawn to the limitation of liability, indemnification and jurisdiction issues defined therein. Any holder of this document is advised that information contained hereon reflects the Company's findings at the time of its intervention only and within the limits of Client's instructions, if any. The Company's sole responsibility is to its Client and this document does not exonerate parties to a transaction from exercising all their rights and obligations under the transaction documents. This document cannot be reproduced except in full, without prior written approval of the Company. Any unauthorized alteration, forgery or falsification of the content or appearance of this document is unlawful and offenders may be prosecuted to the fullest extent of the law.

Report Number :TERF2404000927E2  
 Operation Mode :802.11a  
 Test Frequency :5785 MHz  
 Test Mode :Tx  
 EUT Pol :E2 Plane

Test Site :SAC G Chamber  
 Test Date :2024-04-25  
 Temp./Humi. :23.0°C/59%  
 Antenna Pol. :Vertical  
 Engineer :Temo Chen

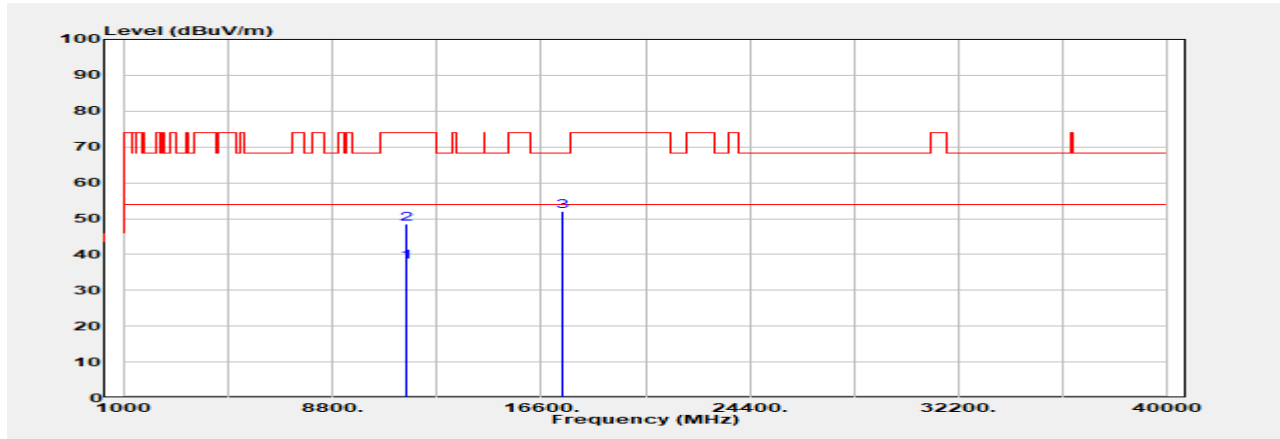

Freq. MHz	Detector Mode PK/QP/AVG	Spectrum Reading Level dB $\mu$ V	Factor dB	Actual FS dB $\mu$ V/m	Limit @3m dB $\mu$ V/m	Margin dB
11570.000	Average	27.81	10.22	38.03	54.00	-15.97
11570.000	Peak	38.29	10.22	48.51	74.00	-25.49
17355.000	Peak	39.41	12.59	51.99	68.20	-16.21

Unless otherwise stated the results shown in this test report refer only to the sample(s) tested and such sample(s) are retained for 90 days only.

除非另有說明，此報告結果僅對測試之樣品負責，同時此樣品僅保留90天。本報告未經本公司書面許可，不可部份複製。

This document is issued by the Company subject to its General Conditions of Service printed overleaf, available on request or accessible at <http://www.sgs.com.tw/Terms-and-Conditions> and for electronic format documents, subject to Terms and Conditions for Electronic Documents at <http://www.sgs.com.tw/Terms-and-Conditions>. Attention is drawn to the limitation of liability, indemnification and jurisdiction issues defined therein. Any holder of this document is advised that information contained hereon reflects the Company's findings at the time of its intervention only and within the limits of Client's instructions, if any. The Company's sole responsibility is to its Client and this document does not exonerate parties to a transaction from exercising all their rights and obligations under the transaction documents. This document cannot be reproduced except in full, without prior written approval of the Company. Any unauthorized alteration, forgery or falsification of the content or appearance of this document is unlawful and offenders may be prosecuted to the fullest extent of the law.



Report Number :TERF2404000927E2	Test Site :SAC G Chamber
Operation Mode :802.11a	Test Date :2024-04-25
Test Frequency :5785 MHz	Temp./Humi. :23.0°C/59%
Test Mode :Tx	Antenna Pol. :Horizontal
EUT Pol :E2 Plane	Engineer :Temo Chen

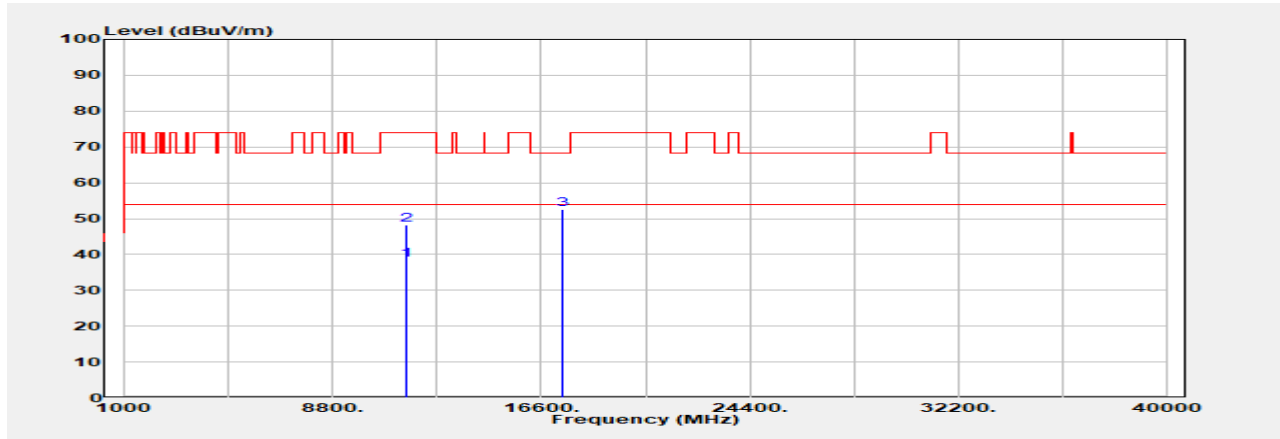

Freq. MHz	Detector Mode PK/QP/AVG	Spectrum Reading Level dBUV	Factor dB	Actual FS dBUV/m	Limit @3m dBUV/m	Margin dB
11570.000	Average	28.31	10.22	38.52	54.00	-15.48
11570.000	Peak	37.91	10.22	48.13	74.00	-25.87
17355.000	Peak	39.87	12.59	52.45	68.20	-15.75

Unless otherwise stated the results shown in this test report refer only to the sample(s) tested and such sample(s) are retained for 90 days only.

除非另有說明，此報告結果僅對測試之樣品負責，同時此樣品僅保留90天。本報告未經本公司書面許可，不可部份複製。

This document is issued by the Company subject to its General Conditions of Service printed overleaf, available on request or accessible at <http://www.sgs.com.tw/Terms-and-Conditions> and for electronic format documents, subject to Terms and Conditions for Electronic Documents at <http://www.sgs.com.tw/Terms-and-Conditions>. Attention is drawn to the limitation of liability, indemnification and jurisdiction issues defined therein. Any holder of this document is advised that information contained hereon reflects the Company's findings at the time of its intervention only and within the limits of Client's instructions, if any. The Company's sole responsibility is to its Client and this document does not exonerate parties to a transaction from exercising all their rights and obligations under the transaction documents. This document cannot be reproduced except in full, without prior written approval of the Company. Any unauthorized alteration, forgery or falsification of the content or appearance of this document is unlawful and offenders may be prosecuted to the fullest extent of the law.

Report Number :TERF2404000927E2

Test Site :SAC G Chamber

Operation Mode :802.11a

Test Date :2024-04-25

Test Frequency :5825 MHz

Temp./Humi. :23.0°C/59%

Test Mode :Tx

Antenna Pol. :Vertical

EUT Pol :E2 Plane

Engineer :Temo Chen

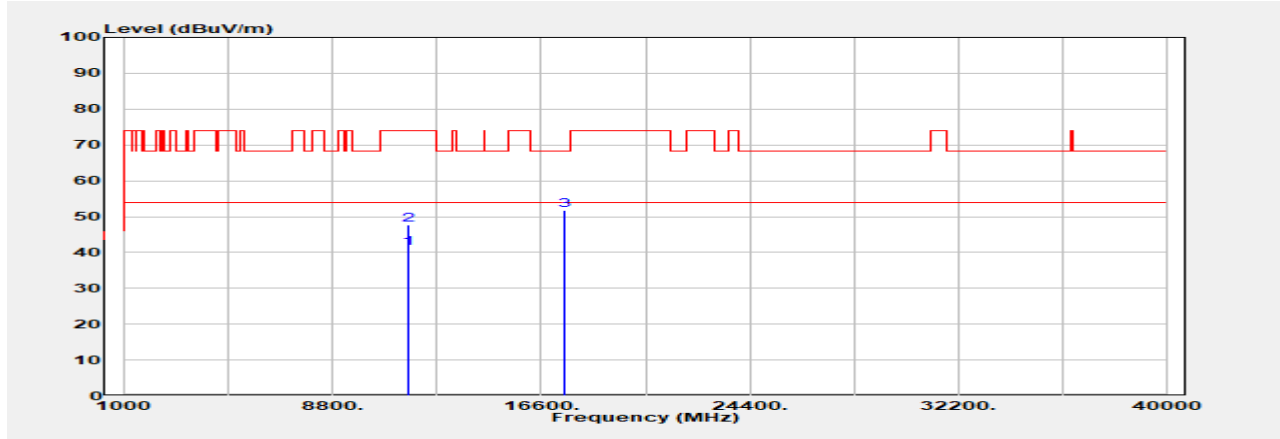

Freq. MHz	Detector Mode PK/QP/AVG	Spectrum Reading Level dB $\mu$ V	Factor dB	Actual FS dB $\mu$ V/m	Limit @3m dB $\mu$ V/m	Margin dB
11650.000	Average	30.58	10.64	41.22	54.00	-12.78
11650.000	Peak	36.94	10.64	47.58	74.00	-26.42
17475.000	Peak	39.17	12.54	51.71	68.20	-16.49

Unless otherwise stated the results shown in this test report refer only to the sample(s) tested and such sample(s) are retained for 90 days only.

除非另有說明，此報告結果僅對測試之樣品負責，同時此樣品僅保留90天。本報告未經本公司書面許可，不可部份複製。

This document is issued by the Company subject to its General Conditions of Service printed overleaf, available on request or accessible at <http://www.sgs.com.tw/Terms-and-Conditions> and for electronic format documents, subject to Terms and Conditions for Electronic Documents at <http://www.sgs.com.tw/Terms-and-Conditions>. Attention is drawn to the limitation of liability, indemnification and jurisdiction issues defined therein. Any holder of this document is advised that information contained hereon reflects the Company's findings at the time of its intervention only and within the limits of Client's instructions, if any. The Company's sole responsibility is to its Client and this document does not exonerate parties to a transaction from exercising all their rights and obligations under the transaction documents. This document cannot be reproduced except in full, without prior written approval of the Company. Any unauthorized alteration, forgery or falsification of the content or appearance of this document is unlawful and offenders may be prosecuted to the fullest extent of the law.

Report Number :TERF2404000927E2	Test Site :SAC G Chamber
Operation Mode :802.11a	Test Date :2024-04-25
Test Frequency :5825 MHz	Temp./Humi. :23.0°C/59%
Test Mode :Tx	Antenna Pol. :Horizontal
EUT Pol :E2 Plane	Engineer :Temo Chen

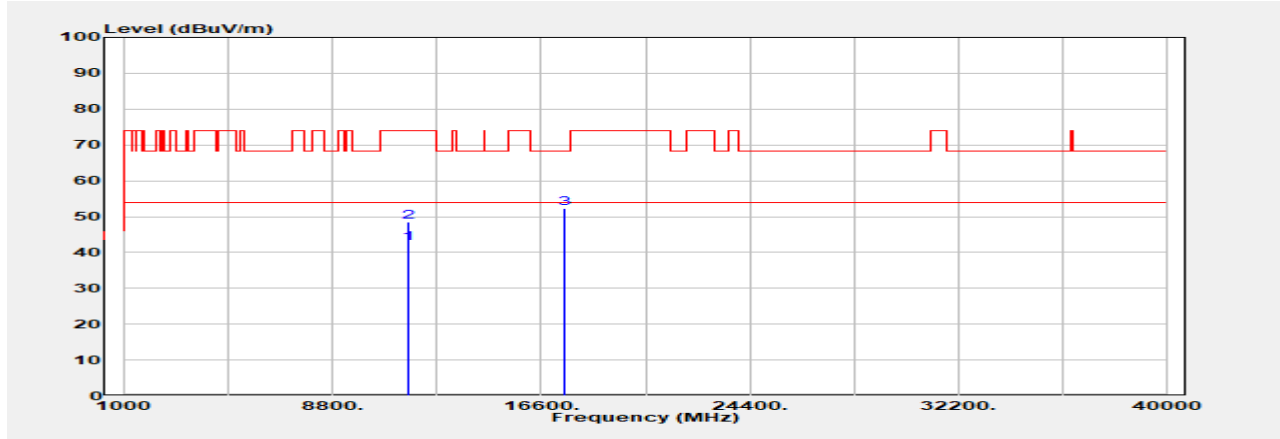

Freq. MHz	Detector Mode PK/QP/AVG	Spectrum Reading Level dBμV	Factor dB	Actual FS dBμV/m	Limit @3m dBμV/m	Margin dB
11650.000	Average	31.78	10.64	42.42	54.00	-11.58
11650.000	Peak	37.75	10.64	48.39	74.00	-25.61
17475.000	Peak	39.68	12.54	52.22	68.20	-15.98

Unless otherwise stated the results shown in this test report refer only to the sample(s) tested and such sample(s) are retained for 90 days only.

除非另有說明，此報告結果僅對測試之樣品負責，同時此樣品僅保留90天。本報告未經本公司書面許可，不可部份複製。

This document is issued by the Company subject to its General Conditions of Service printed overleaf, available on request or accessible at <http://www.sgs.com.tw/Terms-and-Conditions> and for electronic format documents, subject to Terms and Conditions for Electronic Documents at <http://www.sgs.com.tw/Terms-and-Conditions>. Attention is drawn to the limitation of liability, indemnification and jurisdiction issues defined therein. Any holder of this document is advised that information contained hereon reflects the Company's findings at the time of its intervention only and within the limits of Client's instructions, if any. The Company's sole responsibility is to its Client and this document does not exonerate parties to a transaction from exercising all their rights and obligations under the transaction documents. This document cannot be reproduced except in full, without prior written approval of the Company. Any unauthorized alteration, forgery or falsification of the content or appearance of this document is unlawful and offenders may be prosecuted to the fullest extent of the law.

Report Number :TERF2404000927E2  
 Operation Mode :802.11n20  
 Test Frequency :5180 MHz  
 Test Mode :Tx  
 EUT Pol :E2 Plane

Test Site :SAC G Chamber  
 Test Date :2024-04-25  
 Temp./Humi. :23.0°C/59%  
 Antenna Pol. :Vertical  
 Engineer :Temo Chen

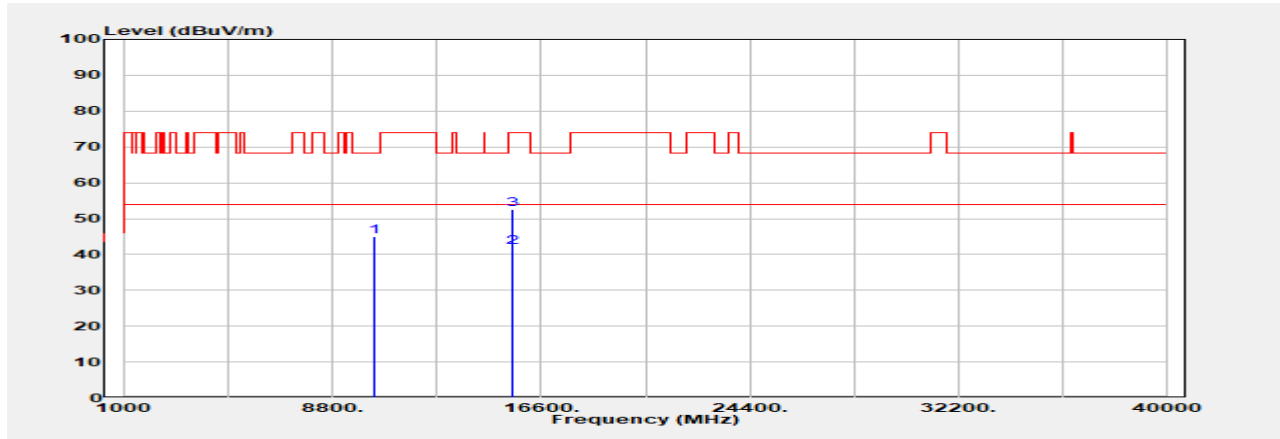

Freq. MHz	Detector Mode PK/QP/AVG	Spectrum Reading Level dB $\mu$ V	Factor dB	Actual FS dB $\mu$ V/m	Limit @3m dB $\mu$ V/m	Margin dB
10360.000	Peak	35.33	9.70	45.03	68.20	-23.17
15540.000	Average	29.76	12.28	42.04	54.00	-11.96
15540.000	Peak	40.35	12.28	52.62	74.00	-21.38

Unless otherwise stated the results shown in this test report refer only to the sample(s) tested and such sample(s) are retained for 90 days only.

除非另有說明，此報告結果僅對測試之樣品負責，同時此樣品僅保留90天。本報告未經本公司書面許可，不可部份複製。

This document is issued by the Company subject to its General Conditions of Service printed overleaf, available on request or accessible at <http://www.sgs.com.tw/Terms-and-Conditions> and for electronic format documents, subject to Terms and Conditions for Electronic Documents at <http://www.sgs.com.tw/Terms-and-Conditions>. Attention is drawn to the limitation of liability, indemnification and jurisdiction issues defined therein. Any holder of this document is advised that information contained hereon reflects the Company's findings at the time of its intervention only and within the limits of Client's instructions, if any. The Company's sole responsibility is to its Client and this document does not exonerate parties to a transaction from exercising all their rights and obligations under the transaction documents. This document cannot be reproduced except in full, without prior written approval of the Company. Any unauthorized alteration, forgery or falsification of the content or appearance of this document is unlawful and offenders may be prosecuted to the fullest extent of the law.

Report Number :TERF2404000927E2  
 Operation Mode :802.11n20  
 Test Frequency :5180 MHz  
 Test Mode :Tx  
 EUT Pol :E2 Plane

Test Site :SAC G Chamber  
 Test Date :2024-04-25  
 Temp./Humi. :23.0°C/59%  
 Antenna Pol. :Horizontal  
 Engineer :Temo Chen

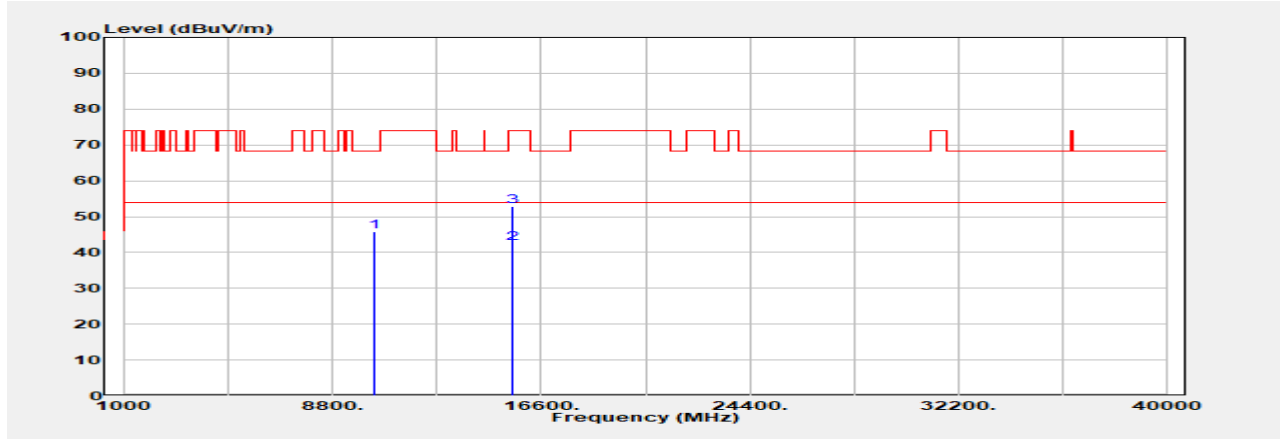

Freq. MHz	Detector Mode PK/QP/AVG	Spectrum Reading Level dB $\mu$ V	Factor dB	Actual FS dB $\mu$ V/m	Limit @3m dB $\mu$ V/m	Margin dB
10360.000	Peak	36.02	9.70	45.72	68.20	-22.48
15540.000	Average	30.21	12.28	42.49	54.00	-11.51
15540.000	Peak	40.44	12.28	52.72	74.00	-21.28

Unless otherwise stated the results shown in this test report refer only to the sample(s) tested and such sample(s) are retained for 90 days only.

除非另有說明，此報告結果僅對測試之樣品負責，同時此樣品僅保留90天。本報告未經本公司書面許可，不可部份複製。

This document is issued by the Company subject to its General Conditions of Service printed overleaf, available on request or accessible at <http://www.sgs.com.tw/Terms-and-Conditions> and for electronic format documents, subject to Terms and Conditions for Electronic Documents at <http://www.sgs.com.tw/Terms-and-Conditions>. Attention is drawn to the limitation of liability, indemnification and jurisdiction issues defined therein. Any holder of this document is advised that information contained hereon reflects the Company's findings at the time of its intervention only and within the limits of Client's instructions, if any. The Company's sole responsibility is to its Client and this document does not exonerate parties to a transaction from exercising all their rights and obligations under the transaction documents. This document cannot be reproduced except in full, without prior written approval of the Company. Any unauthorized alteration, forgery or falsification of the content or appearance of this document is unlawful and offenders may be prosecuted to the fullest extent of the law.

Report Number :TERF2404000927E2  
 Operation Mode :802.11n20  
 Test Frequency :5220 MHz  
 Test Mode :Tx  
 EUT Pol :E2 Plane

Test Site :SAC G Chamber  
 Test Date :2024-04-25  
 Temp./Humi. :23.0°C/59%  
 Antenna Pol. :Vertical  
 Engineer :Temo Chen

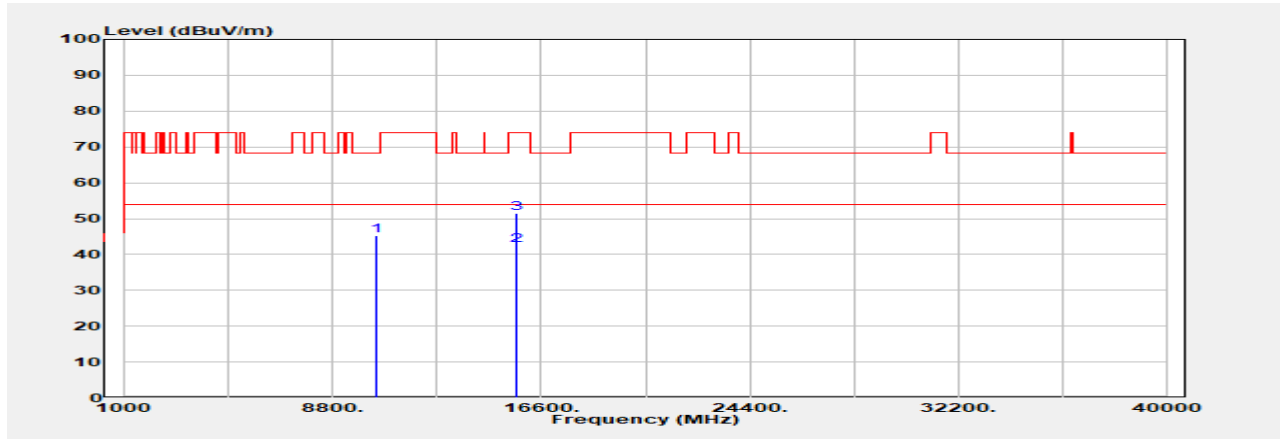

Freq. MHz	Detector Mode PK/QP/AVG	Spectrum Reading Level dB $\mu$ V	Factor dB	Actual FS dB $\mu$ V/m	Limit @3m dB $\mu$ V/m	Margin dB
10440.000	Peak	35.55	9.68	45.23	68.20	-22.97
15660.000	Average	29.54	13.00	42.54	54.00	-11.46
15660.000	Peak	38.54	13.00	51.54	74.00	-22.46

Unless otherwise stated the results shown in this test report refer only to the sample(s) tested and such sample(s) are retained for 90 days only.

除非另有說明，此報告結果僅對測試之樣品負責，同時此樣品僅保留90天。本報告未經本公司書面許可，不可部份複製。

This document is issued by the Company subject to its General Conditions of Service printed overleaf, available on request or accessible at <http://www.sgs.com.tw/Terms-and-Conditions> and for electronic format documents, subject to Terms and Conditions for Electronic Documents at <http://www.sgs.com.tw/Terms-and-Conditions>. Attention is drawn to the limitation of liability, indemnification and jurisdiction issues defined therein. Any holder of this document is advised that information contained hereon reflects the Company's findings at the time of its intervention only and within the limits of Client's instructions, if any. The Company's sole responsibility is to its Client and this document does not exonerate parties to a transaction from exercising all their rights and obligations under the transaction documents. This document cannot be reproduced except in full, without prior written approval of the Company. Any unauthorized alteration, forgery or falsification of the content or appearance of this document is unlawful and offenders may be prosecuted to the fullest extent of the law.

Report Number :TERF2404000927E2  
 Operation Mode :802.11n20  
 Test Frequency :5220 MHz  
 Test Mode :Tx  
 EUT Pol :E2 Plane

Test Site :SAC G Chamber  
 Test Date :2024-04-25  
 Temp./Humi. :23.0°C/59%  
 Antenna Pol. :Horizontal  
 Engineer :Temo Chen

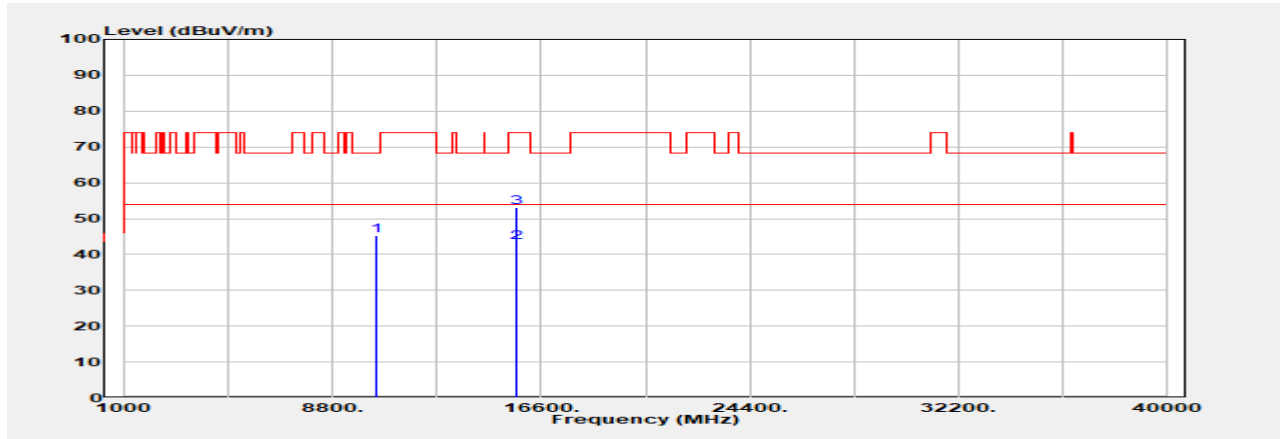

Freq. MHz	Detector Mode PK/QP/AVG	Spectrum Reading Level dB $\mu$ V	Factor dB	Actual FS dB $\mu$ V/m	Limit @3m dB $\mu$ V/m	Margin dB
10440.000	Peak	35.65	9.68	45.33	68.20	-22.87
15660.000	Average	30.27	13.00	43.27	54.00	-10.73
15660.000	Peak	40.02	13.00	53.02	74.00	-20.98

Unless otherwise stated the results shown in this test report refer only to the sample(s) tested and such sample(s) are retained for 90 days only.

除非另有說明，此報告結果僅對測試之樣品負責，同時此樣品僅保留90天。本報告未經本公司書面許可，不可部份複製。

This document is issued by the Company subject to its General Conditions of Service printed overleaf, available on request or accessible at <http://www.sgs.com.tw/Terms-and-Conditions> and for electronic format documents, subject to Terms and Conditions for Electronic Documents at <http://www.sgs.com.tw/Terms-and-Conditions>. Attention is drawn to the limitation of liability, indemnification and jurisdiction issues defined therein. Any holder of this document is advised that information contained hereon reflects the Company's findings at the time of its intervention only and within the limits of Client's instructions, if any. The Company's sole responsibility is to its Client and this document does not exonerate parties to a transaction from exercising all their rights and obligations under the transaction documents. This document cannot be reproduced except in full, without prior written approval of the Company. Any unauthorized alteration, forgery or falsification of the content or appearance of this document is unlawful and offenders may be prosecuted to the fullest extent of the law.



Report Number :TERF2404000927E2  
 Operation Mode :802.11n20  
 Test Frequency :5240 MHz  
 Test Mode :Tx  
 EUT Pol :E2 Plane

Test Site :SAC G Chamber  
 Test Date :2024-04-25  
 Temp./Humi. :23.0°C/59%  
 Antenna Pol. :Vertical  
 Engineer :Temo Chen

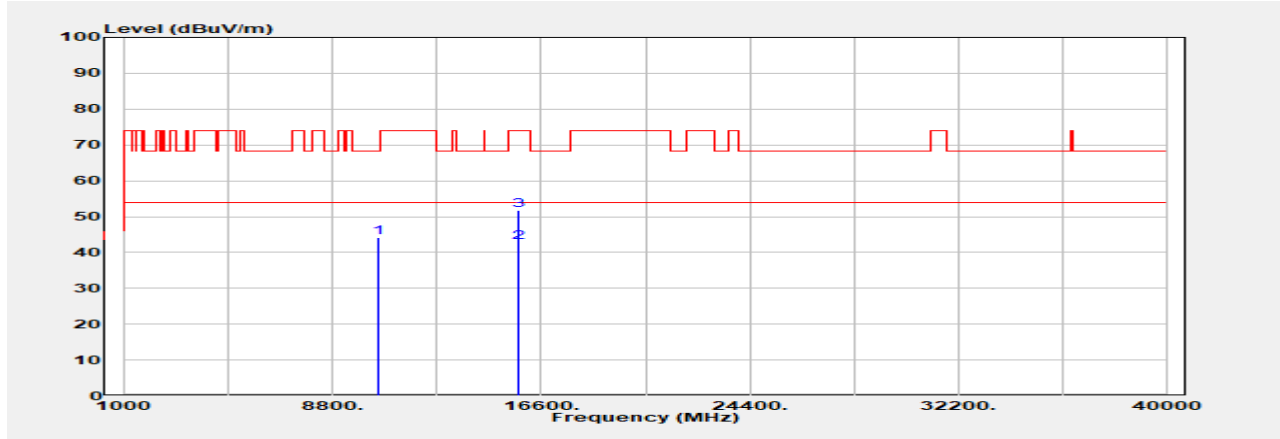

Freq. MHz	Detector Mode PK/QP/AVG	Spectrum Reading Level dB $\mu$ V	Factor dB	Actual FS dB $\mu$ V/m	Limit @3m dB $\mu$ V/m	Margin dB
10480.000	Peak	34.82	9.31	44.13	68.20	-24.07
15720.000	Average	29.38	13.49	42.87	54.00	-11.13
15720.000	Peak	38.23	13.49	51.72	74.00	-22.28

Unless otherwise stated the results shown in this test report refer only to the sample(s) tested and such sample(s) are retained for 90 days only.

除非另有說明，此報告結果僅對測試之樣品負責，同時此樣品僅保留90天。本報告未經本公司書面許可，不可部份複製。

This document is issued by the Company subject to its General Conditions of Service printed overleaf, available on request or accessible at <http://www.sgs.com.tw/Terms-and-Conditions> and for electronic format documents, subject to Terms and Conditions for Electronic Documents at <http://www.sgs.com.tw/Terms-and-Conditions>. Attention is drawn to the limitation of liability, indemnification and jurisdiction issues defined therein. Any holder of this document is advised that information contained hereon reflects the Company's findings at the time of its intervention only and within the limits of Client's instructions, if any. The Company's sole responsibility is to its Client and this document does not exonerate parties to a transaction from exercising all their rights and obligations under the transaction documents. This document cannot be reproduced except in full, without prior written approval of the Company. Any unauthorized alteration, forgery or falsification of the content or appearance of this document is unlawful and offenders may be prosecuted to the fullest extent of the law.

Report Number :TERF2404000927E2  
 Operation Mode :802.11n20  
 Test Frequency :5240 MHz  
 Test Mode :Tx  
 EUT Pol :E2 Plane

Test Site :SAC G Chamber  
 Test Date :2024-04-25  
 Temp./Humi. :23.0°C/59%  
 Antenna Pol. :Horizontal  
 Engineer :Temo Chen

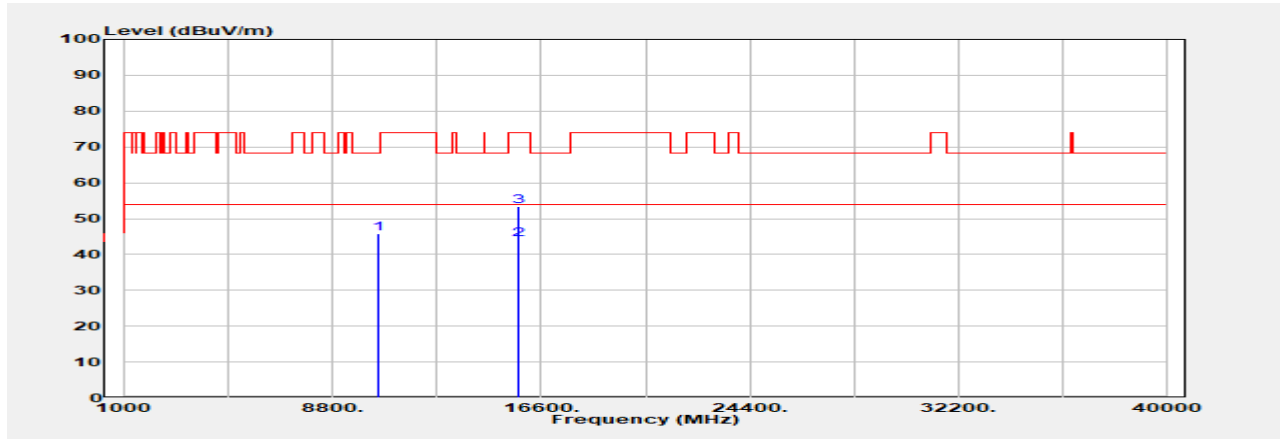

Freq. MHz	Detector Mode PK/QP/AVG	Spectrum Reading Level dBμV	Factor dB	Actual FS dBμV/m	Limit @3m dBμV/m	Margin dB
10480.000	Peak	36.52	9.31	45.83	68.20	-22.37
15720.000	Average	30.57	13.49	44.06	54.00	-9.94
15720.000	Peak	39.95	13.49	53.44	74.00	-20.56

Unless otherwise stated the results shown in this test report refer only to the sample(s) tested and such sample(s) are retained for 90 days only.

除非另有說明，此報告結果僅對測試之樣品負責，同時此樣品僅保留90天。本報告未經本公司書面許可，不可部份複製。

This document is issued by the Company subject to its General Conditions of Service printed overleaf, available on request or accessible at <http://www.sgs.com.tw/Terms-and-Conditions> and for electronic format documents, subject to Terms and Conditions for Electronic Documents at <http://www.sgs.com.tw/Terms-and-Conditions>. Attention is drawn to the limitation of liability, indemnification and jurisdiction issues defined therein. Any holder of this document is advised that information contained hereon reflects the Company's findings at the time of its intervention only and within the limits of Client's instructions, if any. The Company's sole responsibility is to its Client and this document does not exonerate parties to a transaction from exercising all their rights and obligations under the transaction documents. This document cannot be reproduced except in full, without prior written approval of the Company. Any unauthorized alteration, forgery or falsification of the content or appearance of this document is unlawful and offenders may be prosecuted to the fullest extent of the law.

Report Number :TERF2404000927E2  
 Operation Mode :802.11n20  
 Test Frequency :5260 MHz  
 Test Mode :Tx  
 EUT Pol :E2 Plane

Test Site :SAC G Chamber  
 Test Date :2024-04-25  
 Temp./Humi. :23.0°C/59%  
 Antenna Pol. :Vertical  
 Engineer :Temo Chen

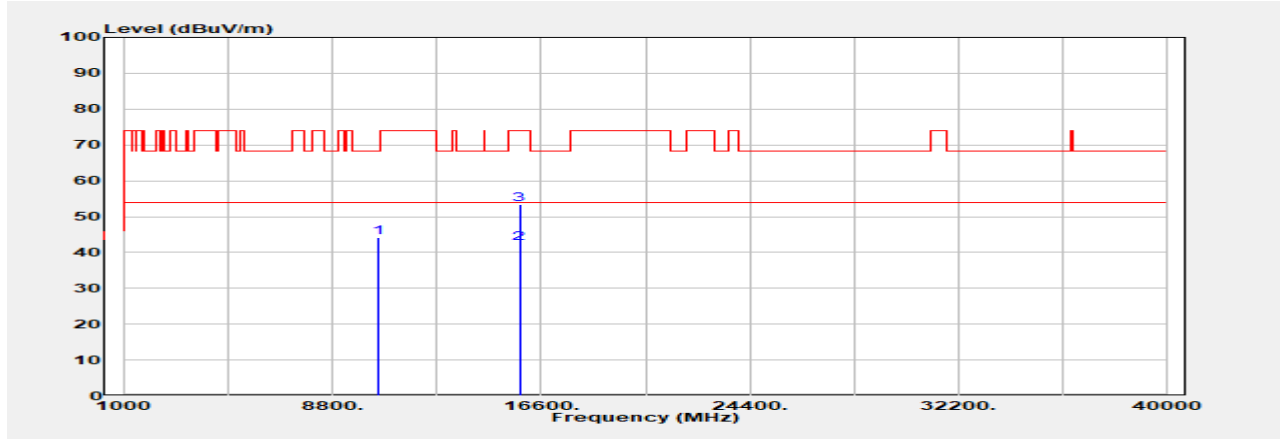

Freq. MHz	Detector Mode PK/QP/AVG	Spectrum Reading Level dB $\mu$ V	Factor dB	Actual FS dB $\mu$ V/m	Limit @3m dB $\mu$ V/m	Margin dB
10520.000	Peak	34.91	9.25	44.16	68.20	-24.04
15780.000	Average	29.48	13.08	42.56	54.00	-11.44
15780.000	Peak	40.38	13.08	53.45	74.00	-20.55

Unless otherwise stated the results shown in this test report refer only to the sample(s) tested and such sample(s) are retained for 90 days only.

除非另有說明，此報告結果僅對測試之樣品負責，同時此樣品僅保留90天。本報告未經本公司書面許可，不可部份複製。

This document is issued by the Company subject to its General Conditions of Service printed overleaf, available on request or accessible at <http://www.sgs.com.tw/Terms-and-Conditions> and for electronic format documents, subject to Terms and Conditions for Electronic Documents at <http://www.sgs.com.tw/Terms-and-Conditions>. Attention is drawn to the limitation of liability, indemnification and jurisdiction issues defined therein. Any holder of this document is advised that information contained hereon reflects the Company's findings at the time of its intervention only and within the limits of Client's instructions, if any. The Company's sole responsibility is to its Client and this document does not exonerate parties to a transaction from exercising all their rights and obligations under the transaction documents. This document cannot be reproduced except in full, without prior written approval of the Company. Any unauthorized alteration, forgery or falsification of the content or appearance of this document is unlawful and offenders may be prosecuted to the fullest extent of the law.

Report Number :TERF2404000927E2  
 Operation Mode :802.11n20  
 Test Frequency :5260 MHz  
 Test Mode :Tx  
 EUT Pol :E2 Plane

Test Site :SAC G Chamber  
 Test Date :2024-04-25  
 Temp./Humi. :23.0°C/59%  
 Antenna Pol. :Horizontal  
 Engineer :Temo Chen

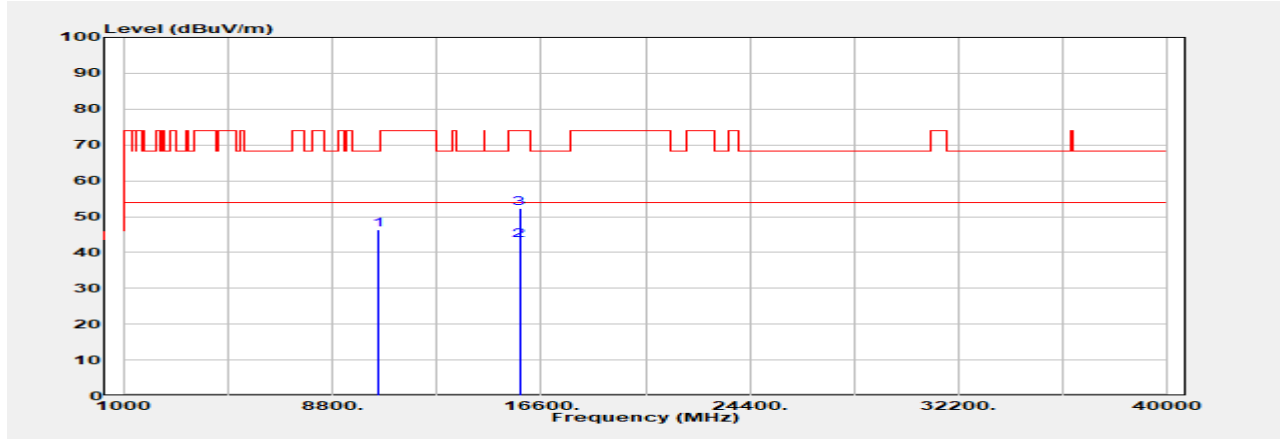

Freq. MHz	Detector Mode PK/QP/AVG	Spectrum Reading Level dB $\mu$ V	Factor dB	Actual FS dB $\mu$ V/m	Limit @3m dB $\mu$ V/m	Margin dB
10520.000	Peak	37.16	9.25	46.41	68.20	-21.79
15780.000	Average	30.36	13.08	43.44	54.00	-10.56
15780.000	Peak	39.33	13.08	52.40	74.00	-21.60

Unless otherwise stated the results shown in this test report refer only to the sample(s) tested and such sample(s) are retained for 90 days only.

除非另有說明，此報告結果僅對測試之樣品負責，同時此樣品僅保留90天。本報告未經本公司書面許可，不可部份複製。

This document is issued by the Company subject to its General Conditions of Service printed overleaf, available on request or accessible at <http://www.sgs.com.tw/Terms-and-Conditions> and for electronic format documents, subject to Terms and Conditions for Electronic Documents at <http://www.sgs.com.tw/Terms-and-Conditions>. Attention is drawn to the limitation of liability, indemnification and jurisdiction issues defined therein. Any holder of this document is advised that information contained hereon reflects the Company's findings at the time of its intervention only and within the limits of Client's instructions, if any. The Company's sole responsibility is to its Client and this document does not exonerate parties to a transaction from exercising all their rights and obligations under the transaction documents. This document cannot be reproduced except in full, without prior written approval of the Company. Any unauthorized alteration, forgery or falsification of the content or appearance of this document is unlawful and offenders may be prosecuted to the fullest extent of the law.

Report Number :TERF2404000927E2  
 Operation Mode :802.11n20  
 Test Frequency :5300 MHz  
 Test Mode :Tx  
 EUT Pol :E2 Plane

Test Site :SAC G Chamber  
 Test Date :2024-04-25  
 Temp./Humi. :23.0°C/59%  
 Antenna Pol. :Vertical  
 Engineer :Temo Chen

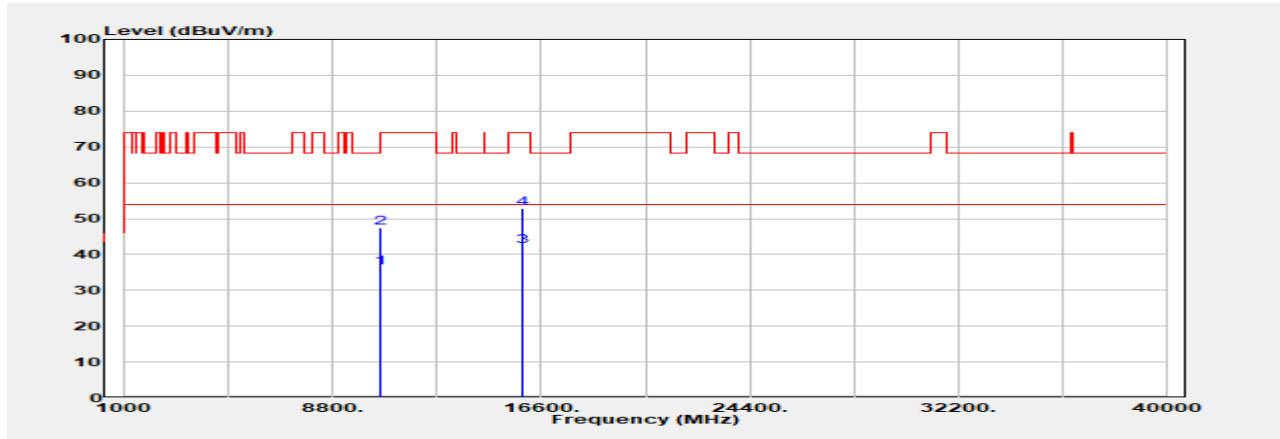

Freq. MHz	Detector Mode PK/QP/AVG	Spectrum Reading Level dBμV	Factor dB	Actual FS dBμV/m	Limit @3m dBμV/m	Margin dB
10600.000	Average	26.63	9.74	36.37	54.00	-17.63
10600.000	Peak	37.57	9.74	47.31	74.00	-26.69
15900.000	Average	29.46	12.95	42.41	54.00	-11.59
15900.000	Peak	39.94	12.95	52.89	74.00	-21.11

Unless otherwise stated the results shown in this test report refer only to the sample(s) tested and such sample(s) are retained for 90 days only.

除非另有說明，此報告結果僅對測試之樣品負責，同時此樣品僅保留90天。本報告未經本公司書面許可，不可部份複製。

This document is issued by the Company subject to its General Conditions of Service printed overleaf, available on request or accessible at <http://www.sgs.com.tw/Terms-and-Conditions> and for electronic format documents, subject to Terms and Conditions for Electronic Documents at <http://www.sgs.com.tw/Terms-and-Conditions>. Attention is drawn to the limitation of liability, indemnification and jurisdiction issues defined therein. Any holder of this document is advised that information contained hereon reflects the Company's findings at the time of its intervention only and within the limits of Client's instructions, if any. The Company's sole responsibility is to its Client and this document does not exonerate parties to a transaction from exercising all their rights and obligations under the transaction documents. This document cannot be reproduced except in full, without prior written approval of the Company. Any unauthorized alteration, forgery or falsification of the content or appearance of this document is unlawful and offenders may be prosecuted to the fullest extent of the law.

Report Number :TERF2404000927E2  
 Operation Mode :802.11n20  
 Test Frequency :5300 MHz  
 Test Mode :Tx  
 EUT Pol :E2 Plane

Test Site :SAC G Chamber  
 Test Date :2024-04-25  
 Temp./Humi. :23.0°C/59%  
 Antenna Pol. :Horizontal  
 Engineer :Temo Chen

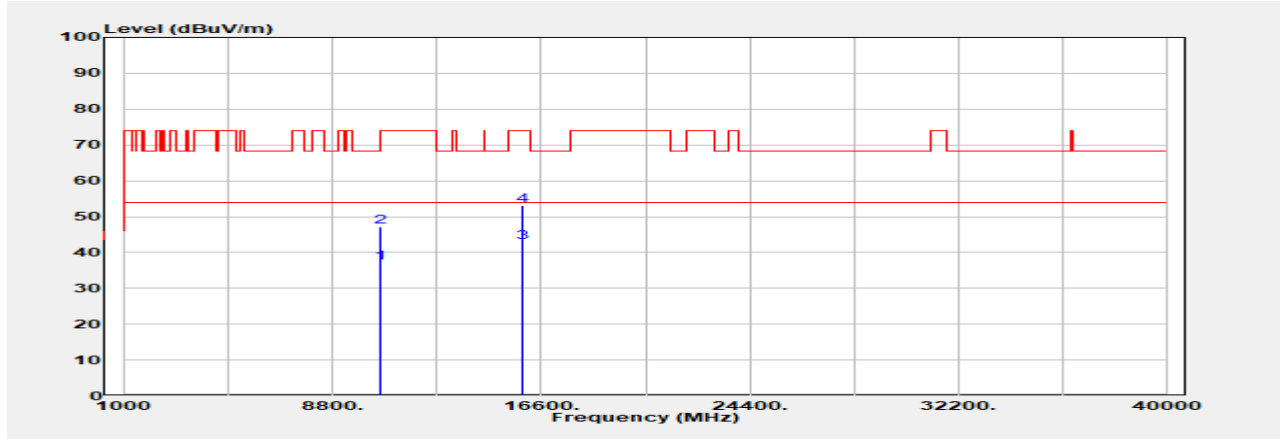

Freq. MHz	Detector Mode PK/QP/AVG	Spectrum Reading Level dB $\mu$ V	Factor dB	Actual FS dB $\mu$ V/m	Limit @3m dB $\mu$ V/m	Margin dB
10600.000	Average	27.48	9.74	37.22	54.00	-16.78
10600.000	Peak	37.35	9.74	47.09	74.00	-26.91
15900.000	Average	29.81	12.95	42.76	54.00	-11.24
15900.000	Peak	40.22	12.95	53.17	74.00	-20.83

Unless otherwise stated the results shown in this test report refer only to the sample(s) tested and such sample(s) are retained for 90 days only.

除非另有說明，此報告結果僅對測試之樣品負責，同時此樣品僅保留90天。本報告未經本公司書面許可，不可部份複製。

This document is issued by the Company subject to its General Conditions of Service printed overleaf, available on request or accessible at <http://www.sgs.com.tw/Terms-and-Conditions> and for electronic format documents, subject to Terms and Conditions for Electronic Documents at <http://www.sgs.com.tw/Terms-and-Conditions>. Attention is drawn to the limitation of liability, indemnification and jurisdiction issues defined therein. Any holder of this document is advised that information contained hereon reflects the Company's findings at the time of its intervention only and within the limits of Client's instructions, if any. The Company's sole responsibility is to its Client and this document does not exonerate parties to a transaction from exercising all their rights and obligations under the transaction documents. This document cannot be reproduced except in full, without prior written approval of the Company. Any unauthorized alteration, forgery or falsification of the content or appearance of this document is unlawful and offenders may be prosecuted to the fullest extent of the law.

Report Number :TERF2404000927E2  
 Operation Mode :802.11n20  
 Test Frequency :5320 MHz  
 Test Mode :Tx  
 EUT Pol :E2 Plane

Test Site :SAC G Chamber  
 Test Date :2024-04-25  
 Temp./Humi. :23.0°C/59%  
 Antenna Pol. :Vertical  
 Engineer :Temo Chen

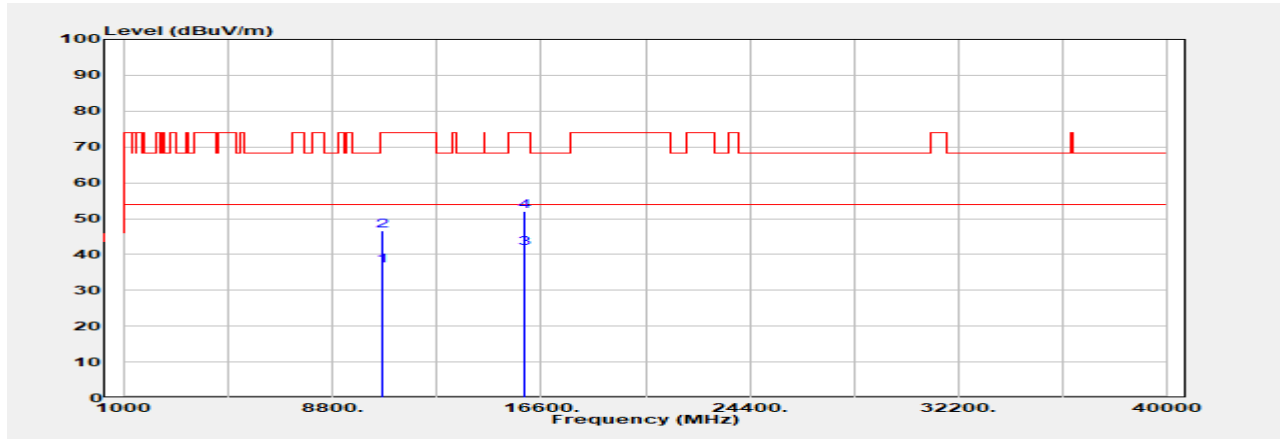

Freq. MHz	Detector Mode PK/QP/AVG	Spectrum Reading Level dBμV	Factor dB	Actual FS dBμV/m	Limit @3m dBμV/m	Margin dB
10640.000	Average	27.20	9.74	36.94	54.00	-17.06
10640.000	Peak	36.98	9.74	46.71	74.00	-27.29
15960.000	Average	29.35	12.50	41.85	54.00	-12.15
15960.000	Peak	39.61	12.50	52.11	74.00	-21.89

Unless otherwise stated the results shown in this test report refer only to the sample(s) tested and such sample(s) are retained for 90 days only.

除非另有說明，此報告結果僅對測試之樣品負責，同時此樣品僅保留90天。本報告未經本公司書面許可，不可部份複製。

This document is issued by the Company subject to its General Conditions of Service printed overleaf, available on request or accessible at <http://www.sgs.com.tw/Terms-and-Conditions> and for electronic format documents, subject to Terms and Conditions for Electronic Documents at <http://www.sgs.com.tw/Terms-and-Conditions>. Attention is drawn to the limitation of liability, indemnification and jurisdiction issues defined therein. Any holder of this document is advised that information contained hereon reflects the Company's findings at the time of its intervention only and within the limits of Client's instructions, if any. The Company's sole responsibility is to its Client and this document does not exonerate parties to a transaction from exercising all their rights and obligations under the transaction documents. This document cannot be reproduced except in full, without prior written approval of the Company. Any unauthorized alteration, forgery or falsification of the content or appearance of this document is unlawful and offenders may be prosecuted to the fullest extent of the law.



Report Number :TERF2404000927E2  
 Operation Mode :802.11n20  
 Test Frequency :5320 MHz  
 Test Mode :Tx  
 EUT Pol :E2 Plane

Test Site :SAC G Chamber  
 Test Date :2024-04-25  
 Temp./Humi. :23.0°C/59%  
 Antenna Pol. :Horizontal  
 Engineer :Temo Chen

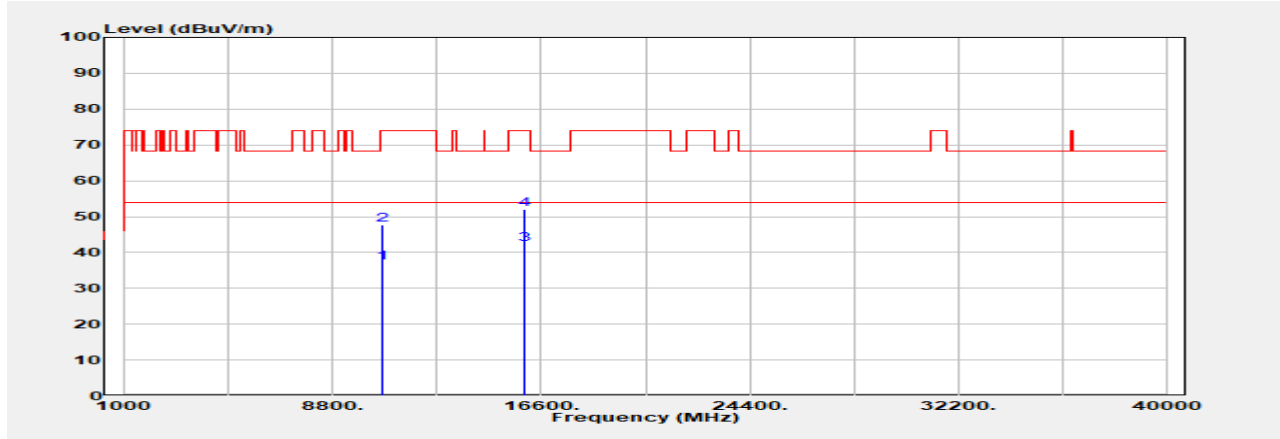

Freq. MHz	Detector Mode PK/QP/AVG	Spectrum Reading Level dBμV	Factor dB	Actual FS dBμV/m	Limit @3m dBμV/m	Margin dB
10640.000	Average	27.45	9.74	37.19	54.00	-16.81
10640.000	Peak	38.06	9.74	47.80	74.00	-26.20
15960.000	Average	29.64	12.50	42.14	54.00	-11.86
15960.000	Peak	39.47	12.50	51.97	74.00	-22.03

Unless otherwise stated the results shown in this test report refer only to the sample(s) tested and such sample(s) are retained for 90 days only.

除非另有說明，此報告結果僅對測試之樣品負責，同時此樣品僅保留90天。本報告未經本公司書面許可，不可部份複製。

This document is issued by the Company subject to its General Conditions of Service printed overleaf, available on request or accessible at <http://www.sgs.com.tw/Terms-and-Conditions> and for electronic format documents, subject to Terms and Conditions for Electronic Documents at <http://www.sgs.com.tw/Terms-and-Conditions>. Attention is drawn to the limitation of liability, indemnification and jurisdiction issues defined therein. Any holder of this document is advised that information contained hereon reflects the Company's findings at the time of its intervention only and within the limits of Client's instructions, if any. The Company's sole responsibility is to its Client and this document does not exonerate parties to a transaction from exercising all their rights and obligations under the transaction documents. This document cannot be reproduced except in full, without prior written approval of the Company. Any unauthorized alteration, forgery or falsification of the content or appearance of this document is unlawful and offenders may be prosecuted to the fullest extent of the law.

Report Number :TERF2404000927E2  
 Operation Mode :802.11n20  
 Test Frequency :5500 MHz  
 Test Mode :Tx  
 EUT Pol :E2 Plane

Test Site :SAC G Chamber  
 Test Date :2024-04-25  
 Temp./Humi. :23.0°C/59%  
 Antenna Pol. :Vertical  
 Engineer :Temo Chen

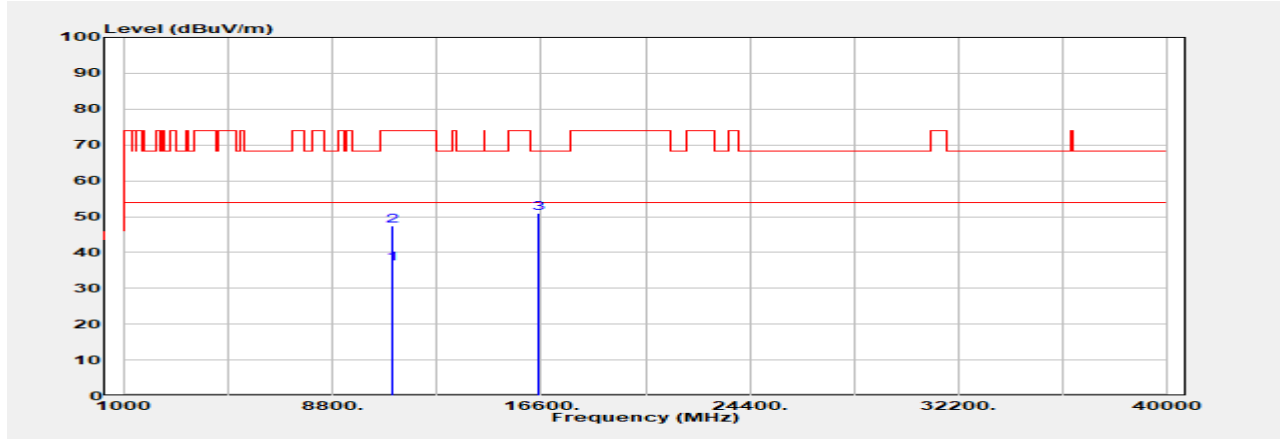

Freq. MHz	Detector Mode PK/QP/AVG	Spectrum Reading Level dBμV	Factor dB	Actual FS dBμV/m	Limit @3m dBμV/m	Margin dB
11000.000	Average	26.89	10.07	36.96	54.00	-17.04
11000.000	Peak	37.42	10.07	47.49	74.00	-26.51
16500.000	Peak	38.26	12.65	50.91	68.20	-17.29

Unless otherwise stated the results shown in this test report refer only to the sample(s) tested and such sample(s) are retained for 90 days only.

除非另有說明，此報告結果僅對測試之樣品負責，同時此樣品僅保留90天。本報告未經本公司書面許可，不可部份複製。

This document is issued by the Company subject to its General Conditions of Service printed overleaf, available on request or accessible at <http://www.sgs.com.tw/Terms-and-Conditions> and for electronic format documents, subject to Terms and Conditions for Electronic Documents at <http://www.sgs.com.tw/Terms-and-Conditions>. Attention is drawn to the limitation of liability, indemnification and jurisdiction issues defined therein. Any holder of this document is advised that information contained hereon reflects the Company's findings at the time of its intervention only and within the limits of Client's instructions, if any. The Company's sole responsibility is to its Client and this document does not exonerate parties to a transaction from exercising all their rights and obligations under the transaction documents. This document cannot be reproduced except in full, without prior written approval of the Company. Any unauthorized alteration, forgery or falsification of the content or appearance of this document is unlawful and offenders may be prosecuted to the fullest extent of the law.

Report Number :TERF2404000927E2  
 Operation Mode :802.11n20  
 Test Frequency :5500 MHz  
 Test Mode :Tx  
 EUT Pol :E2 Plane

Test Site :SAC G Chamber  
 Test Date :2024-04-25  
 Temp./Humi. :23.0°C/59%  
 Antenna Pol. :Horizontal  
 Engineer :Temo Chen

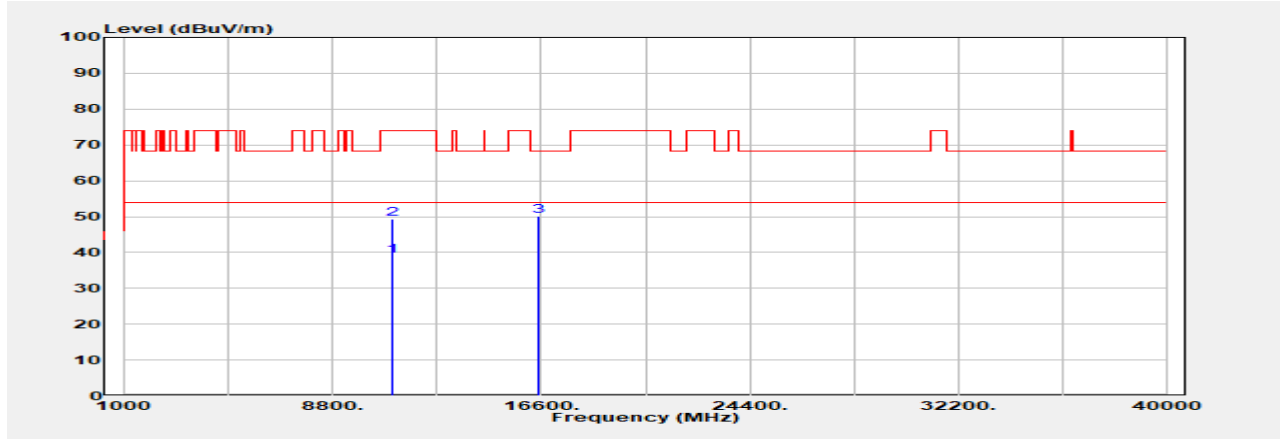

Freq. MHz	Detector Mode PK/QP/AVG	Spectrum Reading Level dBμV	Factor dB	Actual FS dBμV/m	Limit @3m dBμV/m	Margin dB
11000.000	Average	29.05	10.07	39.12	54.00	-14.88
11000.000	Peak	39.16	10.07	49.23	74.00	-24.77
16500.000	Peak	37.55	12.65	50.20	68.20	-18.00

Unless otherwise stated the results shown in this test report refer only to the sample(s) tested and such sample(s) are retained for 90 days only.

除非另有說明，此報告結果僅對測試之樣品負責，同時此樣品僅保留90天。本報告未經本公司書面許可，不可部份複製。

This document is issued by the Company subject to its General Conditions of Service printed overleaf, available on request or accessible at <http://www.sgs.com.tw/Terms-and-Conditions> and for electronic format documents, subject to Terms and Conditions for Electronic Documents at <http://www.sgs.com.tw/Terms-and-Conditions>. Attention is drawn to the limitation of liability, indemnification and jurisdiction issues defined therein. Any holder of this document is advised that information contained hereon reflects the Company's findings at the time of its intervention only and within the limits of Client's instructions, if any. The Company's sole responsibility is to its Client and this document does not exonerate parties to a transaction from exercising all their rights and obligations under the transaction documents. This document cannot be reproduced except in full, without prior written approval of the Company. Any unauthorized alteration, forgery or falsification of the content or appearance of this document is unlawful and offenders may be prosecuted to the fullest extent of the law.

Report Number :TERF2404000927E2  
 Operation Mode :802.11n20  
 Test Frequency :5580 MHz  
 Test Mode :Tx  
 EUT Pol :E2 Plane

Test Site :SAC G Chamber  
 Test Date :2024-04-25  
 Temp./Humi. :23.0°C/59%  
 Antenna Pol. :Vertical  
 Engineer :Temo Chen

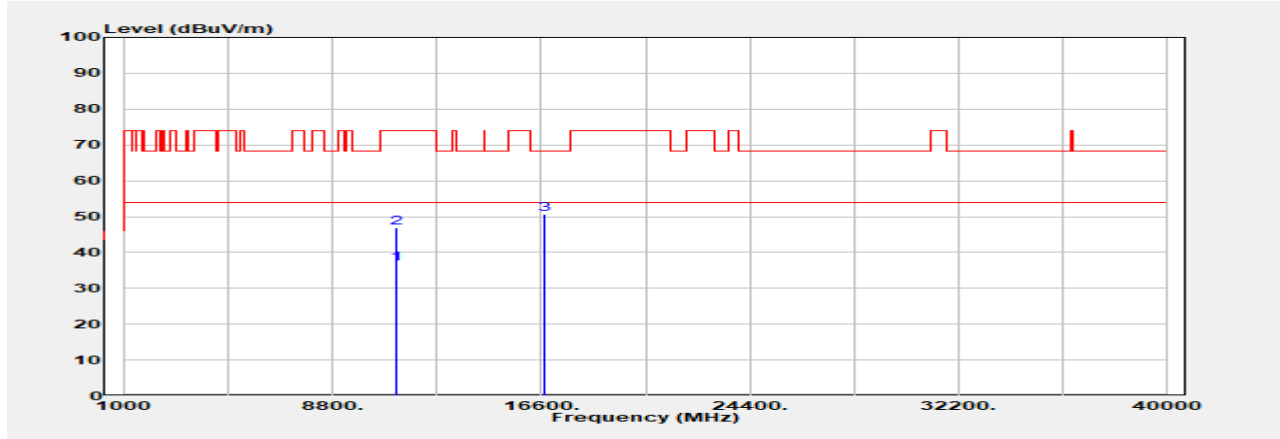

Freq. MHz	Detector Mode PK/QP/AVG	Spectrum Reading Level dBμV	Factor dB	Actual FS dBμV/m	Limit @3m dBμV/m	Margin dB
11160.000	Average	26.96	9.90	36.86	54.00	-17.14
11160.000	Peak	36.96	9.90	46.85	74.00	-27.15
16740.000	Peak	38.50	12.28	50.78	68.20	-17.42

Unless otherwise stated the results shown in this test report refer only to the sample(s) tested and such sample(s) are retained for 90 days only.

除非另有說明，此報告結果僅對測試之樣品負責，同時此樣品僅保留90天。本報告未經本公司書面許可，不可部份複製。

This document is issued by the Company subject to its General Conditions of Service printed overleaf, available on request or accessible at <http://www.sgs.com.tw/Terms-and-Conditions> and for electronic format documents, subject to Terms and Conditions for Electronic Documents at <http://www.sgs.com.tw/Terms-and-Conditions>. Attention is drawn to the limitation of liability, indemnification and jurisdiction issues defined therein. Any holder of this document is advised that information contained hereon reflects the Company's findings at the time of its intervention only and within the limits of Client's instructions, if any. The Company's sole responsibility is to its Client and this document does not exonerate parties to a transaction from exercising all their rights and obligations under the transaction documents. This document cannot be reproduced except in full, without prior written approval of the Company. Any unauthorized alteration, forgery or falsification of the content or appearance of this document is unlawful and offenders may be prosecuted to the fullest extent of the law.

Report Number :TERF2404000927E2  
 Operation Mode :802.11n20  
 Test Frequency :5580 MHz  
 Test Mode :Tx  
 EUT Pol :E2 Plane

Test Site :SAC G Chamber  
 Test Date :2024-04-25  
 Temp./Humi. :23.0°C/59%  
 Antenna Pol. :Horizontal  
 Engineer :Temo Chen

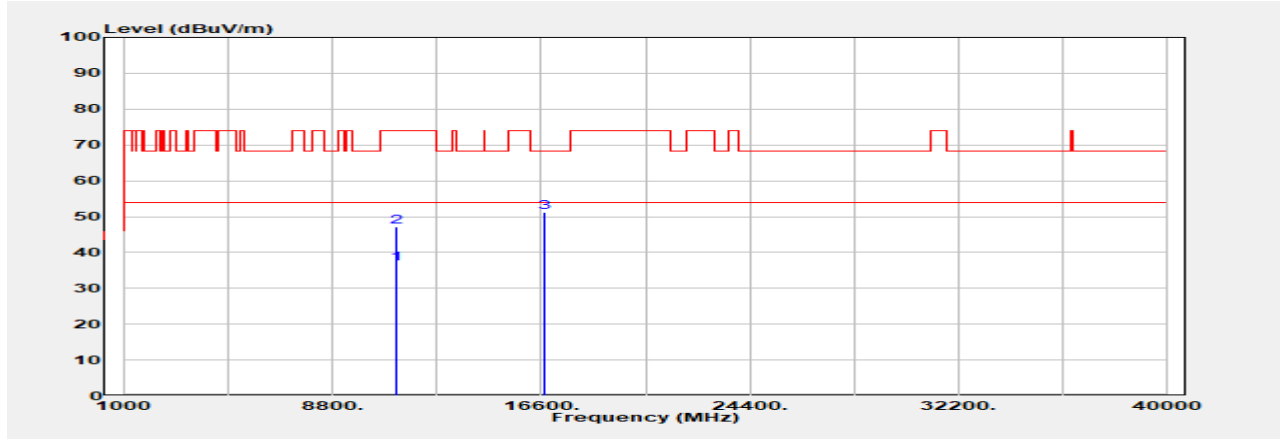

Freq. MHz	Detector Mode PK/QP/AVG	Spectrum Reading Level dB $\mu$ V	Factor dB	Actual FS dB $\mu$ V/m	Limit @3m dB $\mu$ V/m	Margin dB
11160.000	Average	26.87	9.90	36.77	54.00	-17.23
11160.000	Peak	37.31	9.90	47.21	74.00	-26.79
16740.000	Peak	39.05	12.28	51.34	68.20	-16.86

Unless otherwise stated the results shown in this test report refer only to the sample(s) tested and such sample(s) are retained for 90 days only.

除非另有說明，此報告結果僅對測試之樣品負責，同時此樣品僅保留90天。本報告未經本公司書面許可，不可部份複製。

This document is issued by the Company subject to its General Conditions of Service printed overleaf, available on request or accessible at <http://www.sgs.com.tw/Terms-and-Conditions> and for electronic format documents, subject to Terms and Conditions for Electronic Documents at <http://www.sgs.com.tw/Terms-and-Conditions>. Attention is drawn to the limitation of liability, indemnification and jurisdiction issues defined therein. Any holder of this document is advised that information contained hereon reflects the Company's findings at the time of its intervention only and within the limits of Client's instructions, if any. The Company's sole responsibility is to its Client and this document does not exonerate parties to a transaction from exercising all their rights and obligations under the transaction documents. This document cannot be reproduced except in full, without prior written approval of the Company. Any unauthorized alteration, forgery or falsification of the content or appearance of this document is unlawful and offenders may be prosecuted to the fullest extent of the law.

Report Number :TERF2404000927E2  
 Operation Mode :802.11n20  
 Test Frequency :5700 MHz  
 Test Mode :Tx  
 EUT Pol :E2 Plane

Test Site :SAC G Chamber  
 Test Date :2024-04-25  
 Temp./Humi. :23.0°C/59%  
 Antenna Pol. :Vertical  
 Engineer :Temo Chen

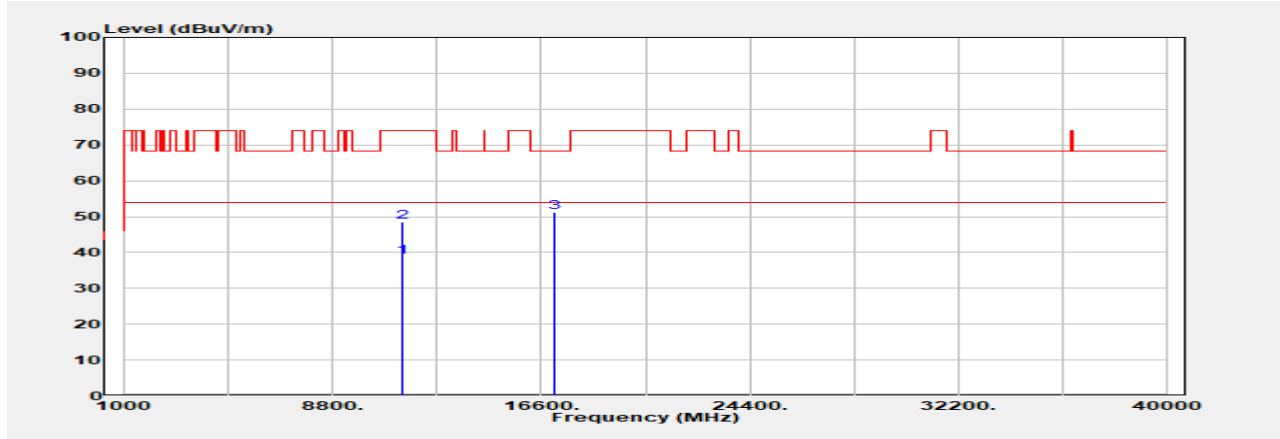

Freq. MHz	Detector Mode PK/QP/AVG	Spectrum Reading Level dB $\mu$ V	Factor dB	Actual FS dB $\mu$ V/m	Limit @3m dB $\mu$ V/m	Margin dB
11400.000	Average	26.49	12.22	38.71	54.00	-15.29
11400.000	Peak	36.38	12.22	48.60	74.00	-25.40
17100.000	Peak	38.90	12.32	51.22	68.20	-16.98

Unless otherwise stated the results shown in this test report refer only to the sample(s) tested and such sample(s) are retained for 90 days only.

除非另有說明，此報告結果僅對測試之樣品負責，同時此樣品僅保留90天。本報告未經本公司書面許可，不可部份複製。

This document is issued by the Company subject to its General Conditions of Service printed overleaf, available on request or accessible at <http://www.sgs.com.tw/Terms-and-Conditions> and for electronic format documents, subject to Terms and Conditions for Electronic Documents at <http://www.sgs.com.tw/Terms-and-Conditions>. Attention is drawn to the limitation of liability, indemnification and jurisdiction issues defined therein. Any holder of this document is advised that information contained hereon reflects the Company's findings at the time of its intervention only and within the limits of Client's instructions, if any. The Company's sole responsibility is to its Client and this document does not exonerate parties to a transaction from exercising all their rights and obligations under the transaction documents. This document cannot be reproduced except in full, without prior written approval of the Company. Any unauthorized alteration, forgery or falsification of the content or appearance of this document is unlawful and offenders may be prosecuted to the fullest extent of the law.

Report Number :TERF2404000927E2  
 Operation Mode :802.11n20  
 Test Frequency :5700 MHz  
 Test Mode :Tx  
 EUT Pol :E2 Plane

Test Site :SAC G Chamber  
 Test Date :2024-04-25  
 Temp./Humi. :23.0°C/59%  
 Antenna Pol. :Horizontal  
 Engineer :Temo Chen

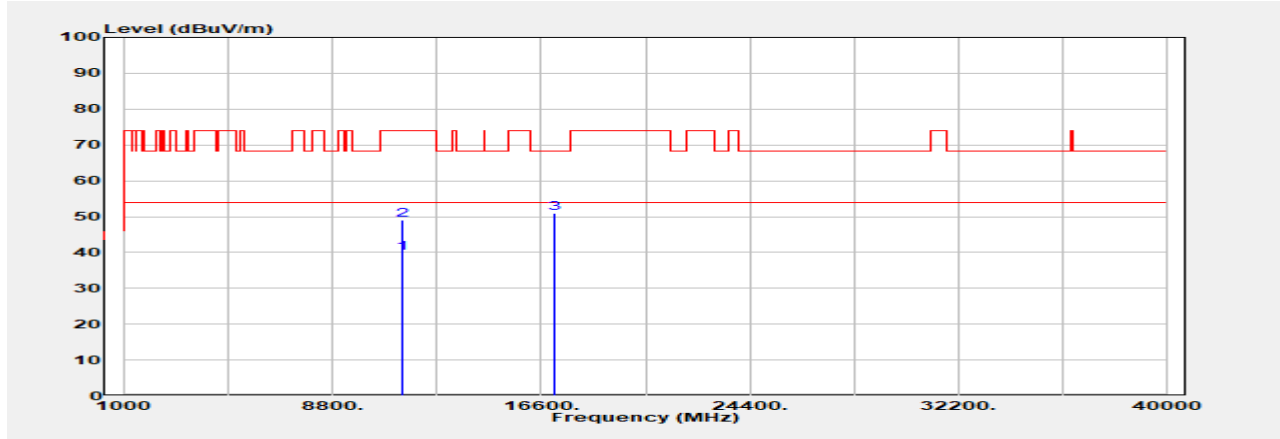

Freq. MHz	Detector Mode PK/QP/AVG	Spectrum Reading Level dBμV	Factor dB	Actual FS dBμV/m	Limit @3m dBμV/m	Margin dB
11400.000	Average	27.63	12.22	39.85	54.00	-14.15
11400.000	Peak	36.86	12.22	49.08	74.00	-24.92
17100.000	Peak	38.67	12.32	50.99	68.20	-17.21

Unless otherwise stated the results shown in this test report refer only to the sample(s) tested and such sample(s) are retained for 90 days only.

除非另有說明，此報告結果僅對測試之樣品負責，同時此樣品僅保留90天。本報告未經本公司書面許可，不可部份複製。

This document is issued by the Company subject to its General Conditions of Service printed overleaf, available on request or accessible at <http://www.sgs.com.tw/Terms-and-Conditions> and for electronic format documents, subject to Terms and Conditions for Electronic Documents at <http://www.sgs.com.tw/Terms-and-Conditions>. Attention is drawn to the limitation of liability, indemnification and jurisdiction issues defined therein. Any holder of this document is advised that information contained hereon reflects the Company's findings at the time of its intervention only and within the limits of Client's instructions, if any. The Company's sole responsibility is to its Client and this document does not exonerate parties to a transaction from exercising all their rights and obligations under the transaction documents. This document cannot be reproduced except in full, without prior written approval of the Company. Any unauthorized alteration, forgery or falsification of the content or appearance of this document is unlawful and offenders may be prosecuted to the fullest extent of the law.



Report Number :TERF2404000927E2  
 Operation Mode :802.11n20  
 Test Frequency :5720 MHz  
 Test Mode :Tx  
 EUT Pol :E2 Plane

Test Site :SAC G Chamber  
 Test Date :2024-04-25  
 Temp./Humi. :23.0°C/59%  
 Antenna Pol. :Vertical  
 Engineer :Temo Chen

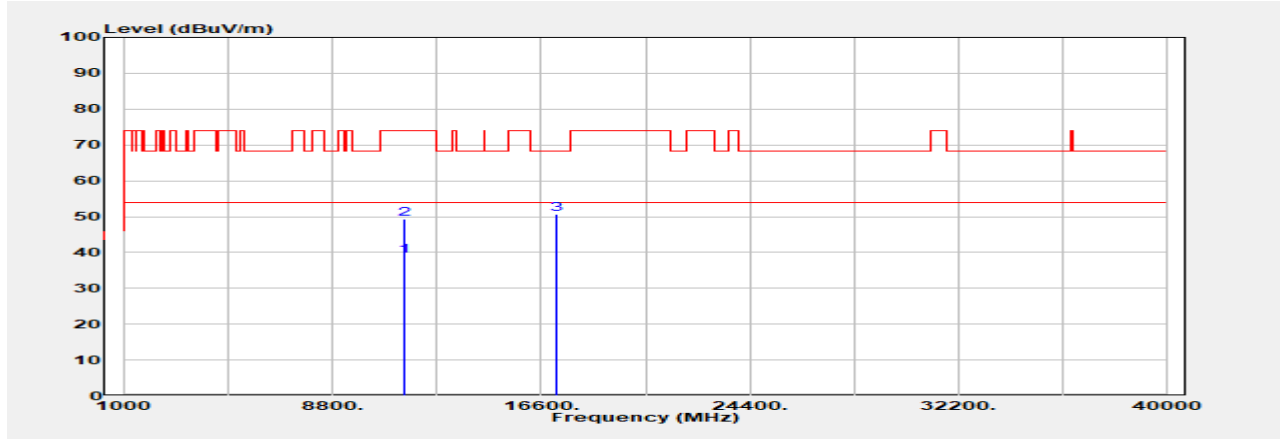

Freq. MHz	Detector Mode PK/QP/AVG	Spectrum Reading Level dBμV	Factor dB	Actual FS dBμV/m	Limit @3m dBμV/m	Margin dB
11440.000	Average	27.57	11.39	38.96	54.00	-15.04
11440.000	Peak	37.96	11.39	49.34	74.00	-24.66
17160.000	Peak	38.67	11.94	50.61	68.20	-17.59

Unless otherwise stated the results shown in this test report refer only to the sample(s) tested and such sample(s) are retained for 90 days only.

除非另有說明，此報告結果僅對測試之樣品負責，同時此樣品僅保留90天。本報告未經本公司書面許可，不可部份複製。

This document is issued by the Company subject to its General Conditions of Service printed overleaf, available on request or accessible at <http://www.sgs.com.tw/Terms-and-Conditions> and for electronic format documents, subject to Terms and Conditions for Electronic Documents at <http://www.sgs.com.tw/Terms-and-Conditions>. Attention is drawn to the limitation of liability, indemnification and jurisdiction issues defined therein. Any holder of this document is advised that information contained hereon reflects the Company's findings at the time of its intervention only and within the limits of Client's instructions, if any. The Company's sole responsibility is to its Client and this document does not exonerate parties to a transaction from exercising all their rights and obligations under the transaction documents. This document cannot be reproduced except in full, without prior written approval of the Company. Any unauthorized alteration, forgery or falsification of the content or appearance of this document is unlawful and offenders may be prosecuted to the fullest extent of the law.

Report Number :TERF2404000927E2  
 Operation Mode :802.11n20  
 Test Frequency :5720 MHz  
 Test Mode :Tx  
 EUT Pol :E2 Plane

Test Site :SAC G Chamber  
 Test Date :2024-04-25  
 Temp./Humi. :23.0°C/59%  
 Antenna Pol. :Horizontal  
 Engineer :Temo Chen

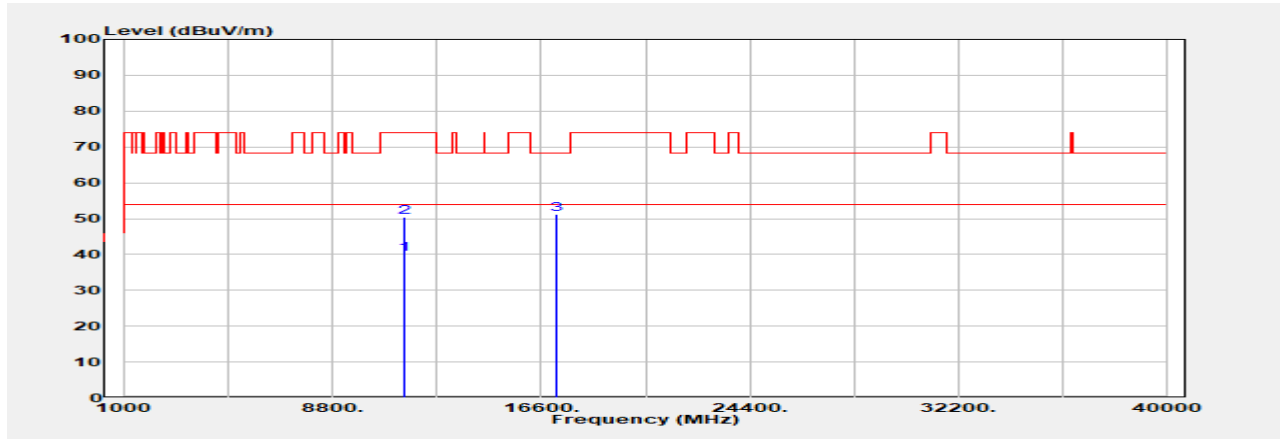

Freq. MHz	Detector Mode PK/QP/AVG	Spectrum Reading Level dBμV	Factor dB	Actual FS dBμV/m	Limit @3m dBμV/m	Margin dB
11440.000	Average	28.64	11.39	40.03	54.00	-13.97
11440.000	Peak	39.00	11.39	50.39	74.00	-23.61
17160.000	Peak	39.32	11.94	51.26	68.20	-16.94

Unless otherwise stated the results shown in this test report refer only to the sample(s) tested and such sample(s) are retained for 90 days only.

除非另有說明，此報告結果僅對測試之樣品負責，同時此樣品僅保留90天。本報告未經本公司書面許可，不可部份複製。

This document is issued by the Company subject to its General Conditions of Service printed overleaf, available on request or accessible at <http://www.sgs.com.tw/Terms-and-Conditions> and for electronic format documents, subject to Terms and Conditions for Electronic Documents at <http://www.sgs.com.tw/Terms-and-Conditions>. Attention is drawn to the limitation of liability, indemnification and jurisdiction issues defined therein. Any holder of this document is advised that information contained hereon reflects the Company's findings at the time of its intervention only and within the limits of Client's instructions, if any. The Company's sole responsibility is to its Client and this document does not exonerate parties to a transaction from exercising all their rights and obligations under the transaction documents. This document cannot be reproduced except in full, without prior written approval of the Company. Any unauthorized alteration, forgery or falsification of the content or appearance of this document is unlawful and offenders may be prosecuted to the fullest extent of the law.

Report Number :TERF2404000927E2  
 Operation Mode :802.11n20  
 Test Frequency :5745 MHz  
 Test Mode :Tx  
 EUT Pol :E2 Plane

Test Site :SAC G Chamber  
 Test Date :2024-04-25  
 Temp./Humi. :23.0°C/59%  
 Antenna Pol. :Vertical  
 Engineer :Temo Chen

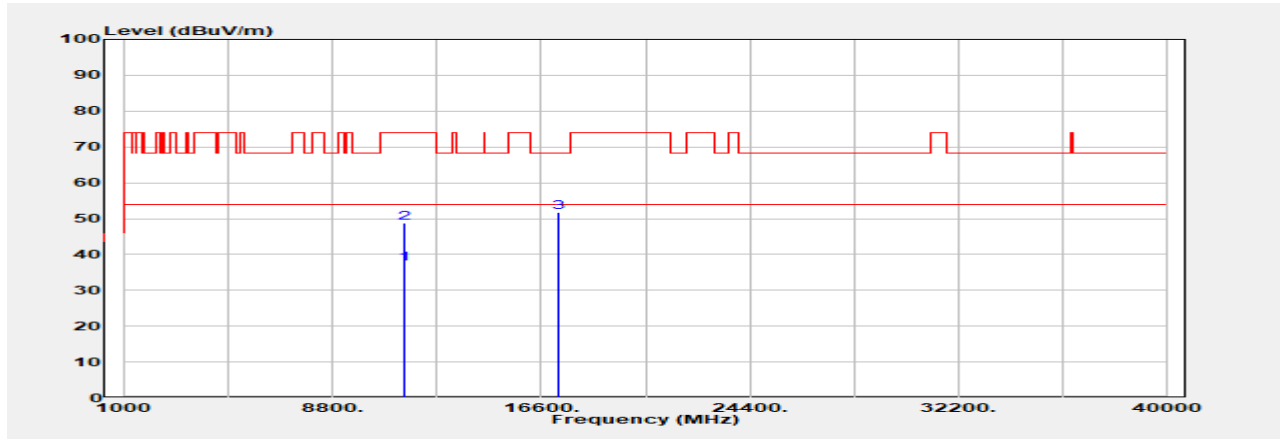

Freq. MHz	Detector Mode PK/QP/AVG	Spectrum Reading Level dB $\mu$ V	Factor dB	Actual FS dB $\mu$ V/m	Limit @3m dB $\mu$ V/m	Margin dB
11490.000	Average	26.99	10.35	37.34	54.00	-16.66
11490.000	Peak	38.41	10.35	48.76	74.00	-25.24
17235.000	Peak	39.49	12.23	51.72	68.20	-16.48

Unless otherwise stated the results shown in this test report refer only to the sample(s) tested and such sample(s) are retained for 90 days only.

除非另有說明，此報告結果僅對測試之樣品負責，同時此樣品僅保留90天。本報告未經本公司書面許可，不可部份複製。

This document is issued by the Company subject to its General Conditions of Service printed overleaf, available on request or accessible at <http://www.sgs.com.tw/Terms-and-Conditions> and for electronic format documents, subject to Terms and Conditions for Electronic Documents at <http://www.sgs.com.tw/Terms-and-Conditions>. Attention is drawn to the limitation of liability, indemnification and jurisdiction issues defined therein. Any holder of this document is advised that information contained hereon reflects the Company's findings at the time of its intervention only and within the limits of Client's instructions, if any. The Company's sole responsibility is to its Client and this document does not exonerate parties to a transaction from exercising all their rights and obligations under the transaction documents. This document cannot be reproduced except in full, without prior written approval of the Company. Any unauthorized alteration, forgery or falsification of the content or appearance of this document is unlawful and offenders may be prosecuted to the fullest extent of the law.

Report Number :TERF2404000927E2  
 Operation Mode :802.11n20  
 Test Frequency :5745 MHz  
 Test Mode :Tx  
 EUT Pol :E2 Plane

Test Site :SAC G Chamber  
 Test Date :2024-04-25  
 Temp./Humi. :23.0°C/59%  
 Antenna Pol. :Horizontal  
 Engineer :Temo Chen

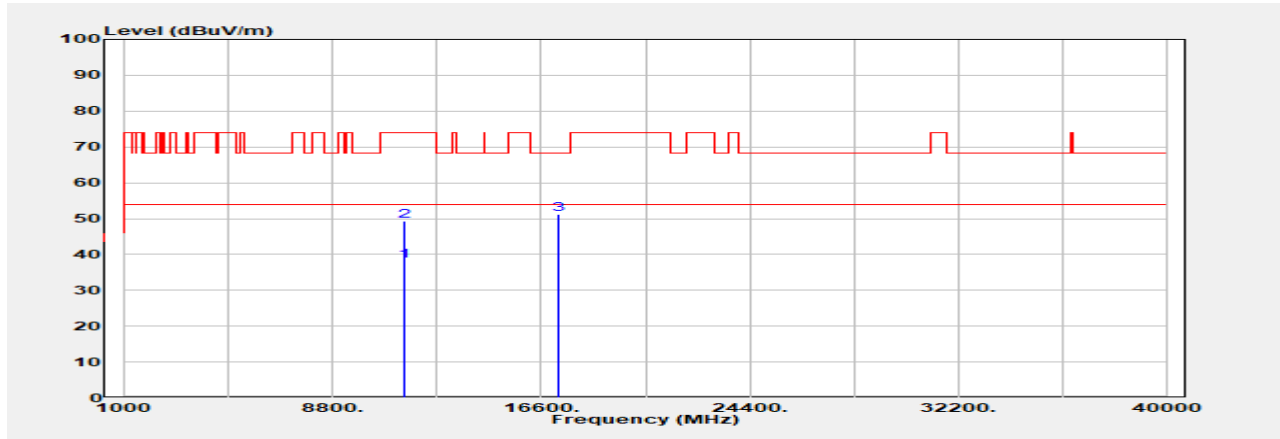

Freq. MHz	Detector Mode PK/QP/AVG	Spectrum Reading Level dB $\mu$ V	Factor dB	Actual FS dB $\mu$ V/m	Limit @3m dB $\mu$ V/m	Margin dB
11490.000	Average	27.94	10.35	38.29	54.00	-15.71
11490.000	Peak	38.85	10.35	49.19	74.00	-24.81
17235.000	Peak	39.06	12.23	51.29	68.20	-16.91

Unless otherwise stated the results shown in this test report refer only to the sample(s) tested and such sample(s) are retained for 90 days only.

除非另有說明，此報告結果僅對測試之樣品負責，同時此樣品僅保留90天。本報告未經本公司書面許可，不可部份複製。

This document is issued by the Company subject to its General Conditions of Service printed overleaf, available on request or accessible at <http://www.sgs.com.tw/Terms-and-Conditions> and for electronic format documents, subject to Terms and Conditions for Electronic Documents at <http://www.sgs.com.tw/Terms-and-Conditions>. Attention is drawn to the limitation of liability, indemnification and jurisdiction issues defined therein. Any holder of this document is advised that information contained hereon reflects the Company's findings at the time of its intervention only and within the limits of Client's instructions, if any. The Company's sole responsibility is to its Client and this document does not exonerate parties to a transaction from exercising all their rights and obligations under the transaction documents. This document cannot be reproduced except in full, without prior written approval of the Company. Any unauthorized alteration, forgery or falsification of the content or appearance of this document is unlawful and offenders may be prosecuted to the fullest extent of the law.

Report Number :TERF2404000927E2  
 Operation Mode :802.11n20  
 Test Frequency :5785 MHz  
 Test Mode :Tx  
 EUT Pol :E2 Plane

Test Site :SAC G Chamber  
 Test Date :2024-04-25  
 Temp./Humi. :23.0°C/59%  
 Antenna Pol. :Vertical  
 Engineer :Temo Chen

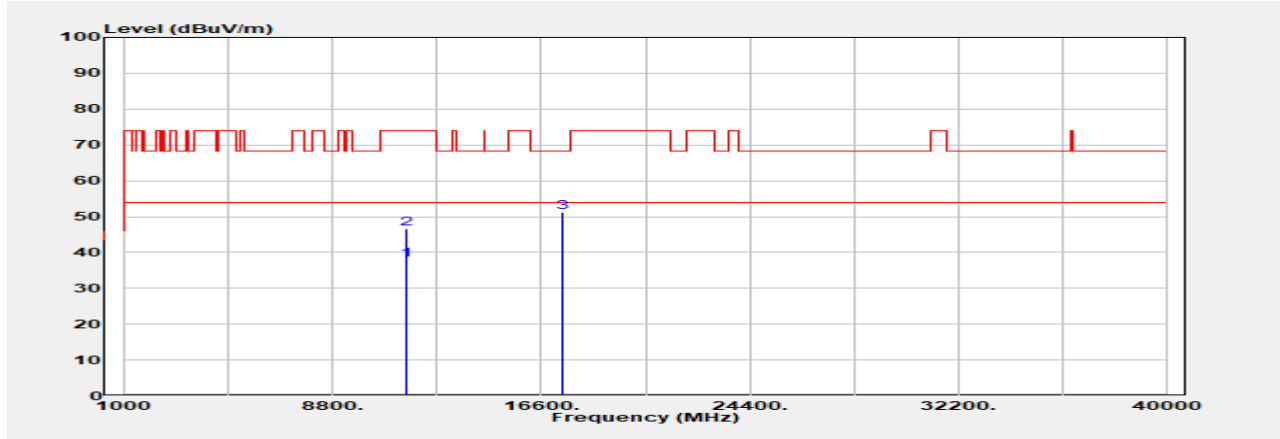

Freq. MHz	Detector Mode PK/QP/AVG	Spectrum Reading Level dB $\mu$ V	Factor dB	Actual FS dB $\mu$ V/m	Limit @3m dB $\mu$ V/m	Margin dB
11570.000	Average	27.62	10.22	37.84	54.00	-16.16
11570.000	Peak	36.36	10.22	46.58	74.00	-27.42
17355.000	Peak	38.58	12.59	51.17	68.20	-17.03

Unless otherwise stated the results shown in this test report refer only to the sample(s) tested and such sample(s) are retained for 90 days only.

除非另有說明，此報告結果僅對測試之樣品負責，同時此樣品僅保留90天。本報告未經本公司書面許可，不可部份複製。

This document is issued by the Company subject to its General Conditions of Service printed overleaf, available on request or accessible at <http://www.sgs.com.tw/Terms-and-Conditions> and for electronic format documents, subject to Terms and Conditions for Electronic Documents at <http://www.sgs.com.tw/Terms-and-Conditions>. Attention is drawn to the limitation of liability, indemnification and jurisdiction issues defined therein. Any holder of this document is advised that information contained hereon reflects the Company's findings at the time of its intervention only and within the limits of Client's instructions, if any. The Company's sole responsibility is to its Client and this document does not exonerate parties to a transaction from exercising all their rights and obligations under the transaction documents. This document cannot be reproduced except in full, without prior written approval of the Company. Any unauthorized alteration, forgery or falsification of the content or appearance of this document is unlawful and offenders may be prosecuted to the fullest extent of the law.

Report Number :TERF2404000927E2

Test Site :SAC G Chamber

Operation Mode :802.11n20

Test Date :2024-04-25

Test Frequency :5785 MHz

Temp./Humi. :23.0°C/59%

Test Mode :Tx

Antenna Pol. :Horizontal

EUT Pol :E2 Plane

Engineer :Temo Chen

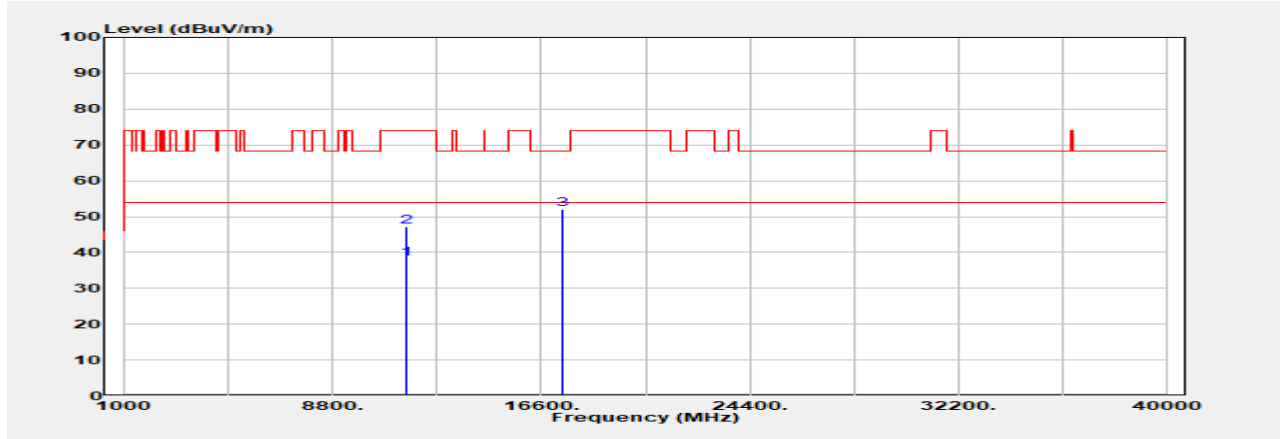

Freq. MHz	Detector Mode PK/QP/AVG	Spectrum Reading Level dB $\mu$ V	Factor dB	Actual FS dB $\mu$ V/m	Limit @3m dB $\mu$ V/m	Margin dB
11570.000	Average	28.12	10.22	38.34	54.00	-15.66
11570.000	Peak	36.84	10.22	47.05	74.00	-26.95
17355.000	Peak	39.33	12.59	51.91	68.20	-16.29

Unless otherwise stated the results shown in this test report refer only to the sample(s) tested and such sample(s) are retained for 90 days only.

除非另有說明，此報告結果僅對測試之樣品負責，同時此樣品僅保留90天。本報告未經本公司書面許可，不可部份複製。

This document is issued by the Company subject to its General Conditions of Service printed overleaf, available on request or accessible at <http://www.sgs.com.tw/Terms-and-Conditions>, and for electronic format documents, subject to Terms and Conditions for Electronic Documents at <http://www.sgs.com.tw/Terms-and-Conditions>. Attention is drawn to the limitation of liability, indemnification and jurisdiction issues defined therein. Any holder of this document is advised that information contained hereon reflects the Company's findings at the time of its intervention only and within the limits of Client's instructions, if any. The Company's sole responsibility is to its Client and this document does not exonerate parties to a transaction from exercising all their rights and obligations under the transaction documents. This document cannot be reproduced except in full, without prior written approval of the Company. Any unauthorized alteration, forgery or falsification of the content or appearance of this document is unlawful and offenders may be prosecuted to the fullest extent of the law.

Report Number :TERF2404000927E2  
 Operation Mode :802.11n20  
 Test Frequency :5825 MHz  
 Test Mode :Tx  
 EUT Pol :E2 Plane

Test Site :SAC G Chamber  
 Test Date :2024-04-25  
 Temp./Humi. :23.0°C/59%  
 Antenna Pol. :Vertical  
 Engineer :Temo Chen

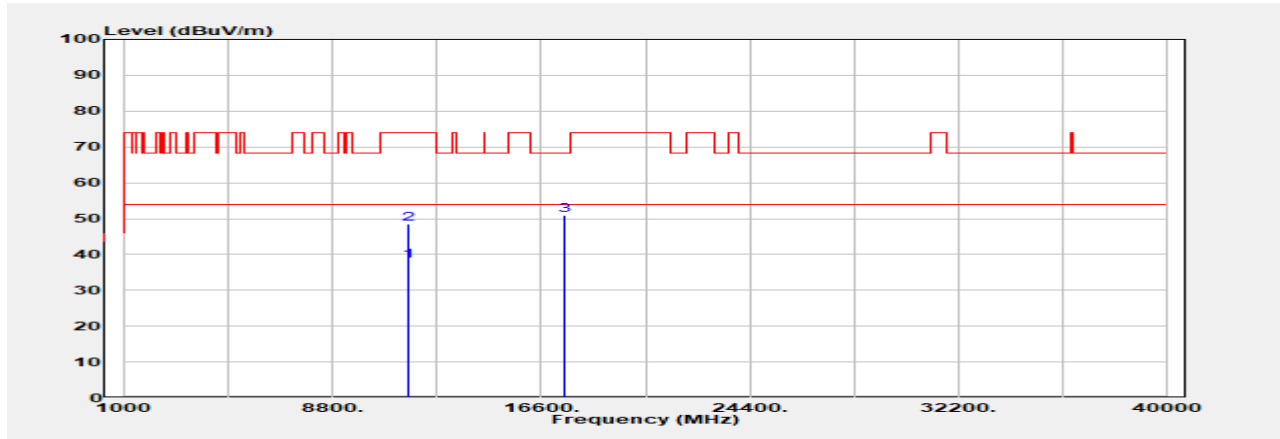

Freq. MHz	Detector Mode PK/QP/AVG	Spectrum Reading Level dBμV	Factor dB	Actual FS dBμV/m	Limit @3m dBμV/m	Margin dB
11650.000	Average	27.46	10.64	38.10	54.00	-15.90
11650.000	Peak	37.74	10.64	48.38	74.00	-25.62
17475.000	Peak	38.30	12.54	50.84	68.20	-17.36

Unless otherwise stated the results shown in this test report refer only to the sample(s) tested and such sample(s) are retained for 90 days only.

除非另有說明，此報告結果僅對測試之樣品負責，同時此樣品僅保留90天。本報告未經本公司書面許可，不可部份複製。

This document is issued by the Company subject to its General Conditions of Service printed overleaf, available on request or accessible at <http://www.sgs.com.tw/Terms-and-Conditions> and for electronic format documents, subject to Terms and Conditions for Electronic Documents at <http://www.sgs.com.tw/Terms-and-Conditions>. Attention is drawn to the limitation of liability, indemnification and jurisdiction issues defined therein. Any holder of this document is advised that information contained hereon reflects the Company's findings at the time of its intervention only and within the limits of Client's instructions, if any. The Company's sole responsibility is to its Client and this document does not exonerate parties to a transaction from exercising all their rights and obligations under the transaction documents. This document cannot be reproduced except in full, without prior written approval of the Company. Any unauthorized alteration, forgery or falsification of the content or appearance of this document is unlawful and offenders may be prosecuted to the fullest extent of the law.



Report Number :TERF2404000927E2

Test Site :SAC G Chamber

Operation Mode :802.11n20

Test Date :2024-04-25

Test Frequency :5825 MHz

Temp./Humi. :23.0°C/59%

Test Mode :Tx

Antenna Pol. :Horizontal

EUT Pol :E2 Plane

Engineer :Temo Chen

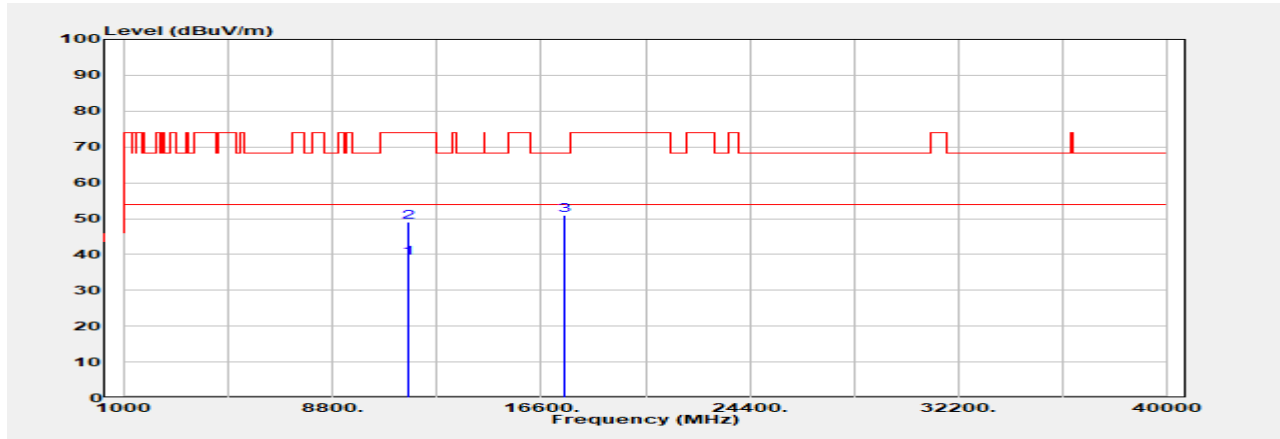

Freq. MHz	Detector Mode PK/QP/AVG	Spectrum Reading Level dBμV	Factor dB	Actual FS dBμV/m	Limit @3m dBμV/m	Margin dB
11650.000	Average	28.29	10.64	38.93	54.00	-15.07
11650.000	Peak	38.44	10.64	49.08	74.00	-24.92
17475.000	Peak	38.38	12.54	50.92	68.20	-17.28

Unless otherwise stated the results shown in this test report refer only to the sample(s) tested and such sample(s) are retained for 90 days only.

除非另有說明，此報告結果僅對測試之樣品負責，同時此樣品僅保留90天。本報告未經本公司書面許可，不可部份複製。

This document is issued by the Company subject to its General Conditions of Service printed overleaf, available on request or accessible at <http://www.sgs.com.tw/Terms-and-Conditions> and for electronic format documents, subject to Terms and Conditions for Electronic Documents at <http://www.sgs.com.tw/Terms-and-Conditions>. Attention is drawn to the limitation of liability, indemnification and jurisdiction issues defined therein. Any holder of this document is advised that information contained hereon reflects the Company's findings at the time of its intervention only and within the limits of Client's instructions, if any. The Company's sole responsibility is to its Client and this document does not exonerate parties to a transaction from exercising all their rights and obligations under the transaction documents. This document cannot be reproduced except in full, without prior written approval of the Company. Any unauthorized alteration, forgery or falsification of the content or appearance of this document is unlawful and offenders may be prosecuted to the fullest extent of the law.

Report Number :TERF2404000927E2  
 Operation Mode :802.11a  
 Test Frequency :5220 MHz  
 Test Mode :Tx  
 EUT Pol :E2 Plane

Test Site :SAC G Chamber  
 Test Date :2024-05-13  
 Temp./Humi. :21.8°C/56%  
 Antenna Pol. :Vertical  
 Engineer :Temo Chen

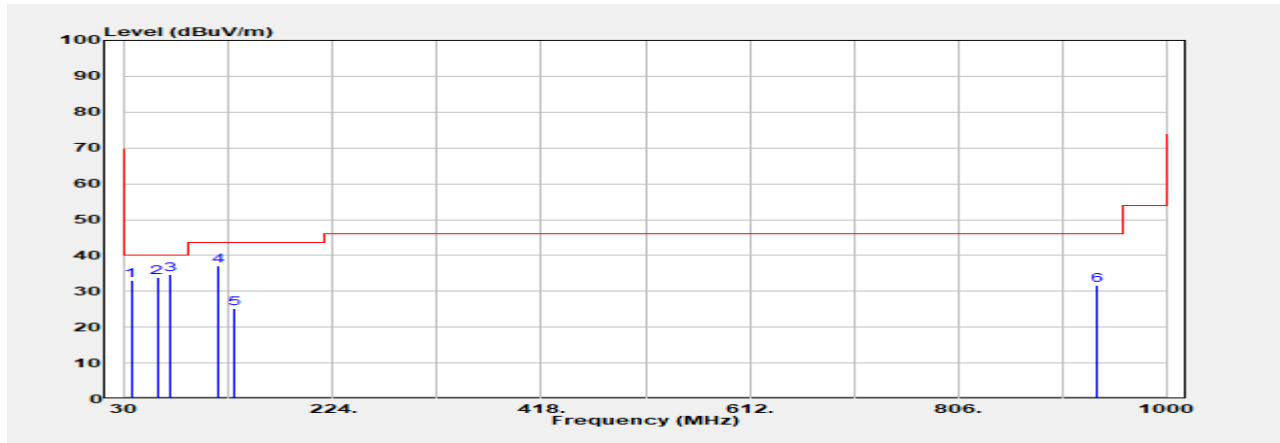

Freq. MHz	Detector Mode PK/QP/AVG	Spectrum Reading Level dB $\mu$ V	Factor dB	Actual FS dB $\mu$ V/m	Limit @3m dB $\mu$ V/m	Margin dB
35.820	QP	47.30	-14.25	33.05	40.00	-6.95
60.070	QP	46.80	-12.95	33.85	40.00	-6.15
72.680	QP	50.20	-15.45	34.75	40.00	-5.25
116.330	Peak	52.90	-15.88	37.02	43.50	-6.48
131.850	QP	39.70	-14.49	25.21	43.50	-18.29
935.980	Peak	31.99	-0.23	31.76	46.00	-14.24

Unless otherwise stated the results shown in this test report refer only to the sample(s) tested and such sample(s) are retained for 90 days only.

除非另有說明，此報告結果僅對測試之樣品負責，同時此樣品僅保留90天。本報告未經本公司書面許可，不可部份複製。

This document is issued by the Company subject to its General Conditions of Service printed overleaf, available on request or accessible at <http://www.sgs.com.tw/Terms-and-Conditions> and for electronic format documents, subject to Terms and Conditions for Electronic Documents at <http://www.sgs.com.tw/Terms-and-Conditions>. Attention is drawn to the limitation of liability, indemnification and jurisdiction issues defined therein. Any holder of this document is advised that information contained hereon reflects the Company's findings at the time of its intervention only and within the limits of Client's instructions, if any. The Company's sole responsibility is to its Client and this document does not exonerate parties to a transaction from exercising all their rights and obligations under the transaction documents. This document cannot be reproduced except in full, without prior written approval of the Company. Any unauthorized alteration, forgery or falsification of the content or appearance of this document is unlawful and offenders may be prosecuted to the fullest extent of the law.

Report Number :TERF2404000927E2  
 Operation Mode :802.11a  
 Test Frequency :5220 MHz  
 Test Mode :Tx  
 EUT Pol :E2 Plane

Test Site :SAC G Chamber  
 Test Date :2024-05-13  
 Temp./Humi. :21.8°C/56%  
 Antenna Pol. :Horizontal  
 Engineer :Temo Chen

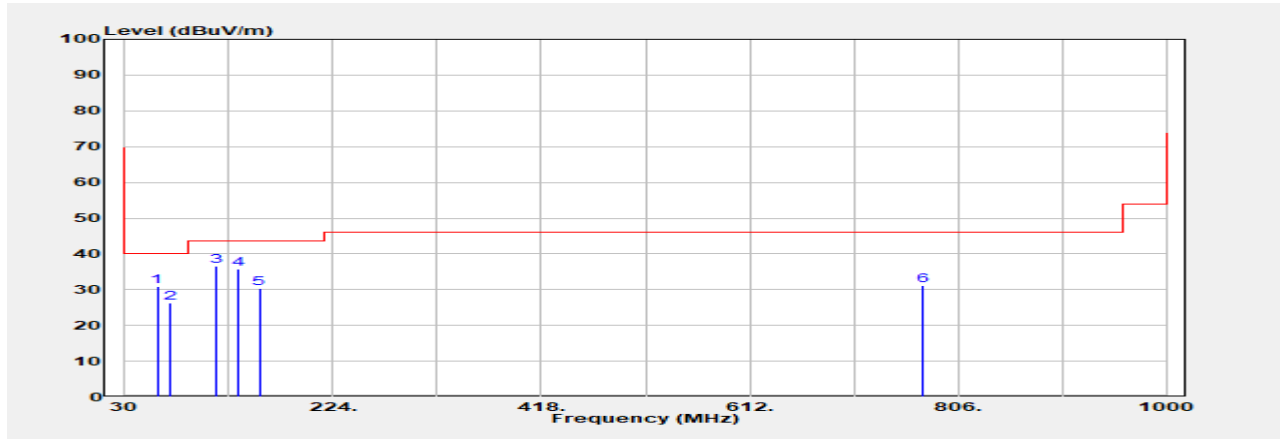

Freq. MHz	Detector Mode PK/QP/AVG	Spectrum Reading Level dBμV	Factor dB	Actual FS dBμV/m	Limit @3m dBμV/m	Margin dB
60.070	Peak	43.84	-12.95	30.89	40.00	-9.11
71.710	QP	41.50	-15.08	26.42	40.00	-13.58
114.390	Peak	52.45	-15.94	36.51	43.50	-6.99
134.760	Peak	49.88	-14.08	35.80	43.50	-7.70
155.130	Peak	42.95	-12.57	30.38	43.50	-13.12
773.020	Peak	32.65	-1.54	31.12	46.00	-14.88

Unless otherwise stated the results shown in this test report refer only to the sample(s) tested and such sample(s) are retained for 90 days only.

除非另有說明，此報告結果僅對測試之樣品負責，同時此樣品僅保留90天。本報告未經本公司書面許可，不可部份複製。

This document is issued by the Company subject to its General Conditions of Service printed overleaf, available on request or accessible at <http://www.sgs.com.tw/Terms-and-Conditions> and for electronic format documents, subject to Terms and Conditions for Electronic Documents at <http://www.sgs.com.tw/Terms-and-Conditions>. Attention is drawn to the limitation of liability, indemnification and jurisdiction issues defined therein. Any holder of this document is advised that information contained hereon reflects the Company's findings at the time of its intervention only and within the limits of Client's instructions, if any. The Company's sole responsibility is to its Client and this document does not exonerate parties to a transaction from exercising all their rights and obligations under the transaction documents. This document cannot be reproduced except in full, without prior written approval of the Company. Any unauthorized alteration, forgery or falsification of the content or appearance of this document is unlawful and offenders may be prosecuted to the fullest extent of the law.

Report Number :TERF2404000927E2  
 Operation Mode :802.11a  
 Test Frequency :5300 MHz  
 Test Mode :Tx  
 EUT Pol :E2 Plane

Test Site :SAC G Chamber  
 Test Date :2024-05-13  
 Temp./Humi. :21.8°C/56%  
 Antenna Pol. :Vertical  
 Engineer :Temo Chen

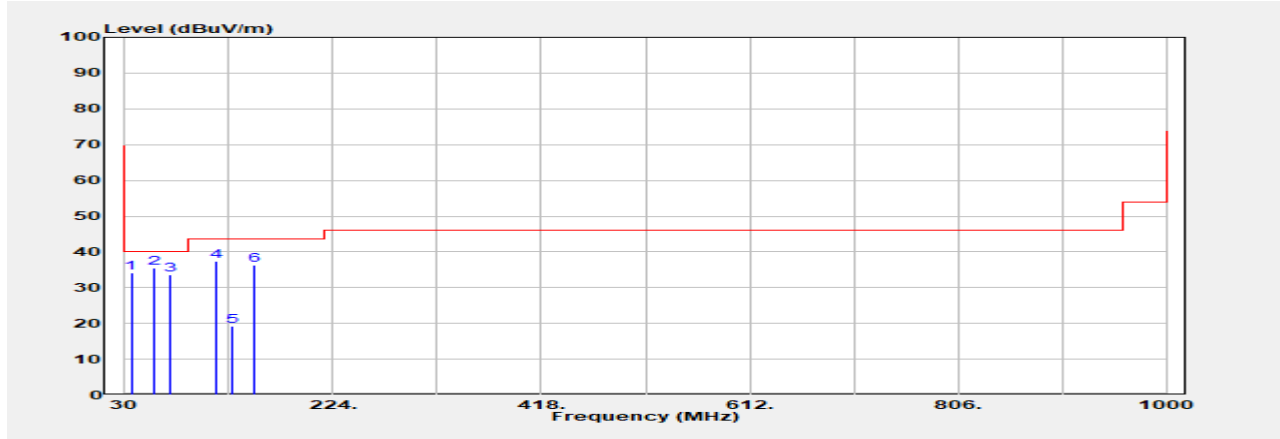

Freq. MHz	Detector Mode PK/QP/AVG	Spectrum Reading Level dB $\mu$ V	Factor dB	Actual FS dB $\mu$ V/m	Limit @3m dB $\mu$ V/m	Margin dB
35.820	QP	48.50	-14.25	34.25	40.00	-5.75
58.130	QP	48.40	-12.95	35.45	40.00	-4.55
71.710	QP	48.80	-15.08	33.72	40.00	-6.28
114.390	Peak	53.37	-15.94	37.43	43.50	-6.07
129.910	QP	33.80	-14.64	19.16	43.50	-24.34
150.280	Peak	49.00	-12.71	36.28	43.50	-7.22

Unless otherwise stated the results shown in this test report refer only to the sample(s) tested and such sample(s) are retained for 90 days only.

除非另有說明，此報告結果僅對測試之樣品負責，同時此樣品僅保留90天。本報告未經本公司書面許可，不可部份複製。

This document is issued by the Company subject to its General Conditions of Service printed overleaf, available on request or accessible at <http://www.sgs.com.tw/Terms-and-Conditions> and for electronic format documents, subject to Terms and Conditions for Electronic Documents at <http://www.sgs.com.tw/Terms-and-Conditions>. Attention is drawn to the limitation of liability, indemnification and jurisdiction issues defined therein. Any holder of this document is advised that information contained hereon reflects the Company's findings at the time of its intervention only and within the limits of Client's instructions, if any. The Company's sole responsibility is to its Client and this document does not exonerate parties to a transaction from exercising all their rights and obligations under the transaction documents. This document cannot be reproduced except in full, without prior written approval of the Company. Any unauthorized alteration, forgery or falsification of the content or appearance of this document is unlawful and offenders may be prosecuted to the fullest extent of the law.

Report Number :TERF2404000927E2  
 Operation Mode :802.11a  
 Test Frequency :5300 MHz  
 Test Mode :Tx  
 EUT Pol :E2 Plane

Test Site :SAC G Chamber  
 Test Date :2024-05-13  
 Temp./Humi. :21.8°C/56%  
 Antenna Pol. :Horizontal  
 Engineer :Temo Chen

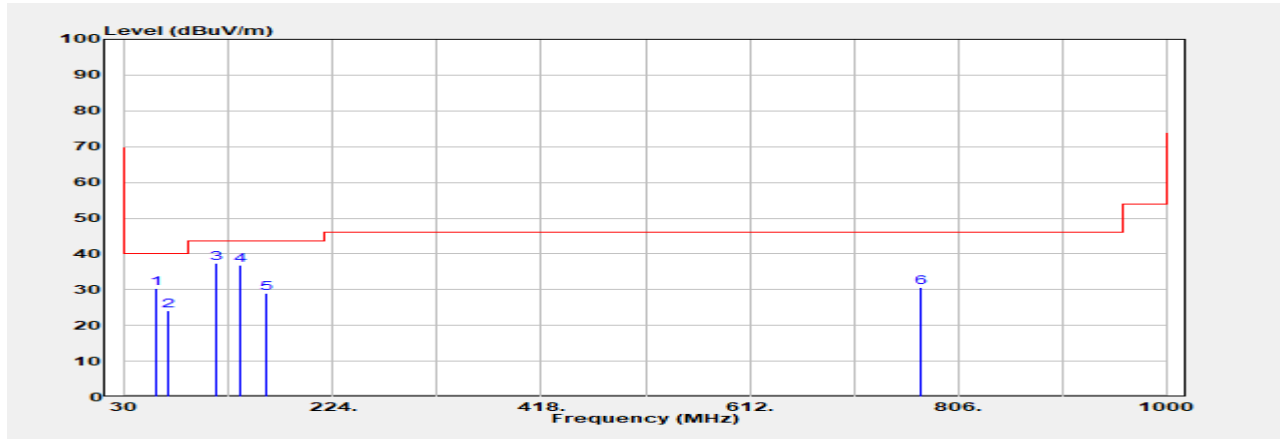

Freq. MHz	Detector Mode PK/QP/AVG	Spectrum Reading Level dBμV	Factor dB	Actual FS dBμV/m	Limit @3m dBμV/m	Margin dB
59.100	Peak	43.28	-13.02	30.25	40.00	-9.75
70.740	QP	39.20	-14.99	24.21	40.00	-15.79
115.360	Peak	53.41	-15.95	37.46	43.50	-6.04
137.670	Peak	50.75	-13.78	36.97	43.50	-6.53
160.950	Peak	41.97	-12.89	29.08	43.50	-14.42
772.050	Peak	32.03	-1.54	30.49	46.00	-15.51

Unless otherwise stated the results shown in this test report refer only to the sample(s) tested and such sample(s) are retained for 90 days only.

除非另有說明，此報告結果僅對測試之樣品負責，同時此樣品僅保留90天。本報告未經本公司書面許可，不可部份複製。

This document is issued by the Company subject to its General Conditions of Service printed overleaf, available on request or accessible at <http://www.sgs.com.tw/Terms-and-Conditions> and for electronic format documents, subject to Terms and Conditions for Electronic Documents at <http://www.sgs.com.tw/Terms-and-Conditions>. Attention is drawn to the limitation of liability, indemnification and jurisdiction issues defined therein. Any holder of this document is advised that information contained hereon reflects the Company's findings at the time of its intervention only and within the limits of Client's instructions, if any. The Company's sole responsibility is to its Client and this document does not exonerate parties to a transaction from exercising all their rights and obligations under the transaction documents. This document cannot be reproduced except in full, without prior written approval of the Company. Any unauthorized alteration, forgery or falsification of the content or appearance of this document is unlawful and offenders may be prosecuted to the fullest extent of the law.

Report Number :TERF2404000927E2  
 Operation Mode :802.11a  
 Test Frequency :5580 MHz  
 Test Mode :Tx  
 EUT Pol :E2 Plane

Test Site :SAC G Chamber  
 Test Date :2024-05-13  
 Temp./Humi. :21.8°C/56%  
 Antenna Pol. :Vertical  
 Engineer :Temo Chen

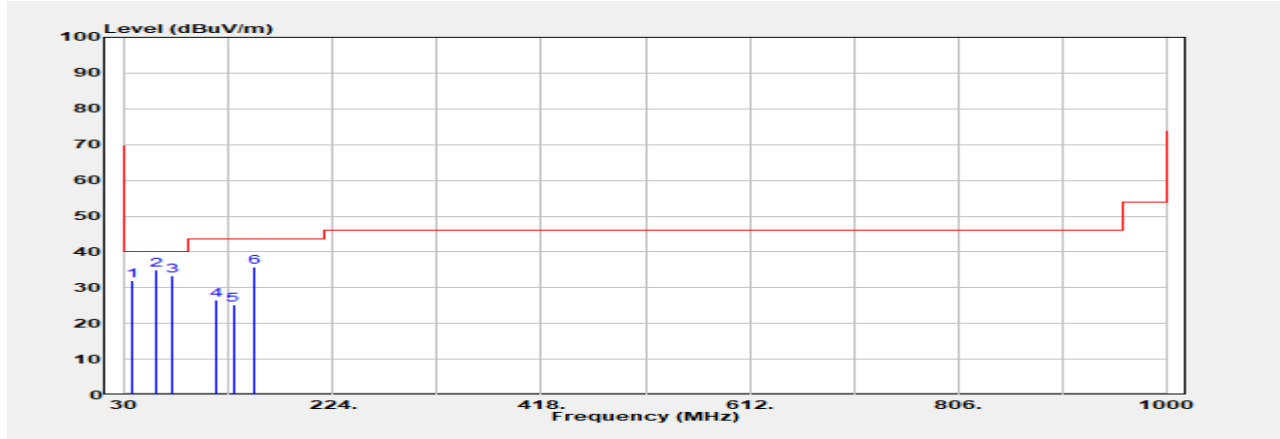

Freq. MHz	Detector Mode PK/QP/AVG	Spectrum Reading Level dBμV	Factor dB	Actual FS dBμV/m	Limit @3m dBμV/m	Margin dB
36.790	QP	46.00	-14.05	31.95	40.00	-8.05
59.100	QP	47.90	-13.02	34.88	40.00	-5.12
73.650	QP	49.20	-15.80	33.40	40.00	-6.60
115.360	QP	42.60	-15.95	26.65	43.50	-16.85
130.880	QP	39.70	-14.52	25.18	43.50	-18.32
151.250	Peak	48.54	-12.72	35.82	43.50	-7.68

Unless otherwise stated the results shown in this test report refer only to the sample(s) tested and such sample(s) are retained for 90 days only.

除非另有說明，此報告結果僅對測試之樣品負責，同時此樣品僅保留90天。本報告未經本公司書面許可，不可部份複製。

This document is issued by the Company subject to its General Conditions of Service printed overleaf, available on request or accessible at <http://www.sgs.com.tw/Terms-and-Conditions> and for electronic format documents, subject to Terms and Conditions for Electronic Documents at <http://www.sgs.com.tw/Terms-and-Conditions>. Attention is drawn to the limitation of liability, indemnification and jurisdiction issues defined therein. Any holder of this document is advised that information contained hereon reflects the Company's findings at the time of its intervention only and within the limits of Client's instructions, if any. The Company's sole responsibility is to its Client and this document does not exonerate parties to a transaction from exercising all their rights and obligations under the transaction documents. This document cannot be reproduced except in full, without prior written approval of the Company. Any unauthorized alteration, forgery or falsification of the content or appearance of this document is unlawful and offenders may be prosecuted to the fullest extent of the law.

Report Number :TERF2404000927E2  
 Operation Mode :802.11a  
 Test Frequency :5580 MHz  
 Test Mode :Tx  
 EUT Pol :E2 Plane

Test Site :SAC G Chamber  
 Test Date :2024-05-13  
 Temp./Humi. :21.8°C/56%  
 Antenna Pol. :Horizontal  
 Engineer :Temo Chen

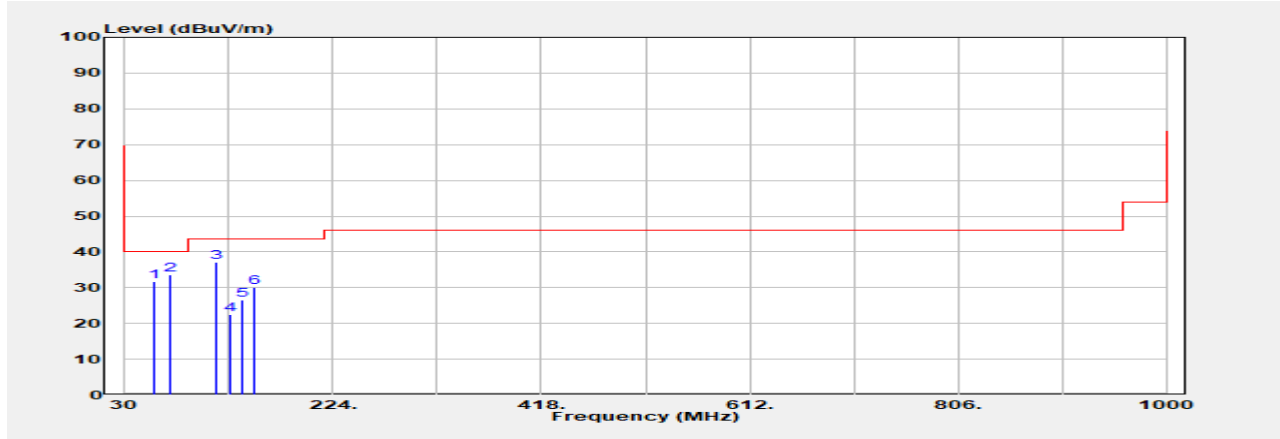

Freq. MHz	Detector Mode PK/QP/AVG	Spectrum Reading Level dBμV	Factor dB	Actual FS dBμV/m	Limit @3m dBμV/m	Margin dB
58.130	Peak	44.74	-12.95	31.79	40.00	-8.21
71.710	Peak	48.80	-15.08	33.72	40.00	-6.28
115.360	Peak	53.07	-15.95	37.12	43.50	-6.38
128.940	QP	37.40	-14.83	22.57	43.50	-20.93
139.610	QP	40.10	-13.59	26.51	43.50	-16.99
151.250	Peak	42.88	-12.72	30.16	43.50	-13.34

Unless otherwise stated the results shown in this test report refer only to the sample(s) tested and such sample(s) are retained for 90 days only.

除非另有說明，此報告結果僅對測試之樣品負責，同時此樣品僅保留90天。本報告未經本公司書面許可，不可部份複製。

This document is issued by the Company subject to its General Conditions of Service printed overleaf, available on request or accessible at <http://www.sgs.com.tw/Terms-and-Conditions> and for electronic format documents, subject to Terms and Conditions for Electronic Documents at <http://www.sgs.com.tw/Terms-and-Conditions>. Attention is drawn to the limitation of liability, indemnification and jurisdiction issues defined therein. Any holder of this document is advised that information contained hereon reflects the Company's findings at the time of its intervention only and within the limits of Client's instructions, if any. The Company's sole responsibility is to its Client and this document does not exonerate parties to a transaction from exercising all their rights and obligations under the transaction documents. This document cannot be reproduced except in full, without prior written approval of the Company. Any unauthorized alteration, forgery or falsification of the content or appearance of this document is unlawful and offenders may be prosecuted to the fullest extent of the law.



Report Number :TERF2404000927E2  
 Operation Mode :802.11a  
 Test Frequency :5785 MHz  
 Test Mode :Tx  
 EUT Pol :E2 Plane

Test Site :SAC G Chamber  
 Test Date :2024-05-13  
 Temp./Humi. :21.8°C/56%  
 Antenna Pol. :Vertical  
 Engineer :Temo Chen

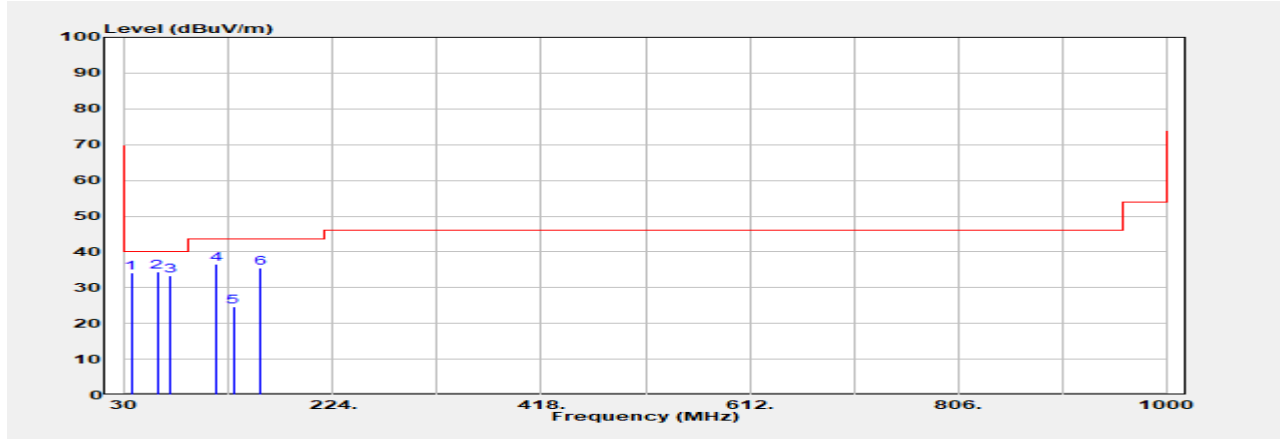

Freq. MHz	Detector Mode PK/QP/AVG	Spectrum Reading Level dB $\mu$ V	Factor dB	Actual FS dB $\mu$ V/m	Limit @3m dB $\mu$ V/m	Margin dB
35.820	QP	48.40	-14.25	34.15	40.00	-5.85
60.070	QP	47.30	-12.95	34.35	40.00	-5.65
72.680	QP	48.90	-15.45	33.45	40.00	-6.55
115.360	Peak	52.59	-15.95	36.64	43.50	-6.86
130.880	QP	39.20	-14.52	24.68	43.50	-18.82
156.100	Peak	48.23	-12.75	35.48	43.50	-8.02

Unless otherwise stated the results shown in this test report refer only to the sample(s) tested and such sample(s) are retained for 90 days only.

除非另有說明，此報告結果僅對測試之樣品負責，同時此樣品僅保留90天。本報告未經本公司書面許可，不可部份複製。

This document is issued by the Company subject to its General Conditions of Service printed overleaf, available on request or accessible at <http://www.sgs.com.tw/Terms-and-Conditions> and for electronic format documents, subject to Terms and Conditions for Electronic Documents at <http://www.sgs.com.tw/Terms-and-Conditions>. Attention is drawn to the limitation of liability, indemnification and jurisdiction issues defined therein. Any holder of this document is advised that information contained hereon reflects the Company's findings at the time of its intervention only and within the limits of Client's instructions, if any. The Company's sole responsibility is to its Client and this document does not exonerate parties to a transaction from exercising all their rights and obligations under the transaction documents. This document cannot be reproduced except in full, without prior written approval of the Company. Any unauthorized alteration, forgery or falsification of the content or appearance of this document is unlawful and offenders may be prosecuted to the fullest extent of the law.

Report Number :TERF2404000927E2  
 Operation Mode :802.11a  
 Test Frequency :5785 MHz  
 Test Mode :Tx  
 EUT Pol :E2 Plane

Test Site :SAC G Chamber  
 Test Date :2024-05-13  
 Temp./Humi. :21.8°C/56%  
 Antenna Pol. :Horizontal  
 Engineer :Temo Chen

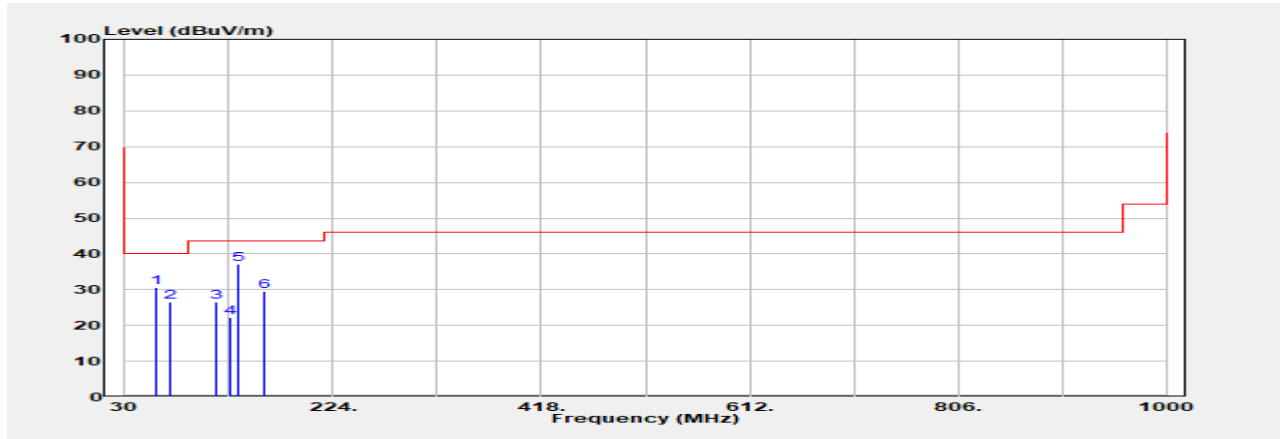

Freq. MHz	Detector Mode PK/QP/AVG	Spectrum Reading Level dBμV	Factor dB	Actual FS dBμV/m	Limit @3m dBμV/m	Margin dB
59.100	Peak	43.52	-13.02	30.50	40.00	-9.50
71.710	QP	41.60	-15.08	26.52	40.00	-13.48
115.360	QP	42.40	-15.95	26.45	43.50	-17.05
128.940	QP	37.00	-14.83	22.17	43.50	-21.33
135.730	Peak	51.06	-14.04	37.02	43.50	-6.48
159.010	Peak	42.11	-12.67	29.44	43.50	-14.06

Unless otherwise stated the results shown in this test report refer only to the sample(s) tested and such sample(s) are retained for 90 days only.

除非另有說明，此報告結果僅對測試之樣品負責，同時此樣品僅保留90天。本報告未經本公司書面許可，不可部份複製。

This document is issued by the Company subject to its General Conditions of Service printed overleaf, available on request or accessible at <http://www.sgs.com.tw/Terms-and-Conditions> and for electronic format documents, subject to Terms and Conditions for Electronic Documents at <http://www.sgs.com.tw/Terms-and-Conditions>. Attention is drawn to the limitation of liability, indemnification and jurisdiction issues defined therein. Any holder of this document is advised that information contained hereon reflects the Company's findings at the time of its intervention only and within the limits of Client's instructions, if any. The Company's sole responsibility is to its Client and this document does not exonerate parties to a transaction from exercising all their rights and obligations under the transaction documents. This document cannot be reproduced except in full, without prior written approval of the Company. Any unauthorized alteration, forgery or falsification of the content or appearance of this document is unlawful and offenders may be prosecuted to the fullest extent of the law.

Report Number :TERF2404000927E2  
 Operation Mode :802.11a  
 Test Frequency :5180 MHz  
 Test Mode :Tx  
 EUT Pol :E2 Plane

Test Site :SAC G Chamber  
 Test Date :2024-04-29  
 Temp./Humi. :20.6°C/62%  
 Antenna Pol. :Vertical  
 Engineer :Temo Chen

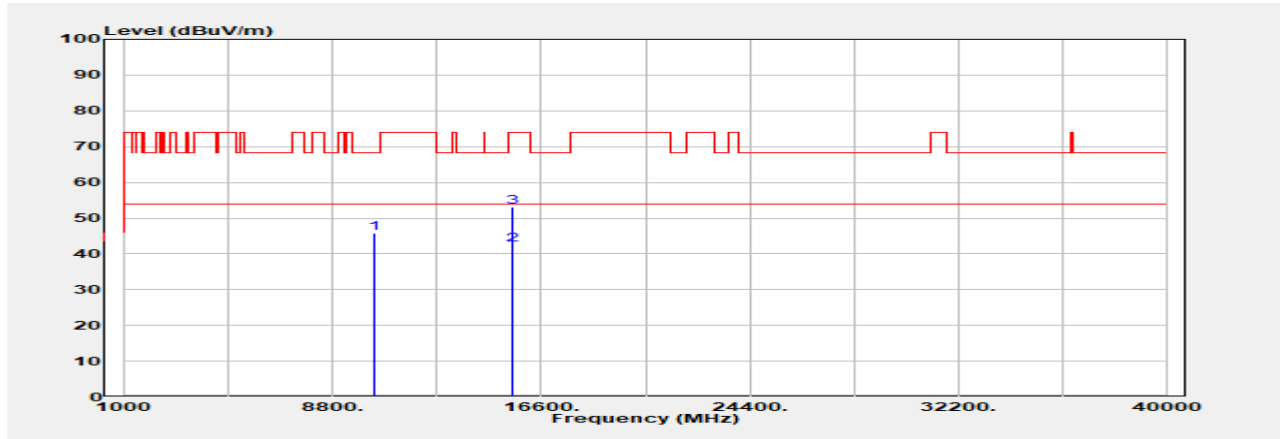

Freq. MHz	Detector Mode PK/QP/AVG	Spectrum Reading Level dB $\mu$ V	Factor dB	Actual FS dB $\mu$ V/m	Limit @3m dB $\mu$ V/m	Margin dB
10360.000	Peak	36.01	9.70	45.71	68.20	-22.49
15540.000	Average	30.33	12.28	42.61	54.00	-11.39
15540.000	Peak	40.95	12.28	53.22	74.00	-20.78

Unless otherwise stated the results shown in this test report refer only to the sample(s) tested and such sample(s) are retained for 90 days only.

除非另有說明，此報告結果僅對測試之樣品負責，同時此樣品僅保留90天。本報告未經本公司書面許可，不可部份複製。

This document is issued by the Company subject to its General Conditions of Service printed overleaf, available on request or accessible at <http://www.sgs.com.tw/Terms-and-Conditions> and for electronic format documents, subject to Terms and Conditions for Electronic Documents at <http://www.sgs.com.tw/Terms-and-Conditions>. Attention is drawn to the limitation of liability, indemnification and jurisdiction issues defined therein. Any holder of this document is advised that information contained hereon reflects the Company's findings at the time of its intervention only and within the limits of Client's instructions, if any. The Company's sole responsibility is to its Client and this document does not exonerate parties to a transaction from exercising all their rights and obligations under the transaction documents. This document cannot be reproduced except in full, without prior written approval of the Company. Any unauthorized alteration, forgery or falsification of the content or appearance of this document is unlawful and offenders may be prosecuted to the fullest extent of the law.

Report Number :TERF2404000927E2  
 Operation Mode :802.11a  
 Test Frequency :5180 MHz  
 Test Mode :Tx  
 EUT Pol :E2 Plane

Test Site :SAC G Chamber  
 Test Date :2024-04-29  
 Temp./Humi. :20.6°C/62%  
 Antenna Pol. :Horizontal  
 Engineer :Temo Chen

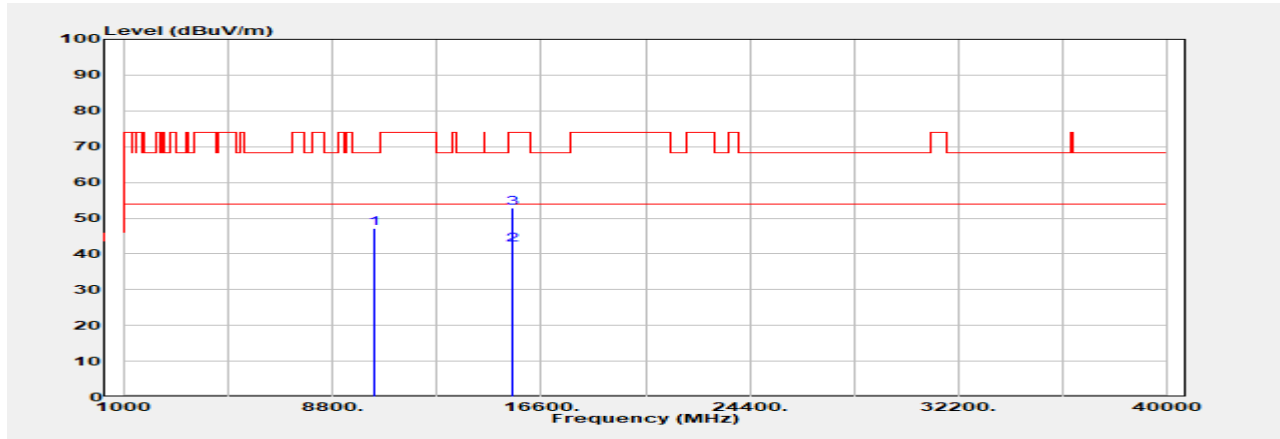

Freq. MHz	Detector Mode PK/QP/AVG	Spectrum Reading Level dB $\mu$ V	Factor dB	Actual FS dB $\mu$ V/m	Limit @3m dB $\mu$ V/m	Margin dB
10360.000	Peak	37.37	9.70	47.07	68.20	-21.13
15540.000	Average	30.31	12.28	42.59	54.00	-11.41
15540.000	Peak	40.58	12.28	52.86	74.00	-21.14

Unless otherwise stated the results shown in this test report refer only to the sample(s) tested and such sample(s) are retained for 90 days only.

除非另有說明，此報告結果僅對測試之樣品負責，同時此樣品僅保留90天。本報告未經本公司書面許可，不可部份複製。

This document is issued by the Company subject to its General Conditions of Service printed overleaf, available on request or accessible at <http://www.sgs.com.tw/Terms-and-Conditions> and for electronic format documents, subject to Terms and Conditions for Electronic Documents at <http://www.sgs.com.tw/Terms-and-Conditions>. Attention is drawn to the limitation of liability, indemnification and jurisdiction issues defined therein. Any holder of this document is advised that information contained hereon reflects the Company's findings at the time of its intervention only and within the limits of Client's instructions, if any. The Company's sole responsibility is to its Client and this document does not exonerate parties to a transaction from exercising all their rights and obligations under the transaction documents. This document cannot be reproduced except in full, without prior written approval of the Company. Any unauthorized alteration, forgery or falsification of the content or appearance of this document is unlawful and offenders may be prosecuted to the fullest extent of the law.

Report Number :TERF2404000927E2  
 Operation Mode :802.11a  
 Test Frequency :5220 MHz  
 Test Mode :Tx  
 EUT Pol :E2 Plane

Test Site :SAC G Chamber  
 Test Date :2024-04-29  
 Temp./Humi. :20.6°C/62%  
 Antenna Pol. :Vertical  
 Engineer :Temo Chen

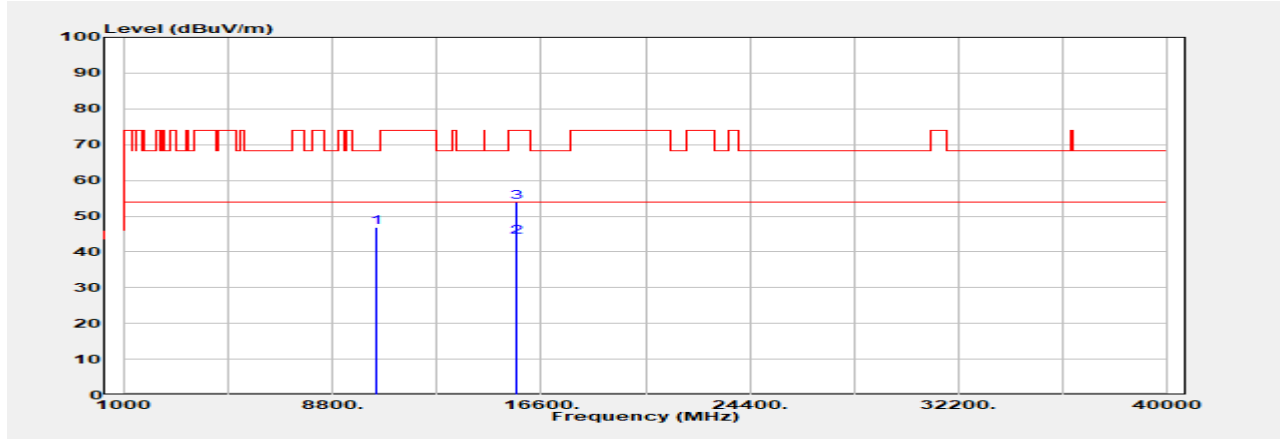

Freq. MHz	Detector Mode PK/QP/AVG	Spectrum Reading Level dB $\mu$ V	Factor dB	Actual FS dB $\mu$ V/m	Limit @3m dB $\mu$ V/m	Margin dB
10440.000	Peak	37.07	9.68	46.76	68.20	-21.44
15660.000	Average	31.09	13.00	44.09	54.00	-9.91
15660.000	Peak	40.88	13.00	53.88	74.00	-20.12

Unless otherwise stated the results shown in this test report refer only to the sample(s) tested and such sample(s) are retained for 90 days only.

除非另有說明，此報告結果僅對測試之樣品負責，同時此樣品僅保留90天。本報告未經本公司書面許可，不可部份複製。

This document is issued by the Company subject to its General Conditions of Service printed overleaf, available on request or accessible at <http://www.sgs.com.tw/Terms-and-Conditions> and for electronic format documents, subject to Terms and Conditions for Electronic Documents at <http://www.sgs.com.tw/Terms-and-Conditions>. Attention is drawn to the limitation of liability, indemnification and jurisdiction issues defined therein. Any holder of this document is advised that information contained hereon reflects the Company's findings at the time of its intervention only and within the limits of Client's instructions, if any. The Company's sole responsibility is to its Client and this document does not exonerate parties to a transaction from exercising all their rights and obligations under the transaction documents. This document cannot be reproduced except in full, without prior written approval of the Company. Any unauthorized alteration, forgery or falsification of the content or appearance of this document is unlawful and offenders may be prosecuted to the fullest extent of the law.

Report Number :TERF2404000927E2  
 Operation Mode :802.11a  
 Test Frequency :5220 MHz  
 Test Mode :Tx  
 EUT Pol :E2 Plane

Test Site :SAC G Chamber  
 Test Date :2024-04-29  
 Temp./Humi. :20.6°C/62%  
 Antenna Pol. :Horizontal  
 Engineer :Temo Chen

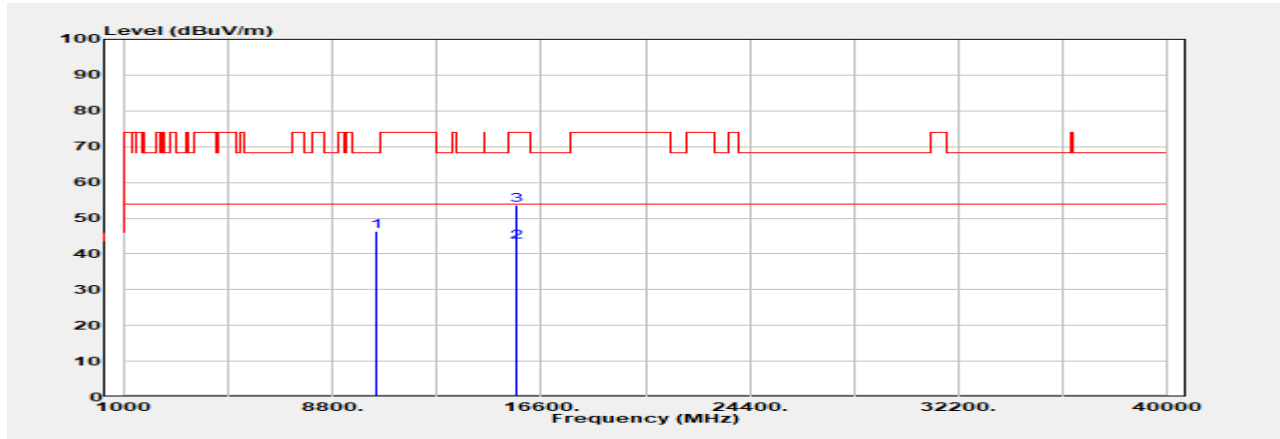

Freq. MHz	Detector Mode PK/QP/AVG	Spectrum Reading Level dB $\mu$ V	Factor dB	Actual FS dB $\mu$ V/m	Limit @3m dB $\mu$ V/m	Margin dB
10440.000	Peak	36.59	9.68	46.27	68.20	-21.93
15660.000	Average	30.28	13.00	43.28	54.00	-10.72
15660.000	Peak	40.70	13.00	53.70	74.00	-20.30

Unless otherwise stated the results shown in this test report refer only to the sample(s) tested and such sample(s) are retained for 90 days only.

除非另有說明，此報告結果僅對測試之樣品負責，同時此樣品僅保留90天。本報告未經本公司書面許可，不可部份複製。

This document is issued by the Company subject to its General Conditions of Service printed overleaf, available on request or accessible at <http://www.sgs.com.tw/Terms-and-Conditions> and for electronic format documents, subject to Terms and Conditions for Electronic Documents at <http://www.sgs.com.tw/Terms-and-Conditions>. Attention is drawn to the limitation of liability, indemnification and jurisdiction issues defined therein. Any holder of this document is advised that information contained hereon reflects the Company's findings at the time of its intervention only and within the limits of Client's instructions, if any. The Company's sole responsibility is to its Client and this document does not exonerate parties to a transaction from exercising all their rights and obligations under the transaction documents. This document cannot be reproduced except in full, without prior written approval of the Company. Any unauthorized alteration, forgery or falsification of the content or appearance of this document is unlawful and offenders may be prosecuted to the fullest extent of the law.

Report Number :TERF2404000927E2  
 Operation Mode :802.11a  
 Test Frequency :5240 MHz  
 Test Mode :Tx  
 EUT Pol :E2 Plane

Test Site :SAC G Chamber  
 Test Date :2024-04-29  
 Temp./Humi. :20.6°C/62%  
 Antenna Pol. :Vertical  
 Engineer :Temo Chen

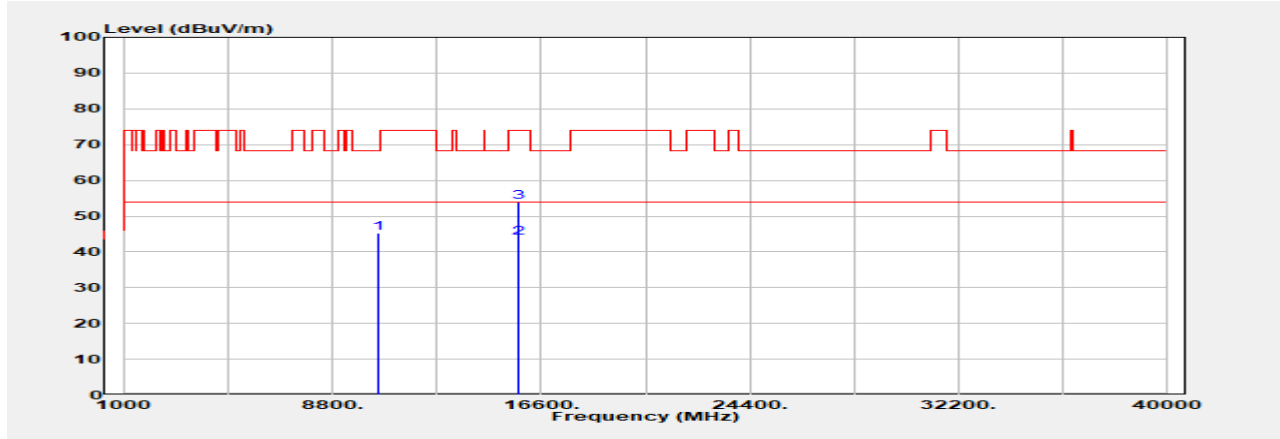

Freq. MHz	Detector Mode PK/QP/AVG	Spectrum Reading Level dB $\mu$ V	Factor dB	Actual FS dB $\mu$ V/m	Limit @3m dB $\mu$ V/m	Margin dB
10480.000	Peak	36.03	9.31	45.34	68.20	-22.86
15720.000	Average	30.34	13.49	43.83	54.00	-10.17
15720.000	Peak	40.54	13.49	54.03	74.00	-19.97

Unless otherwise stated the results shown in this test report refer only to the sample(s) tested and such sample(s) are retained for 90 days only.

除非另有說明，此報告結果僅對測試之樣品負責，同時此樣品僅保留90天。本報告未經本公司書面許可，不可部份複製。

This document is issued by the Company subject to its General Conditions of Service printed overleaf, available on request or accessible at <http://www.sgs.com.tw/Terms-and-Conditions> and for electronic format documents, subject to Terms and Conditions for Electronic Documents at <http://www.sgs.com.tw/Terms-and-Conditions>. Attention is drawn to the limitation of liability, indemnification and jurisdiction issues defined therein. Any holder of this document is advised that information contained hereon reflects the Company's findings at the time of its intervention only and within the limits of Client's instructions, if any. The Company's sole responsibility is to its Client and this document does not exonerate parties to a transaction from exercising all their rights and obligations under the transaction documents. This document cannot be reproduced except in full, without prior written approval of the Company. Any unauthorized alteration, forgery or falsification of the content or appearance of this document is unlawful and offenders may be prosecuted to the fullest extent of the law.



Report Number :TERF2404000927E2  
 Operation Mode :802.11a  
 Test Frequency :5240 MHz  
 Test Mode :Tx  
 EUT Pol :E2 Plane

Test Site :SAC G Chamber  
 Test Date :2024-04-29  
 Temp./Humi. :20.6°C/62%  
 Antenna Pol. :Horizontal  
 Engineer :Temo Chen

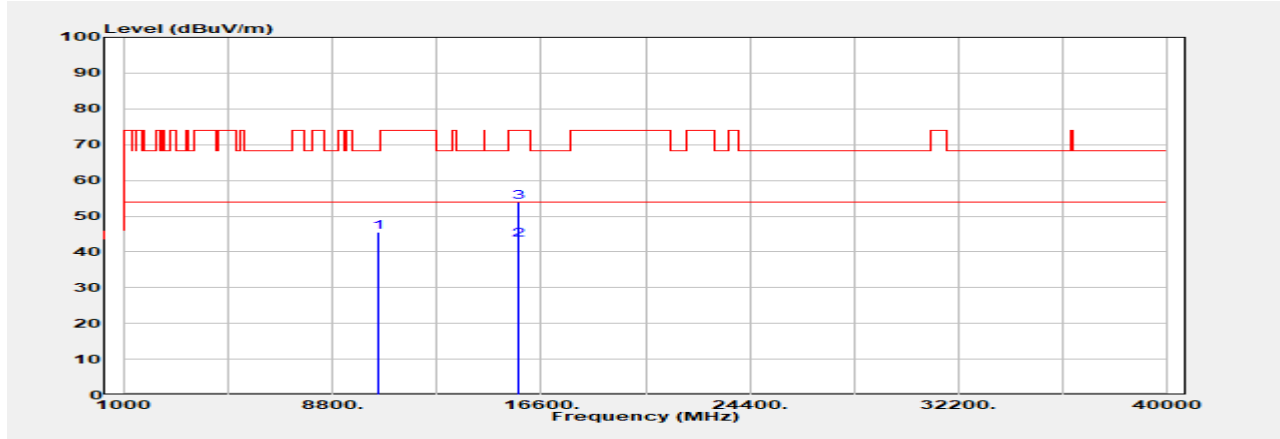

Freq. MHz	Detector Mode PK/QP/AVG	Spectrum Reading Level dBμV	Factor dB	Actual FS dBμV/m	Limit @3m dBμV/m	Margin dB
10480.000	Peak	36.20	9.31	45.51	68.20	-22.69
15720.000	Average	29.99	13.49	43.48	54.00	-10.52
15720.000	Peak	40.43	13.49	53.92	74.00	-20.08

Unless otherwise stated the results shown in this test report refer only to the sample(s) tested and such sample(s) are retained for 90 days only.

除非另有說明，此報告結果僅對測試之樣品負責，同時此樣品僅保留90天。本報告未經本公司書面許可，不可部份複製。

This document is issued by the Company subject to its General Conditions of Service printed overleaf, available on request or accessible at <http://www.sgs.com.tw/Terms-and-Conditions> and for electronic format documents, subject to Terms and Conditions for Electronic Documents at <http://www.sgs.com.tw/Terms-and-Conditions>. Attention is drawn to the limitation of liability, indemnification and jurisdiction issues defined therein. Any holder of this document is advised that information contained hereon reflects the Company's findings at the time of its intervention only and within the limits of Client's instructions, if any. The Company's sole responsibility is to its Client and this document does not exonerate parties to a transaction from exercising all their rights and obligations under the transaction documents. This document cannot be reproduced except in full, without prior written approval of the Company. Any unauthorized alteration, forgery or falsification of the content or appearance of this document is unlawful and offenders may be prosecuted to the fullest extent of the law.

Report Number :TERF2404000927E2  
 Operation Mode :802.11a  
 Test Frequency :5260 MHz  
 Test Mode :Tx  
 EUT Pol :E2 Plane

Test Site :SAC G Chamber  
 Test Date :2024-04-29  
 Temp./Humi. :20.6°C/62%  
 Antenna Pol. :Vertical  
 Engineer :Temo Chen

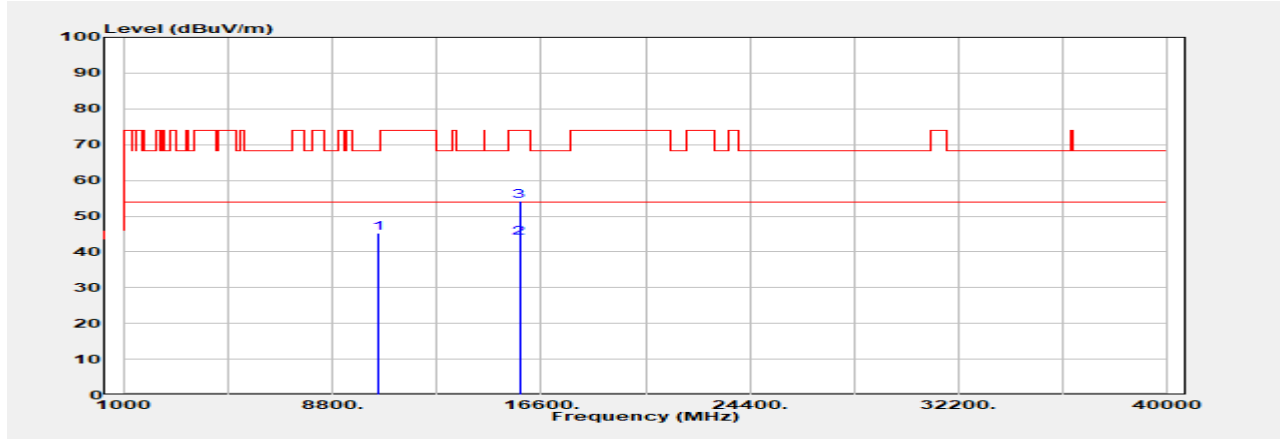

Freq. MHz	Detector Mode PK/QP/AVG	Spectrum Reading Level dB $\mu$ V	Factor dB	Actual FS dB $\mu$ V/m	Limit @3m dB $\mu$ V/m	Margin dB
10520.000	Peak	36.04	9.25	45.30	68.20	-22.90
15780.000	Average	30.81	13.08	43.89	54.00	-10.11
15780.000	Peak	41.04	13.08	54.11	74.00	-19.89

Unless otherwise stated the results shown in this test report refer only to the sample(s) tested and such sample(s) are retained for 90 days only.

除非另有說明，此報告結果僅對測試之樣品負責，同時此樣品僅保留90天。本報告未經本公司書面許可，不可部份複製。

This document is issued by the Company subject to its General Conditions of Service printed overleaf, available on request or accessible at <http://www.sgs.com.tw/Terms-and-Conditions> and for electronic format documents, subject to Terms and Conditions for Electronic Documents at <http://www.sgs.com.tw/Terms-and-Conditions>. Attention is drawn to the limitation of liability, indemnification and jurisdiction issues defined therein. Any holder of this document is advised that information contained hereon reflects the Company's findings at the time of its intervention only and within the limits of Client's instructions, if any. The Company's sole responsibility is to its Client and this document does not exonerate parties to a transaction from exercising all their rights and obligations under the transaction documents. This document cannot be reproduced except in full, without prior written approval of the Company. Any unauthorized alteration, forgery or falsification of the content or appearance of this document is unlawful and offenders may be prosecuted to the fullest extent of the law.

Report Number :TERF2404000927E2  
 Operation Mode :802.11a  
 Test Frequency :5260 MHz  
 Test Mode :Tx  
 EUT Pol :E2 Plane

Test Site :SAC G Chamber  
 Test Date :2024-04-29  
 Temp./Humi. :20.6°C/62%  
 Antenna Pol. :Horizontal  
 Engineer :Temo Chen

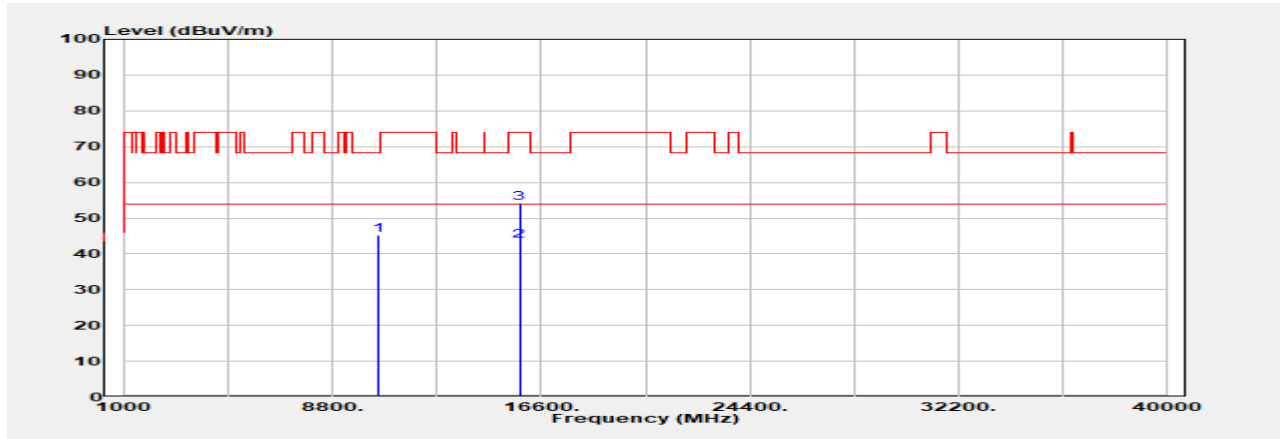

Freq. MHz	Detector Mode PK/QP/AVG	Spectrum Reading Level dBμV	Factor dB	Actual FS dBμV/m	Limit @3m dBμV/m	Margin dB
10520.000	Peak	36.14	9.25	45.39	68.20	-22.81
15780.000	Average	30.47	13.08	43.55	54.00	-10.45
15780.000	Peak	41.21	13.08	54.29	74.00	-19.71

Unless otherwise stated the results shown in this test report refer only to the sample(s) tested and such sample(s) are retained for 90 days only.

除非另有說明，此報告結果僅對測試之樣品負責，同時此樣品僅保留90天。本報告未經本公司書面許可，不可部份複製。

This document is issued by the Company subject to its General Conditions of Service printed overleaf, available on request or accessible at <http://www.sgs.com.tw/Terms-and-Conditions> and for electronic format documents, subject to Terms and Conditions for Electronic Documents at <http://www.sgs.com.tw/Terms-and-Conditions>. Attention is drawn to the limitation of liability, indemnification and jurisdiction issues defined therein. Any holder of this document is advised that information contained hereon reflects the Company's findings at the time of its intervention only and within the limits of Client's instructions, if any. The Company's sole responsibility is to its Client and this document does not exonerate parties to a transaction from exercising all their rights and obligations under the transaction documents. This document cannot be reproduced except in full, without prior written approval of the Company. Any unauthorized alteration, forgery or falsification of the content or appearance of this document is unlawful and offenders may be prosecuted to the fullest extent of the law.

Report Number :TERF2404000927E2  
 Operation Mode :802.11a  
 Test Frequency :5300 MHz  
 Test Mode :Tx  
 EUT Pol :E2 Plane

Test Site :SAC G Chamber  
 Test Date :2024-04-29  
 Temp./Humi. :20.6°C/62%  
 Antenna Pol. :Vertical  
 Engineer :Temo Chen

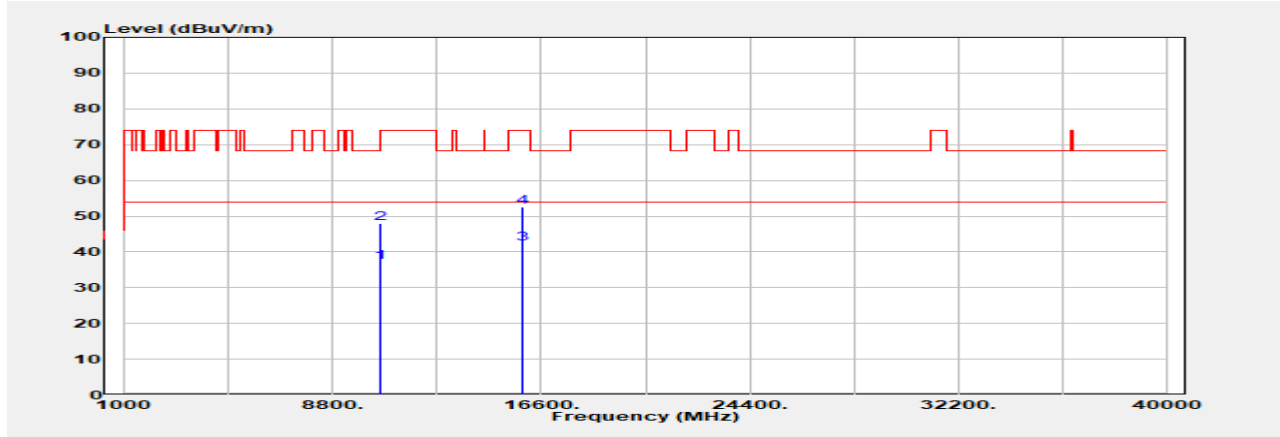

Freq. MHz	Detector Mode PK/QP/AVG	Spectrum Reading Level dB $\mu$ V	Factor dB	Actual FS dB $\mu$ V/m	Limit @3m dB $\mu$ V/m	Margin dB
10600.000	Average	27.30	9.74	37.04	54.00	-16.96
10600.000	Peak	38.30	9.74	48.04	74.00	-25.96
15900.000	Average	29.27	12.95	42.22	54.00	-11.78
15900.000	Peak	39.51	12.95	52.46	74.00	-21.54

Unless otherwise stated the results shown in this test report refer only to the sample(s) tested and such sample(s) are retained for 90 days only.

除非另有說明，此報告結果僅對測試之樣品負責，同時此樣品僅保留90天。本報告未經本公司書面許可，不可部份複製。

This document is issued by the Company subject to its General Conditions of Service printed overleaf, available on request or accessible at <http://www.sgs.com.tw/Terms-and-Conditions> and for electronic format documents, subject to Terms and Conditions for Electronic Documents at <http://www.sgs.com.tw/Terms-and-Conditions>. Attention is drawn to the limitation of liability, indemnification and jurisdiction issues defined therein. Any holder of this document is advised that information contained hereon reflects the Company's findings at the time of its intervention only and within the limits of Client's instructions, if any. The Company's sole responsibility is to its Client and this document does not exonerate parties to a transaction from exercising all their rights and obligations under the transaction documents. This document cannot be reproduced except in full, without prior written approval of the Company. Any unauthorized alteration, forgery or falsification of the content or appearance of this document is unlawful and offenders may be prosecuted to the fullest extent of the law.

Report Number :TERF2404000927E2  
 Operation Mode :802.11a  
 Test Frequency :5300 MHz  
 Test Mode :Tx  
 EUT Pol :E2 Plane

Test Site :SAC G Chamber  
 Test Date :2024-04-29  
 Temp./Humi. :20.6°C/62%  
 Antenna Pol. :Horizontal  
 Engineer :Temo Chen

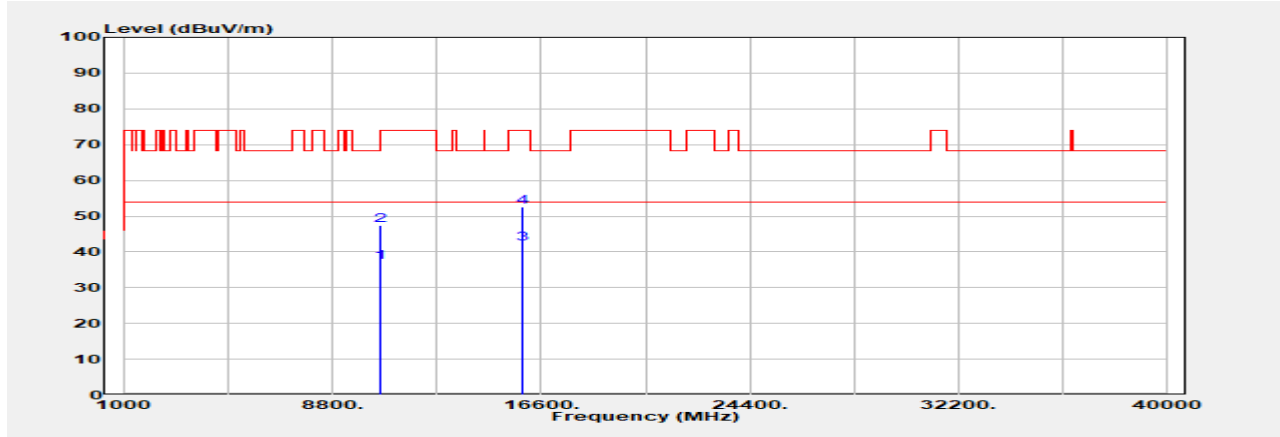

Freq. MHz	Detector Mode PK/QP/AVG	Spectrum Reading Level dB $\mu$ V	Factor dB	Actual FS dB $\mu$ V/m	Limit @3m dB $\mu$ V/m	Margin dB
10600.000	Average	27.41	9.74	37.15	54.00	-16.85
10600.000	Peak	37.62	9.74	47.36	74.00	-26.64
15900.000	Average	29.26	12.95	42.21	54.00	-11.79
15900.000	Peak	39.56	12.95	52.51	74.00	-21.49

Unless otherwise stated the results shown in this test report refer only to the sample(s) tested and such sample(s) are retained for 90 days only.

除非另有說明，此報告結果僅對測試之樣品負責，同時此樣品僅保留90天。本報告未經本公司書面許可，不可部份複製。

This document is issued by the Company subject to its General Conditions of Service printed overleaf, available on request or accessible at <http://www.sgs.com.tw/Terms-and-Conditions> and for electronic format documents, subject to Terms and Conditions for Electronic Documents at <http://www.sgs.com.tw/Terms-and-Conditions>. Attention is drawn to the limitation of liability, indemnification and jurisdiction issues defined therein. Any holder of this document is advised that information contained hereon reflects the Company's findings at the time of its intervention only and within the limits of Client's instructions, if any. The Company's sole responsibility is to its Client and this document does not exonerate parties to a transaction from exercising all their rights and obligations under the transaction documents. This document cannot be reproduced except in full, without prior written approval of the Company. Any unauthorized alteration, forgery or falsification of the content or appearance of this document is unlawful and offenders may be prosecuted to the fullest extent of the law.

Report Number :TERF2404000927E2  
 Operation Mode :802.11a  
 Test Frequency :5320 MHz  
 Test Mode :Tx  
 EUT Pol :E2 Plane

Test Site :SAC G Chamber  
 Test Date :2024-04-29  
 Temp./Humi. :20.6°C/62%  
 Antenna Pol. :Vertical  
 Engineer :Temo Chen

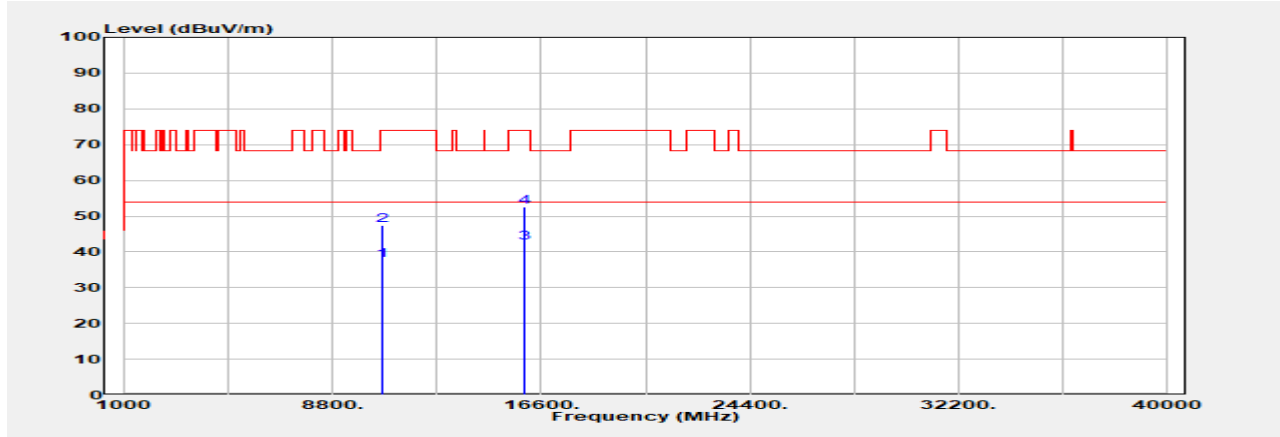

Freq. MHz	Detector Mode PK/QP/AVG	Spectrum Reading Level dBμV	Factor dB	Actual FS dBμV/m	Limit @3m dBμV/m	Margin dB
10640.000	Average	28.01	9.74	37.75	54.00	-16.25
10640.000	Peak	37.80	9.74	47.53	74.00	-26.47
15960.000	Average	29.93	12.50	42.43	54.00	-11.57
15960.000	Peak	40.19	12.50	52.69	74.00	-21.31

Unless otherwise stated the results shown in this test report refer only to the sample(s) tested and such sample(s) are retained for 90 days only.

除非另有說明，此報告結果僅對測試之樣品負責，同時此樣品僅保留90天。本報告未經本公司書面許可，不可部份複製。

This document is issued by the Company subject to its General Conditions of Service printed overleaf, available on request or accessible at <http://www.sgs.com.tw/Terms-and-Conditions> and for electronic format documents, subject to Terms and Conditions for Electronic Documents at <http://www.sgs.com.tw/Terms-and-Conditions>. Attention is drawn to the limitation of liability, indemnification and jurisdiction issues defined therein. Any holder of this document is advised that information contained hereon reflects the Company's findings at the time of its intervention only and within the limits of Client's instructions, if any. The Company's sole responsibility is to its Client and this document does not exonerate parties to a transaction from exercising all their rights and obligations under the transaction documents. This document cannot be reproduced except in full, without prior written approval of the Company. Any unauthorized alteration, forgery or falsification of the content or appearance of this document is unlawful and offenders may be prosecuted to the fullest extent of the law.

Report Number :TERF2404000927E2  
 Operation Mode :802.11a  
 Test Frequency :5320 MHz  
 Test Mode :Tx  
 EUT Pol :E2 Plane

Test Site :SAC G Chamber  
 Test Date :2024-04-29  
 Temp./Humi. :20.6°C/62%  
 Antenna Pol. :Horizontal  
 Engineer :Temo Chen

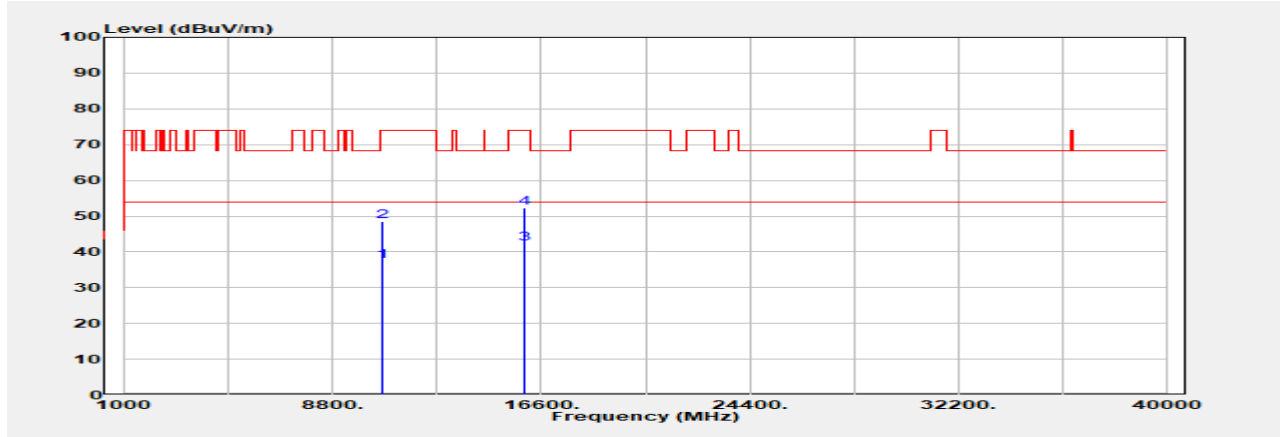

Freq. MHz	Detector Mode PK/QP/AVG	Spectrum Reading Level dB $\mu$ V	Factor dB	Actual FS dB $\mu$ V/m	Limit @3m dB $\mu$ V/m	Margin dB
10640.000	Average	27.76	9.74	37.50	54.00	-16.50
10640.000	Peak	38.86	9.74	48.60	74.00	-25.40
15960.000	Average	29.91	12.50	42.41	54.00	-11.59
15960.000	Peak	39.85	12.50	52.35	74.00	-21.65

Unless otherwise stated the results shown in this test report refer only to the sample(s) tested and such sample(s) are retained for 90 days only.

除非另有說明，此報告結果僅對測試之樣品負責，同時此樣品僅保留90天。本報告未經本公司書面許可，不可部份複製。

This document is issued by the Company subject to its General Conditions of Service printed overleaf, available on request or accessible at <http://www.sgs.com.tw/Terms-and-Conditions> and for electronic format documents, subject to Terms and Conditions for Electronic Documents at <http://www.sgs.com.tw/Terms-and-Conditions>. Attention is drawn to the limitation of liability, indemnification and jurisdiction issues defined therein. Any holder of this document is advised that information contained hereon reflects the Company's findings at the time of its intervention only and within the limits of Client's instructions, if any. The Company's sole responsibility is to its Client and this document does not exonerate parties to a transaction from exercising all their rights and obligations under the transaction documents. This document cannot be reproduced except in full, without prior written approval of the Company. Any unauthorized alteration, forgery or falsification of the content or appearance of this document is unlawful and offenders may be prosecuted to the fullest extent of the law.

Report Number :TERF2404000927E2  
 Operation Mode :802.11a  
 Test Frequency :5500 MHz  
 Test Mode :Tx  
 EUT Pol :E2 Plane

Test Site :SAC G Chamber  
 Test Date :2024-04-29  
 Temp./Humi. :20.6°C/62%  
 Antenna Pol. :Vertical  
 Engineer :Temo Chen

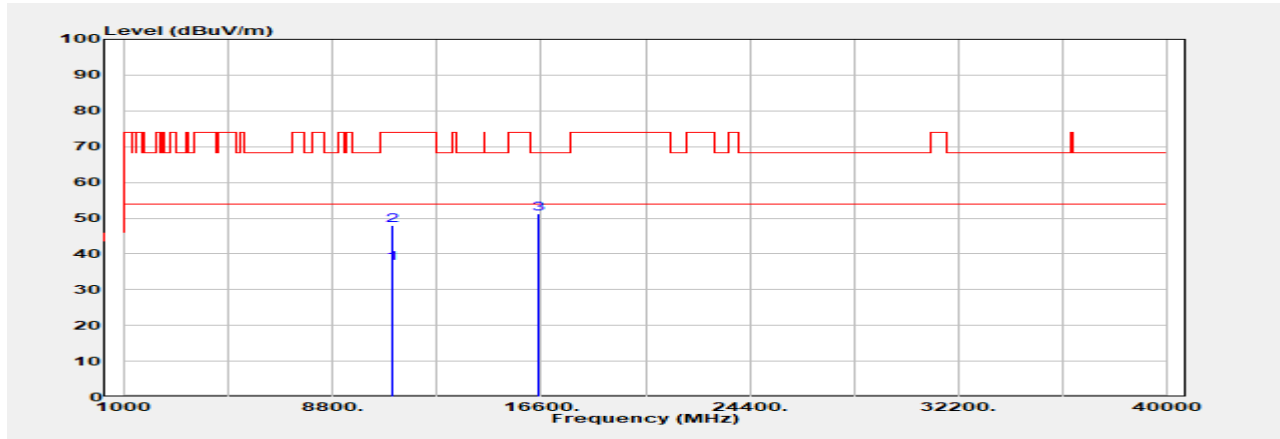

Freq. MHz	Detector Mode PK/QP/AVG	Spectrum Reading Level dB $\mu$ V	Factor dB	Actual FS dB $\mu$ V/m	Limit @3m dB $\mu$ V/m	Margin dB
11000.000	Average	27.27	10.07	37.34	54.00	-16.66
11000.000	Peak	37.83	10.07	47.90	74.00	-26.10
16500.000	Peak	38.57	12.65	51.22	68.20	-16.98

Unless otherwise stated the results shown in this test report refer only to the sample(s) tested and such sample(s) are retained for 90 days only.

除非另有說明，此報告結果僅對測試之樣品負責，同時此樣品僅保留90天。本報告未經本公司書面許可，不可部份複製。

This document is issued by the Company subject to its General Conditions of Service printed overleaf, available on request or accessible at <http://www.sgs.com.tw/Terms-and-Conditions> and for electronic format documents, subject to Terms and Conditions for Electronic Documents at <http://www.sgs.com.tw/Terms-and-Conditions>. Attention is drawn to the limitation of liability, indemnification and jurisdiction issues defined therein. Any holder of this document is advised that information contained hereon reflects the Company's findings at the time of its intervention only and within the limits of Client's instructions, if any. The Company's sole responsibility is to its Client and this document does not exonerate parties to a transaction from exercising all their rights and obligations under the transaction documents. This document cannot be reproduced except in full, without prior written approval of the Company. Any unauthorized alteration, forgery or falsification of the content or appearance of this document is unlawful and offenders may be prosecuted to the fullest extent of the law.



Report Number :TERF2404000927E2  
 Operation Mode :802.11a  
 Test Frequency :5500 MHz  
 Test Mode :Tx  
 EUT Pol :E2 Plane

Test Site :SAC G Chamber  
 Test Date :2024-04-29  
 Temp./Humi. :20.6°C/62%  
 Antenna Pol. :Horizontal  
 Engineer :Temo Chen

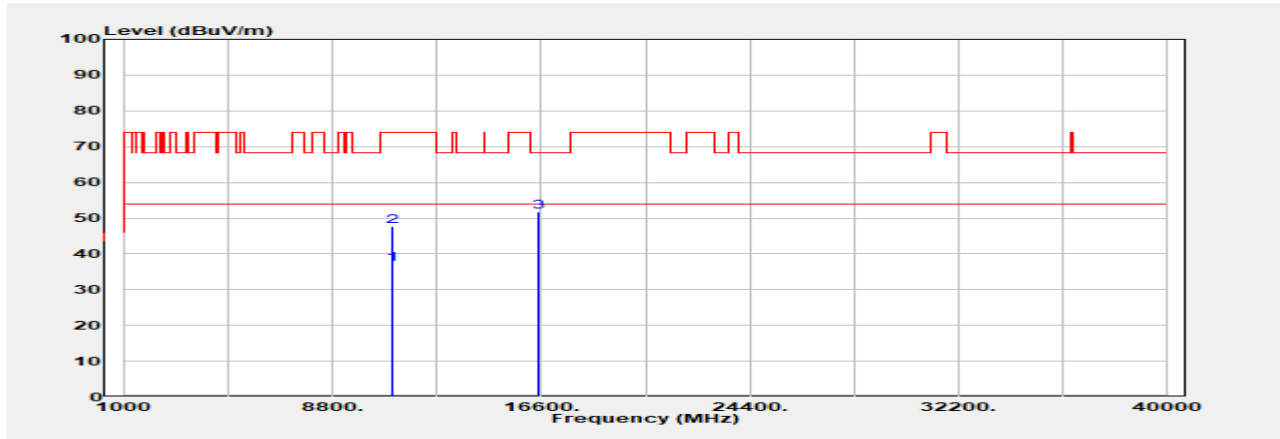

Freq. MHz	Detector Mode PK/QP/AVG	Spectrum Reading Level dBμV	Factor dB	Actual FS dBμV/m	Limit @3m dBμV/m	Margin dB
11000.000	Average	27.17	10.07	37.24	54.00	-16.76
11000.000	Peak	37.52	10.07	47.59	74.00	-26.41
16500.000	Peak	39.09	12.65	51.74	68.20	-16.46

Unless otherwise stated the results shown in this test report refer only to the sample(s) tested and such sample(s) are retained for 90 days only.

除非另有說明，此報告結果僅對測試之樣品負責，同時此樣品僅保留90天。本報告未經本公司書面許可，不可部份複製。

This document is issued by the Company subject to its General Conditions of Service printed overleaf, available on request or accessible at <http://www.sgs.com.tw/Terms-and-Conditions> and for electronic format documents, subject to Terms and Conditions for Electronic Documents at <http://www.sgs.com.tw/Terms-and-Conditions>. Attention is drawn to the limitation of liability, indemnification and jurisdiction issues defined therein. Any holder of this document is advised that information contained hereon reflects the Company's findings at the time of its intervention only and within the limits of Client's instructions, if any. The Company's sole responsibility is to its Client and this document does not exonerate parties to a transaction from exercising all their rights and obligations under the transaction documents. This document cannot be reproduced except in full, without prior written approval of the Company. Any unauthorized alteration, forgery or falsification of the content or appearance of this document is unlawful and offenders may be prosecuted to the fullest extent of the law.

Report Number :TERF2404000927E2  
 Operation Mode :802.11a  
 Test Frequency :5580 MHz  
 Test Mode :Tx  
 EUT Pol :E2 Plane

Test Site :SAC G Chamber  
 Test Date :2024-04-29  
 Temp./Humi. :20.6°C/62%  
 Antenna Pol. :Vertical  
 Engineer :Temo Chen

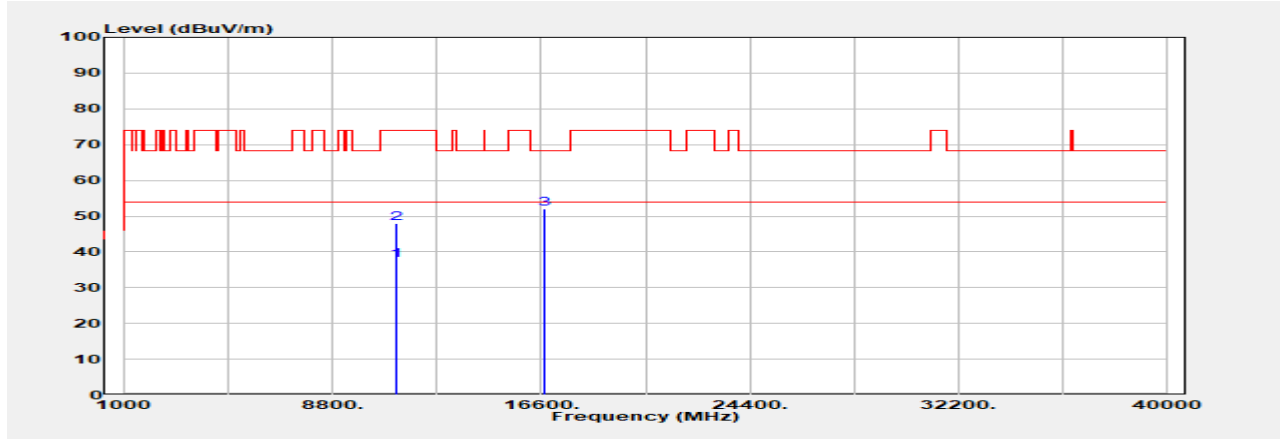

Freq. MHz	Detector Mode PK/QP/AVG	Spectrum Reading Level dB $\mu$ V	Factor dB	Actual FS dB $\mu$ V/m	Limit @3m dB $\mu$ V/m	Margin dB
11160.000	Average	27.83	9.90	37.73	54.00	-16.27
11160.000	Peak	38.10	9.90	48.00	74.00	-26.00
16740.000	Peak	39.85	12.28	52.13	68.20	-16.07

Unless otherwise stated the results shown in this test report refer only to the sample(s) tested and such sample(s) are retained for 90 days only.

除非另有說明，此報告結果僅對測試之樣品負責，同時此樣品僅保留90天。本報告未經本公司書面許可，不可部份複製。

This document is issued by the Company subject to its General Conditions of Service printed overleaf, available on request or accessible at <http://www.sgs.com.tw/Terms-and-Conditions> and for electronic format documents, subject to Terms and Conditions for Electronic Documents at <http://www.sgs.com.tw/Terms-and-Conditions>. Attention is drawn to the limitation of liability, indemnification and jurisdiction issues defined therein. Any holder of this document is advised that information contained hereon reflects the Company's findings at the time of its intervention only and within the limits of Client's instructions, if any. The Company's sole responsibility is to its Client and this document does not exonerate parties to a transaction from exercising all their rights and obligations under the transaction documents. This document cannot be reproduced except in full, without prior written approval of the Company. Any unauthorized alteration, forgery or falsification of the content or appearance of this document is unlawful and offenders may be prosecuted to the fullest extent of the law.

Report Number :TERF2404000927E2  
 Operation Mode :802.11a  
 Test Frequency :5580 MHz  
 Test Mode :Tx  
 EUT Pol :E2 Plane

Test Site :SAC G Chamber  
 Test Date :2024-04-29  
 Temp./Humi. :20.6°C/62%  
 Antenna Pol. :Horizontal  
 Engineer :Temo Chen

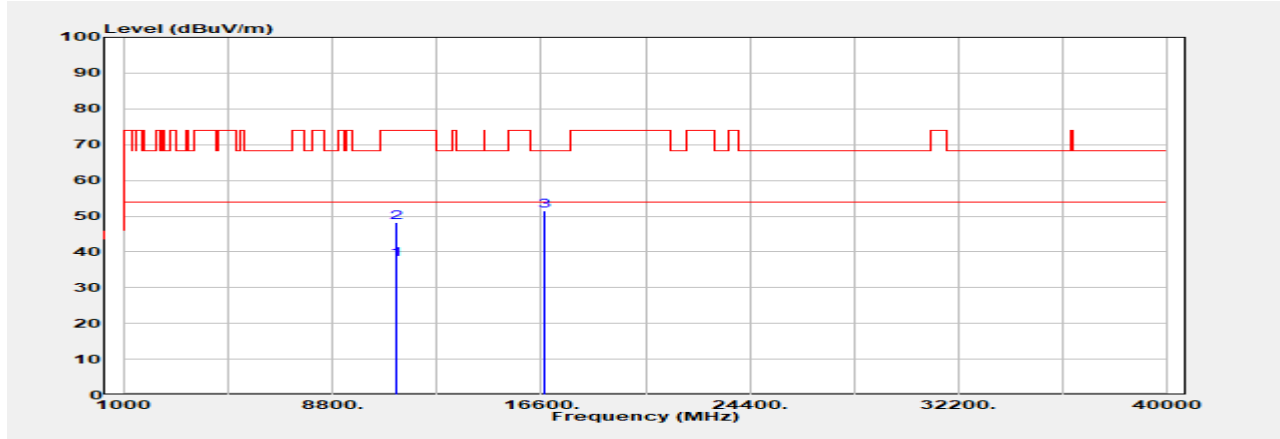

Freq. MHz	Detector Mode PK/QP/AVG	Spectrum Reading Level dB $\mu$ V	Factor dB	Actual FS dB $\mu$ V/m	Limit @3m dB $\mu$ V/m	Margin dB
11160.000	Average	27.97	9.90	37.87	54.00	-16.13
11160.000	Peak	38.45	9.90	48.35	74.00	-25.65
16740.000	Peak	39.16	12.28	51.45	68.20	-16.75

Unless otherwise stated the results shown in this test report refer only to the sample(s) tested and such sample(s) are retained for 90 days only.

除非另有說明，此報告結果僅對測試之樣品負責，同時此樣品僅保留90天。本報告未經本公司書面許可，不可部份複製。

This document is issued by the Company subject to its General Conditions of Service printed overleaf, available on request or accessible at <http://www.sgs.com.tw/Terms-and-Conditions> and for electronic format documents, subject to Terms and Conditions for Electronic Documents at <http://www.sgs.com.tw/Terms-and-Conditions>. Attention is drawn to the limitation of liability, indemnification and jurisdiction issues defined therein. Any holder of this document is advised that information contained hereon reflects the Company's findings at the time of its intervention only and within the limits of Client's instructions, if any. The Company's sole responsibility is to its Client and this document does not exonerate parties to a transaction from exercising all their rights and obligations under the transaction documents. This document cannot be reproduced except in full, without prior written approval of the Company. Any unauthorized alteration, forgery or falsification of the content or appearance of this document is unlawful and offenders may be prosecuted to the fullest extent of the law.

Report Number :TERF2404000927E2

Test Site :SAC G Chamber

Operation Mode :802.11a

Test Date :2024-04-29

Test Frequency :5700 MHz

Temp./Humi. :20.6°C/62%

Test Mode :Tx

Antenna Pol. :Vertical

EUT Pol :E2 Plane

Engineer :Temo Chen

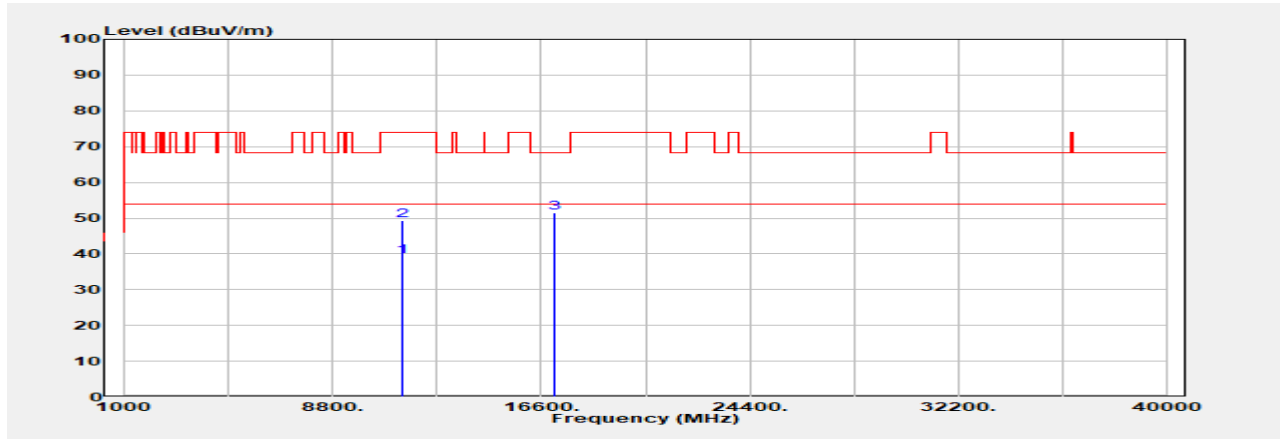

Freq. MHz	Detector Mode PK/QP/AVG	Spectrum Reading Level dBμV	Factor dB	Actual FS dBμV/m	Limit @3m dBμV/m	Margin dB
11400.000	Average	27.07	12.22	39.29	54.00	-14.71
11400.000	Peak	37.19	12.22	49.41	74.00	-24.59
17100.000	Peak	39.10	12.32	51.42	68.20	-16.78

Unless otherwise stated the results shown in this test report refer only to the sample(s) tested and such sample(s) are retained for 90 days only.

除非另有說明，此報告結果僅對測試之樣品負責，同時此樣品僅保留90天。本報告未經本公司書面許可，不可部份複製。

This document is issued by the Company subject to its General Conditions of Service printed overleaf, available on request or accessible at <http://www.sgs.com.tw/Terms-and-Conditions> and for electronic format documents, subject to Terms and Conditions for Electronic Documents at <http://www.sgs.com.tw/Terms-and-Conditions>. Attention is drawn to the limitation of liability, indemnification and jurisdiction issues defined therein. Any holder of this document is advised that information contained hereon reflects the Company's findings at the time of its intervention only and within the limits of Client's instructions, if any. The Company's sole responsibility is to its Client and this document does not exonerate parties to a transaction from exercising all their rights and obligations under the transaction documents. This document cannot be reproduced except in full, without prior written approval of the Company. Any unauthorized alteration, forgery or falsification of the content or appearance of this document is unlawful and offenders may be prosecuted to the fullest extent of the law.

Report Number :TERF2404000927E2  
 Operation Mode :802.11a  
 Test Frequency :5700 MHz  
 Test Mode :Tx  
 EUT Pol :E2 Plane

Test Site :SAC G Chamber  
 Test Date :2024-04-29  
 Temp./Humi. :20.6°C/62%  
 Antenna Pol. :Horizontal  
 Engineer :Temo Chen

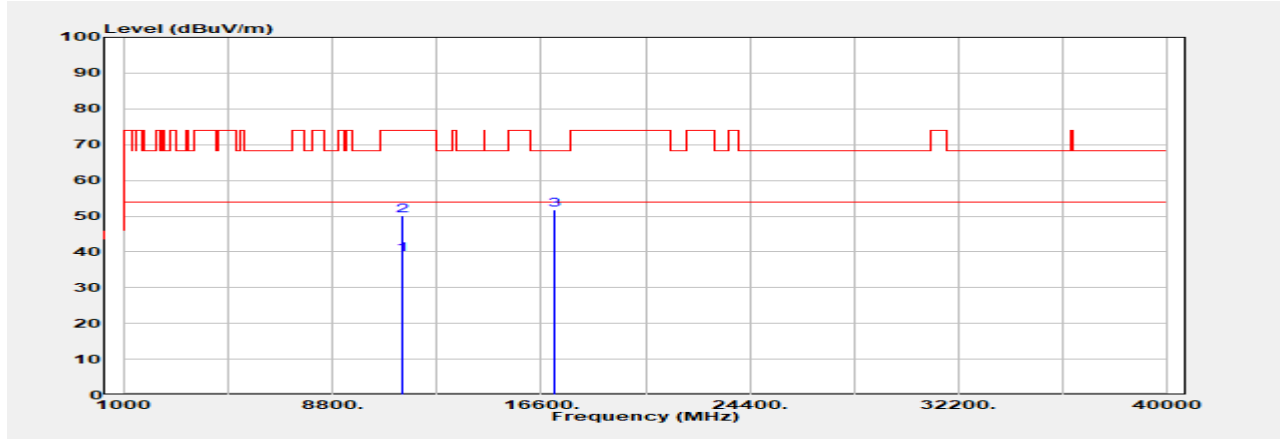

Freq. MHz	Detector Mode PK/QP/AVG	Spectrum Reading Level dB $\mu$ V	Factor dB	Actual FS dB $\mu$ V/m	Limit @3m dB $\mu$ V/m	Margin dB
11400.000	Average	27.00	12.22	39.22	54.00	-14.78
11400.000	Peak	37.78	12.22	50.00	74.00	-24.00
17100.000	Peak	39.43	12.32	51.75	68.20	-16.45

Unless otherwise stated the results shown in this test report refer only to the sample(s) tested and such sample(s) are retained for 90 days only.

除非另有說明，此報告結果僅對測試之樣品負責，同時此樣品僅保留90天。本報告未經本公司書面許可，不可部份複製。

This document is issued by the Company subject to its General Conditions of Service printed overleaf, available on request or accessible at <http://www.sgs.com.tw/Terms-and-Conditions> and for electronic format documents, subject to Terms and Conditions for Electronic Documents at <http://www.sgs.com.tw/Terms-and-Conditions>. Attention is drawn to the limitation of liability, indemnification and jurisdiction issues defined therein. Any holder of this document is advised that information contained hereon reflects the Company's findings at the time of its intervention only and within the limits of Client's instructions, if any. The Company's sole responsibility is to its Client and this document does not exonerate parties to a transaction from exercising all their rights and obligations under the transaction documents. This document cannot be reproduced except in full, without prior written approval of the Company. Any unauthorized alteration, forgery or falsification of the content or appearance of this document is unlawful and offenders may be prosecuted to the fullest extent of the law.

Report Number :TERF2404000927E2  
 Operation Mode :802.11a  
 Test Frequency :5720 MHz  
 Test Mode :Tx  
 EUT Pol :E2 Plane

Test Site :SAC G Chamber  
 Test Date :2024-04-29  
 Temp./Humi. :20.6°C/62%  
 Antenna Pol. :Vertical  
 Engineer :Temo Chen

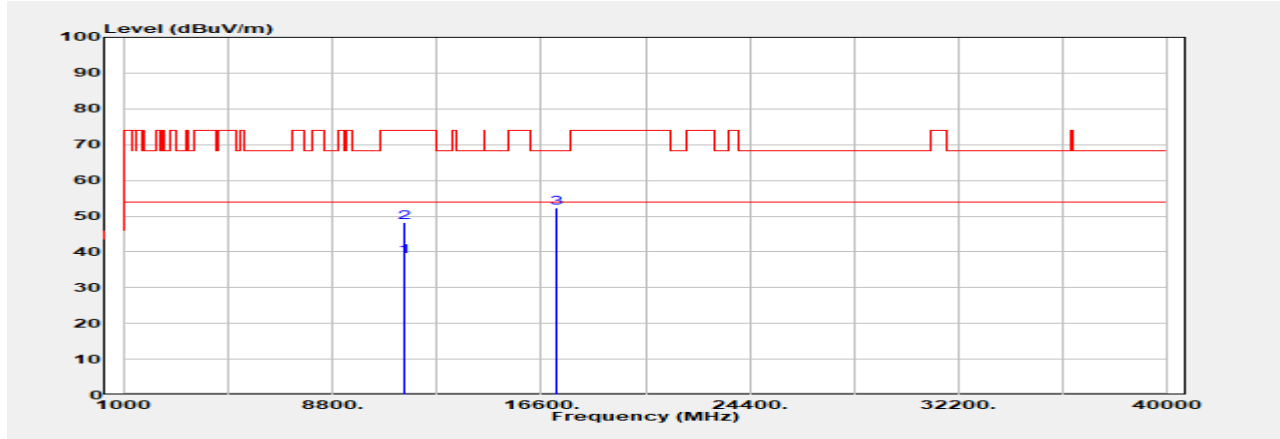

Freq. MHz	Detector Mode PK/QP/AVG	Spectrum Reading Level dBμV	Factor dB	Actual FS dBμV/m	Limit @3m dBμV/m	Margin dB
11440.000	Average	27.36	11.39	38.75	54.00	-15.25
11440.000	Peak	36.97	11.39	48.36	74.00	-25.64
17160.000	Peak	40.45	11.94	52.39	68.20	-15.81

Unless otherwise stated the results shown in this test report refer only to the sample(s) tested and such sample(s) are retained for 90 days only.

除非另有說明，此報告結果僅對測試之樣品負責，同時此樣品僅保留90天。本報告未經本公司書面許可，不可部份複製。

This document is issued by the Company subject to its General Conditions of Service printed overleaf, available on request or accessible at <http://www.sgs.com.tw/Terms-and-Conditions> and for electronic format documents, subject to Terms and Conditions for Electronic Documents at <http://www.sgs.com.tw/Terms-and-Conditions>. Attention is drawn to the limitation of liability, indemnification and jurisdiction issues defined therein. Any holder of this document is advised that information contained hereon reflects the Company's findings at the time of its intervention only and within the limits of Client's instructions, if any. The Company's sole responsibility is to its Client and this document does not exonerate parties to a transaction from exercising all their rights and obligations under the transaction documents. This document cannot be reproduced except in full, without prior written approval of the Company. Any unauthorized alteration, forgery or falsification of the content or appearance of this document is unlawful and offenders may be prosecuted to the fullest extent of the law.

Report Number :TERF2404000927E2  
 Operation Mode :802.11a  
 Test Frequency :5720 MHz  
 Test Mode :Tx  
 EUT Pol :E2 Plane

Test Site :SAC G Chamber  
 Test Date :2024-04-29  
 Temp./Humi. :20.6°C/62%  
 Antenna Pol. :Horizontal  
 Engineer :Temo Chen

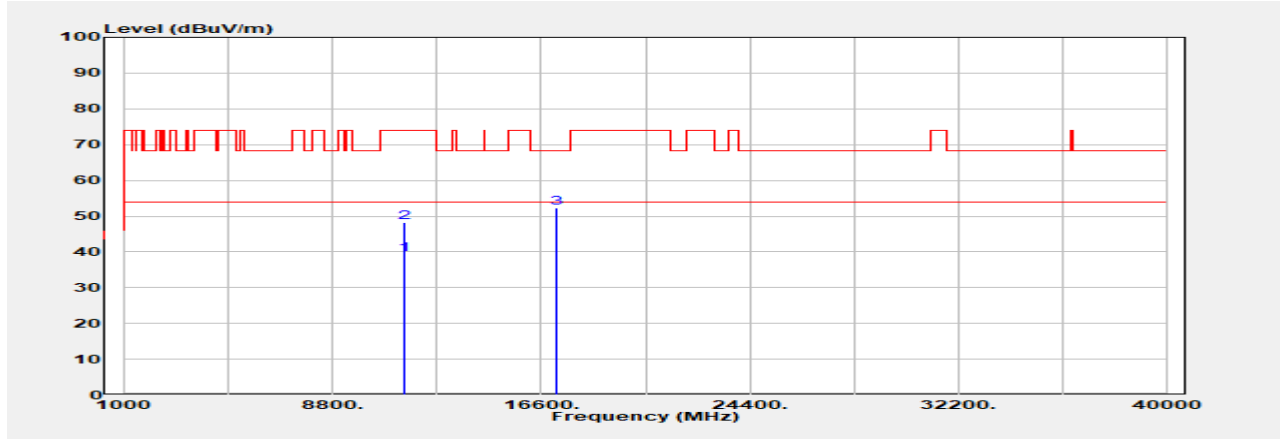

Freq. MHz	Detector Mode PK/QP/AVG	Spectrum Reading Level dB $\mu$ V	Factor dB	Actual FS dB $\mu$ V/m	Limit @3m dB $\mu$ V/m	Margin dB
11440.000	Average	27.84	11.39	39.23	54.00	-14.77
11440.000	Peak	36.75	11.39	48.13	74.00	-25.87
17160.000	Peak	40.28	11.94	52.22	68.20	-15.98

Unless otherwise stated the results shown in this test report refer only to the sample(s) tested and such sample(s) are retained for 90 days only.

除非另有說明，此報告結果僅對測試之樣品負責，同時此樣品僅保留90天。本報告未經本公司書面許可，不可部份複製。

This document is issued by the Company subject to its General Conditions of Service printed overleaf, available on request or accessible at <http://www.sgs.com.tw/Terms-and-Conditions> and for electronic format documents, subject to Terms and Conditions for Electronic Documents at <http://www.sgs.com.tw/Terms-and-Conditions>. Attention is drawn to the limitation of liability, indemnification and jurisdiction issues defined therein. Any holder of this document is advised that information contained hereon reflects the Company's findings at the time of its intervention only and within the limits of Client's instructions, if any. The Company's sole responsibility is to its Client and this document does not exonerate parties to a transaction from exercising all their rights and obligations under the transaction documents. This document cannot be reproduced except in full, without prior written approval of the Company. Any unauthorized alteration, forgery or falsification of the content or appearance of this document is unlawful and offenders may be prosecuted to the fullest extent of the law.

Report Number :TERF2404000927E2  
 Operation Mode :802.11a  
 Test Frequency :5745 MHz  
 Test Mode :Tx  
 EUT Pol :E2 Plane

Test Site :SAC G Chamber  
 Test Date :2024-04-29  
 Temp./Humi. :20.6°C/62%  
 Antenna Pol. :Vertical  
 Engineer :Temo Chen

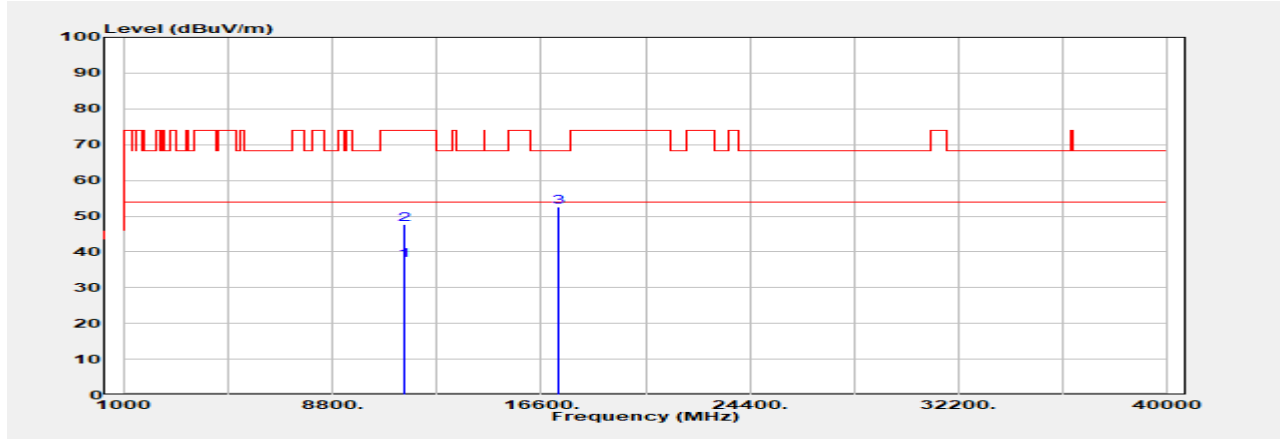

Freq. MHz	Detector Mode PK/QP/AVG	Spectrum Reading Level dBμV	Factor dB	Actual FS dBμV/m	Limit @3m dBμV/m	Margin dB
11490.000	Average	27.31	10.35	37.66	54.00	-16.34
11490.000	Peak	37.30	10.35	47.65	74.00	-26.35
17235.000	Peak	40.36	12.23	52.59	68.20	-15.61

Unless otherwise stated the results shown in this test report refer only to the sample(s) tested and such sample(s) are retained for 90 days only.

除非另有說明，此報告結果僅對測試之樣品負責，同時此樣品僅保留90天。本報告未經本公司書面許可，不可部份複製。

This document is issued by the Company subject to its General Conditions of Service printed overleaf, available on request or accessible at <http://www.sgs.com.tw/Terms-and-Conditions> and for electronic format documents, subject to Terms and Conditions for Electronic Documents at <http://www.sgs.com.tw/Terms-and-Conditions>. Attention is drawn to the limitation of liability, indemnification and jurisdiction issues defined therein. Any holder of this document is advised that information contained hereon reflects the Company's findings at the time of its intervention only and within the limits of Client's instructions, if any. The Company's sole responsibility is to its Client and this document does not exonerate parties to a transaction from exercising all their rights and obligations under the transaction documents. This document cannot be reproduced except in full, without prior written approval of the Company. Any unauthorized alteration, forgery or falsification of the content or appearance of this document is unlawful and offenders may be prosecuted to the fullest extent of the law.



Report Number :TERF2404000927E2  
 Operation Mode :802.11a  
 Test Frequency :5745 MHz  
 Test Mode :Tx  
 EUT Pol :E2 Plane

Test Site :SAC G Chamber  
 Test Date :2024-04-29  
 Temp./Humi. :20.6°C/62%  
 Antenna Pol. :Horizontal  
 Engineer :Temo Chen

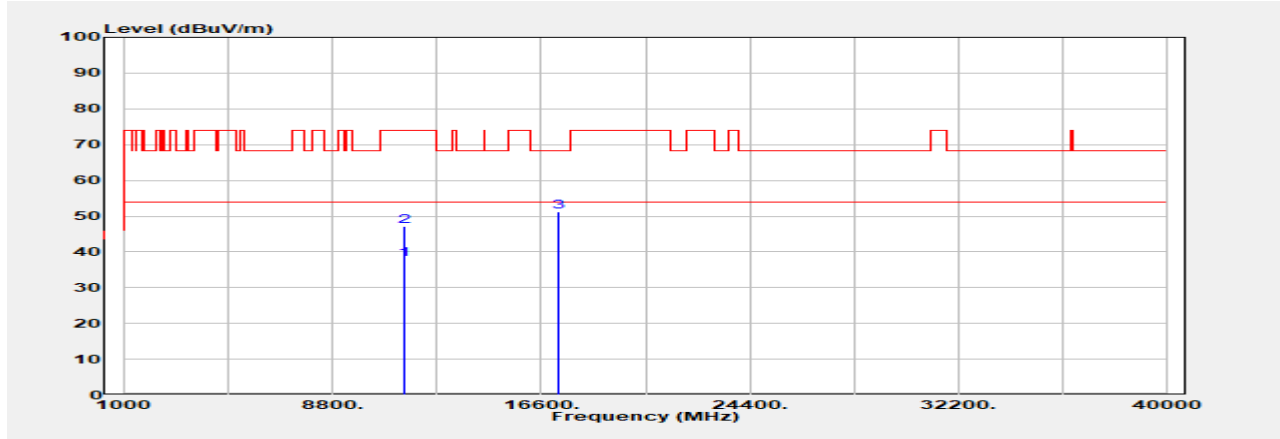

Freq. MHz	Detector Mode PK/QP/AVG	Spectrum Reading Level dB $\mu$ V	Factor dB	Actual FS dB $\mu$ V/m	Limit @3m dB $\mu$ V/m	Margin dB
11490.000	Average	27.72	10.35	38.07	54.00	-15.93
11490.000	Peak	36.91	10.35	47.26	74.00	-26.74
17235.000	Peak	39.07	12.23	51.30	68.20	-16.90

Unless otherwise stated the results shown in this test report refer only to the sample(s) tested and such sample(s) are retained for 90 days only.

除非另有說明，此報告結果僅對測試之樣品負責，同時此樣品僅保留90天。本報告未經本公司書面許可，不可部份複製。

This document is issued by the Company subject to its General Conditions of Service printed overleaf, available on request or accessible at <http://www.sgs.com.tw/Terms-and-Conditions> and for electronic format documents, subject to Terms and Conditions for Electronic Documents at <http://www.sgs.com.tw/Terms-and-Conditions>. Attention is drawn to the limitation of liability, indemnification and jurisdiction issues defined therein. Any holder of this document is advised that information contained hereon reflects the Company's findings at the time of its intervention only and within the limits of Client's instructions, if any. The Company's sole responsibility is to its Client and this document does not exonerate parties to a transaction from exercising all their rights and obligations under the transaction documents. This document cannot be reproduced except in full, without prior written approval of the Company. Any unauthorized alteration, forgery or falsification of the content or appearance of this document is unlawful and offenders may be prosecuted to the fullest extent of the law.

Report Number	:TERF2404000927E2	Test Site	:SAC G Chamber
Operation Mode	:802.11a	Test Date	:2024-04-29
Test Frequency	:5825 MHz	Temp./Humi.	:20.6°C/62%
Test Mode	:Tx	Antenna Pol.	:Vertical
EUT Pol	:E2 Plane	Engineer	:Temo Chen

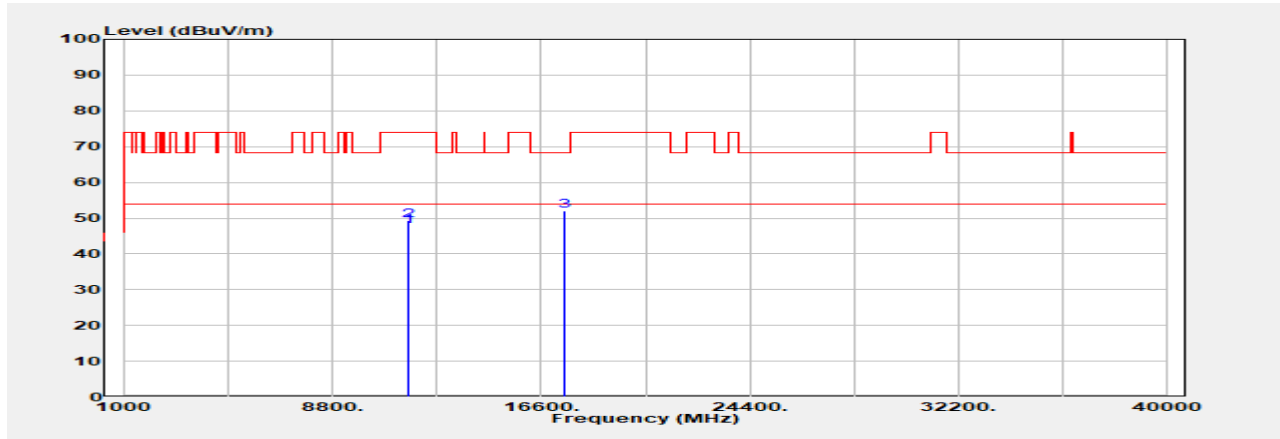

Freq. MHz	Detector Mode PK/QP/AVG	Spectrum Reading Level dBμV	Factor dB	Actual FS dBμV/m	Limit @3m dBμV/m	Margin dB
11650.000	Average	37.15	10.64	47.79	54.00	-6.21
11650.000	Peak	38.76	10.64	49.40	74.00	-24.60
17475.000	Peak	39.56	12.54	52.10	68.20	-16.10

Unless otherwise stated the results shown in this test report refer only to the sample(s) tested and such sample(s) are retained for 90 days only.

除非另有說明，此報告結果僅對測試之樣品負責，同時此樣品僅保留90天。本報告未經本公司書面許可，不可部份複製。

This document is issued by the Company subject to its General Conditions of Service printed overleaf, available on request or accessible at <http://www.sgs.com.tw/Terms-and-Conditions> and for electronic format documents, subject to Terms and Conditions for Electronic Documents at <http://www.sgs.com.tw/Terms-and-Conditions>. Attention is drawn to the limitation of liability, indemnification and jurisdiction issues defined therein. Any holder of this document is advised that information contained hereon reflects the Company's findings at the time of its intervention only and within the limits of Client's instructions, if any. The Company's sole responsibility is to its Client and this document does not exonerate parties to a transaction from exercising all their rights and obligations under the transaction documents. This document cannot be reproduced except in full, without prior written approval of the Company. Any unauthorized alteration, forgery or falsification of the content or appearance of this document is unlawful and offenders may be prosecuted to the fullest extent of the law.

Report Number :TERF2404000927E2	Test Site :SAC G Chamber
Operation Mode :802.11a	Test Date :2024-04-29
Test Frequency :5825 MHz	Temp./Humi. :20.6°C/62%
Test Mode :Tx	Antenna Pol. :Horizontal
EUT Pol :E2 Plane	Engineer :Temo Chen

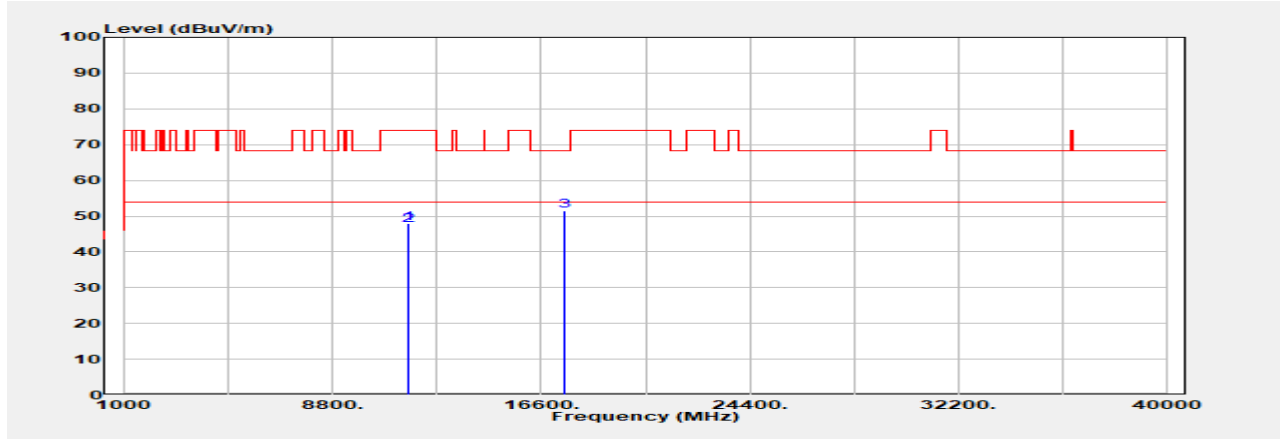

Freq. MHz	Detector Mode PK/QP/AVG	Spectrum Reading Level dB $\mu$ V	Factor dB	Actual FS dB $\mu$ V/m	Limit @3m dB $\mu$ V/m	Margin dB
11650.000	Average	37.45	10.64	48.09	54.00	-5.91
11650.000	Peak	36.83	10.64	47.48	74.00	-26.52
17475.000	Peak	39.03	12.54	51.57	68.20	-16.63

Unless otherwise stated the results shown in this test report refer only to the sample(s) tested and such sample(s) are retained for 90 days only.

除非另有說明，此報告結果僅對測試之樣品負責，同時此樣品僅保留90天。本報告未經本公司書面許可，不可部份複製。

This document is issued by the Company subject to its General Conditions of Service printed overleaf, available on request or accessible at <http://www.sgs.com.tw/Terms-and-Conditions> and for electronic format documents, subject to Terms and Conditions for Electronic Documents at <http://www.sgs.com.tw/Terms-and-Conditions>. Attention is drawn to the limitation of liability, indemnification and jurisdiction issues defined therein. Any holder of this document is advised that information contained hereon reflects the Company's findings at the time of its intervention only and within the limits of Client's instructions, if any. The Company's sole responsibility is to its Client and this document does not exonerate parties to a transaction from exercising all their rights and obligations under the transaction documents. This document cannot be reproduced except in full, without prior written approval of the Company. Any unauthorized alteration, forgery or falsification of the content or appearance of this document is unlawful and offenders may be prosecuted to the fullest extent of the law.

Report Number :TERF2404000927E2  
 Operation Mode :802.11n20  
 Test Frequency :5180 MHz  
 Test Mode :Tx  
 EUT Pol :E2 Plane

Test Site :SAC G Chamber  
 Test Date :2024-04-29  
 Temp./Humi. :20.6°C/62%  
 Antenna Pol. :Vertical  
 Engineer :Temo Chen

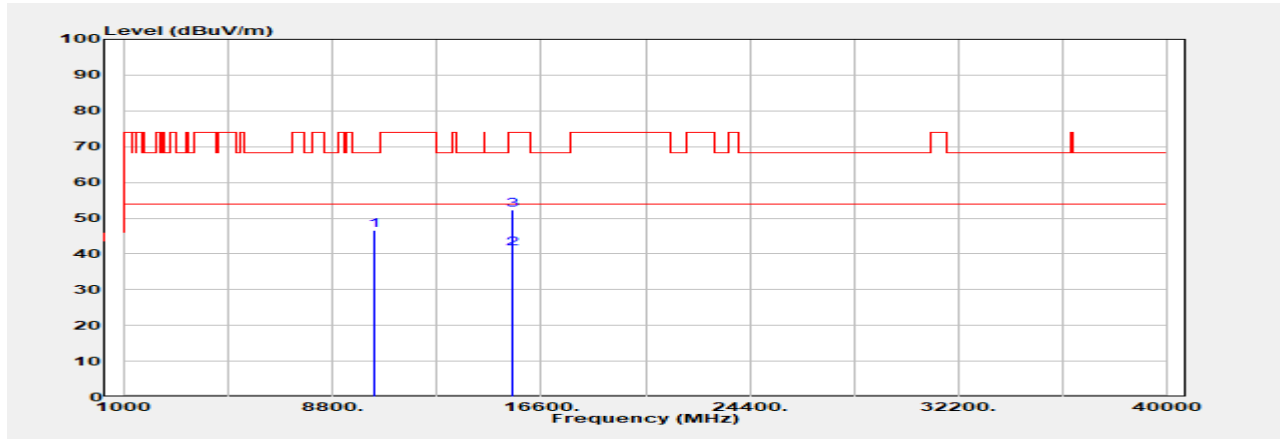

Freq. MHz	Detector Mode PK/QP/AVG	Spectrum Reading Level dB $\mu$ V	Factor dB	Actual FS dB $\mu$ V/m	Limit @3m dB $\mu$ V/m	Margin dB
10360.000	Peak	36.86	9.70	46.56	68.20	-21.64
15540.000	Average	29.24	12.28	41.52	54.00	-12.48
15540.000	Peak	39.93	12.28	52.21	74.00	-21.79

Unless otherwise stated the results shown in this test report refer only to the sample(s) tested and such sample(s) are retained for 90 days only.

除非另有說明，此報告結果僅對測試之樣品負責，同時此樣品僅保留90天。本報告未經本公司書面許可，不可部份複製。

This document is issued by the Company subject to its General Conditions of Service printed overleaf, available on request or accessible at <http://www.sgs.com.tw/Terms-and-Conditions> and for electronic format documents, subject to Terms and Conditions for Electronic Documents at <http://www.sgs.com.tw/Terms-and-Conditions>. Attention is drawn to the limitation of liability, indemnification and jurisdiction issues defined therein. Any holder of this document is advised that information contained hereon reflects the Company's findings at the time of its intervention only and within the limits of Client's instructions, if any. The Company's sole responsibility is to its Client and this document does not exonerate parties to a transaction from exercising all their rights and obligations under the transaction documents. This document cannot be reproduced except in full, without prior written approval of the Company. Any unauthorized alteration, forgery or falsification of the content or appearance of this document is unlawful and offenders may be prosecuted to the fullest extent of the law.

Report Number :TERF2404000927E2  
 Operation Mode :802.11n20  
 Test Frequency :5180 MHz  
 Test Mode :Tx  
 EUT Pol :E2 Plane

Test Site :SAC G Chamber  
 Test Date :2024-04-29  
 Temp./Humi. :20.6°C/62%  
 Antenna Pol. :Horizontal  
 Engineer :Temo Chen

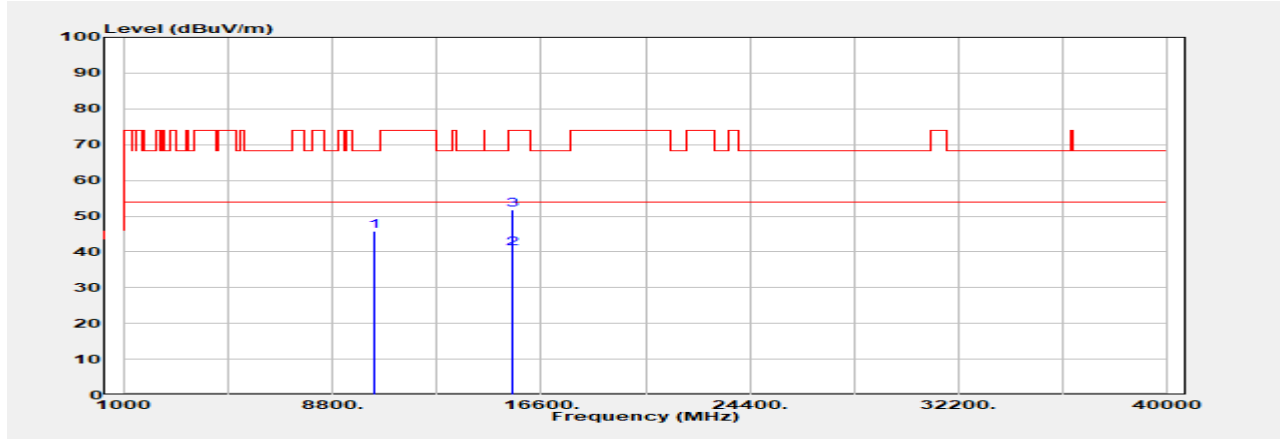

Freq. MHz	Detector Mode PK/QP/AVG	Spectrum Reading Level dB $\mu$ V	Factor dB	Actual FS dB $\mu$ V/m	Limit @3m dB $\mu$ V/m	Margin dB
10360.000	Peak	36.15	9.70	45.85	68.20	-22.35
15540.000	Average	28.70	12.28	40.98	54.00	-13.02
15540.000	Peak	39.44	12.28	51.72	74.00	-22.28

Unless otherwise stated the results shown in this test report refer only to the sample(s) tested and such sample(s) are retained for 90 days only.

除非另有說明，此報告結果僅對測試之樣品負責，同時此樣品僅保留90天。本報告未經本公司書面許可，不可部份複製。

This document is issued by the Company subject to its General Conditions of Service printed overleaf, available on request or accessible at <http://www.sgs.com.tw/Terms-and-Conditions> and for electronic format documents, subject to Terms and Conditions for Electronic Documents at <http://www.sgs.com.tw/Terms-and-Conditions>. Attention is drawn to the limitation of liability, indemnification and jurisdiction issues defined therein. Any holder of this document is advised that information contained hereon reflects the Company's findings at the time of its intervention only and within the limits of Client's instructions, if any. The Company's sole responsibility is to its Client and this document does not exonerate parties to a transaction from exercising all their rights and obligations under the transaction documents. This document cannot be reproduced except in full, without prior written approval of the Company. Any unauthorized alteration, forgery or falsification of the content or appearance of this document is unlawful and offenders may be prosecuted to the fullest extent of the law.

Report Number :TERF2404000927E2  
 Operation Mode :802.11n20  
 Test Frequency :5220 MHz  
 Test Mode :Tx  
 EUT Pol :E2 Plane

Test Site :SAC G Chamber  
 Test Date :2024-04-29  
 Temp./Humi. :20.6°C/62%  
 Antenna Pol. :Vertical  
 Engineer :Temo Chen

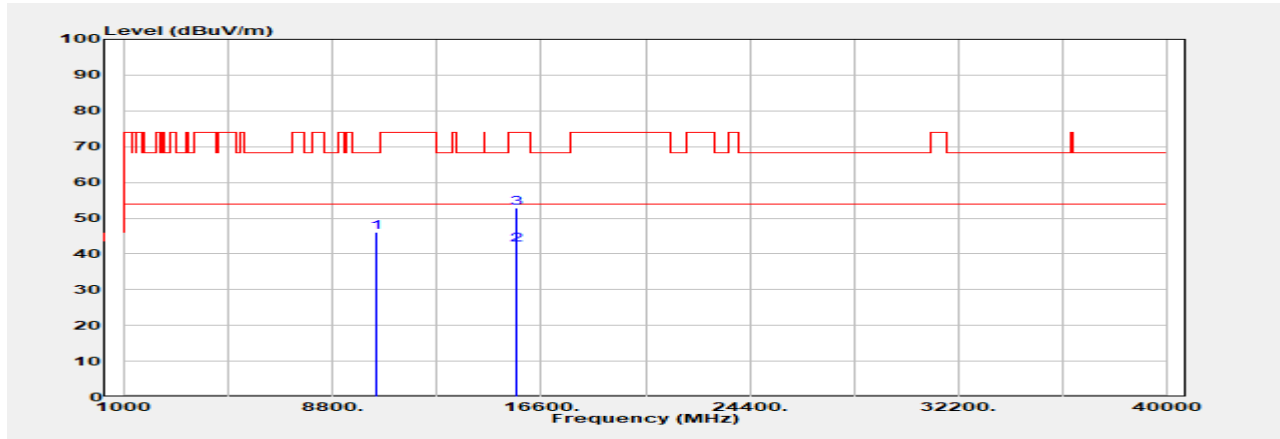

Freq. MHz	Detector Mode PK/QP/AVG	Spectrum Reading Level dB $\mu$ V	Factor dB	Actual FS dB $\mu$ V/m	Limit @3m dB $\mu$ V/m	Margin dB
10440.000	Peak	36.42	9.68	46.10	68.20	-22.10
15660.000	Average	29.62	13.00	42.62	54.00	-11.38
15660.000	Peak	39.92	13.00	52.92	74.00	-21.08

Unless otherwise stated the results shown in this test report refer only to the sample(s) tested and such sample(s) are retained for 90 days only.

除非另有說明，此報告結果僅對測試之樣品負責，同時此樣品僅保留90天。本報告未經本公司書面許可，不可部份複製。

This document is issued by the Company subject to its General Conditions of Service printed overleaf, available on request or accessible at <http://www.sgs.com.tw/Terms-and-Conditions> and for electronic format documents, subject to Terms and Conditions for Electronic Documents at <http://www.sgs.com.tw/Terms-and-Conditions>. Attention is drawn to the limitation of liability, indemnification and jurisdiction issues defined therein. Any holder of this document is advised that information contained hereon reflects the Company's findings at the time of its intervention only and within the limits of Client's instructions, if any. The Company's sole responsibility is to its Client and this document does not exonerate parties to a transaction from exercising all their rights and obligations under the transaction documents. This document cannot be reproduced except in full, without prior written approval of the Company. Any unauthorized alteration, forgery or falsification of the content or appearance of this document is unlawful and offenders may be prosecuted to the fullest extent of the law.

Report Number :TERF2404000927E2  
 Operation Mode :802.11n20  
 Test Frequency :5220 MHz  
 Test Mode :Tx  
 EUT Pol :E2 Plane

Test Site :SAC G Chamber  
 Test Date :2024-04-29  
 Temp./Humi. :20.6°C/62%  
 Antenna Pol. :Horizontal  
 Engineer :Temo Chen

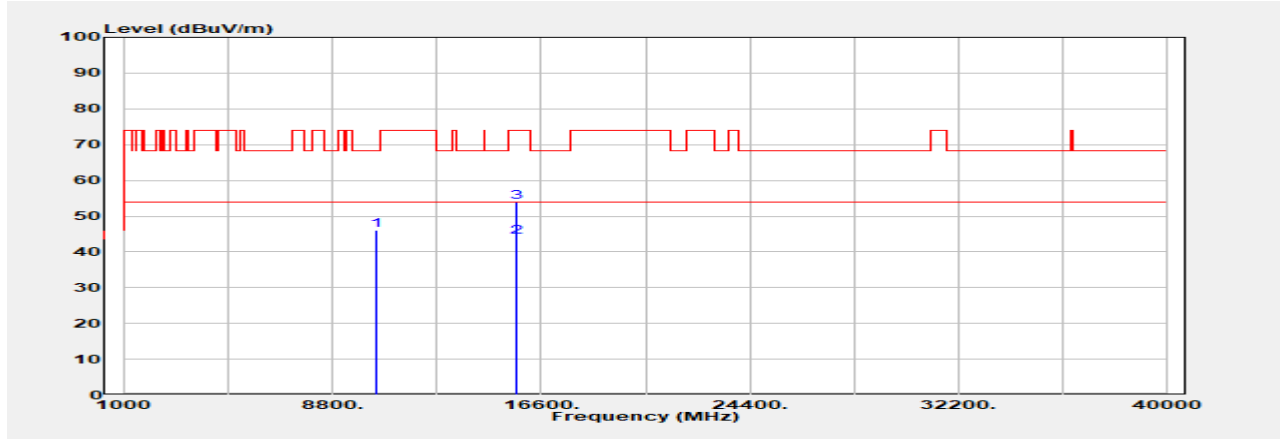

Freq. MHz	Detector Mode PK/QP/AVG	Spectrum Reading Level dB $\mu$ V	Factor dB	Actual FS dB $\mu$ V/m	Limit @3m dB $\mu$ V/m	Margin dB
10440.000	Peak	36.48	9.68	46.16	68.20	-22.04
15660.000	Average	31.22	13.00	44.22	54.00	-9.78
15660.000	Peak	40.90	13.00	53.90	74.00	-20.10

Unless otherwise stated the results shown in this test report refer only to the sample(s) tested and such sample(s) are retained for 90 days only.

除非另有說明，此報告結果僅對測試之樣品負責，同時此樣品僅保留90天。本報告未經本公司書面許可，不可部份複製。

This document is issued by the Company subject to its General Conditions of Service printed overleaf, available on request or accessible at <http://www.sgs.com.tw/Terms-and-Conditions> and for electronic format documents, subject to Terms and Conditions for Electronic Documents at <http://www.sgs.com.tw/Terms-and-Conditions>. Attention is drawn to the limitation of liability, indemnification and jurisdiction issues defined therein. Any holder of this document is advised that information contained hereon reflects the Company's findings at the time of its intervention only and within the limits of Client's instructions, if any. The Company's sole responsibility is to its Client and this document does not exonerate parties to a transaction from exercising all their rights and obligations under the transaction documents. This document cannot be reproduced except in full, without prior written approval of the Company. Any unauthorized alteration, forgery or falsification of the content or appearance of this document is unlawful and offenders may be prosecuted to the fullest extent of the law.

Report Number :TERF2404000927E2  
 Operation Mode :802.11n20  
 Test Frequency :5240 MHz  
 Test Mode :Tx  
 EUT Pol :E2 Plane

Test Site :SAC G Chamber  
 Test Date :2024-04-29  
 Temp./Humi. :20.6°C/62%  
 Antenna Pol. :Vertical  
 Engineer :Temo Chen

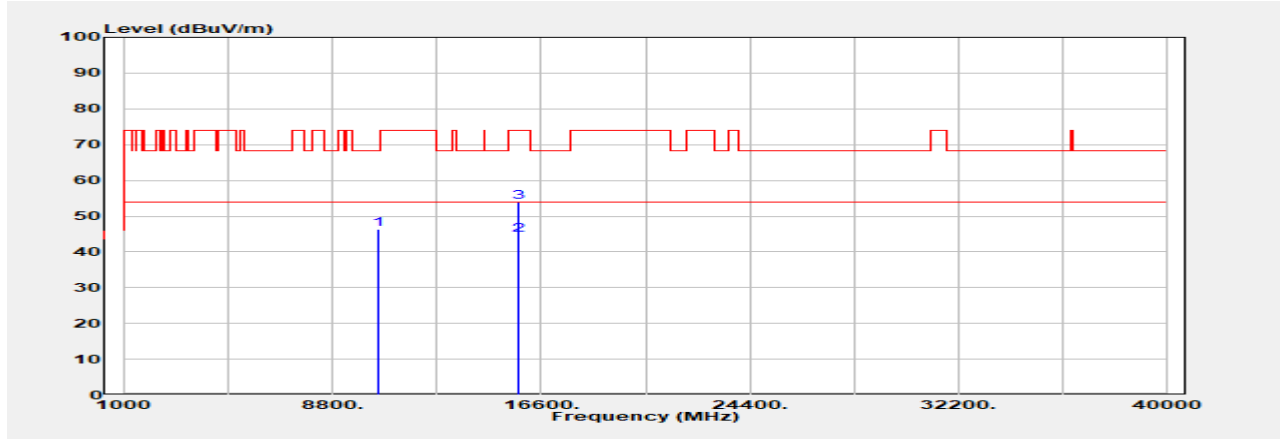

Freq. MHz	Detector Mode PK/QP/AVG	Spectrum Reading Level dB $\mu$ V	Factor dB	Actual FS dB $\mu$ V/m	Limit @3m dB $\mu$ V/m	Margin dB
10480.000	Peak	37.15	9.31	46.46	68.20	-21.74
15720.000	Average	31.31	13.49	44.80	54.00	-9.20
15720.000	Peak	40.35	13.49	53.84	74.00	-20.16

Unless otherwise stated the results shown in this test report refer only to the sample(s) tested and such sample(s) are retained for 90 days only.

除非另有說明，此報告結果僅對測試之樣品負責，同時此樣品僅保留90天。本報告未經本公司書面許可，不可部份複製。

This document is issued by the Company subject to its General Conditions of Service printed overleaf, available on request or accessible at <http://www.sgs.com.tw/Terms-and-Conditions> and for electronic format documents, subject to Terms and Conditions for Electronic Documents at <http://www.sgs.com.tw/Terms-and-Conditions>. Attention is drawn to the limitation of liability, indemnification and jurisdiction issues defined therein. Any holder of this document is advised that information contained hereon reflects the Company's findings at the time of its intervention only and within the limits of Client's instructions, if any. The Company's sole responsibility is to its Client and this document does not exonerate parties to a transaction from exercising all their rights and obligations under the transaction documents. This document cannot be reproduced except in full, without prior written approval of the Company. Any unauthorized alteration, forgery or falsification of the content or appearance of this document is unlawful and offenders may be prosecuted to the fullest extent of the law.



Report Number :TERF2404000927E2  
 Operation Mode :802.11n20  
 Test Frequency :5240 MHz  
 Test Mode :Tx  
 EUT Pol :E2 Plane

Test Site :SAC G Chamber  
 Test Date :2024-04-29  
 Temp./Humi. :20.6°C/62%  
 Antenna Pol. :Horizontal  
 Engineer :Temo Chen

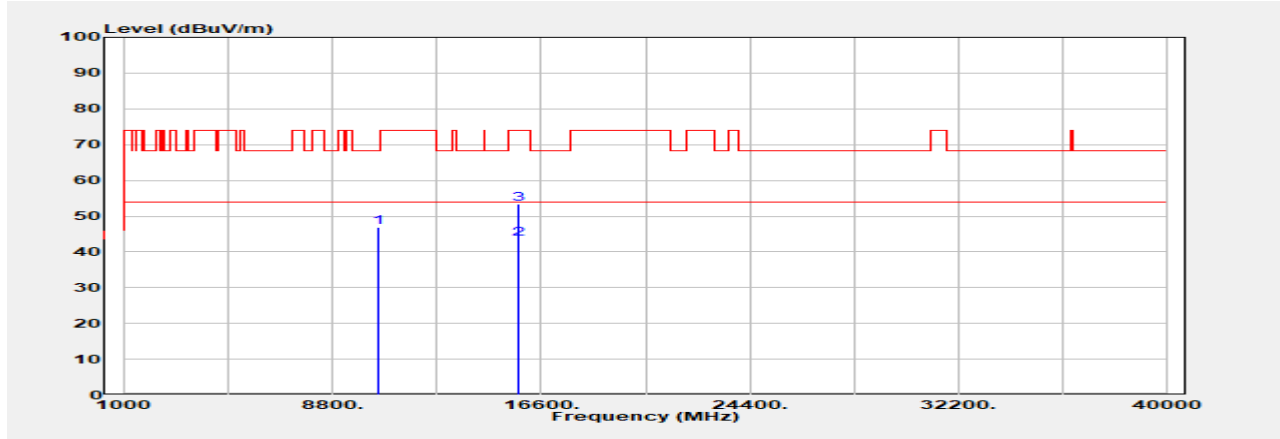

Freq. MHz	Detector Mode PK/QP/AVG	Spectrum Reading Level dB $\mu$ V	Factor dB	Actual FS dB $\mu$ V/m	Limit @3m dB $\mu$ V/m	Margin dB
10480.000	Peak	37.58	9.31	46.89	68.20	-21.31
15720.000	Average	30.21	13.49	43.70	54.00	-10.30
15720.000	Peak	39.94	13.49	53.43	74.00	-20.57

Unless otherwise stated the results shown in this test report refer only to the sample(s) tested and such sample(s) are retained for 90 days only.

除非另有說明，此報告結果僅對測試之樣品負責，同時此樣品僅保留90天。本報告未經本公司書面許可，不可部份複製。

This document is issued by the Company subject to its General Conditions of Service printed overleaf, available on request or accessible at <http://www.sgs.com.tw/Terms-and-Conditions> and for electronic format documents, subject to Terms and Conditions for Electronic Documents at <http://www.sgs.com.tw/Terms-and-Conditions>. Attention is drawn to the limitation of liability, indemnification and jurisdiction issues defined therein. Any holder of this document is advised that information contained hereon reflects the Company's findings at the time of its intervention only and within the limits of Client's instructions, if any. The Company's sole responsibility is to its Client and this document does not exonerate parties to a transaction from exercising all their rights and obligations under the transaction documents. This document cannot be reproduced except in full, without prior written approval of the Company. Any unauthorized alteration, forgery or falsification of the content or appearance of this document is unlawful and offenders may be prosecuted to the fullest extent of the law.

Report Number :TERF2404000927E2  
 Operation Mode :802.11n20  
 Test Frequency :5260 MHz  
 Test Mode :Tx  
 EUT Pol :E2 Plane

Test Site :SAC G Chamber  
 Test Date :2024-04-29  
 Temp./Humi. :20.6°C/62%  
 Antenna Pol. :Vertical  
 Engineer :Temo Chen

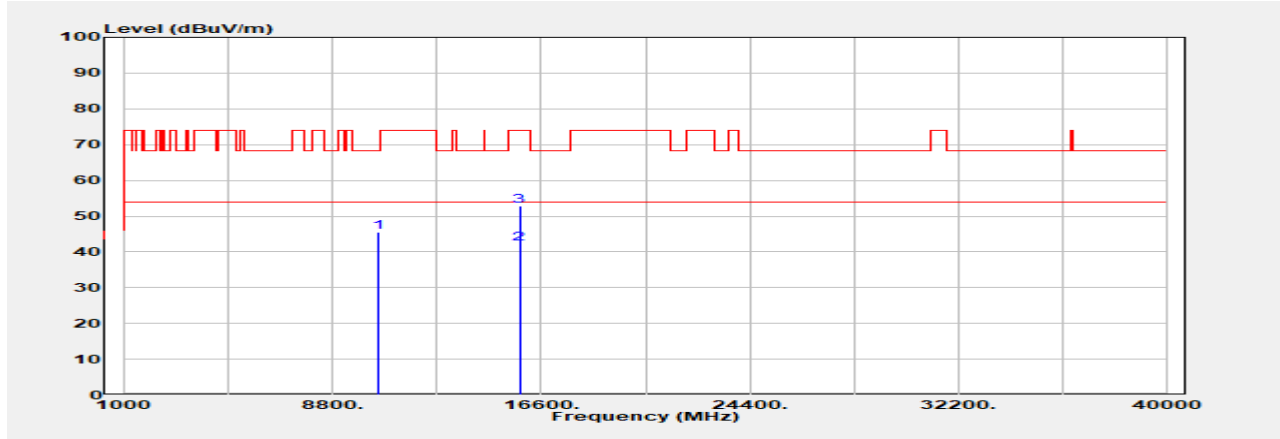

Freq. MHz	Detector Mode PK/QP/AVG	Spectrum Reading Level dB $\mu$ V	Factor dB	Actual FS dB $\mu$ V/m	Limit @3m dB $\mu$ V/m	Margin dB
10520.000	Peak	36.16	9.25	45.42	68.20	-22.78
15780.000	Average	29.15	13.08	42.23	54.00	-11.77
15780.000	Peak	39.71	13.08	52.79	74.00	-21.21

Unless otherwise stated the results shown in this test report refer only to the sample(s) tested and such sample(s) are retained for 90 days only.

除非另有說明，此報告結果僅對測試之樣品負責，同時此樣品僅保留90天。本報告未經本公司書面許可，不可部份複製。

This document is issued by the Company subject to its General Conditions of Service printed overleaf, available on request or accessible at <http://www.sgs.com.tw/Terms-and-Conditions> and for electronic format documents, subject to Terms and Conditions for Electronic Documents at <http://www.sgs.com.tw/Terms-and-Conditions>. Attention is drawn to the limitation of liability, indemnification and jurisdiction issues defined therein. Any holder of this document is advised that information contained hereon reflects the Company's findings at the time of its intervention only and within the limits of Client's instructions, if any. The Company's sole responsibility is to its Client and this document does not exonerate parties to a transaction from exercising all their rights and obligations under the transaction documents. This document cannot be reproduced except in full, without prior written approval of the Company. Any unauthorized alteration, forgery or falsification of the content or appearance of this document is unlawful and offenders may be prosecuted to the fullest extent of the law.

Report Number :TERF2404000927E2  
 Operation Mode :802.11n20  
 Test Frequency :5260 MHz  
 Test Mode :Tx  
 EUT Pol :E2 Plane

Test Site :SAC G Chamber  
 Test Date :2024-04-29  
 Temp./Humi. :20.6°C/62%  
 Antenna Pol. :Horizontal  
 Engineer :Temo Chen

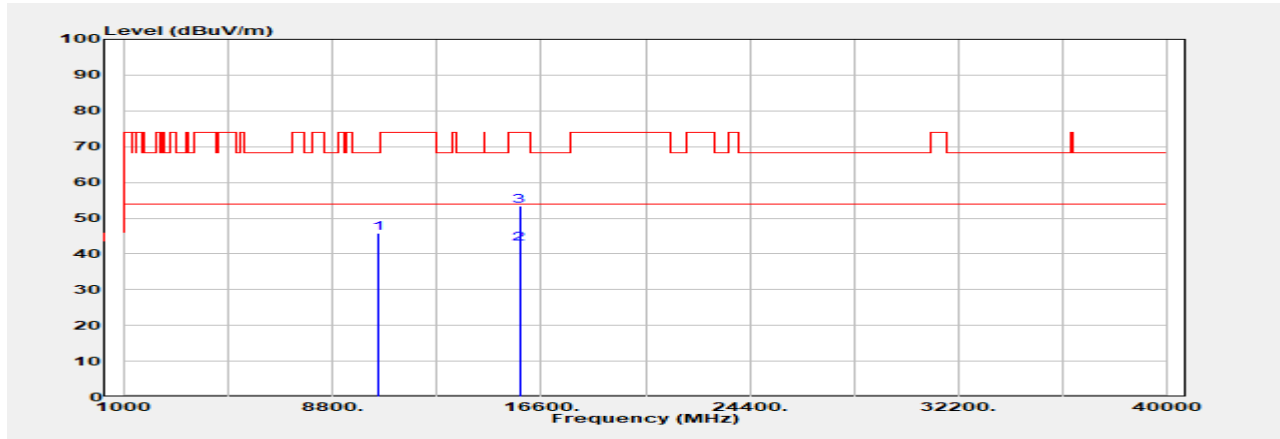

Freq. MHz	Detector Mode PK/QP/AVG	Spectrum Reading Level dB $\mu$ V	Factor dB	Actual FS dB $\mu$ V/m	Limit @3m dB $\mu$ V/m	Margin dB
10520.000	Peak	36.59	9.25	45.84	68.20	-22.36
15780.000	Average	29.64	13.08	42.72	54.00	-11.28
15780.000	Peak	40.44	13.08	53.52	74.00	-20.48

Unless otherwise stated the results shown in this test report refer only to the sample(s) tested and such sample(s) are retained for 90 days only.

除非另有說明，此報告結果僅對測試之樣品負責，同時此樣品僅保留90天。本報告未經本公司書面許可，不可部份複製。

This document is issued by the Company subject to its General Conditions of Service printed overleaf, available on request or accessible at <http://www.sgs.com.tw/Terms-and-Conditions> and for electronic format documents, subject to Terms and Conditions for Electronic Documents at <http://www.sgs.com.tw/Terms-and-Conditions>. Attention is drawn to the limitation of liability, indemnification and jurisdiction issues defined therein. Any holder of this document is advised that information contained hereon reflects the Company's findings at the time of its intervention only and within the limits of Client's instructions, if any. The Company's sole responsibility is to its Client and this document does not exonerate parties to a transaction from exercising all their rights and obligations under the transaction documents. This document cannot be reproduced except in full, without prior written approval of the Company. Any unauthorized alteration, forgery or falsification of the content or appearance of this document is unlawful and offenders may be prosecuted to the fullest extent of the law.

Report Number :TERF2404000927E2  
 Operation Mode :802.11n20  
 Test Frequency :5300 MHz  
 Test Mode :Tx  
 EUT Pol :E2 Plane

Test Site :SAC G Chamber  
 Test Date :2024-04-29  
 Temp./Humi. :20.6°C/62%  
 Antenna Pol. :Vertical  
 Engineer :Temo Chen

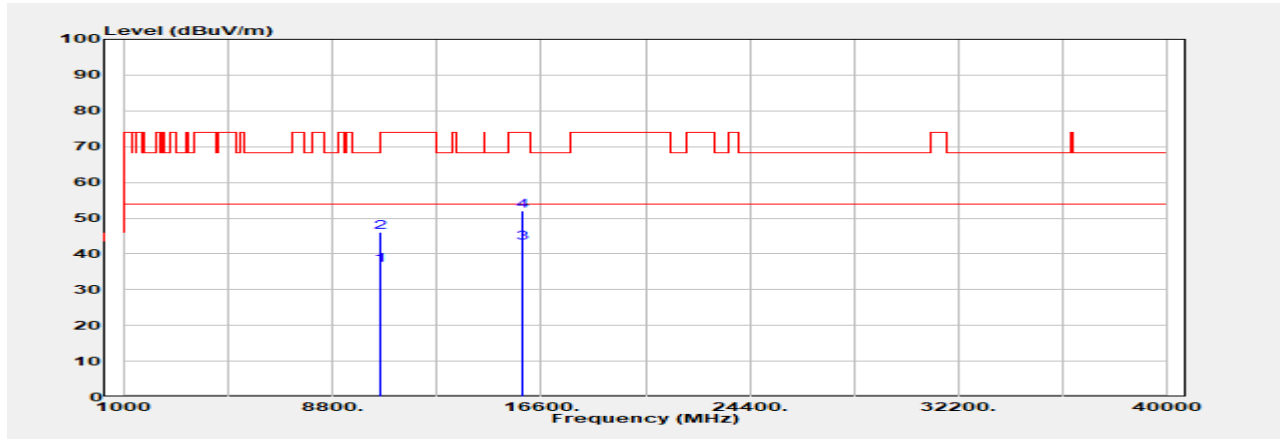

Freq. MHz	Detector Mode PK/QP/AVG	Spectrum Reading Level dB $\mu$ V	Factor dB	Actual FS dB $\mu$ V/m	Limit @3m dB $\mu$ V/m	Margin dB
10600.000	Average	27.10	9.74	36.84	54.00	-17.16
10600.000	Peak	36.46	9.74	46.20	74.00	-27.80
15900.000	Average	30.15	12.95	43.10	54.00	-10.90
15900.000	Peak	39.02	12.95	51.97	74.00	-22.03

Unless otherwise stated the results shown in this test report refer only to the sample(s) tested and such sample(s) are retained for 90 days only.

除非另有說明，此報告結果僅對測試之樣品負責，同時此樣品僅保留90天。本報告未經本公司書面許可，不可部份複製。

This document is issued by the Company subject to its General Conditions of Service printed overleaf, available on request or accessible at <http://www.sgs.com.tw/Terms-and-Conditions> and for electronic format documents, subject to Terms and Conditions for Electronic Documents at <http://www.sgs.com.tw/Terms-and-Conditions>. Attention is drawn to the limitation of liability, indemnification and jurisdiction issues defined therein. Any holder of this document is advised that information contained hereon reflects the Company's findings at the time of its intervention only and within the limits of Client's instructions, if any. The Company's sole responsibility is to its Client and this document does not exonerate parties to a transaction from exercising all their rights and obligations under the transaction documents. This document cannot be reproduced except in full, without prior written approval of the Company. Any unauthorized alteration, forgery or falsification of the content or appearance of this document is unlawful and offenders may be prosecuted to the fullest extent of the law.

Report Number :TERF2404000927E2  
 Operation Mode :802.11n20  
 Test Frequency :5300 MHz  
 Test Mode :Tx  
 EUT Pol :E2 Plane

Test Site :SAC G Chamber  
 Test Date :2024-04-29  
 Temp./Humi. :20.6°C/62%  
 Antenna Pol. :Horizontal  
 Engineer :Temo Chen

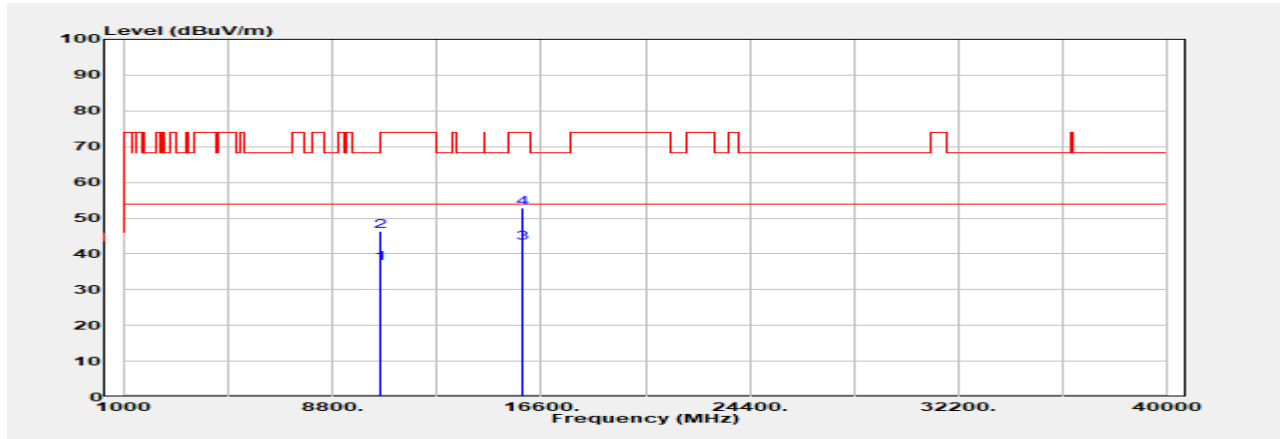

Freq. MHz	Detector Mode PK/QP/AVG	Spectrum Reading Level dB $\mu$ V	Factor dB	Actual FS dB $\mu$ V/m	Limit @3m dB $\mu$ V/m	Margin dB
10600.000	Average	27.71	9.74	37.45	54.00	-16.55
10600.000	Peak	36.50	9.74	46.24	74.00	-27.76
15900.000	Average	30.25	12.95	43.20	54.00	-10.80
15900.000	Peak	39.82	12.95	52.77	74.00	-21.23

Unless otherwise stated the results shown in this test report refer only to the sample(s) tested and such sample(s) are retained for 90 days only.

除非另有說明，此報告結果僅對測試之樣品負責，同時此樣品僅保留90天。本報告未經本公司書面許可，不可部份複製。

This document is issued by the Company subject to its General Conditions of Service printed overleaf, available on request or accessible at <http://www.sgs.com.tw/Terms-and-Conditions> and for electronic format documents, subject to Terms and Conditions for Electronic Documents at <http://www.sgs.com.tw/Terms-and-Conditions>. Attention is drawn to the limitation of liability, indemnification and jurisdiction issues defined therein. Any holder of this document is advised that information contained hereon reflects the Company's findings at the time of its intervention only and within the limits of Client's instructions, if any. The Company's sole responsibility is to its Client and this document does not exonerate parties to a transaction from exercising all their rights and obligations under the transaction documents. This document cannot be reproduced except in full, without prior written approval of the Company. Any unauthorized alteration, forgery or falsification of the content or appearance of this document is unlawful and offenders may be prosecuted to the fullest extent of the law.

Report Number :TERF2404000927E2  
 Operation Mode :802.11n20  
 Test Frequency :5320 MHz  
 Test Mode :Tx  
 EUT Pol :E2 Plane

Test Site :SAC G Chamber  
 Test Date :2024-04-29  
 Temp./Humi. :20.6°C/62%  
 Antenna Pol. :Vertical  
 Engineer :Temo Chen

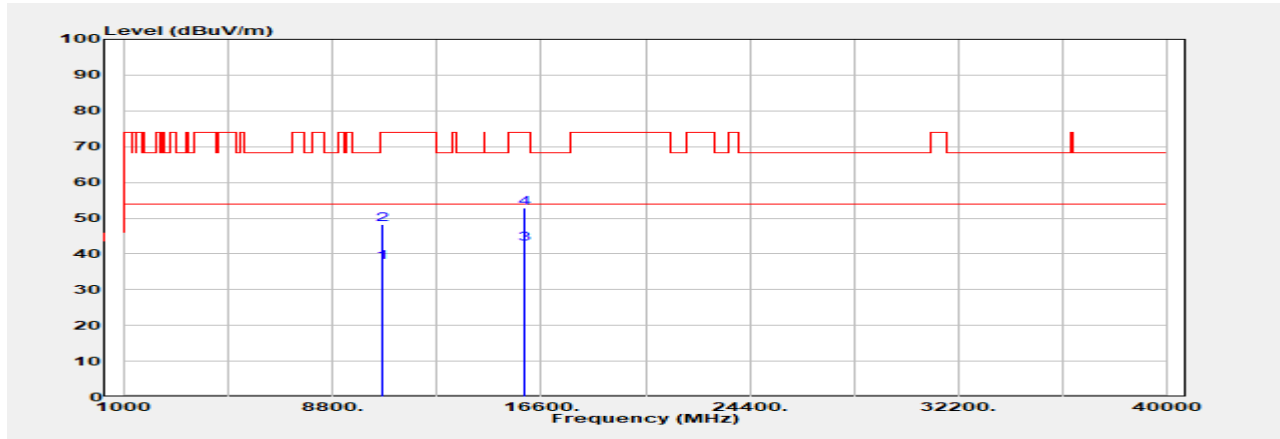

Freq. MHz	Detector Mode PK/QP/AVG	Spectrum Reading Level dB $\mu$ V	Factor dB	Actual FS dB $\mu$ V/m	Limit @3m dB $\mu$ V/m	Margin dB
10640.000	Average	28.03	9.74	37.76	54.00	-16.24
10640.000	Peak	38.54	9.74	48.27	74.00	-25.73
15960.000	Average	30.34	12.50	42.84	54.00	-11.16
15960.000	Peak	40.42	12.50	52.92	74.00	-21.08

Unless otherwise stated the results shown in this test report refer only to the sample(s) tested and such sample(s) are retained for 90 days only.

除非另有說明，此報告結果僅對測試之樣品負責，同時此樣品僅保留90天。本報告未經本公司書面許可，不可部份複製。

This document is issued by the Company subject to its General Conditions of Service printed overleaf, available on request or accessible at <http://www.sgs.com.tw/Terms-and-Conditions> and for electronic format documents, subject to Terms and Conditions for Electronic Documents at <http://www.sgs.com.tw/Terms-and-Conditions>. Attention is drawn to the limitation of liability, indemnification and jurisdiction issues defined therein. Any holder of this document is advised that information contained hereon reflects the Company's findings at the time of its intervention only and within the limits of Client's instructions, if any. The Company's sole responsibility is to its Client and this document does not exonerate parties to a transaction from exercising all their rights and obligations under the transaction documents. This document cannot be reproduced except in full, without prior written approval of the Company. Any unauthorized alteration, forgery or falsification of the content or appearance of this document is unlawful and offenders may be prosecuted to the fullest extent of the law.

Report Number :TERF2404000927E2  
 Operation Mode :802.11n20  
 Test Frequency :5320 MHz  
 Test Mode :Tx  
 EUT Pol :E2 Plane

Test Site :SAC G Chamber  
 Test Date :2024-04-29  
 Temp./Humi. :20.6°C/62%  
 Antenna Pol. :Horizontal  
 Engineer :Temo Chen

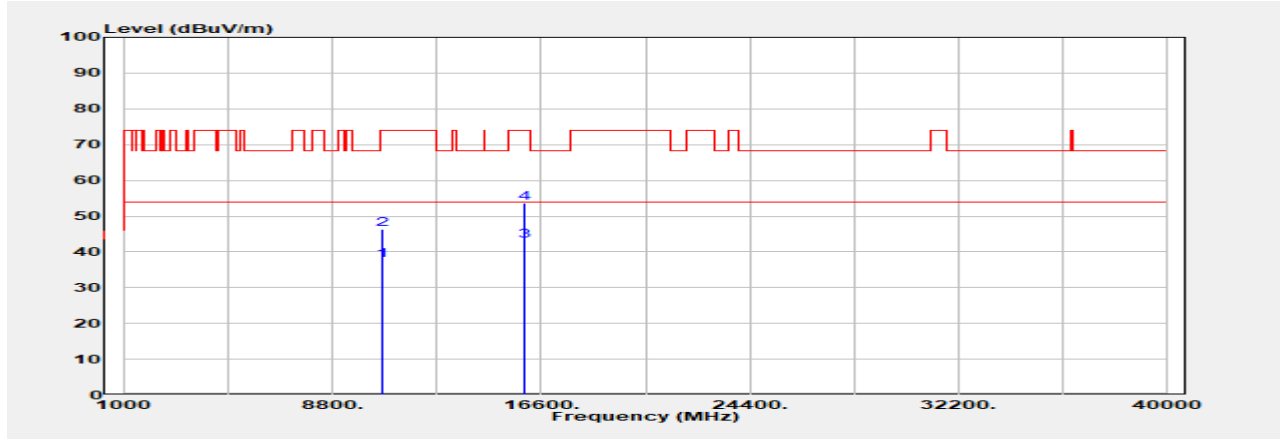

Freq. MHz	Detector Mode PK/QP/AVG	Spectrum Reading Level dB $\mu$ V	Factor dB	Actual FS dB $\mu$ V/m	Limit @3m dB $\mu$ V/m	Margin dB
10640.000	Average	27.89	9.74	37.63	54.00	-16.37
10640.000	Peak	36.49	9.74	46.23	74.00	-27.77
15960.000	Average	30.46	12.50	42.96	54.00	-11.04
15960.000	Peak	41.14	12.50	53.64	74.00	-20.36

Unless otherwise stated the results shown in this test report refer only to the sample(s) tested and such sample(s) are retained for 90 days only.

除非另有說明，此報告結果僅對測試之樣品負責，同時此樣品僅保留90天。本報告未經本公司書面許可，不可部份複製。

This document is issued by the Company subject to its General Conditions of Service printed overleaf, available on request or accessible at <http://www.sgs.com.tw/Terms-and-Conditions> and for electronic format documents, subject to Terms and Conditions for Electronic Documents at <http://www.sgs.com.tw/Terms-and-Conditions>. Attention is drawn to the limitation of liability, indemnification and jurisdiction issues defined therein. Any holder of this document is advised that information contained hereon reflects the Company's findings at the time of its intervention only and within the limits of Client's instructions, if any. The Company's sole responsibility is to its Client and this document does not exonerate parties to a transaction from exercising all their rights and obligations under the transaction documents. This document cannot be reproduced except in full, without prior written approval of the Company. Any unauthorized alteration, forgery or falsification of the content or appearance of this document is unlawful and offenders may be prosecuted to the fullest extent of the law.

Report Number :TERF2404000927E2  
 Operation Mode :802.11n20  
 Test Frequency :5500 MHz  
 Test Mode :Tx  
 EUT Pol :E2 Plane

Test Site :SAC G Chamber  
 Test Date :2024-04-29  
 Temp./Humi. :20.6°C/62%  
 Antenna Pol. :Vertical  
 Engineer :Temo Chen

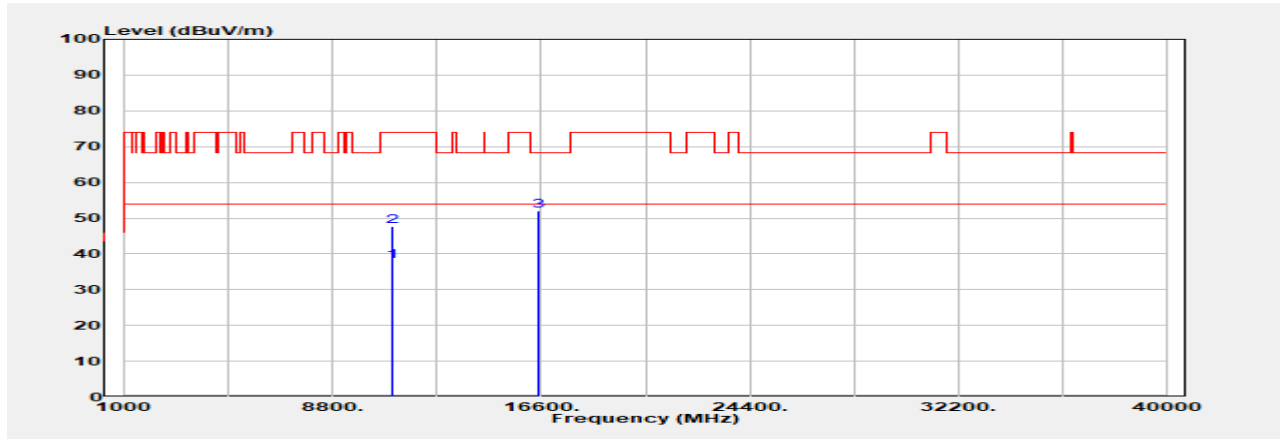

Freq. MHz	Detector Mode PK/QP/AVG	Spectrum Reading Level dB $\mu$ V	Factor dB	Actual FS dB $\mu$ V/m	Limit @3m dB $\mu$ V/m	Margin dB
11000.000	Average	27.79	10.07	37.86	54.00	-16.14
11000.000	Peak	37.73	10.07	47.80	74.00	-26.20
16500.000	Peak	39.34	12.65	51.99	68.20	-16.21

Unless otherwise stated the results shown in this test report refer only to the sample(s) tested and such sample(s) are retained for 90 days only.

除非另有說明，此報告結果僅對測試之樣品負責，同時此樣品僅保留90天。本報告未經本公司書面許可，不可部份複製。

This document is issued by the Company subject to its General Conditions of Service printed overleaf, available on request or accessible at <http://www.sgs.com.tw/Terms-and-Conditions> and for electronic format documents, subject to Terms and Conditions for Electronic Documents at <http://www.sgs.com.tw/Terms-and-Conditions>. Attention is drawn to the limitation of liability, indemnification and jurisdiction issues defined therein. Any holder of this document is advised that information contained hereon reflects the Company's findings at the time of its intervention only and within the limits of Client's instructions, if any. The Company's sole responsibility is to its Client and this document does not exonerate parties to a transaction from exercising all their rights and obligations under the transaction documents. This document cannot be reproduced except in full, without prior written approval of the Company. Any unauthorized alteration, forgery or falsification of the content or appearance of this document is unlawful and offenders may be prosecuted to the fullest extent of the law.



Report Number :TERF2404000927E2  
 Operation Mode :802.11n20  
 Test Frequency :5500 MHz  
 Test Mode :Tx  
 EUT Pol :E2 Plane

Test Site :SAC G Chamber  
 Test Date :2024-04-29  
 Temp./Humi. :20.6°C/62%  
 Antenna Pol. :Horizontal  
 Engineer :Temo Chen

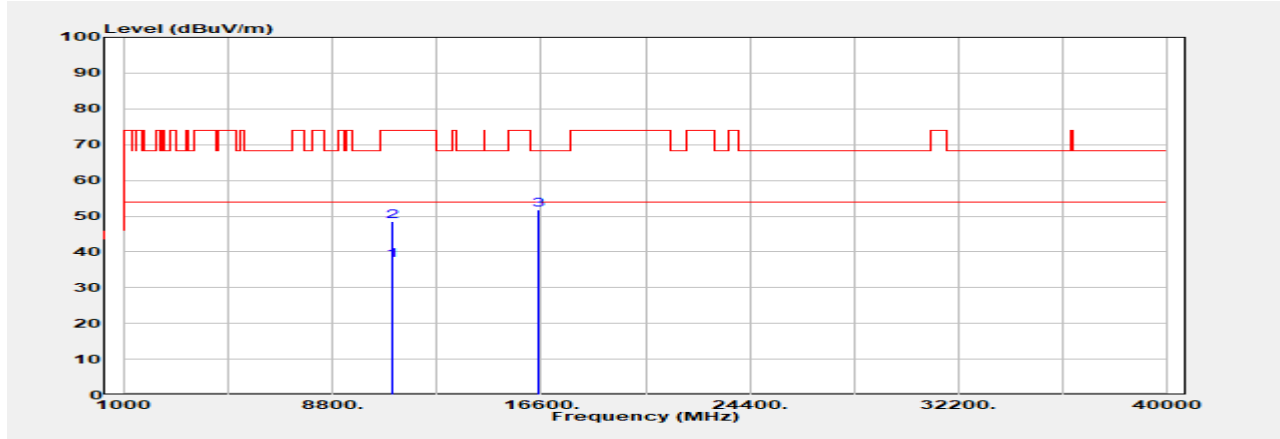

Freq. MHz	Detector Mode PK/QP/AVG	Spectrum Reading Level dBμV	Factor dB	Actual FS dBμV/m	Limit @3m dBμV/m	Margin dB
11000.000	Average	27.59	10.07	37.66	54.00	-16.34
11000.000	Peak	38.31	10.07	48.38	74.00	-25.62
16500.000	Peak	39.11	12.65	51.76	68.20	-16.44

Unless otherwise stated the results shown in this test report refer only to the sample(s) tested and such sample(s) are retained for 90 days only.

除非另有說明，此報告結果僅對測試之樣品負責，同時此樣品僅保留90天。本報告未經本公司書面許可，不可部份複製。

This document is issued by the Company subject to its General Conditions of Service printed overleaf, available on request or accessible at <http://www.sgs.com.tw/Terms-and-Conditions> and for electronic format documents, subject to Terms and Conditions for Electronic Documents at <http://www.sgs.com.tw/Terms-and-Conditions>. Attention is drawn to the limitation of liability, indemnification and jurisdiction issues defined therein. Any holder of this document is advised that information contained hereon reflects the Company's findings at the time of its intervention only and within the limits of Client's instructions, if any. The Company's sole responsibility is to its Client and this document does not exonerate parties to a transaction from exercising all their rights and obligations under the transaction documents. This document cannot be reproduced except in full, without prior written approval of the Company. Any unauthorized alteration, forgery or falsification of the content or appearance of this document is unlawful and offenders may be prosecuted to the fullest extent of the law.

Report Number :TERF2404000927E2  
 Operation Mode :802.11n20  
 Test Frequency :5580 MHz  
 Test Mode :Tx  
 EUT Pol :E2 Plane

Test Site :SAC G Chamber  
 Test Date :2024-04-29  
 Temp./Humi. :20.6°C/62%  
 Antenna Pol. :Vertical  
 Engineer :Temo Chen

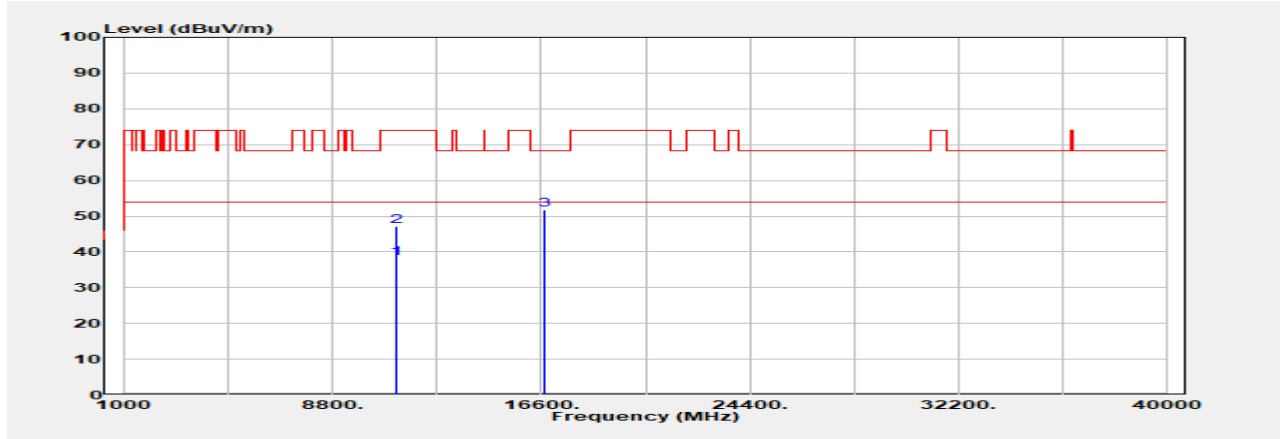

Freq. MHz	Detector Mode PK/QP/AVG	Spectrum Reading Level dBμV	Factor dB	Actual FS dBμV/m	Limit @3m dBμV/m	Margin dB
11160.000	Average	28.19	9.90	38.09	54.00	-15.91
11160.000	Peak	37.18	9.90	47.08	74.00	-26.92
16740.000	Peak	39.53	12.28	51.82	68.20	-16.38

Unless otherwise stated the results shown in this test report refer only to the sample(s) tested and such sample(s) are retained for 90 days only.

除非另有說明，此報告結果僅對測試之樣品負責，同時此樣品僅保留90天。本報告未經本公司書面許可，不可部份複製。

This document is issued by the Company subject to its General Conditions of Service printed overleaf, available on request or accessible at <http://www.sgs.com.tw/Terms-and-Conditions> and for electronic format documents, subject to Terms and Conditions for Electronic Documents at <http://www.sgs.com.tw/Terms-and-Conditions>. Attention is drawn to the limitation of liability, indemnification and jurisdiction issues defined therein. Any holder of this document is advised that information contained hereon reflects the Company's findings at the time of its intervention only and within the limits of Client's instructions, if any. The Company's sole responsibility is to its Client and this document does not exonerate parties to a transaction from exercising all their rights and obligations under the transaction documents. This document cannot be reproduced except in full, without prior written approval of the Company. Any unauthorized alteration, forgery or falsification of the content or appearance of this document is unlawful and offenders may be prosecuted to the fullest extent of the law.

Report Number :TERF2404000927E2  
 Operation Mode :802.11n20  
 Test Frequency :5580 MHz  
 Test Mode :Tx  
 EUT Pol :E2 Plane

Test Site :SAC G Chamber  
 Test Date :2024-04-29  
 Temp./Humi. :20.6°C/62%  
 Antenna Pol. :Horizontal  
 Engineer :Temo Chen

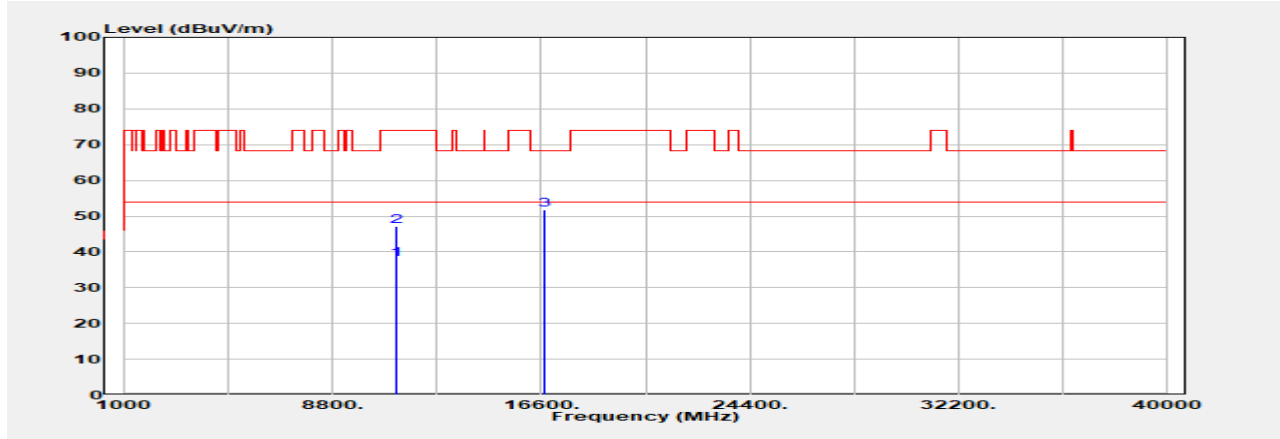

Freq. MHz	Detector Mode PK/QP/AVG	Spectrum Reading Level dBμV	Factor dB	Actual FS dBμV/m	Limit @3m dBμV/m	Margin dB
11160.000	Average	27.92	9.90	37.82	54.00	-16.18
11160.000	Peak	37.21	9.90	47.11	74.00	-26.89
16740.000	Peak	39.61	12.28	51.90	68.20	-16.30

Unless otherwise stated the results shown in this test report refer only to the sample(s) tested and such sample(s) are retained for 90 days only.

除非另有說明，此報告結果僅對測試之樣品負責，同時此樣品僅保留90天。本報告未經本公司書面許可，不可部份複製。

This document is issued by the Company subject to its General Conditions of Service printed overleaf, available on request or accessible at <http://www.sgs.com.tw/Terms-and-Conditions> and for electronic format documents, subject to Terms and Conditions for Electronic Documents at <http://www.sgs.com.tw/Terms-and-Conditions>. Attention is drawn to the limitation of liability, indemnification and jurisdiction issues defined therein. Any holder of this document is advised that information contained hereon reflects the Company's findings at the time of its intervention only and within the limits of Client's instructions, if any. The Company's sole responsibility is to its Client and this document does not exonerate parties to a transaction from exercising all their rights and obligations under the transaction documents. This document cannot be reproduced except in full, without prior written approval of the Company. Any unauthorized alteration, forgery or falsification of the content or appearance of this document is unlawful and offenders may be prosecuted to the fullest extent of the law.

Report Number :TERF2404000927E2  
 Operation Mode :802.11n20  
 Test Frequency :5700 MHz  
 Test Mode :Tx  
 EUT Pol :E2 Plane

Test Site :SAC G Chamber  
 Test Date :2024-04-29  
 Temp./Humi. :20.6°C/62%  
 Antenna Pol. :Vertical  
 Engineer :Temo Chen

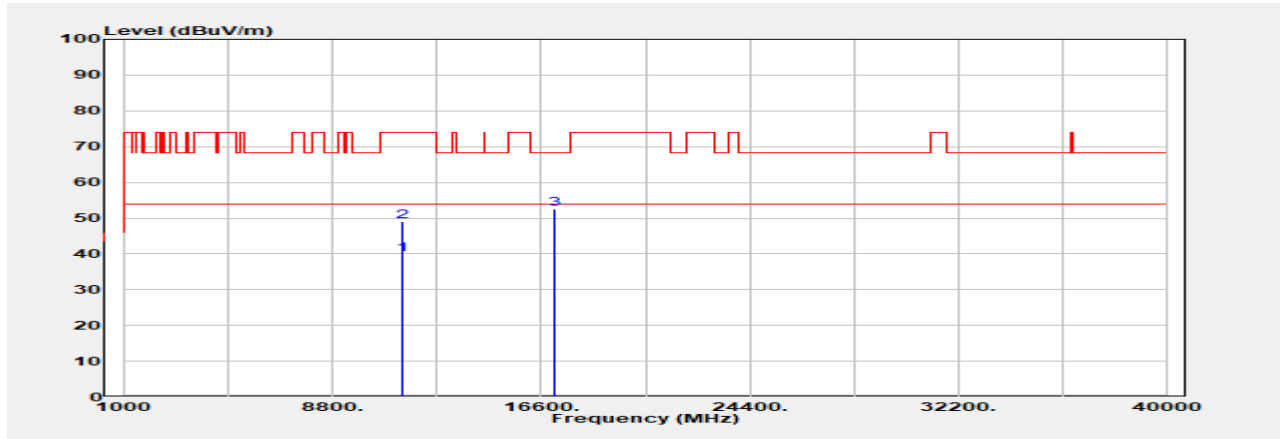

Freq. MHz	Detector Mode PK/QP/AVG	Spectrum Reading Level dB $\mu$ V	Factor dB	Actual FS dB $\mu$ V/m	Limit @3m dB $\mu$ V/m	Margin dB
11400.000	Average	27.52	12.22	39.74	54.00	-14.26
11400.000	Peak	36.88	12.22	49.10	74.00	-24.90
17100.000	Peak	40.22	12.32	52.54	68.20	-15.66

Unless otherwise stated the results shown in this test report refer only to the sample(s) tested and such sample(s) are retained for 90 days only.

除非另有說明，此報告結果僅對測試之樣品負責，同時此樣品僅保留90天。本報告未經本公司書面許可，不可部份複製。

This document is issued by the Company subject to its General Conditions of Service printed overleaf, available on request or accessible at <http://www.sgs.com.tw/Terms-and-Conditions> and for electronic format documents, subject to Terms and Conditions for Electronic Documents at <http://www.sgs.com.tw/Terms-and-Conditions>. Attention is drawn to the limitation of liability, indemnification and jurisdiction issues defined therein. Any holder of this document is advised that information contained hereon reflects the Company's findings at the time of its intervention only and within the limits of Client's instructions, if any. The Company's sole responsibility is to its Client and this document does not exonerate parties to a transaction from exercising all their rights and obligations under the transaction documents. This document cannot be reproduced except in full, without prior written approval of the Company. Any unauthorized alteration, forgery or falsification of the content or appearance of this document is unlawful and offenders may be prosecuted to the fullest extent of the law.

Report Number :TERF2404000927E2  
 Operation Mode :802.11n20  
 Test Frequency :5700 MHz  
 Test Mode :Tx  
 EUT Pol :E2 Plane

Test Site :SAC G Chamber  
 Test Date :2024-04-29  
 Temp./Humi. :20.6°C/62%  
 Antenna Pol. :Horizontal  
 Engineer :Temo Chen

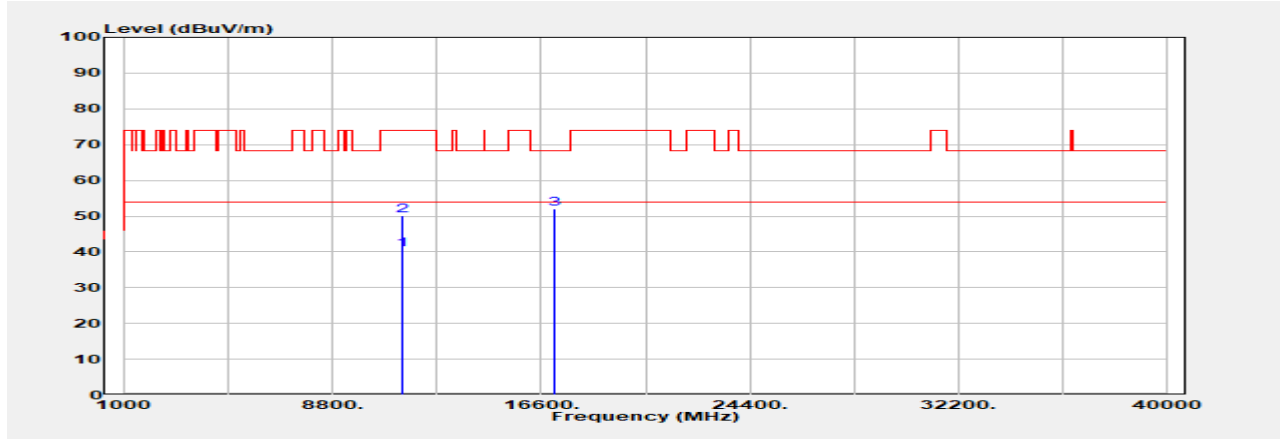

Freq. MHz	Detector Mode PK/QP/AVG	Spectrum Reading Level dBμV	Factor dB	Actual FS dBμV/m	Limit @3m dBμV/m	Margin dB
11400.000	Average	28.33	12.22	40.55	54.00	-13.45
11400.000	Peak	37.89	12.22	50.11	74.00	-23.89
17100.000	Peak	39.59	12.32	51.91	68.20	-16.29

Unless otherwise stated the results shown in this test report refer only to the sample(s) tested and such sample(s) are retained for 90 days only.

除非另有說明，此報告結果僅對測試之樣品負責，同時此樣品僅保留90天。本報告未經本公司書面許可，不可部份複製。

This document is issued by the Company subject to its General Conditions of Service printed overleaf, available on request or accessible at <http://www.sgs.com.tw/Terms-and-Conditions> and for electronic format documents, subject to Terms and Conditions for Electronic Documents at <http://www.sgs.com.tw/Terms-and-Conditions>. Attention is drawn to the limitation of liability, indemnification and jurisdiction issues defined therein. Any holder of this document is advised that information contained hereon reflects the Company's findings at the time of its intervention only and within the limits of Client's instructions, if any. The Company's sole responsibility is to its Client and this document does not exonerate parties to a transaction from exercising all their rights and obligations under the transaction documents. This document cannot be reproduced except in full, without prior written approval of the Company. Any unauthorized alteration, forgery or falsification of the content or appearance of this document is unlawful and offenders may be prosecuted to the fullest extent of the law.

Report Number :TERF2404000927E2  
 Operation Mode :802.11n20  
 Test Frequency :5720 MHz  
 Test Mode :Tx  
 EUT Pol :E2 Plane

Test Site :SAC G Chamber  
 Test Date :2024-04-29  
 Temp./Humi. :20.6°C/62%  
 Antenna Pol. :Vertical  
 Engineer :Temo Chen

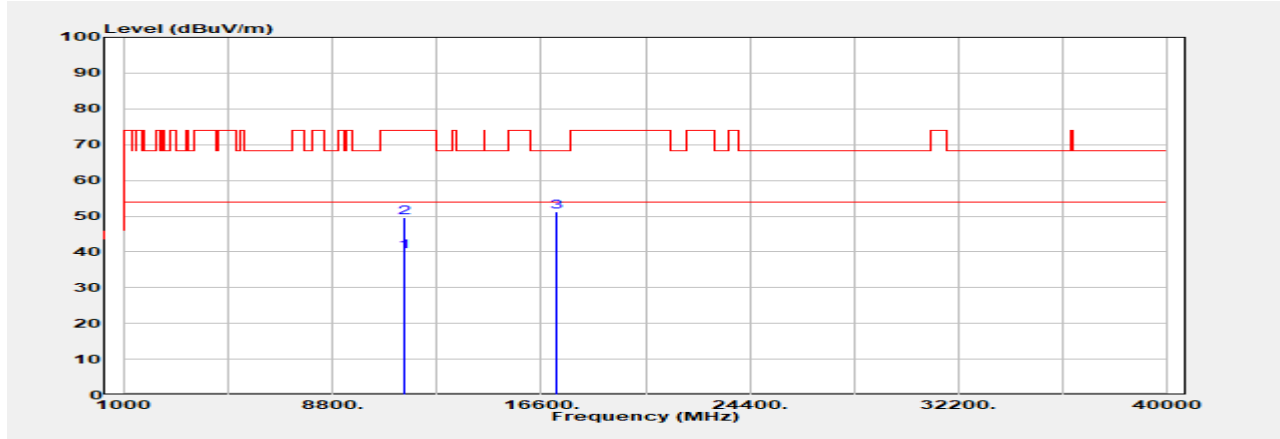

Freq. MHz	Detector Mode PK/QP/AVG	Spectrum Reading Level dBμV	Factor dB	Actual FS dBμV/m	Limit @3m dBμV/m	Margin dB
11440.000	Average	28.66	11.39	40.04	54.00	-13.96
11440.000	Peak	38.34	11.39	49.72	74.00	-24.28
17160.000	Peak	39.41	11.94	51.35	68.20	-16.85

Unless otherwise stated the results shown in this test report refer only to the sample(s) tested and such sample(s) are retained for 90 days only.

除非另有說明，此報告結果僅對測試之樣品負責，同時此樣品僅保留90天。本報告未經本公司書面許可，不可部份複製。

This document is issued by the Company subject to its General Conditions of Service printed overleaf, available on request or accessible at <http://www.sgs.com.tw/Terms-and-Conditions> and for electronic format documents, subject to Terms and Conditions for Electronic Documents at <http://www.sgs.com.tw/Terms-and-Conditions>. Attention is drawn to the limitation of liability, indemnification and jurisdiction issues defined therein. Any holder of this document is advised that information contained hereon reflects the Company's findings at the time of its intervention only and within the limits of Client's instructions, if any. The Company's sole responsibility is to its Client and this document does not exonerate parties to a transaction from exercising all their rights and obligations under the transaction documents. This document cannot be reproduced except in full, without prior written approval of the Company. Any unauthorized alteration, forgery or falsification of the content or appearance of this document is unlawful and offenders may be prosecuted to the fullest extent of the law.

Report Number :TERF2404000927E2  
 Operation Mode :802.11n20  
 Test Frequency :5720 MHz  
 Test Mode :Tx  
 EUT Pol :E2 Plane

Test Site :SAC G Chamber  
 Test Date :2024-04-29  
 Temp./Humi. :20.6°C/62%  
 Antenna Pol. :Horizontal  
 Engineer :Temo Chen

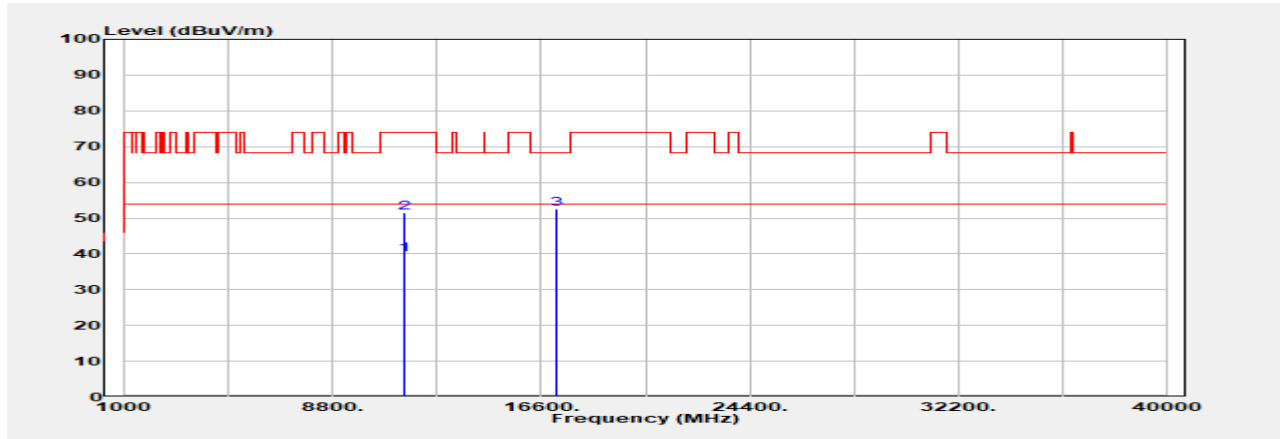

Freq. MHz	Detector Mode PK/QP/AVG	Spectrum Reading Level dB $\mu$ V	Factor dB	Actual FS dB $\mu$ V/m	Limit @3m dB $\mu$ V/m	Margin dB
11440.000	Average	28.35	11.39	39.74	54.00	-14.26
11440.000	Peak	40.15	11.39	51.53	74.00	-22.47
17160.000	Peak	40.55	11.94	52.49	68.20	-15.71

Unless otherwise stated the results shown in this test report refer only to the sample(s) tested and such sample(s) are retained for 90 days only.

除非另有說明，此報告結果僅對測試之樣品負責，同時此樣品僅保留90天。本報告未經本公司書面許可，不可部份複製。

This document is issued by the Company subject to its General Conditions of Service printed overleaf, available on request or accessible at <http://www.sgs.com.tw/Terms-and-Conditions> and for electronic format documents, subject to Terms and Conditions for Electronic Documents at <http://www.sgs.com.tw/Terms-and-Conditions>. Attention is drawn to the limitation of liability, indemnification and jurisdiction issues defined therein. Any holder of this document is advised that information contained hereon reflects the Company's findings at the time of its intervention only and within the limits of Client's instructions, if any. The Company's sole responsibility is to its Client and this document does not exonerate parties to a transaction from exercising all their rights and obligations under the transaction documents. This document cannot be reproduced except in full, without prior written approval of the Company. Any unauthorized alteration, forgery or falsification of the content or appearance of this document is unlawful and offenders may be prosecuted to the fullest extent of the law.

Report Number :TERF2404000927E2  
 Operation Mode :802.11n20  
 Test Frequency :5745 MHz  
 Test Mode :Tx  
 EUT Pol :E2 Plane

Test Site :SAC G Chamber  
 Test Date :2024-04-29  
 Temp./Humi. :20.6°C/62%  
 Antenna Pol. :Vertical  
 Engineer :Temo Chen

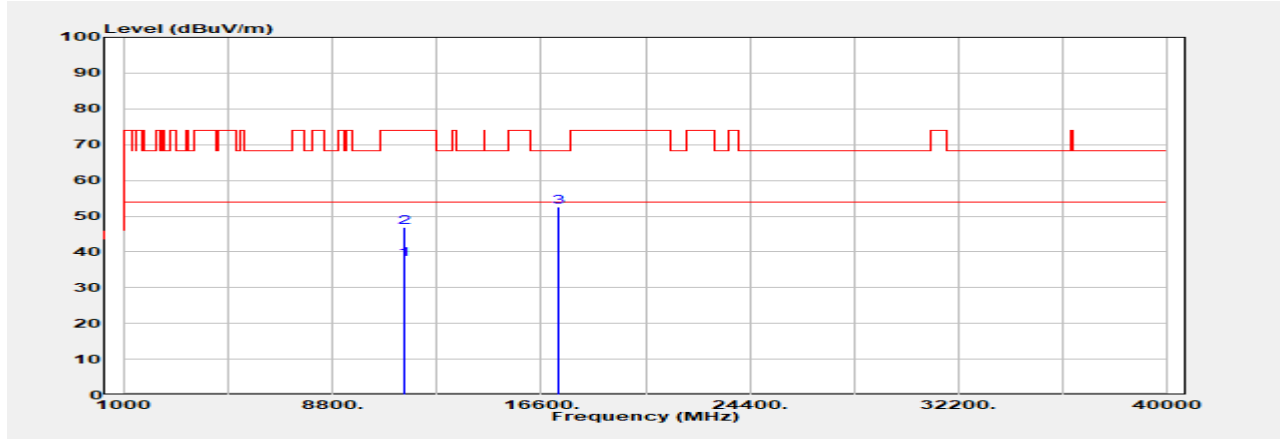

Freq. MHz	Detector Mode PK/QP/AVG	Spectrum Reading Level dBμV	Factor dB	Actual FS dBμV/m	Limit @3m dBμV/m	Margin dB
11490.000	Average	27.69	10.35	38.04	54.00	-15.96
11490.000	Peak	36.61	10.35	46.96	74.00	-27.04
17235.000	Peak	40.27	12.23	52.50	68.20	-15.70

Unless otherwise stated the results shown in this test report refer only to the sample(s) tested and such sample(s) are retained for 90 days only.

除非另有說明，此報告結果僅對測試之樣品負責，同時此樣品僅保留90天。本報告未經本公司書面許可，不可部份複製。

This document is issued by the Company subject to its General Conditions of Service printed overleaf, available on request or accessible at <http://www.sgs.com.tw/Terms-and-Conditions> and for electronic format documents, subject to Terms and Conditions for Electronic Documents at <http://www.sgs.com.tw/Terms-and-Conditions>. Attention is drawn to the limitation of liability, indemnification and jurisdiction issues defined therein. Any holder of this document is advised that information contained hereon reflects the Company's findings at the time of its intervention only and within the limits of Client's instructions, if any. The Company's sole responsibility is to its Client and this document does not exonerate parties to a transaction from exercising all their rights and obligations under the transaction documents. This document cannot be reproduced except in full, without prior written approval of the Company. Any unauthorized alteration, forgery or falsification of the content or appearance of this document is unlawful and offenders may be prosecuted to the fullest extent of the law.



Report Number :TERF2404000927E2  
 Operation Mode :802.11n20  
 Test Frequency :5745 MHz  
 Test Mode :Tx  
 EUT Pol :E2 Plane

Test Site :SAC G Chamber  
 Test Date :2024-04-29  
 Temp./Humi. :20.6°C/62%  
 Antenna Pol. :Horizontal  
 Engineer :Temo Chen

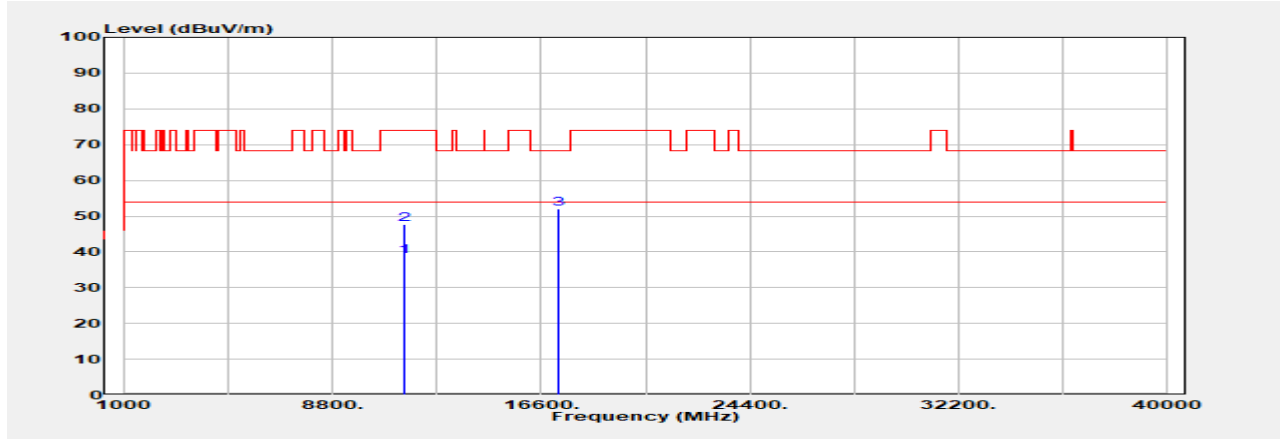

Freq. MHz	Detector Mode PK/QP/AVG	Spectrum Reading Level dB $\mu$ V	Factor dB	Actual FS dB $\mu$ V/m	Limit @3m dB $\mu$ V/m	Margin dB
11490.000	Average	28.28	10.35	38.63	54.00	-15.37
11490.000	Peak	37.44	10.35	47.79	74.00	-26.21
17235.000	Peak	39.87	12.23	52.10	68.20	-16.10

Unless otherwise stated the results shown in this test report refer only to the sample(s) tested and such sample(s) are retained for 90 days only.

除非另有說明，此報告結果僅對測試之樣品負責，同時此樣品僅保留90天。本報告未經本公司書面許可，不可部份複製。

This document is issued by the Company subject to its General Conditions of Service printed overleaf, available on request or accessible at <http://www.sgs.com.tw/Terms-and-Conditions> and for electronic format documents, subject to Terms and Conditions for Electronic Documents at <http://www.sgs.com.tw/Terms-and-Conditions>. Attention is drawn to the limitation of liability, indemnification and jurisdiction issues defined therein. Any holder of this document is advised that information contained hereon reflects the Company's findings at the time of its intervention only and within the limits of Client's instructions, if any. The Company's sole responsibility is to its Client and this document does not exonerate parties to a transaction from exercising all their rights and obligations under the transaction documents. This document cannot be reproduced except in full, without prior written approval of the Company. Any unauthorized alteration, forgery or falsification of the content or appearance of this document is unlawful and offenders may be prosecuted to the fullest extent of the law.

Report Number :TERF2404000927E2  
 Operation Mode :802.11n20  
 Test Frequency :5785 MHz  
 Test Mode :Tx  
 EUT Pol :E2 Plane

Test Site :SAC G Chamber  
 Test Date :2024-04-29  
 Temp./Humi. :20.6°C/62%  
 Antenna Pol. :Vertical  
 Engineer :Temo Chen

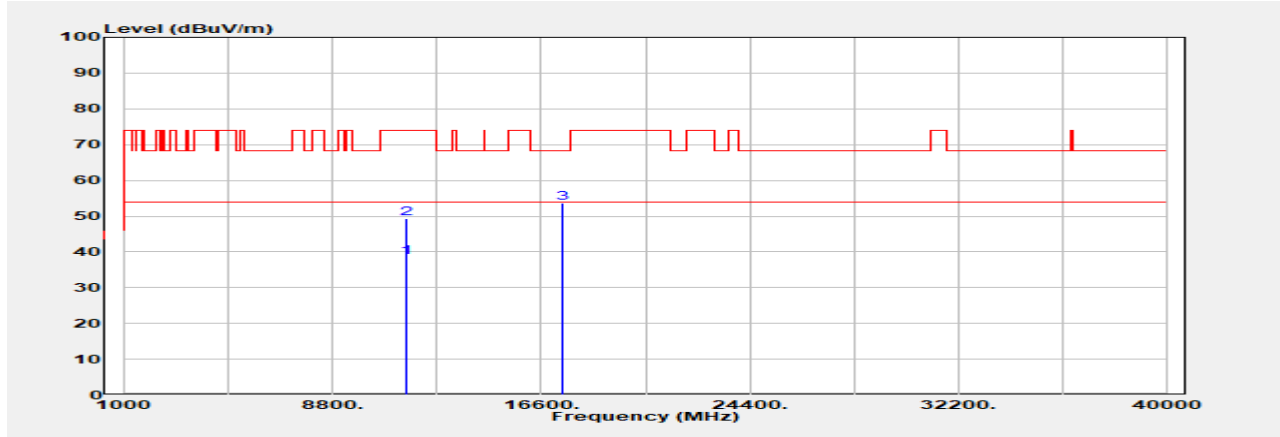

Freq. MHz	Detector Mode PK/QP/AVG	Spectrum Reading Level dB $\mu$ V	Factor dB	Actual FS dB $\mu$ V/m	Limit @3m dB $\mu$ V/m	Margin dB
11570.000	Average	28.20	10.22	38.42	54.00	-15.58
11570.000	Peak	39.11	10.22	49.33	74.00	-24.67
17355.000	Peak	41.06	12.59	53.64	68.20	-14.56

Unless otherwise stated the results shown in this test report refer only to the sample(s) tested and such sample(s) are retained for 90 days only.

除非另有說明，此報告結果僅對測試之樣品負責，同時此樣品僅保留90天。本報告未經本公司書面許可，不可部份複製。

This document is issued by the Company subject to its General Conditions of Service printed overleaf, available on request or accessible at <http://www.sgs.com.tw/Terms-and-Conditions> and for electronic format documents, subject to Terms and Conditions for Electronic Documents at <http://www.sgs.com.tw/Terms-and-Conditions>. Attention is drawn to the limitation of liability, indemnification and jurisdiction issues defined therein. Any holder of this document is advised that information contained hereon reflects the Company's findings at the time of its intervention only and within the limits of Client's instructions, if any. The Company's sole responsibility is to its Client and this document does not exonerate parties to a transaction from exercising all their rights and obligations under the transaction documents. This document cannot be reproduced except in full, without prior written approval of the Company. Any unauthorized alteration, forgery or falsification of the content or appearance of this document is unlawful and offenders may be prosecuted to the fullest extent of the law.

Report Number :TERF2404000927E2	Test Site :SAC G Chamber
Operation Mode :802.11n20	Test Date :2024-04-29
Test Frequency :5785 MHz	Temp./Humi. :20.6°C/62%
Test Mode :Tx	Antenna Pol. :Horizontal
EUT Pol :E2 Plane	Engineer :Temo Chen

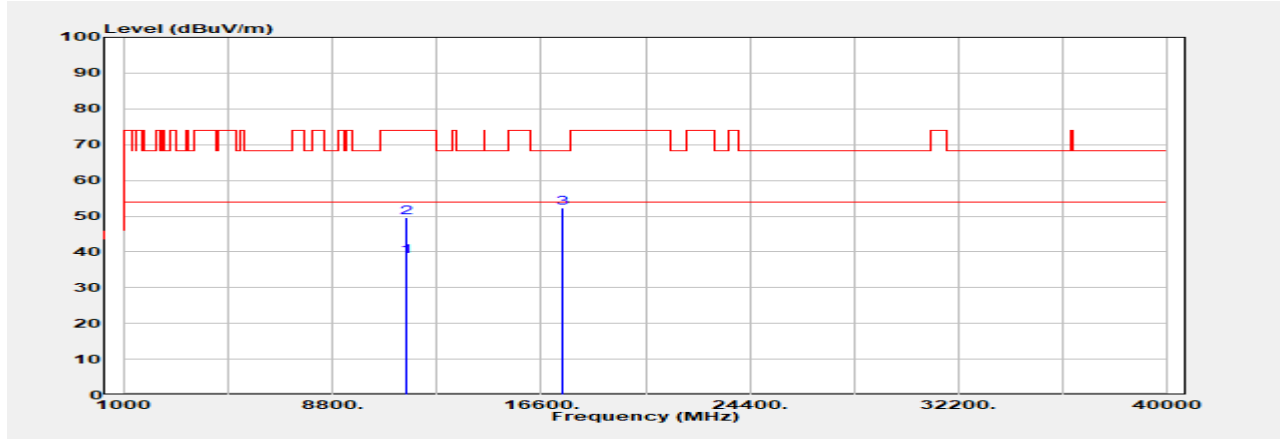

Freq. MHz	Detector Mode PK/QP/AVG	Spectrum Reading Level dB $\mu$ V	Factor dB	Actual FS dB $\mu$ V/m	Limit @3m dB $\mu$ V/m	Margin dB
11570.000	Average	28.42	10.22	38.64	54.00	-15.36
11570.000	Peak	39.39	10.22	49.60	74.00	-24.40
17355.000	Peak	39.62	12.59	52.20	68.20	-16.00

Unless otherwise stated the results shown in this test report refer only to the sample(s) tested and such sample(s) are retained for 90 days only.

除非另有說明，此報告結果僅對測試之樣品負責，同時此樣品僅保留90天。本報告未經本公司書面許可，不可部份複製。

This document is issued by the Company subject to its General Conditions of Service printed overleaf, available on request or accessible at <http://www.sgs.com.tw/Terms-and-Conditions> and for electronic format documents, subject to Terms and Conditions for Electronic Documents at <http://www.sgs.com.tw/Terms-and-Conditions>. Attention is drawn to the limitation of liability, indemnification and jurisdiction issues defined therein. Any holder of this document is advised that information contained hereon reflects the Company's findings at the time of its intervention only and within the limits of Client's instructions, if any. The Company's sole responsibility is to its Client and this document does not exonerate parties to a transaction from exercising all their rights and obligations under the transaction documents. This document cannot be reproduced except in full, without prior written approval of the Company. Any unauthorized alteration, forgery or falsification of the content or appearance of this document is unlawful and offenders may be prosecuted to the fullest extent of the law.

Report Number :TERF2404000927E2  
 Operation Mode :802.11n20  
 Test Frequency :5825 MHz  
 Test Mode :Tx  
 EUT Pol :E2 Plane

Test Site :SAC G Chamber  
 Test Date :2024-04-29  
 Temp./Humi. :20.6°C/62%  
 Antenna Pol. :Vertical  
 Engineer :Temo Chen

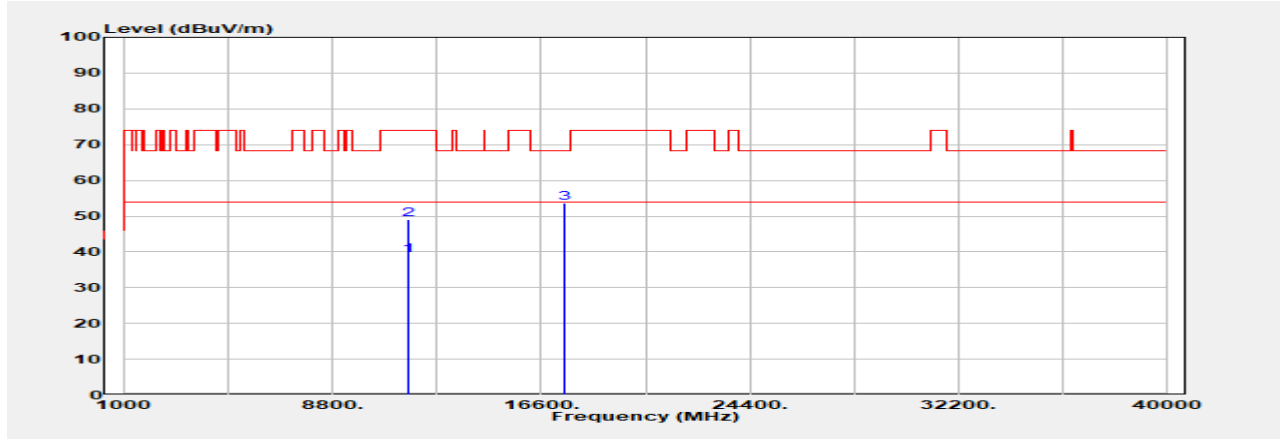

Freq. MHz	Detector Mode PK/QP/AVG	Spectrum Reading Level dBμV	Factor dB	Actual FS dBμV/m	Limit @3m dBμV/m	Margin dB
11650.000	Average	28.37	10.64	39.01	54.00	-14.99
11650.000	Peak	38.43	10.64	49.07	74.00	-24.93
17475.000	Peak	41.13	12.54	53.67	68.20	-14.53

Unless otherwise stated the results shown in this test report refer only to the sample(s) tested and such sample(s) are retained for 90 days only.

除非另有說明，此報告結果僅對測試之樣品負責，同時此樣品僅保留90天。本報告未經本公司書面許可，不可部份複製。

This document is issued by the Company subject to its General Conditions of Service printed overleaf, available on request or accessible at <http://www.sgs.com.tw/Terms-and-Conditions> and for electronic format documents, subject to Terms and Conditions for Electronic Documents at <http://www.sgs.com.tw/Terms-and-Conditions>. Attention is drawn to the limitation of liability, indemnification and jurisdiction issues defined therein. Any holder of this document is advised that information contained hereon reflects the Company's findings at the time of its intervention only and within the limits of Client's instructions, if any. The Company's sole responsibility is to its Client and this document does not exonerate parties to a transaction from exercising all their rights and obligations under the transaction documents. This document cannot be reproduced except in full, without prior written approval of the Company. Any unauthorized alteration, forgery or falsification of the content or appearance of this document is unlawful and offenders may be prosecuted to the fullest extent of the law.

Report Number :TERF2404000927E2

Test Site :SAC G Chamber

Operation Mode :802.11n20

Test Date :2024-04-29

Test Frequency :5825 MHz

Temp./Humi. :20.6°C/62%

Test Mode :Tx

Antenna Pol. :Horizontal

EUT Pol :E2 Plane

Engineer :Temo Chen

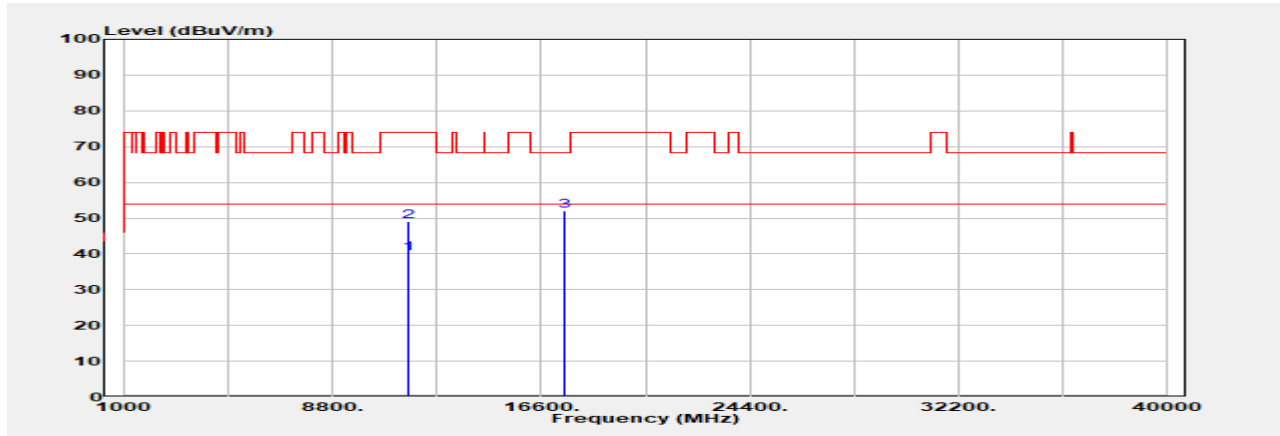

Freq. MHz	Detector Mode PK/QP/AVG	Spectrum Reading Level dB $\mu$ V	Factor dB	Actual FS dB $\mu$ V/m	Limit @3m dB $\mu$ V/m	Margin dB
11650.000	Average	29.42	10.64	40.06	54.00	-13.94
11650.000	Peak	38.34	10.64	48.98	74.00	-25.02
17475.000	Peak	39.54	12.54	52.08	68.20	-16.12

Unless otherwise stated the results shown in this test report refer only to the sample(s) tested and such sample(s) are retained for 90 days only.

除非另有說明，此報告結果僅對測試之樣品負責，同時此樣品僅保留90天。本報告未經本公司書面許可，不可部份複製。

This document is issued by the Company subject to its General Conditions of Service printed overleaf, available on request or accessible at <http://www.sgs.com.tw/Terms-and-Conditions> and for electronic format documents, subject to Terms and Conditions for Electronic Documents at <http://www.sgs.com.tw/Terms-and-Conditions>. Attention is drawn to the limitation of liability, indemnification and jurisdiction issues defined therein. Any holder of this document is advised that information contained hereon reflects the Company's findings at the time of its intervention only and within the limits of Client's instructions, if any. The Company's sole responsibility is to its Client and this document does not exonerate parties to a transaction from exercising all their rights and obligations under the transaction documents. This document cannot be reproduced except in full, without prior written approval of the Company. Any unauthorized alteration, forgery or falsification of the content or appearance of this document is unlawful and offenders may be prosecuted to the fullest extent of the law.

### 11.6.2 Band edge falling to restricted band

#### dipole

Report Number	:TERF2404000927E2	Test Site	:SAC G Chamber
Operation Mode	:802.11a	Test Date	:2024-05-10
Test Frequency	:5180 MHz	Temp./Humi.	:24.0°C/51%
Test Mode	:Bandedge	Antenna Pol.	:Vertical
EUT Pol	:E2 Plane	Engineer	:Temo Chen

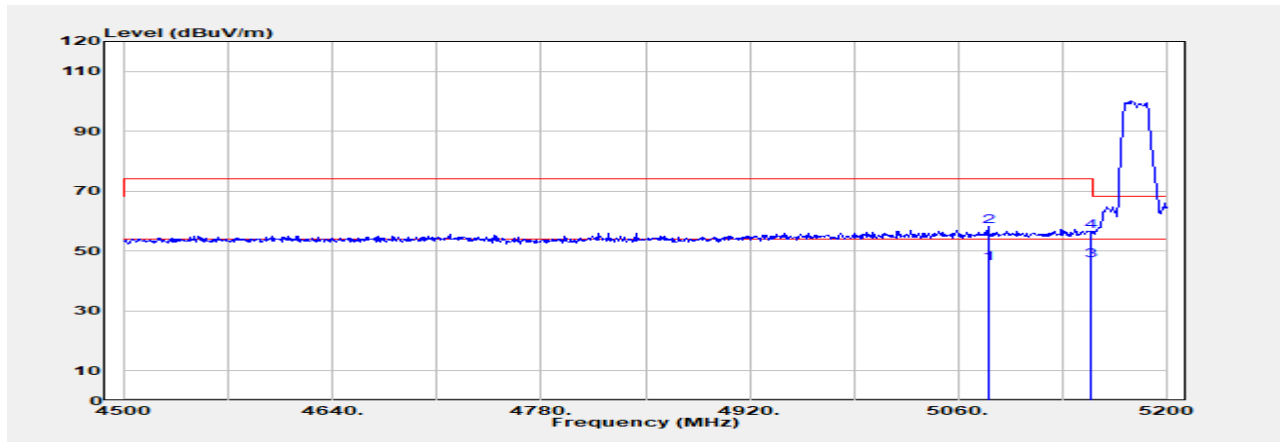

Freq. MHz	Detector Mode	Spectrum Reading Level dB $\mu$ V	Factor dB	Actual FS dB $\mu$ V/m	Limit @3m dB $\mu$ V/m	Margin dB
5080.300	Average	40.34	5.62	45.97	54.00	-8.03
5080.300	Peak	52.54	5.62	58.16	74.00	-15.84
5150.000	Average	41.29	5.42	46.71	54.00	-7.29
5150.000	Peak	51.15	5.42	56.57	74.00	-17.43

Unless otherwise stated the results shown in this test report refer only to the sample(s) tested and such sample(s) are retained for 90 days only.

除非另有說明，此報告結果僅對測試之樣品負責，同時此樣品僅保留90天。本報告未經本公司書面許可，不可部份複製。

This document is issued by the Company subject to its General Conditions of Service printed overleaf, available on request or accessible at <http://www.sgs.com.tw/Terms-and-Conditions> and for electronic format documents, subject to Terms and Conditions for Electronic Documents at <http://www.sgs.com.tw/Terms-and-Conditions>. Attention is drawn to the limitation of liability, indemnification and jurisdiction issues defined therein. Any holder of this document is advised that information contained hereon reflects the Company's findings at the time of its intervention only and within the limits of Client's instructions, if any. The Company's sole responsibility is to its Client and this document does not exonerate parties to a transaction from exercising all their rights and obligations under the transaction documents. This document cannot be reproduced except in full, without prior written approval of the Company. Any unauthorized alteration, forgery or falsification of the content or appearance of this document is unlawful and offenders may be prosecuted to the fullest extent of the law.

Report Number :TERF2404000927E2  
 Operation Mode :802.11a  
 Test Frequency :5180 MHz  
 Test Mode :Bandedge  
 EUT Pol :E2 Plane

Test Site :SAC G Chamber  
 Test Date :2024-05-10  
 Temp./Humi. :24.0°C/51%  
 Antenna Pol. :Horizontal  
 Engineer :Temo Chen

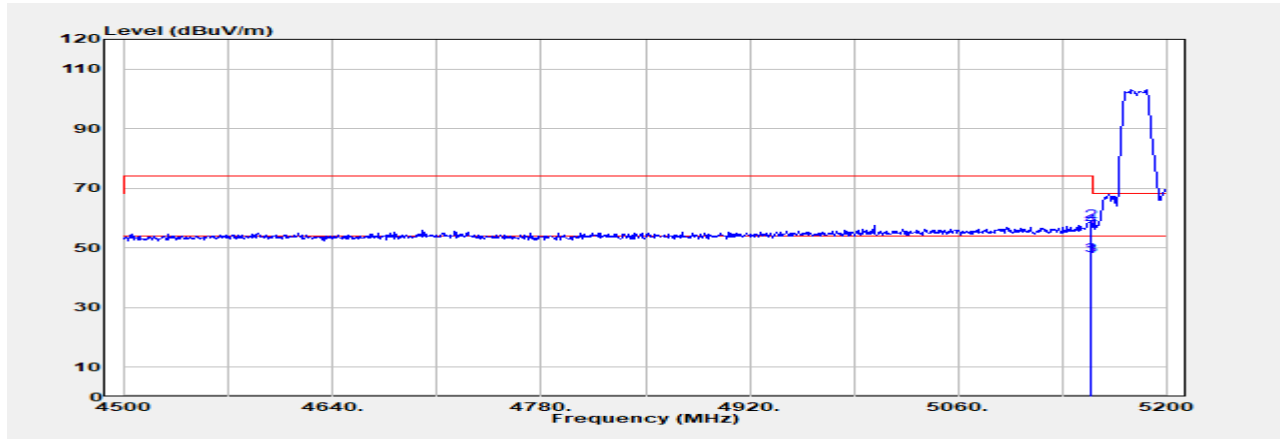

Freq. MHz	Detector Mode PK/QP/AVG	Spectrum Reading Level dB $\mu$ V	Factor dB	Actual FS dB $\mu$ V/m	Limit @3m dB $\mu$ V/m	Margin dB
5148.900	Average	41.86	5.43	47.29	54.00	-6.71
5148.900	Peak	53.48	5.43	58.91	74.00	-15.09
5150.000	Average	41.90	5.42	47.33	54.00	-6.67
5150.000	Peak	51.88	5.42	57.31	74.00	-16.69

Unless otherwise stated the results shown in this test report refer only to the sample(s) tested and such sample(s) are retained for 90 days only.

除非另有說明，此報告結果僅對測試之樣品負責，同時此樣品僅保留90天。本報告未經本公司書面許可，不可部份複製。

This document is issued by the Company subject to its General Conditions of Service printed overleaf, available on request or accessible at <http://www.sgs.com.tw/Terms-and-Conditions> and for electronic format documents, subject to Terms and Conditions for Electronic Documents at <http://www.sgs.com.tw/Terms-and-Conditions>. Attention is drawn to the limitation of liability, indemnification and jurisdiction issues defined therein. Any holder of this document is advised that information contained hereon reflects the Company's findings at the time of its intervention only and within the limits of Client's instructions, if any. The Company's sole responsibility is to its Client and this document does not exonerate parties to a transaction from exercising all their rights and obligations under the transaction documents. This document cannot be reproduced except in full, without prior written approval of the Company. Any unauthorized alteration, forgery or falsification of the content or appearance of this document is unlawful and offenders may be prosecuted to the fullest extent of the law.

Report Number :TERF2404000927E2  
 Operation Mode :802.11a  
 Test Frequency :5320 MHz  
 Test Mode :Bandedge  
 EUT Pol :E2 Plane

Test Site :SAC G Chamber  
 Test Date :2024-04-24  
 Temp./Humi. :22.1°C/57%  
 Antenna Pol. :Vertical  
 Engineer :Temo Chen

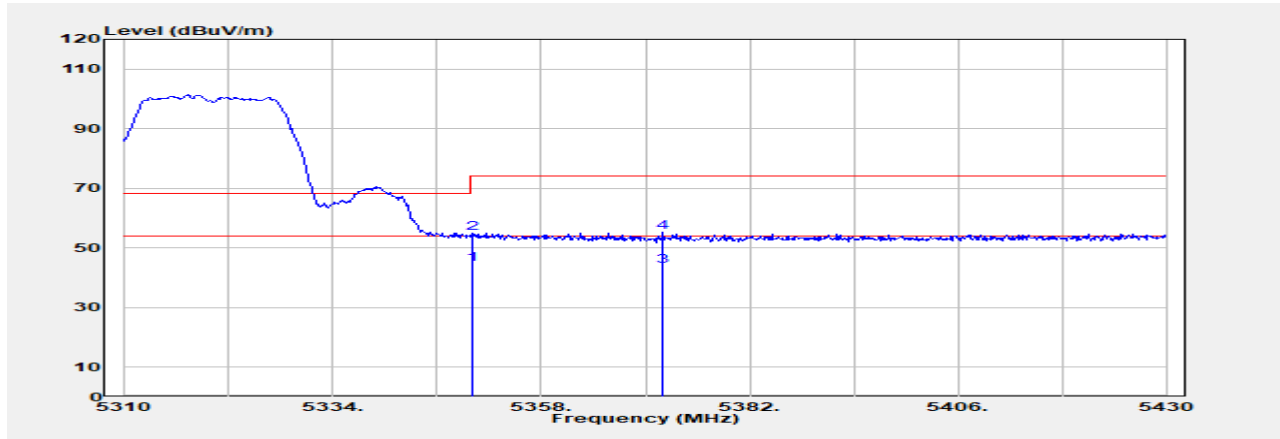

Freq. MHz	Detector Mode PK/QP/AVG	Spectrum Reading Level dB $\mu$ V	Factor dB	Actual FS dB $\mu$ V/m	Limit @3m dB $\mu$ V/m	Margin dB
5350.000	Average	39.36	5.04	44.40	54.00	-9.60
5350.000	Peak	49.87	5.04	54.91	74.00	-19.09
5372.040	Average	38.89	5.05	43.94	54.00	-10.06
5372.040	Peak	50.25	5.05	55.30	74.00	-18.70

Unless otherwise stated the results shown in this test report refer only to the sample(s) tested and such sample(s) are retained for 90 days only.

除非另有說明，此報告結果僅對測試之樣品負責，同時此樣品僅保留90天。本報告未經本公司書面許可，不可部份複製。

This document is issued by the Company subject to its General Conditions of Service printed overleaf, available on request or accessible at <http://www.sgs.com.tw/Terms-and-Conditions> and for electronic format documents, subject to Terms and Conditions for Electronic Documents at <http://www.sgs.com.tw/Terms-and-Conditions>. Attention is drawn to the limitation of liability, indemnification and jurisdiction issues defined therein. Any holder of this document is advised that information contained hereon reflects the Company's findings at the time of its intervention only and within the limits of Client's instructions, if any. The Company's sole responsibility is to its Client and this document does not exonerate parties to a transaction from exercising all their rights and obligations under the transaction documents. This document cannot be reproduced except in full, without prior written approval of the Company. Any unauthorized alteration, forgery or falsification of the content or appearance of this document is unlawful and offenders may be prosecuted to the fullest extent of the law.



Report Number :TERF2404000927E2  
 Operation Mode :802.11a  
 Test Frequency :5320 MHz  
 Test Mode :Bandedge  
 EUT Pol :E2 Plane

Test Site :SAC G Chamber  
 Test Date :2024-04-24  
 Temp./Humi. :22.1°C/57%  
 Antenna Pol. :Horizontal  
 Engineer :Temo Chen

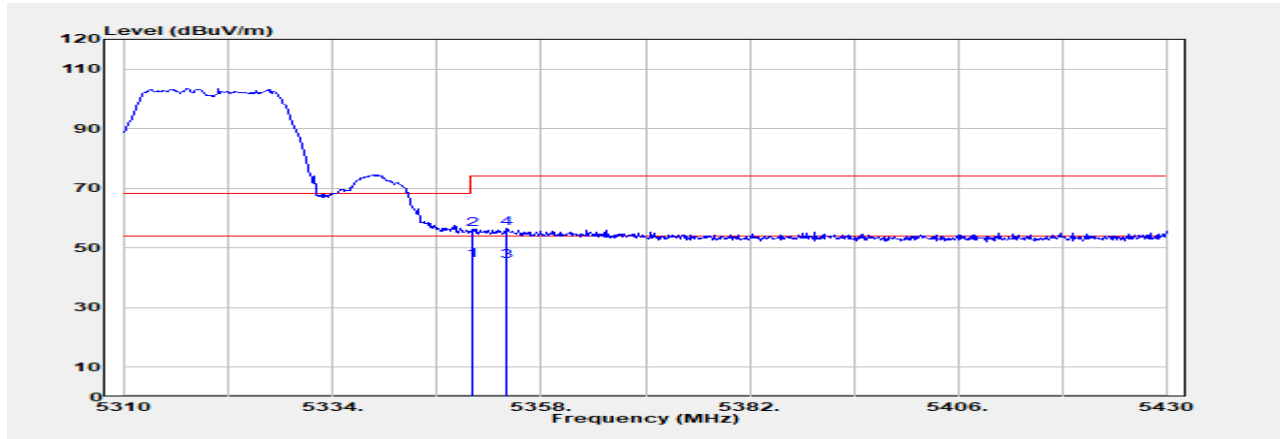

Freq. MHz	Detector Mode PK/QP/AVG	Spectrum Reading Level dBμV	Factor dB	Actual FS dBμV/m	Limit @3m dBμV/m	Margin dB
5350.000	Average	40.84	5.04	45.88	54.00	-8.12
5350.000	Peak	51.24	5.04	56.28	74.00	-17.72
5353.920	Average	40.55	5.04	45.59	54.00	-8.41
5353.920	Peak	51.43	5.04	56.47	74.00	-17.53

Unless otherwise stated the results shown in this test report refer only to the sample(s) tested and such sample(s) are retained for 90 days only.

除非另有說明，此報告結果僅對測試之樣品負責，同時此樣品僅保留90天。本報告未經本公司書面許可，不可部份複製。

This document is issued by the Company subject to its General Conditions of Service printed overleaf, available on request or accessible at <http://www.sgs.com.tw/Terms-and-Conditions> and for electronic format documents, subject to Terms and Conditions for Electronic Documents at <http://www.sgs.com.tw/Terms-and-Conditions>. Attention is drawn to the limitation of liability, indemnification and jurisdiction issues defined therein. Any holder of this document is advised that information contained hereon reflects the Company's findings at the time of its intervention only and within the limits of Client's instructions, if any. The Company's sole responsibility is to its Client and this document does not exonerate parties to a transaction from exercising all their rights and obligations under the transaction documents. This document cannot be reproduced except in full, without prior written approval of the Company. Any unauthorized alteration, forgery or falsification of the content or appearance of this document is unlawful and offenders may be prosecuted to the fullest extent of the law.

Report Number :TERF2404000927E2  
 Operation Mode :802.11a  
 Test Frequency :5500 MHz  
 Test Mode :Bandedge  
 EUT Pol :E2 Plane

Test Site :SAC G Chamber  
 Test Date :2024-04-24  
 Temp./Humi. :22.1°C/57%  
 Antenna Pol. :Vertical  
 Engineer :Temo Chen

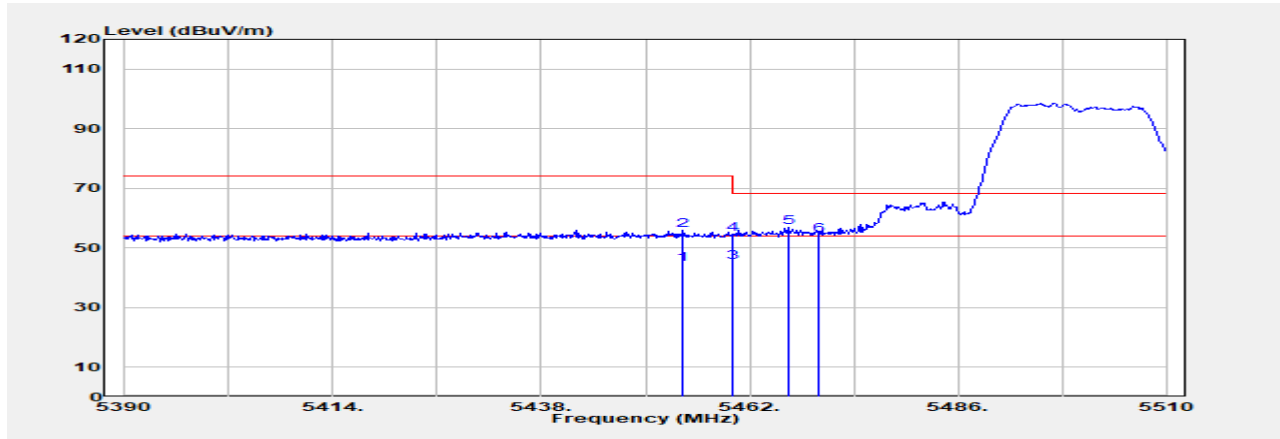

Freq. MHz	Detector Mode PK/QP/AVG	Spectrum Reading Level dB $\mu$ V	Factor dB	Actual FS dB $\mu$ V/m	Limit @3m dB $\mu$ V/m	Margin dB
5454.320	Average	39.03	5.66	44.69	54.00	-9.31
5454.320	Peak	50.35	5.66	56.01	74.00	-17.99
5460.000	Average	39.48	5.71	45.19	54.00	-8.81
5460.000	Peak	48.90	5.71	54.61	74.00	-19.39
5466.440	Peak	51.23	5.77	57.00	68.20	-11.20
5470.000	Peak	48.48	5.81	54.29	68.20	-13.91

Unless otherwise stated the results shown in this test report refer only to the sample(s) tested and such sample(s) are retained for 90 days only.

除非另有說明，此報告結果僅對測試之樣品負責，同時此樣品僅保留90天。本報告未經本公司書面許可，不可部份複製。

This document is issued by the Company subject to its General Conditions of Service printed overleaf, available on request or accessible at <http://www.sgs.com.tw/Terms-and-Conditions> and for electronic format documents, subject to Terms and Conditions for Electronic Documents at <http://www.sgs.com.tw/Terms-and-Conditions>. Attention is drawn to the limitation of liability, indemnification and jurisdiction issues defined therein. Any holder of this document is advised that information contained hereon reflects the Company's findings at the time of its intervention only and within the limits of Client's instructions, if any. The Company's sole responsibility is to its Client and this document does not exonerate parties to a transaction from exercising all their rights and obligations under the transaction documents. This document cannot be reproduced except in full, without prior written approval of the Company. Any unauthorized alteration, forgery or falsification of the content or appearance of this document is unlawful and offenders may be prosecuted to the fullest extent of the law.

Report Number :TERF2404000927E2  
 Operation Mode :802.11a  
 Test Frequency :5500 MHz  
 Test Mode :Bandedge  
 EUT Pol :E2 Plane

Test Site :SAC G Chamber  
 Test Date :2024-04-24  
 Temp./Humi. :22.1°C/57%  
 Antenna Pol. :Horizontal  
 Engineer :Temo Chen

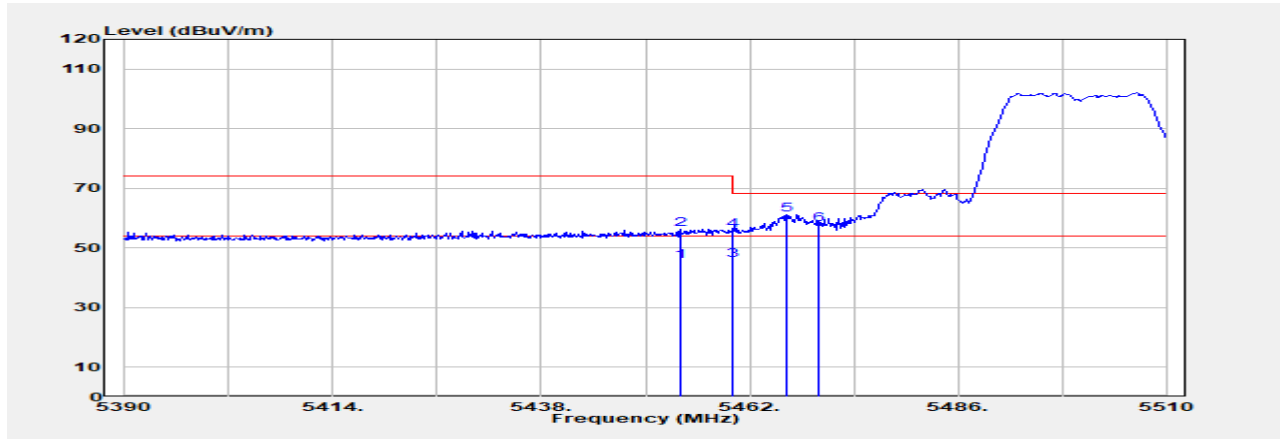

Freq. MHz	Detector Mode PK/QP/AVG	Spectrum Reading Level dBμV	Factor dB	Actual FS dBμV/m	Limit @3m dBμV/m	Margin dB
5453.960	Average	39.91	5.66	45.57	54.00	-8.43
5453.960	Peak	50.60	5.66	56.25	74.00	-17.75
5460.000	Average	40.24	5.71	45.96	54.00	-8.04
5460.000	Peak	50.08	5.71	55.79	74.00	-18.21
5466.320	Peak	55.39	5.77	61.16	68.20	-7.04
5470.000	Peak	52.06	5.81	57.87	68.20	-10.33

Unless otherwise stated the results shown in this test report refer only to the sample(s) tested and such sample(s) are retained for 90 days only.

除非另有說明，此報告結果僅對測試之樣品負責，同時此樣品僅保留90天。本報告未經本公司書面許可，不可部份複製。

This document is issued by the Company subject to its General Conditions of Service printed overleaf, available on request or accessible at <http://www.sgs.com.tw/Terms-and-Conditions> and for electronic format documents, subject to Terms and Conditions for Electronic Documents at <http://www.sgs.com.tw/Terms-and-Conditions>. Attention is drawn to the limitation of liability, indemnification and jurisdiction issues defined therein. Any holder of this document is advised that information contained hereon reflects the Company's findings at the time of its intervention only and within the limits of Client's instructions, if any. The Company's sole responsibility is to its Client and this document does not exonerate parties to a transaction from exercising all their rights and obligations under the transaction documents. This document cannot be reproduced except in full, without prior written approval of the Company. Any unauthorized alteration, forgery or falsification of the content or appearance of this document is unlawful and offenders may be prosecuted to the fullest extent of the law.

Report Number :TERF2404000927E2  
 Operation Mode :802.11a  
 Test Frequency :5700 MHz  
 Test Mode :Bandedge  
 EUT Pol :E2 Plane

Test Site :SAC G Chamber  
 Test Date :2024-05-10  
 Temp./Humi. :24.0°C/51%  
 Antenna Pol. :Vertical  
 Engineer :Temo Chen

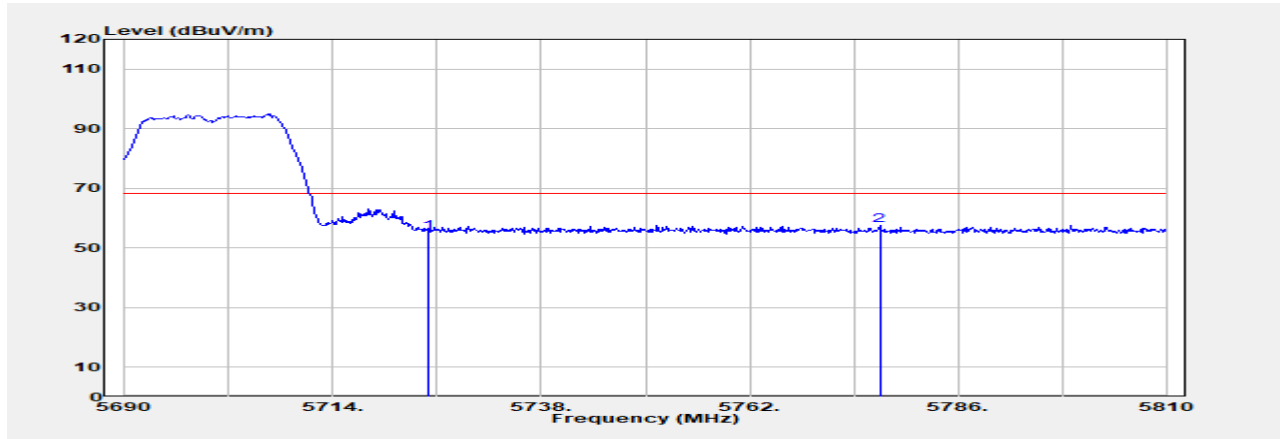

Freq. MHz	Detector Mode PK/QP/AVG	Spectrum Reading Level dB $\mu$ V	Factor dB	Actual FS dB $\mu$ V/m	Limit @3m dB $\mu$ V/m	Margin dB
5725.000	Peak	48.76	6.67	55.43	68.20	-12.77
5777.000	Peak	50.67	6.93	57.60	68.20	-10.60

Unless otherwise stated the results shown in this test report refer only to the sample(s) tested and such sample(s) are retained for 90 days only.

除非另有說明，此報告結果僅對測試之樣品負責，同時此樣品僅保留90天。本報告未經本公司書面許可，不可部份複製。

This document is issued by the Company subject to its General Conditions of Service printed overleaf, available on request or accessible at <http://www.sgs.com.tw/Terms-and-Conditions> and for electronic format documents, subject to Terms and Conditions for Electronic Documents at <http://www.sgs.com.tw/Terms-and-Conditions>. Attention is drawn to the limitation of liability, indemnification and jurisdiction issues defined therein. Any holder of this document is advised that information contained hereon reflects the Company's findings at the time of its intervention only and within the limits of Client's instructions, if any. The Company's sole responsibility is to its Client and this document does not exonerate parties to a transaction from exercising all their rights and obligations under the transaction documents. This document cannot be reproduced except in full, without prior written approval of the Company. Any unauthorized alteration, forgery or falsification of the content or appearance of this document is unlawful and offenders may be prosecuted to the fullest extent of the law.

Report Number :TERF2404000927E2  
 Operation Mode :802.11a  
 Test Frequency :5700 MHz  
 Test Mode :Bandedge  
 EUT Pol :E2 Plane

Test Site :SAC G Chamber  
 Test Date :2024-05-10  
 Temp./Humi. :24.0°C/51%  
 Antenna Pol. :Horizontal  
 Engineer :Temo Chen

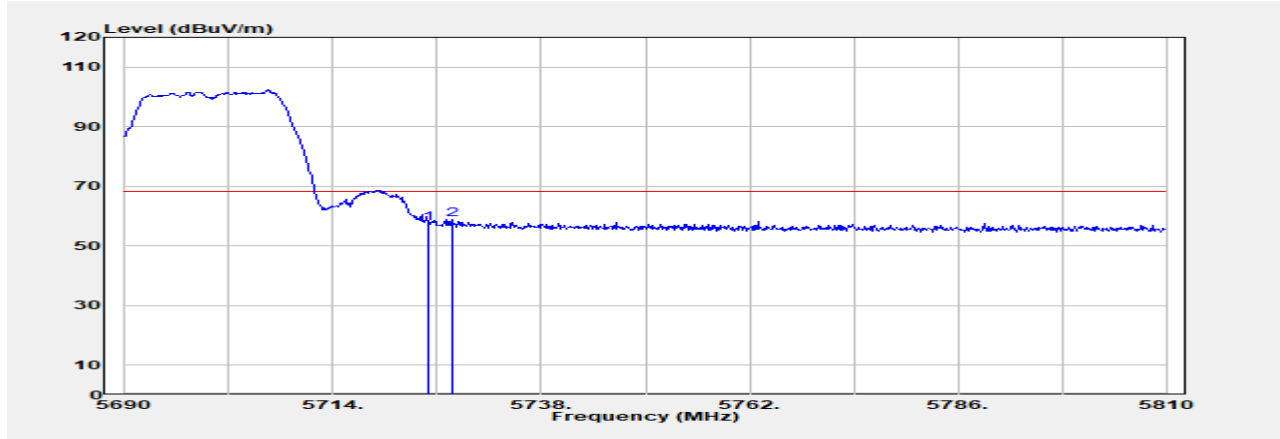

Freq. MHz	Detector Mode PK/QP/AVG	Spectrum Reading Level dB $\mu$ V	Factor dB	Actual FS dB $\mu$ V/m	Limit @3m dB $\mu$ V/m	Margin dB
5725.000	Peak	50.75	6.67	57.42	68.20	-10.78
5727.680	Peak	52.06	6.69	58.74	68.20	-9.46

Unless otherwise stated the results shown in this test report refer only to the sample(s) tested and such sample(s) are retained for 90 days only.

除非另有說明，此報告結果僅對測試之樣品負責，同時此樣品僅保留90天。本報告未經本公司書面許可，不可部份複製。

This document is issued by the Company subject to its General Conditions of Service printed overleaf, available on request or accessible at <http://www.sgs.com.tw/Terms-and-Conditions> and for electronic format documents, subject to Terms and Conditions for Electronic Documents at <http://www.sgs.com.tw/Terms-and-Conditions>. Attention is drawn to the limitation of liability, indemnification and jurisdiction issues defined therein. Any holder of this document is advised that information contained hereon reflects the Company's findings at the time of its intervention only and within the limits of Client's instructions, if any. The Company's sole responsibility is to its Client and this document does not exonerate parties to a transaction from exercising all their rights and obligations under the transaction documents. This document cannot be reproduced except in full, without prior written approval of the Company. Any unauthorized alteration, forgery or falsification of the content or appearance of this document is unlawful and offenders may be prosecuted to the fullest extent of the law.

Report Number :TERF2404000927E2  
 Operation Mode :802.11a  
 Test Frequency :5720 MHz  
 Test Mode :Bandedge  
 EUT Pol :E2 Plane

Test Site :SAC G Chamber  
 Test Date :2024-04-24  
 Temp./Humi. :22.1°C/57%  
 Antenna Pol. :Vertical  
 Engineer :Temo Chen

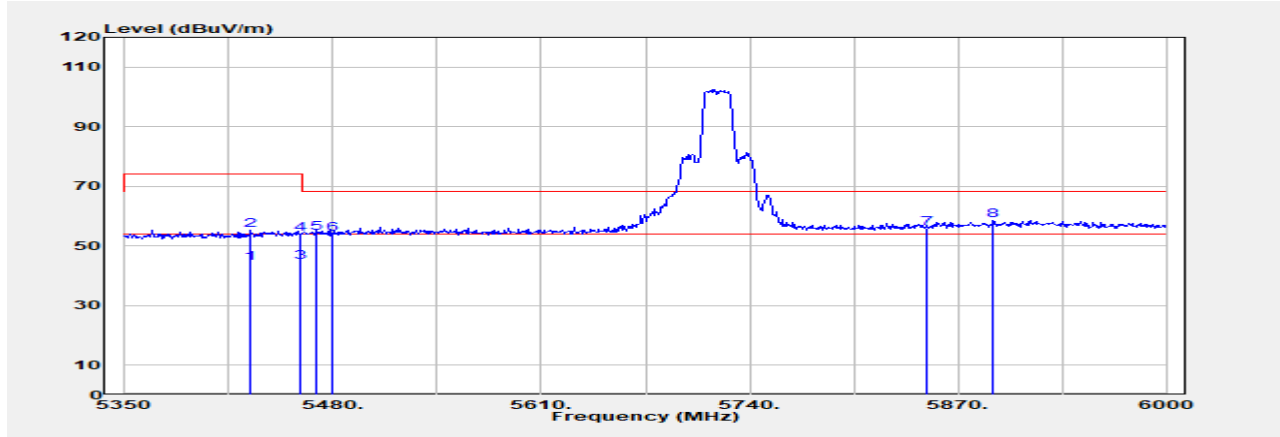

Freq. MHz	Detector Mode PK/QP/AVG	Spectrum Reading Level dBμV	Factor dB	Actual FS dBUV/m	Limit @3m dBUV/m	Margin dB
5428.650	Average	38.95	5.38	44.33	54.00	-9.67
5428.650	Peak	49.91	5.38	55.30	74.00	-18.70
5460.000	Average	38.97	5.71	44.68	54.00	-9.32
5460.000	Peak	48.12	5.71	53.83	74.00	-20.17
5470.000	Peak	48.46	5.81	54.27	68.20	-13.93
5480.000	Peak	48.23	5.90	54.13	68.20	-14.07
5850.000	Peak	48.20	7.71	55.91	68.20	-12.29
5892.100	Peak	50.30	8.38	58.68	68.20	-9.52

Unless otherwise stated the results shown in this test report refer only to the sample(s) tested and such sample(s) are retained for 90 days only.

除非另有說明，此報告結果僅對測試之樣品負責，同時此樣品僅保留90天。本報告未經本公司書面許可，不可部份複製。

This document is issued by the Company subject to its General Conditions of Service printed overleaf, available on request or accessible at <http://www.sgs.com.tw/Terms-and-Conditions> and for electronic format documents, subject to Terms and Conditions for Electronic Documents at <http://www.sgs.com.tw/Terms-and-Conditions>. Attention is drawn to the limitation of liability, indemnification and jurisdiction issues defined therein. Any holder of this document is advised that information contained hereon reflects the Company's findings at the time of its intervention only and within the limits of Client's instructions, if any. The Company's sole responsibility is to its Client and this document does not exonerate parties to a transaction from exercising all their rights and obligations under the transaction documents. This document cannot be reproduced except in full, without prior written approval of the Company. Any unauthorized alteration, forgery or falsification of the content or appearance of this document is unlawful and offenders may be prosecuted to the fullest extent of the law.

Report Number :TERF2404000927E2  
 Operation Mode :802.11a  
 Test Frequency :5720 MHz  
 Test Mode :Bandedge  
 EUT Pol :E2 Plane

Test Site :SAC G Chamber  
 Test Date :2024-04-24  
 Temp./Humi. :22.1°C/57%  
 Antenna Pol. :Horizontal  
 Engineer :Temo Chen

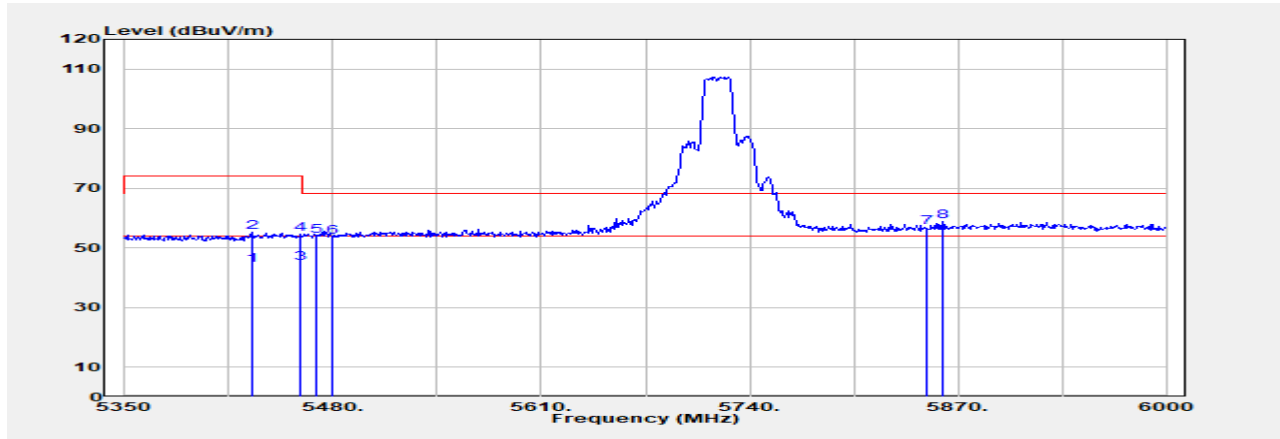

Freq. MHz	Detector Mode PK/QP/AVG	Spectrum Reading Level dBμV	Factor dB	Actual FS dBUV/m	Limit @3m dBUV/m	Margin dB
5429.300	Average	38.92	5.39	44.31	54.00	-9.69
5429.300	Peak	49.75	5.39	55.14	74.00	-18.86
5460.000	Average	39.03	5.71	44.74	54.00	-9.26
5460.000	Peak	49.06	5.71	54.78	74.00	-19.22
5470.000	Peak	48.19	5.81	53.99	68.20	-14.21
5480.000	Peak	47.62	5.90	53.51	68.20	-14.69
5850.000	Peak	49.22	7.71	56.92	68.20	-11.28
5860.250	Peak	51.08	7.87	58.95	68.20	-9.25

Unless otherwise stated the results shown in this test report refer only to the sample(s) tested and such sample(s) are retained for 90 days only.

除非另有說明，此報告結果僅對測試之樣品負責，同時此樣品僅保留90天。本報告未經本公司書面許可，不可部份複製。

This document is issued by the Company subject to its General Conditions of Service printed overleaf, available on request or accessible at <http://www.sgs.com.tw/Terms-and-Conditions> and for electronic format documents, subject to Terms and Conditions for Electronic Documents at <http://www.sgs.com.tw/Terms-and-Conditions>. Attention is drawn to the limitation of liability, indemnification and jurisdiction issues defined therein. Any holder of this document is advised that information contained hereon reflects the Company's findings at the time of its intervention only and within the limits of Client's instructions, if any. The Company's sole responsibility is to its Client and this document does not exonerate parties to a transaction from exercising all their rights and obligations under the transaction documents. This document cannot be reproduced except in full, without prior written approval of the Company. Any unauthorized alteration, forgery or falsification of the content or appearance of this document is unlawful and offenders may be prosecuted to the fullest extent of the law.

Report Number :TERF2404000927E2  
 Operation Mode :802.11a  
 Test Frequency :5745 MHz  
 Test Mode :Bandedge  
 EUT Pol :E2 Plane

Test Site :SAC G Chamber  
 Test Date :2024-04-24  
 Temp./Humi. :22.1°C/57%  
 Antenna Pol. :Vertical  
 Engineer :Temo Chen

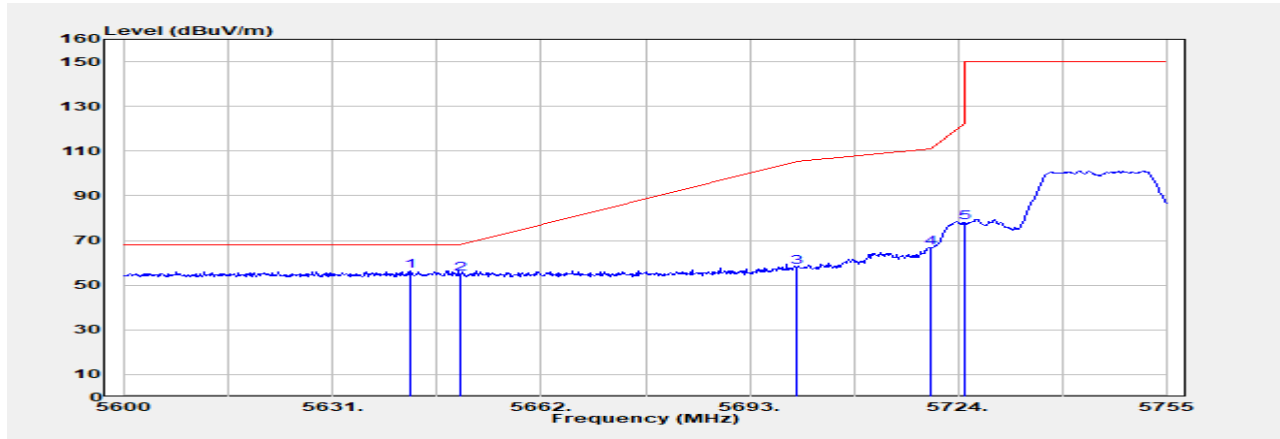

Freq. MHz	Detector Mode PK/QP/AVG	Spectrum Reading Level dBμV	Factor dB	Actual FS dBμV/m	Limit @3m dBμV/m	Margin dB
5642.625	Peak	50.45	5.97	56.43	68.20	-11.77
5650.000	Peak	49.20	6.03	55.23	68.20	-12.97
5700.000	Peak	51.56	6.49	58.05	105.20	-47.15
5720.000	Peak	60.02	6.63	66.65	110.80	-44.15
5725.000	Peak	71.30	6.67	77.97	122.20	-44.23

Unless otherwise stated the results shown in this test report refer only to the sample(s) tested and such sample(s) are retained for 90 days only.

除非另有說明，此報告結果僅對測試之樣品負責，同時此樣品僅保留90天。本報告未經本公司書面許可，不可部份複製。

This document is issued by the Company subject to its General Conditions of Service printed overleaf, available on request or accessible at <http://www.sgs.com.tw/Terms-and-Conditions> and for electronic format documents, subject to Terms and Conditions for Electronic Documents at <http://www.sgs.com.tw/Terms-and-Conditions>. Attention is drawn to the limitation of liability, indemnification and jurisdiction issues defined therein. Any holder of this document is advised that information contained hereon reflects the Company's findings at the time of its intervention only and within the limits of Client's instructions, if any. The Company's sole responsibility is to its Client and this document does not exonerate parties to a transaction from exercising all their rights and obligations under the transaction documents. This document cannot be reproduced except in full, without prior written approval of the Company. Any unauthorized alteration, forgery or falsification of the content or appearance of this document is unlawful and offenders may be prosecuted to the fullest extent of the law.



Report Number :TERF2404000927E2  
 Operation Mode :802.11a  
 Test Frequency :5745 MHz  
 Test Mode :Bandedge  
 EUT Pol :E2 Plane

Test Site :SAC G Chamber  
 Test Date :2024-04-24  
 Temp./Humi. :22.1°C/57%  
 Antenna Pol. :Horizontal  
 Engineer :Temo Chen

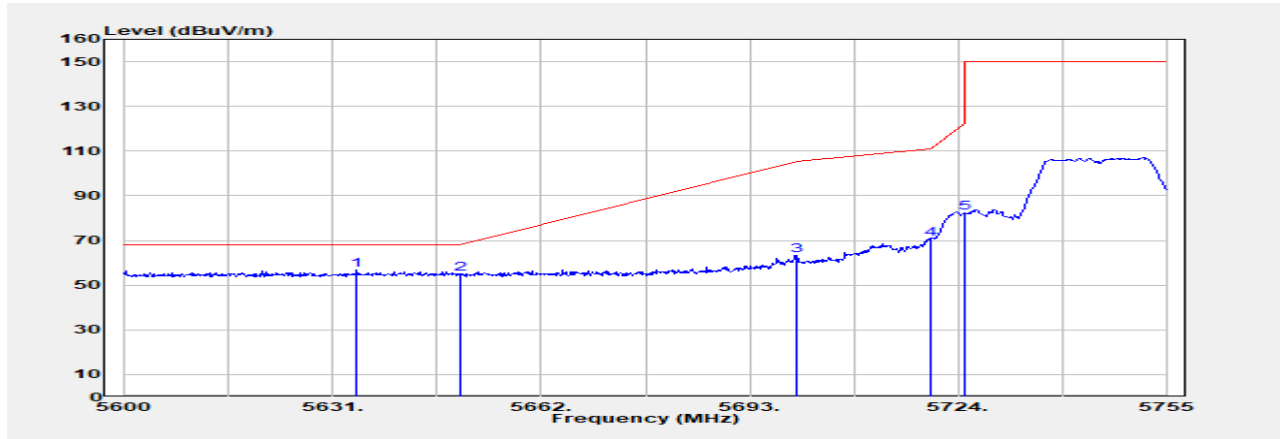

Freq. MHz	Detector Mode PK/QP/AVG	Spectrum Reading Level dBμV	Factor dB	Actual FS dBμV/m	Limit @3m dBμV/m	Margin dB
5634.565	Peak	50.74	5.91	56.65	68.20	-11.55
5650.000	Peak	48.86	6.03	54.89	68.20	-13.31
5700.000	Peak	56.82	6.49	63.31	105.20	-41.89
5720.000	Peak	63.85	6.63	70.48	110.80	-40.32
5725.000	Peak	75.52	6.67	82.19	122.20	-40.01

Unless otherwise stated the results shown in this test report refer only to the sample(s) tested and such sample(s) are retained for 90 days only.

除非另有說明，此報告結果僅對測試之樣品負責，同時此樣品僅保留90天。本報告未經本公司書面許可，不可部份複製。

This document is issued by the Company subject to its General Conditions of Service printed overleaf, available on request or accessible at <http://www.sgs.com.tw/Terms-and-Conditions> and for electronic format documents, subject to Terms and Conditions for Electronic Documents at <http://www.sgs.com.tw/Terms-and-Conditions>. Attention is drawn to the limitation of liability, indemnification and jurisdiction issues defined therein. Any holder of this document is advised that information contained hereon reflects the Company's findings at the time of its intervention only and within the limits of Client's instructions, if any. The Company's sole responsibility is to its Client and this document does not exonerate parties to a transaction from exercising all their rights and obligations under the transaction documents. This document cannot be reproduced except in full, without prior written approval of the Company. Any unauthorized alteration, forgery or falsification of the content or appearance of this document is unlawful and offenders may be prosecuted to the fullest extent of the law.

Report Number :TERF2404000927E2  
 Operation Mode :802.11a  
 Test Frequency :5825 MHz  
 Test Mode :Bandedge  
 EUT Pol :E2 Plane

Test Site :SAC G Chamber  
 Test Date :2024-04-24  
 Temp./Humi. :22.1°C/57%  
 Antenna Pol. :Vertical  
 Engineer :Temo Chen

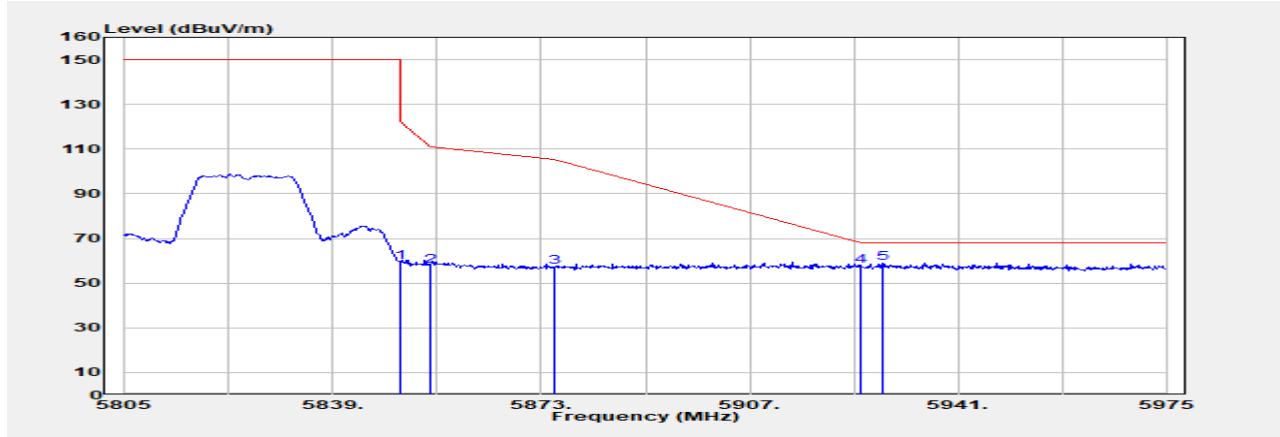

Freq. MHz	Detector Mode PK/QP/AVG	Spectrum Reading Level dB $\mu$ V	Factor dB	Actual FS dB $\mu$ V/m	Limit @3m dB $\mu$ V/m	Margin dB
5850.000	Peak	51.68	7.71	59.39	122.20	-62.81
5855.000	Peak	49.74	7.79	57.53	110.80	-53.27
5875.000	Peak	49.32	8.11	57.43	105.20	-47.77
5925.000	Peak	49.20	8.37	57.57	68.20	-10.63
5928.590	Peak	50.64	8.35	58.99	68.20	-9.21

Unless otherwise stated the results shown in this test report refer only to the sample(s) tested and such sample(s) are retained for 90 days only.

除非另有說明，此報告結果僅對測試之樣品負責，同時此樣品僅保留90天。本報告未經本公司書面許可，不可部份複製。

This document is issued by the Company subject to its General Conditions of Service printed overleaf, available on request or accessible at <http://www.sgs.com.tw/Terms-and-Conditions> and for electronic format documents, subject to Terms and Conditions for Electronic Documents at <http://www.sgs.com.tw/Terms-and-Conditions>. Attention is drawn to the limitation of liability, indemnification and jurisdiction issues defined therein. Any holder of this document is advised that information contained hereon reflects the Company's findings at the time of its intervention only and within the limits of Client's instructions, if any. The Company's sole responsibility is to its Client and this document does not exonerate parties to a transaction from exercising all their rights and obligations under the transaction documents. This document cannot be reproduced except in full, without prior written approval of the Company. Any unauthorized alteration, forgery or falsification of the content or appearance of this document is unlawful and offenders may be prosecuted to the fullest extent of the law.

Report Number :TERF2404000927E2  
 Operation Mode :802.11a  
 Test Frequency :5825 MHz  
 Test Mode :Bandedge  
 EUT Pol :E2 Plane

Test Site :SAC G Chamber  
 Test Date :2024-04-24  
 Temp./Humi. :22.1°C/57%  
 Antenna Pol. :Horizontal  
 Engineer :Temo Chen

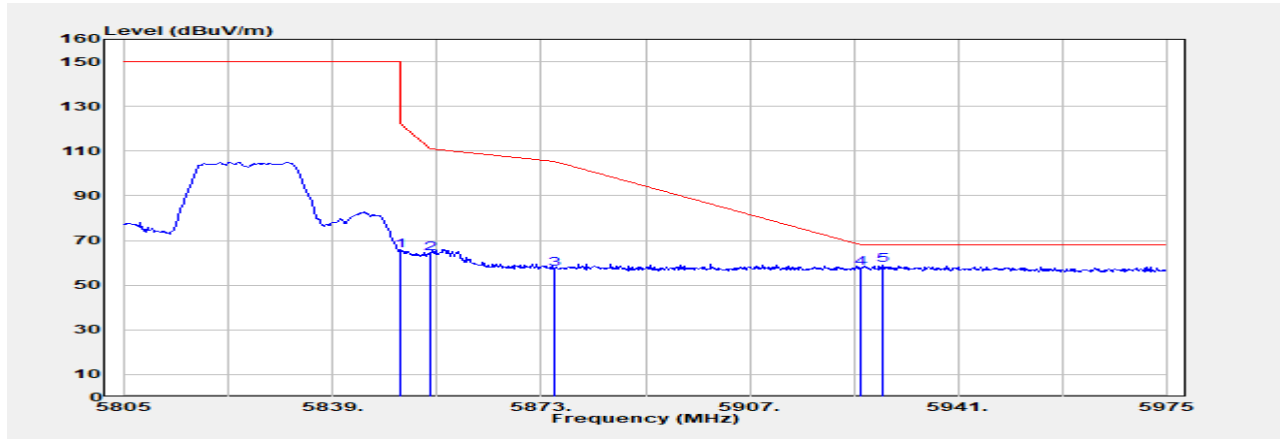

Freq. MHz	Detector Mode PK/QP/AVG	Spectrum Reading Level dB $\mu$ V	Factor dB	Actual FS dB $\mu$ V/m	Limit @3m dB $\mu$ V/m	Margin dB
5850.000	Peak	57.61	7.71	65.32	122.20	-56.88
5855.000	Peak	56.31	7.79	64.10	110.80	-46.70
5875.000	Peak	49.09	8.11	57.20	105.20	-48.00
5925.000	Peak	49.10	8.37	57.46	68.20	-10.74
5928.590	Peak	50.43	8.35	58.78	68.20	-9.42

Unless otherwise stated the results shown in this test report refer only to the sample(s) tested and such sample(s) are retained for 90 days only.

除非另有說明，此報告結果僅對測試之樣品負責，同時此樣品僅保留90天。本報告未經本公司書面許可，不可部份複製。

This document is issued by the Company subject to its General Conditions of Service printed overleaf, available on request or accessible at <http://www.sgs.com.tw/Terms-and-Conditions> and for electronic format documents, subject to Terms and Conditions for Electronic Documents at <http://www.sgs.com.tw/Terms-and-Conditions>. Attention is drawn to the limitation of liability, indemnification and jurisdiction issues defined therein. Any holder of this document is advised that information contained hereon reflects the Company's findings at the time of its intervention only and within the limits of Client's instructions, if any. The Company's sole responsibility is to its Client and this document does not exonerate parties to a transaction from exercising all their rights and obligations under the transaction documents. This document cannot be reproduced except in full, without prior written approval of the Company. Any unauthorized alteration, forgery or falsification of the content or appearance of this document is unlawful and offenders may be prosecuted to the fullest extent of the law.

Report Number :TERF2404000927E2  
 Operation Mode :802.11n20  
 Test Frequency :5180 MHz  
 Test Mode :Bandedge  
 EUT Pol :E2 Plane

Test Site :SAC G Chamber  
 Test Date :2024-05-10  
 Temp./Humi. :24.0°C/51%  
 Antenna Pol. :Vertical  
 Engineer :Temo Chen

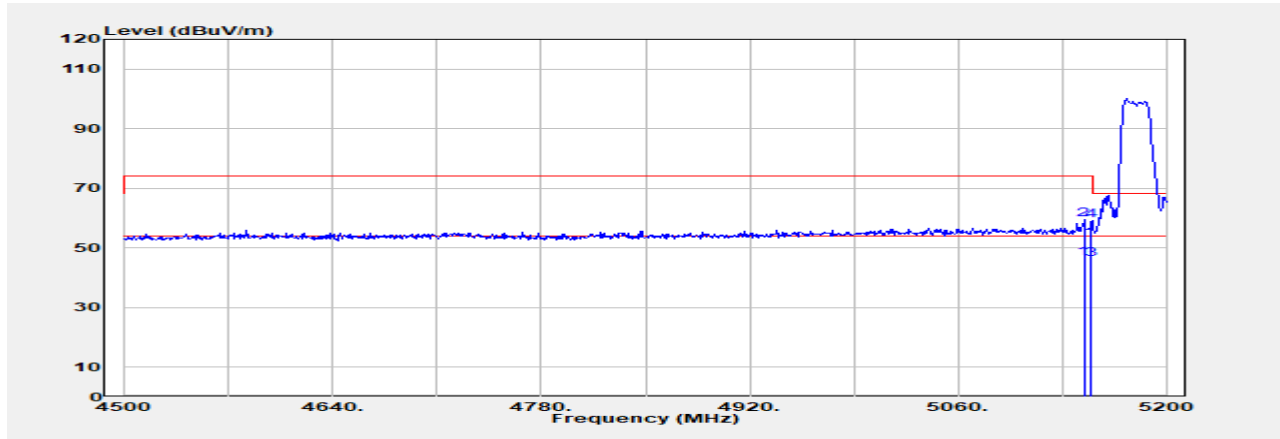

Freq. MHz	Detector Mode PK/QP/AVG	Spectrum Reading Level dBμV	Factor dB	Actual FS dBμV/m	Limit @3m dBμV/m	Margin dB
5144.700	Average	40.99	5.46	46.44	54.00	-7.56
5144.700	Peak	53.98	5.46	59.44	74.00	-14.56
5150.000	Average	40.78	5.42	46.20	54.00	-7.80
5150.000	Peak	53.76	5.42	59.19	74.00	-14.81

Unless otherwise stated the results shown in this test report refer only to the sample(s) tested and such sample(s) are retained for 90 days only.

除非另有說明，此報告結果僅對測試之樣品負責，同時此樣品僅保留90天。本報告未經本公司書面許可，不可部份複製。

This document is issued by the Company subject to its General Conditions of Service printed overleaf, available on request or accessible at <http://www.sgs.com.tw/Terms-and-Conditions> and for electronic format documents, subject to Terms and Conditions for Electronic Documents at <http://www.sgs.com.tw/Terms-and-Conditions>. Attention is drawn to the limitation of liability, indemnification and jurisdiction issues defined therein. Any holder of this document is advised that information contained hereon reflects the Company's findings at the time of its intervention only and within the limits of Client's instructions, if any. The Company's sole responsibility is to its Client and this document does not exonerate parties to a transaction from exercising all their rights and obligations under the transaction documents. This document cannot be reproduced except in full, without prior written approval of the Company. Any unauthorized alteration, forgery or falsification of the content or appearance of this document is unlawful and offenders may be prosecuted to the fullest extent of the law.

Report Number :TERF2404000927E2  
 Operation Mode :802.11n20  
 Test Frequency :5180 MHz  
 Test Mode :Bandedge  
 EUT Pol :E2 Plane

Test Site :SAC G Chamber  
 Test Date :2024-05-10  
 Temp./Humi. :24.0°C/51%  
 Antenna Pol. :Horizontal  
 Engineer :Temo Chen

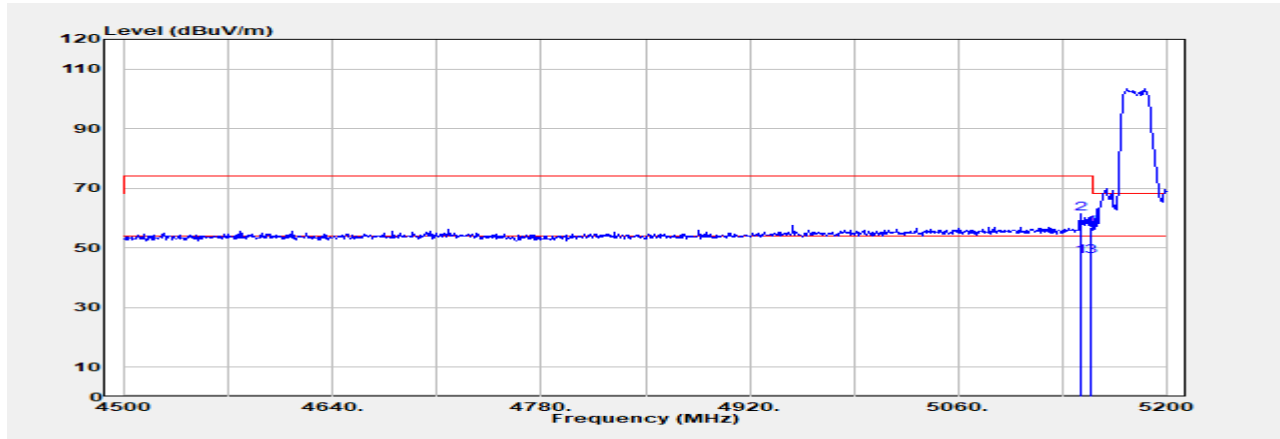

Freq. MHz	Detector Mode PK/QP/AVG	Spectrum Reading Level dB $\mu$ V	Factor dB	Actual FS dB $\mu$ V/m	Limit @3m dB $\mu$ V/m	Margin dB
5142.600	Average	41.61	5.47	47.08	54.00	-6.92
5142.600	Peak	55.84	5.47	61.31	74.00	-12.69
5150.000	Average	41.81	5.42	47.24	54.00	-6.76
5150.000	Peak	51.39	5.42	56.81	74.00	-17.19

Unless otherwise stated the results shown in this test report refer only to the sample(s) tested and such sample(s) are retained for 90 days only.

除非另有說明，此報告結果僅對測試之樣品負責，同時此樣品僅保留90天。本報告未經本公司書面許可，不可部份複製。

This document is issued by the Company subject to its General Conditions of Service printed overleaf, available on request or accessible at <http://www.sgs.com.tw/Terms-and-Conditions> and for electronic format documents, subject to Terms and Conditions for Electronic Documents at <http://www.sgs.com.tw/Terms-and-Conditions>. Attention is drawn to the limitation of liability, indemnification and jurisdiction issues defined therein. Any holder of this document is advised that information contained hereon reflects the Company's findings at the time of its intervention only and within the limits of Client's instructions, if any. The Company's sole responsibility is to its Client and this document does not exonerate parties to a transaction from exercising all their rights and obligations under the transaction documents. This document cannot be reproduced except in full, without prior written approval of the Company. Any unauthorized alteration, forgery or falsification of the content or appearance of this document is unlawful and offenders may be prosecuted to the fullest extent of the law.

Report Number :TERF2404000927E2  
 Operation Mode :802.11n20  
 Test Frequency :5320 MHz  
 Test Mode :Bandedge  
 EUT Pol :E2 Plane

Test Site :SAC G Chamber  
 Test Date :2024-04-25  
 Temp./Humi. :23.0°C/59%  
 Antenna Pol. :Vertical  
 Engineer :Temo Chen

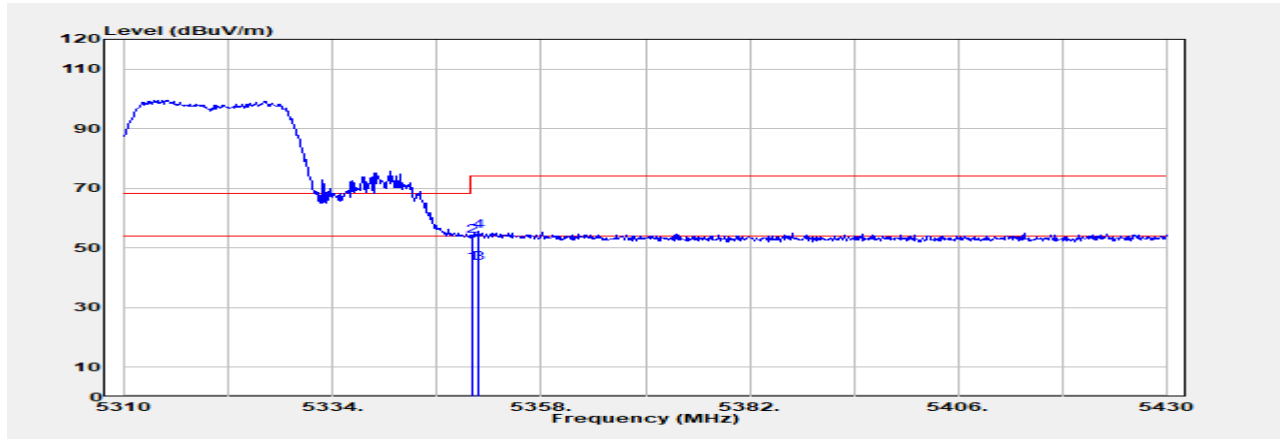

Freq. MHz	Detector Mode PK/QP/AVG	Spectrum Reading Level dBμV	Factor dB	Actual FS dBμV/m	Limit @3m dBμV/m	Margin dB
5350.000	Average	39.76	5.04	44.80	54.00	-9.20
5350.000	Peak	49.02	5.04	54.06	74.00	-19.94
5350.680	Average	39.77	5.04	44.81	54.00	-9.19
5350.680	Peak	50.62	5.04	55.66	74.00	-18.34

Unless otherwise stated the results shown in this test report refer only to the sample(s) tested and such sample(s) are retained for 90 days only.

除非另有說明，此報告結果僅對測試之樣品負責，同時此樣品僅保留90天。本報告未經本公司書面許可，不可部份複製。

This document is issued by the Company subject to its General Conditions of Service printed overleaf, available on request or accessible at <http://www.sgs.com.tw/Terms-and-Conditions> and for electronic format documents, subject to Terms and Conditions for Electronic Documents at <http://www.sgs.com.tw/Terms-and-Conditions>. Attention is drawn to the limitation of liability, indemnification and jurisdiction issues defined therein. Any holder of this document is advised that information contained hereon reflects the Company's findings at the time of its intervention only and within the limits of Client's instructions, if any. The Company's sole responsibility is to its Client and this document does not exonerate parties to a transaction from exercising all their rights and obligations under the transaction documents. This document cannot be reproduced except in full, without prior written approval of the Company. Any unauthorized alteration, forgery or falsification of the content or appearance of this document is unlawful and offenders may be prosecuted to the fullest extent of the law.

Report Number :TERF2404000927E2  
 Operation Mode :802.11n20  
 Test Frequency :5320 MHz  
 Test Mode :Bandedge  
 EUT Pol :E2 Plane

Test Site :SAC G Chamber  
 Test Date :2024-04-25  
 Temp./Humi. :23.0°C/59%  
 Antenna Pol. :Horizontal  
 Engineer :Temo Chen

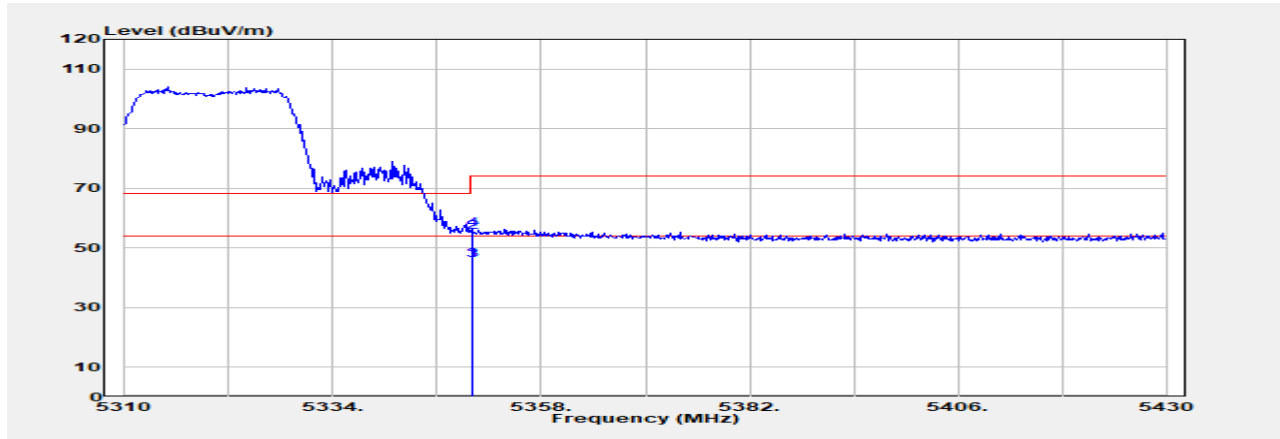

Freq. MHz	Detector Mode PK/QP/AVG	Spectrum Reading Level dB $\mu$ V	Factor dB	Actual FS dB $\mu$ V/m	Limit @3m dB $\mu$ V/m	Margin dB
5350.000	Average	40.78	5.04	45.82	54.00	-8.18
5350.000	Peak	50.33	5.04	55.37	74.00	-18.63
5350.080	Average	40.77	5.04	45.81	54.00	-8.19
5350.080	Peak	51.27	5.04	56.31	74.00	-17.69

Unless otherwise stated the results shown in this test report refer only to the sample(s) tested and such sample(s) are retained for 90 days only.

除非另有說明，此報告結果僅對測試之樣品負責，同時此樣品僅保留90天。本報告未經本公司書面許可，不可部份複製。

This document is issued by the Company subject to its General Conditions of Service printed overleaf, available on request or accessible at <http://www.sgs.com.tw/Terms-and-Conditions> and for electronic format documents, subject to Terms and Conditions for Electronic Documents at <http://www.sgs.com.tw/Terms-and-Conditions>. Attention is drawn to the limitation of liability, indemnification and jurisdiction issues defined therein. Any holder of this document is advised that information contained hereon reflects the Company's findings at the time of its intervention only and within the limits of Client's instructions, if any. The Company's sole responsibility is to its Client and this document does not exonerate parties to a transaction from exercising all their rights and obligations under the transaction documents. This document cannot be reproduced except in full, without prior written approval of the Company. Any unauthorized alteration, forgery or falsification of the content or appearance of this document is unlawful and offenders may be prosecuted to the fullest extent of the law.

Report Number :TERF2404000927E2  
 Operation Mode :802.11n20  
 Test Frequency :5500 MHz  
 Test Mode :Bandedge  
 EUT Pol :E2 Plane

Test Site :SAC G Chamber  
 Test Date :2024-05-10  
 Temp./Humi. :24.0°C/51%  
 Antenna Pol. :Vertical  
 Engineer :Temo Chen

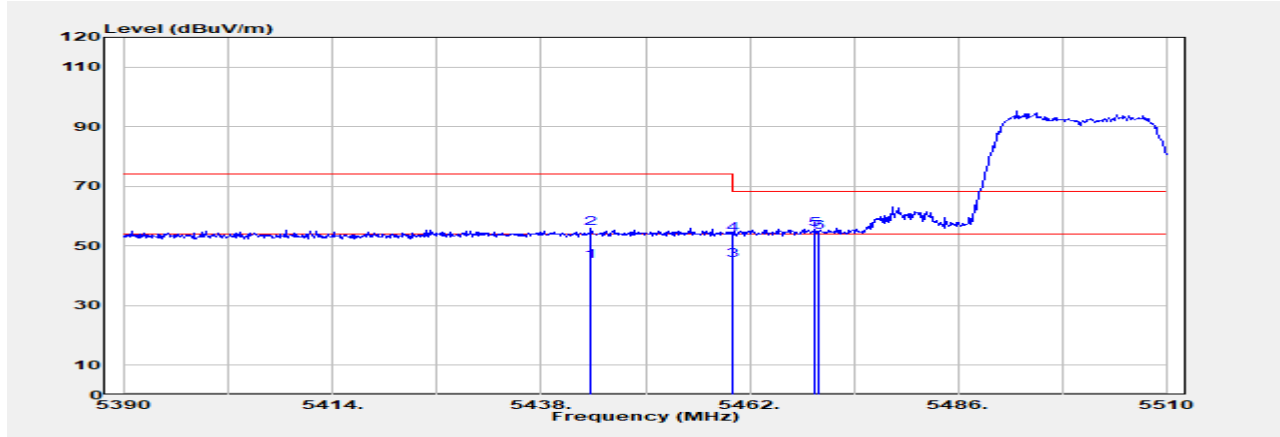

Freq. MHz	Detector Mode PK/QP/AVG	Spectrum Reading Level dBμV	Factor dB	Actual FS dBμV/m	Limit @3m dBμV/m	Margin dB
5443.760	Average	39.20	5.55	44.75	54.00	-9.25
5443.760	Peak	50.29	5.55	55.84	74.00	-18.16
5460.000	Average	39.37	5.71	45.09	54.00	-8.91
5460.000	Peak	48.26	5.71	53.98	74.00	-20.02
5469.560	Peak	49.81	5.80	55.61	68.20	-12.59
5470.000	Peak	48.79	5.81	54.60	68.20	-13.60

Unless otherwise stated the results shown in this test report refer only to the sample(s) tested and such sample(s) are retained for 90 days only.

除非另有說明，此報告結果僅對測試之樣品負責，同時此樣品僅保留90天。本報告未經本公司書面許可，不可部份複製。

This document is issued by the Company subject to its General Conditions of Service printed overleaf, available on request or accessible at <http://www.sgs.com.tw/Terms-and-Conditions> and for electronic format documents, subject to Terms and Conditions for Electronic Documents at <http://www.sgs.com.tw/Terms-and-Conditions>. Attention is drawn to the limitation of liability, indemnification and jurisdiction issues defined therein. Any holder of this document is advised that information contained hereon reflects the Company's findings at the time of its intervention only and within the limits of Client's instructions, if any. The Company's sole responsibility is to its Client and this document does not exonerate parties to a transaction from exercising all their rights and obligations under the transaction documents. This document cannot be reproduced except in full, without prior written approval of the Company. Any unauthorized alteration, forgery or falsification of the content or appearance of this document is unlawful and offenders may be prosecuted to the fullest extent of the law.



Report Number :TERF2404000927E2  
 Operation Mode :802.11n20  
 Test Frequency :5500 MHz  
 Test Mode :Bandedge  
 EUT Pol :E2 Plane

Test Site :SAC G Chamber  
 Test Date :2024-05-10  
 Temp./Humi. :24.0°C/51%  
 Antenna Pol. :Horizontal  
 Engineer :Temo Chen

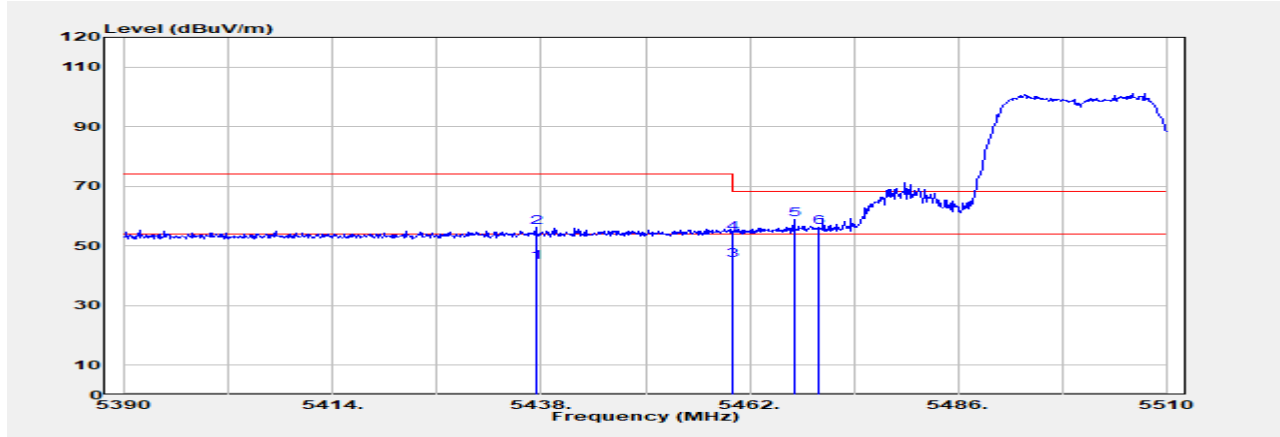

Freq. MHz	Detector Mode PK/QP/AVG	Spectrum Reading Level dBμV	Factor dB	Actual FS dBμV/m	Limit @3m dBμV/m	Margin dB
5437.400	Average	39.15	5.48	44.63	54.00	-9.37
5437.400	Peak	50.84	5.48	56.32	74.00	-17.68
5460.000	Average	39.64	5.71	45.36	54.00	-8.64
5460.000	Peak	48.50	5.71	54.22	74.00	-19.78
5467.160	Peak	53.08	5.78	58.86	68.20	-9.34
5470.000	Peak	50.31	5.81	56.12	68.20	-12.08

Unless otherwise stated the results shown in this test report refer only to the sample(s) tested and such sample(s) are retained for 90 days only.

除非另有說明，此報告結果僅對測試之樣品負責，同時此樣品僅保留90天。本報告未經本公司書面許可，不可部份複製。

This document is issued by the Company subject to its General Conditions of Service printed overleaf, available on request or accessible at <http://www.sgs.com.tw/Terms-and-Conditions> and for electronic format documents, subject to Terms and Conditions for Electronic Documents at <http://www.sgs.com.tw/Terms-and-Conditions>. Attention is drawn to the limitation of liability, indemnification and jurisdiction issues defined therein. Any holder of this document is advised that information contained hereon reflects the Company's findings at the time of its intervention only and within the limits of Client's instructions, if any. The Company's sole responsibility is to its Client and this document does not exonerate parties to a transaction from exercising all their rights and obligations under the transaction documents. This document cannot be reproduced except in full, without prior written approval of the Company. Any unauthorized alteration, forgery or falsification of the content or appearance of this document is unlawful and offenders may be prosecuted to the fullest extent of the law.

Report Number :TERF2404000927E2  
 Operation Mode :802.11n20  
 Test Frequency :5700 MHz  
 Test Mode :Bandedge  
 EUT Pol :E2 Plane

Test Site :SAC G Chamber  
 Test Date :2024-05-10  
 Temp./Humi. :24.0°C/51%  
 Antenna Pol. :Vertical  
 Engineer :Temo Chen

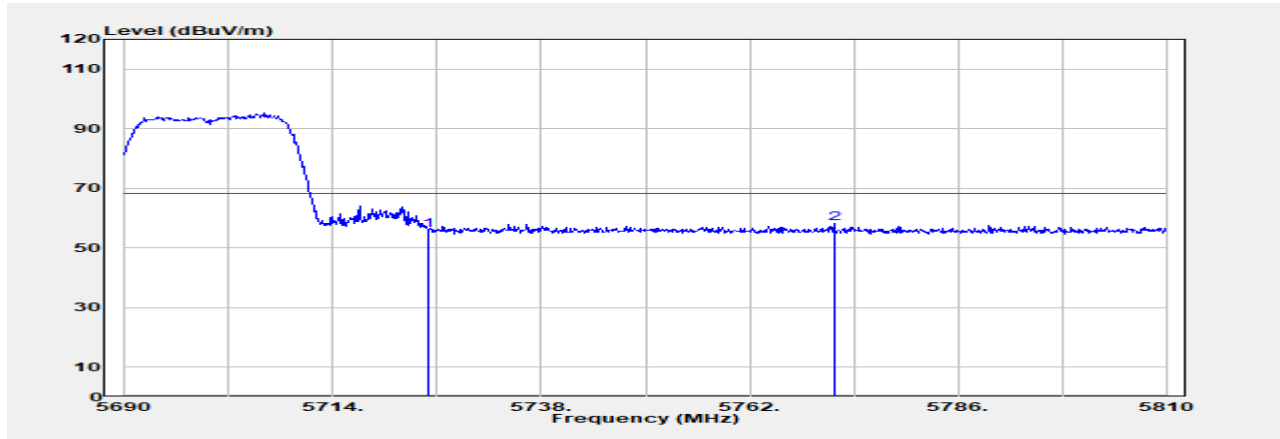

Freq. MHz	Detector Mode PK/QP/AVG	Spectrum Reading Level dBμV	Factor dB	Actual FS dBμV/m	Limit @3m dBμV/m	Margin dB
5725.000	Peak	49.36	6.67	56.02	68.20	-12.18
5771.720	Peak	51.19	6.91	58.10	68.20	-10.10

Unless otherwise stated the results shown in this test report refer only to the sample(s) tested and such sample(s) are retained for 90 days only.

除非另有說明，此報告結果僅對測試之樣品負責，同時此樣品僅保留90天。本報告未經本公司書面許可，不可部份複製。

This document is issued by the Company subject to its General Conditions of Service printed overleaf, available on request or accessible at <http://www.sgs.com.tw/Terms-and-Conditions> and for electronic format documents, subject to Terms and Conditions for Electronic Documents at <http://www.sgs.com.tw/Terms-and-Conditions>. Attention is drawn to the limitation of liability, indemnification and jurisdiction issues defined therein. Any holder of this document is advised that information contained hereon reflects the Company's findings at the time of its intervention only and within the limits of Client's instructions, if any. The Company's sole responsibility is to its Client and this document does not exonerate parties to a transaction from exercising all their rights and obligations under the transaction documents. This document cannot be reproduced except in full, without prior written approval of the Company. Any unauthorized alteration, forgery or falsification of the content or appearance of this document is unlawful and offenders may be prosecuted to the fullest extent of the law.

Report Number :TERF2404000927E2  
 Operation Mode :802.11n20  
 Test Frequency :5700 MHz  
 Test Mode :Bandedge  
 EUT Pol :E2 Plane

Test Site :SAC G Chamber  
 Test Date :2024-05-10  
 Temp./Humi. :24.0°C/51%  
 Antenna Pol. :Horizontal  
 Engineer :Temo Chen

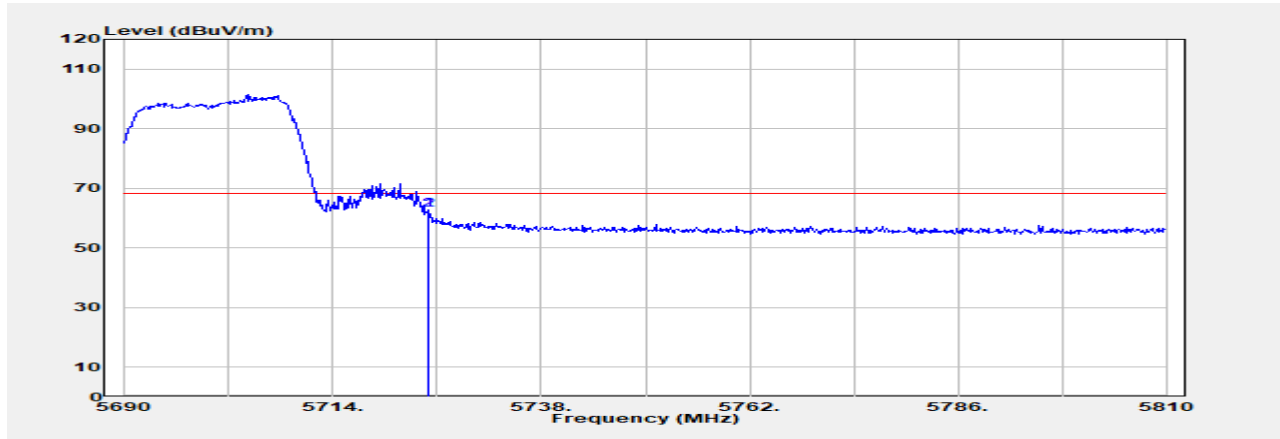

Freq. MHz	Detector Mode PK/QP/AVG	Spectrum Reading Level dB $\mu$ V	Factor dB	Actual FS dB $\mu$ V/m	Limit @3m dB $\mu$ V/m	Margin dB
5725.000	Peak	55.95	6.67	62.62	68.20	-5.58
5725.040	Peak	55.95	6.67	62.62	68.20	-5.58

Unless otherwise stated the results shown in this test report refer only to the sample(s) tested and such sample(s) are retained for 90 days only.

除非另有說明，此報告結果僅對測試之樣品負責，同時此樣品僅保留90天。本報告未經本公司書面許可，不可部份複製。

This document is issued by the Company subject to its General Conditions of Service printed overleaf, available on request or accessible at <http://www.sgs.com.tw/Terms-and-Conditions> and for electronic format documents, subject to Terms and Conditions for Electronic Documents at <http://www.sgs.com.tw/Terms-and-Conditions>. Attention is drawn to the limitation of liability, indemnification and jurisdiction issues defined therein. Any holder of this document is advised that information contained hereon reflects the Company's findings at the time of its intervention only and within the limits of Client's instructions, if any. The Company's sole responsibility is to its Client and this document does not exonerate parties to a transaction from exercising all their rights and obligations under the transaction documents. This document cannot be reproduced except in full, without prior written approval of the Company. Any unauthorized alteration, forgery or falsification of the content or appearance of this document is unlawful and offenders may be prosecuted to the fullest extent of the law.

Report Number :TERF2404000927E2  
 Operation Mode :802.11n20  
 Test Frequency :5720 MHz  
 Test Mode :Bandedge  
 EUT Pol :E2 Plane

Test Site :SAC G Chamber  
 Test Date :2024-04-25  
 Temp./Humi. :23.0°C/59%  
 Antenna Pol. :Vertical  
 Engineer :Temo Chen

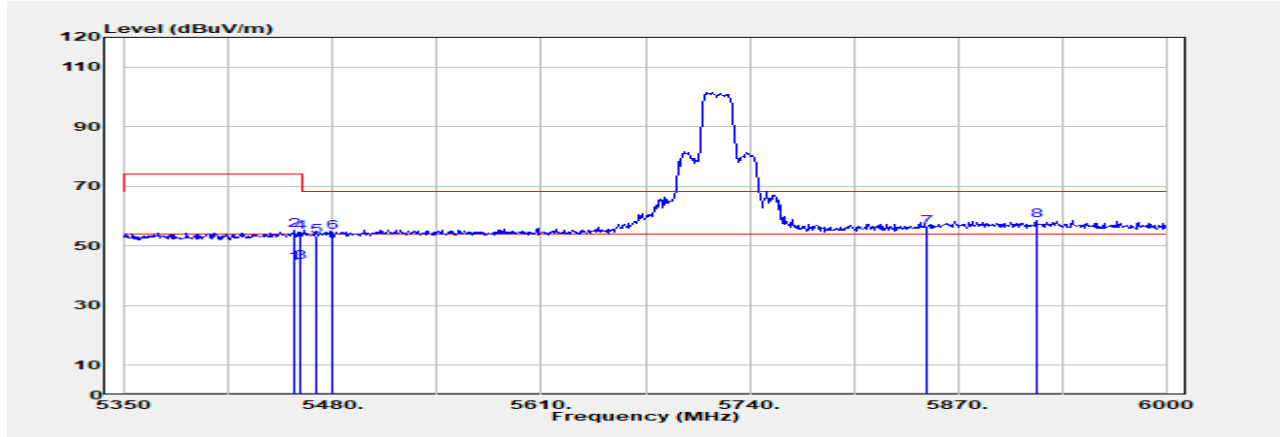

Freq. MHz	Detector Mode PK/QP/AVG	Spectrum Reading Level dBμV	Factor dB	Actual FS dBμV/m	Limit @3m dBμV/m	Margin dB
5455.950	Average	38.62	5.68	44.30	54.00	-9.70
5455.950	Peak	49.61	5.68	55.29	74.00	-18.71
5460.000	Average	38.71	5.71	44.42	54.00	-9.58
5460.000	Peak	48.88	5.71	54.60	74.00	-19.40
5470.000	Peak	47.62	5.81	53.43	68.20	-14.77
5480.000	Peak	48.61	5.90	54.50	68.20	-13.70
5850.000	Peak	48.40	7.71	56.10	68.20	-12.10
5918.750	Peak	50.13	8.40	58.53	68.20	-9.67

Unless otherwise stated the results shown in this test report refer only to the sample(s) tested and such sample(s) are retained for 90 days only.

除非另有說明，此報告結果僅對測試之樣品負責，同時此樣品僅保留90天。本報告未經本公司書面許可，不可部份複製。

This document is issued by the Company subject to its General Conditions of Service printed overleaf, available on request or accessible at <http://www.sgs.com.tw/Terms-and-Conditions> and for electronic format documents, subject to Terms and Conditions for Electronic Documents at <http://www.sgs.com.tw/Terms-and-Conditions>. Attention is drawn to the limitation of liability, indemnification and jurisdiction issues defined therein. Any holder of this document is advised that information contained hereon reflects the Company's findings at the time of its intervention only and within the limits of Client's instructions, if any. The Company's sole responsibility is to its Client and this document does not exonerate parties to a transaction from exercising all their rights and obligations under the transaction documents. This document cannot be reproduced except in full, without prior written approval of the Company. Any unauthorized alteration, forgery or falsification of the content or appearance of this document is unlawful and offenders may be prosecuted to the fullest extent of the law.

Report Number :TERF2404000927E2  
 Operation Mode :802.11n20  
 Test Frequency :5720 MHz  
 Test Mode :Bandedge  
 EUT Pol :E2 Plane

Test Site :SAC G Chamber  
 Test Date :2024-04-25  
 Temp./Humi. :23.0°C/59%  
 Antenna Pol. :Horizontal  
 Engineer :Temo Chen

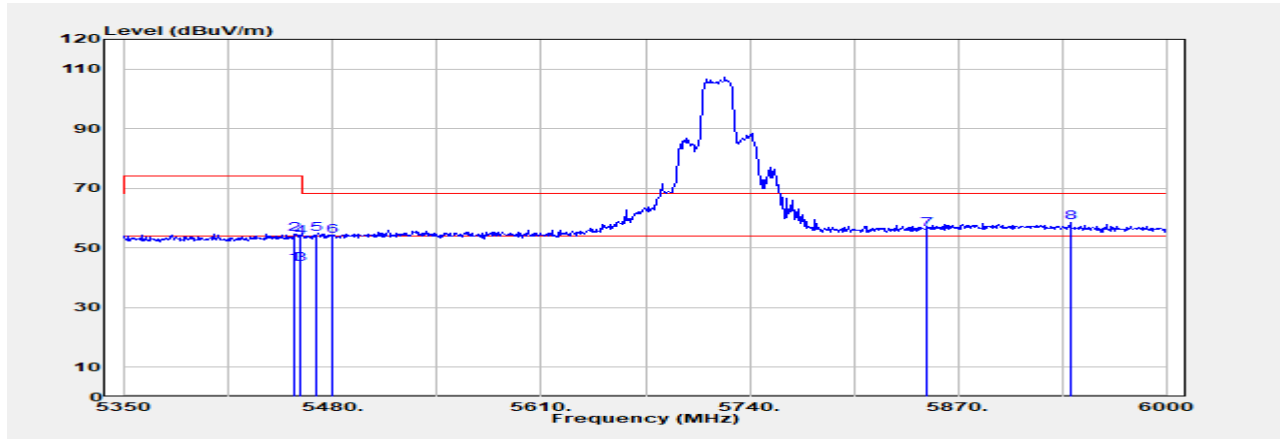

Freq. MHz	Detector Mode PK/QP/AVG	Spectrum Reading Level dBμV	Factor dB	Actual FS dBμV/m	Limit @3m dBμV/m	Margin dB
5455.950	Average	38.72	5.68	44.39	54.00	-9.61
5455.950	Peak	49.04	5.68	54.71	74.00	-19.29
5460.000	Average	38.90	5.71	44.61	54.00	-9.39
5460.000	Peak	48.10	5.71	53.81	74.00	-20.19
5470.000	Peak	48.86	5.81	54.67	68.20	-13.53
5480.000	Peak	48.24	5.90	54.13	68.20	-14.07
5850.000	Peak	48.49	7.71	56.20	68.20	-12.00
5940.200	Peak	50.15	8.28	58.43	68.20	-9.77

Unless otherwise stated the results shown in this test report refer only to the sample(s) tested and such sample(s) are retained for 90 days only.

除非另有說明，此報告結果僅對測試之樣品負責，同時此樣品僅保留90天。本報告未經本公司書面許可，不可部份複製。

This document is issued by the Company subject to its General Conditions of Service printed overleaf, available on request or accessible at <http://www.sgs.com.tw/Terms-and-Conditions> and for electronic format documents, subject to Terms and Conditions for Electronic Documents at <http://www.sgs.com.tw/Terms-and-Conditions>. Attention is drawn to the limitation of liability, indemnification and jurisdiction issues defined therein. Any holder of this document is advised that information contained hereon reflects the Company's findings at the time of its intervention only and within the limits of Client's instructions, if any. The Company's sole responsibility is to its Client and this document does not exonerate parties to a transaction from exercising all their rights and obligations under the transaction documents. This document cannot be reproduced except in full, without prior written approval of the Company. Any unauthorized alteration, forgery or falsification of the content or appearance of this document is unlawful and offenders may be prosecuted to the fullest extent of the law.

Report Number :TERF2404000927E2  
 Operation Mode :802.11n20  
 Test Frequency :5745 MHz  
 Test Mode :Bandedge  
 EUT Pol :E2 Plane

Test Site :SAC G Chamber  
 Test Date :2024-04-25  
 Temp./Humi. :23.0°C/59%  
 Antenna Pol. :Vertical  
 Engineer :Temo Chen

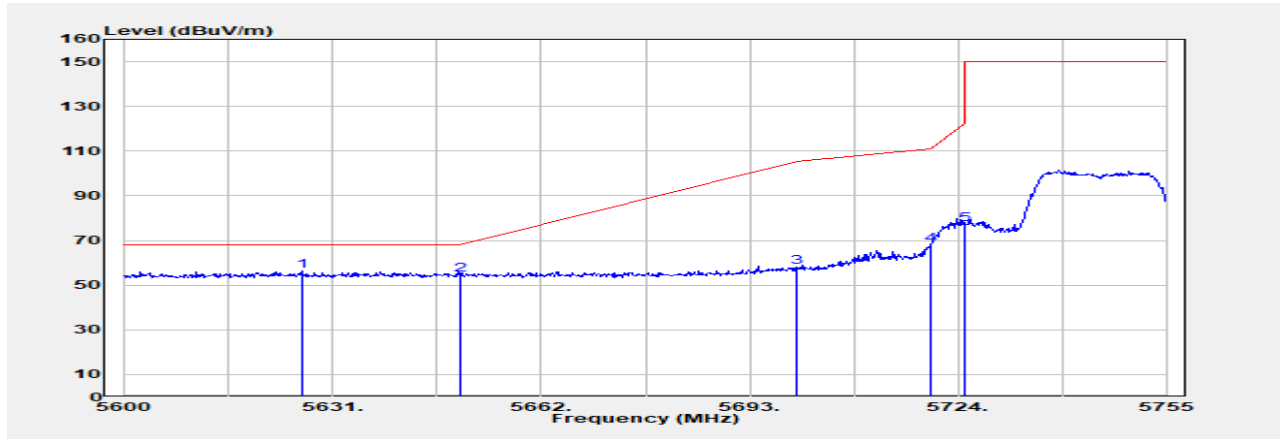

Freq. MHz	Detector Mode PK/QP/AVG	Spectrum Reading Level dBμV	Factor dB	Actual FS dBμV/m	Limit @3m dBμV/m	Margin dB
5626.350	Peak	50.35	5.85	56.21	68.20	-11.99
5650.000	Peak	48.54	6.03	54.56	68.20	-13.64
5700.000	Peak	51.56	6.49	58.05	105.20	-47.15
5720.000	Peak	61.24	6.63	67.87	110.80	-42.93
5725.000	Peak	70.63	6.67	77.30	122.20	-44.90

Unless otherwise stated the results shown in this test report refer only to the sample(s) tested and such sample(s) are retained for 90 days only.

除非另有說明，此報告結果僅對測試之樣品負責，同時此樣品僅保留90天。本報告未經本公司書面許可，不可部份複製。

This document is issued by the Company subject to its General Conditions of Service printed overleaf, available on request or accessible at <http://www.sgs.com.tw/Terms-and-Conditions> and for electronic format documents, subject to Terms and Conditions for Electronic Documents at <http://www.sgs.com.tw/Terms-and-Conditions>. Attention is drawn to the limitation of liability, indemnification and jurisdiction issues defined therein. Any holder of this document is advised that information contained hereon reflects the Company's findings at the time of its intervention only and within the limits of Client's instructions, if any. The Company's sole responsibility is to its Client and this document does not exonerate parties to a transaction from exercising all their rights and obligations under the transaction documents. This document cannot be reproduced except in full, without prior written approval of the Company. Any unauthorized alteration, forgery or falsification of the content or appearance of this document is unlawful and offenders may be prosecuted to the fullest extent of the law.

Report Number :TERF2404000927E2  
 Operation Mode :802.11n20  
 Test Frequency :5745 MHz  
 Test Mode :Bandedge  
 EUT Pol :E2 Plane

Test Site :SAC G Chamber  
 Test Date :2024-04-25  
 Temp./Humi. :23.0°C/59%  
 Antenna Pol. :Horizontal  
 Engineer :Temo Chen

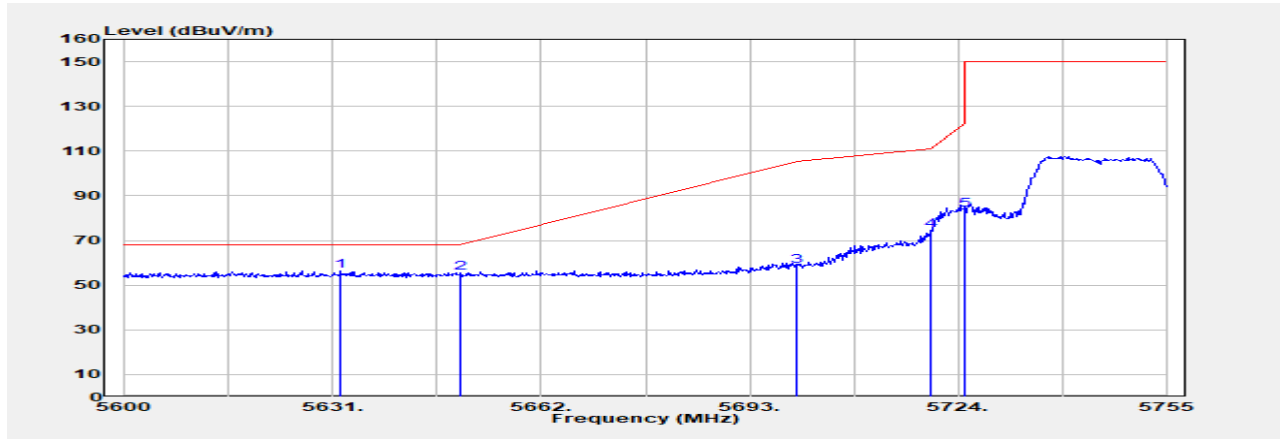

Freq. MHz	Detector Mode PK/QP/AVG	Spectrum Reading Level dB $\mu$ V	Factor dB	Actual FS dB $\mu$ V/m	Limit @3m dB $\mu$ V/m	Margin dB
5632.085	Peak	50.37	5.90	56.26	68.20	-11.94
5650.000	Peak	49.53	6.03	55.55	68.20	-12.65
5700.000	Peak	52.11	6.49	58.60	105.20	-46.60
5720.000	Peak	68.02	6.63	74.65	110.80	-36.15
5725.000	Peak	77.20	6.67	83.86	122.20	-38.34

Unless otherwise stated the results shown in this test report refer only to the sample(s) tested and such sample(s) are retained for 90 days only.

除非另有說明，此報告結果僅對測試之樣品負責，同時此樣品僅保留90天。本報告未經本公司書面許可，不可部份複製。

This document is issued by the Company subject to its General Conditions of Service printed overleaf, available on request or accessible at <http://www.sgs.com.tw/Terms-and-Conditions> and for electronic format documents, subject to Terms and Conditions for Electronic Documents at <http://www.sgs.com.tw/Terms-and-Conditions>. Attention is drawn to the limitation of liability, indemnification and jurisdiction issues defined therein. Any holder of this document is advised that information contained hereon reflects the Company's findings at the time of its intervention only and within the limits of Client's instructions, if any. The Company's sole responsibility is to its Client and this document does not exonerate parties to a transaction from exercising all their rights and obligations under the transaction documents. This document cannot be reproduced except in full, without prior written approval of the Company. Any unauthorized alteration, forgery or falsification of the content or appearance of this document is unlawful and offenders may be prosecuted to the fullest extent of the law.

Report Number :TERF2404000927E2  
 Operation Mode :802.11n20  
 Test Frequency :5825 MHz  
 Test Mode :Bandedge  
 EUT Pol :E2 Plane

Test Site :SAC G Chamber  
 Test Date :2024-04-29  
 Temp./Humi. :20.6°C/62%  
 Antenna Pol. :Vertical  
 Engineer :Temo Chen

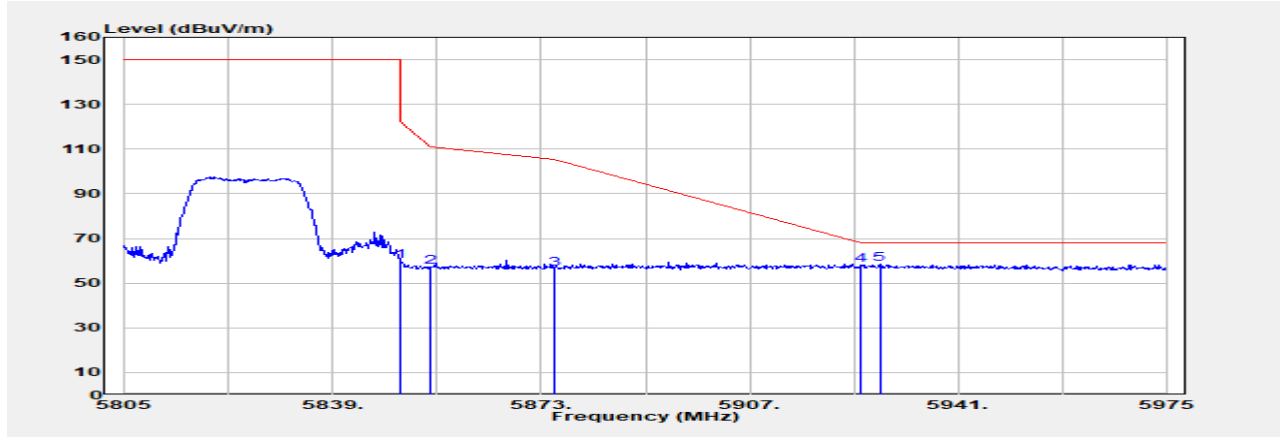

Freq. MHz	Detector Mode PK/QP/AVG	Spectrum Reading Level dB $\mu$ V	Factor dB	Actual FS dB $\mu$ V/m	Limit @3m dB $\mu$ V/m	Margin dB
5850.000	Peak	52.26	7.71	59.97	122.20	-62.23
5855.000	Peak	49.38	7.79	57.17	110.80	-53.63
5875.000	Peak	48.28	8.11	56.39	105.20	-48.81
5925.000	Peak	49.68	8.37	58.04	68.20	-10.16
5928.250	Peak	50.29	8.35	58.63	68.20	-9.57

Unless otherwise stated the results shown in this test report refer only to the sample(s) tested and such sample(s) are retained for 90 days only.

除非另有說明，此報告結果僅對測試之樣品負責，同時此樣品僅保留90天。本報告未經本公司書面許可，不可部份複製。

This document is issued by the Company subject to its General Conditions of Service printed overleaf, available on request or accessible at <http://www.sgs.com.tw/Terms-and-Conditions> and for electronic format documents, subject to Terms and Conditions for Electronic Documents at <http://www.sgs.com.tw/Terms-and-Conditions>. Attention is drawn to the limitation of liability, indemnification and jurisdiction issues defined therein. Any holder of this document is advised that information contained hereon reflects the Company's findings at the time of its intervention only and within the limits of Client's instructions, if any. The Company's sole responsibility is to its Client and this document does not exonerate parties to a transaction from exercising all their rights and obligations under the transaction documents. This document cannot be reproduced except in full, without prior written approval of the Company. Any unauthorized alteration, forgery or falsification of the content or appearance of this document is unlawful and offenders may be prosecuted to the fullest extent of the law.



Report Number :TERF2404000927E2  
 Operation Mode :802.11n20  
 Test Frequency :5825 MHz  
 Test Mode :Bandedge  
 EUT Pol :E2 Plane

Test Site :SAC G Chamber  
 Test Date :2024-04-29  
 Temp./Humi. :20.6°C/62%  
 Antenna Pol. :Horizontal  
 Engineer :Temo Chen

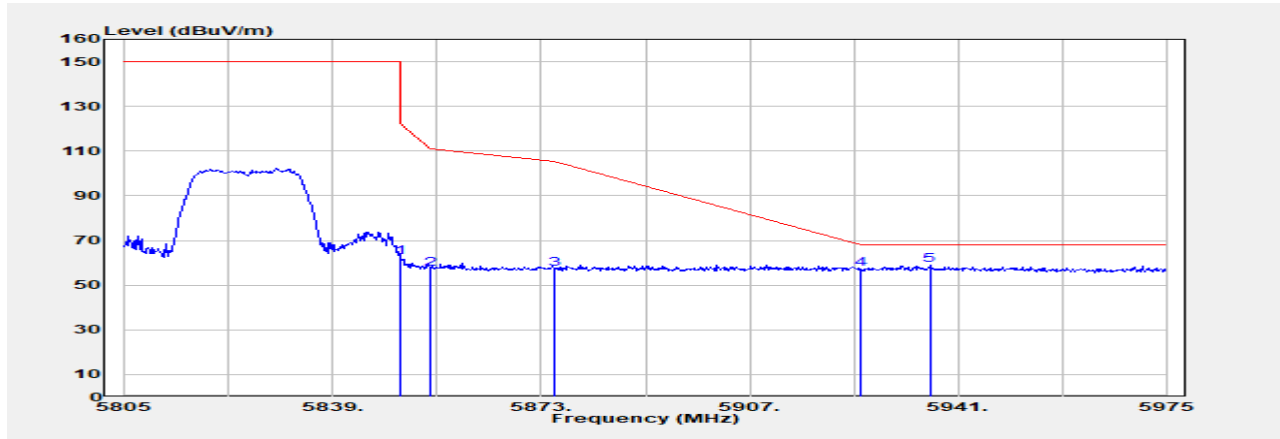

Freq. MHz	Detector Mode PK/QP/AVG	Spectrum Reading Level dBμV	Factor dB	Actual FS dBμV/m	Limit @3m dBμV/m	Margin dB
5850.000	Peak	54.92	7.71	62.63	122.20	-59.57
5855.000	Peak	49.47	7.79	57.25	110.80	-53.55
5875.000	Peak	49.03	8.11	57.14	105.20	-48.06
5925.000	Peak	49.02	8.37	57.38	68.20	-10.82
5936.410	Peak	50.71	8.30	59.01	68.20	-9.19

Unless otherwise stated the results shown in this test report refer only to the sample(s) tested and such sample(s) are retained for 90 days only.

除非另有說明，此報告結果僅對測試之樣品負責，同時此樣品僅保留90天。本報告未經本公司書面許可，不可部份複製。

This document is issued by the Company subject to its General Conditions of Service printed overleaf, available on request or accessible at <http://www.sgs.com.tw/Terms-and-Conditions> and for electronic format documents, subject to Terms and Conditions for Electronic Documents at <http://www.sgs.com.tw/Terms-and-Conditions>. Attention is drawn to the limitation of liability, indemnification and jurisdiction issues defined therein. Any holder of this document is advised that information contained hereon reflects the Company's findings at the time of its intervention only and within the limits of Client's instructions, if any. The Company's sole responsibility is to its Client and this document does not exonerate parties to a transaction from exercising all their rights and obligations under the transaction documents. This document cannot be reproduced except in full, without prior written approval of the Company. Any unauthorized alteration, forgery or falsification of the content or appearance of this document is unlawful and offenders may be prosecuted to the fullest extent of the law.

monopole

Report Number :TERF2404000927E2  
 Operation Mode :802.11a  
 Test Frequency :5180 MHz  
 Test Mode :Bandedge  
 EUT Pol :E2 Plane

Test Site :SAC G Chamber  
 Test Date :2024-05-10  
 Temp./Humi. :24.0°C/51%  
 Antenna Pol. :Vertical  
 Engineer :Temo Chen

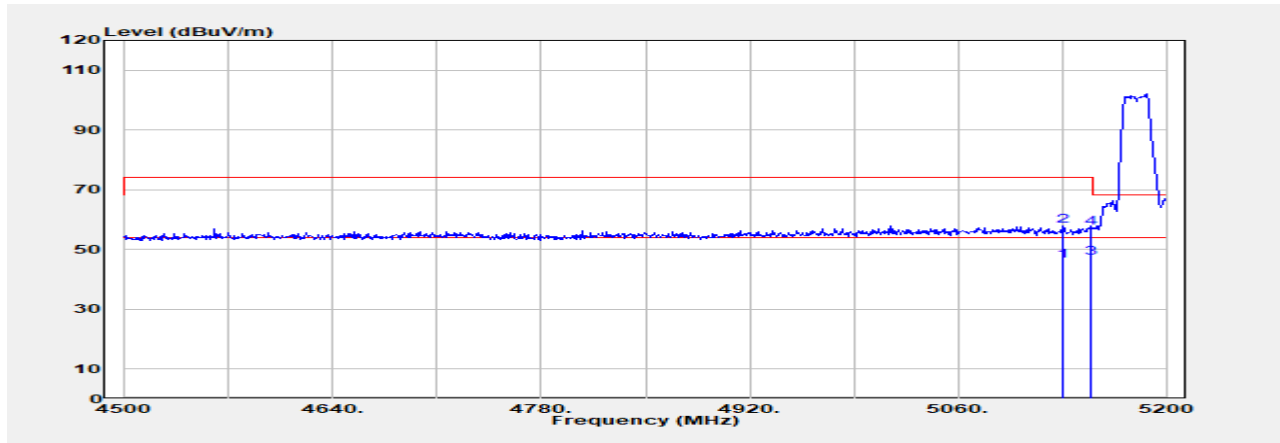

Freq. MHz	Detector Mode PK/QP/AVG	Spectrum Reading Level dB $\mu$ V	Factor dB	Actual FS dB $\mu$ V/m	Limit @3m dB $\mu$ V/m	Margin dB
5130.000	Average	40.71	5.55	46.26	54.00	-7.74
5130.000	Peak	52.40	5.55	57.95	74.00	-16.05
5150.000	Average	41.74	5.42	47.17	54.00	-6.83
5150.000	Peak	51.70	5.42	57.12	74.00	-16.88

Unless otherwise stated the results shown in this test report refer only to the sample(s) tested and such sample(s) are retained for 90 days only.

除非另有說明，此報告結果僅對測試之樣品負責，同時此樣品僅保留90天。本報告未經本公司書面許可，不可部份複製。

This document is issued by the Company subject to its General Conditions of Service printed overleaf, available on request or accessible at <http://www.sgs.com.tw/Terms-and-Conditions> and for electronic format documents, subject to Terms and Conditions for Electronic Documents at <http://www.sgs.com.tw/Terms-and-Conditions>. Attention is drawn to the limitation of liability, indemnification and jurisdiction issues defined therein. Any holder of this document is advised that information contained hereon reflects the Company's findings at the time of its intervention only and within the limits of Client's instructions, if any. The Company's sole responsibility is to its Client and this document does not exonerate parties to a transaction from exercising all their rights and obligations under the transaction documents. This document cannot be reproduced except in full, without prior written approval of the Company. Any unauthorized alteration, forgery or falsification of the content or appearance of this document is unlawful and offenders may be prosecuted to the fullest extent of the law.

Report Number :TERF2404000927E2  
 Operation Mode :802.11a  
 Test Frequency :5180 MHz  
 Test Mode :Bandedge  
 EUT Pol :E2 Plane

Test Site :SAC G Chamber  
 Test Date :2024-05-10  
 Temp./Humi. :24.0°C/51%  
 Antenna Pol. :Horizontal  
 Engineer :Temo Chen

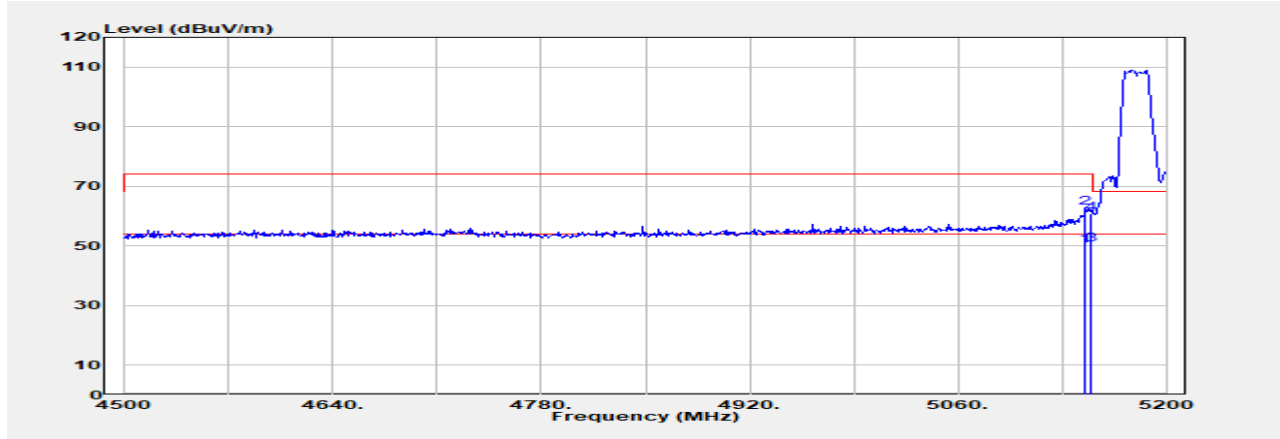

Freq. MHz	Detector Mode PK/QP/AVG	Spectrum Reading Level dB $\mu$ V	Factor dB	Actual FS dB $\mu$ V/m	Limit @3m dB $\mu$ V/m	Margin dB
5145.400	Average	44.62	5.45	50.08	54.00	-3.92
5145.400	Peak	57.19	5.45	62.64	74.00	-11.36
5150.000	Average	44.95	5.42	50.37	54.00	-3.63
5150.000	Peak	55.44	5.42	60.86	74.00	-13.14

Unless otherwise stated the results shown in this test report refer only to the sample(s) tested and such sample(s) are retained for 90 days only.

除非另有說明，此報告結果僅對測試之樣品負責，同時此樣品僅保留90天。本報告未經本公司書面許可，不可部份複製。

This document is issued by the Company subject to its General Conditions of Service printed overleaf, available on request or accessible at <http://www.sgs.com.tw/Terms-and-Conditions> and for electronic format documents, subject to Terms and Conditions for Electronic Documents at <http://www.sgs.com.tw/Terms-and-Conditions>. Attention is drawn to the limitation of liability, indemnification and jurisdiction issues defined therein. Any holder of this document is advised that information contained hereon reflects the Company's findings at the time of its intervention only and within the limits of Client's instructions, if any. The Company's sole responsibility is to its Client and this document does not exonerate parties to a transaction from exercising all their rights and obligations under the transaction documents. This document cannot be reproduced except in full, without prior written approval of the Company. Any unauthorized alteration, forgery or falsification of the content or appearance of this document is unlawful and offenders may be prosecuted to the fullest extent of the law.

Report Number :TERF2404000927E2  
 Operation Mode :802.11a  
 Test Frequency :5320 MHz  
 Test Mode :Bandedge  
 EUT Pol :E2 Plane

Test Site :SAC G Chamber  
 Test Date :2024-04-26  
 Temp./Humi. :22.3°C/54%  
 Antenna Pol. :Vertical  
 Engineer :Temo Chen

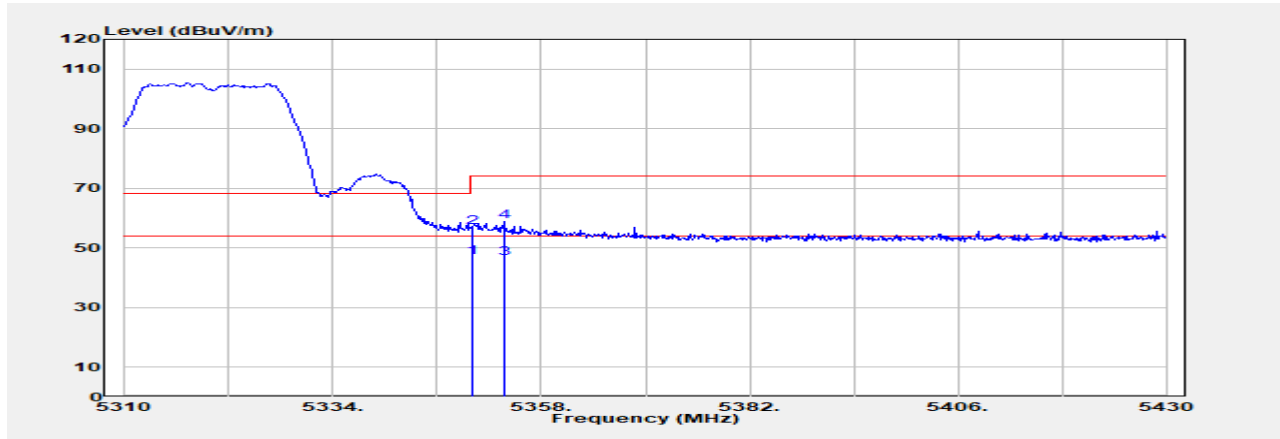

Freq. MHz	Detector Mode PK/QP/AVG	Spectrum Reading Level dB $\mu$ V	Factor dB	Actual FS dB $\mu$ V/m	Limit @3m dB $\mu$ V/m	Margin dB
5350.000	Average	41.77	5.04	46.81	54.00	-7.19
5350.000	Peak	51.74	5.04	56.78	74.00	-17.22
5353.680	Average	41.39	5.04	46.43	54.00	-7.57
5353.680	Peak	53.76	5.04	58.80	74.00	-15.20

Unless otherwise stated the results shown in this test report refer only to the sample(s) tested and such sample(s) are retained for 90 days only.

除非另有說明，此報告結果僅對測試之樣品負責，同時此樣品僅保留90天。本報告未經本公司書面許可，不可部份複製。

This document is issued by the Company subject to its General Conditions of Service printed overleaf, available on request or accessible at <http://www.sgs.com.tw/Terms-and-Conditions> and for electronic format documents, subject to Terms and Conditions for Electronic Documents at <http://www.sgs.com.tw/Terms-and-Conditions>. Attention is drawn to the limitation of liability, indemnification and jurisdiction issues defined therein. Any holder of this document is advised that information contained hereon reflects the Company's findings at the time of its intervention only and within the limits of Client's instructions, if any. The Company's sole responsibility is to its Client and this document does not exonerate parties to a transaction from exercising all their rights and obligations under the transaction documents. This document cannot be reproduced except in full, without prior written approval of the Company. Any unauthorized alteration, forgery or falsification of the content or appearance of this document is unlawful and offenders may be prosecuted to the fullest extent of the law.

Report Number :TERF2404000927E2  
 Operation Mode :802.11a  
 Test Frequency :5320 MHz  
 Test Mode :Bandedge  
 EUT Pol :E2 Plane

Test Site :SAC G Chamber  
 Test Date :2024-04-26  
 Temp./Humi. :22.3°C/54%  
 Antenna Pol. :Horizontal  
 Engineer :Temo Chen

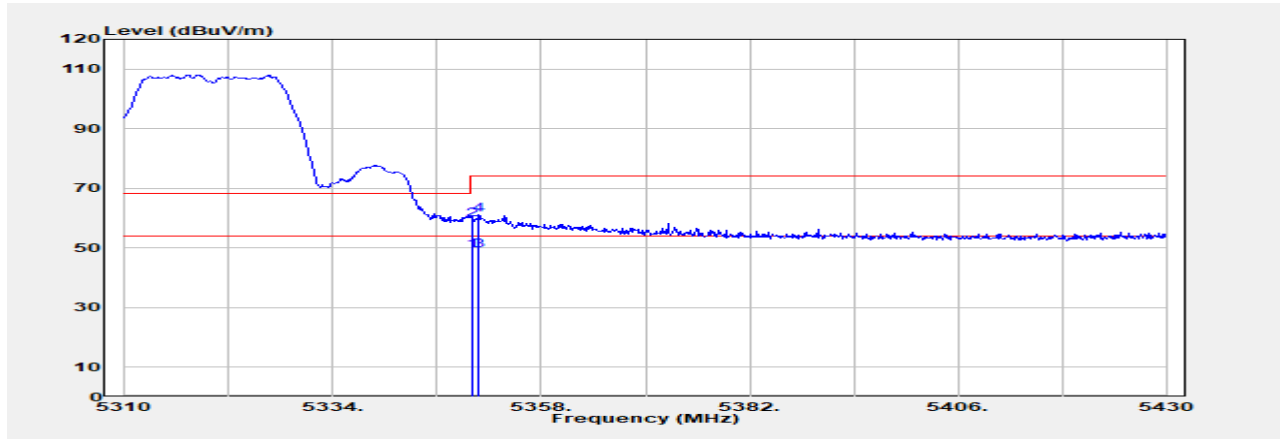

Freq. MHz	Detector Mode PK/QP/AVG	Spectrum Reading Level dBμV	Factor dB	Actual FS dBμV/m	Limit @3m dBμV/m	Margin dB
5350.000	Average	44.01	5.04	49.05	54.00	-4.95
5350.000	Peak	54.61	5.04	59.65	74.00	-14.35
5350.800	Average	43.92	5.04	48.96	54.00	-5.04
5350.800	Peak	56.01	5.04	61.05	74.00	-12.95

Unless otherwise stated the results shown in this test report refer only to the sample(s) tested and such sample(s) are retained for 90 days only.

除非另有說明，此報告結果僅對測試之樣品負責，同時此樣品僅保留90天。本報告未經本公司書面許可，不可部份複製。

This document is issued by the Company subject to its General Conditions of Service printed overleaf, available on request or accessible at <http://www.sgs.com.tw/Terms-and-Conditions> and for electronic format documents, subject to Terms and Conditions for Electronic Documents at <http://www.sgs.com.tw/Terms-and-Conditions>. Attention is drawn to the limitation of liability, indemnification and jurisdiction issues defined therein. Any holder of this document is advised that information contained hereon reflects the Company's findings at the time of its intervention only and within the limits of Client's instructions, if any. The Company's sole responsibility is to its Client and this document does not exonerate parties to a transaction from exercising all their rights and obligations under the transaction documents. This document cannot be reproduced except in full, without prior written approval of the Company. Any unauthorized alteration, forgery or falsification of the content or appearance of this document is unlawful and offenders may be prosecuted to the fullest extent of the law.

Report Number :TERF2404000927E2  
 Operation Mode :802.11a  
 Test Frequency :5500 MHz  
 Test Mode :Bandedge  
 EUT Pol :E2 Plane

Test Site :SAC G Chamber  
 Test Date :2024-04-26  
 Temp./Humi. :22.3°C/54%  
 Antenna Pol. :Vertical  
 Engineer :Temo Chen

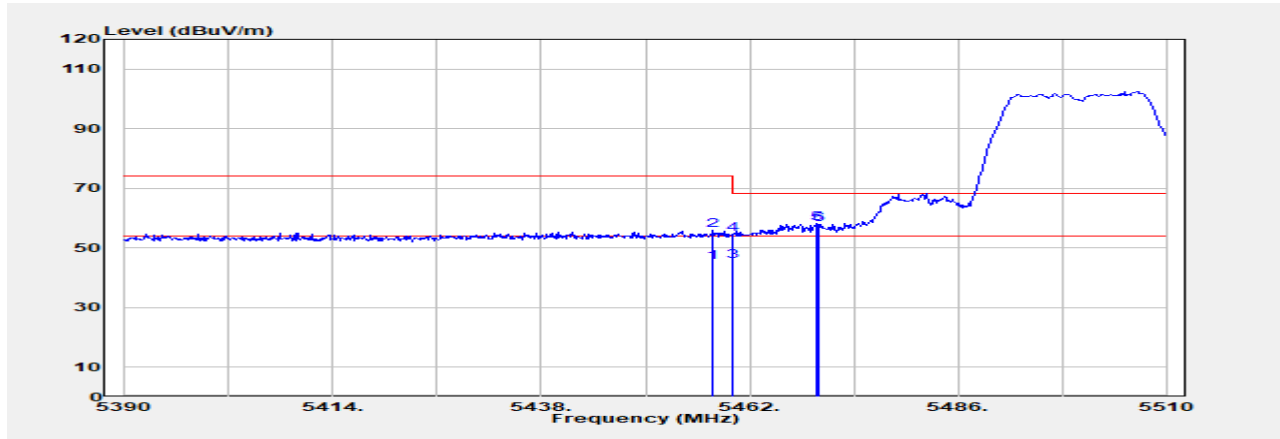

Freq. MHz	Detector Mode PK/QP/AVG	Spectrum Reading Level dBμV	Factor dB	Actual FS dBμV/m	Limit @3m dBμV/m	Margin dB
5457.800	Average	39.39	5.69	45.09	54.00	-8.91
5457.800	Peak	50.35	5.69	56.04	74.00	-17.96
5460.000	Average	39.65	5.71	45.37	54.00	-8.63
5460.000	Peak	49.00	5.71	54.71	74.00	-19.29
5469.680	Peak	52.37	5.80	58.17	68.20	-10.03
5470.000	Peak	52.02	5.81	57.82	68.20	-10.38

Unless otherwise stated the results shown in this test report refer only to the sample(s) tested and such sample(s) are retained for 90 days only.

除非另有說明，此報告結果僅對測試之樣品負責，同時此樣品僅保留90天。本報告未經本公司書面許可，不可部份複製。

This document is issued by the Company subject to its General Conditions of Service printed overleaf, available on request or accessible at <http://www.sgs.com.tw/Terms-and-Conditions> and for electronic format documents, subject to Terms and Conditions for Electronic Documents at <http://www.sgs.com.tw/Terms-and-Conditions>. Attention is drawn to the limitation of liability, indemnification and jurisdiction issues defined therein. Any holder of this document is advised that information contained hereon reflects the Company's findings at the time of its intervention only and within the limits of Client's instructions, if any. The Company's sole responsibility is to its Client and this document does not exonerate parties to a transaction from exercising all their rights and obligations under the transaction documents. This document cannot be reproduced except in full, without prior written approval of the Company. Any unauthorized alteration, forgery or falsification of the content or appearance of this document is unlawful and offenders may be prosecuted to the fullest extent of the law.

Report Number :TERF2404000927E2  
 Operation Mode :802.11a  
 Test Frequency :5500 MHz  
 Test Mode :Bandedge  
 EUT Pol :E2 Plane

Test Site :SAC G Chamber  
 Test Date :2024-04-26  
 Temp./Humi. :22.3°C/54%  
 Antenna Pol. :Horizontal  
 Engineer :Temo Chen

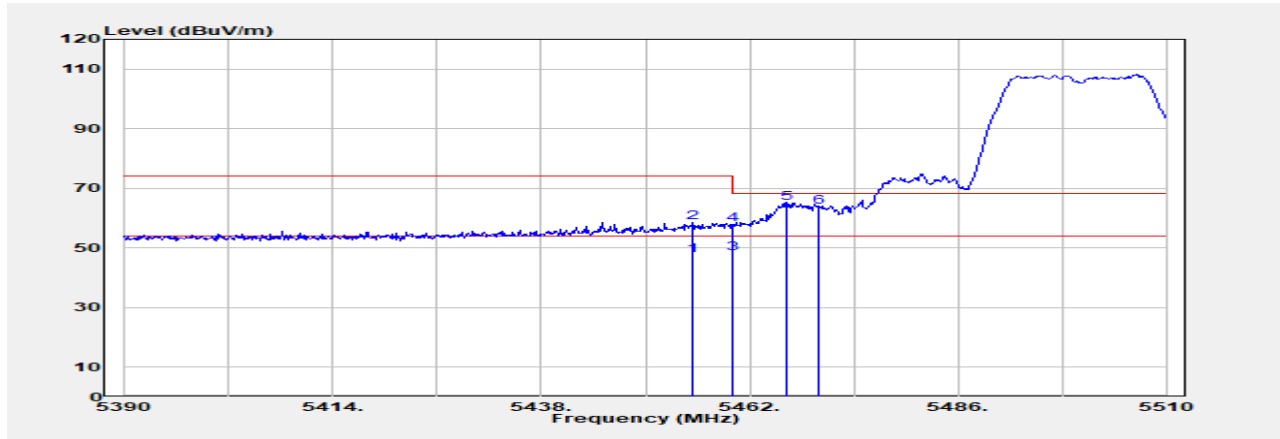

Freq. MHz	Detector Mode PK/QP/AVG	Spectrum Reading Level dB $\mu$ V	Factor dB	Actual FS dB $\mu$ V/m	Limit @3m dB $\mu$ V/m	Margin dB
5455.520	Average	41.72	5.67	47.39	54.00	-6.61
5455.520	Peak	52.96	5.67	58.63	74.00	-15.37
5460.000	Average	42.58	5.71	48.29	54.00	-5.71
5460.000	Peak	52.19	5.71	57.90	74.00	-16.10
5466.200	Peak	59.41	5.77	65.18	68.20	-3.02
5470.000	Peak	57.99	5.81	63.80	68.20	-4.40

Unless otherwise stated the results shown in this test report refer only to the sample(s) tested and such sample(s) are retained for 90 days only.

除非另有說明，此報告結果僅對測試之樣品負責，同時此樣品僅保留90天。本報告未經本公司書面許可，不可部份複製。

This document is issued by the Company subject to its General Conditions of Service printed overleaf, available on request or accessible at <http://www.sgs.com.tw/Terms-and-Conditions>, and for electronic format documents, subject to Terms and Conditions for Electronic Documents at <http://www.sgs.com.tw/Terms-and-Conditions>. Attention is drawn to the limitation of liability, indemnification and jurisdiction issues defined therein. Any holder of this document is advised that information contained hereon reflects the Company's findings at the time of its intervention only and within the limits of Client's instructions, if any. The Company's sole responsibility is to its Client and this document does not exonerate parties to a transaction from exercising all their rights and obligations under the transaction documents. This document cannot be reproduced except in full, without prior written approval of the Company. Any unauthorized alteration, forgery or falsification of the content or appearance of this document is unlawful and offenders may be prosecuted to the fullest extent of the law.

Report Number :TERF2404000927E2  
 Operation Mode :802.11a  
 Test Frequency :5700 MHz  
 Test Mode :Bandedge  
 EUT Pol :E2 Plane

Test Site :SAC G Chamber  
 Test Date :2024-05-10  
 Temp./Humi. :24.0°C/51%  
 Antenna Pol. :Vertical  
 Engineer :Temo Chen

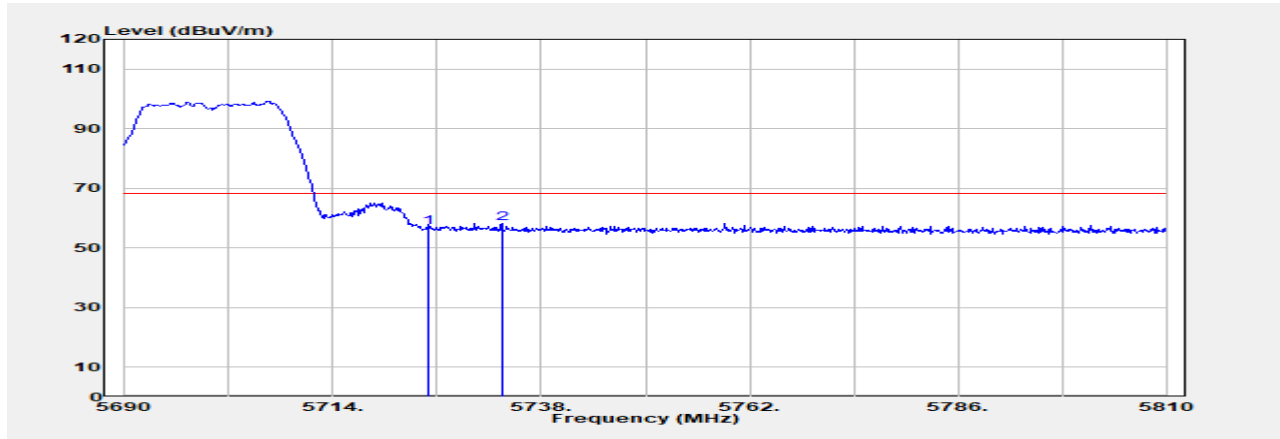

Freq. MHz	Detector Mode PK/QP/AVG	Spectrum Reading Level dB $\mu$ V	Factor dB	Actual FS dB $\mu$ V/m	Limit @3m dB $\mu$ V/m	Margin dB
5725.000	Peak	50.17	6.67	56.84	68.20	-11.36
5733.440	Peak	51.48	6.73	58.21	68.20	-9.99

Unless otherwise stated the results shown in this test report refer only to the sample(s) tested and such sample(s) are retained for 90 days only.

除非另有說明，此報告結果僅對測試之樣品負責，同時此樣品僅保留90天。本報告未經本公司書面許可，不可部份複製。

This document is issued by the Company subject to its General Conditions of Service printed overleaf, available on request or accessible at <http://www.sgs.com.tw/Terms-and-Conditions> and for electronic format documents, subject to Terms and Conditions for Electronic Documents at <http://www.sgs.com.tw/Terms-and-Conditions>. Attention is drawn to the limitation of liability, indemnification and jurisdiction issues defined therein. Any holder of this document is advised that information contained hereon reflects the Company's findings at the time of its intervention only and within the limits of Client's instructions, if any. The Company's sole responsibility is to its Client and this document does not exonerate parties to a transaction from exercising all their rights and obligations under the transaction documents. This document cannot be reproduced except in full, without prior written approval of the Company. Any unauthorized alteration, forgery or falsification of the content or appearance of this document is unlawful and offenders may be prosecuted to the fullest extent of the law.



Report Number :TERF2404000927E2  
 Operation Mode :802.11a  
 Test Frequency :5700 MHz  
 Test Mode :Bandedge  
 EUT Pol :E2 Plane

Test Site :SAC G Chamber  
 Test Date :2024-05-10  
 Temp./Humi. :24.0°C/51%  
 Antenna Pol. :Horizontal  
 Engineer :Temo Chen

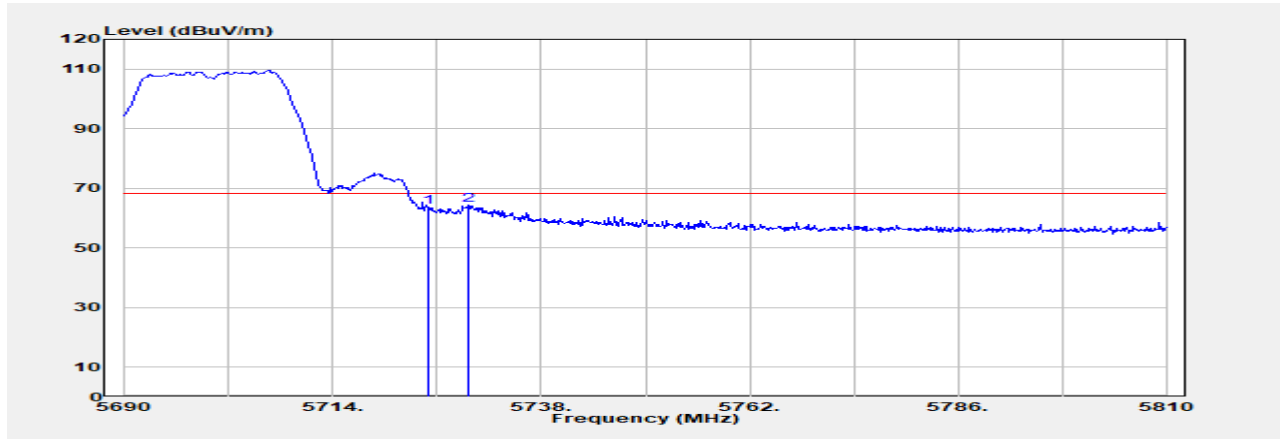

Freq. MHz	Detector Mode PK/QP/AVG	Spectrum Reading Level dBμV	Factor dB	Actual FS dBμV/m	Limit @3m dBμV/m	Margin dB
5725.000	Peak	57.09	6.67	63.76	68.20	-4.44
5729.600	Peak	57.72	6.70	64.42	68.20	-3.78

Unless otherwise stated the results shown in this test report refer only to the sample(s) tested and such sample(s) are retained for 90 days only.

除非另有說明，此報告結果僅對測試之樣品負責，同時此樣品僅保留90天。本報告未經本公司書面許可，不可部份複製。

This document is issued by the Company subject to its General Conditions of Service printed overleaf, available on request or accessible at <http://www.sgs.com.tw/Terms-and-Conditions> and for electronic format documents, subject to Terms and Conditions for Electronic Documents at <http://www.sgs.com.tw/Terms-and-Conditions>. Attention is drawn to the limitation of liability, indemnification and jurisdiction issues defined therein. Any holder of this document is advised that information contained hereon reflects the Company's findings at the time of its intervention only and within the limits of Client's instructions, if any. The Company's sole responsibility is to its Client and this document does not exonerate parties to a transaction from exercising all their rights and obligations under the transaction documents. This document cannot be reproduced except in full, without prior written approval of the Company. Any unauthorized alteration, forgery or falsification of the content or appearance of this document is unlawful and offenders may be prosecuted to the fullest extent of the law.

Report Number :TERF2404000927E2  
 Operation Mode :802.11a  
 Test Frequency :5720 MHz  
 Test Mode :Bandedge  
 EUT Pol :E2 Plane

Test Site :SAC G Chamber  
 Test Date :2024-04-26  
 Temp./Humi. :22.3°C/54%  
 Antenna Pol. :Vertical  
 Engineer :Temo Chen

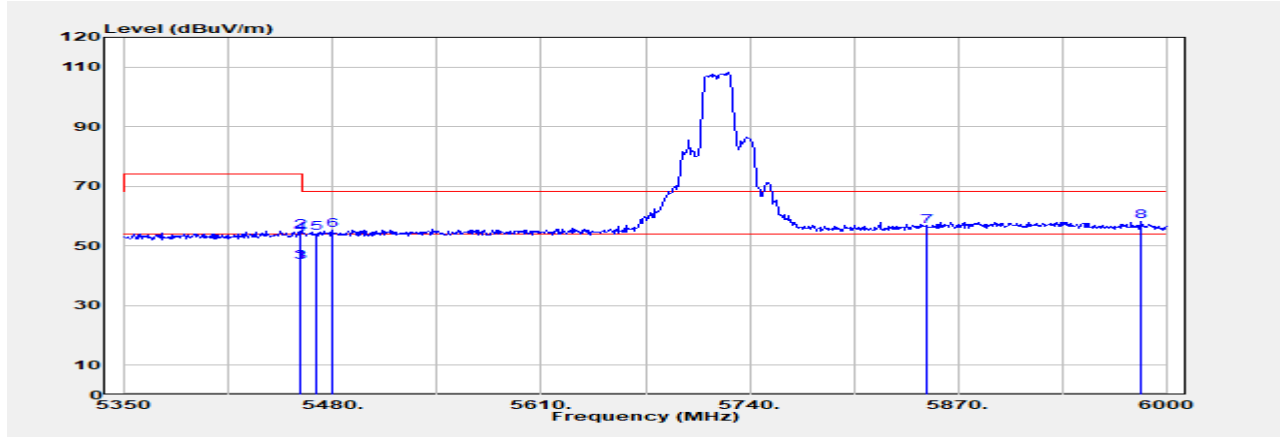

Freq. MHz	Detector Mode PK/QP/AVG	Spectrum Reading Level dB $\mu$ V	Factor dB	Actual FS dB $\mu$ V/m	Limit @3m dB $\mu$ V/m	Margin dB
5459.200	Average	38.82	5.71	44.53	54.00	-9.47
5459.200	Peak	49.28	5.71	54.99	74.00	-19.01
5460.000	Average	38.77	5.71	44.49	54.00	-9.51
5460.000	Peak	48.42	5.71	54.13	74.00	-19.87
5470.000	Peak	48.34	5.81	54.15	68.20	-14.05
5480.000	Peak	49.39	5.90	55.28	68.20	-12.92
5850.000	Peak	48.90	7.71	56.61	68.20	-11.59
5983.750	Peak	50.22	8.03	58.25	68.20	-9.95

Unless otherwise stated the results shown in this test report refer only to the sample(s) tested and such sample(s) are retained for 90 days only.

除非另有說明，此報告結果僅對測試之樣品負責，同時此樣品僅保留90天。本報告未經本公司書面許可，不可部份複製。

This document is issued by the Company subject to its General Conditions of Service printed overleaf, available on request or accessible at <http://www.sgs.com.tw/Terms-and-Conditions> and for electronic format documents, subject to Terms and Conditions for Electronic Documents at <http://www.sgs.com.tw/Terms-and-Conditions>. Attention is drawn to the limitation of liability, indemnification and jurisdiction issues defined therein. Any holder of this document is advised that information contained hereon reflects the Company's findings at the time of its intervention only and within the limits of Client's instructions, if any. The Company's sole responsibility is to its Client and this document does not exonerate parties to a transaction from exercising all their rights and obligations under the transaction documents. This document cannot be reproduced except in full, without prior written approval of the Company. Any unauthorized alteration, forgery or falsification of the content or appearance of this document is unlawful and offenders may be prosecuted to the fullest extent of the law.

Report Number :TERF2404000927E2  
 Operation Mode :802.11a  
 Test Frequency :5720 MHz  
 Test Mode :Bandedge  
 EUT Pol :E2 Plane

Test Site :SAC G Chamber  
 Test Date :2024-04-26  
 Temp./Humi. :22.3°C/54%  
 Antenna Pol. :Horizontal  
 Engineer :Temo Chen

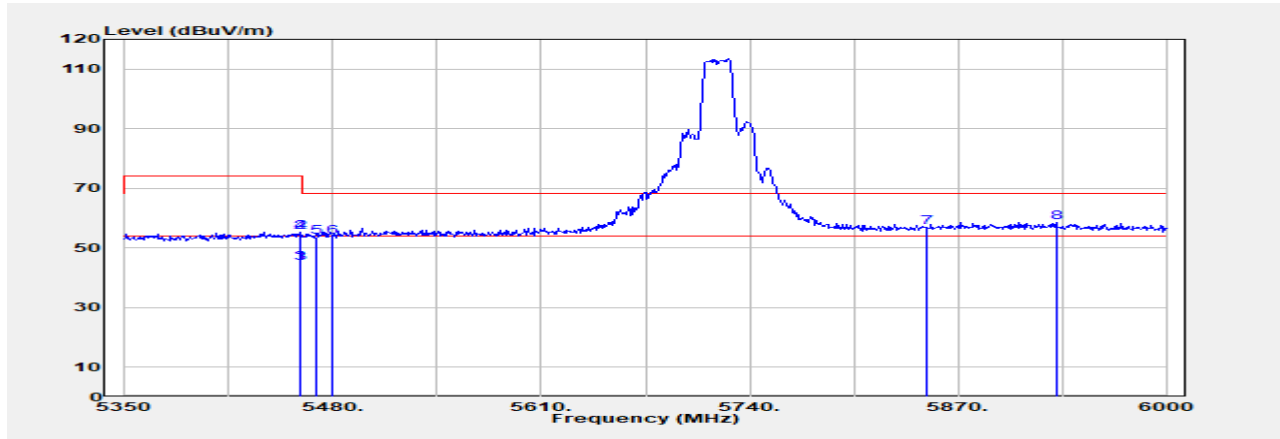

Freq. MHz	Detector Mode PK/QP/AVG	Spectrum Reading Level dBμV	Factor dB	Actual FS dBUV/m	Limit @3m dBUV/m	Margin dB
5459.850	Average	39.23	5.71	44.94	54.00	-9.06
5459.850	Peak	49.73	5.71	55.44	74.00	-18.56
5460.000	Average	39.19	5.71	44.90	54.00	-9.10
5460.000	Peak	49.73	5.71	55.44	74.00	-18.56
5470.000	Peak	47.97	5.81	53.77	68.20	-14.43
5480.000	Peak	47.81	5.90	53.71	68.20	-14.49
5850.000	Peak	49.19	7.71	56.90	68.20	-11.30
5931.750	Peak	50.35	8.33	58.68	68.20	-9.52

Unless otherwise stated the results shown in this test report refer only to the sample(s) tested and such sample(s) are retained for 90 days only.

除非另有說明，此報告結果僅對測試之樣品負責，同時此樣品僅保留90天。本報告未經本公司書面許可，不可部份複製。

This document is issued by the Company subject to its General Conditions of Service printed overleaf, available on request or accessible at <http://www.sgs.com.tw/Terms-and-Conditions> and for electronic format documents, subject to Terms and Conditions for Electronic Documents at <http://www.sgs.com.tw/Terms-and-Conditions>. Attention is drawn to the limitation of liability, indemnification and jurisdiction issues defined therein. Any holder of this document is advised that information contained hereon reflects the Company's findings at the time of its intervention only and within the limits of Client's instructions, if any. The Company's sole responsibility is to its Client and this document does not exonerate parties to a transaction from exercising all their rights and obligations under the transaction documents. This document cannot be reproduced except in full, without prior written approval of the Company. Any unauthorized alteration, forgery or falsification of the content or appearance of this document is unlawful and offenders may be prosecuted to the fullest extent of the law.

Report Number :TERF2404000927E2  
 Operation Mode :802.11a  
 Test Frequency :5745 MHz  
 Test Mode :Bandedge  
 EUT Pol :E2 Plane

Test Site :SAC G Chamber  
 Test Date :2024-04-26  
 Temp./Humi. :22.3°C/54%  
 Antenna Pol. :Vertical  
 Engineer :Temo Chen

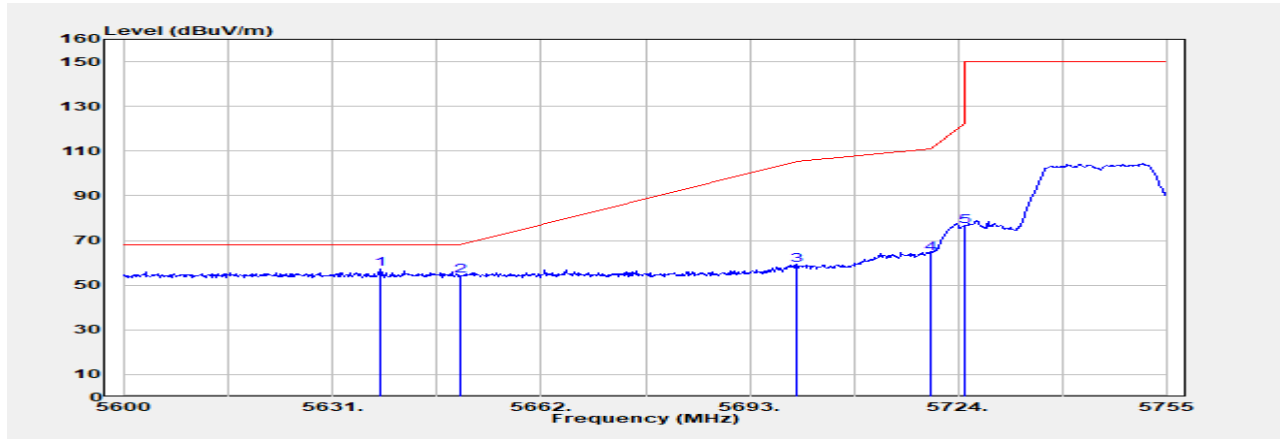

Freq. MHz	Detector Mode PK/QP/AVG	Spectrum Reading Level dBμV	Factor dB	Actual FS dBμV/m	Limit @3m dBμV/m	Margin dB
5637.975	Peak	51.12	5.94	57.05	68.20	-11.15
5650.000	Peak	48.02	6.03	54.04	68.20	-14.16
5700.000	Peak	52.61	6.49	59.10	105.20	-46.10
5720.000	Peak	57.66	6.63	64.29	110.80	-46.51
5725.000	Peak	69.80	6.67	76.47	122.20	-45.73

Unless otherwise stated the results shown in this test report refer only to the sample(s) tested and such sample(s) are retained for 90 days only.

除非另有說明，此報告結果僅對測試之樣品負責，同時此樣品僅保留90天。本報告未經本公司書面許可，不可部份複製。

This document is issued by the Company subject to its General Conditions of Service printed overleaf, available on request or accessible at <http://www.sgs.com.tw/Terms-and-Conditions> and for electronic format documents, subject to Terms and Conditions for Electronic Documents at <http://www.sgs.com.tw/Terms-and-Conditions>. Attention is drawn to the limitation of liability, indemnification and jurisdiction issues defined therein. Any holder of this document is advised that information contained hereon reflects the Company's findings at the time of its intervention only and within the limits of Client's instructions, if any. The Company's sole responsibility is to its Client and this document does not exonerate parties to a transaction from exercising all their rights and obligations under the transaction documents. This document cannot be reproduced except in full, without prior written approval of the Company. Any unauthorized alteration, forgery or falsification of the content or appearance of this document is unlawful and offenders may be prosecuted to the fullest extent of the law.

Report Number :TERF2404000927E2  
 Operation Mode :802.11a  
 Test Frequency :5745 MHz  
 Test Mode :Bandedge  
 EUT Pol :E2 Plane

Test Site :SAC G Chamber  
 Test Date :2024-04-26  
 Temp./Humi. :22.3°C/54%  
 Antenna Pol. :Horizontal  
 Engineer :Temo Chen

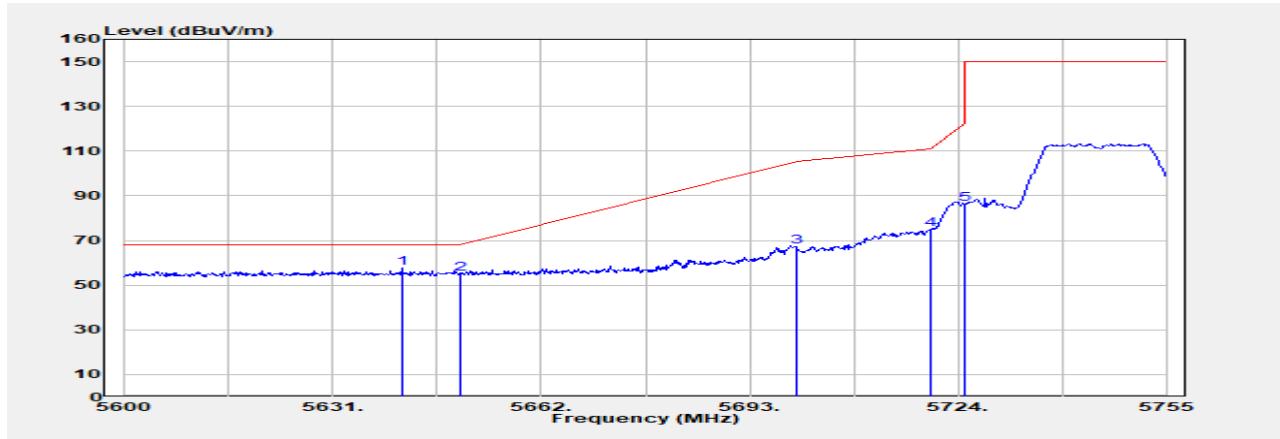

Freq. MHz	Detector Mode PK/QP/AVG	Spectrum Reading Level dBμV	Factor dB	Actual FS dBμV/m	Limit @3m dBμV/m	Margin dB
5641.230	Peak	51.77	5.96	57.74	68.20	-10.46
5650.000	Peak	48.85	6.03	54.87	68.20	-13.33
5700.000	Peak	60.62	6.49	67.11	105.20	-38.09
5720.000	Peak	68.40	6.63	75.04	110.80	-35.76
5725.000	Peak	79.76	6.67	86.42	122.20	-35.78

Unless otherwise stated the results shown in this test report refer only to the sample(s) tested and such sample(s) are retained for 90 days only.

除非另有說明，此報告結果僅對測試之樣品負責，同時此樣品僅保留90天。本報告未經本公司書面許可，不可部份複製。

This document is issued by the Company subject to its General Conditions of Service printed overleaf, available on request or accessible at <http://www.sgs.com.tw/Terms-and-Conditions> and for electronic format documents, subject to Terms and Conditions for Electronic Documents at <http://www.sgs.com.tw/Terms-and-Conditions>. Attention is drawn to the limitation of liability, indemnification and jurisdiction issues defined therein. Any holder of this document is advised that information contained hereon reflects the Company's findings at the time of its intervention only and within the limits of Client's instructions, if any. The Company's sole responsibility is to its Client and this document does not exonerate parties to a transaction from exercising all their rights and obligations under the transaction documents. This document cannot be reproduced except in full, without prior written approval of the Company. Any unauthorized alteration, forgery or falsification of the content or appearance of this document is unlawful and offenders may be prosecuted to the fullest extent of the law.

Report Number :TERF2404000927E2  
 Operation Mode :802.11a  
 Test Frequency :5825 MHz  
 Test Mode :Bandedge  
 EUT Pol :E2 Plane

Test Site :SAC G Chamber  
 Test Date :2024-04-26  
 Temp./Humi. :22.3°C/54%  
 Antenna Pol. :Vertical  
 Engineer :Temo Chen

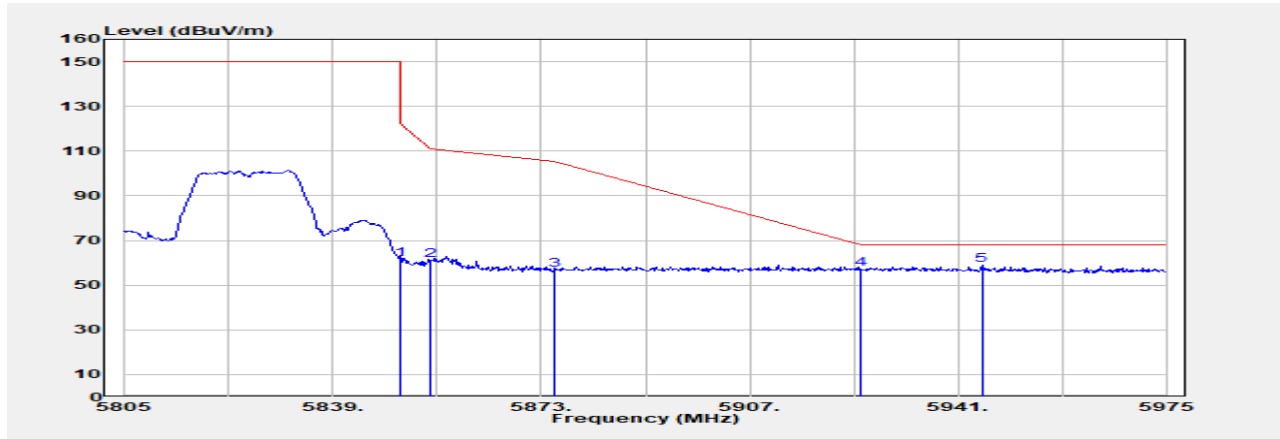

Freq. MHz	Detector Mode PK/QP/AVG	Spectrum Reading Level dB $\mu$ V	Factor dB	Actual FS dB $\mu$ V/m	Limit @3m dB $\mu$ V/m	Margin dB
5850.000	Peak	53.84	7.71	61.55	122.20	-60.65
5855.000	Peak	53.30	7.79	61.09	110.80	-49.71
5875.000	Peak	48.90	8.11	57.01	105.20	-48.19
5925.000	Peak	48.75	8.37	57.12	68.20	-11.08
5944.910	Peak	50.57	8.25	58.82	68.20	-9.38

Unless otherwise stated the results shown in this test report refer only to the sample(s) tested and such sample(s) are retained for 90 days only.

除非另有說明，此報告結果僅對測試之樣品負責，同時此樣品僅保留90天。本報告未經本公司書面許可，不可部份複製。

This document is issued by the Company subject to its General Conditions of Service printed overleaf, available on request or accessible at <http://www.sgs.com.tw/Terms-and-Conditions> and for electronic format documents, subject to Terms and Conditions for Electronic Documents at <http://www.sgs.com.tw/Terms-and-Conditions>. Attention is drawn to the limitation of liability, indemnification and jurisdiction issues defined therein. Any holder of this document is advised that information contained hereon reflects the Company's findings at the time of its intervention only and within the limits of Client's instructions, if any. The Company's sole responsibility is to its Client and this document does not exonerate parties to a transaction from exercising all their rights and obligations under the transaction documents. This document cannot be reproduced except in full, without prior written approval of the Company. Any unauthorized alteration, forgery or falsification of the content or appearance of this document is unlawful and offenders may be prosecuted to the fullest extent of the law.

Report Number :TERF2404000927E2  
 Operation Mode :802.11a  
 Test Frequency :5825 MHz  
 Test Mode :Bandedge  
 EUT Pol :E2 Plane

Test Site :SAC G Chamber  
 Test Date :2024-04-26  
 Temp./Humi. :22.3°C/54%  
 Antenna Pol. :Horizontal  
 Engineer :Temo Chen

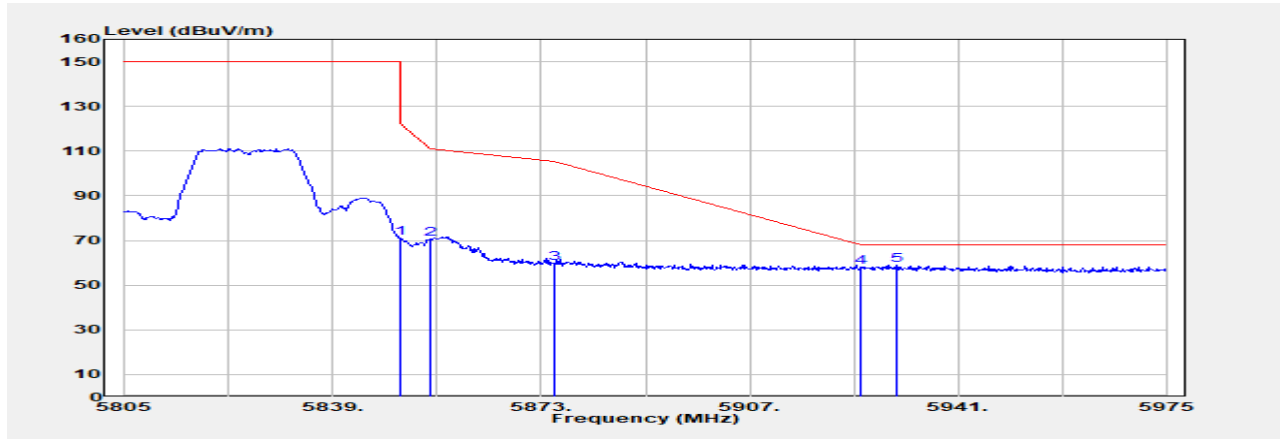

Freq. MHz	Detector Mode PK/QP/AVG	Spectrum Reading Level dB $\mu$ V	Factor dB	Actual FS dB $\mu$ V/m	Limit @3m dB $\mu$ V/m	Margin dB
5850.000	Peak	63.21	7.71	70.91	122.20	-51.29
5855.000	Peak	63.04	7.79	70.83	110.80	-39.97
5875.000	Peak	51.55	8.11	59.66	105.20	-45.54
5925.000	Peak	49.65	8.37	58.02	68.20	-10.18
5931.140	Peak	50.61	8.33	58.95	68.20	-9.25

Unless otherwise stated the results shown in this test report refer only to the sample(s) tested and such sample(s) are retained for 90 days only.

除非另有說明，此報告結果僅對測試之樣品負責，同時此樣品僅保留90天。本報告未經本公司書面許可，不可部份複製。

This document is issued by the Company subject to its General Conditions of Service printed overleaf, available on request or accessible at <http://www.sgs.com.tw/Terms-and-Conditions> and for electronic format documents, subject to Terms and Conditions for Electronic Documents at <http://www.sgs.com.tw/Terms-and-Conditions>. Attention is drawn to the limitation of liability, indemnification and jurisdiction issues defined therein. Any holder of this document is advised that information contained hereon reflects the Company's findings at the time of its intervention only and within the limits of Client's instructions, if any. The Company's sole responsibility is to its Client and this document does not exonerate parties to a transaction from exercising all their rights and obligations under the transaction documents. This document cannot be reproduced except in full, without prior written approval of the Company. Any unauthorized alteration, forgery or falsification of the content or appearance of this document is unlawful and offenders may be prosecuted to the fullest extent of the law.

Report Number :TERF2404000927E2  
 Operation Mode :802.11n20  
 Test Frequency :5180 MHz  
 Test Mode :Bandedge  
 EUT Pol :E2 Plane

Test Site :SAC G Chamber  
 Test Date :2024-05-10  
 Temp./Humi. :24.0°C/51%  
 Antenna Pol. :Vertical  
 Engineer :Temo Chen

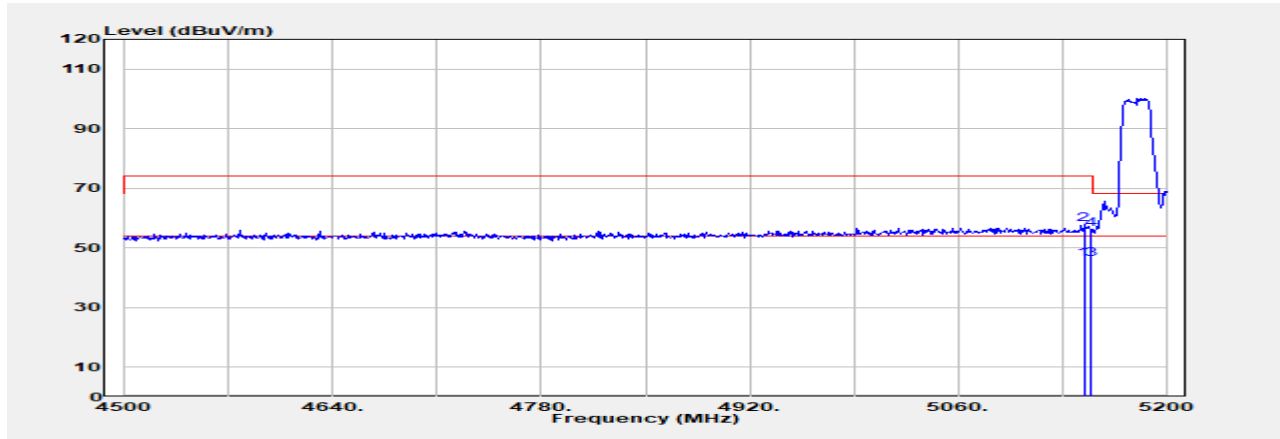

Freq. MHz	Detector Mode PK/QP/AVG	Spectrum Reading Level dBμV	Factor dB	Actual FS dBμV/m	Limit @3m dBμV/m	Margin dB
5144.700	Average	40.78	5.46	46.24	54.00	-7.76
5144.700	Peak	52.39	5.46	57.84	74.00	-16.16
5150.000	Average	40.77	5.42	46.20	54.00	-7.80
5150.000	Peak	50.85	5.42	56.27	74.00	-17.73

Unless otherwise stated the results shown in this test report refer only to the sample(s) tested and such sample(s) are retained for 90 days only.

除非另有說明，此報告結果僅對測試之樣品負責，同時此樣品僅保留90天。本報告未經本公司書面許可，不可部份複製。

This document is issued by the Company subject to its General Conditions of Service printed overleaf, available on request or accessible at <http://www.sgs.com.tw/Terms-and-Conditions> and for electronic format documents, subject to Terms and Conditions for Electronic Documents at <http://www.sgs.com.tw/Terms-and-Conditions>. Attention is drawn to the limitation of liability, indemnification and jurisdiction issues defined therein. Any holder of this document is advised that information contained hereon reflects the Company's findings at the time of its intervention only and within the limits of Client's instructions, if any. The Company's sole responsibility is to its Client and this document does not exonerate parties to a transaction from exercising all their rights and obligations under the transaction documents. This document cannot be reproduced except in full, without prior written approval of the Company. Any unauthorized alteration, forgery or falsification of the content or appearance of this document is unlawful and offenders may be prosecuted to the fullest extent of the law.



Report Number :TERF2404000927E2  
 Operation Mode :802.11n20  
 Test Frequency :5180 MHz  
 Test Mode :Bandedge  
 EUT Pol :E2 Plane

Test Site :SAC G Chamber  
 Test Date :2024-05-10  
 Temp./Humi. :24.0°C/51%  
 Antenna Pol. :Horizontal  
 Engineer :Temo Chen

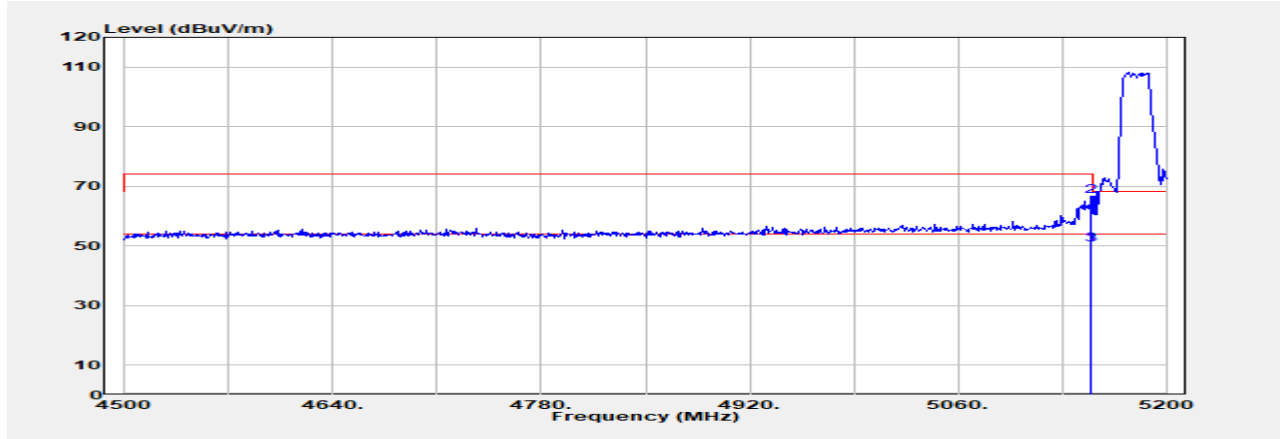

Freq. MHz	Detector Mode PK/QP/AVG	Spectrum Reading Level dBμV	Factor dB	Actual FS dBμV/m	Limit @3m dBμV/m	Margin dB
5149.600	Average	45.04	5.43	50.46	54.00	-3.54
5149.600	Peak	61.27	5.43	66.69	74.00	-7.31
5150.000	Average	45.00	5.42	50.43	54.00	-3.57
5150.000	Peak	55.46	5.42	60.88	74.00	-13.12

Unless otherwise stated the results shown in this test report refer only to the sample(s) tested and such sample(s) are retained for 90 days only.

除非另有說明，此報告結果僅對測試之樣品負責，同時此樣品僅保留90天。本報告未經本公司書面許可，不可部份複製。

This document is issued by the Company subject to its General Conditions of Service printed overleaf, available on request or accessible at <http://www.sgs.com.tw/Terms-and-Conditions> and for electronic format documents, subject to Terms and Conditions for Electronic Documents at <http://www.sgs.com.tw/Terms-and-Conditions>. Attention is drawn to the limitation of liability, indemnification and jurisdiction issues defined therein. Any holder of this document is advised that information contained hereon reflects the Company's findings at the time of its intervention only and within the limits of Client's instructions, if any. The Company's sole responsibility is to its Client and this document does not exonerate parties to a transaction from exercising all their rights and obligations under the transaction documents. This document cannot be reproduced except in full, without prior written approval of the Company. Any unauthorized alteration, forgery or falsification of the content or appearance of this document is unlawful and offenders may be prosecuted to the fullest extent of the law.

Report Number :TERF2404000927E2  
 Operation Mode :802.11n20  
 Test Frequency :5320 MHz  
 Test Mode :Bandedge  
 EUT Pol :E2 Plane

Test Site :SAC G Chamber  
 Test Date :2024-04-26  
 Temp./Humi. :22.3°C/54%  
 Antenna Pol. :Vertical  
 Engineer :Temo Chen

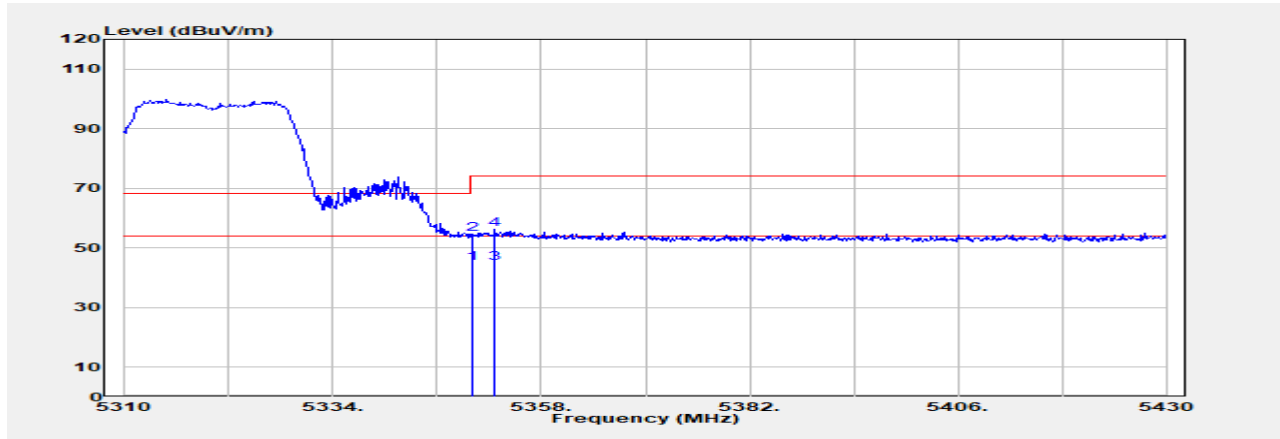

Freq. MHz	Detector Mode PK/QP/AVG	Spectrum Reading Level dBμV	Factor dB	Actual FS dBμV/m	Limit @3m dBμV/m	Margin dB
5350.000	Average	39.75	5.04	44.79	54.00	-9.21
5350.000	Peak	49.72	5.04	54.76	74.00	-19.24
5352.600	Average	39.98	5.04	45.02	54.00	-8.98
5352.600	Peak	51.35	5.04	56.39	74.00	-17.61

Unless otherwise stated the results shown in this test report refer only to the sample(s) tested and such sample(s) are retained for 90 days only.

除非另有說明，此報告結果僅對測試之樣品負責，同時此樣品僅保留90天。本報告未經本公司書面許可，不可部份複製。

This document is issued by the Company subject to its General Conditions of Service printed overleaf, available on request or accessible at <http://www.sgs.com.tw/Terms-and-Conditions> and for electronic format documents, subject to Terms and Conditions for Electronic Documents at <http://www.sgs.com.tw/Terms-and-Conditions>. Attention is drawn to the limitation of liability, indemnification and jurisdiction issues defined therein. Any holder of this document is advised that information contained hereon reflects the Company's findings at the time of its intervention only and within the limits of Client's instructions, if any. The Company's sole responsibility is to its Client and this document does not exonerate parties to a transaction from exercising all their rights and obligations under the transaction documents. This document cannot be reproduced except in full, without prior written approval of the Company. Any unauthorized alteration, forgery or falsification of the content or appearance of this document is unlawful and offenders may be prosecuted to the fullest extent of the law.

Report Number :TERF2404000927E2  
 Operation Mode :802.11n20  
 Test Frequency :5320 MHz  
 Test Mode :Bandedge  
 EUT Pol :E2 Plane

Test Site :SAC G Chamber  
 Test Date :2024-04-26  
 Temp./Humi. :22.3°C/54%  
 Antenna Pol. :Horizontal  
 Engineer :Temo Chen

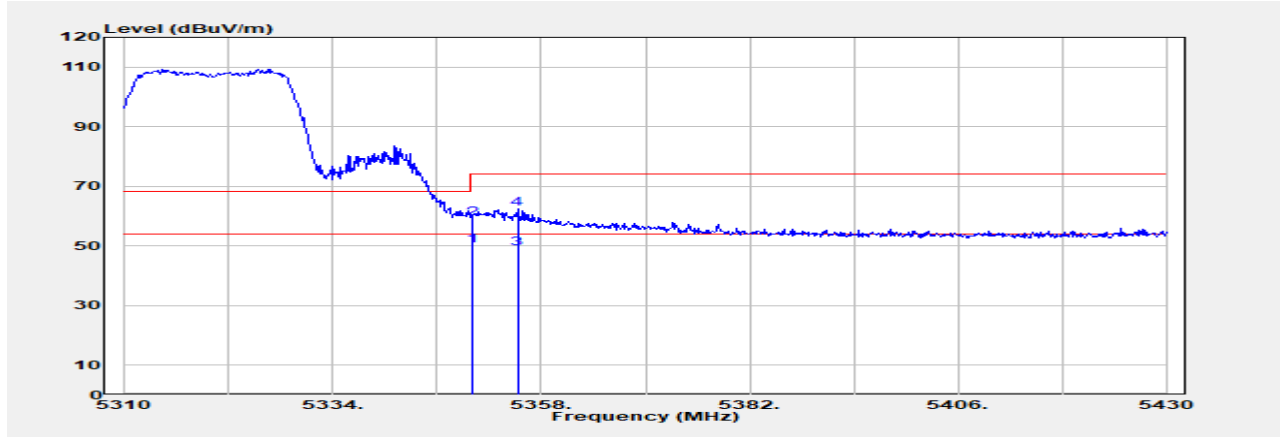

Freq. MHz	Detector Mode PK/QP/AVG	Spectrum Reading Level dB $\mu$ V	Factor dB	Actual FS dB $\mu$ V/m	Limit @3m dB $\mu$ V/m	Margin dB
5350.000	Average	45.02	5.04	50.06	54.00	-3.94
5350.000	Peak	54.30	5.04	59.34	74.00	-14.66
5355.240	Average	44.12	5.04	49.16	54.00	-4.84
5355.240	Peak	57.26	5.04	62.30	74.00	-11.70

Unless otherwise stated the results shown in this test report refer only to the sample(s) tested and such sample(s) are retained for 90 days only.

除非另有說明，此報告結果僅對測試之樣品負責，同時此樣品僅保留90天。本報告未經本公司書面許可，不可部份複製。

This document is issued by the Company subject to its General Conditions of Service printed overleaf, available on request or accessible at <http://www.sgs.com.tw/Terms-and-Conditions> and for electronic format documents, subject to Terms and Conditions for Electronic Documents at <http://www.sgs.com.tw/Terms-and-Conditions>. Attention is drawn to the limitation of liability, indemnification and jurisdiction issues defined therein. Any holder of this document is advised that information contained hereon reflects the Company's findings at the time of its intervention only and within the limits of Client's instructions, if any. The Company's sole responsibility is to its Client and this document does not exonerate parties to a transaction from exercising all their rights and obligations under the transaction documents. This document cannot be reproduced except in full, without prior written approval of the Company. Any unauthorized alteration, forgery or falsification of the content or appearance of this document is unlawful and offenders may be prosecuted to the fullest extent of the law.

Report Number :TERF2404000927E2  
 Operation Mode :802.11n20  
 Test Frequency :5500 MHz  
 Test Mode :Bandedge  
 EUT Pol :E2 Plane

Test Site :SAC G Chamber  
 Test Date :2024-05-10  
 Temp./Humi. :24.0°C/51%  
 Antenna Pol. :Vertical  
 Engineer :Temo Chen

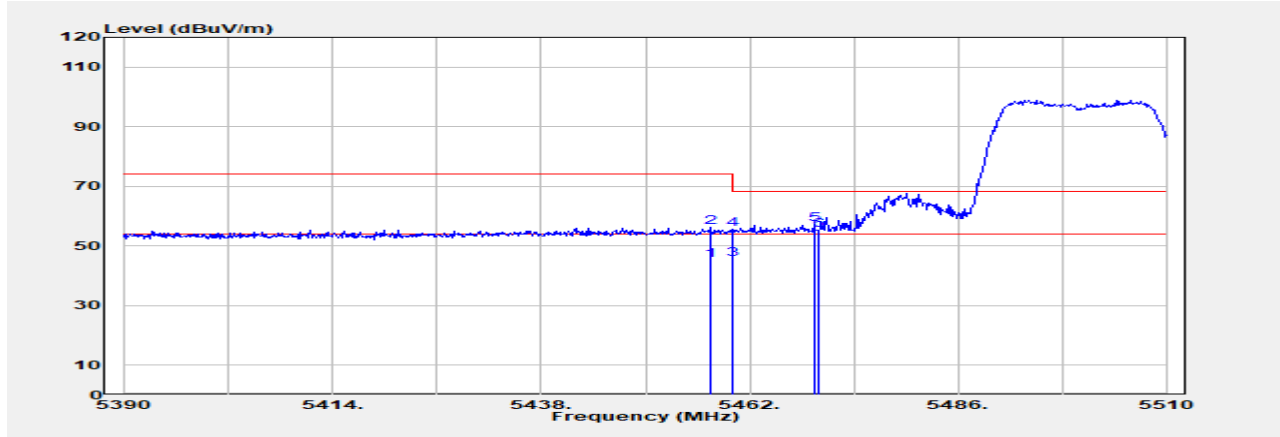

Freq. MHz	Detector Mode PK/QP/AVG	Spectrum Reading Level dBμV	Factor dB	Actual FS dBμV/m	Limit @3m dBμV/m	Margin dB
5457.440	Average	39.60	5.69	45.29	54.00	-8.71
5457.440	Peak	50.47	5.69	56.16	74.00	-17.84
5460.000	Average	39.70	5.71	45.42	54.00	-8.58
5460.000	Peak	49.74	5.71	55.45	74.00	-18.55
5469.440	Peak	51.58	5.80	57.38	68.20	-10.82
5470.000	Peak	49.61	5.81	55.42	68.20	-12.78

Unless otherwise stated the results shown in this test report refer only to the sample(s) tested and such sample(s) are retained for 90 days only.

除非另有說明，此報告結果僅對測試之樣品負責，同時此樣品僅保留90天。本報告未經本公司書面許可，不可部份複製。

This document is issued by the Company subject to its General Conditions of Service printed overleaf, available on request or accessible at <http://www.sgs.com.tw/Terms-and-Conditions> and for electronic format documents, subject to Terms and Conditions for Electronic Documents at <http://www.sgs.com.tw/Terms-and-Conditions>. Attention is drawn to the limitation of liability, indemnification and jurisdiction issues defined therein. Any holder of this document is advised that information contained hereon reflects the Company's findings at the time of its intervention only and within the limits of Client's instructions, if any. The Company's sole responsibility is to its Client and this document does not exonerate parties to a transaction from exercising all their rights and obligations under the transaction documents. This document cannot be reproduced except in full, without prior written approval of the Company. Any unauthorized alteration, forgery or falsification of the content or appearance of this document is unlawful and offenders may be prosecuted to the fullest extent of the law.

Report Number :TERF2404000927E2  
 Operation Mode :802.11n20  
 Test Frequency :5500 MHz  
 Test Mode :Bandedge  
 EUT Pol :E2 Plane

Test Site :SAC G Chamber  
 Test Date :2024-05-10  
 Temp./Humi. :24.0°C/51%  
 Antenna Pol. :Horizontal  
 Engineer :Temo Chen

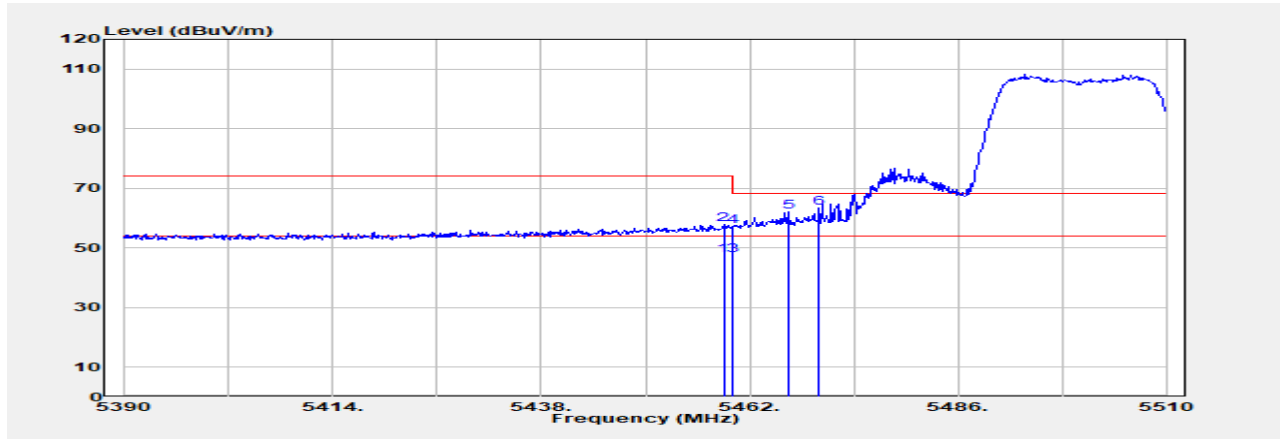

Freq. MHz	Detector Mode PK/QP/AVG	Spectrum Reading Level dBμV	Factor dB	Actual FS dBμV/m	Limit @3m dBμV/m	Margin dB
5459.000	Average	41.83	5.70	47.54	54.00	-6.46
5459.000	Peak	52.32	5.70	58.03	74.00	-15.97
5460.000	Average	41.76	5.71	47.47	54.00	-6.53
5460.000	Peak	51.66	5.71	57.37	74.00	-16.63
5466.440	Peak	56.23	5.77	62.00	68.20	-6.20
5470.000	Peak	57.55	5.81	63.36	68.20	-4.84

Unless otherwise stated the results shown in this test report refer only to the sample(s) tested and such sample(s) are retained for 90 days only.

除非另有說明，此報告結果僅對測試之樣品負責，同時此樣品僅保留90天。本報告未經本公司書面許可，不可部份複製。

This document is issued by the Company subject to its General Conditions of Service printed overleaf, available on request or accessible at <http://www.sgs.com.tw/Terms-and-Conditions> and for electronic format documents, subject to Terms and Conditions for Electronic Documents at <http://www.sgs.com.tw/Terms-and-Conditions>. Attention is drawn to the limitation of liability, indemnification and jurisdiction issues defined therein. Any holder of this document is advised that information contained hereon reflects the Company's findings at the time of its intervention only and within the limits of Client's instructions, if any. The Company's sole responsibility is to its Client and this document does not exonerate parties to a transaction from exercising all their rights and obligations under the transaction documents. This document cannot be reproduced except in full, without prior written approval of the Company. Any unauthorized alteration, forgery or falsification of the content or appearance of this document is unlawful and offenders may be prosecuted to the fullest extent of the law.

Report Number :TERF2404000927E2  
 Operation Mode :802.11n20  
 Test Frequency :5700 MHz  
 Test Mode :Bandedge  
 EUT Pol :E2 Plane

Test Site :SAC G Chamber  
 Test Date :2024-05-10  
 Temp./Humi. :24.0°C/51%  
 Antenna Pol. :Vertical  
 Engineer :Temo Chen

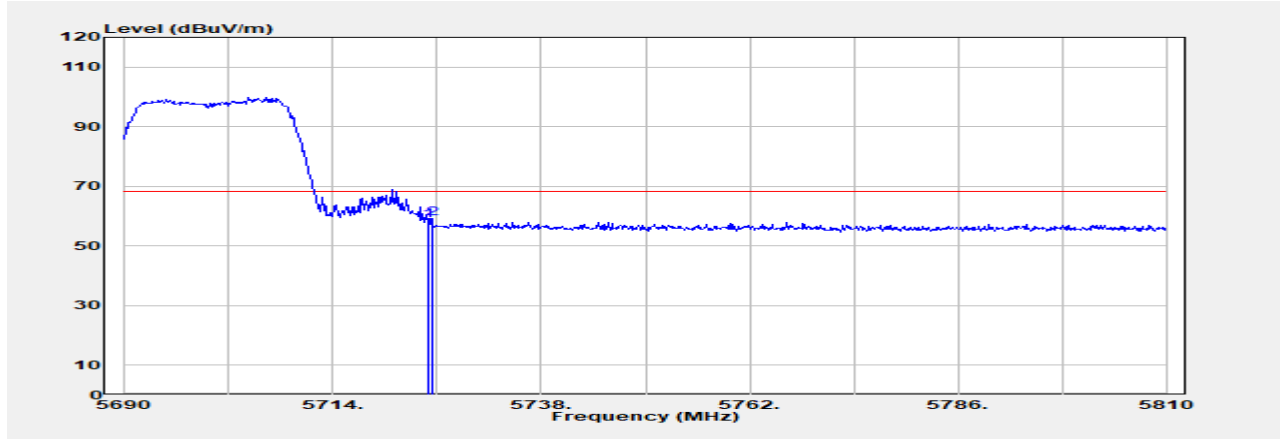

Freq. MHz	Detector Mode PK/QP/AVG	Spectrum Reading Level dB $\mu$ V	Factor dB	Actual FS dB $\mu$ V/m	Limit @3m dB $\mu$ V/m	Margin dB
5725.000	Peak	51.97	6.67	58.64	68.20	-9.56
5725.400	Peak	52.64	6.67	59.31	68.20	-8.89

Unless otherwise stated the results shown in this test report refer only to the sample(s) tested and such sample(s) are retained for 90 days only.

除非另有說明，此報告結果僅對測試之樣品負責，同時此樣品僅保留90天。本報告未經本公司書面許可，不可部份複製。

This document is issued by the Company subject to its General Conditions of Service printed overleaf, available on request or accessible at <http://www.sgs.com.tw/Terms-and-Conditions> and for electronic format documents, subject to Terms and Conditions for Electronic Documents at <http://www.sgs.com.tw/Terms-and-Conditions>. Attention is drawn to the limitation of liability, indemnification and jurisdiction issues defined therein. Any holder of this document is advised that information contained hereon reflects the Company's findings at the time of its intervention only and within the limits of Client's instructions, if any. The Company's sole responsibility is to its Client and this document does not exonerate parties to a transaction from exercising all their rights and obligations under the transaction documents. This document cannot be reproduced except in full, without prior written approval of the Company. Any unauthorized alteration, forgery or falsification of the content or appearance of this document is unlawful and offenders may be prosecuted to the fullest extent of the law.

Report Number :TERF2404000927E2  
 Operation Mode :802.11n20  
 Test Frequency :5700 MHz  
 Test Mode :Bandedge  
 EUT Pol :E2 Plane

Test Site :SAC G Chamber  
 Test Date :2024-05-10  
 Temp./Humi. :24.0°C/51%  
 Antenna Pol. :Horizontal  
 Engineer :Temo Chen

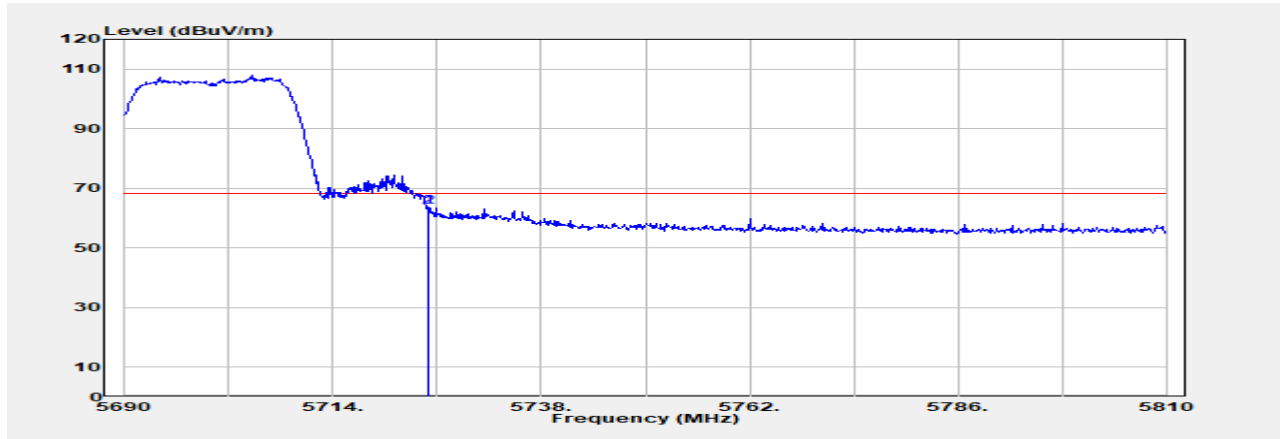

Freq. MHz	Detector Mode PK/QP/AVG	Spectrum Reading Level dB $\mu$ V	Factor dB	Actual FS dB $\mu$ V/m	Limit @3m dB $\mu$ V/m	Margin dB
5725.000	Peak	57.14	6.67	63.81	68.20	-4.39
5725.040	Peak	57.14	6.67	63.81	68.20	-4.39

Unless otherwise stated the results shown in this test report refer only to the sample(s) tested and such sample(s) are retained for 90 days only.

除非另有說明，此報告結果僅對測試之樣品負責，同時此樣品僅保留90天。本報告未經本公司書面許可，不可部份複製。

This document is issued by the Company subject to its General Conditions of Service printed overleaf, available on request or accessible at <http://www.sgs.com.tw/Terms-and-Conditions> and for electronic format documents, subject to Terms and Conditions for Electronic Documents at <http://www.sgs.com.tw/Terms-and-Conditions>. Attention is drawn to the limitation of liability, indemnification and jurisdiction issues defined therein. Any holder of this document is advised that information contained hereon reflects the Company's findings at the time of its intervention only and within the limits of Client's instructions, if any. The Company's sole responsibility is to its Client and this document does not exonerate parties to a transaction from exercising all their rights and obligations under the transaction documents. This document cannot be reproduced except in full, without prior written approval of the Company. Any unauthorized alteration, forgery or falsification of the content or appearance of this document is unlawful and offenders may be prosecuted to the fullest extent of the law.

Report Number :TERF2404000927E2  
 Operation Mode :802.11n20  
 Test Frequency :5720 MHz  
 Test Mode :Bandedge  
 EUT Pol :E2 Plane

Test Site :SAC G Chamber  
 Test Date :2024-04-29  
 Temp./Humi. :20.6°C/62%  
 Antenna Pol. :Vertical  
 Engineer :Temo Chen

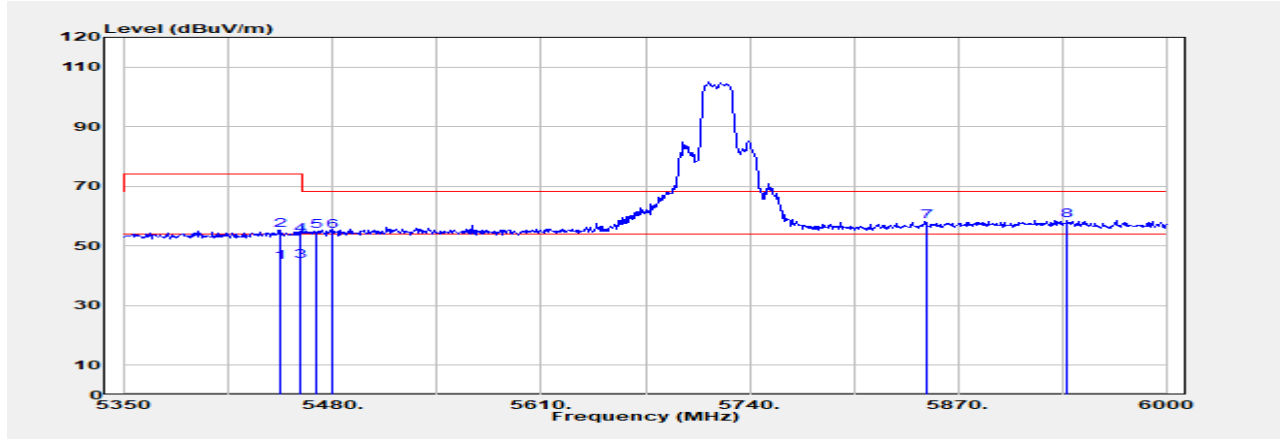

Freq. MHz	Detector Mode PK/QP/AVG	Spectrum Reading Level dBμV	Factor dB	Actual FS dBμV/m	Limit @3m dBμV/m	Margin dB
5447.500	Average	39.07	5.59	44.66	54.00	-9.34
5447.500	Peak	49.56	5.59	55.15	74.00	-18.85
5460.000	Average	39.06	5.71	44.77	54.00	-9.23
5460.000	Peak	47.86	5.71	53.58	74.00	-20.42
5470.000	Peak	49.08	5.81	54.89	68.20	-13.31
5480.000	Peak	48.97	5.90	54.87	68.20	-13.33
5850.000	Peak	50.49	7.71	58.20	68.20	-10.00
5938.250	Peak	50.14	8.29	58.44	68.20	-9.76

Unless otherwise stated the results shown in this test report refer only to the sample(s) tested and such sample(s) are retained for 90 days only.

除非另有說明，此報告結果僅對測試之樣品負責，同時此樣品僅保留90天。本報告未經本公司書面許可，不可部份複製。

This document is issued by the Company subject to its General Conditions of Service printed overleaf, available on request or accessible at <http://www.sgs.com.tw/Terms-and-Conditions> and for electronic format documents, subject to Terms and Conditions for Electronic Documents at <http://www.sgs.com.tw/Terms-and-Conditions>. Attention is drawn to the limitation of liability, indemnification and jurisdiction issues defined therein. Any holder of this document is advised that information contained hereon reflects the Company's findings at the time of its intervention only and within the limits of Client's instructions, if any. The Company's sole responsibility is to its Client and this document does not exonerate parties to a transaction from exercising all their rights and obligations under the transaction documents. This document cannot be reproduced except in full, without prior written approval of the Company. Any unauthorized alteration, forgery or falsification of the content or appearance of this document is unlawful and offenders may be prosecuted to the fullest extent of the law.



Report Number :TERF2404000927E2  
 Operation Mode :802.11n20  
 Test Frequency :5720 MHz  
 Test Mode :Bandedge  
 EUT Pol :E2 Plane

Test Site :SAC G Chamber  
 Test Date :2024-04-29  
 Temp./Humi. :20.6°C/62%  
 Antenna Pol. :Horizontal  
 Engineer :Temo Chen

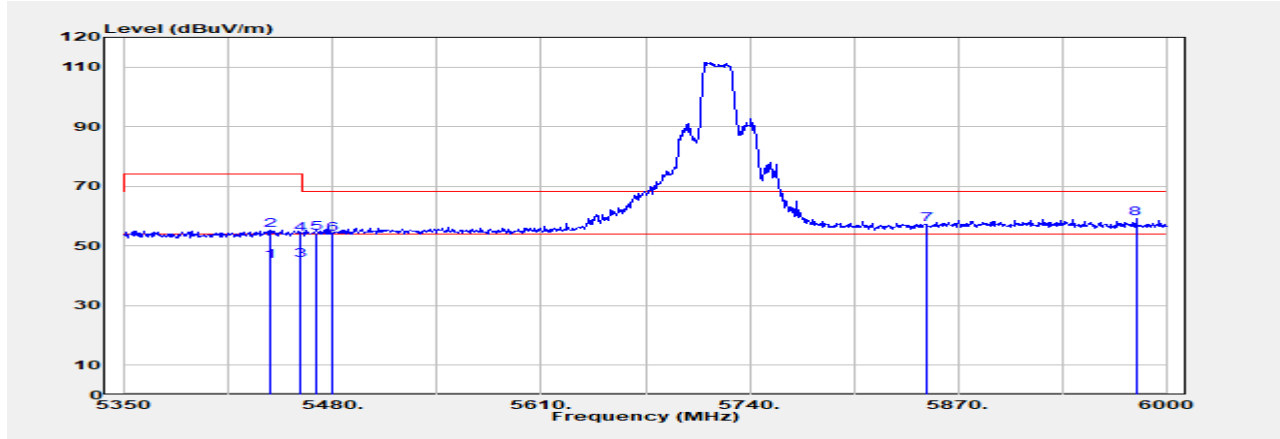

Freq. MHz	Detector Mode PK/QP/AVG	Spectrum Reading Level dB $\mu$ V	Factor dB	Actual FS dB $\mu$ V/m	Limit @3m dB $\mu$ V/m	Margin dB
5440.350	Average	39.34	5.51	44.86	54.00	-9.14
5440.350	Peak	49.93	5.51	55.44	74.00	-18.56
5460.000	Average	39.51	5.71	45.22	54.00	-8.78
5460.000	Peak	48.37	5.71	54.08	74.00	-19.92
5470.000	Peak	48.56	5.81	54.37	68.20	-13.83
5480.000	Peak	48.06	5.90	53.95	68.20	-14.25
5850.000	Peak	49.52	7.71	57.23	68.20	-10.97
5981.150	Peak	51.10	8.05	59.15	68.20	-9.05

Unless otherwise stated the results shown in this test report refer only to the sample(s) tested and such sample(s) are retained for 90 days only.

除非另有說明，此報告結果僅對測試之樣品負責，同時此樣品僅保留90天。本報告未經本公司書面許可，不可部份複製。

This document is issued by the Company subject to its General Conditions of Service printed overleaf, available on request or accessible at <http://www.sgs.com.tw/Terms-and-Conditions> and for electronic format documents, subject to Terms and Conditions for Electronic Documents at <http://www.sgs.com.tw/Terms-and-Conditions>. Attention is drawn to the limitation of liability, indemnification and jurisdiction issues defined therein. Any holder of this document is advised that information contained hereon reflects the Company's findings at the time of its intervention only and within the limits of Client's instructions, if any. The Company's sole responsibility is to its Client and this document does not exonerate parties to a transaction from exercising all their rights and obligations under the transaction documents. This document cannot be reproduced except in full, without prior written approval of the Company. Any unauthorized alteration, forgery or falsification of the content or appearance of this document is unlawful and offenders may be prosecuted to the fullest extent of the law.

Report Number :TERF2404000927E2  
 Operation Mode :802.11n20  
 Test Frequency :5745 MHz  
 Test Mode :Bandedge  
 EUT Pol :E2 Plane

Test Site :SAC G Chamber  
 Test Date :2024-04-29  
 Temp./Humi. :20.6°C/62%  
 Antenna Pol. :Vertical  
 Engineer :Temo Chen

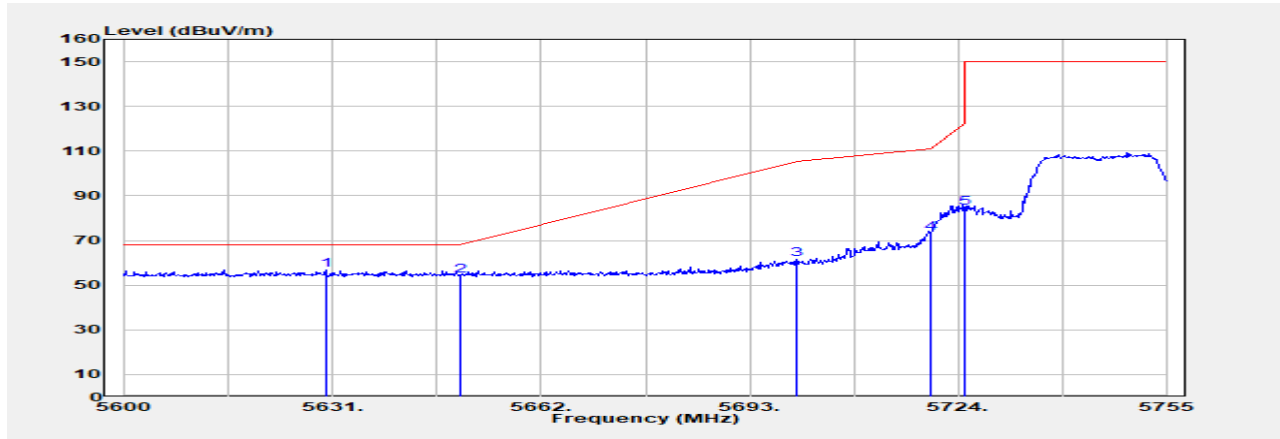

Freq. MHz	Detector Mode PK/QP/AVG	Spectrum Reading Level dB $\mu$ V	Factor dB	Actual FS dB $\mu$ V/m	Limit @3m dB $\mu$ V/m	Margin dB
5629.915	Peak	51.13	5.88	57.01	68.20	-11.19
5650.000	Peak	48.36	6.03	54.39	68.20	-13.81
5700.000	Peak	54.97	6.49	61.46	105.20	-43.74
5720.000	Peak	66.79	6.63	73.42	110.80	-37.38
5725.000	Peak	77.89	6.67	84.56	122.20	-37.64

Unless otherwise stated the results shown in this test report refer only to the sample(s) tested and such sample(s) are retained for 90 days only.

除非另有說明，此報告結果僅對測試之樣品負責，同時此樣品僅保留90天。本報告未經本公司書面許可，不可部份複製。

This document is issued by the Company subject to its General Conditions of Service printed overleaf, available on request or accessible at <http://www.sgs.com.tw/Terms-and-Conditions> and for electronic format documents, subject to Terms and Conditions for Electronic Documents at <http://www.sgs.com.tw/Terms-and-Conditions>. Attention is drawn to the limitation of liability, indemnification and jurisdiction issues defined therein. Any holder of this document is advised that information contained hereon reflects the Company's findings at the time of its intervention only and within the limits of Client's instructions, if any. The Company's sole responsibility is to its Client and this document does not exonerate parties to a transaction from exercising all their rights and obligations under the transaction documents. This document cannot be reproduced except in full, without prior written approval of the Company. Any unauthorized alteration, forgery or falsification of the content or appearance of this document is unlawful and offenders may be prosecuted to the fullest extent of the law.

Report Number :TERF2404000927E2  
 Operation Mode :802.11n20  
 Test Frequency :5745 MHz  
 Test Mode :Bandedge  
 EUT Pol :E2 Plane

Test Site :SAC G Chamber  
 Test Date :2024-04-29  
 Temp./Humi. :20.6°C/62%  
 Antenna Pol. :Horizontal  
 Engineer :Temo Chen

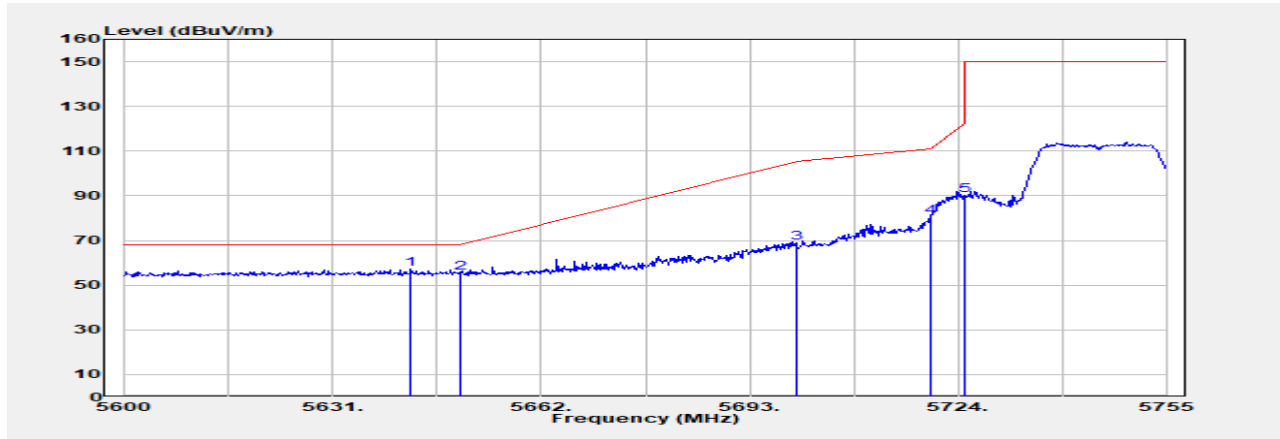

Freq. MHz	Detector Mode PK/QP/AVG	Spectrum Reading Level dB $\mu$ V	Factor dB	Actual FS dB $\mu$ V/m	Limit @3m dB $\mu$ V/m	Margin dB
5642.625	Peak	51.05	5.97	57.02	68.20	-11.18
5650.000	Peak	49.30	6.03	55.33	68.20	-12.87
5700.000	Peak	62.50	6.49	68.99	105.20	-36.21
5720.000	Peak	73.89	6.63	80.52	110.80	-30.28
5725.000	Peak	83.51	6.67	90.18	122.20	-32.02

Unless otherwise stated the results shown in this test report refer only to the sample(s) tested and such sample(s) are retained for 90 days only.

除非另有說明，此報告結果僅對測試之樣品負責，同時此樣品僅保留90天。本報告未經本公司書面許可，不可部份複製。

This document is issued by the Company subject to its General Conditions of Service printed overleaf, available on request or accessible at <http://www.sgs.com.tw/Terms-and-Conditions> and for electronic format documents, subject to Terms and Conditions for Electronic Documents at <http://www.sgs.com.tw/Terms-and-Conditions>. Attention is drawn to the limitation of liability, indemnification and jurisdiction issues defined therein. Any holder of this document is advised that information contained hereon reflects the Company's findings at the time of its intervention only and within the limits of Client's instructions, if any. The Company's sole responsibility is to its Client and this document does not exonerate parties to a transaction from exercising all their rights and obligations under the transaction documents. This document cannot be reproduced except in full, without prior written approval of the Company. Any unauthorized alteration, forgery or falsification of the content or appearance of this document is unlawful and offenders may be prosecuted to the fullest extent of the law.

Report Number :TERF2404000927E2  
 Operation Mode :802.11n20  
 Test Frequency :5825 MHz  
 Test Mode :Bandedge  
 EUT Pol :E2 Plane

Test Site :SAC G Chamber  
 Test Date :2024-04-29  
 Temp./Humi. :20.6°C/62%  
 Antenna Pol. :Vertical  
 Engineer :Temo Chen

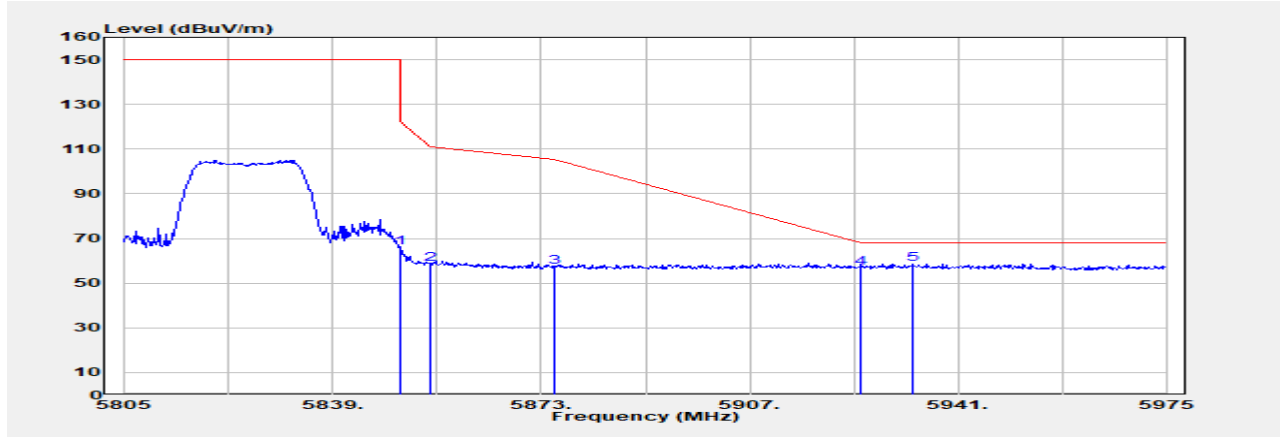

Freq. MHz	Detector Mode PK/QP/AVG	Spectrum Reading Level dB $\mu$ V	Factor dB	Actual FS dB $\mu$ V/m	Limit @3m dB $\mu$ V/m	Margin dB
5850.000	Peak	58.24	7.71	65.95	122.20	-56.25
5855.000	Peak	50.84	7.79	58.63	110.80	-52.17
5875.000	Peak	49.01	8.11	57.12	105.20	-48.08
5925.000	Peak	48.27	8.37	56.64	68.20	-11.56
5933.690	Peak	50.37	8.32	58.69	68.20	-9.51

Unless otherwise stated the results shown in this test report refer only to the sample(s) tested and such sample(s) are retained for 90 days only.

除非另有說明，此報告結果僅對測試之樣品負責，同時此樣品僅保留90天。本報告未經本公司書面許可，不可部份複製。

This document is issued by the Company subject to its General Conditions of Service printed overleaf, available on request or accessible at <http://www.sgs.com.tw/Terms-and-Conditions> and for electronic format documents, subject to Terms and Conditions for Electronic Documents at <http://www.sgs.com.tw/Terms-and-Conditions>. Attention is drawn to the limitation of liability, indemnification and jurisdiction issues defined therein. Any holder of this document is advised that information contained hereon reflects the Company's findings at the time of its intervention only and within the limits of Client's instructions, if any. The Company's sole responsibility is to its Client and this document does not exonerate parties to a transaction from exercising all their rights and obligations under the transaction documents. This document cannot be reproduced except in full, without prior written approval of the Company. Any unauthorized alteration, forgery or falsification of the content or appearance of this document is unlawful and offenders may be prosecuted to the fullest extent of the law.

Report Number :TERF2404000927E2  
 Operation Mode :802.11n20  
 Test Frequency :5825 MHz  
 Test Mode :Bandedge  
 EUT Pol :E2 Plane

Test Site :SAC G Chamber  
 Test Date :2024-04-29  
 Temp./Humi. :20.6°C/62%  
 Antenna Pol. :Horizontal  
 Engineer :Temo Chen

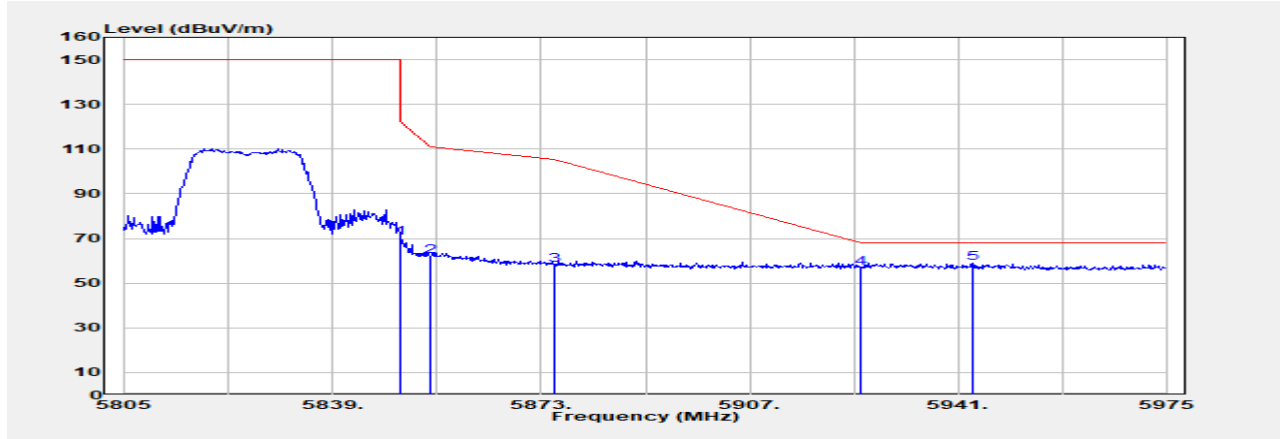

Freq. MHz	Detector Mode PK/QP/AVG	Spectrum Reading Level dB $\mu$ V	Factor dB	Actual FS dB $\mu$ V/m	Limit @3m dB $\mu$ V/m	Margin dB
5850.000	Peak	62.58	7.71	70.29	122.20	-51.91
5855.000	Peak	54.22	7.79	62.01	110.80	-48.79
5875.000	Peak	50.11	8.11	58.22	105.20	-46.98
5925.000	Peak	48.41	8.37	56.78	68.20	-11.42
5943.380	Peak	50.82	8.26	59.08	68.20	-9.12

Unless otherwise stated the results shown in this test report refer only to the sample(s) tested and such sample(s) are retained for 90 days only.

除非另有說明，此報告結果僅對測試之樣品負責，同時此樣品僅保留90天。本報告未經本公司書面許可，不可部份複製。

This document is issued by the Company subject to its General Conditions of Service printed overleaf, available on request or accessible at <http://www.sgs.com.tw/Terms-and-Conditions> and for electronic format documents, subject to Terms and Conditions for Electronic Documents at <http://www.sgs.com.tw/Terms-and-Conditions>. Attention is drawn to the limitation of liability, indemnification and jurisdiction issues defined therein. Any holder of this document is advised that information contained hereon reflects the Company's findings at the time of its intervention only and within the limits of Client's instructions, if any. The Company's sole responsibility is to its Client and this document does not exonerate parties to a transaction from exercising all their rights and obligations under the transaction documents. This document cannot be reproduced except in full, without prior written approval of the Company. Any unauthorized alteration, forgery or falsification of the content or appearance of this document is unlawful and offenders may be prosecuted to the fullest extent of the law.

## 12 TRANSMISSION IN THE ABSENCE OF DATA

### 12.1 Standard Applicable

According to §15.407(c) & RSS-247 §6.4

The device shall automatically discontinue transmission in case of either absence of information to transmit or operational failure. These provisions are not intended to preclude the transmission of control or signaling information or the use of repetitive codes used by certain digital technologies to complete frame or burst intervals. Applicants shall include in their application for equipment authorization a description of how this requirement is met.

### 12.2 Result

While the EUT is not transmitting any information, the EUT can automatically discontinue transmission and become standby mode for power saving. The EUT can detect the controlling signal of ASK message transmitting from remote device and verify whether it shall resend or discontinue transmission.

Unless otherwise stated the results shown in this test report refer only to the sample(s) tested and such sample(s) are retained for 90 days only.  
除非另有說明，此報告結果僅對測試之樣品負責，同時此樣品僅保留90天。本報告未經本公司書面許可，不可部份複製。

This document is issued by the Company subject to its General Conditions of Service printed overleaf, available on request or accessible at <http://www.sgs.com.tw/Terms-and-Conditions> and for electronic format documents, subject to Terms and Conditions for Electronic Documents at <http://www.sgs.com.tw/Terms-and-Conditions>. Attention is drawn to the limitation of liability, indemnification and jurisdiction issues defined therein. Any holder of this document is advised that information contained hereon reflects the Company's findings at the time of its intervention only and within the limits of Client's instructions, if any. The Company's sole responsibility is to its Client and this document does not exonerate parties to a transaction from exercising all their rights and obligations under the transaction documents. This document cannot be reproduced except in full, without prior written approval of the Company. Any unauthorized alteration, forgery or falsification of the content or appearance of this document is unlawful and offenders may be prosecuted to the fullest extent of the law.

## 13 ANTENNA REQUIREMENT

### 13.1 Standard Applicable

An intentional radiator shall be designed to ensure that no antenna other than that furnished by the responsible party shall be used with the device. The use of a permanently attached antenna or of an antenna that uses a unique coupling to the intentional radiator shall be considered sufficient to comply with the provisions of this section. The manufacturer may design the unit so that a broken antenna can be replaced by the user, but the use of a standard antenna jack or electrical connector is prohibited. This requirement does not apply to carrier current devices or to devices operated under the provisions of §§ 15.211, 15.213, 15.217, 15.219, 15.221, or § 15.236. Further, this requirement does not apply to intentional radiators that must be professionally installed, such as perimeter protection systems and some field disturbance sensors, or to other intentional radiators which, in accordance with § 15.31(d), must be measured at the installation site. However, the installer shall be responsible for ensuring that the proper antenna is employed so that the limits in this part are not exceeded.

### 13.2 Antenna Connected Construction:

The antenna complies with this requirement and no consideration of replacement. Please see EUT photo for details.

*~ End of Report ~*

Unless otherwise stated the results shown in this test report refer only to the sample(s) tested and such sample(s) are retained for 90 days only.  
除非另有說明，此報告結果僅對測試之樣品負責，同時此樣品僅保留90天。本報告未經本公司書面許可，不可部份複製。

This document is issued by the Company subject to its General Conditions of Service printed overleaf, available on request or accessible at <http://www.sgs.com.tw/Terms-and-Conditions> and for electronic format documents, subject to Terms and Conditions for Electronic Documents at <http://www.sgs.com.tw/Terms-and-Conditions>. Attention is drawn to the limitation of liability, indemnification and jurisdiction issues defined therein. Any holder of this document is advised that information contained hereon reflects the Company's findings at the time of its intervention only and within the limits of Client's instructions, if any. The Company's sole responsibility is to its Client and this document does not exonerate parties to a transaction from exercising all their rights and obligations under the transaction documents. This document cannot be reproduced except in full, without prior written approval of the Company. Any unauthorized alteration, forgery or falsification of the content or appearance of this document is unlawful and offenders may be prosecuted to the fullest extent of the law.