



Test report No:
2260325R-RF-US-P06V01

FCC & ISED TEST REPORT

Product Name	WLAN+Bluetooth Module
Trademark	Murata
Model and /or type reference	LBEE5HY2DU
FCC ID	VPYLB2DU
IC	772C-LB2DU
Applicant's name / address	Murata Manufacturing Co., Ltd. 10-1, Higashikotari 1-chome, Nagaokakyo-shi, Kyoto 617-8555, Japan
Test method requested, standard	FCC CFR Title 47 Part 15 Subpart C Section 15.247 ANSI C63.10: 2013 KDB558074 D01 15.247 Meas Guidance v05r02 RSS-Gen Issue 5 /RSS-247 Issue 2
Verdict Summary	IN COMPLIANCE
Tested by (name / position & signature)	Tim Cao/ Project Engineer 
Approved by (name / position & signature)	Jack Zhang/ Manager 
Date of issue	2022-07-31
Report Version	V1.0
Report template No	Template_FCC 15.247-RF-V1.0

INDEX

	page
General conditions	5
Environmental conditions	5
Possible test case verdicts	6
Abbreviations	6
Document History	7
Remarks and Comments.....	7
Used Equipment	8
Uncertainty	10
1 General Information.....	11
1.1 General Description of the Item(s)	11
1.2 Antenna Information	12
1.3 Channel List	13
1.4 Power Setting.....	13
2 Description of Test Setup	14
2.1 Operating mode(s) used for tests.....	14
2.2 Accessories Information	14
2.3 Auxiliary equipment / Test software for the EUT.....	14
2.4 Test Configuration / Block diagram used for tests	15
2.5 Testing process.....	16
3 Verdict summary section	17
3.1 Standards.....	17
3.2 Deviation(s) from the Standard(s) / Test Specification(s).....	17
3.3 Overview of results.....	18
3.4 Test Facility.....	20
4 Test Results	21
4.1 Conducted Emission.....	21
4.1.1 Limit	21
4.1.2 Test Setup.....	21
4.1.3 Test Procedure.....	21
4.1.4 Test Data	22
4.2 Emissions in restricted frequency bands	23
4.2.1 Limit	23
4.2.2 Test Setup.....	25
4.2.3 Test Procedure.....	26

4.2.4	Test Data	27
4.3	20dB Bandwidth	49
4.3.1	Limit	49
4.3.2	Test Setup.....	49
4.3.3	Test Procedure.....	49
4.3.4	Test Data	50
4.4	CarrierFrequencySeparation.....	51
4.4.1	Limit	51
4.4.2	Test Setup.....	51
4.4.3	Test Procedure.....	51
4.4.4	Test Data	52
4.5	Number of hopping Frequencies.....	53
4.5.1	Limit	53
4.5.2	Test Setup.....	53
4.5.3	Test Procedure.....	53
4.5.4	Test Data	54
4.6	Time of Occupancy(Dwell Time).....	55
4.6.1	Limit	55
4.6.2	Test Setup.....	55
4.6.3	Test Procedure.....	55
4.6.4	Test Data	56
4.7	Peak Output Power	59
4.7.1	Limit	59
4.7.2	Test Setup.....	59
4.7.3	Test Procedure.....	60
4.7.4	Test Data	61
4.8	Emissions in non-restricted frequency band.....	62
4.8.1	Limit	62
4.8.2	Test Setup.....	62
4.8.3	Test Procedure.....	62
4.8.4	Test Data	63
4.9	Duty cycle	67
4.9.1	Limit	67
4.9.2	Test Setup.....	67
4.9.3	Test Procedure.....	67
4.9.4	Test Data	68
4.10	Band Edge	69

4.10.1	Limit	69
4.10.2	Test Setup.....	69
4.10.3	Test Procedure.....	69
4.10.4	Test Data	70
4.11	Antenna Requirement.....	94
4.11.1	Limit:	94
4.11.2	Antenna Connector Construction:	94
5	Test setup photo and EUT Photo.....	95

COMPETENCES AND GUARANTEES

DEKRA is a testing laboratory competent to carry out the tests described in this report.

In order to assure the traceability to other national and international laboratories, DEKRA has a calibration and maintenance program for its measurement equipment.

DEKRA guarantees the reliability of the data presented in this report, which is the result of the measurements and the tests performed to the item under test on the date and under the conditions stated in the report and it is based on the knowledge and technical facilities available at DEKRA at the time of performance of the test.

DEKRA is liable to the client for the maintenance of the confidentiality of all information related to the item under test and the results of the test.

The results presented in this Test Report apply only to the particular item under test established in this document.

IMPORTANT: No parts of this report may be reproduced or quoted out of context, in any form or by any means, except in full, without the previous written permission of DEKRA.

GENERAL CONDITIONS

Test Location	No. 99, Hongye Road, Suzhou Industrial Park Suzhou, 215006, P.R. China
Date(receive sample)	Jun. 20, 2022
Date (start test)	Jun. 20, 2022
Date (finish test)	Jul. 20, 2022

1. This report is only referred to the item that has undergone the test.
2. This report does not constitute or imply on its own an approval of the product by the Certification Bodies or Competent Authorities.
3. This document is only valid if complete; no partial reproduction can be made without previous written permission of DEKRA.
4. This test report cannot be used partially or in full for publicity and/or promotional purposes without previous written permission of DEKRA.

ENVIRONMENTAL CONDITIONS

The climatic conditions during the tests are within the limits specified by the manufacturer for the operation of the EUT and the test equipment. The climatic conditions during the tests were within the following limits:

Ambient temperature	15 °C – 35 °C
Relative Humidity air	30% - 60%

If explicitly required in the basic standard or applied product / product family standard the climatic values are recorded and documented separately in this test report.

POSSIBLE TEST CASE VERDICTS

Test case does not apply to test object	N/A
Test object does meet requirement	P (Pass) / PASS
Test object does not meet requirement	F (Fail) / FAIL
Not measured	N/M

ABBREVIATIONS

For the purposes of the present document, the following abbreviations apply:

EUT	: Equipment Under Test
QP	: Quasi-Peak
CAV	: CISPR Average
AV	: Average
CDN	: Coupling Decoupling Network
SAC	: Semi-Anechoic Chamber
OATS	: Open Area Test Site
BW	: Bandwidth
AM	: Amplitude Modulation
PM	: Pulse Modulation
HCP	: Horizontal Coupling Plane
VCP	: Vertical Coupling Plane
U_N	: Nominal voltage
T_x	: Transmitter
R_x	: Receiver
N/A	: Not Applicable
N/M	: Not Measured

DOCUMENT HISTORY

Report No.	Version	Description	Issued Date
2260325R-RF-US-P06V01	V1.0	Initial issue of report.	2022-07-31

REMARKS AND COMMENTS

1. The equipment under test (EUT) does meet the essential requirements of the stated standard(s)/test(s).
2. These test results on a sample of the device are for the purpose of demonstrating Compliance with Part 15 Subpart C Paragraph 15.247, RSS-Gen Issue 5, RSS-247 Issue 2.
3. The measurement result is considered in conformance with the requirement if it is within the prescribed limit, It is not necessary to account the uncertainty associated with the measurement result.
4. The test results presented in this report relate only to the object tested.
5. The test report shall not be reproduced without the written approval of DEKRA Testing and Certification (Suzhou) Co., Ltd.
6. This report will not be used for social proof function in China market.
7. DEKRA declines any responsibility with the following test data provided by customer that may affect the validity of result:
 - Chapter 1.1 General Description of the Item(s);
 - Chapter 1.2 Antenna Information ;
 - Chapter 1.3 Channel List ;
 - Chapter 1.3 Power Setting.

USED EQUIPMENT

AC Power Line Conducted Emission / TR1

Instrument	Manufacturer	Model No.	Serial No.	Cal. Date	Next Cal. Date
EMI Test Receiver	R&S	ESCI	100573	2021.10.30	2022.10.29
Two-Line V-Network	R&S	ENV216	101044	2022.03.12	2023.03.11
Current Probe	R&S	EZ-17	100678	2021.12.31	2022.12.30
50ohm Termination	SHX	TF2	07081403	2021.09.04	2022.09.03
50ohm Coaxial Switch	Anritsu	MP59B	6200464462	N/A	N/A
Temperature/Humidity Meter	RTS	RTS-8S	TR1-TH	2021.07.09	2022.07.08
Temperature/Humidity Meter	RTS	RTS-8S	TR1-TH	2022.07.07	2023.07.06
Coaxial Cable	Suhner	RG 223	TR1-C2	2022.03.21	2023.03.20
Dekra test software	Dekra	-	-	-	-

Emissions in non-restricted frequency bands/ Occupied Bandwidth/ Fundamental emission output power/ Power Spectral Density/Band Edge/ TR8

Instrument	Manufacturer	Model No.	Serial No.	Cal. Date	Next Cal. Date
MAX Signal Analyzer	Agilent	N9020A	MY49100159	2021.11.17	2022.11.16
MXA Signal Analyzer	Keysight	N9020A	MY56060147	2021.11.18	2022.11.17
Temperature/Humidity Meter	RTS	RTS-8S	RF08	2021.07.09	2022.07.08
Temperature/Humidity Meter	RTS	RTS-8S	RF08	2022.07.07	2023.07.06
Temperature/Humidity Meter	RTS	RTS-8S	RF08	2021.07.09	2022.07.08

Radiated Emission(30MHz-1GHz) / AC3

Instrument	Manufacturer	Model No.	Serial No.	Cal. Date	Next Cal. Date
EMI Test Receiver	R&S	ESCI	100573	2021.10.30	2022.10.29
Loop Antenna	R&S	HFH2-Z2	833799/003	2022.04.15	2023.04.14
Bilog Antenna	Teseq GmbH	CBL6112D	27611	2021.12.03	2022.12.02
Temperature/Humidity Meter	RTS	RTS-8S	AC3-TH	2021.07.09	2022.07.08
Temperature/Humidity Meter	RTS	RTS-8S	AC3-TH	2022.07.07	2023.07.06
Coaxial Cable	Huber+Suhner	RG 214	AC3-C	2022.03.21	2023.03.20
Dekra test software	Dekra	-	-	-	-

Radiated Emission(1GHz-40GHz) / AC5

Instrument	Manufacturer	Model No.	Serial No.	Cal. Date	Next Cal. Date
EXA Spectrum Analyzer	Keysight	N9010A	MY55370495	2021.08.12	2022.08.11
Pre-Amplifier	SKET	LNPA_0118G-45	SK2021090101	2021.12.13	2022.12.12
Preamplifier	CHENGYI	EMC184045SE	980263	2022.05.21	2023.05.20
DRG Horn	ETS-Lindgren	3117	00123988	2021.10.22	2022.10.21
Broad-Band Horn Antenna	Schwarzbeck	BBHA9170	294	2022.05.19	2023.05.18
Temperature/Humidity Meter	RTS	RTS-8S	AC5-TH	2021.07.09	2022.07.08
Temperature/Humidity Meter	RTS	RTS-8S	AC5-TH	2022.07.07	2023.07.06
Coaxial Cable	Huber+Suhner	SUCOFLEX 106	AC5-C1	2022.03.21	2023.03.20
Coaxial Cable	Huber+Suhner	SUCOFLEX 106	AC5-C2	2022.03.21	2023.03.20
Coaxial Cable	Huber+Suhner	SUCOFLEX 102	AC5-C3	2022.03.21	2023.03.20
Dekra test software	Dekra	-	-	-	-

UNCERTAINTY

Uncertainties have been calculated according to the DEKRA internal document. The reported expanded uncertainties are based on a standard uncertainty multiplied by a coverage factor of $k=2$, providing a level of confidence of approximately 95%. The Uncertainties is comply with standard required as below.

Test item	Uncertainty
Conducted Emission	± 2.02 dB
Emissions in restricted frequency bands	above 1G : ± 3.9 dB below 1G : ± 3.8 dB
20dB Bandwidth	± 1 kHz
Carrier Frequency Separation	± 1 kHz
Number of Hopping Frequencies	± 1 kHz
Time of Occupancy (Dwell Time)	± 0.1 us
Peak Output Power	± 1.0 dB
Emissions in non-restricted frequency bands	± 1.0 dB
Radiated Emission Band Edge	above 1G : ± 3.9 dB below 1G : ± 3.8 dB

1 GENERAL INFORMATION

1.1 General Description of the Item(s)

Product Name..... :	WLAN+Bluetooth Module
Model No. :	LBEE5HY2DU
FCC ID :	VPYLB2DU
IC :	772C-LB2DU
Hardware Version :	1.0
Software Version..... :	1.0
Manufacturer..... :	Murata Manufacturing Co., Ltd.
Manufacturer Address..... :	10-1, Higashikotari 1-chome, Nagaokakyo-shi, Kyoto 617-8555, Japan
Factory :	Murata Manufacturing Co., Ltd.
Address :	10-1, Higashikotari 1-chome, Nagaokakyo-shi, Kyoto 617-8555, Japan

Wireless specification..... :	Bluetooth V5.2 - BR/EDR					
Operating frequency range(s)..... :	2400~2483.5MHz					
Type of Modulation..... :	<input checked="" type="checkbox"/>	GFSK	<input checked="" type="checkbox"/>	Pi/4 DQPSK	<input checked="" type="checkbox"/>	8DPSK
Data Rate :	<input checked="" type="checkbox"/>	1Mbit/s	<input checked="" type="checkbox"/>	2Mbit/s	<input checked="" type="checkbox"/>	3Mbit/s
Number of channel..... :	79					

Rated power supply	Voltage and Frequency					
	<input type="checkbox"/>	AC: 220 – 240 V, 50/60 Hz				
	<input checked="" type="checkbox"/>	DC:3.2-4.2V				
	<input type="checkbox"/>	Adapter:				
	<input type="checkbox"/>	Battery:.....				
Mounting position..... :	<input type="checkbox"/>	Table top equipment				
	<input type="checkbox"/>	Wall/Ceiling mounted equipment				
	<input type="checkbox"/>	Floor standing equipment				
	<input type="checkbox"/>	Head-mounted equipment				
	<input checked="" type="checkbox"/>	Other: Module				

1.2 Antenna Information

Antenna model / type number.....:	N/A		
Antenna serial number	N/A		
Antenna Delivery	<input checked="" type="checkbox"/>	1TX + 1RX	
	<input type="checkbox"/>	2TX + 2RX	
	<input type="checkbox"/>	Others:.....	
Antenna technology.....:	<input checked="" type="checkbox"/>	SISO	
	<input type="checkbox"/>	MIMO	<input type="checkbox"/> CDD
			<input type="checkbox"/> Beam-forming
Antenna Type.....:	<input checked="" type="checkbox"/>	External	<input type="checkbox"/> Dipole
			<input type="checkbox"/> Sectorized
			<input checked="" type="checkbox"/> PCB
	<input type="checkbox"/>	Internal	<input type="checkbox"/> PIFA
			<input type="checkbox"/> PCB
			<input type="checkbox"/> Dipole
			<input type="checkbox"/> Others.....
	Antenna Gain.....:	0.1 dBi	

1.3 Channel List

Bluetooth Working Frequency of Each Channel: (For BR/EDR)							
Channel	Frequency	Channel	Frequency	Channel	Frequency	Channel	Frequency
00	2402 MHz	01	2403 MHz	02	2404 MHz	03	2405 MHz
04	2406 MHz	05	2407 MHz	06	2408 MHz	07	2409 MHz
08	2410 MHz	09	2411 MHz	10	2412 MHz	11	2413 MHz
12	2414 MHz	13	2415 MHz	14	2416 MHz	15	2417 MHz
16	2418 MHz	17	2419 MHz	18	2420 MHz	19	2421 MHz
20	2422 MHz	21	2423 MHz	22	2424 MHz	23	2425 MHz
24	2426 MHz	25	2427 MHz	26	2428 MHz	27	2429 MHz
28	2430 MHz	29	2431 MHz	30	2432 MHz	31	2433 MHz
32	2434 MHz	33	2435 MHz	34	2436 MHz	35	2437 MHz
36	2438 MHz	37	2439 MHz	38	2440 MHz	39	2441 MHz
40	2442 MHz	41	2443 MHz	42	2444 MHz	43	2445 MHz
44	2446 MHz	45	2447 MHz	46	2448 MHz	47	2449 MHz
48	2450 MHz	49	2451 MHz	50	2452 MHz	51	2453 MHz
52	2454 MHz	53	2455 MHz	54	2456 MHz	55	2457 MHz
56	2458 MHz	57	2459 MHz	58	2460 MHz	59	2461 MHz
60	2462 MHz	61	2463 MHz	62	2464 MHz	63	2465 MHz
64	2466 MHz	65	2467 MHz	66	2468 MHz	67	2469 MHz
68	2470 MHz	69	2471 MHz	70	2472 MHz	71	2473 MHz
72	2474 MHz	73	2475 MHz	74	2476 MHz	75	2477 MHz
76	2478 MHz	77	2479 MHz	78	2480 MHz	N/A	N/A

1.4 Power Setting

Mode	Channel	Test Frequency (MHz)	Power Setting
1Mbps(GFSK_DH5)	00	2402	0
	39	2441	0
	78	2480	0
2Mbps(Pi/4 DQPSK_DH5)	00	2402	0
	39	2441	0
	78	2480	0
3Mbps(8DPSK_DH5)	00	2402	0
	39	2441	0
	78	2480	0

Note: The general description of the Item(s), antenna information, channel list and Power Setting in clause 1 are provided and confirmed by the client.

2 DESCRIPTION OF TEST SETUP

2.1 Operating mode(s) used for tests

During the tests the following operating mode(s) has(have) been used.

Test Mode For Bluetooth	Mode 1: Transmitter-1Mbps(GFSK_DH5)
	Mode 2: Transmitter-2Mbps(Pi/4 DQPSK_DH5)
	Mode 3: Transmitter-3Mbps(8DPSK_DH5)
	Mode 4: Transmitter-Hopping-1Mbps(GFSK_DH5)
	Mode 5: Transmitter-Hopping-2Mbps(Pi/4 DQPSK_DH5)
	Mode 6: Transmitter-Hopping-3Mbps(8DPSK_DH5)

Note : For client device, radiated tests was verified over X, Y, Z axis, and shown the worst case Z axis on this report.

2.2 Accessories Information

Accessories Information	Brand/model name	Cable		
		Length used during test [m]	Attached during test	Shielded
USB Cable	N/A	10	<input checked="" type="checkbox"/>	<input checked="" type="checkbox"/>
USB Cable	N/A	0.5	<input checked="" type="checkbox"/>	<input checked="" type="checkbox"/>

2.3 Auxiliary equipment / Test software for the EUT

Auxiliary equipment	Type / Version	Manufacturer	Supplied by
Notebook	2526	Think Pad	N/A
Software	Type / Version	Manufacturer	Supplied by
BlueTool	N/A	N/A	N/A

2.4 Test Configuration / Block diagram used for tests

Test setup Diagram- AC Line Conducted Emission Test

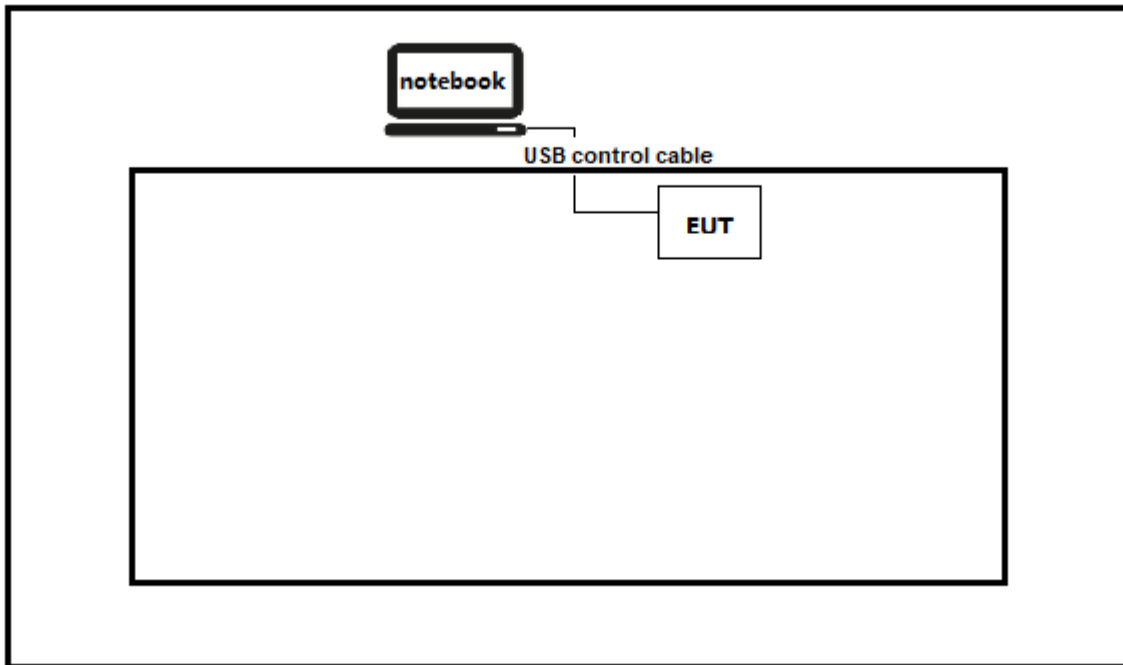

Test setup Diagram- Radiated Emission

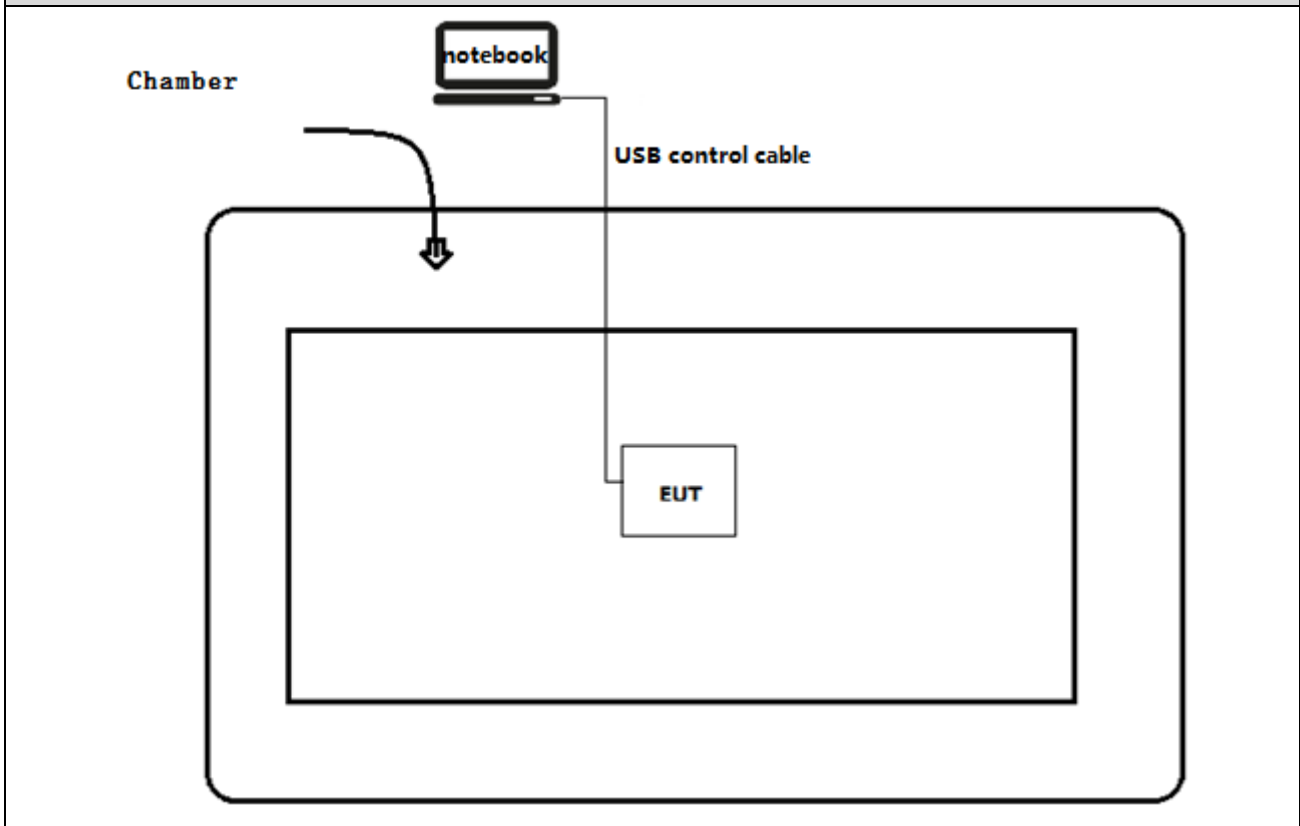

2.5 Testing process

1	Setup the EUT as shown in Section 2.3
2	Run the software "BlueTool.exe" on the notebook computer.
3	Open the serial port and enter the corresponding commands to configure the test mode, test channel, test power and data rate.
4	Verify that the EUT works properly.

3 VERDICT SUMMARY SECTION

This chapter presents an overview of standards and results. Refer to the next chapters for details of measured test results and applied test levels.

3.1 Standards

Standard	Year	Description
FCC CFR Title 47 Part 15 Subpart C Section 15.247	2021	Operation within the bands 902–928 MHz, 2400–2483.5 MHz, and 5725–5850 MHz.
ANSI C63.10	2013	American National Standard of Procedures for Compliance Testing of Unlicensed Wireless Devices
KDB558074 D01 v05r02	2019	Guidance for performing compliance measurements on Digital Transmission System (DTS) operating under section 15.247
RSS-Gen Issue 5 Amendment 2	2021	General Requirements for Compliance of Radio Apparatus
RSS-247 Issue 2	2017	Digital Transmission Systems (DTSS), Frequency Hopping Systems (FHSs) and Licence-Exempt Local Area Network (LE-LAN) Devices

3.2 Deviation(s) from the Standard(s) / Test Specification(s)

The following deviation(s) was / were made from the published requirements of the listed standards: N/A.

(Please define the deviations from the standard(s) if applicable)

3.3 Overview of results

For FCC

Performed Test Item	Normative References	Test Performed	Deviation
Conducted Emission	FCC CFR Title 47 Part 15 Subpart C: 2015Section 15.207	N/A	No
Emissions in restricted frequency bands	FCC CFR Title 47 Part 15 Subpart C: 2015Section 15.209	Yes	No
20dB Bandwidth	FCC CFR Title 47 Part 15 Subpart C: 2015 Section 15.247(a)(1)	Yes	No
Carrier Frequency Separation	FCC CFR Title 47 Part 15 Subpart C: 2015 Section 15.247(a)(1)	Yes	No
Number of Hopping Frequencies	FCC CFR Title 47 Part 15 Subpart C: 2015 Section 15.247(a)(1)(iii)	Yes	No
Time of Occupancy (Dwell Time)	FCC CFR Title 47 Part 15 Subpart C: 2015 Section 15.247(a)(1)(iii)	Yes	No
Peak OutputPower	FCC CFR Title 47 Part 15 Subpart C: 2015 Section 15.247(b)(1)	Yes	No
Emissions in non-restricted frequency bands	FCC CFR Title 47 Part 15 Subpart C: 2015 Section 15.215(c), 15.247(d)	Yes	No
Band Edge	FCC CFR Title 47 Part 15 Subpart C: 2015 15.247(d)	Yes	No
Antenna Requirement	FCC CFR Title 47 Part 15 Subpart C: 2015 Section 15.203	Yes	No

For ISED

Performed Test Item	Normative References	Test Performed	Deviation
Conducted Emission	RSS-Gen Issue 5Section 8.8	N/A	No
Radiated Emission	RSS-Gen Issue 5Section 8.9	Yes	No
20dB Bandwidth	RSS-247 Issue 2 Section 5.1	Yes	No
Carrier Frequency Separation	RSS-247 Issue 2 Section 5.1	Yes	No
Number of Hopping Frequencies	RSS-247 Issue 2 Section 5.1	Yes	No
Time of Occupancy (Dwell Time)	RSS-247 Issue 2 Section 5.1	Yes	No
Peak OutputPower	RSS-247 Issue 2 Section 5.4	Yes	No
Emissions in non-restricted frequency bands	RSS-247 Issue 2 Section 5.5	Yes	No
Band Edge	RSS-Gen Issue 5Section 8.10	Yes	No
Antenna Requirement	RSS-Gen Issue 5Section 8.3	Yes	No

3.4 Test Facility

USA : FCC Designation Number: CN1199

CA : ISED CAB identifier: CN0040

4 TEST RESULTS

4.1 Conducted Emission

VERDICT: N/A

4.1.1 Limit

Standard		
FCC Part 15 Subpart C Paragraph 15.207		
Frequency range [MHz]	Limit: QP [dB(μV) ¹⁾	Limit: AV [dB(μV) ¹⁾
0,15 - 0,50	66 - 56 ²⁾	56 - 46 ²⁾
0,50 - 5,0	56	46
5,0 - 30	60	50

¹⁾ At the transition frequency, the lower limit applies.

²⁾ The limit decreases linearly with the logarithm of the frequency.

NOTE 1: The exclusion band for transmitters shall be considered for transmitters operating at frequencies below 30 MHz.

NOTE 2: Where the AC output port is directly connected (or via a circuit breaker) to the AC power input port of the EUT the AC power output port need not to be tested.

4.1.2 Test Setup

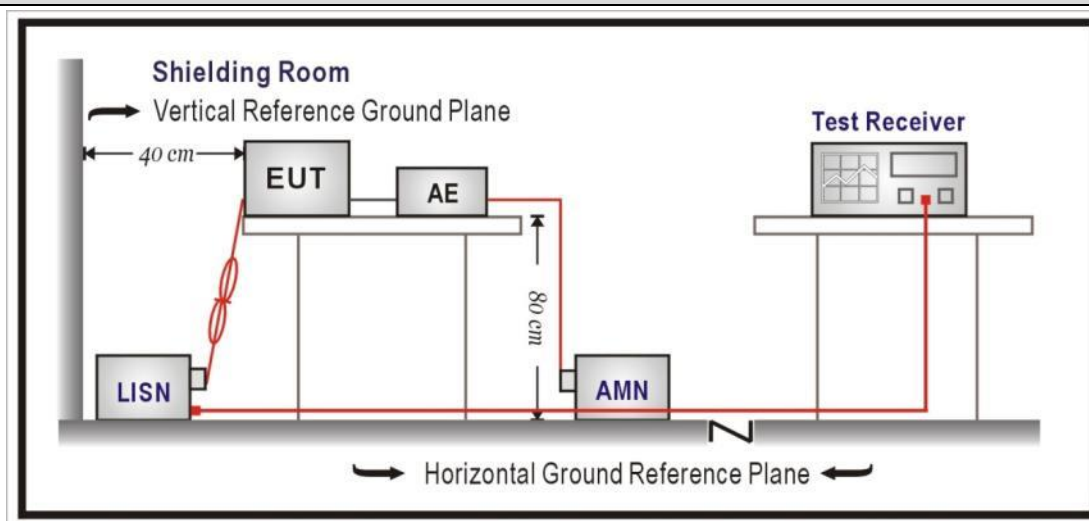

4.1.3 Test Procedure

	References Rule	Chapter	Item
<input checked="" type="checkbox"/>	ANSI C63.10-2013	6.2	Standard test method for ac power-line conducted emissions from unlicensed wireless devices

4.1.4 Test Data

N/A: The EUT is powered by DC.

4.2 Emissions in restricted frequency bands	VERDICT: PASS
--	----------------------

4.2.1 Limit			
Standard		FCC Part 15 Subpart C Paragraph 15.209	
Restricted Bands of operation for FCC			
Frequency (MHz)	Frequency (MHz)	Frequency (MHz)	Frequency (GHz)
0.090 – 0.110	16.42 – 16.423	399.9 – 410	4.5 – 5.15
0.495 – 0.505	16.69475 – 16.69525	608 – 614	5.35 – 5.46
2.1735 – 2.1905	16.80425 – 16.80475	960 – 1240	7.25 – 7.75
4.125 – 4.128	25.5 – 25.67	1300 – 1427	8.025 – 8.5
4.17725 – 4.17775	37.5 – 38.25	1435 – 1626.5	9.0 – 9.2
4.20725 – 4.20775	73 – 74.6	1645.5 – 1646.5	9.3 – 9.5
6.215 – 6.218	74.8 – 75.2	1660 – 1710	10.6 – 12.7
6.26775 – 6.26825	108 – 121.94	1718.8 – 1722.2	13.25 – 13.4
6.31175 – 6.31225	123 – 138	2200 – 2300	14.47 – 14.5
8.291 – 8.294	149.9 – 150.05	2310 – 2390	15.35 – 16.2
8.362 – 8.366	156.52475 – 156.52525	2483.5 – 2500	17.7 – 21.4
8.37625 – 8.38675	156.7 – 156.9	2690 – 2900	22.01 – 23.12
8.81425 – 8.81475	162.0125 – 167.17	3260 – 3267	23.6 – 24.0
12.29 – 12.293	167.72 – 173.2	3332 – 3339	31.2 – 31.8
12.51975 – 12.52025	240 – 285	3345.8 – 3358	36.43 – 36.5
12.57675 – 12.57725	322 – 335.4	3600 – 4400	
13.36 – 13.41			
Restricted Bands of operation for ISED			
0.090 - 0.110	13.36 - 13.41	960 - 1427	9.0 - 9.2
0.495 - 0.505	16.42 - 16.423	1435 - 1626.5	9.3 - 9.5
2.1735 - 2.1905	16.69475 - 16.69525	1645.5 - 1646.5	10.6 - 12.7
3.020 - 3.026	16.80425 - 16.80475	1660 - 1710	13.25 - 13.4
4.125 - 4.128	25.5 - 25.67	1718.8 - 1722.2	14.47 - 14.5
4.17725 - 4.17775	37.5 - 38.25	2200 - 2300	15.35 - 16.2
4.20725 - 4.20775	73 - 74.6	2310 - 2390	17.7 - 21.4
5.677 - 5.683	74.8 - 75.2	2483.5 - 2500	22.01 - 23.12
6.215 - 6.218	108 - 138	2655 - 2900	23.6 - 24.0
6.26775 - 6.26825	149.9 - 150.05	3260 - 3267	31.2 - 31.8
6.31175 - 6.31225	156.52475 - 156.52525	3332 - 3339	36.43 - 36.5
8.291 - 8.294	156.7 - 156.9	3345.8 - 3358	Above 38.6
8.362 - 8.366	162.0125 - 167.17	3500 - 4400	
8.37625 - 8.38675	167.72 - 173.2	4500 - 5150	
8.41425 - 8.41475	240 - 285	5350 - 5460	
12.29 - 12.293	322 - 335.4	7250 - 7750	
12.51975 - 12.52025	399.9 - 410	8025 - 8500	
12.57675 - 12.57725	608 - 614	--	

Restricted Band Emissions Limit			
Frequency (MHz)	Field strength ($\mu\text{V/m}$)	Field strength ($\text{dB}\mu\text{V/m}$)	Measurement distance (m)
0.009 - 0.49	2400/F(kHz)	48.5 – 13.8	300 _(Note 1)
0.49 - 1.705	24000/F(kHz)	33.8 - 23	30 _(Note 1)
1.705 - 30	30	29.5	30 _(Note 1)
30 -88	100	40	3 _(Note 2)
88-216	150	43.5	3 _(Note 2)
216 - 960	200	46	3 _(Note 2)
Above 960	500	54	3 _(Note 2)

Note 1: At frequencies below 30 MHz, measurements may be performed at a distance closer than that specified in the regulations; however, an attempt should be made to avoid making measurements in the near field. Pending the development of an appropriate measurement procedure for measurements performed below 30 MHz, when performing measurements at a closer distance than specified, the results shall be extrapolated to the specified distance by either making measurements at a minimum of two distances on at least one radial to determine the proper extrapolation factor or by using the square of an inverse linear distance extrapolation factor (40 dB/decade).

Note 2: At frequencies at or above 30 MHz, measurements may be performed at a distance other than what is specified provided: measurements are not made in the near field except where it can be shown that near field measurements are appropriate due to the characteristics of the device; and it can be demonstrated that the signal levels needed to be measured at the distance employed can be detected by the measurement equipment.

Measurements shall not be performed at a distance greater than 30 meters unless it can be further demonstrated that measurements at a distance of 30 meters or less are impractical. When performing measurements at a distance other than that specified, the results shall be extrapolated to the specified distance using an extrapolation factor of 20 dB/decade (inverse linear-distance for field strength measurements; inverse-linear-distance-squared for power density measurements).

4.2.2 Test Setup

Below 30MHz Test Setup:

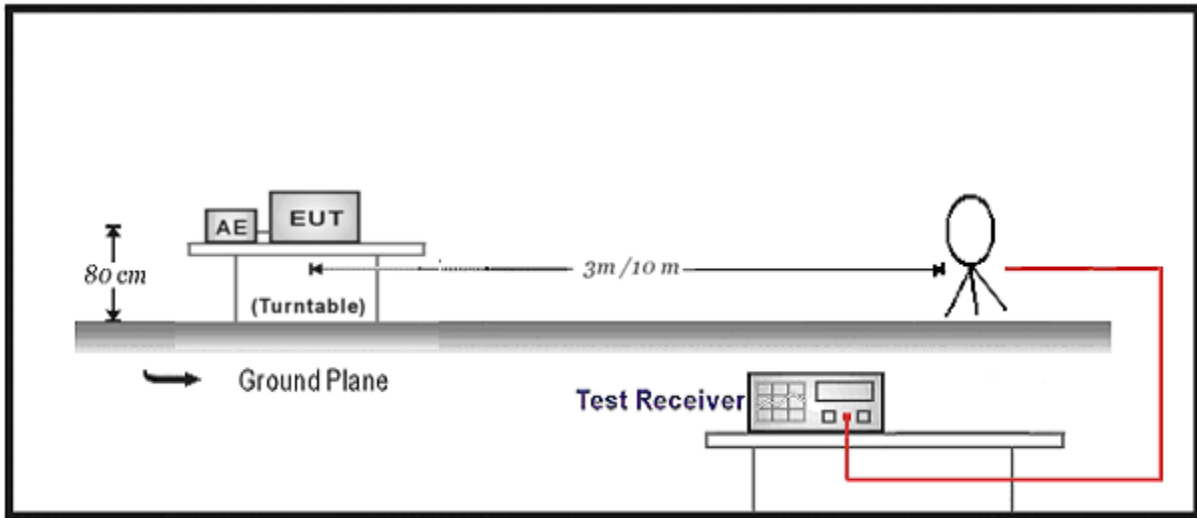

30MHz-1GHz Test Setup:

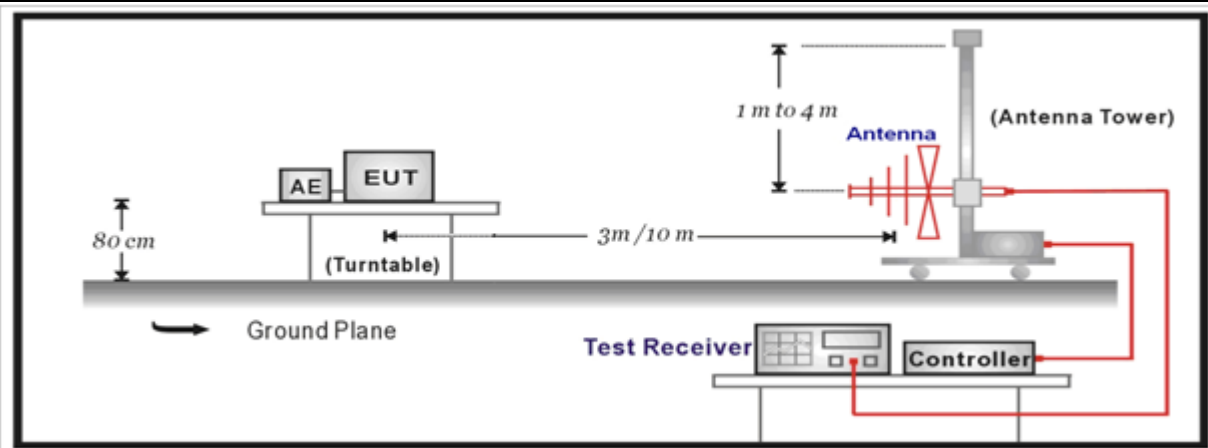

Above 1GHz Test Setup:

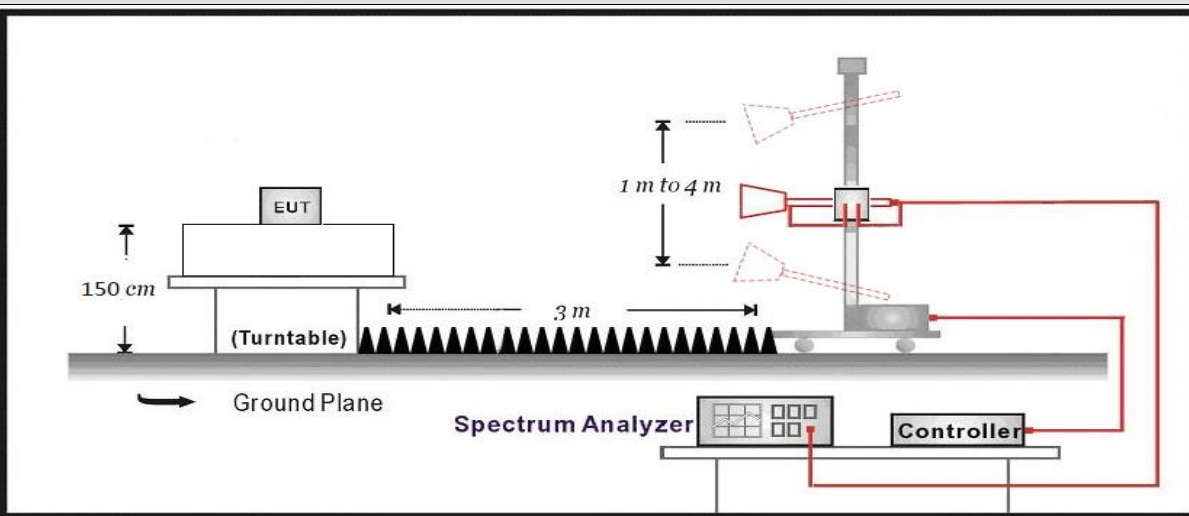

4.2.3 Test Procedure			
	References Rule	Chapter	Description
<input checked="" type="checkbox"/>	ANSI C63.10	11.12	Emissions in restricted frequency bands
	<input checked="" type="checkbox"/> ANSI C63.10	11.12.1	Radiated emission measurements
	<input checked="" type="checkbox"/> ANSI C63.10	11.12.2.7	Radiated spurious emission test
	<input checked="" type="checkbox"/> ANSI C63.10	6.4	Radiated emissions from unlicensed wireless devices below 30 MHz
	<input checked="" type="checkbox"/> ANSI C63.10	6.5	Radiated emissions from unlicensed wireless devices in the frequency range of 30 MHz to 1000 MHz
	<input checked="" type="checkbox"/> ANSI C63.10	6.6	Radiated emissions from unlicensed wireless devices above 1 GHz

4.2.4 Test Data

Profile: 2260325R	Page No.: 19
Engineer: YuLiu	
Site: AC5	Time: 2022/06/30 - 01:58
Limit: FCC_Part15.209_RE(3m)	Margin: 0
Probe: Horn_3117_00167055(1-18GHz)	Polarity: Horizontal
EUT: LBEE5HY2DU	Power: DC 3.6V
Note: Mode 1:Transmit at 2402MHz by DH5	

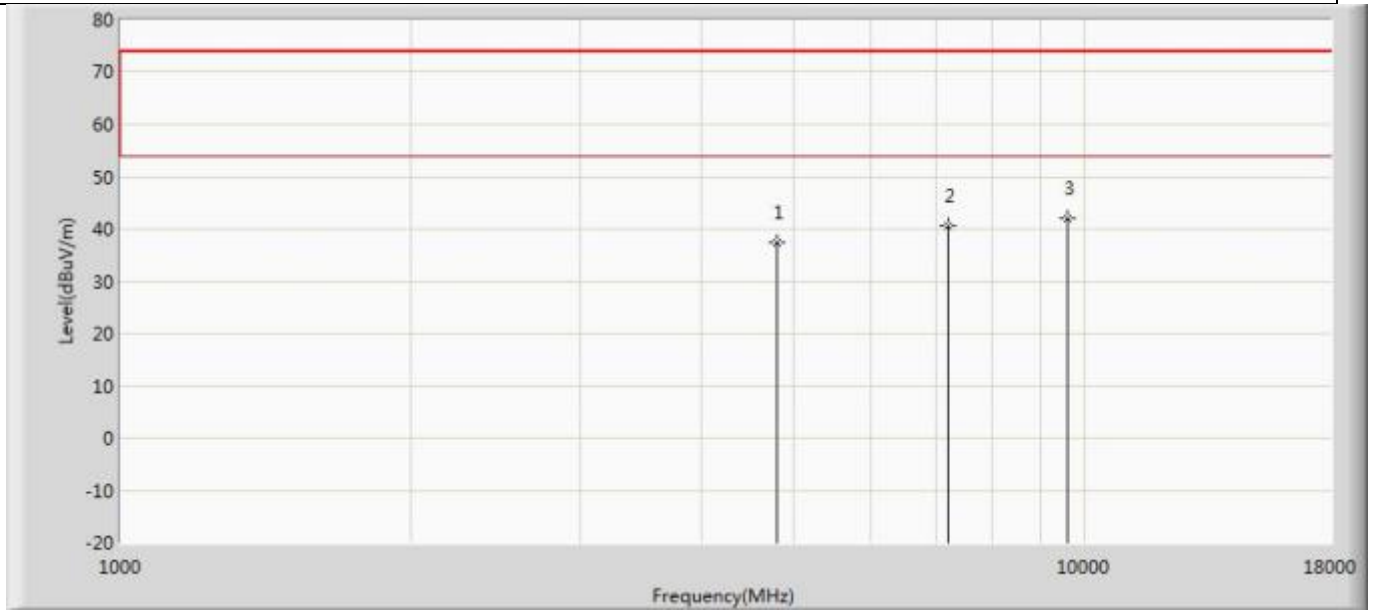

No	Mark	Frequency (MHz)	Measure Level (dBuV/m)	Reading Level (dBuV)	Over Limit (dB)	Limit (dBuV/m)	Factor (dB)	Type
1		4804.000	37.511	48.845	-36.489	74.000	-11.334	PK
2		7206.000	40.557	47.871	-33.443	74.000	-7.314	PK
3	*	9608.000	42.039	47.761	-31.961	74.000	-5.722	PK

Profile: 2260325R	Page No.: 20
Engineer: YuLiu	
Site: AC5	Time: 2022/06/30 - 01:58
Limit: FCC_Part15.209_RE(3m)	Margin: 0
Probe: Horn_3117_00167055(1-18GHz)	Polarity: Vertical
EUT: LBEE5HY2DU	Power: DC 3.6V
Note: Mode 1:Transmit at 2402MHz by DH5	

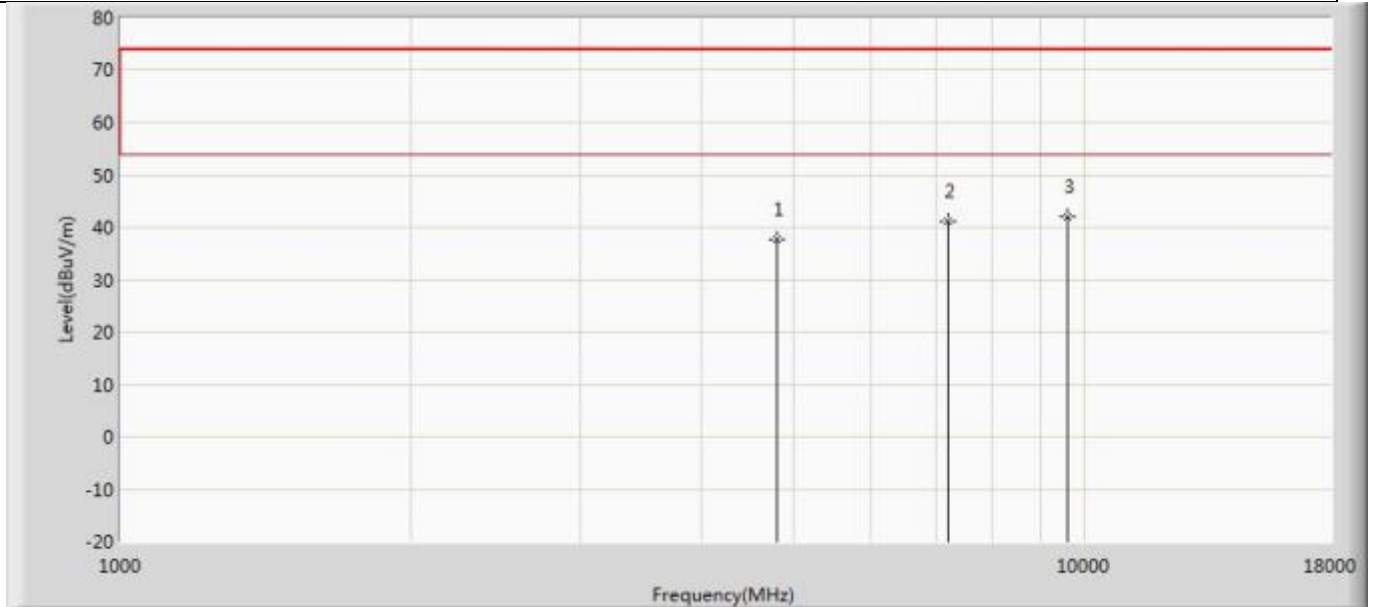

No	Mark	Frequency (MHz)	Measure Level (dBuV/m)	Reading Level (dBuV)	Over Limit (dB)	Limit (dBuV/m)	Factor (dB)	Type
1		4804.000	37.538	48.872	-36.462	74.000	-11.334	PK
2		7206.000	41.159	48.473	-32.841	74.000	-7.314	PK
3	*	9608.000	41.963	47.685	-32.037	74.000	-5.722	PK

Profile: 2260325R	Page No.: 21
Engineer: YuLiu	
Site: AC5	Time: 2022/06/30 - 01:58
Limit: FCC_Part15.209_RE(3m)	Margin: 0
Probe: Horn_3117_00167055(1-18GHz)	Polarity: Horizontal
EUT: LBEE5HY2DU	Power: DC 3.6V
Note: Mode 1:Transmit at 2441MHz by DH5	

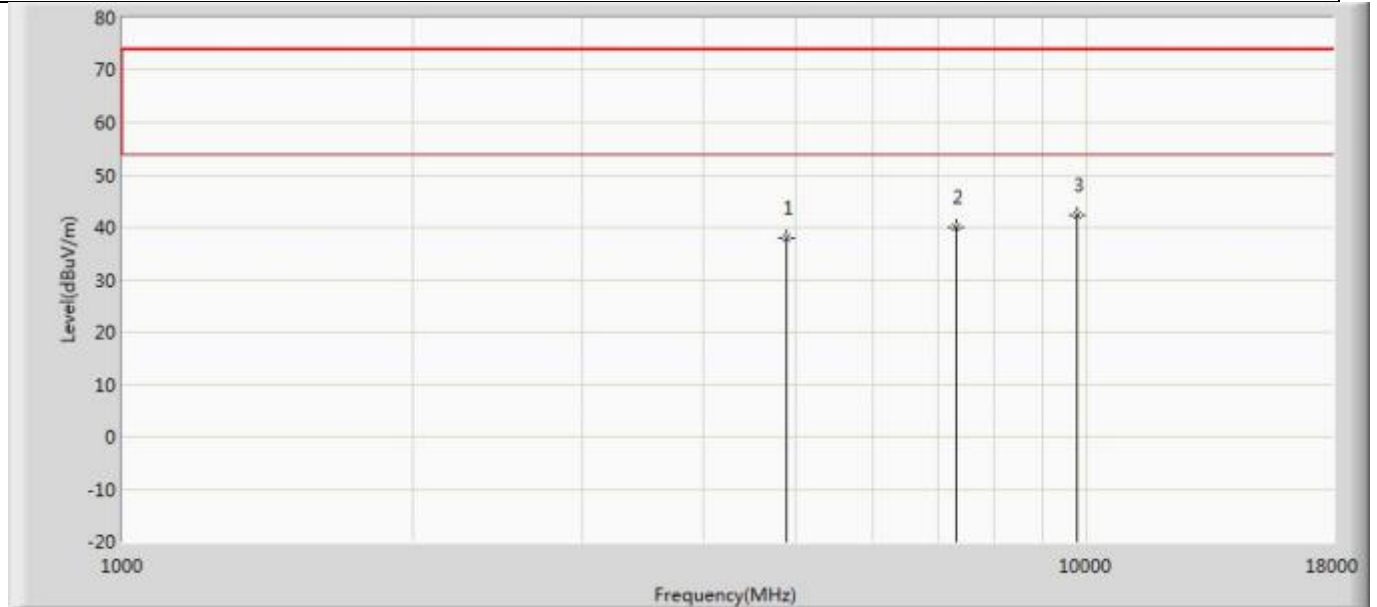

No	Mark	Frequency (MHz)	Measure Level (dBuV/m)	Reading Level (dBuV)	Over Limit (dB)	Limit (dBuV/m)	Factor (dB)	Type
1		4882.000	37.860	49.021	-36.140	74.000	-11.160	PK
2		7323.000	39.883	47.009	-34.117	74.000	-7.126	PK
3	*	9764.000	42.240	47.591	-31.760	74.000	-5.351	PK

Profile: 2260325R	Page No.: 22
Engineer: YuLiu	
Site: AC5	Time: 2022/06/30 - 01:58
Limit: FCC_Part15.209_RE(3m)	Margin: 0
Probe: Horn_3117_00167055(1-18GHz)	Polarity: Vertical
EUT: LBEE5HY2DU	Power: DC 3.6V
Note: Mode 1:Transmit at 2441MHz by DH5	

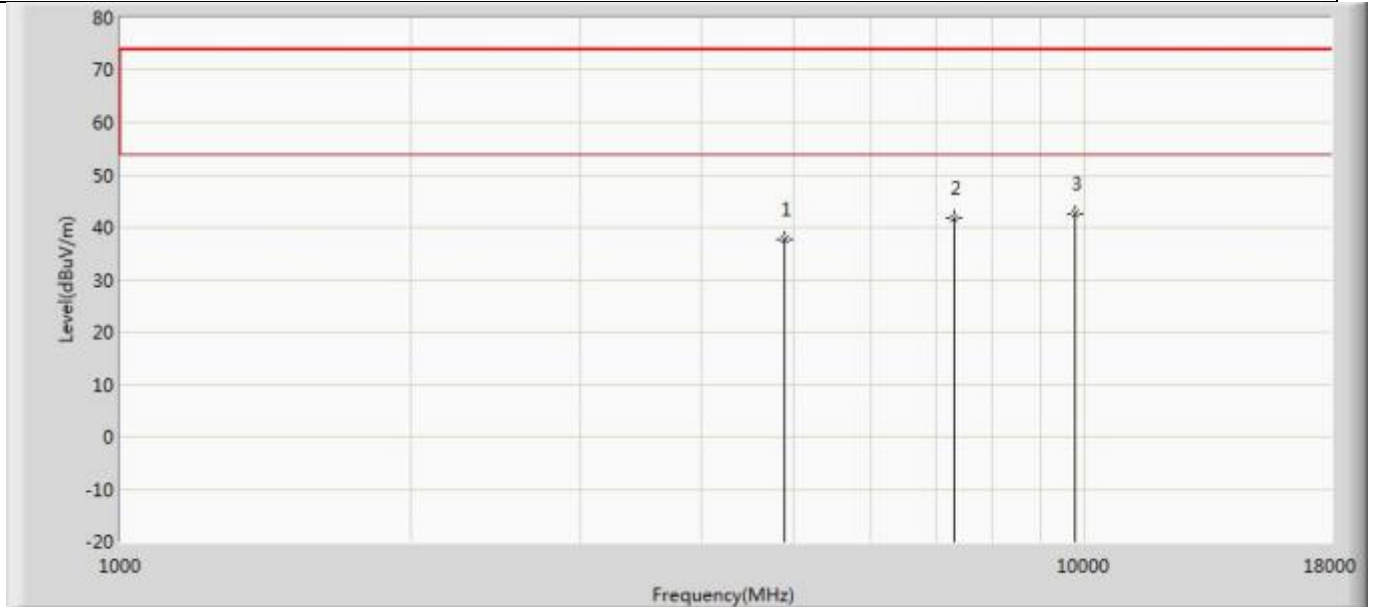

No	Mark	Frequency (MHz)	Measure Level (dBuV/m)	Reading Level (dBuV)	Over Limit (dB)	Limit (dBuV/m)	Factor (dB)	Type
1		4882.000	37.609	48.770	-36.391	74.000	-11.160	PK
2		7323.000	41.600	48.726	-32.400	74.000	-7.126	PK
3	*	9764.000	42.633	47.984	-31.367	74.000	-5.351	PK

Profile: 2260325R	Page No.: 23
Engineer: YuLiu	
Site: AC5	Time: 2022/06/30 - 01:58
Limit: FCC_Part15.209_RE(3m)	Margin: 0
Probe: Horn_3117_00167055(1-18GHz)	Polarity: Horizontal
EUT: LBEE5HY2DU	Power: DC 3.6V
Note: Mode 1:Transmit at 2480MHz by DH5	

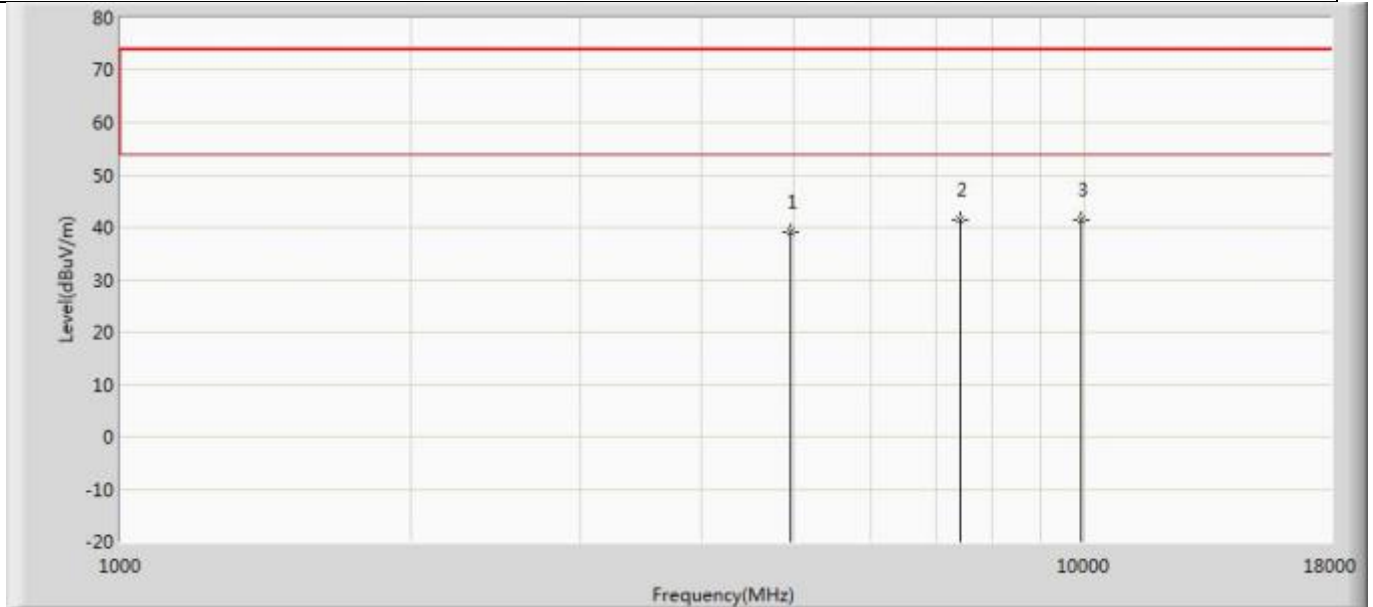

No	Mark	Frequency (MHz)	Measure Level (dBuV/m)	Reading Level (dBuV)	Over Limit (dB)	Limit (dBuV/m)	Factor (dB)	Type
1		4960.000	39.155	50.806	-34.845	74.000	-11.651	PK
2	*	7440.000	41.557	48.586	-32.443	74.000	-7.029	PK
3		9920.000	41.469	46.856	-32.531	74.000	-5.386	PK

Profile: 2260325R	Page No.: 24
Engineer: YuLiu	
Site: AC5	Time: 2022/06/30 - 01:58
Limit: FCC_Part15.209_RE(3m)	Margin: 0
Probe: Horn_3117_00167055(1-18GHz)	Polarity: Vertical
EUT: LBEE5HY2DU	Power: DC 3.6V
Note: Mode 1:Transmit at 2480MHz by DH5	

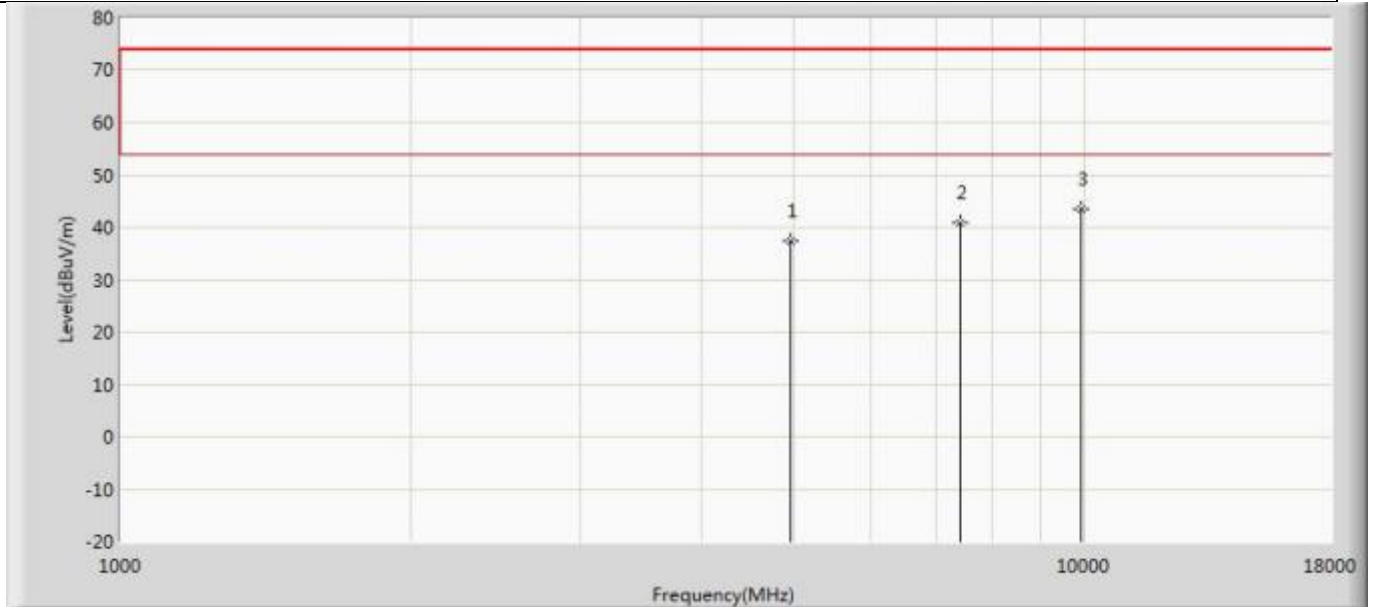

No	Mark	Frequency (MHz)	Measure Level (dBuV/m)	Reading Level (dBuV)	Over Limit (dB)	Limit (dBuV/m)	Factor (dB)	Type
1		4960.000	37.427	49.078	-36.573	74.000	-11.651	PK
2		7440.000	40.887	47.916	-33.113	74.000	-7.029	PK
3	*	9920.000	43.532	48.919	-30.468	74.000	-5.386	PK

Profile: 2260325R	Page No.: 25
Engineer: YuLiu	
Site: AC5	Time: 2022/06/30 - 01:58
Limit: FCC_Part15.209_RE(3m)	Margin: 0
Probe: Horn_3117_00167055(1-18GHz)	Polarity: Horizontal
EUT: LBEE5HY2DU	Power: DC 3.6V
Note: Mode 2:Transmit at 2402MHz by 2DH5	

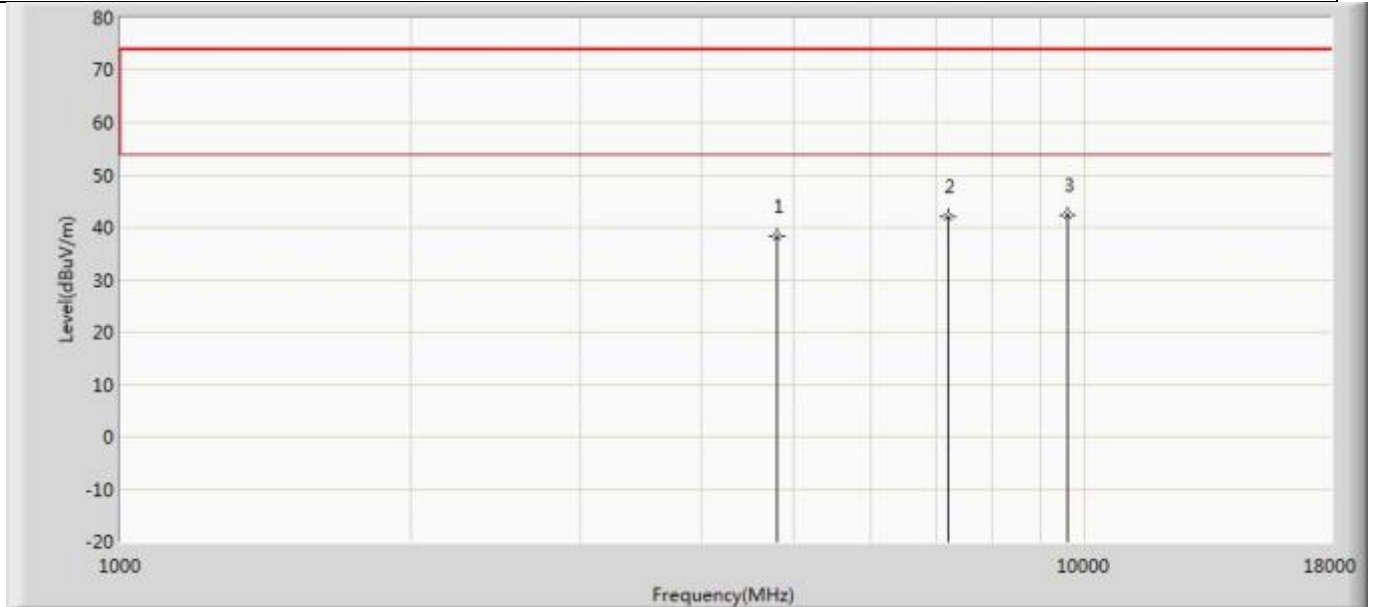

No	Mark	Frequency (MHz)	Measure Level (dBuV/m)	Reading Level (dBuV)	Over Limit (dB)	Limit (dBuV/m)	Factor (dB)	Type
1		4804.000	38.278	49.612	-35.722	74.000	-11.334	PK
2		7206.000	41.934	49.248	-32.066	74.000	-7.314	PK
3	*	9608.000	42.370	48.092	-31.630	74.000	-5.722	PK

Profile: 2260325R	Page No.: 26
Engineer: YuLiu	
Site: AC5	Time: 2022/06/30 - 01:58
Limit: FCC_Part15.209_RE(3m)	Margin: 0
Probe: Horn_3117_00167055(1-18GHz)	Polarity: Vertical
EUT: LBEE5HY2DU	Power: DC 3.6V
Note: Mode 2:Transmit at 2402MHz by 2DH5	

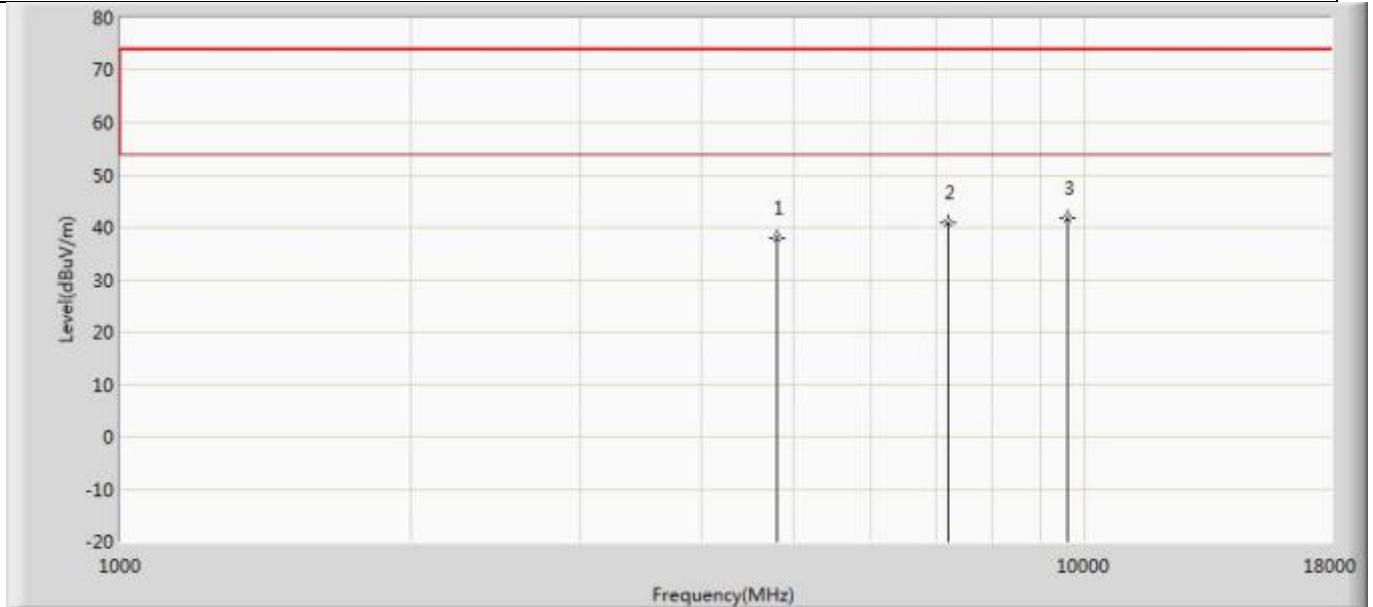

No	Mark	Frequency (MHz)	Measure Level (dBuV/m)	Reading Level (dBuV)	Over Limit (dB)	Limit (dBuV/m)	Factor (dB)	Type
1		4804.000	37.859	49.193	-36.141	74.000	-11.334	PK
2		7206.000	40.771	48.085	-33.229	74.000	-7.314	PK
3	*	9608.000	41.877	47.599	-32.123	74.000	-5.722	PK

Profile: 2260325R	Page No.: 27
Engineer: YuLiu	
Site: AC5	Time: 2022/06/30 - 01:58
Limit: FCC_Part15.209_RE(3m)	Margin: 0
Probe: Horn_3117_00167055(1-18GHz)	Polarity: Horizontal
EUT: LBEE5HY2DU	Power: DC 3.6V
Note: Mode 2:Transmit at 2441MHz by 2DH5	

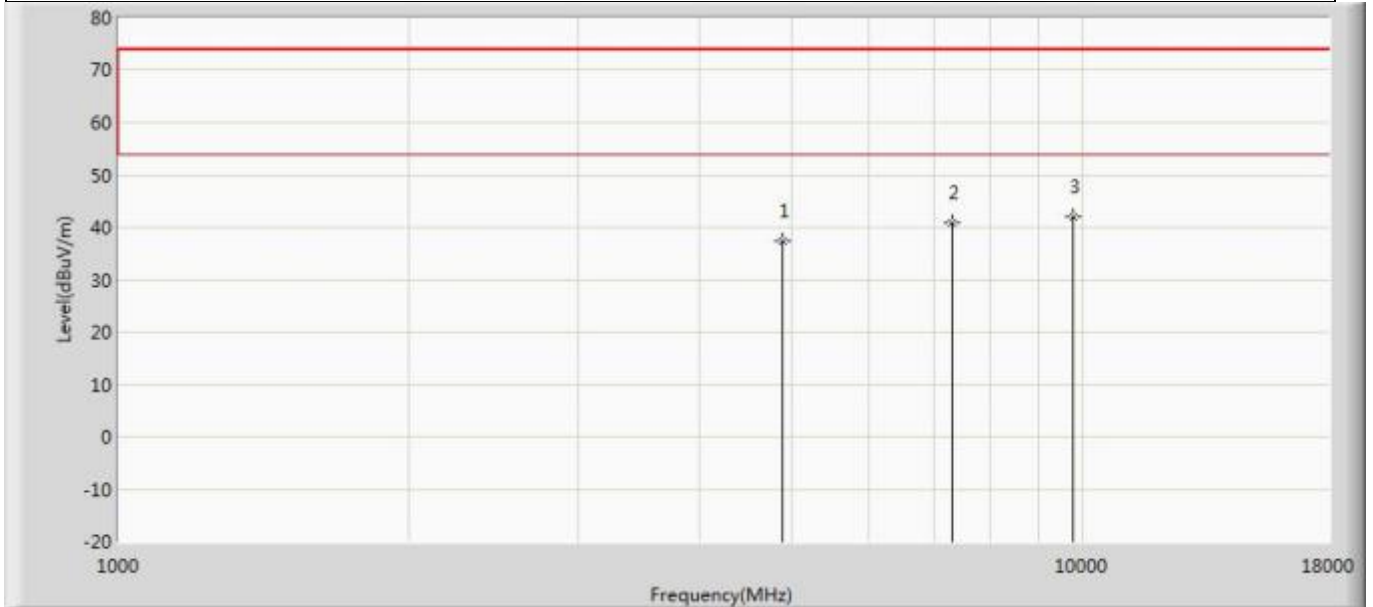

No	Mark	Frequency (MHz)	Measure Level (dBuV/m)	Reading Level (dBuV)	Over Limit (dB)	Limit (dBuV/m)	Factor (dB)	Type
1		4882.000	37.453	48.614	-36.547	74.000	-11.160	PK
2		7323.000	40.782	47.908	-33.218	74.000	-7.126	PK
3	*	9764.000	42.065	47.416	-31.935	74.000	-5.351	PK

Profile: 2260325R	Page No.: 28
Engineer: YuLiu	
Site: AC5	Time: 2022/06/30 - 01:58
Limit: FCC_Part15.209_RE(3m)	Margin: 0
Probe: Horn_3117_00167055(1-18GHz)	Polarity: Vertical
EUT: LBEE5HY2DU	Power: DC 3.6V
Note: Mode 2:Transmit at 2441MHz by 2DH5	

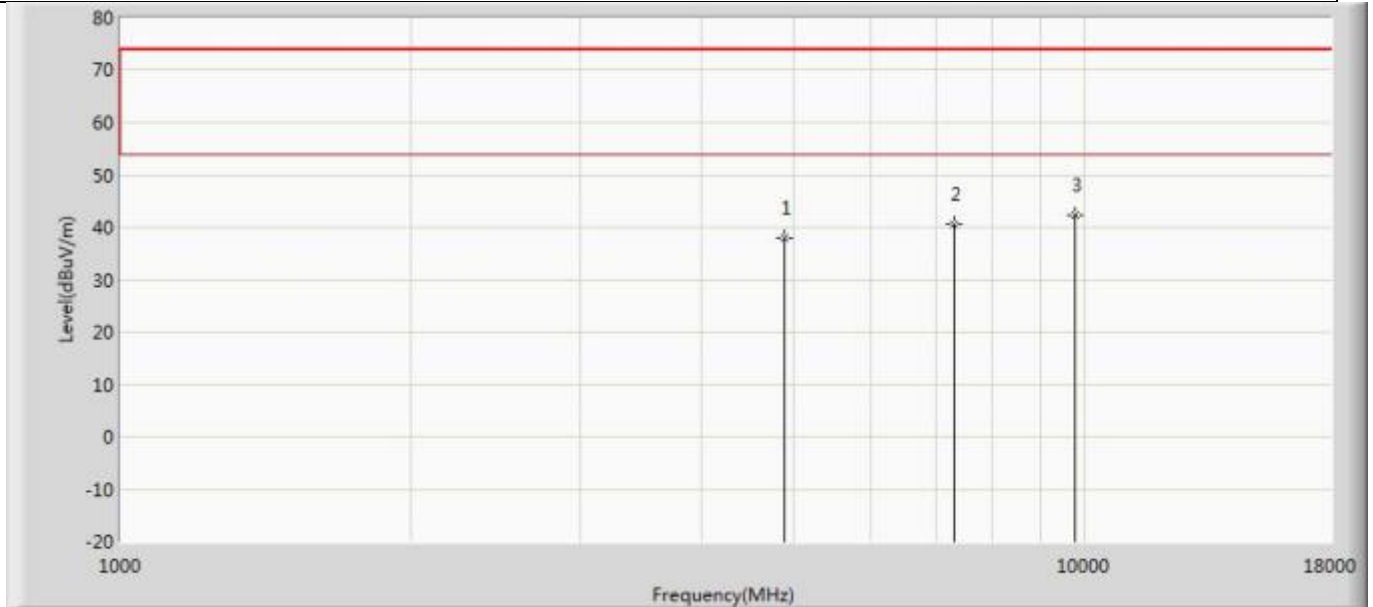

No	Mark	Frequency (MHz)	Measure Level (dBuV/m)	Reading Level (dBuV)	Over Limit (dB)	Limit (dBuV/m)	Factor (dB)	Type
1		4882.000	38.087	49.248	-35.913	74.000	-11.160	PK
2		7323.000	40.686	47.812	-33.314	74.000	-7.126	PK
3	*	9764.000	42.350	47.701	-31.650	74.000	-5.351	PK

Profile: 2260325R	Page No.: 29
Engineer: YuLiu	
Site: AC5	Time: 2022/06/30 - 01:58
Limit: FCC_Part15.209_RE(3m)	Margin: 0
Probe: Horn_3117_00167055(1-18GHz)	Polarity: Horizontal
EUT: LBEE5HY2DU	Power: DC 3.6V
Note: Mode 2:Transmit at 2480MHz by 2DH5	

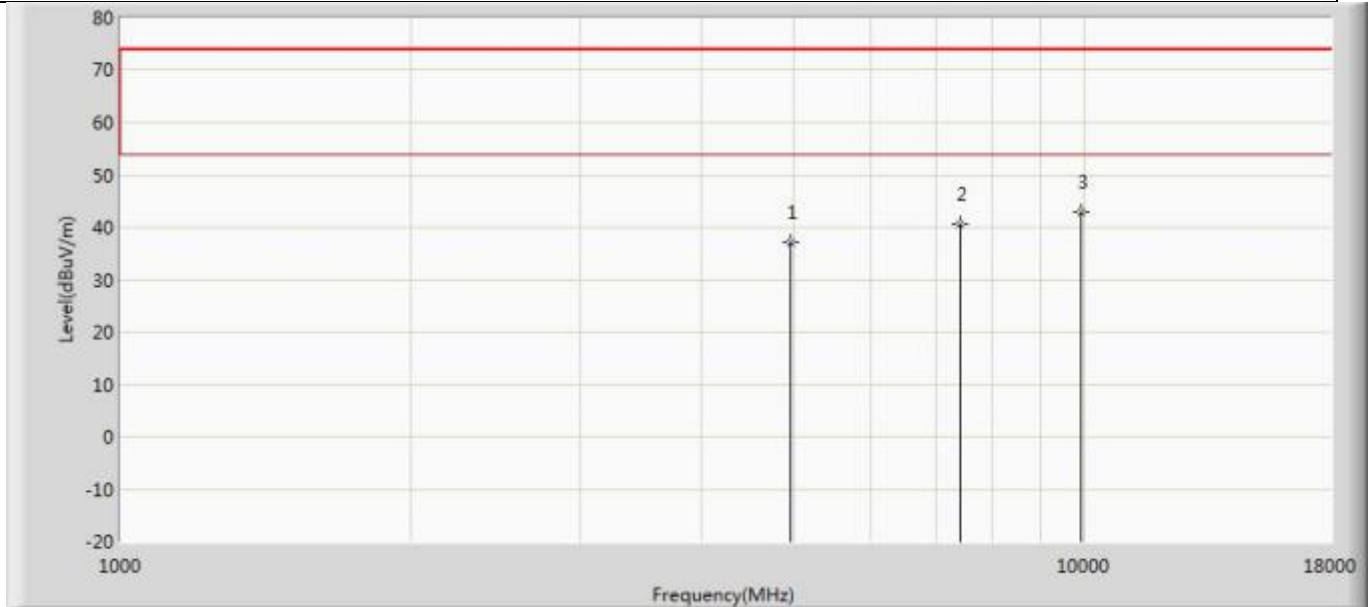

No	Mark	Frequency (MHz)	Measure Level (dBuV/m)	Reading Level (dBuV)	Over Limit (dB)	Limit (dBuV/m)	Factor (dB)	Type
1		4960.000	37.213	48.864	-36.787	74.000	-11.651	PK
2		7440.000	40.587	47.616	-33.413	74.000	-7.029	PK
3	*	9920.000	42.785	48.172	-31.215	74.000	-5.386	PK

Profile: 2260325R	Page No.: 30
Engineer: YuLiu	
Site: AC5	Time: 2022/06/30 - 01:58
Limit: FCC_Part15.209_RE(3m)	Margin: 0
Probe: Horn_3117_00167055(1-18GHz)	Polarity: Vertical
EUT: LBEE5HY2DU	Power: DC 3.6V
Note: Mode 2:Transmit at 2480MHz by 2DH5	

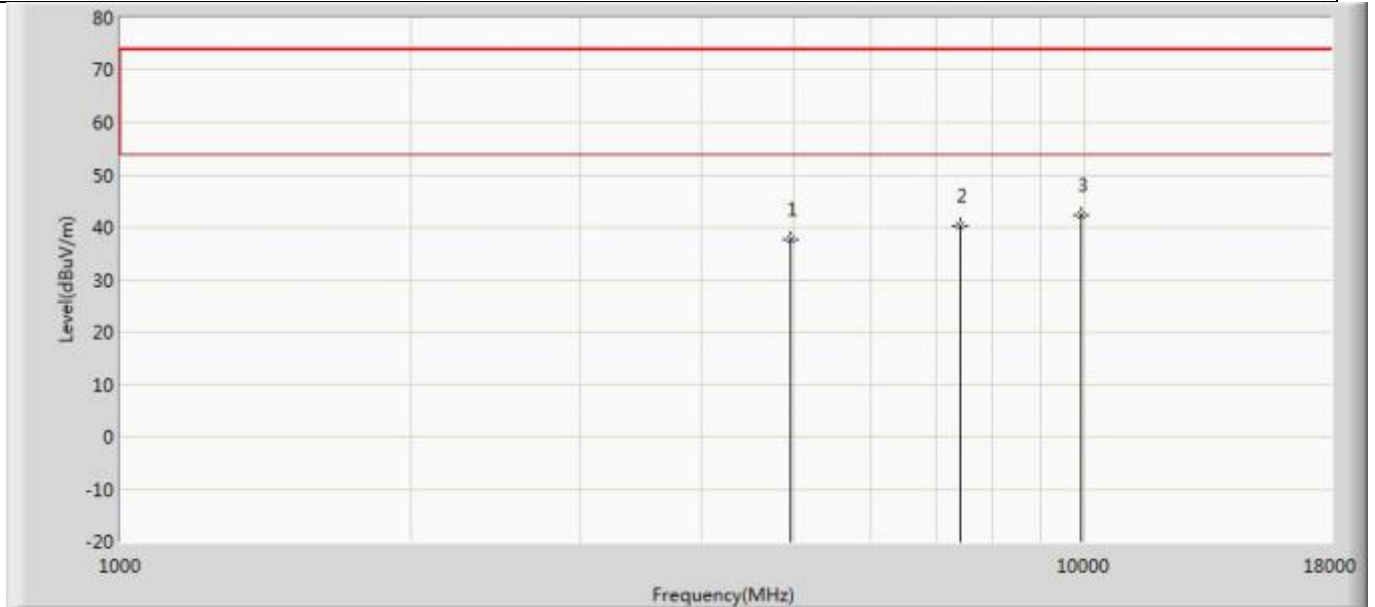

No	Mark	Frequency (MHz)	Measure Level (dBuV/m)	Reading Level (dBuV)	Over Limit (dB)	Limit (dBuV/m)	Factor (dB)	Type
1		4960.000	37.732	49.383	-36.268	74.000	-11.651	PK
2		7440.000	40.365	47.394	-33.635	74.000	-7.029	PK
3	*	9920.000	42.380	47.767	-31.620	74.000	-5.386	PK

Profile: 2260325R	Page No.: 31
Engineer: YuLiu	
Site: AC5	Time: 2022/06/30 - 01:58
Limit: FCC_Part15.209_RE(3m)	Margin: 0
Probe: Horn_3117_00167055(1-18GHz)	Polarity: Horizontal
EUT: LBEE5HY2DU	Power: DC 3.6V
Note: Mode 3:Transmit at 2402MHz by 3DH5	

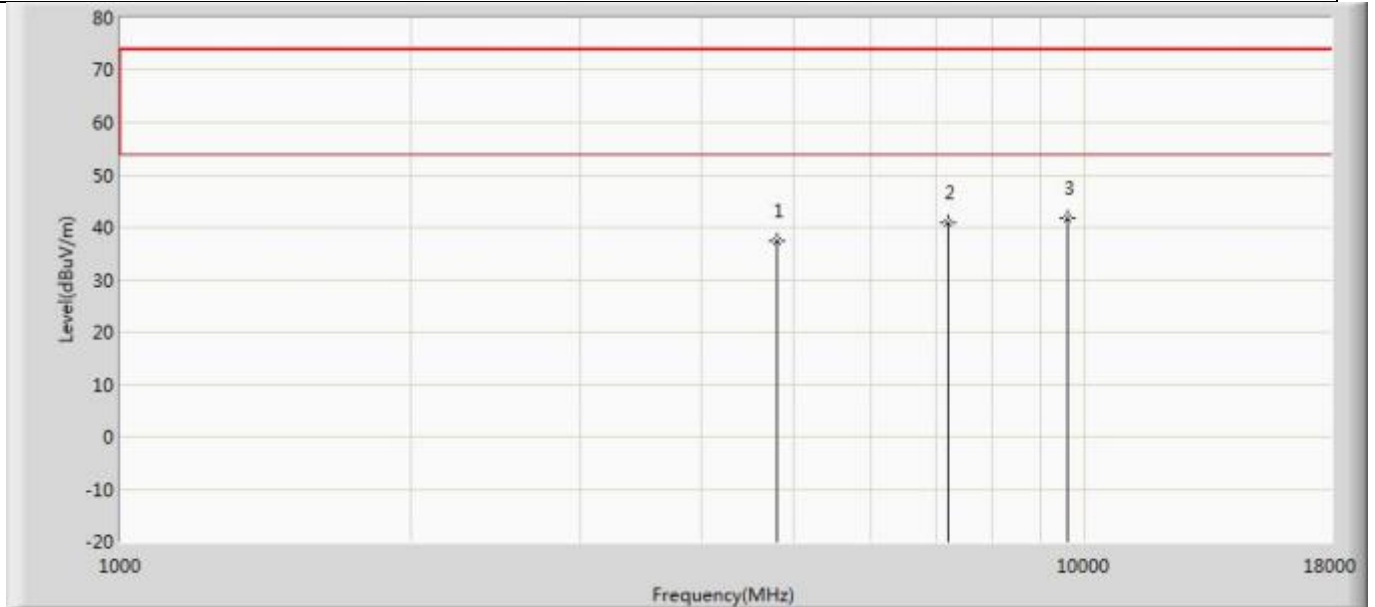

No	Mark	Frequency (MHz)	Measure Level (dBuV/m)	Reading Level (dBuV)	Over Limit (dB)	Limit (dBuV/m)	Factor (dB)	Type
1		4804.000	37.289	48.623	-36.711	74.000	-11.334	PK
2		7206.000	40.861	48.175	-33.139	74.000	-7.314	PK
3	*	9608.000	41.678	47.400	-32.322	74.000	-5.722	PK

Profile: 2260325R	Page No.: 32
Engineer: YuLiu	
Site: AC5	Time: 2022/06/30 - 01:58
Limit: FCC_Part15.209_RE(3m)	Margin: 0
Probe: Horn_3117_00167055(1-18GHz)	Polarity: Vertical
EUT: LBEE5HY2DU	Power: DC 3.6V
Note: Mode 3:Transmit at 2402MHz by 3DH5	

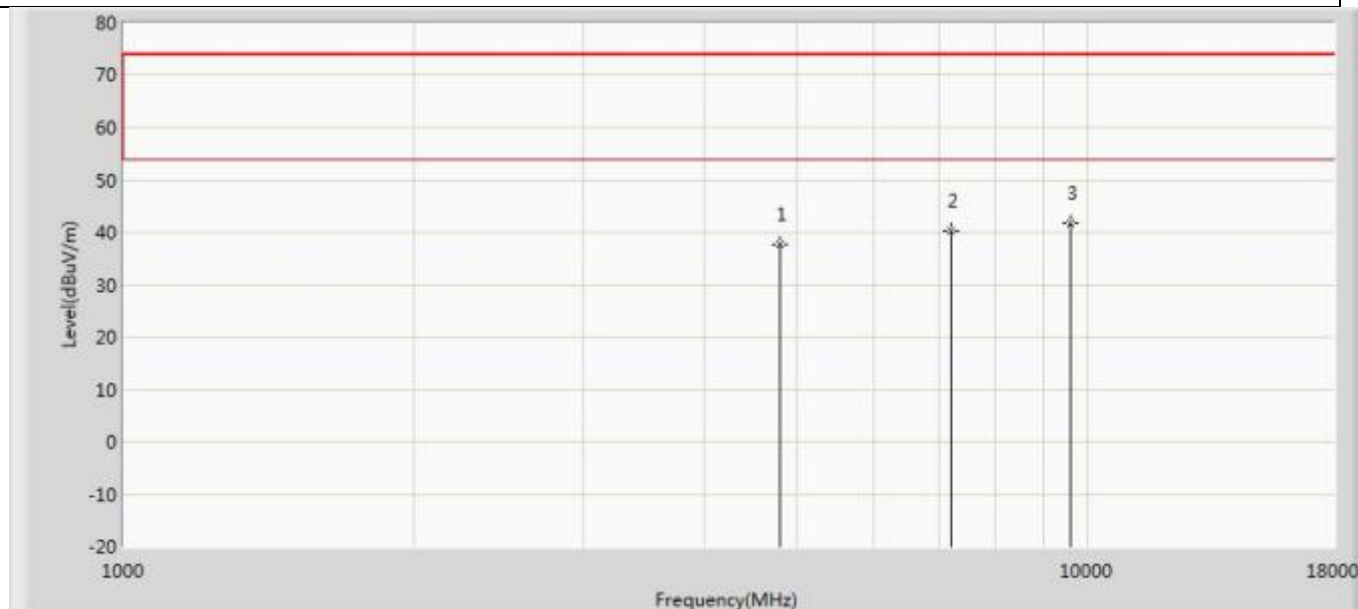

No	Mark	Frequency (MHz)	Measure Level (dBuV/m)	Reading Level (dBuV)	Over Limit (dB)	Limit (dBuV/m)	Factor (dB)	Type
1		4804.000	37.629	48.963	-36.371	74.000	-11.334	PK
2		7206.000	40.404	47.718	-33.596	74.000	-7.314	PK
3	*	9608.000	41.846	47.568	-32.154	74.000	-5.722	PK

Profile: 2260325R	Page No.: 33
Engineer: YuLiu	
Site: AC5	Time: 2022/06/30 - 01:58
Limit: FCC_Part15.209_RE(3m)	Margin: 0
Probe: Horn_3117_00167055(1-18GHz)	Polarity: Horizontal
EUT: LBEE5HY2DU	Power: DC 3.6V
Note: Mode 3:Transmit at 2441MHz by 3DH5	

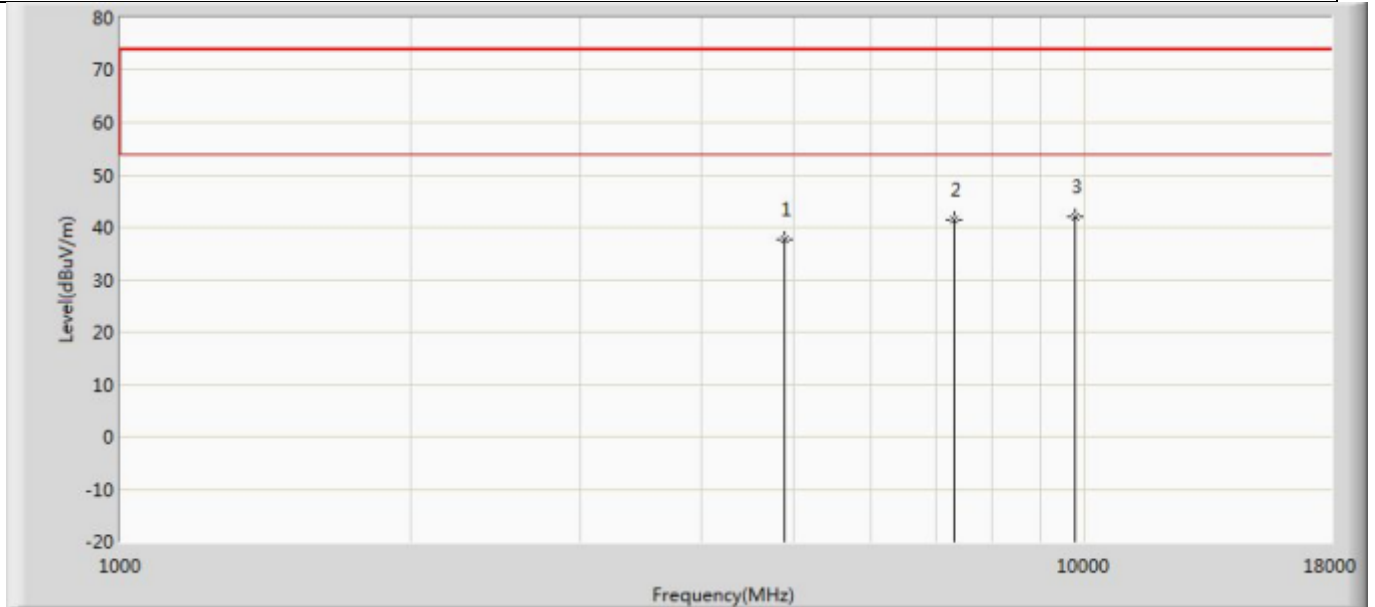

No	Mark	Frequency (MHz)	Measure Level (dBuV/m)	Reading Level (dBuV)	Over Limit (dB)	Limit (dBuV/m)	Factor (dB)	Type
1		4882.000	37.776	48.937	-36.224	74.000	-11.160	PK
2		7323.000	41.508	48.634	-32.492	74.000	-7.126	PK
3	*	9764.000	42.033	47.384	-31.967	74.000	-5.351	PK

Profile: 2260325R	Page No.: 34
Engineer: YuLiu	
Site: AC5	Time: 2022/06/30 - 01:58
Limit: FCC_Part15.209_RE(3m)	Margin: 0
Probe: Horn_3117_00167055(1-18GHz)	Polarity: Vertical
EUT: LBEE5HY2DU	Power: DC 3.6V
Note: Mode 3:Transmit at 2441MHz by 3DH5	

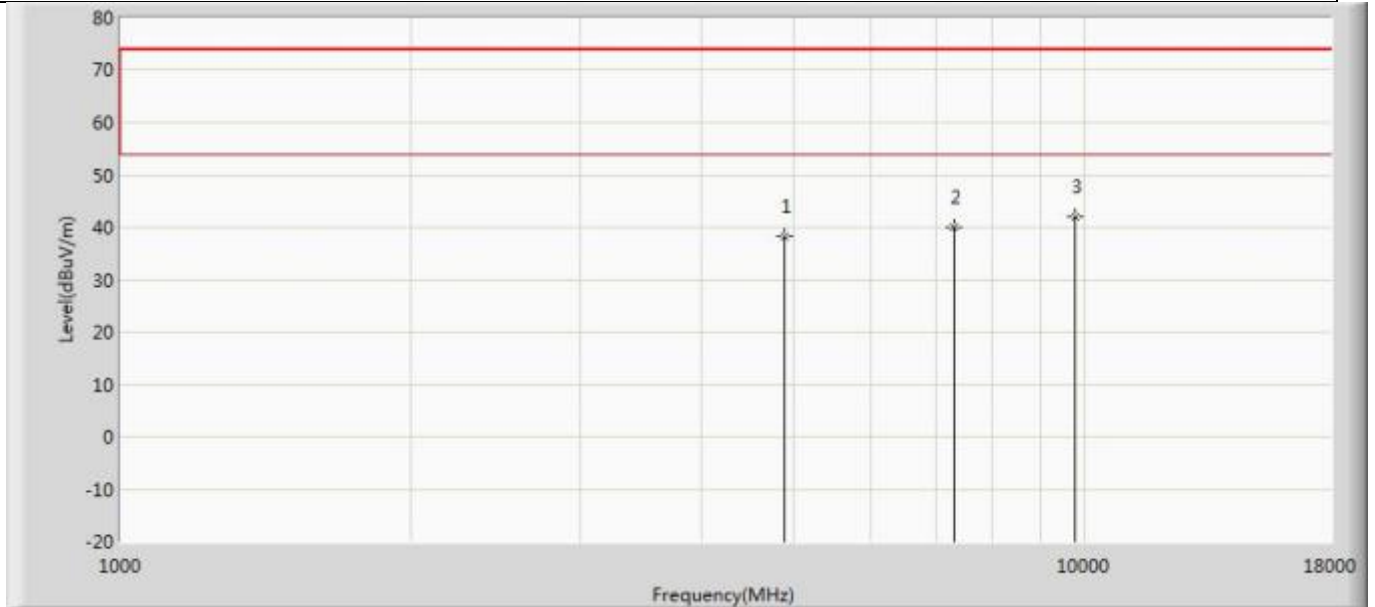

No	Mark	Frequency (MHz)	Measure Level (dBuV/m)	Reading Level (dBuV)	Over Limit (dB)	Limit (dBuV/m)	Factor (dB)	Type
1		4882.000	38.280	49.441	-35.720	74.000	-11.160	PK
2		7323.000	40.117	47.243	-33.883	74.000	-7.126	PK
3	*	9764.000	41.978	47.329	-32.022	74.000	-5.351	PK

Profile: 2260325R	Page No.: 35
Engineer: YuLiu	
Site: AC5	Time: 2022/06/30 - 01:59
Limit: FCC_Part15.209_RE(3m)	Margin: 0
Probe: Horn_3117_00167055(1-18GHz)	Polarity: Horizontal
EUT: LBEE5HY2DU	Power: DC 3.6V
Note: Mode 3:Transmit at 2480MHz by 3DH5	

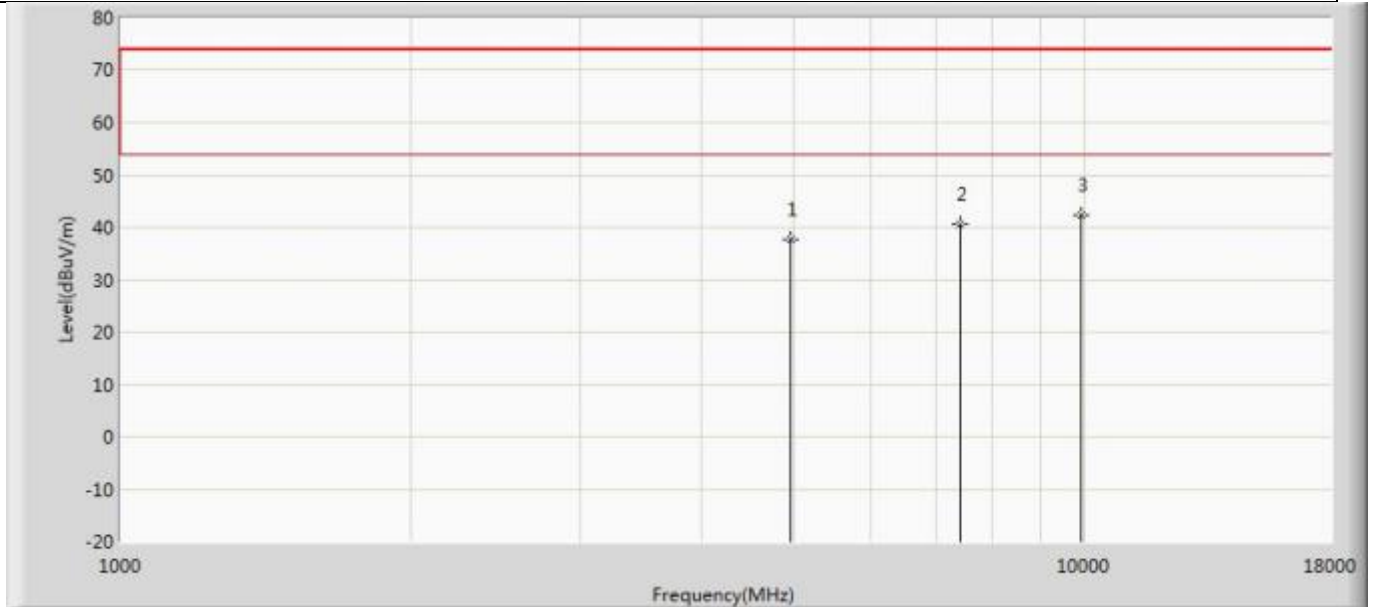

No	Mark	Frequency (MHz)	Measure Level (dBuV/m)	Reading Level (dBuV)	Over Limit (dB)	Limit (dBuV/m)	Factor (dB)	Type
1		4960.000	37.619	49.270	-36.381	74.000	-11.651	PK
2		7440.000	40.582	47.611	-33.418	74.000	-7.029	PK
3	*	9920.000	42.359	47.746	-31.641	74.000	-5.386	PK

Profile: 2260325R	Page No.: 36
Engineer: YuLiu	
Site: AC5	Time: 2022/06/30 - 01:59
Limit: FCC_Part15.209_RE(3m)	Margin: 0
Probe: Horn_3117_00167055(1-18GHz)	Polarity: Vertical
EUT: LBEE5HY2DU	Power: DC 3.6V
Note: Mode 3:Transmit at 2480MHz by 3DH5	

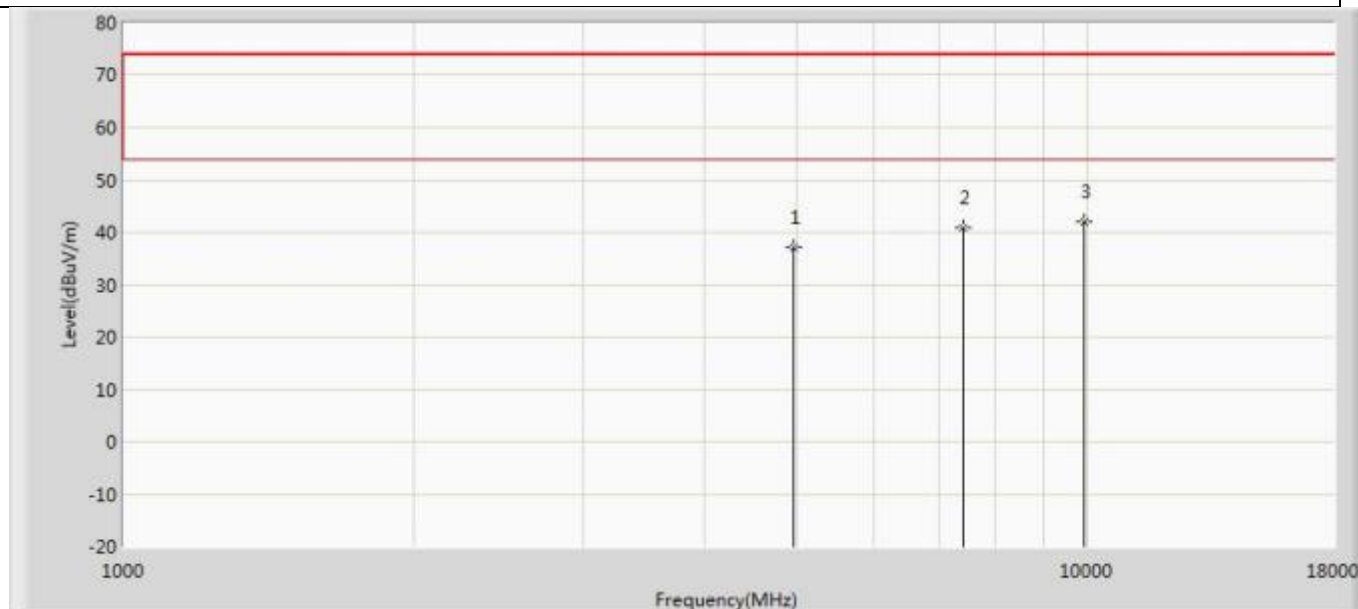

No	Mark	Frequency (MHz)	Measure Level (dBuV/m)	Reading Level (dBuV)	Over Limit (dB)	Limit (dBuV/m)	Factor (dB)	Type
1		4960.000	37.074	48.725	-36.926	74.000	-11.651	PK
2		7440.000	40.988	48.017	-33.012	74.000	-7.029	PK
3	*	9920.000	42.102	47.489	-31.898	74.000	-5.386	PK

Note:

1. Measured Level = Reading Level + Factor.
2. The test frequency range, 9kHz~30MHz, worst case are at least 20dB below the limits, therefore no data appear in the report.
3. This limit applies for both peak and average detector, if the test result on peak is lower than average limit, then average measurement needn't be performed.
4. The points in graph are the highest data in test frequency range.

The worst case of Radiated Emission below 1GHz:

Profile: 2260325R	Page No.: 59
Engineer: Yuliu	
Site: AC2	Time: 2022/07/04 - 22:27
Limit: FCC_Part15.109_RE(3m)_ClassB	Margin: 0
Probe: AC2_3M(30-1000M)	Polarity: Horizontal
EUT: LBEE5HY2DU	Power: DC 3.6V
Note: Mode 1: Transmit at 2480MHz by DH5	

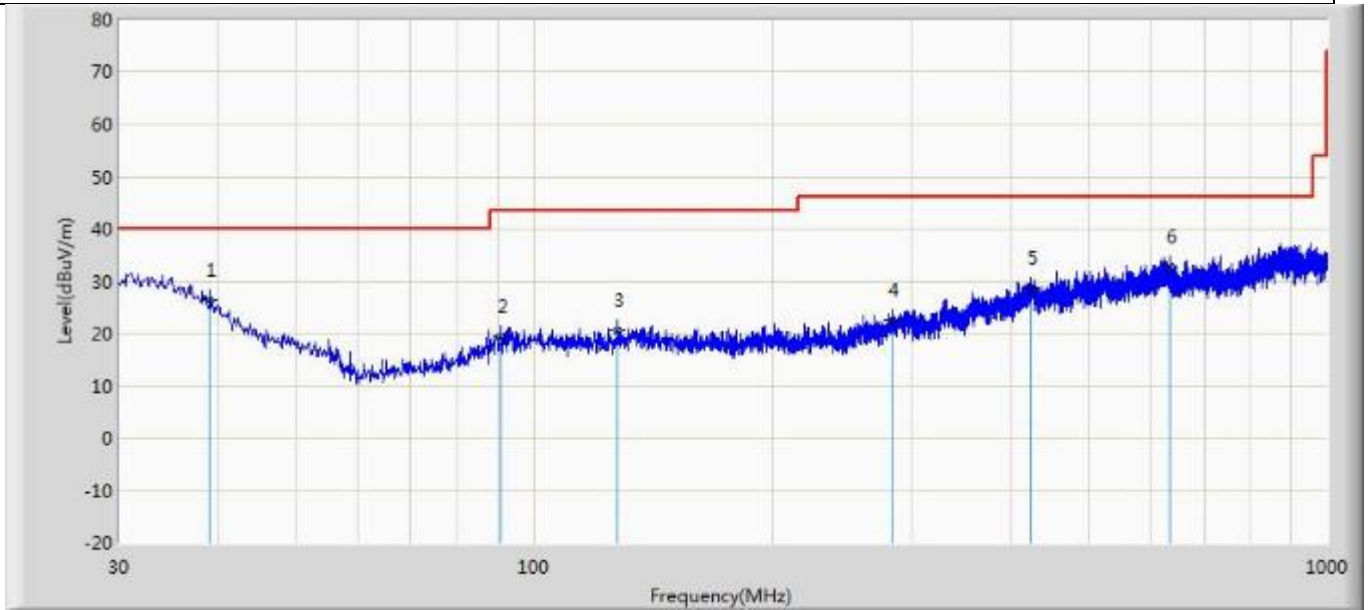

No	Mark	Frequency (MHz)	Measure Level (dBuV/m)	Reading Level (dBuV)	Over Limit (dB)	Limit (dBuV/m)	Factor (dB)	Type
1		39.094	26.458	3.359	-13.542	40.000	23.099	QP
2		90.989	19.502	5.732	-23.998	43.500	13.770	QP
3		127.485	20.498	3.379	-23.002	43.500	17.120	QP
4		283.170	22.504	2.262	-23.496	46.000	20.242	QP
5		422.971	28.690	1.446	-17.310	46.000	27.244	QP
6	*	633.704	32.716	3.224	-13.284	46.000	29.492	QP

Profile: 2260325R	Page No.: 60
Engineer: Yuliu	
Site: AC2	Time: 2022/07/04 - 22:27
Limit: FCC_Part15.109_RE(3m)_ClassB	Margin: 0
Probe: AC2_3M(30-1000M)	Polarity: Vertical
EUT: LBEE5HY2DU	Power: DC 3.6V
Note: Mode 1:Transmit at 2480MHz by DH5	

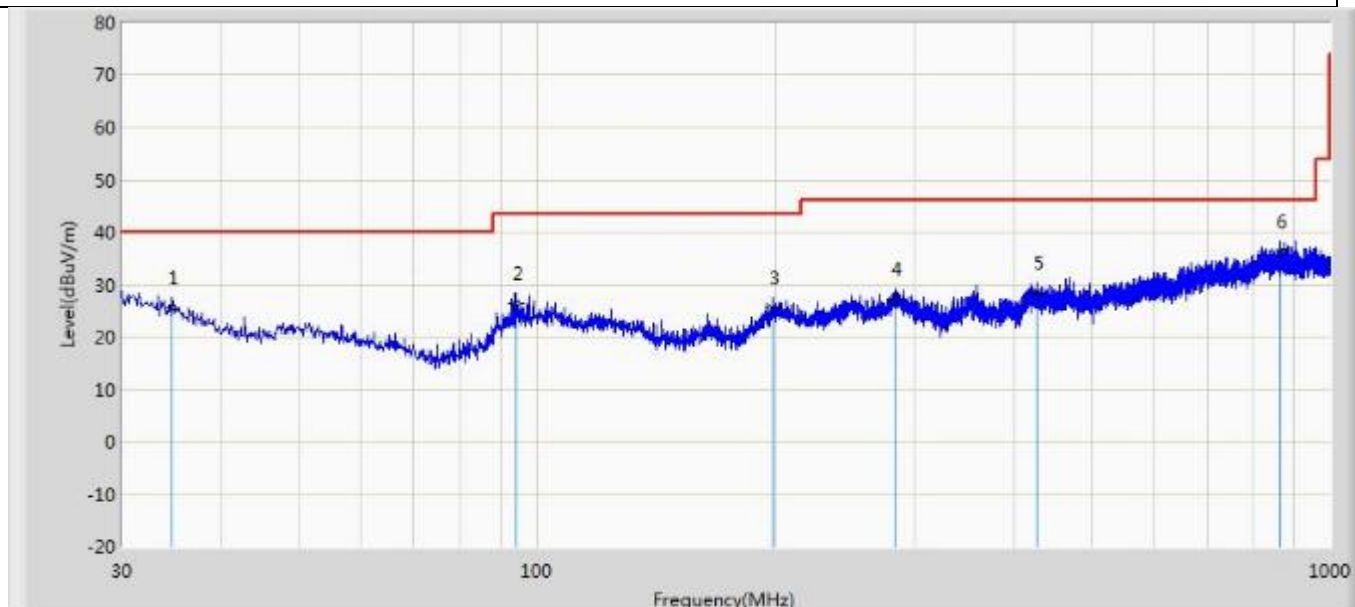

No	Mark	Frequency (MHz)	Measure Level (dBuV/m)	Reading Level (dBuV)	Over Limit (dB)	Limit (dBuV/m)	Factor (dB)	Type
1		34.607	25.507	2.788	-14.493	40.000	22.719	QP
2		94.384	26.351	6.820	-17.149	43.500	19.531	QP
3		198.416	25.643	2.566	-17.857	43.500	23.076	QP
4		282.685	27.266	2.177	-18.734	46.000	25.089	QP
5		426.730	28.292	2.271	-17.708	46.000	26.021	QP
6	*	866.625	36.350	3.391	-9.650	46.000	32.959	QP

Note:

1. All Readings below 1GHz are Quasi-Peak, above are performed with peak and/or average measurements as necessary.
2. " * ", means this data is the worst emission level.
3. Measurement Level = Reading Level + Factor(Probe+Cable-Amp)

The worst case of Radiated Emission above 18GHz:

Profile: 2260325R	Page No.: 43
Engineer: Yu Liu	
Site: AC5	Time: 2022/07/05 - 14:53
Limit: FCC_Part15.209_RE(3m)	Margin: 0
Probe: BBHA 9170_294(18-40GHz)	Polarity: Horizontal
EUT: LBEE5HY2DU	Power: DC 3.6V
Note: Mode 1:Transmit at 2402MHz by DH5	

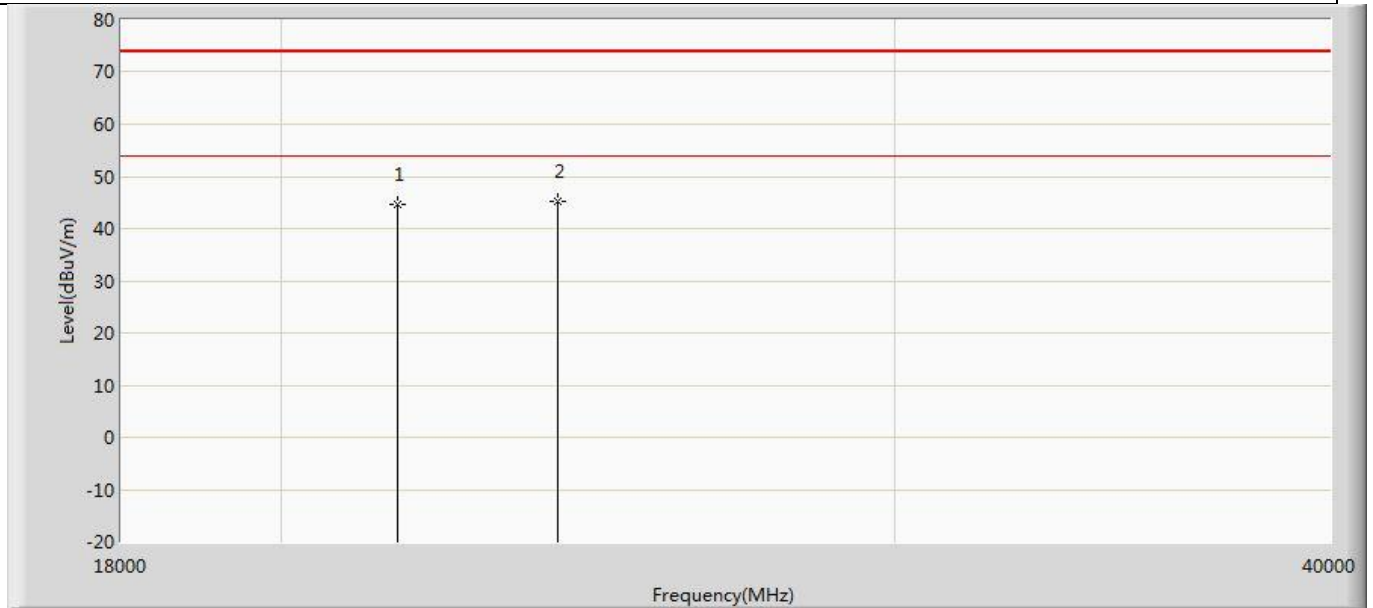

No	Mark	Frequency (MHz)	Measure Level (dBuV/m)	Reading Level (dBuV)	Over Limit (dB)	Limit (dBuV/m)	Factor (dB)	Type
1		21618.000	44.515	45.231	-29.485	74.000	-0.716	PK
2	*	24020.000	45.322	44.504	-28.678	74.000	0.818	PK

Profile: 2260325R	Page No.: 44
Engineer: Yu Liu	
Site: AC5	Time: 2022/08/01 - 14:53
Limit: FCC_Part15.209_RE(3m)	Margin: 0
Probe: BBHA 9170_294(18-40GHz)	Polarity: Vertical
EUT: LBEE5HY2DU	Power: DC 3.6V
Note: Mode 1:Transmit at 2402MHz by DH5	

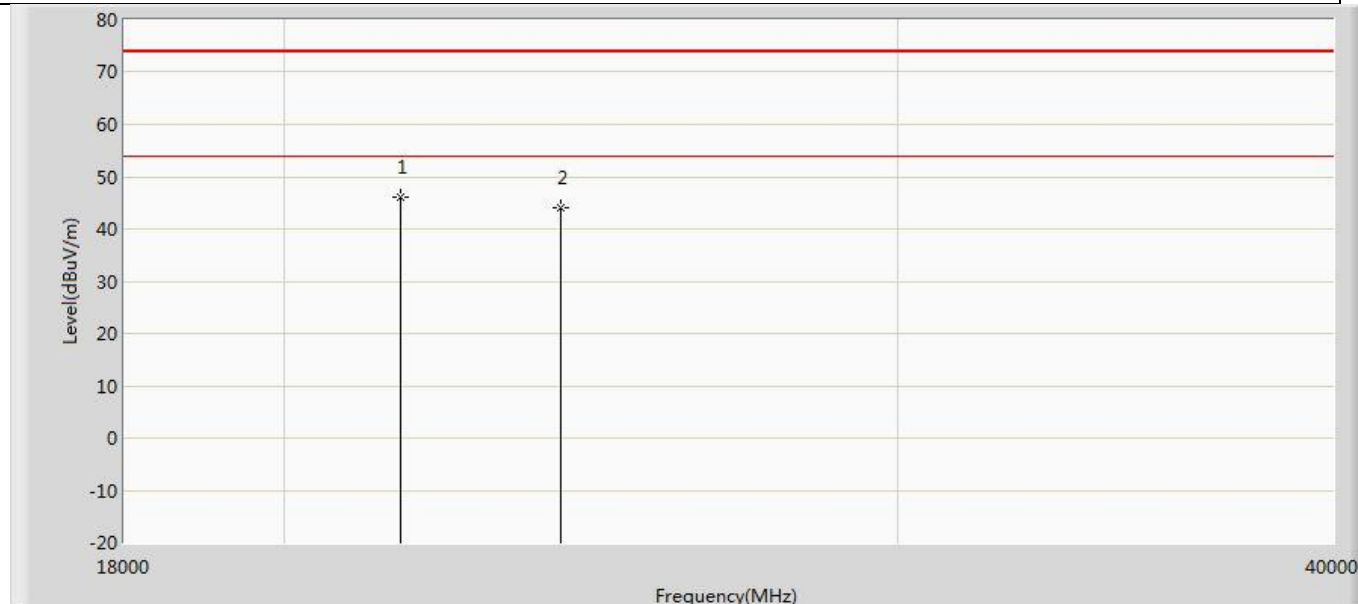

No	Mark	Frequency (MHz)	Measure Level (dBuV/m)	Reading Level (dBuV)	Over Limit (dB)	Limit (dBuV/m)	Factor (dB)	Type
1	*	21618.000	45.958	46.674	-28.042	74.000	-0.716	PK
2		24020.000	44.166	43.348	-29.834	74.000	0.818	PK

Note:

1. Measured Level = Reading Level + Factor.
2. The test frequency range, 9kHz~30MHz, worst case are at least 20dB below the limits, therefore no data appear in the report.
3. This limit applies for both peak and average detector, if the test result on peak is lower than average limit, then average measurement needn't be performed.
- 4.The points in graph are the highest data in test frequency range.

4.3 20dB Bandwidth	VERDICT: PASS
---------------------------	----------------------

4.3.1 Limit	
Standard	FCC Part 15 Subpart C Paragraph 15.247(a)
<input checked="" type="checkbox"/>	For frequency hopping systems operating in 2400-2483.5 MHz band, within frequency range.
<input type="checkbox"/>	For frequency hopping systems operating in 902-928 MHz band, the maximum allowed 20 dB bandwidth of the hopping channel is 500 kHz.
<input type="checkbox"/>	For frequency hopping systems operating in 5725-5850 MHz band, the maximum 20 dB bandwidth of the hopping channel is 1 MHz.

4.3.2 Test Setup

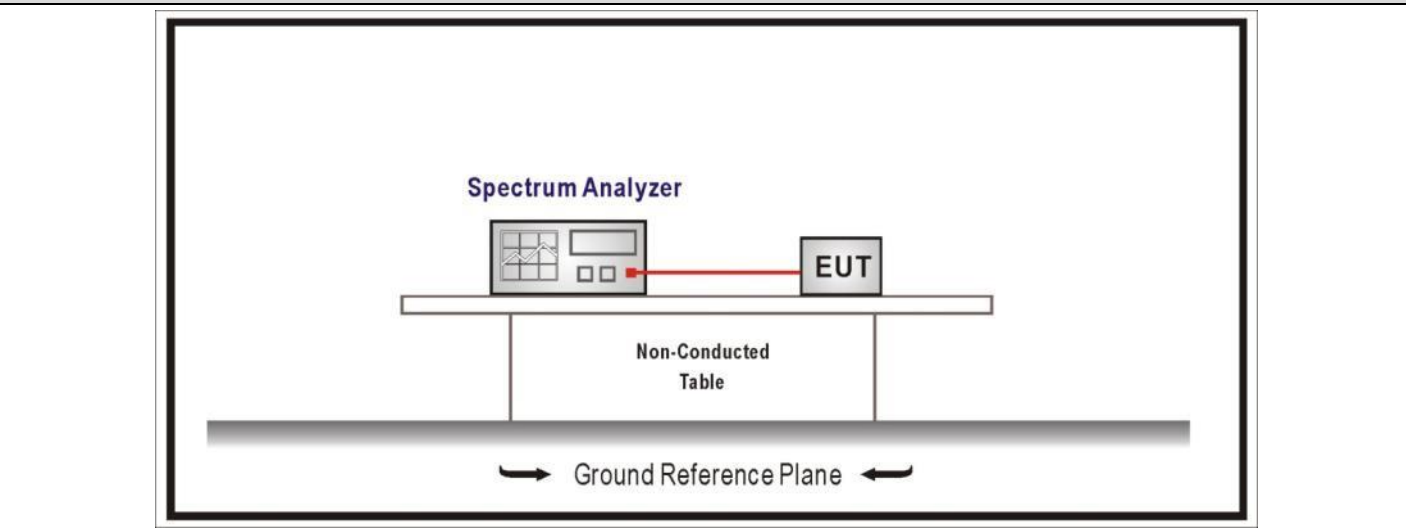

4.3.3 Test Procedure			
----------------------	--	--	--

	References Rule	Chapter	Description
<input checked="" type="checkbox"/>	ANSI C63.10	6.9	Occupied bandwidth tests
<input checked="" type="checkbox"/>	ANSI C63.10	6.9.2	Occupied bandwidth—relative measurement procedure

4.3.4 Test Data

Mode	Channel	Frequency (MHz)	20dB Bandwidth (kHz)	99% Bandwidth (kHz)
1	00	2402	929.3	870.20
	39	2441	927.5	872.11
	78	2480	930.3	873.49
2	00	2402	1339	1239.8
	39	2441	1347	1276.5
	78	2480	1348	1270.0
3	00	2402	1308	1229.9
	39	2441	1329	1266.5
	78	2480	1326	1252.3

Note 1: The worst data plot as below:

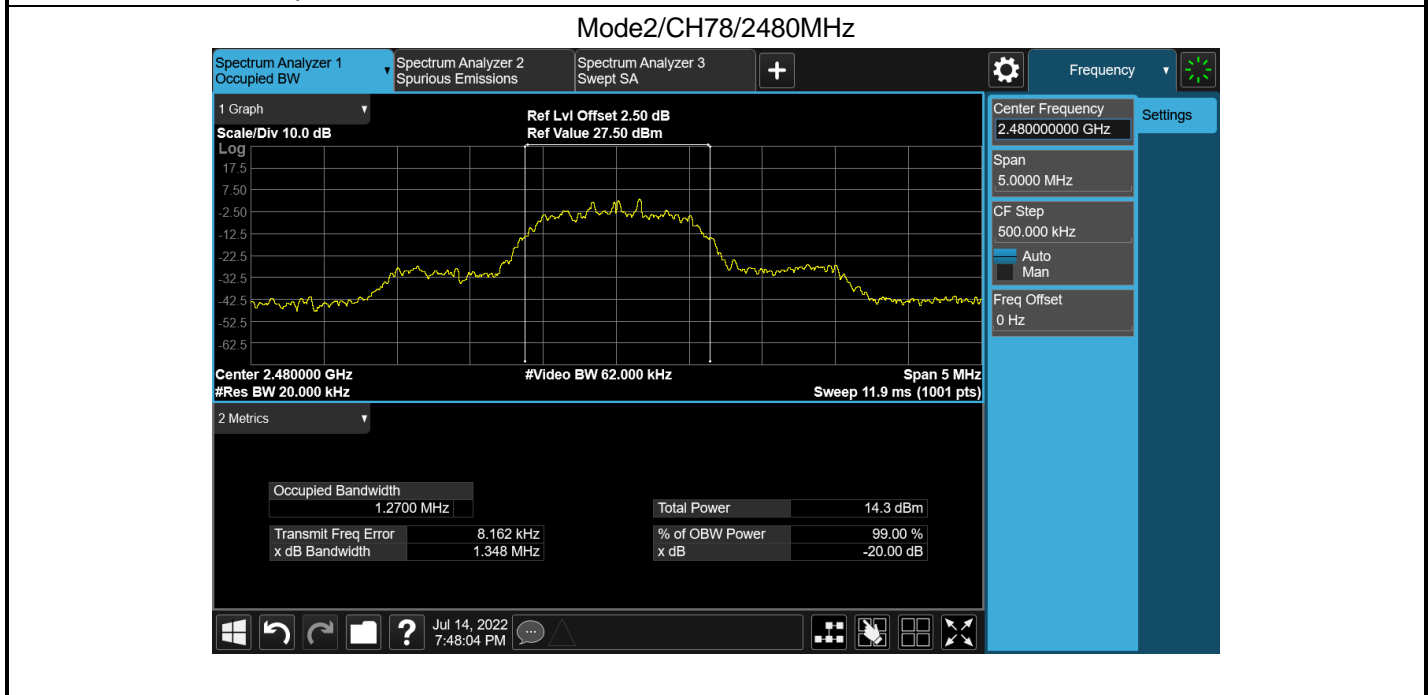

4.4 Carrier Frequency Separation	VERDICT: PASS
---	----------------------

4.4.1 Limit	
Standard	FCC Part 15 Subpart C Paragraph 15.247(a)
<input type="checkbox"/>	Frequency hopping systems shall have hopping channel carrier frequencies separated by a minimum of 25 kHz or the 20 dB bandwidth of the hopping channel, whichever is greater.
<input checked="" type="checkbox"/>	Frequency hopping systems operating in the 2400-2483.5 MHz band may have hopping channel carrier frequencies that are separated by 25 kHz or two-thirds of the 20 dB bandwidth of the hopping channel.
<input type="checkbox"/>	The 20 dB bandwidth of the hopping channel is less than 250 kHz, the system shall use at least 50 hopping frequencies and the average time of occupancy on any frequency shall not be greater than 0.4 seconds within a
<input type="checkbox"/>	The 20 dB bandwidth of the hopping channel is 250 kHz or greater, the system shall use at least 25 hopping frequencies and the average time of occupancy on any frequency shall not be greater than 0.4 seconds within a
<input type="checkbox"/>	Frequency hopping systems operating in the 5725-5850 MHz band shall use at least 75 hopping frequencies. The maximum 20 dB bandwidth of the hopping channel is 1 MHz.

4.4.2 Test Setup

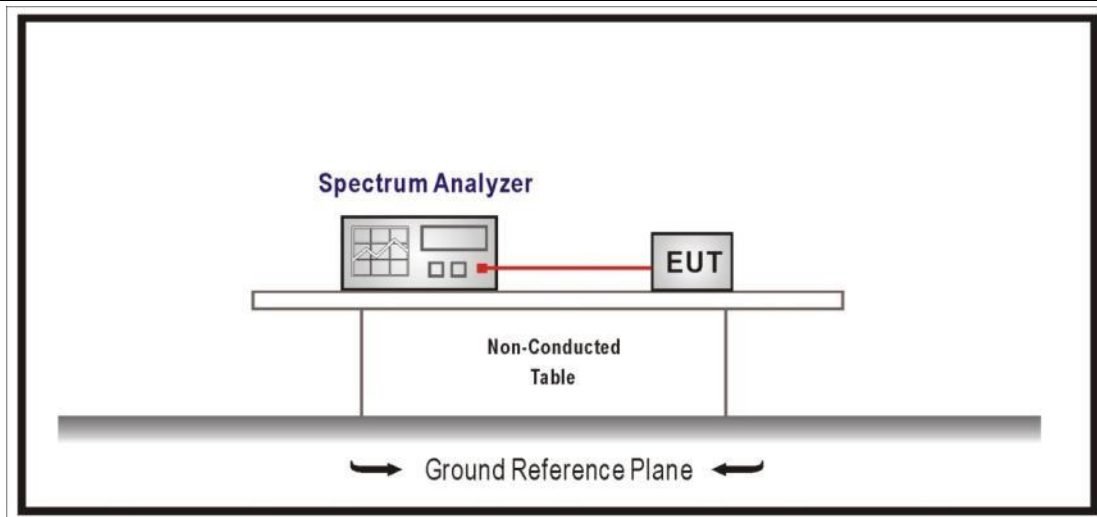

4.4.3 Test Procedure			
----------------------	--	--	--

	References Rule	Chapter	Description
<input checked="" type="checkbox"/>	ANSI C63.10	7.8	Evaluation of frequency-hopping device parameters
<input checked="" type="checkbox"/>	ANSI C63.10	7.8.2	Carrier frequency separation

4.5 Number of hopping Frequencies

VERDICT: PASS

4.5.1 Limit

Standard		FCC Part 15 Subpart C Paragraph 15.247(a)
<input checked="" type="checkbox"/>	For frequency hopping systems operating in the 2400-2483.5 MHz band shall use at least 15 hopping frequencies.	
<input type="checkbox"/>	For frequency hopping systems operating in 902-928 MHz band, if the 20 dB bandwidth of the hopping channel is less than 250 kHz, shall use at least 50 hopping frequencies.	
<input type="checkbox"/>	For frequency hopping systems operating in 902-928 MHz band, if the 20 dB bandwidth of the hopping channel is higher than 250 kHz, shall use at least 25 hopping frequencies.	
<input type="checkbox"/>	For frequency hopping systems operating in the 5725-5850 MHz band shall use at least 75 hopping frequencies.	

4.5.2 Test Setup

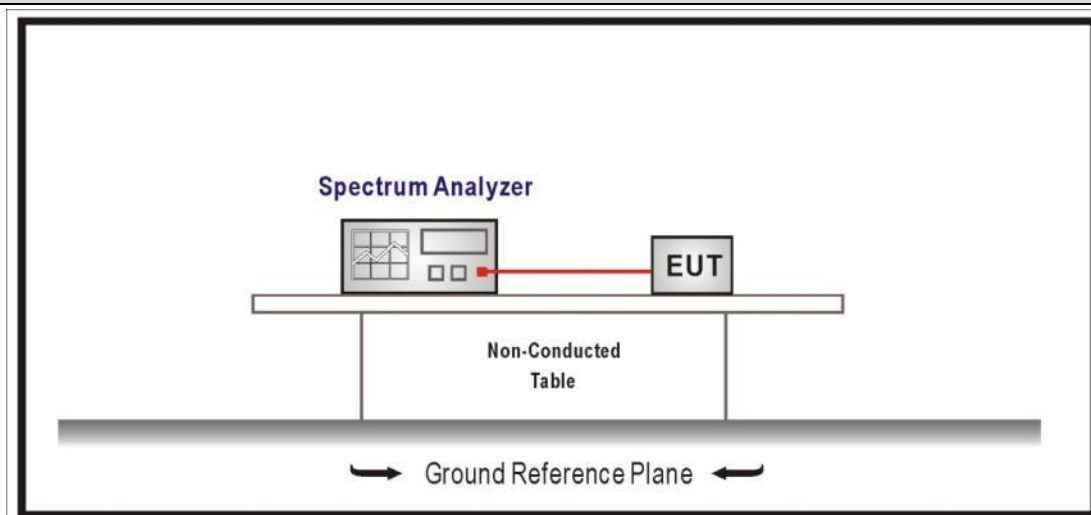

4.5.3 Test Procedure

References Rule	Chapter	Description
<input checked="" type="checkbox"/> ANSI C63.10	7.8.	Evaluation of frequency-hopping device parameters
<input checked="" type="checkbox"/> ANSI C63.10	7.8.3	Number of Hopping Frequencies

4.5.4 Test Data

Mode	Number of Hopping Frequencies	Limit	Result
1	79	>15	Pass
2	79	>15	Pass
3	79	>15	Pass

Mode 1

Mode2

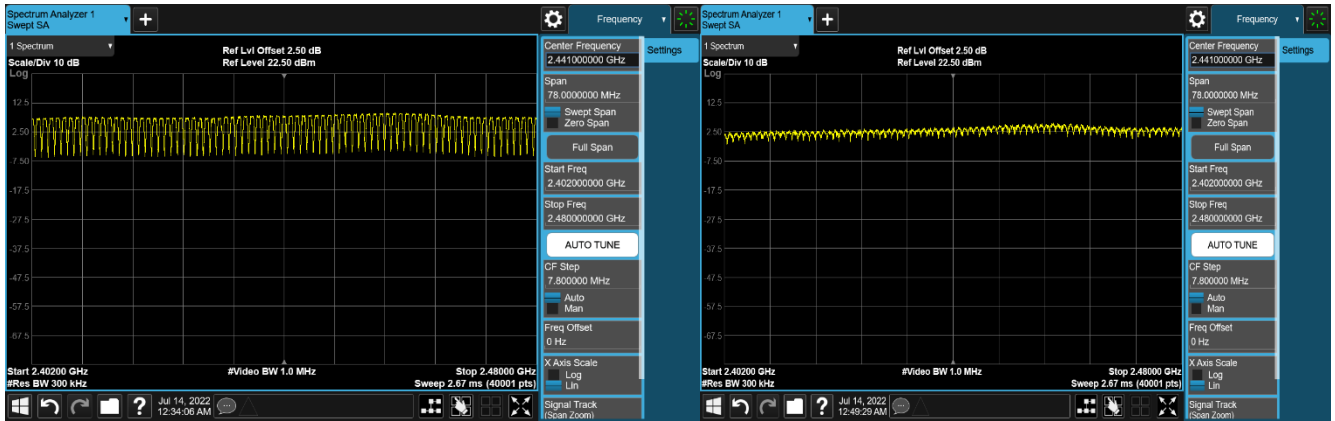

Mode 3

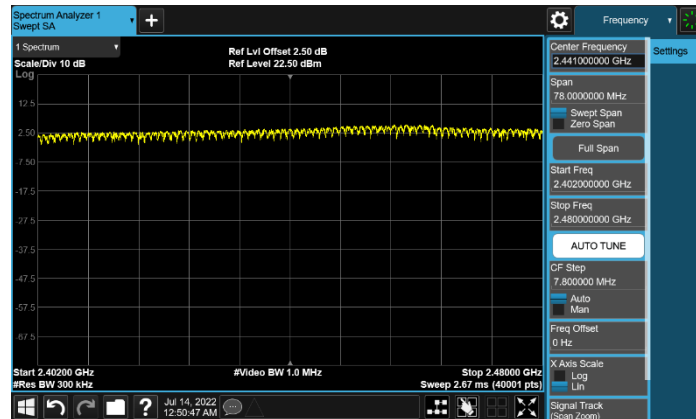

4.6 Time of Occupancy(Dwell Time)

VERDICT: PASS

4.6.1 Limit

Standard	
FCC Part 15 Subpart C Paragraph 15.247(a)	
<input checked="" type="checkbox"/>	Frequency hopping systems in the 2400-2483.5 MHz band shall use at least 15 channels. The average time of occupancy on any channel shall not be greater than 0.4 seconds within a period of 0.4 seconds multiplied by the number of hopping channels employed.
<input type="checkbox"/>	For frequency hopping systems operating in the 902-928 MHz band: if the 20 dB bandwidth of the hopping channel is less than 250 kHz, the system shall use at least 50 hopping frequencies and the average time of occupancy on any frequency shall not be greater than 0.4 seconds within a 20 second period
<input type="checkbox"/>	For frequency hopping systems operating in the 902-928 MHz band: if the 20 dB bandwidth of the hopping channel is 250 kHz or greater, the system shall use at least 25 hopping frequencies and the average time of occupancy on any frequency shall not be greater than 0.4 seconds within a 10 second period.
<input type="checkbox"/>	Frequency hopping systems operating in the 5725-5850 MHz band shall use at least 75 hopping frequencies. The maximum 20 dB bandwidth of the hopping channel is 1 MHz. The average time of occupancy on any frequency shall not be greater than 0.4 seconds within a 30 second period.

4.6.2 Test Setup

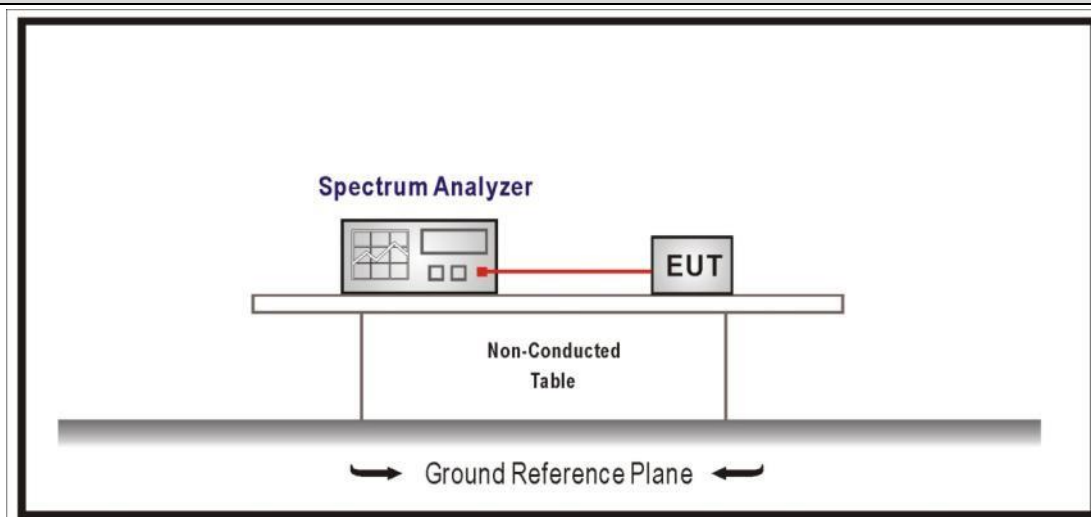

4.6.3 Test Procedure

References Rule	Chapter	Description
<input checked="" type="checkbox"/> ANSI C63.10	7.8	Evaluation of frequency-hopping device parameters
<input checked="" type="checkbox"/> ANSI C63.10	7.8.4	Time of occupancy (dwell time)

4.6.4 Test Data

Mode	Channel	Frequency (MHz)	Time of Occupancy (ms)	Limit (ms)	Result
1	39	2441	121.504	< 400	Pass

Note1: Test Time Period: $0.4 \times 79 = 31.6 \text{sec}$

Note2: Time of Occupancy = $0.3797 \times 32 \times 31.6 / 3.16 = 121.504 \text{ms}$

Note3: We have evaluated different packet type, shown in the report is the worst data.

Channel 39 (2441MHz) - (DH1)



Mode	Channel	Frequency (MHz)	Time of Occupancy (ms)	Limit (ms)	Result
1	39	2441	245.4	< 400	Pass

Note1: Test Time Period: $0.4 \times 79 = 31.6 \text{sec}$

Note2: Time of Occupancy = $1.636 \times 15 \times 31.6 / 3.16 = 245.4 \text{ms}$

Note3: We have evaluated different packet type, shown in the report is the worst data.

Channel 39 (2441MHz) - (DH3)

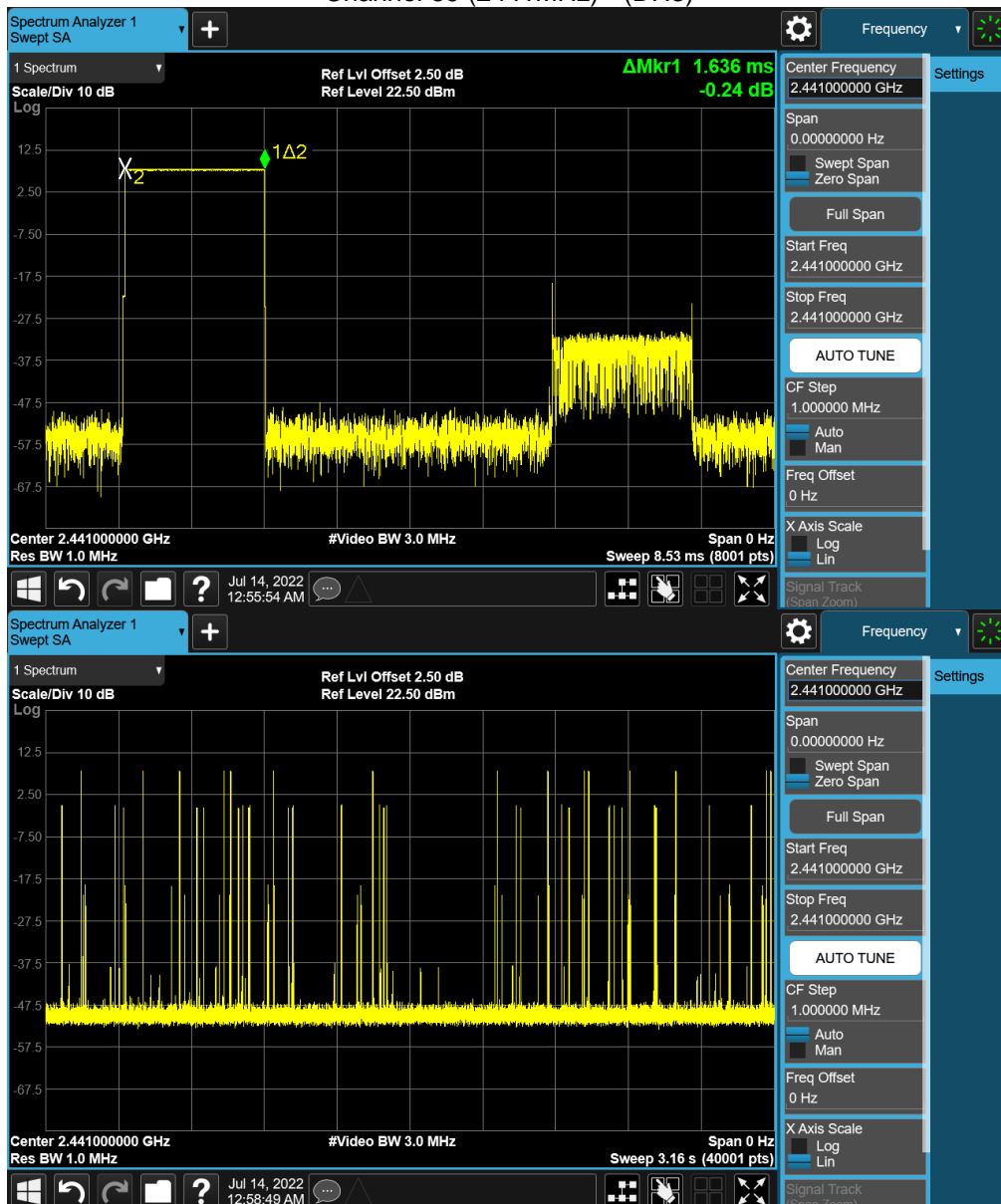

Mode	Channel	Frequency (MHz)	Time of Occupancy (ms)	Limit (ms)	Result
1	39	2441	288.2	< 400	Pass

Note1: Test Time Period: $0.4 \times 79 = 31.6 \text{sec}$

Note2: Time of Occupancy = $2.882 \times 10^3 \times 31.6 / 3.16 = 288.2 \text{ms}$

Note3: We have evaluated different packet type, shown in the report is the worst data.

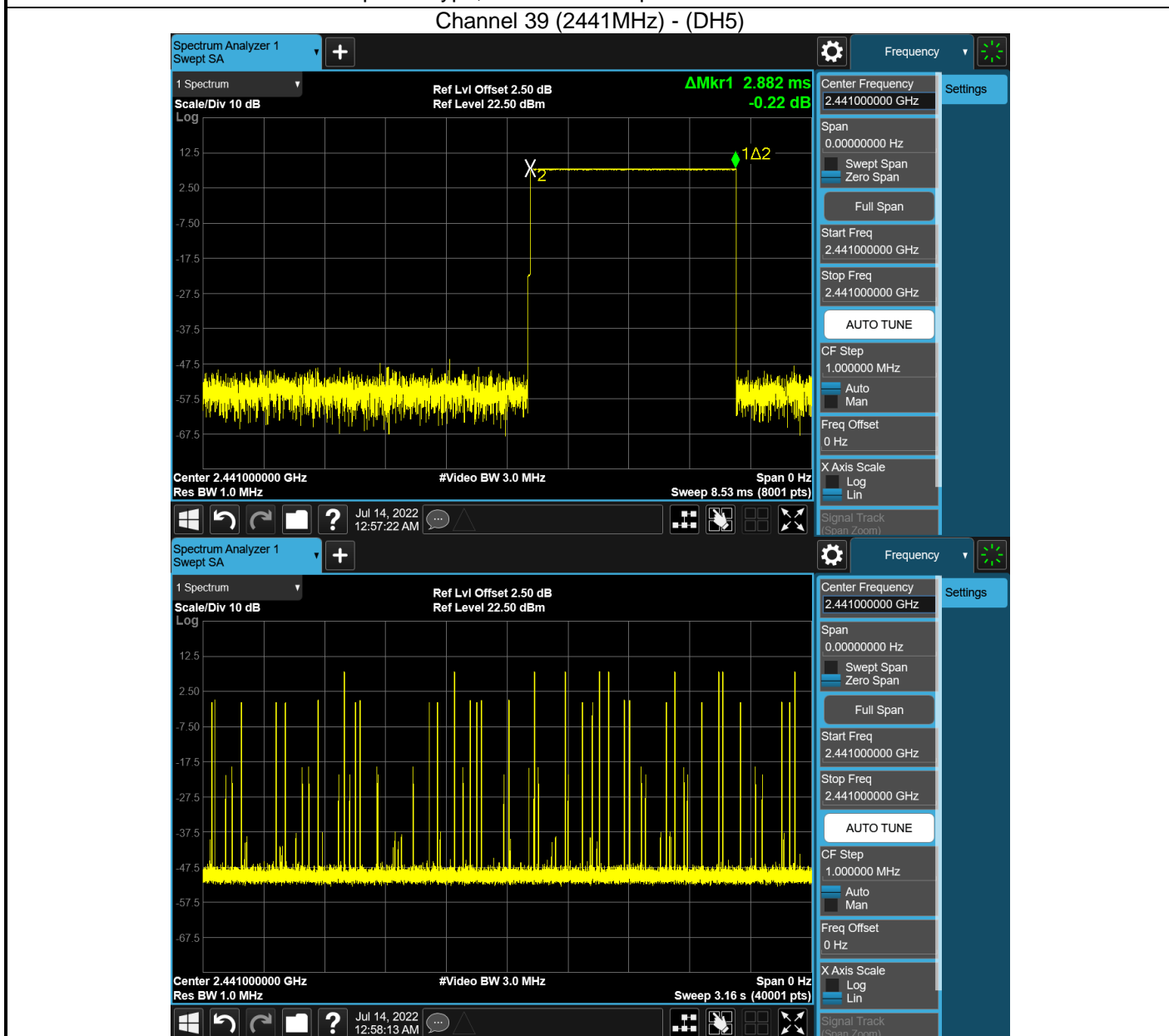

Note: The packet time of AFH mode is same as normal mode, due to the packet time of AFH mode multiply with lesser factor is dwell time of $0.4 \times 20 = 8 \text{S}$, the dwell time of AFH mode comply with the limit.

4.7 Peak Output Power	VERDICT: PASS
------------------------------	----------------------

4.7.1 Limit

Standard	FCC Part 15 Subpart C Paragraph 15.247 (a)(1)
<input checked="" type="checkbox"/>	Frequency hopping systems operating in the 2400-2483.5 MHz band employing at least 75 non-overlapping hopping channels, and all frequency hopping systems in the 5725-5850 MHz band: 1 watt. For all other frequency hopping systems in the 2400-2483.5 MHz band: 0.125 watts.
<input checked="" type="checkbox"/>	Frequency hopping systems operating in the 2400-2483.5 MHz band may have hopping channel carrier frequencies that are separated by 25 kHz or two-thirds of the 20 dB bandwidth of the hopping channel, whichever is greater, provided the systems operate with an output power no greater than 125 mW.
<input type="checkbox"/>	For frequency hopping systems operating in the 902-928 MHz band: 1 watt for systems employing at least 50 hopping channels; and, 0.25 watts for systems employing less than 50 hopping channels, but at least 25 hopping channels

4.7.2 Test Setup

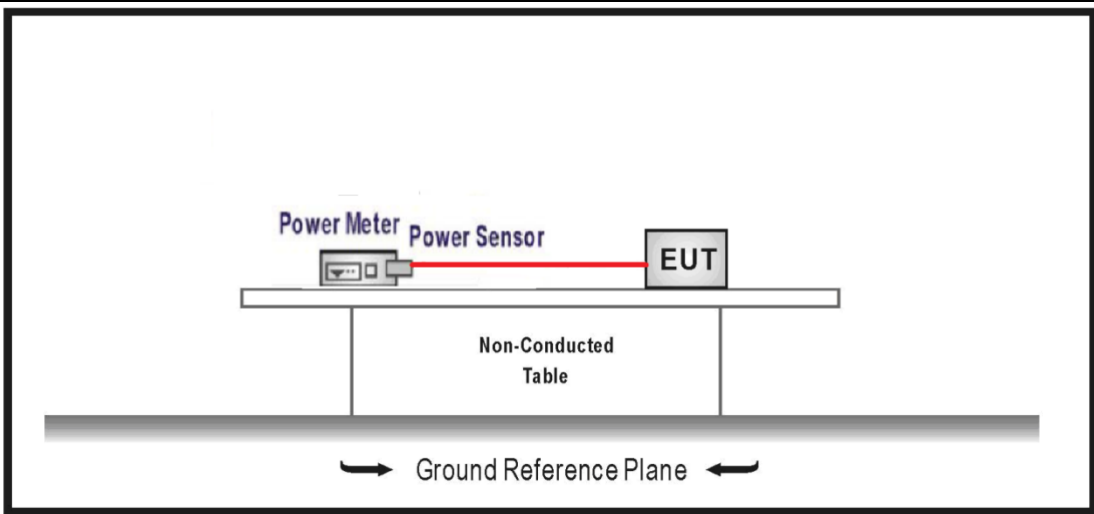

4.7.3 Test Procedure				
	References Rule		Chapter	Description
<input checked="" type="checkbox"/>	ANSI C63.10		7.8	Evaluation of frequency-hopping device parameters
	<input checked="" type="checkbox"/>	ANSI C63.10	7.8.5	Output power test procedure for frequency-hopping spread-spectrum (FHSS) devices

4.7.4 Test Data

Mode	Channel	Test Frequency (MHz)	Conducted Power (dBm)	Conducted Power Limit (dBm)	EIRP (dBm)	EIRP Limit (dBm)	Result
Mode 1	00	2402	8.26	≤21	8.36	≤27	Pass
	39	2441	9.25	≤21	9.35	≤27	Pass
	78	2480	8.83	≤21	8.93	≤27	Pass
Mode 2	00	2402	6.05	≤21	6.15	≤27	Pass
	39	2441	7.73	≤21	7.83	≤27	Pass
	78	2480	7.58	≤21	7.68	≤27	Pass
Mode 3	00	2402	6.02	≤21	6.12	≤27	Pass
	39	2441	7.72	≤21	7.82	≤27	Pass
	78	2480	7.59	≤21	7.69	≤27	Pass

4.8 Emissions in non-restricted frequency band

VERDICT: PASS

4.8.1 Limit

Standard	FCC Part 15 Subpart C Paragraph 15.247(d)	
RF Output power (Detection methods)	Limit(dB)	
RF Output power(Average detector)	30dBc(Note1)	
RF Output power(PK detector)	20dBc(Note2)	

Note 1: If maximum conducted (average) output power was used to demonstrate compliance as described in 9.2, then the peak power in any 100 kHz bandwidth outside of the authorized frequency band shall be attenuated by at least 30 dB relative to the maximum in-band peak PSD level in 100 kHz (i.e., 30 dBc).

Note 2: If the maximum peak conducted output power procedure was used, then the peak output power measured in any 100 kHz bandwidth outside of the authorized frequency band shall be attenuated by at least 20 dB relative to the maximum in-band peak PSD level in 100 kHz (i.e., 20 dBc).

4.8.2 Test Setup

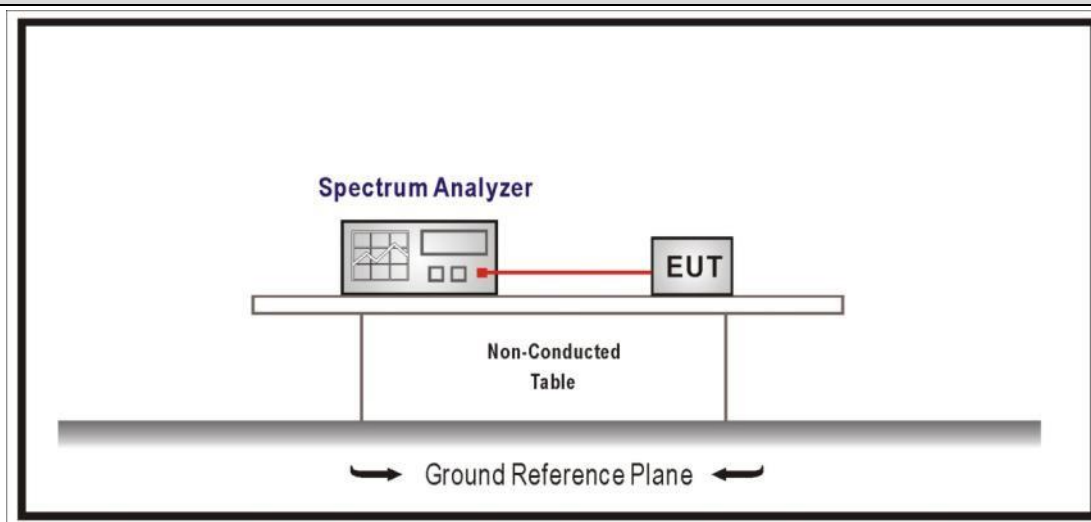

4.8.3 Test Procedure

References Rule	Chapter	Description
<input checked="" type="checkbox"/> ANSI C63.10	7.8	Evaluation of frequency-hopping device parameters
<input checked="" type="checkbox"/> ANSI C63.10	7.8.6	Band-edge measurements for RF conducted emissions

4.8.4 Test Data

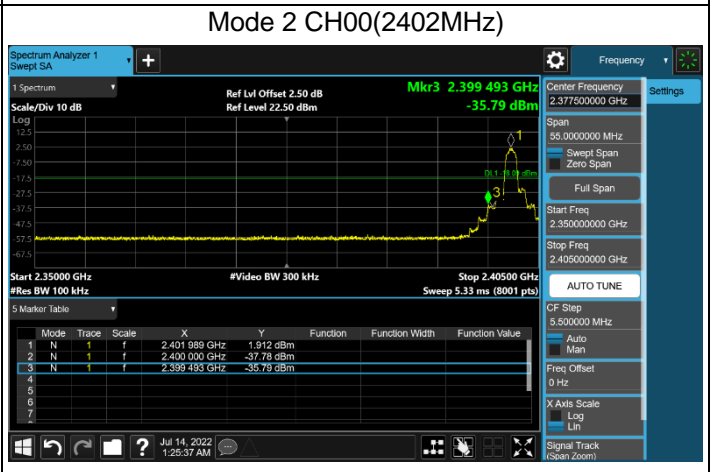
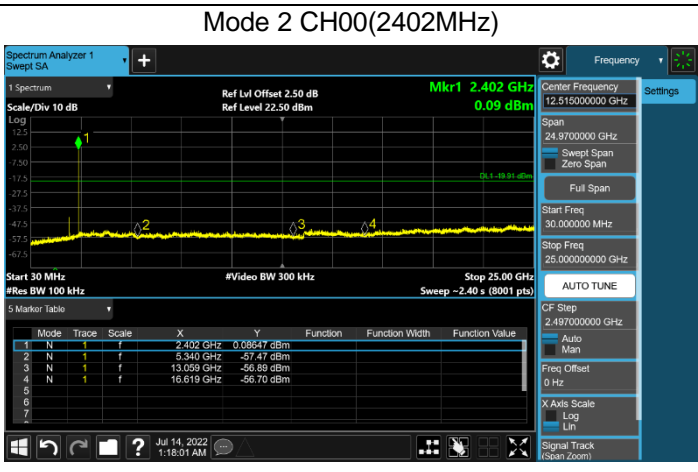
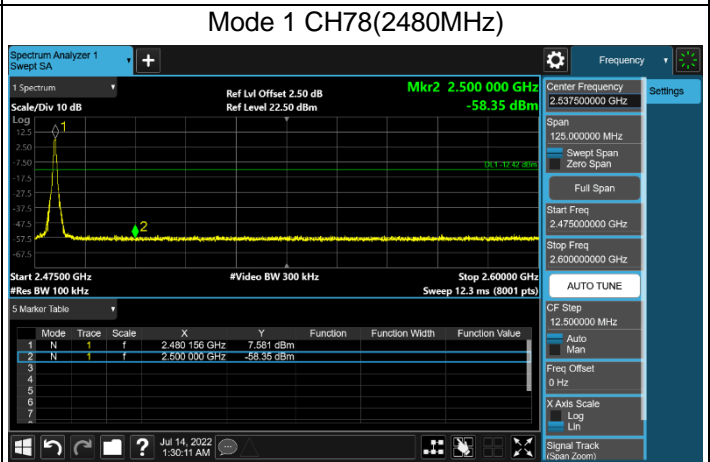
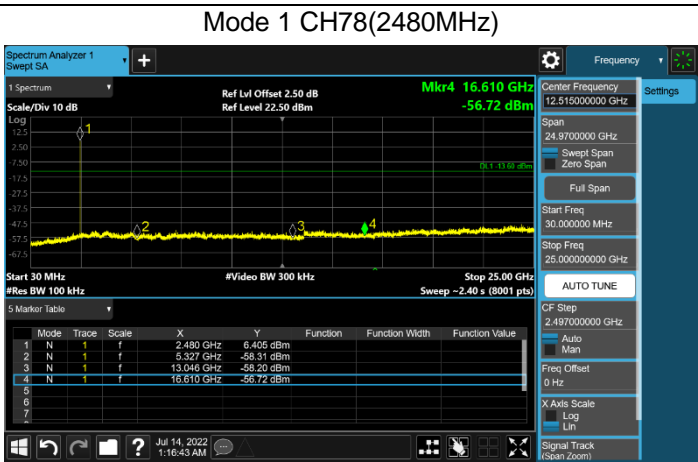
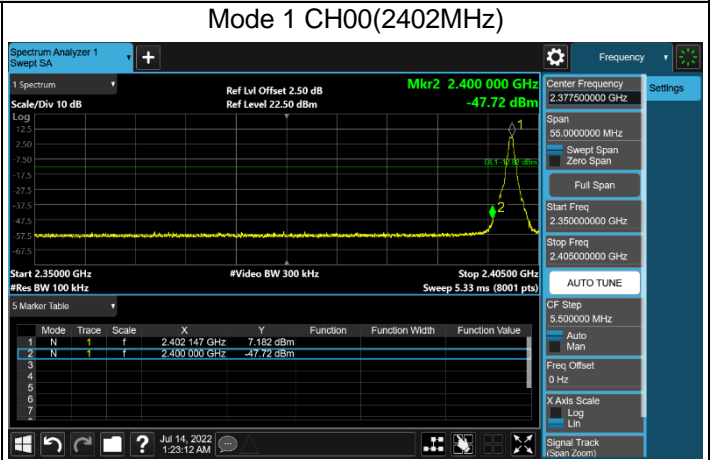
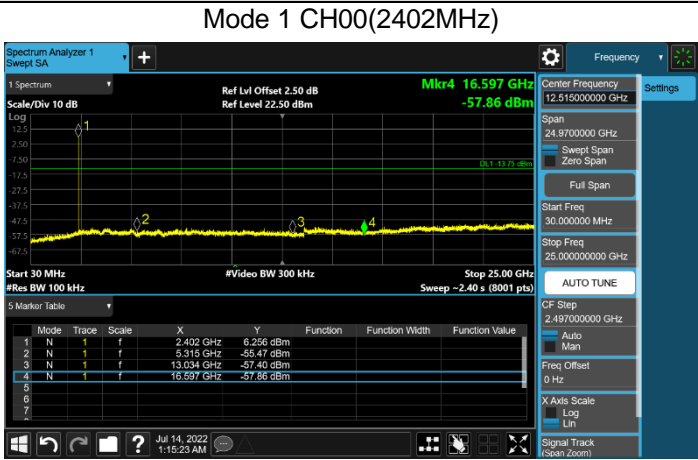

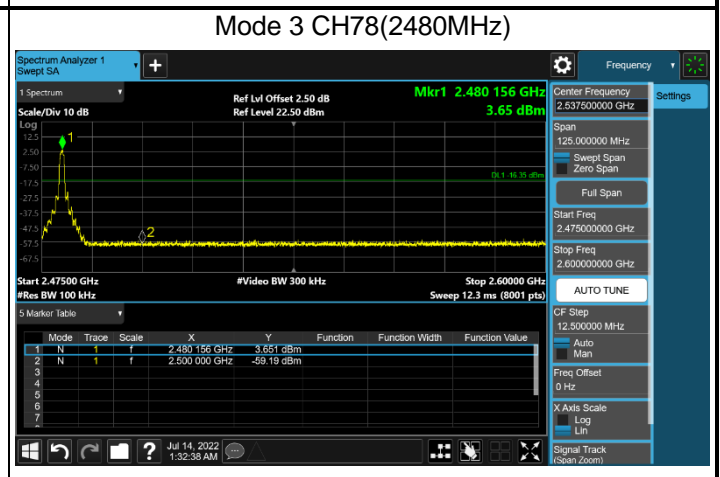
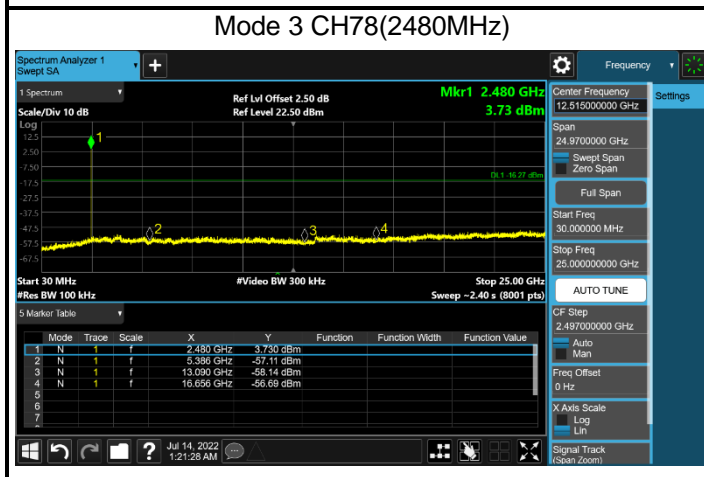
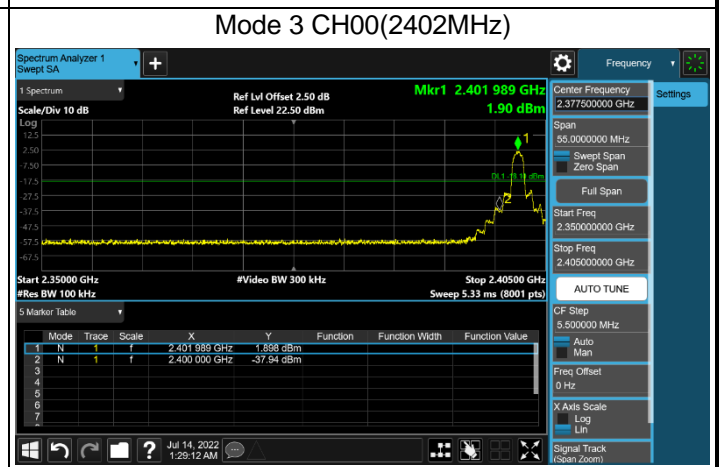
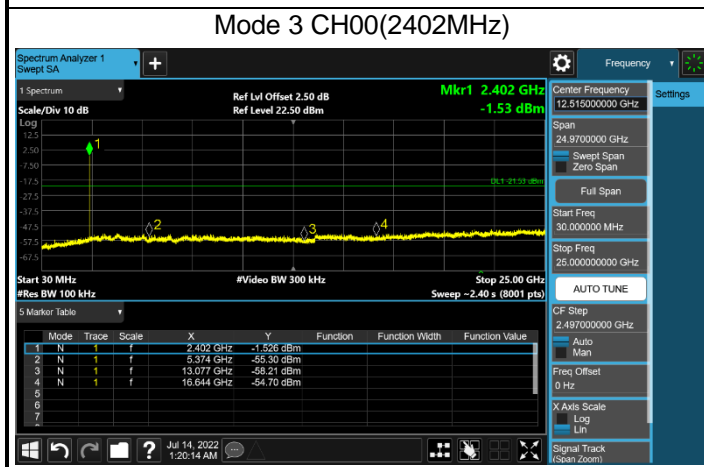
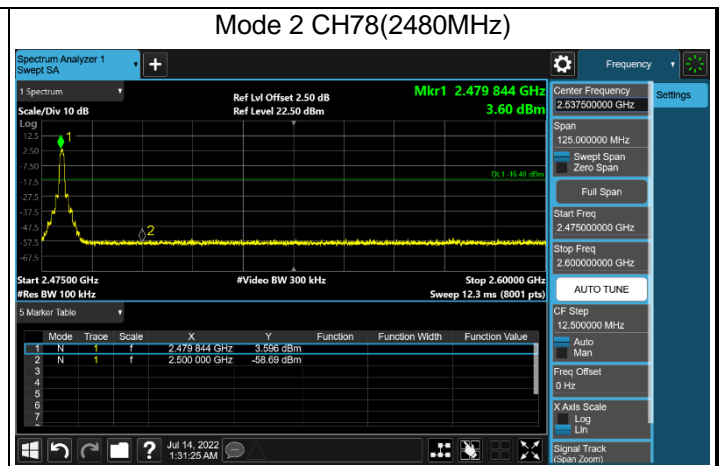
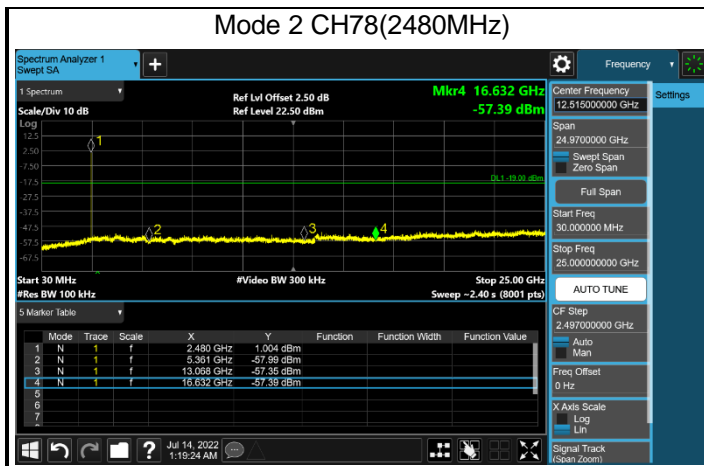

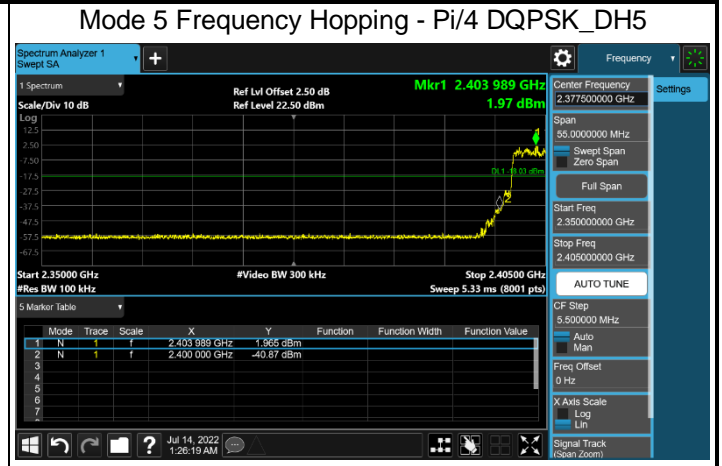
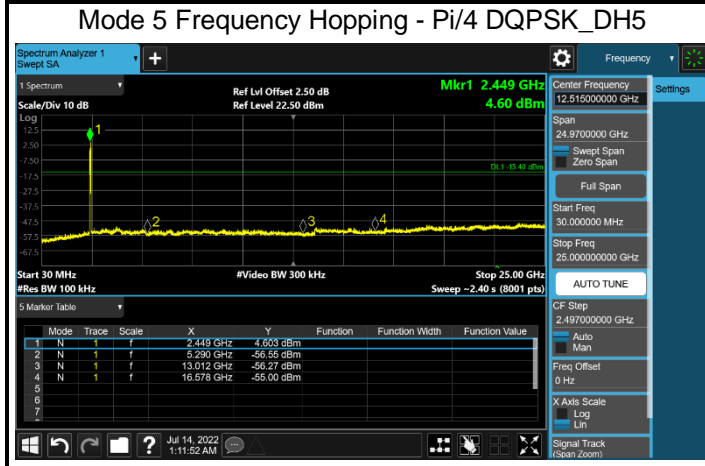
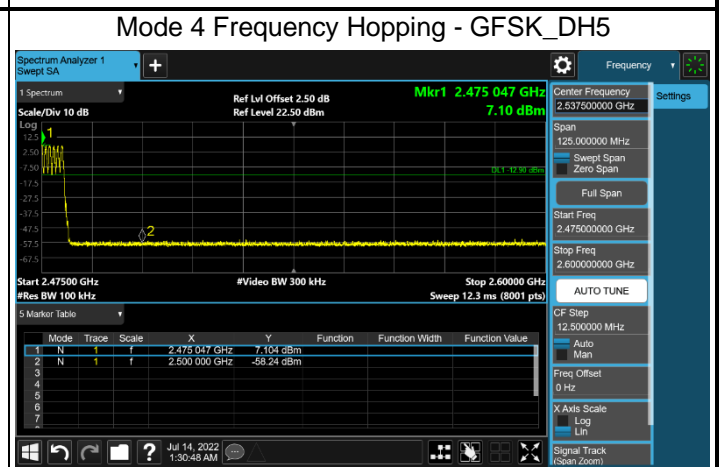
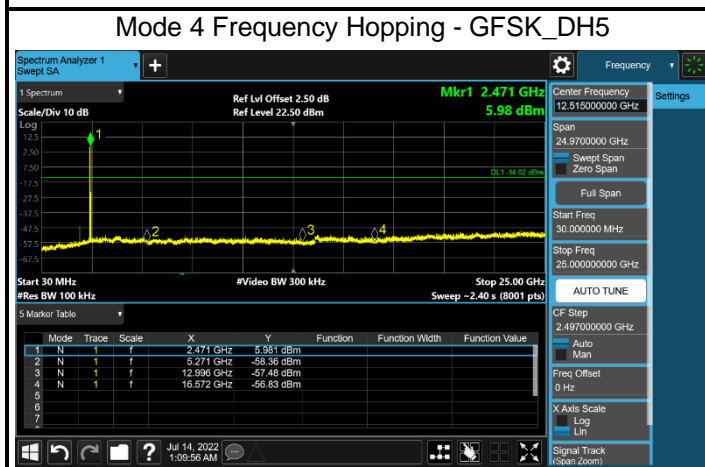
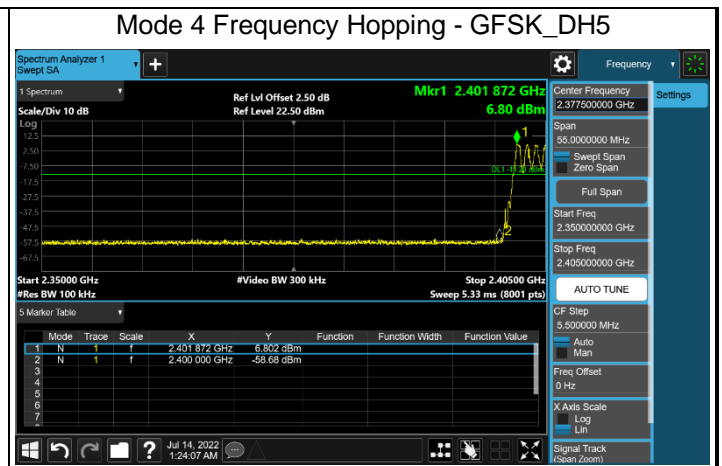
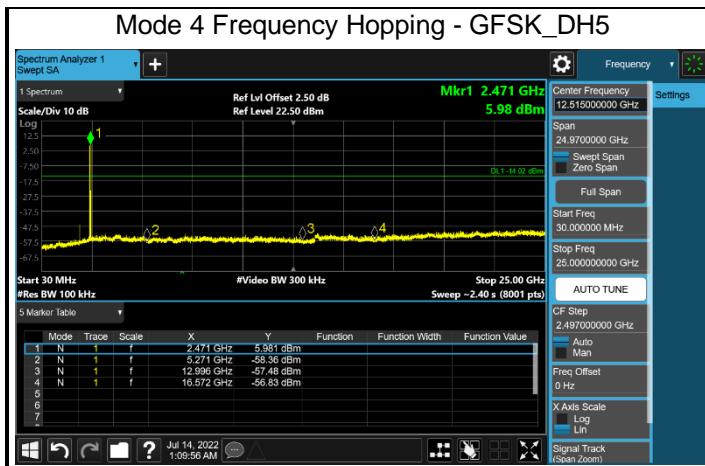

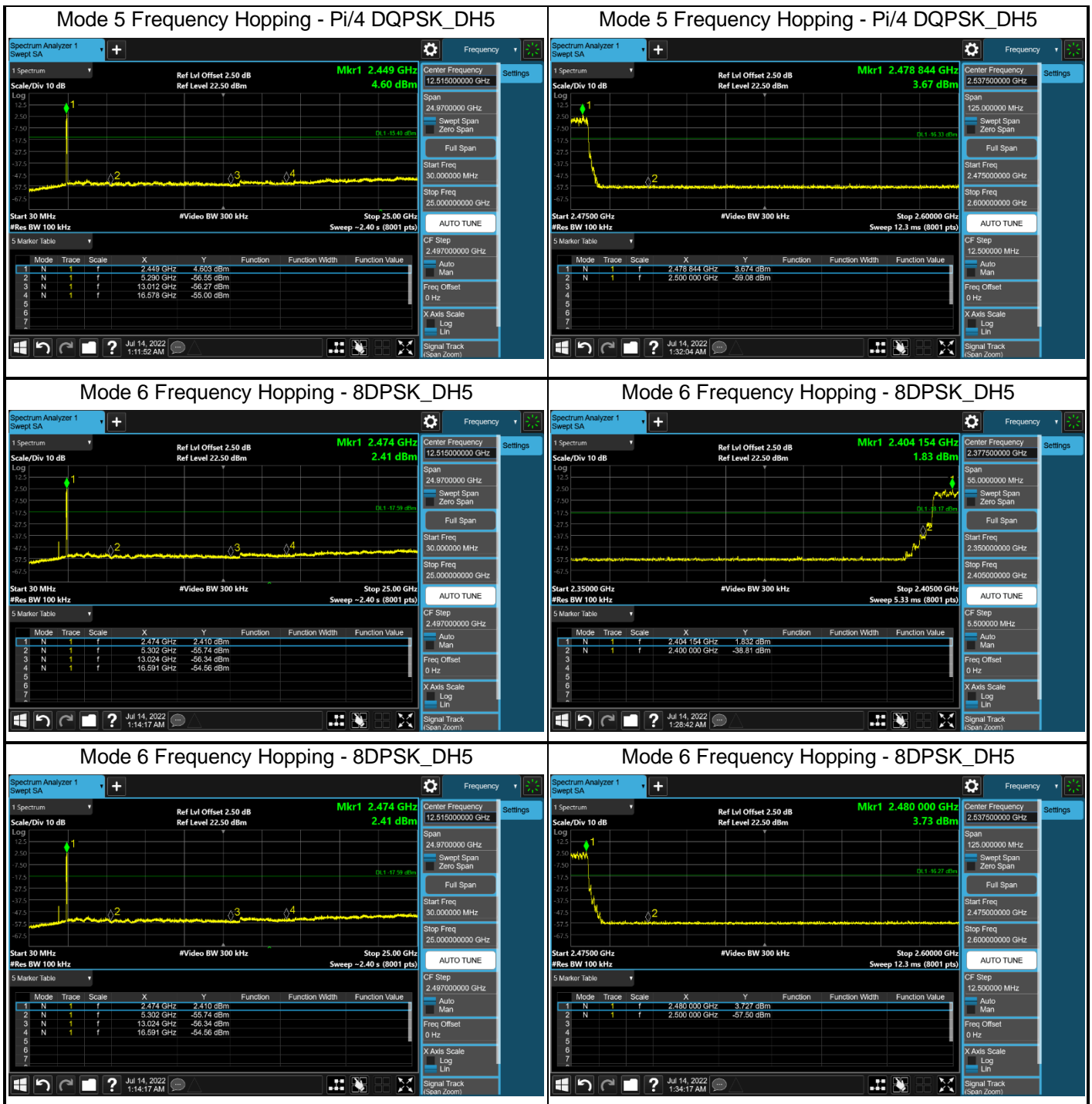

4.9 Duty cycle

VERDICT: PASS

4.9.1 Limit

N/A

4.9.2 Test Setup

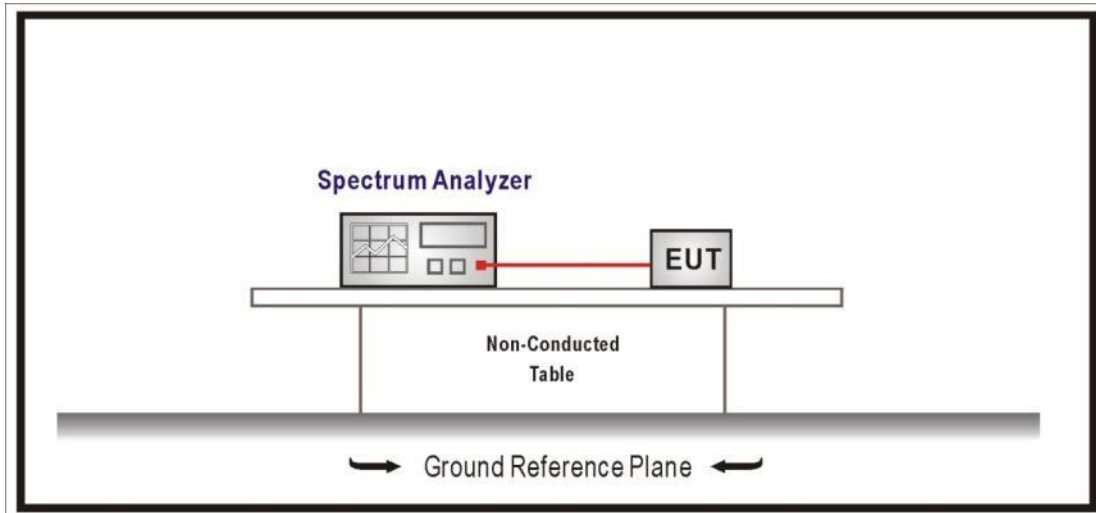

4.9.3 Test Procedure

References Rule	Chapter	Description
<input checked="" type="checkbox"/> ANSI C63.10	11.6	Duty cycle (D), transmission duration (T), and maximum power control level

4.9.4 Test Data

Test Mode	Tx On (ms)	Tx Off (ms)	VBW (kHz)	Tx On + Tx Off (ms)	Duty Cycle (%)
Mode 1	2.879	0.872	0.35	3.751	76.75
Mode 2	2.870	0.881	0.35	3.751	77.51
Mode 3	2.879	0.863	0.35	3.742	76.94

Note 1: T means the minimum transmission duration over which the transmitter is on and is transmitting at its maximum power control level for the tested mode of operation.

Note 2: According to KDB 558074, when test for Radiated Emission Band Edge and Radiated Emission, for average detector set: $VBW \geq 1/T$ will be used.

Mode 1 CH39 2441MHz

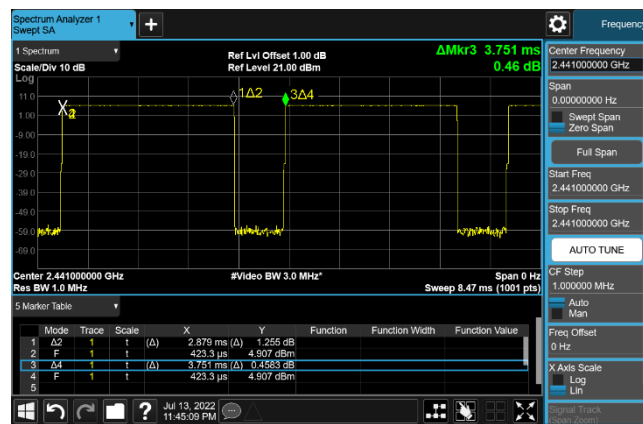

Mode 2 CH39 2441MHz

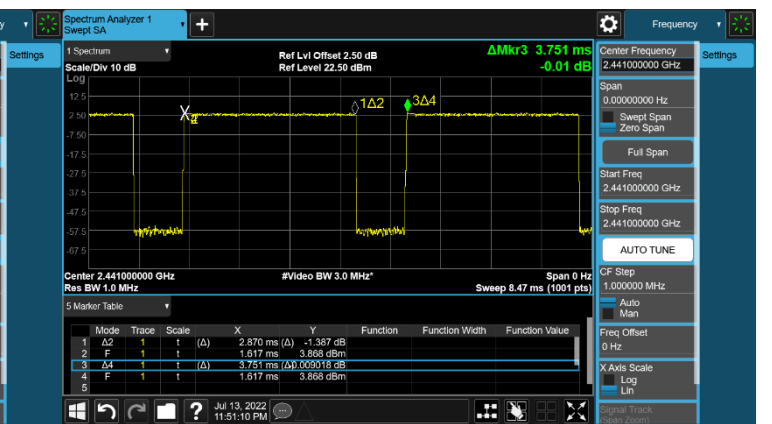

Mode 3 CH39 2441MHz

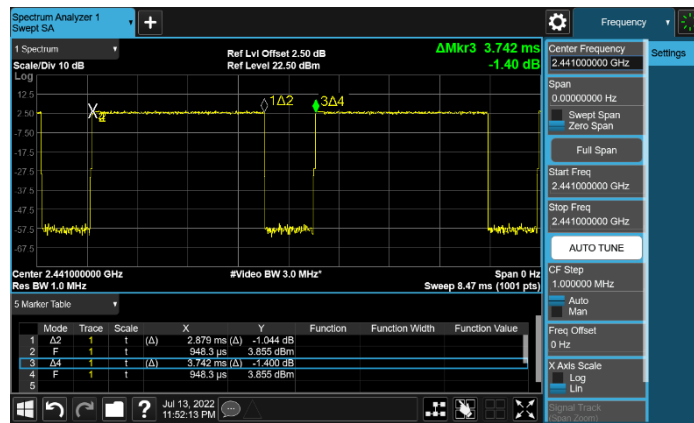

4.10 Band Edge

VERDICT: PASS

4.10.1 Limit

Standard		FCC Part 15 Subpart C Paragraph 15.247(d) ,15.209		
Frequency bands (MHz)	Detector	Limit (dB μ V/m)	RBW (MHz)	Distance (m)
2310-2390	PK	74	1	3
2483.5-2500	AV	54	1	3

Note: The field strength of emissions appearing within these frequency bands shall not exceed the limits.

4.10.2 Test Setup

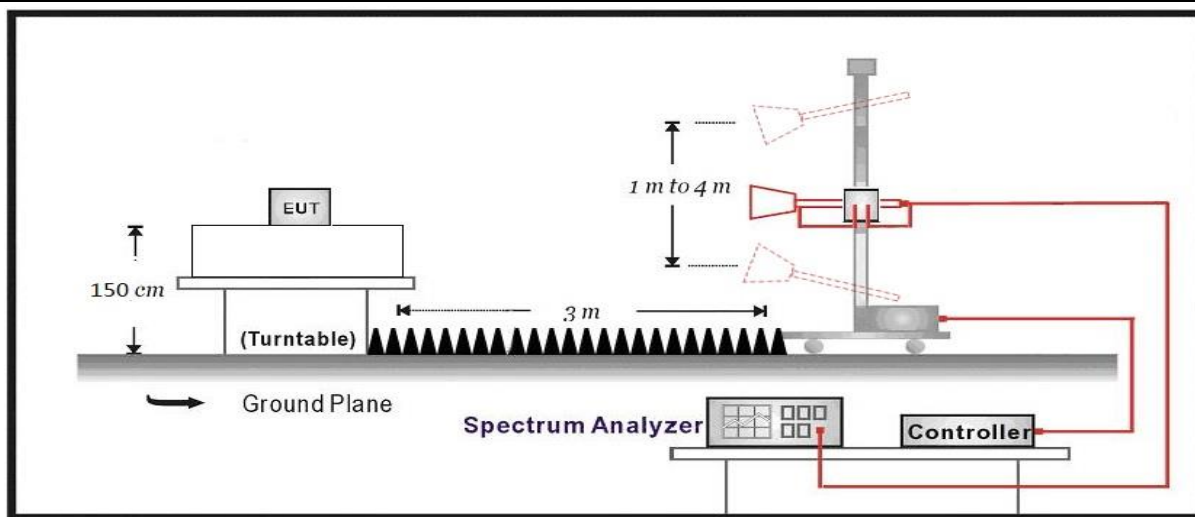

4.10.3 Test Procedure

Test Method

	References Rule	Chapter	Description
<input type="checkbox"/>	DA 00-705	N/A	duty cycle correction factor
<input checked="" type="checkbox"/>	ANSI C63.10	6.10	Band-edge testing
<input checked="" type="checkbox"/>	ANSI C63.10	6.10.5	Restricted-band band-edge measurements
<input type="checkbox"/>	ANSI C63.10	6.10.6	Marker-delta method
<input type="checkbox"/>	ANSI C63.10	6.4	Radiated emissions from unlicensed wireless devices below 30 MHz
<input type="checkbox"/>	ANSI C63.10	6.5	Radiated emissions from unlicensed wireless devices in the frequency range of 30 MHz to 1000 MHz
<input type="checkbox"/>	ANSI C63.10	6.6	Radiated emissions from unlicensed wireless devices above 1 GHz

4.10.4 Test Data

Profile: 2260325R	Page No.: 2
Engineer: Carlosshen	
Site: AC5	Time: 2022/07/02 - 23:02
Limit: FCC_Part15.209_RE(3m)	Margin: 0
Probe: Horn_3117_00167055(1-18GHz)	Polarity: Horizontal
EUT: LBEE5HY2DU	Power: DC 3.6V
Note: Mode 1:Transmit at 2402MHz by DH5	

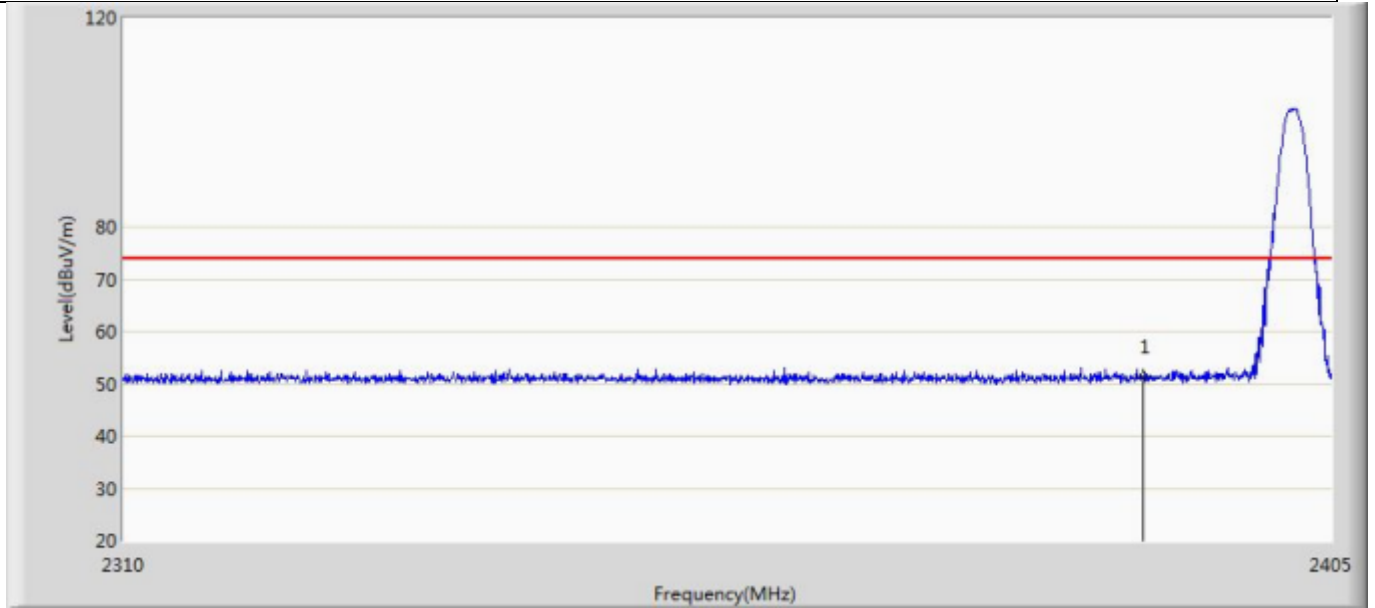

No	Mark	Frequency (MHz)	Measure Level (dBuV/m)	Reading Level (dBuV)	Over Limit (dB)	Limit (dBuV/m)	Factor (dB)	Type
1	*	2390.000	51.278	15.180	-22.722	74.000	36.098	PK

Profile: 2260325R	Page No.: 1
Engineer: Carlosshen	
Site: AC5	Time: 2022/07/02 - 22:31
Limit: FCC_Part15.209_RE(3m)	Margin: 0
Probe: Horn_3117_00167055(1-18GHz)	Polarity: Horizontal
EUT: LBEE5HY2DU	Power: DC 3.6V
Note: Mode 1:Transmit at 2402MHz by DH5	

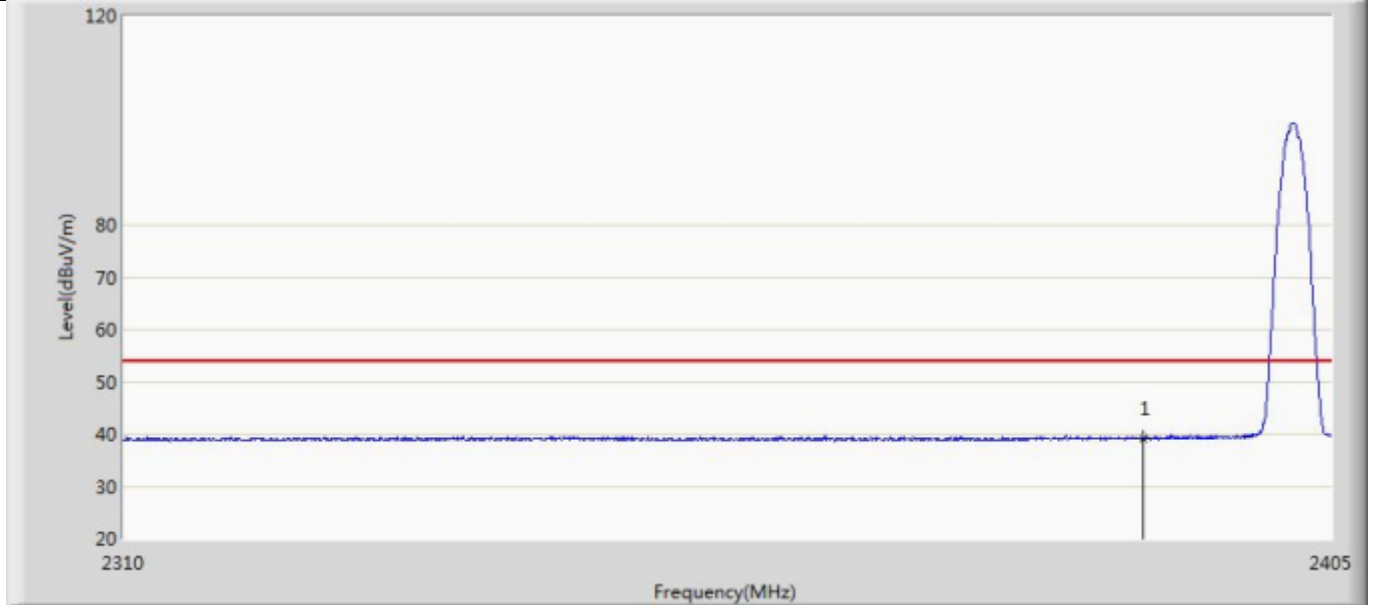

No	Mark	Frequency (MHz)	Measure Level (dBuV/m)	Reading Level (dBuV)	Over Limit (dB)	Limit (dBuV/m)	Factor (dB)	Type
1	*	2390.000	39.253	3.155	-14.747	54.000	36.098	AV

Profile: 2260325R	Page No.: 4
Engineer: Carlosshen	
Site: AC5	Time: 2022/07/02 - 23:04
Limit: FCC_Part15.209_RE(3m)	Margin: 0
Probe: Horn_3117_00167055(1-18GHz)	Polarity: Vertical
EUT: LBEE5HY2DU	Power: DC 3.6V
Note: Mode 1:Transmit at 2402MHz by DH5	

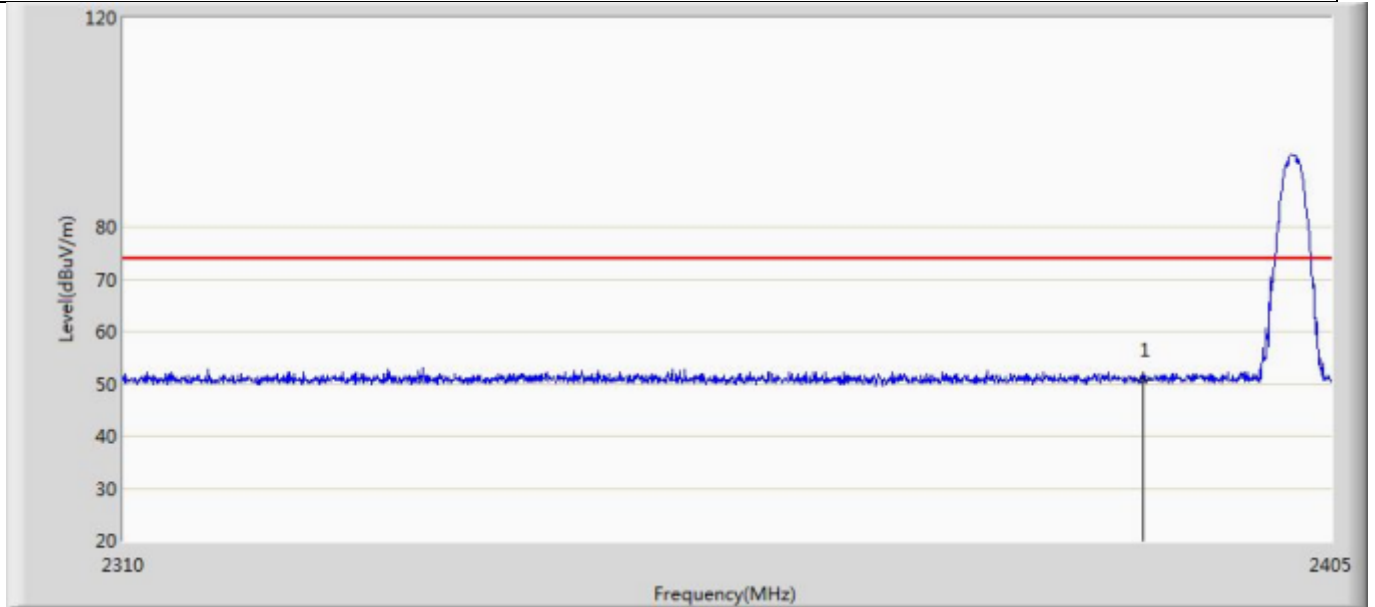

No	Mark	Frequency (MHz)	Measure Level (dBuV/m)	Reading Level (dBuV)	Over Limit (dB)	Limit (dBuV/m)	Factor (dB)	Type
1	*	2390.000	50.752	14.654	-23.248	74.000	36.098	PK

Profile: 2260325R	Page No.: 3
Engineer: Carlosshen	
Site: AC5	Time: 2022/07/02 - 23:03
Limit: FCC_Part15.209_RE(3m)	Margin: 0
Probe: Horn_3117_00167055(1-18GHz)	Polarity: Vertical
EUT: LBEE5HY2DU	Power: DC 3.6V
Note: Mode 1:Transmit at 2402MHz by DH5	

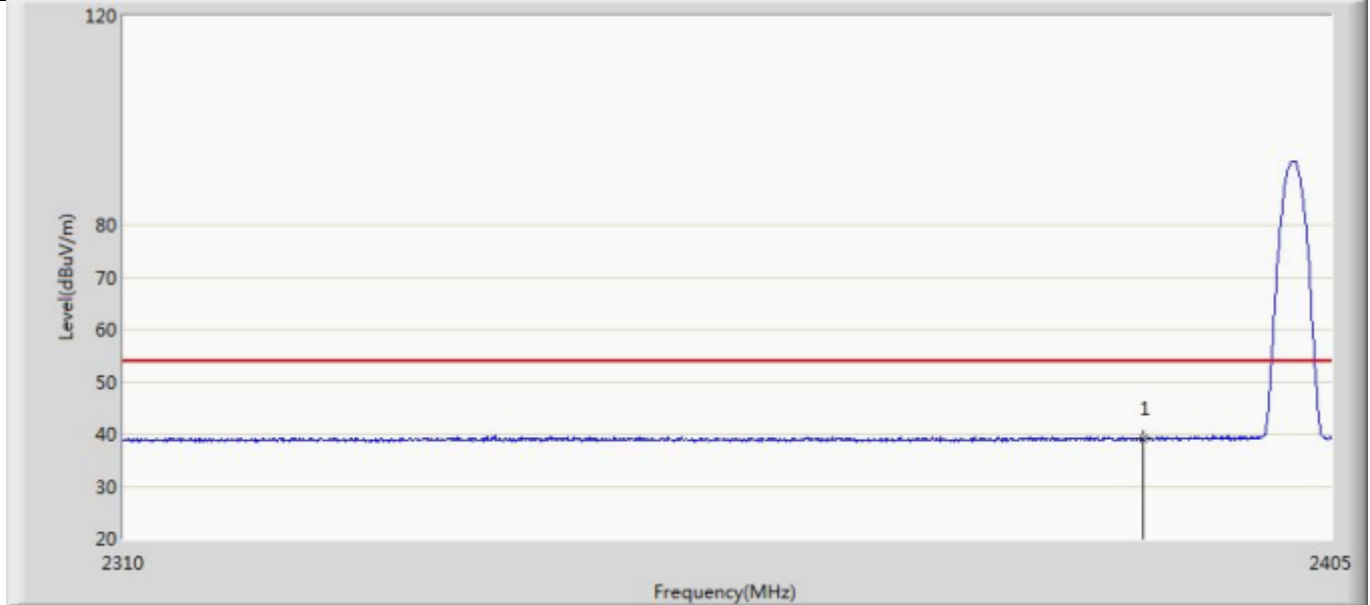

No	Mark	Frequency (MHz)	Measure Level (dBuV/m)	Reading Level (dBuV)	Over Limit (dB)	Limit (dBuV/m)	Factor (dB)	Type
1	*	2390.000	39.129	3.031	-14.871	54.000	36.098	AV

Profile: 2260325R	Page No.: 6
Engineer: Carlosshen	
Site: AC5	Time: 2022/07/02 - 20:37
Limit: FCC_Part15.209_RE(3m)	Margin: 0
Probe: Horn_3117_00167055(1-18GHz)	Polarity: Horizontal
EUT: LBEE5HY2DU	Power: DC 3.6V
Note: Mode 1:Transmit at 2480MHz by DH5	

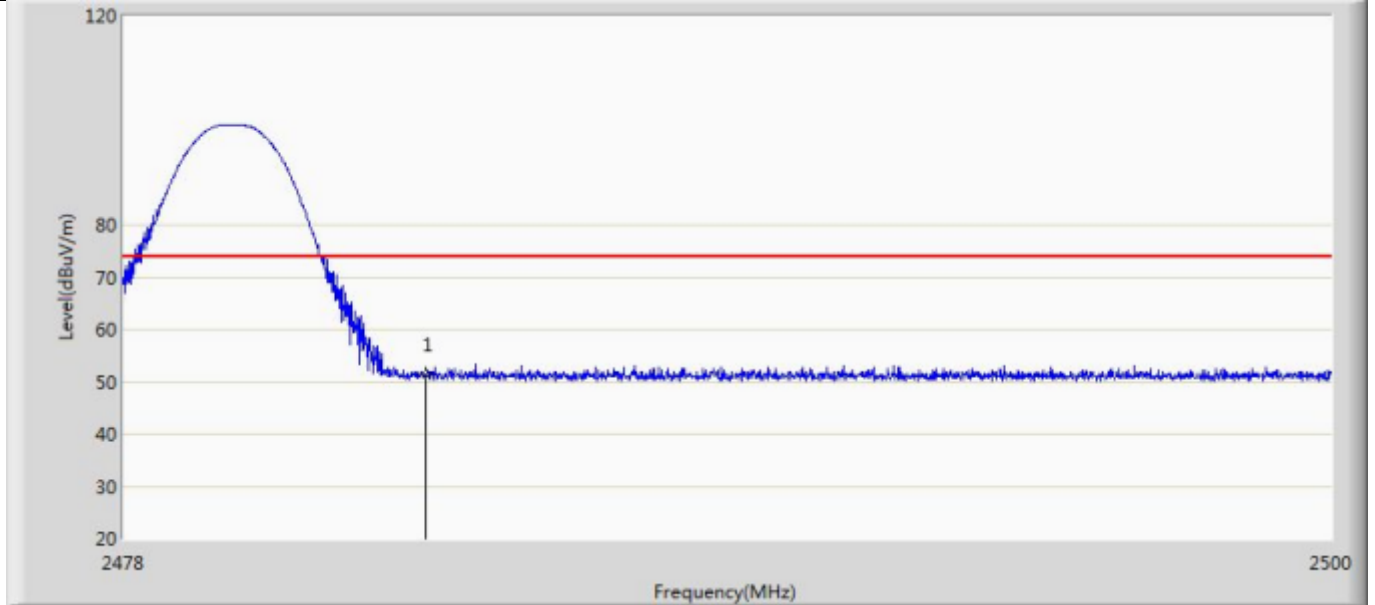

No	Mark	Frequency (MHz)	Measure Level (dBuV/m)	Reading Level (dBuV)	Over Limit (dB)	Limit (dBuV/m)	Factor (dB)	Type
1	*	2483.500	51.246	15.025	-22.754	74.000	36.220	PK

Profile: 2260325R	Page No.: 5
Engineer: Carlosshen	
Site: AC5	Time: 2022/07/02 - 20:34
Limit: FCC_Part15.209_RE(3m)	Margin: 0
Probe: Horn_3117_00167055(1-18GHz)	Polarity: Horizontal
EUT: LBEE5HY2DU	Power: DC 3.6V
Note: Mode 1:Transmit at 2480MHz by DH5	

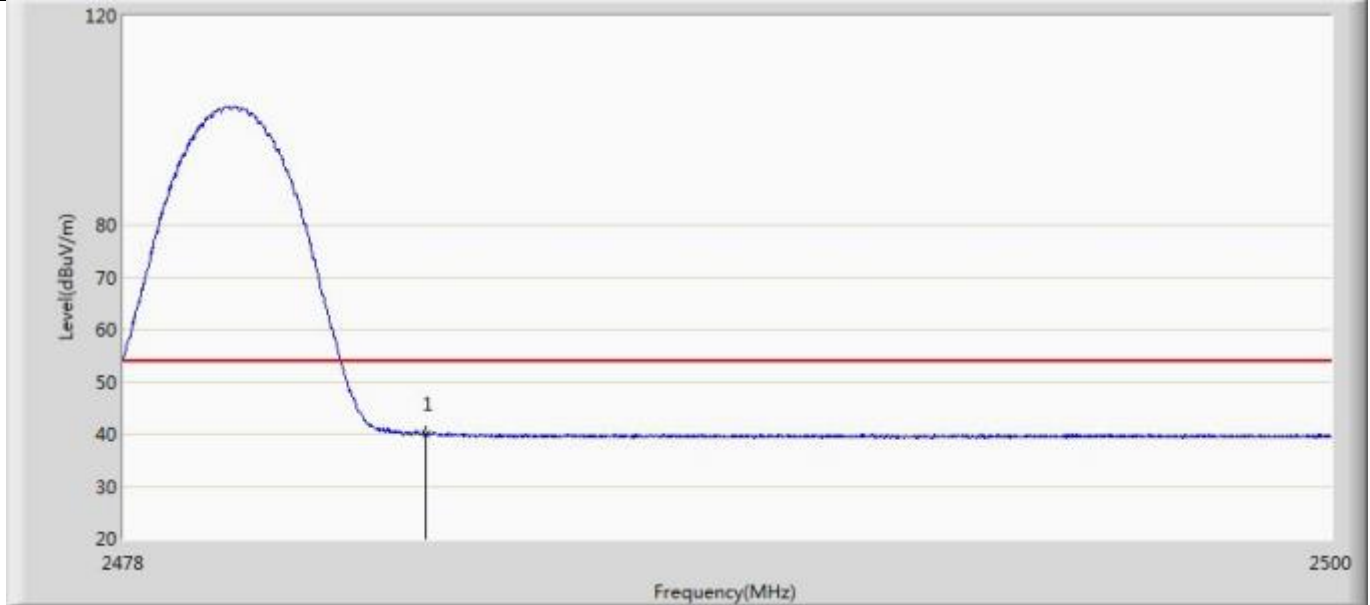

No	Mark	Frequency (MHz)	Measure Level (dBuV/m)	Reading Level (dBuV)	Over Limit (dB)	Limit (dBuV/m)	Factor (dB)	Type
1	*	2483.500	40.045	3.824	-13.955	54.000	36.220	AV

Profile: 2260325R	Page No.: 8
Engineer: Carlosshen	
Site: AC5	Time: 2022/07/02 - 20:39
Limit: FCC_Part15.209_RE(3m)	Margin: 0
Probe: Horn_3117_00167055(1-18GHz)	Polarity: Vertical
EUT: LBEE5HY2DU	Power: DC 3.6V
Note: Mode 1:Transmit at 2480MHz by DH5	

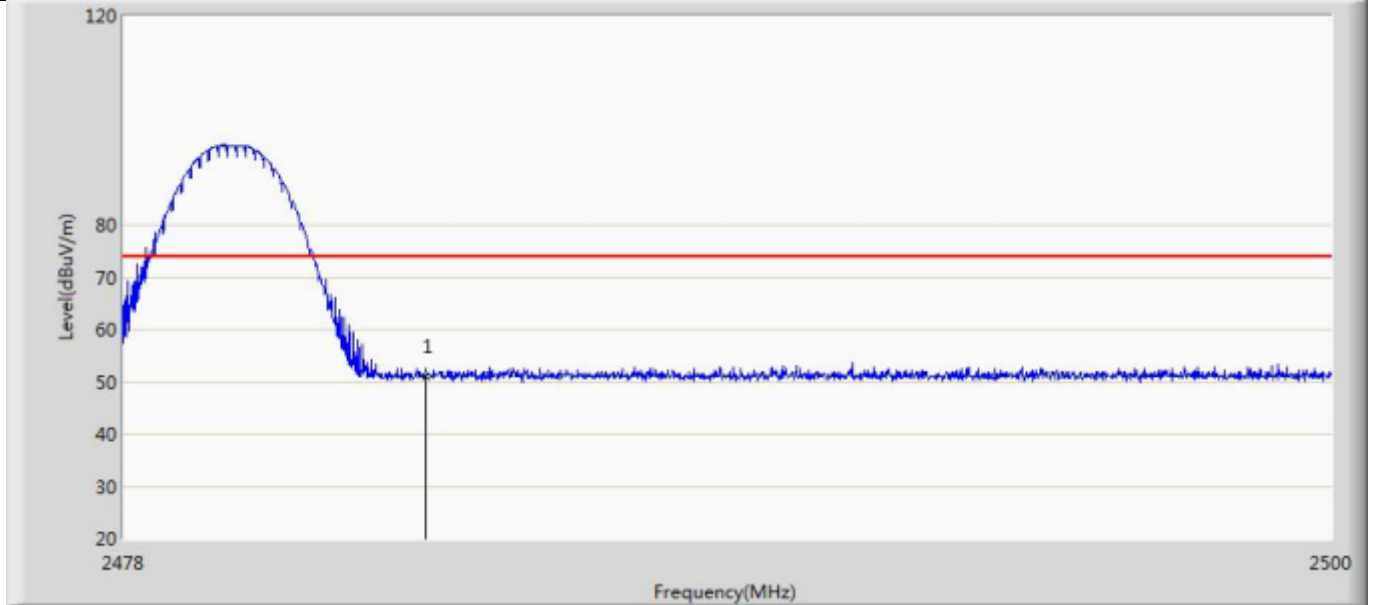

No	Mark	Frequency (MHz)	Measure Level (dBuV/m)	Reading Level (dBuV)	Over Limit (dB)	Limit (dBuV/m)	Factor (dB)	Type
1	*	2483.500	51.146	14.925	-22.854	74.000	36.220	PK

Profile: 2260325R	Page No.: 7
Engineer: Carlosshen	
Site: AC5	Time: 2022/07/02 - 20:38
Limit: FCC_Part15.209_RE(3m)	Margin: 0
Probe: Horn_3117_00167055(1-18GHz)	Polarity: Vertical
EUT: LBEE5HY2DU	Power: DC 3.6V
Note: Mode 1:Transmit at 2480MHz by DH5	

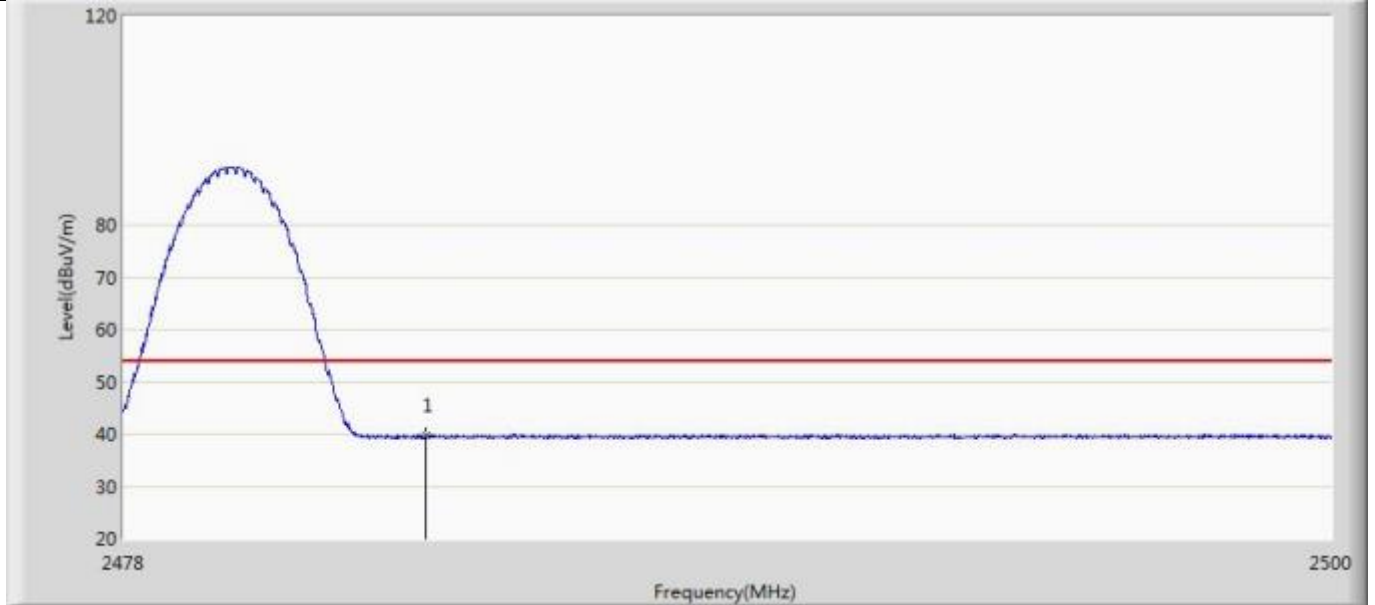

No	Mark	Frequency (MHz)	Measure Level (dBuV/m)	Reading Level (dBuV)	Over Limit (dB)	Limit (dBuV/m)	Factor (dB)	Type
1	*	2483.500	39.591	3.370	-14.409	54.000	36.220	AV

Profile: 2260325R	Page No.: 10
Engineer: Carlosshen	
Site: AC5	Time: 2022/07/02 - 21:09
Limit: FCC_Part15.209_RE(3m)	Margin: 0
Probe: Horn_3117_00167055(1-18GHz)	Polarity: Horizontal
EUT: LBEE5HY2DU	Power: DC 3.6V
Note: Mode 2:Transmit at 2402MHz by 2DH5	

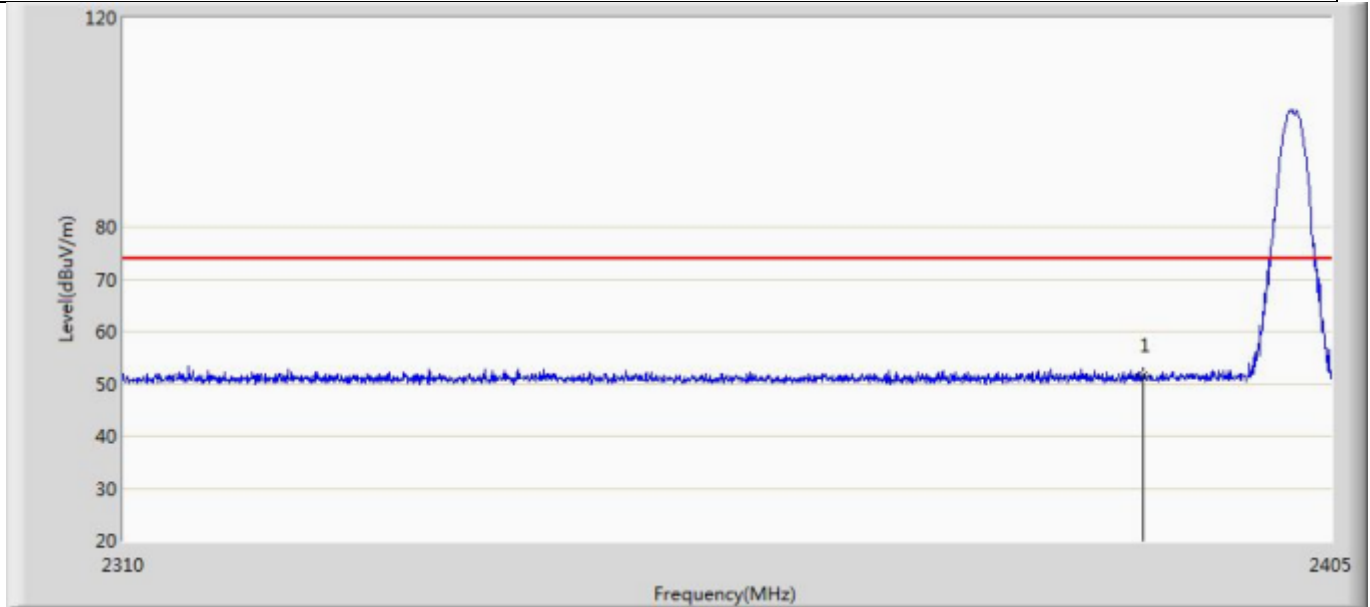

No	Mark	Frequency (MHz)	Measure Level (dBuV/m)	Reading Level (dBuV)	Over Limit (dB)	Limit (dBuV/m)	Factor (dB)	Type
1	*	2390.000	51.466	15.368	-22.534	74.000	36.098	PK

Profile: 2260325R	Page No.: 9
Engineer: Carlosshen	
Site: AC5	Time: 2022/07/02 - 21:09
Limit: FCC_Part15.209_RE(3m)	Margin: 0
Probe: Horn_3117_00167055(1-18GHz)	Polarity: Horizontal
EUT: LBEE5HY2DU	Power: DC 3.6V
Note: Mode 1:Transmit at 2402MHz by 2DH5	

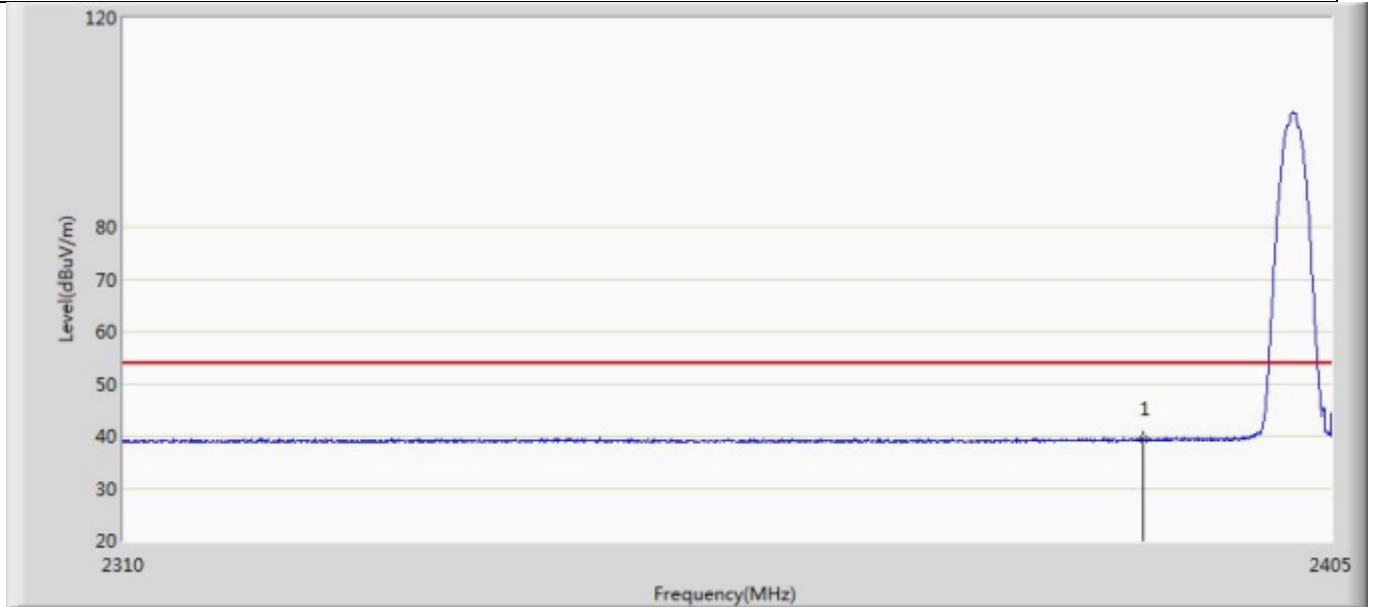

No	Mark	Frequency (MHz)	Measure Level (dBuV/m)	Reading Level (dBuV)	Over Limit (dB)	Limit (dBuV/m)	Factor (dB)	Type
1	*	2390.000	39.457	3.359	-14.543	54.000	36.098	AV

Profile: 2260325R	Page No.: 12
Engineer: Carlosshen	
Site: AC5	Time: 2022/07/02 - 21:09
Limit: FCC_Part15.209_RE(3m)	Margin: 0
Probe: Horn_3117_00167055(1-18GHz)	Polarity: Vertical
EUT: LBEE5HY2DU	Power: DC 3.6V
Note: Mode 2:Transmit at 2402MHz by 2DH5	

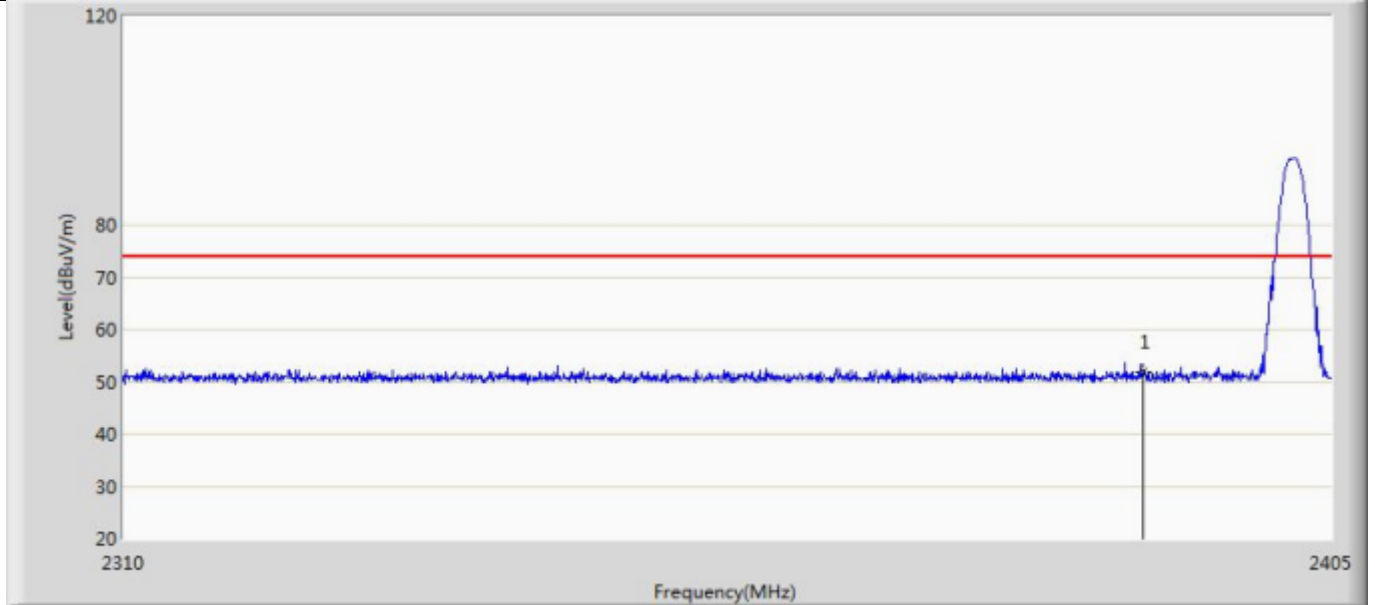

No	Mark	Frequency (MHz)	Measure Level (dBuV/m)	Reading Level (dBuV)	Over Limit (dB)	Limit (dBuV/m)	Factor (dB)	Type
1	*	2390.000	51.898	15.800	-22.102	74.000	36.098	PK

Profile: 2260325R	Page No.: 11
Engineer: Carlosshen	
Site: AC5	Time: 2022/07/02 - 21:09
Limit: FCC_Part15.209_RE(3m)	Margin: 0
Probe: Horn_3117_00167055(1-18GHz)	Polarity: Vertical
EUT: LBEE5HY2DU	Power: DC 3.6V
Note: Mode 2:Transmit at 2402MHz by 2DH5	

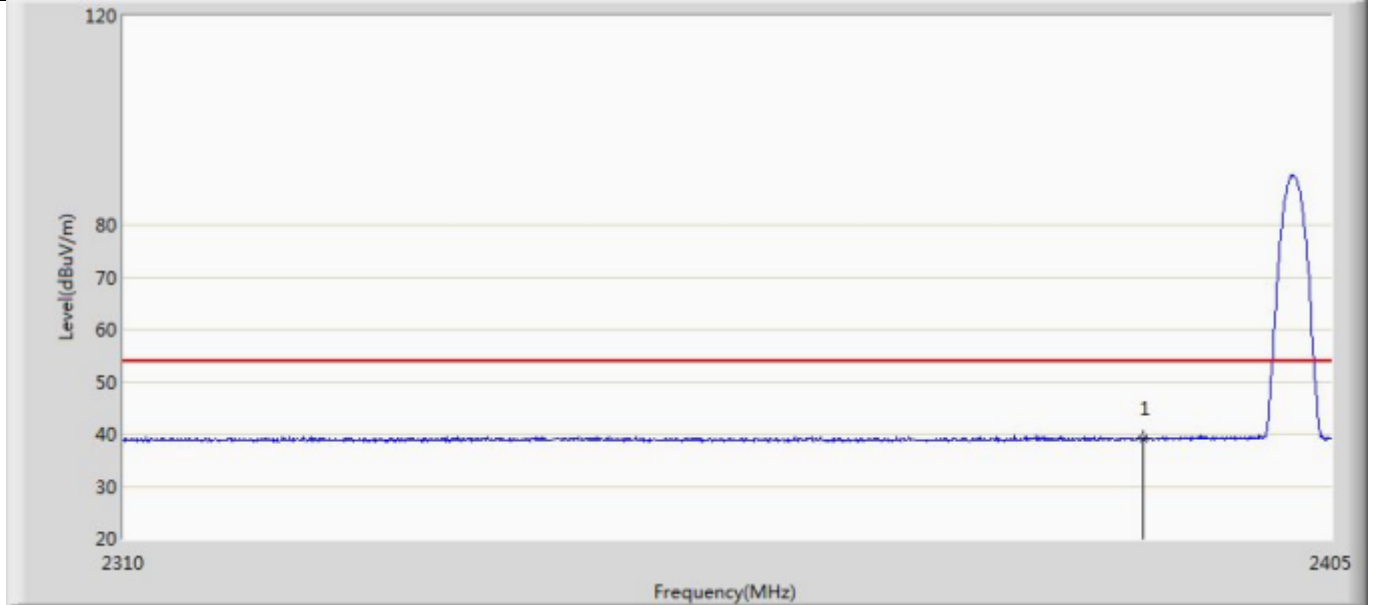

No	Mark	Frequency (MHz)	Measure Level (dBuV/m)	Reading Level (dBuV)	Over Limit (dB)	Limit (dBuV/m)	Factor (dB)	Type
1	*	2390.000	39.015	2.917	-14.985	54.000	36.098	AV

Profile: 2260325R	Page No.: 14
Engineer: Carlosshen	
Site: AC5	Time: 2022/07/02 - 21:10
Limit: FCC_Part15.209_RE(3m)	Margin: 0
Probe: Horn_3117_00167055(1-18GHz)	Polarity: Horizontal
EUT: LBEE5HY2DU	Power: DC 3.6V
Note: Mode 2:Transmit at 2480MHz by 2DH5	

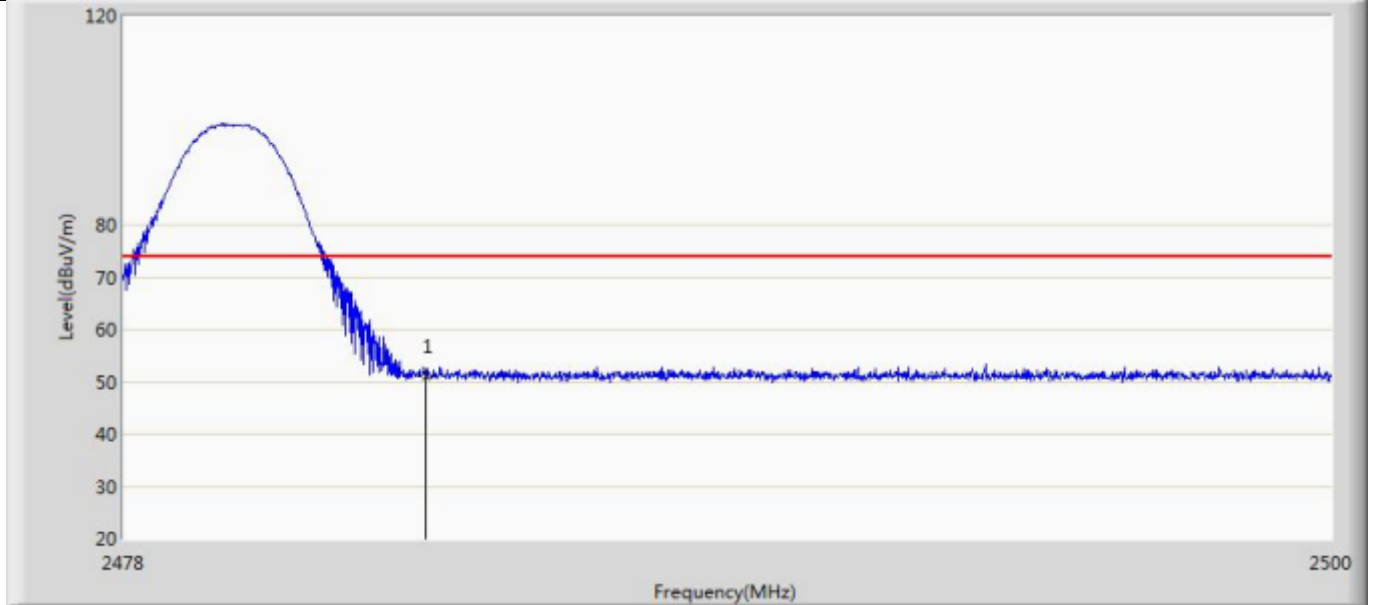

No	Mark	Frequency (MHz)	Measure Level (dBuV/m)	Reading Level (dBuV)	Over Limit (dB)	Limit (dBuV/m)	Factor (dB)	Type
1	*	2483.500	51.000	14.779	-23.000	74.000	36.220	PK

Profile: 2260325R	Page No.: 13
Engineer: Carlosshen	
Site: AC5	Time: 2022/07/02 - 21:10
Limit: FCC_Part15.209_RE(3m)	Margin: 0
Probe: Horn_3117_00167055(1-18GHz)	Polarity: Horizontal
EUT: LBEE5HY2DU	Power: DC 3.6V
Note: Mode 2:Transmit at 2480MHz by 2DH5	

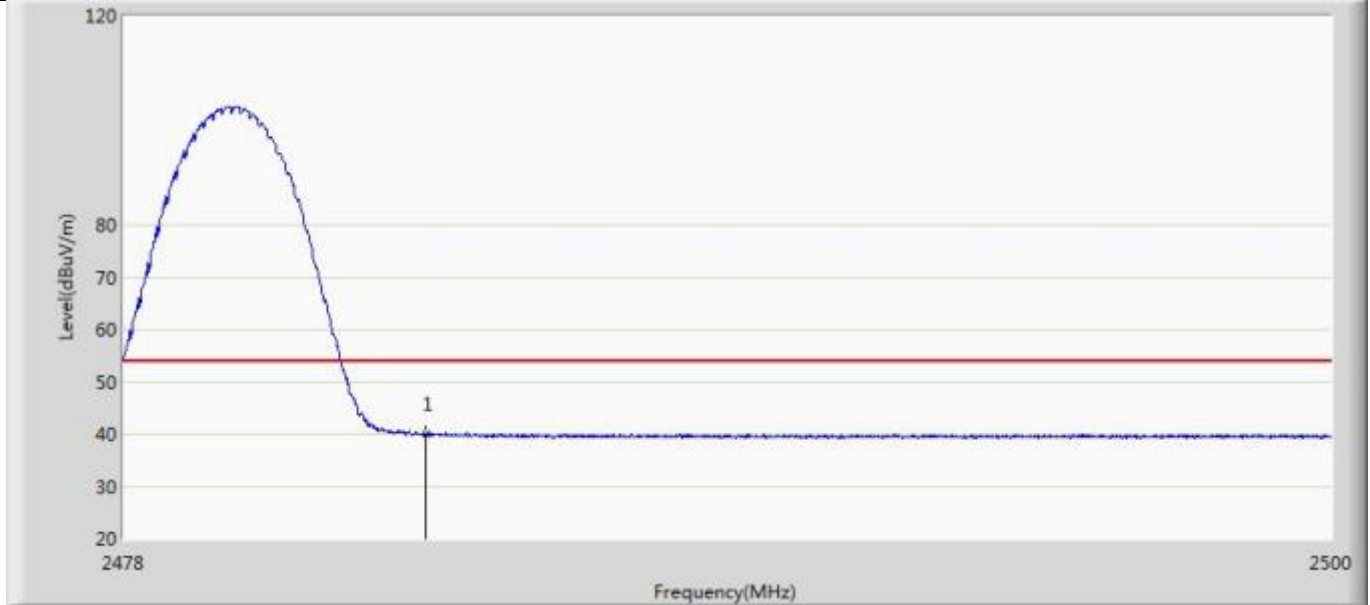

No	Mark	Frequency (MHz)	Measure Level (dBuV/m)	Reading Level (dBuV)	Over Limit (dB)	Limit (dBuV/m)	Factor (dB)	Type
1	*	2483.500	39.905	3.684	-14.095	54.000	36.220	AV

Profile: 2260325R	Page No.: 16
Engineer: Carlosshen	
Site: AC5	Time: 2022/07/02 - 21:10
Limit: FCC_Part15.209_RE(3m)	Margin: 0
Probe: Horn_3117_00167055(1-18GHz)	Polarity: Vertical
EUT: LBEE5HY2DU	Power: DC 3.6V
Note: Mode 2:Transmit at 2480MHz by 2DH5	

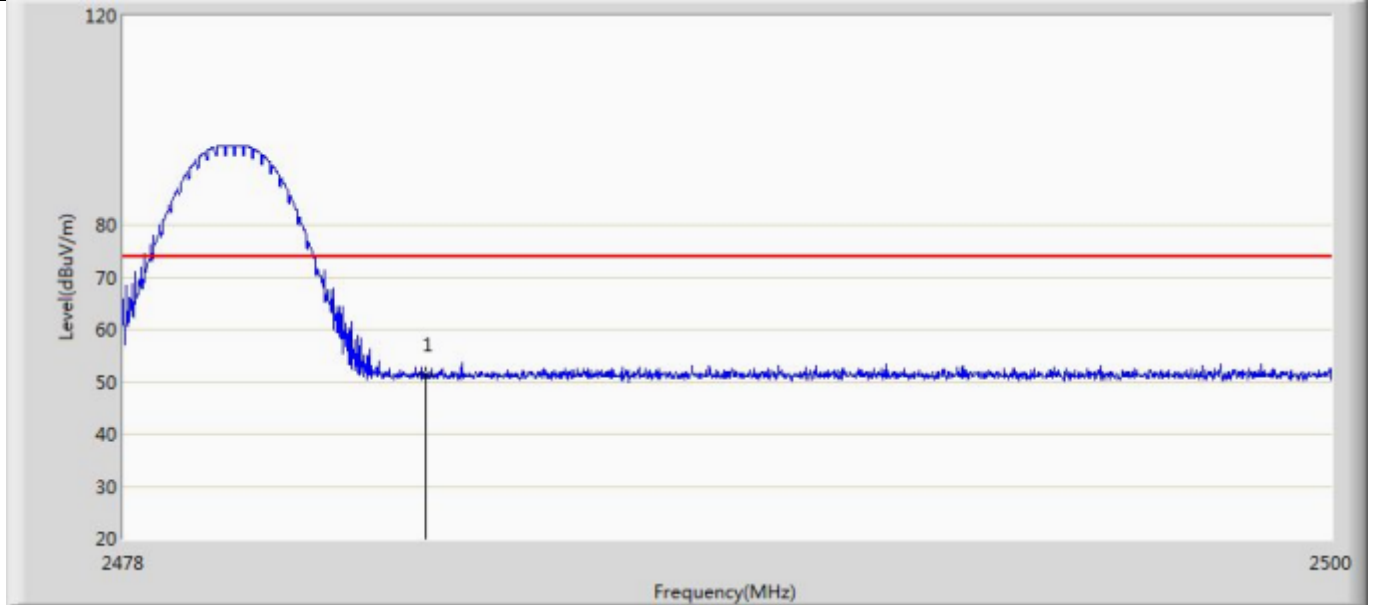

No	Mark	Frequency (MHz)	Measure Level (dBuV/m)	Reading Level (dBuV)	Over Limit (dB)	Limit (dBuV/m)	Factor (dB)	Type
1	*	2483.500	51.204	14.983	-22.796	74.000	36.220	PK

Profile: 2260325R	Page No.: 15
Engineer: Carlosshen	
Site: AC5	Time: 2022/07/02 - 21:10
Limit: FCC_Part15.209_RE(3m)	Margin: 0
Probe: Horn_3117_00167055(1-18GHz)	Polarity: Vertical
EUT: LBEE5HY2DU	Power: DC 3.6V
Note: Mode 2:Transmit at 2480MHz by 2DH5	

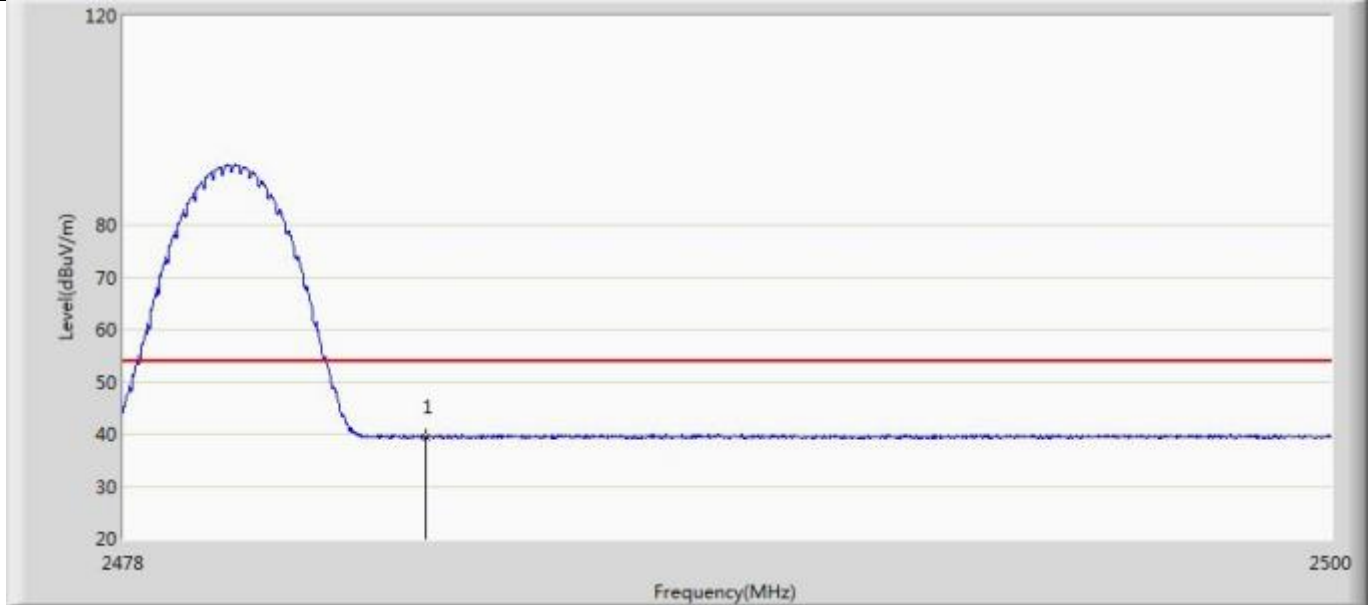

No	Mark	Frequency (MHz)	Measure Level (dBuV/m)	Reading Level (dBuV)	Over Limit (dB)	Limit (dBuV/m)	Factor (dB)	Type
1	*	2483.500	39.407	3.186	-14.593	54.000	36.220	AV

Profile: 2260325R	Page No.: 18
Engineer: Carlosshen	
Site: AC5	Time: 2022/07/03 - 02:37
Limit: FCC_Part15.209_RE(3m)	Margin: 0
Probe: Horn_3117_00167055(1-18GHz)	Polarity: Horizontal
EUT: LBEE5HY2DU	Power: DC 3.6V
Note: Mode 3:Transmit at 2402MHz by 3DH5	

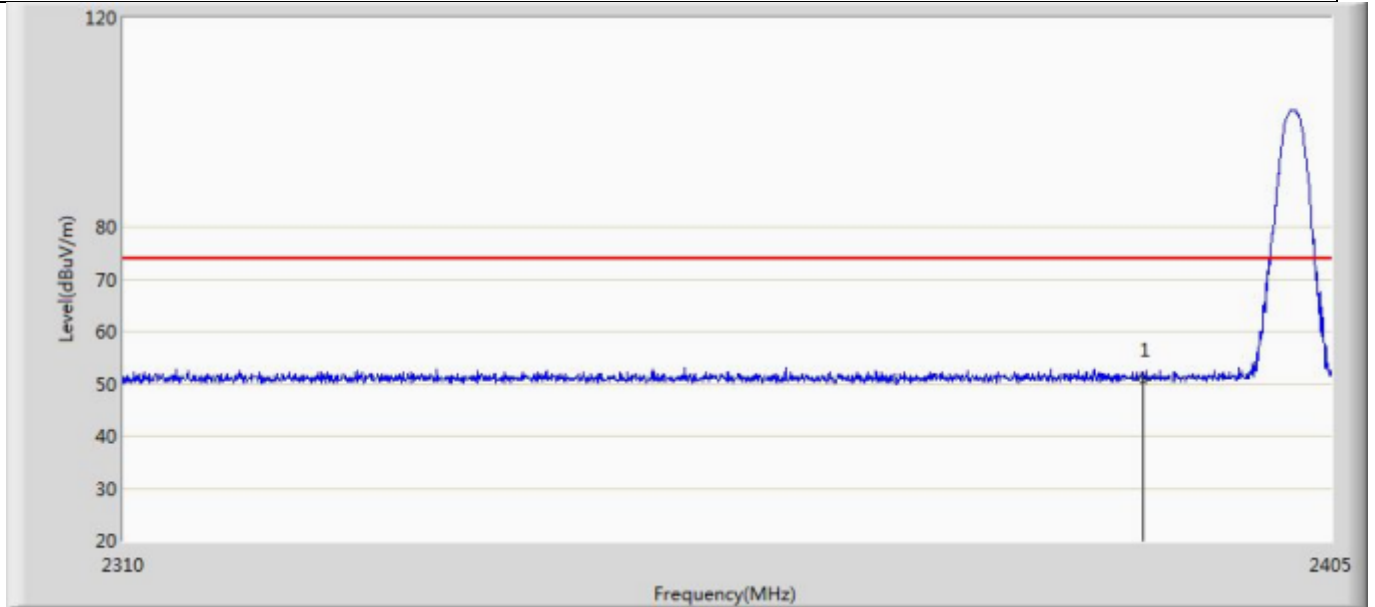

No	Mark	Frequency (MHz)	Measure Level (dBuV/m)	Reading Level (dBuV)	Over Limit (dB)	Limit (dBuV/m)	Factor (dB)	Type
1	*	2390.000	50.822	14.724	-23.178	74.000	36.098	PK

Profile: 2260325R	Page No.: 17
Engineer: Carlosshen	
Site: AC5	Time: 2022/07/03 - 02:37
Limit: FCC_Part15.209_RE(3m)	Margin: 0
Probe: Horn_3117_00167055(1-18GHz)	Polarity: Horizontal
EUT: LBEE5HY2DU	Power: DC 3.6V
Note: Mode 3:Transmit at 2402MHz by 3DH5	

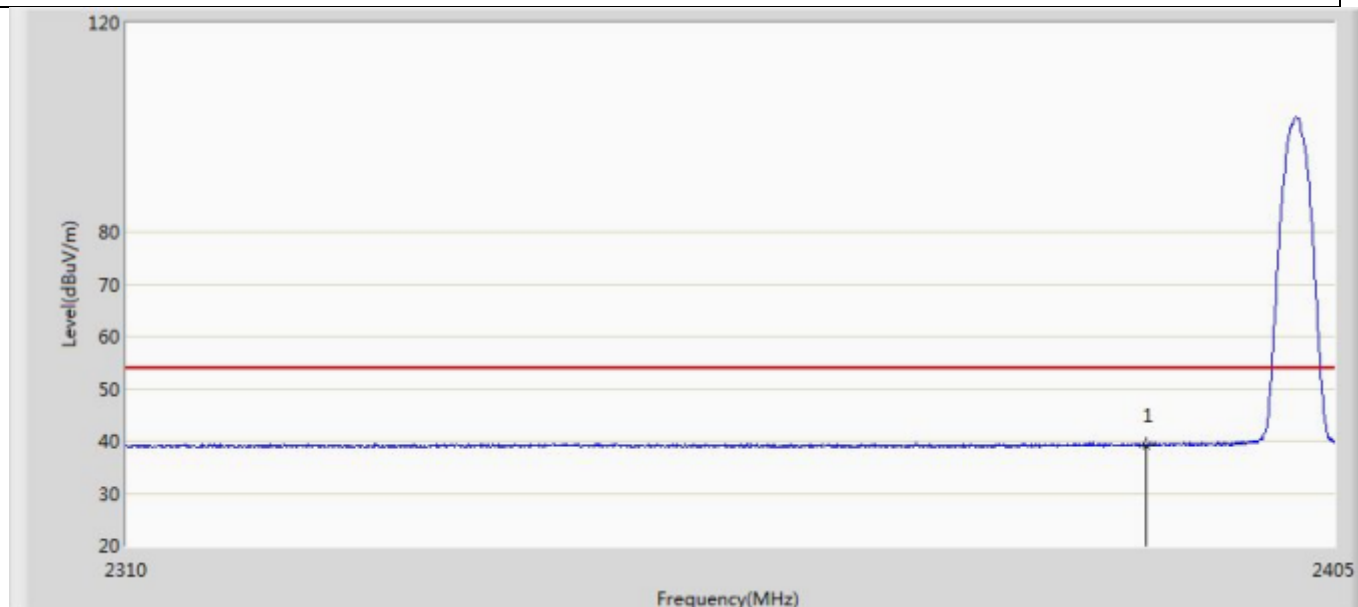

No	Mark	Frequency (MHz)	Measure Level (dBuV/m)	Reading Level (dBuV)	Over Limit (dB)	Limit (dBuV/m)	Factor (dB)	Type
1	*	2390.000	39.145	3.047	-14.855	54.000	36.098	AV

Profile: 2260325R	Page No.: 20
Engineer: Carlosshen	
Site: AC5	Time: 2022/07/03 - 02:37
Limit: FCC_Part15.209_RE(3m)	Margin: 0
Probe: Horn_3117_00167055(1-18GHz)	Polarity: Vertical
EUT: LBEE5HY2DU	Power: DC 3.6V
Note: Mode 3:Transmit at 2402MHz by 3DH5	

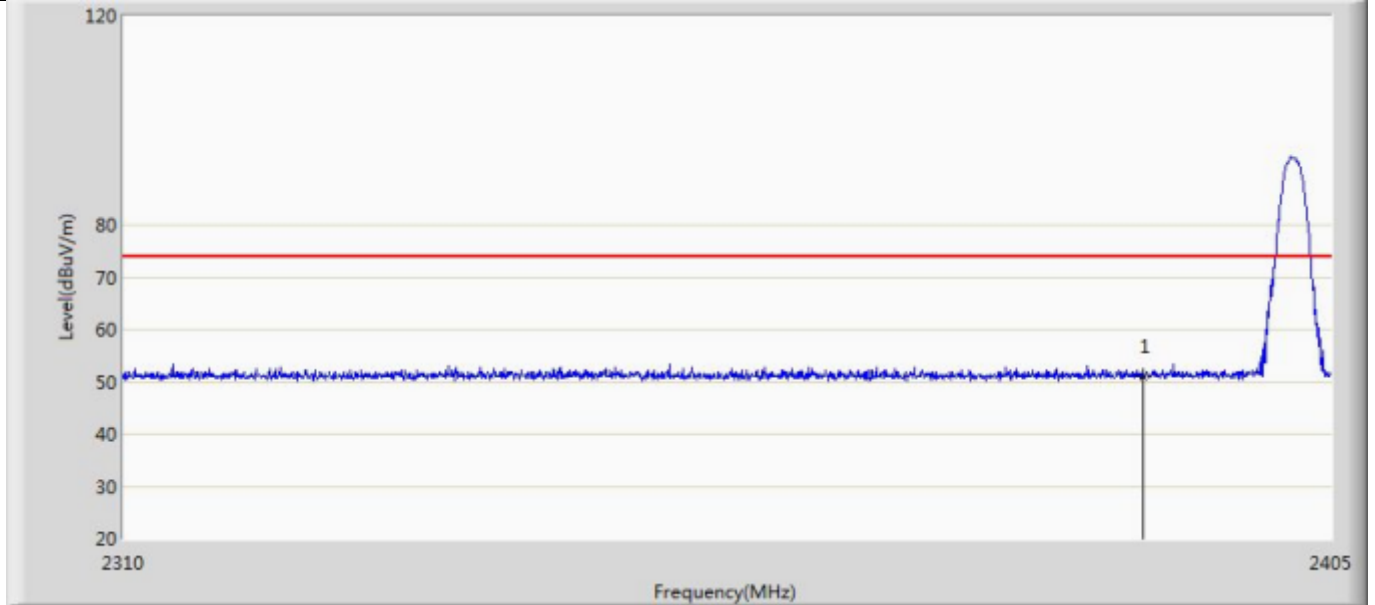

No	Mark	Frequency (MHz)	Measure Level (dBuV/m)	Reading Level (dBuV)	Over Limit (dB)	Limit (dBuV/m)	Factor (dB)	Type
1	*	2390.000	51.111	15.013	-22.889	74.000	36.098	PK

Profile: 2260325R	Page No.: 19
Engineer: Carlosshen	
Site: AC5	Time: 2022/07/03 - 02:37
Limit: FCC_Part15.209_RE(3m)	Margin: 0
Probe: Horn_3117_00167055(1-18GHz)	Polarity: Vertical
EUT: LBEE5HY2DU	Power: DC 3.6V
Note: Mode 3:Transmit at 2402MHz by 3DH5	

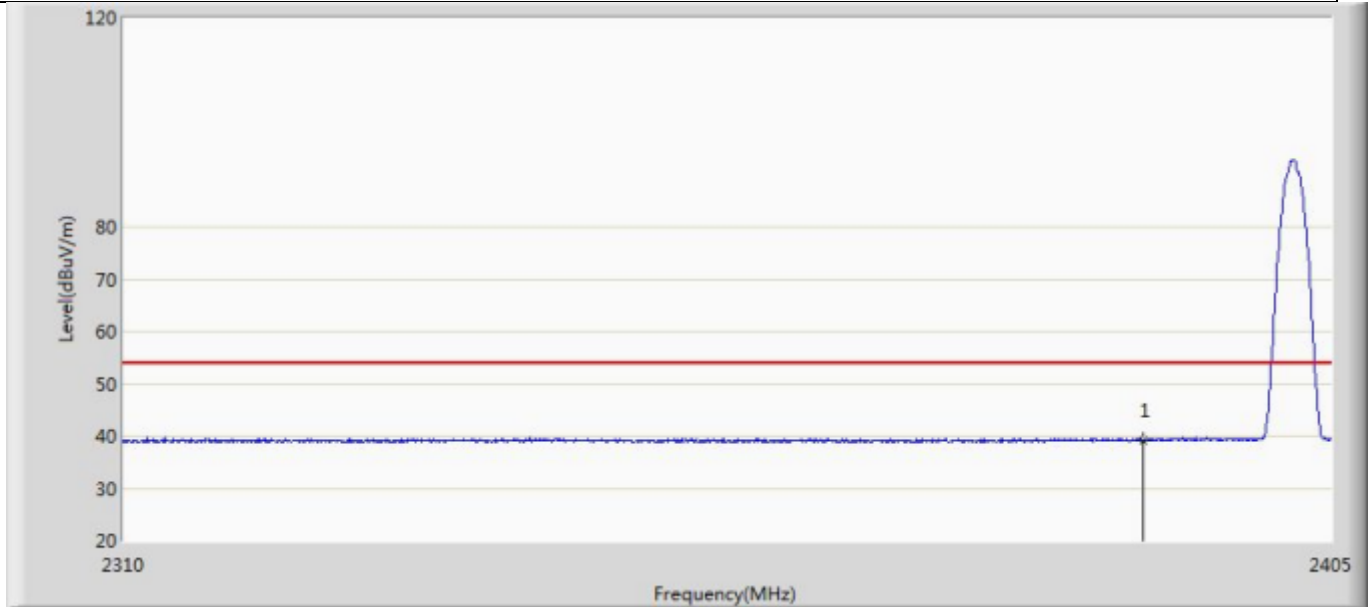

No	Mark	Frequency (MHz)	Measure Level (dBuV/m)	Reading Level (dBuV)	Over Limit (dB)	Limit (dBuV/m)	Factor (dB)	Type
1	*	2390.000	39.191	3.093	-14.809	54.000	36.098	AV

Profile: 2260325R	Page No.: 22
Engineer: Carlosshen	
Site: AC5	Time: 2022/07/03 - 03:06
Limit: FCC_Part15.209_RE(3m)	Margin: 0
Probe: Horn_3117_00167055(1-18GHz)	Polarity: Horizontal
EUT: LBEE5HY2DU	Power: DC 3.6V
Note: Mode 3:Transmit at 2480MHz by 3DH5	

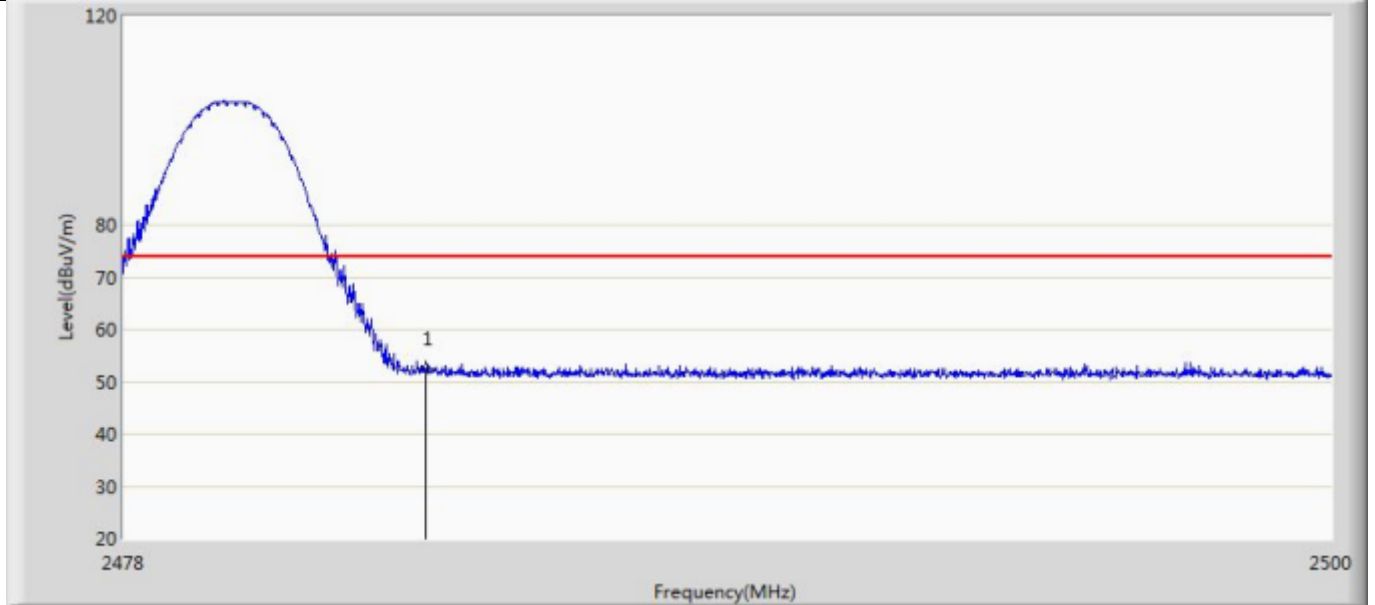

No	Mark	Frequency (MHz)	Measure Level (dBuV/m)	Reading Level (dBuV)	Over Limit (dB)	Limit (dBuV/m)	Factor (dB)	Type
1	*	2483.500	52.332	16.111	-21.668	74.000	36.220	PK

Profile: 2260325R	Page No.: 21
Engineer: Carlosshen	
Site: AC5	Time: 2022/07/03 - 02:37
Limit: FCC_Part15.209_RE(3m)	Margin: 0
Probe: Horn_3117_00167055(1-18GHz)	Polarity: Horizontal
EUT: LBEE5HY2DU	Power: DC 3.6V
Note: Mode 3:Transmit at 2480MHz by 3DH5	

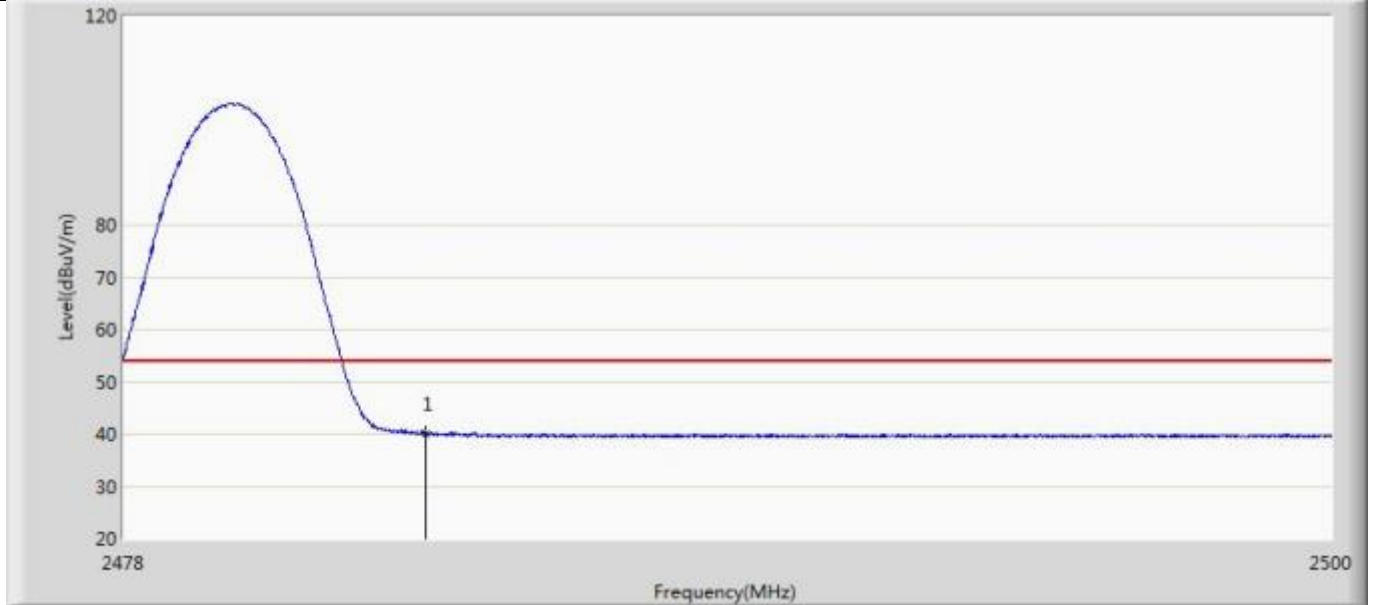

No	Mark	Frequency (MHz)	Measure Level (dBuV/m)	Reading Level (dBuV)	Over Limit (dB)	Limit (dBuV/m)	Factor (dB)	Type
1	*	2483.500	40.053	3.832	-13.947	54.000	36.220	AV

Profile: 2260325R	Page No.: 24
Engineer: Carlosshen	
Site: AC5	Time: 2022/07/03 - 03:07
Limit: FCC_Part15.209_RE(3m)	Margin: 0
Probe: Horn_3117_00167055(1-18GHz)	Polarity: Vertical
EUT: LBEE5HY2DU	Power: DC 3.6V
Note: Mode 3:Transmit at 2480MHz by 3DH5	

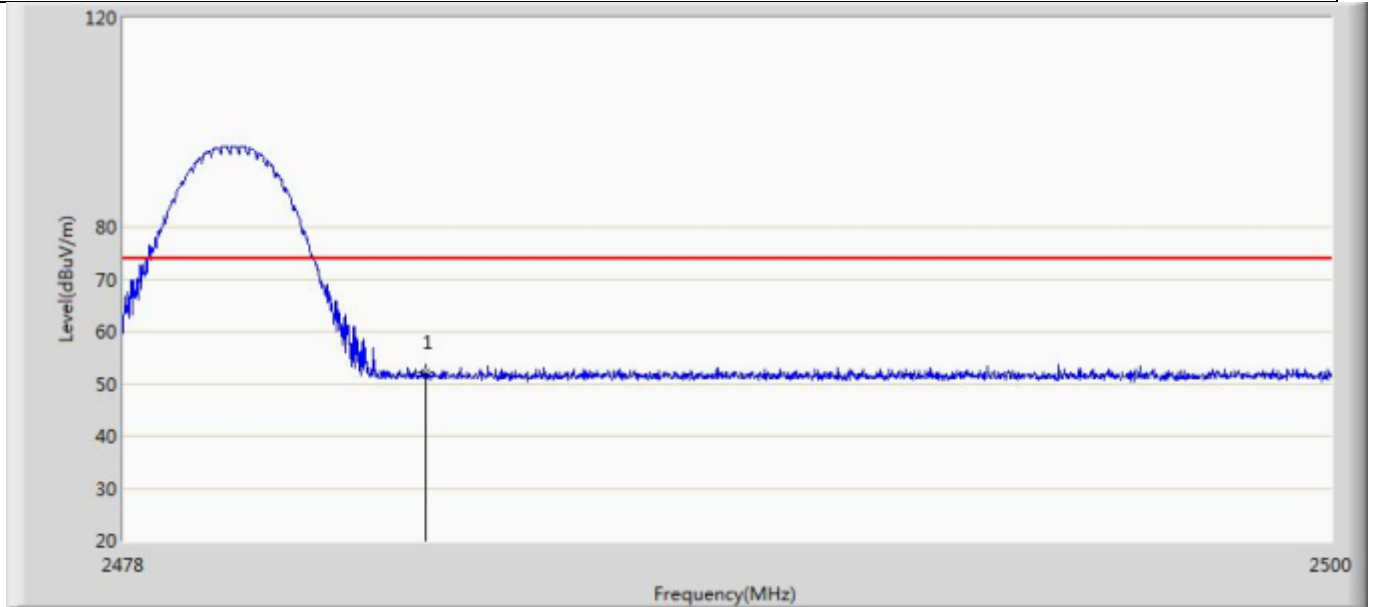

No	Mark	Frequency (MHz)	Measure Level (dBuV/m)	Reading Level (dBuV)	Over Limit (dB)	Limit (dBuV/m)	Factor (dB)	Type
1	*	2483.500	52.129	15.908	-21.871	74.000	36.220	PK

Profile: 2260325R	Page No.: 23
Engineer: Carlosshen	
Site: AC5	Time: 2022/07/03 - 03:06
Limit: FCC_Part15.209_RE(3m)	Margin: 0
Probe: Horn_3117_00167055(1-18GHz)	Polarity: Vertical
EUT: LBEE5HY2DU	Power: DC 3.6V
Note: Mode 3:Transmit at 2480MHz by 3DH5	

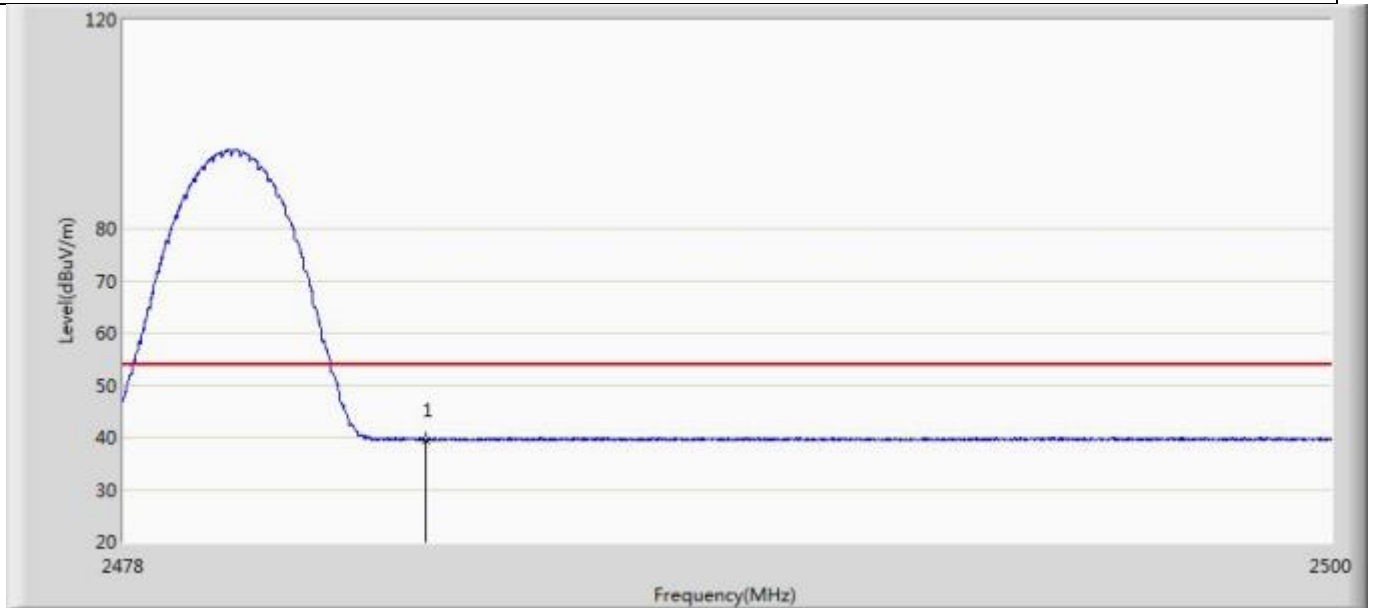

No	Mark	Frequency (MHz)	Measure Level (dBuV/m)	Reading Level (dBuV)	Over Limit (dB)	Limit (dBuV/m)	Factor (dB)	Type
1	*	2483.500	39.559	3.338	-14.441	54.000	36.220	AV

Note:

1. " * ", means this data is the worst emission level.
2. Measurement Level = Reading Level + Factor(Probe+Cable-Amp)

4.11 Antenna Requirement

VERDICT: PASS

4.11.1 Limit:

Standard	FCC Part 15 Subpart C Paragraph 15.203
-----------------	--

An intentional radiator shall be designed to ensure that no antenna other than that furnished by the responsible party shall be used with the device. The use of a permanently attached antenna or of an antenna that uses a unique coupling to the intentional radiator shall be considered sufficient to comply with the provisions of this section. The manufacturer may design the unit so that a broken antenna can be replaced by the user, but the use of a standard antenna jack or electrical connector is prohibited. This requirement does not apply to carrier current devices or to devices operated under the provisions of §15.211, §15.213, §15.217, §15.219, or §15.221. Further, this requirement does not apply to intentional radiators that must be professionally installed, such as perimeter protection systems and some field disturbance sensors, or to other intentional radiators which, in accordance with §15.31(d), must be measured at the installation site. However, the installer shall be responsible for ensuring that the proper antenna is employed so that the limits in this part are not exceeded.

4.11.2 Antenna Connector Construction:

- | | |
|-------------------------------------|--|
| <input type="checkbox"/> | The use of a permanently attached antenna |
| <input type="checkbox"/> | The antenna use of a unique coupling to the intentional radiator |
| <input checked="" type="checkbox"/> | The use of a nonstandard antenna jack or electrical connector |
- Please refer to the attached document "Internal Photograph" to show the antenna connector.

5 TEST SETUP PHOTO AND EUT PHOTO

Remark: The test setup photo and EUT Photo please see appendix.

_____ The End _____