

ELECTROMAGNETIC EMISSIONS COMPLIANCE REPORT

Applicant: Murata Manufacturing Co., Ltd.
10-1, Higashikotari 1-chome, Nagaokakyo-shi, Kyoto 617-8555
Japan

Product Name: Communication Module

Brand Name: muRata

Model No.: LBEE6ZZ2AJ

Model Difference: N/A

Report Number: ER/2020/B0047

FCC ID VPLYB2AJ

IC: 772C-LB2AJ

FCC Rule Part: §15.407, Cat: U-NII

ISED RSS: RSS-247 issue 2 Feb. 2017

Issue Date: Feb. 22, 2021

Date of Test: Nov. 19, 2020 ~ Jan. 12, 2021

**Date of EUT Re-
ceived:** Nov. 19, 2020

We hereby certify that:

The above equipment was tested by SGS Taiwan Ltd. Central RF Lab The test data, data evaluation, test procedures, and equipment configurations shown in this report were made in accordance with the procedures given in ANSI C63.10: 2013 and the energy emitted by the sample EUT tested as described in this report is in compliance with conducted and radiated emission limits.

The test results of this report relate only to the tested sample identified in this report.

Approved By: _____



Jim Chang / Manager



Unless otherwise stated the results shown in this test report refer only to the sample(s) tested and such sample(s) are retained for 90 days only.

除非另有說明，此報告結果僅對測試之樣品負責，同時此樣品僅保留90天。本報告未經本公司書面許可，不可部份複製。

This document is issued by the Company subject to its General Conditions of Service printed overleaf, available on request or accessible at <http://www.sgs.com.tw/Terms-and-Conditions> and for electronic format documents, subject to Terms and Conditions for Electronic Documents at <http://www.sgs.com.tw/Terms-and-Conditions>. Attention is drawn to the limitation of liability, indemnification and jurisdiction issues defined therein. Any holder of this document is advised that information contained hereon reflects the Company's findings at the time of its intervention only and within the limits of Client's instructions, if any. The Company's sole responsibility is to its Client and this document does not exonerate parties to a transaction from exercising all their rights and obligations under the transaction documents. This document cannot be reproduced except in full, without prior written approval of the Company. Any unauthorized alteration, forgery or falsification of the content or appearance of this document is unlawful and offenders may be prosecuted to the fullest extent of the law.

Revision History

Report Number	Revision	Description	Issue Date	Remark
ER/2020/B0047	Rev.00	Original.	Feb. 22, 2021	Revised By: Yuri Tsai

Note:

1、Disclaimer

Antenna information is provided by the applicant, test results of this report are applicable to the sample EUT received.

Unless otherwise stated the results shown in this test report refer only to the sample(s) tested and such sample(s) are retained for 90 days only.

除非另有說明，此報告結果僅對測試之樣品負責，同時此樣品僅保留90天。本報告未經本公司書面許可，不可部份複製。

This document is issued by the Company subject to its General Conditions of Service printed overleaf, available on request or accessible at <http://www.sgs.com.tw/Terms-and-Conditions> and for electronic format documents, subject to Terms and Conditions for Electronic Documents at <http://www.sgs.com.tw/Terms-and-Conditions>. Attention is drawn to the limitation of liability, indemnification and jurisdiction issues defined therein. Any holder of this document is advised that information contained hereon reflects the Company's findings at the time of its intervention only and within the limits of Client's instructions, if any. The Company's sole responsibility is to its Client and this document does not exonerate parties to a transaction from exercising all their rights and obligations under the transaction documents. This document cannot be reproduced except in full, without prior written approval of the Company. Any unauthorized alteration, forgery or falsification of the content or appearance of this document is unlawful and offenders may be prosecuted to the fullest extent of the law.

Contents

1	GENERAL INFORMATION	4
2	SYSTEM TEST CONFIGURATION.....	9
3	SUMMARY OF TEST RESULT	12
4	DESCRIPTION OF TEST MODES.....	13
5	MEASUREMENT UNCERTAINTY	20
6	CONDUCTED EMISSION TEST.....	21
7	DUTY CYCLE TEST SIGNAL	25
8	26dB, 99% & 6dB EMISSION BANDWIDTH MEASUREMENT.....	28
9	MAXIMUM CONDUCTED OUTPUT POWER MEASUREMENT	85
10	MAXIMUM POWER SPECTRAL DENSITY.....	108
11	UNDESIRABLE RADIATED EMISSION MEASUREMENT.....	152
12	TRANSMISSION IN THE ABSENCE OF DATA.....	454
13	ANTENNA REQUIREMENT.....	455

Unless otherwise stated the results shown in this test report refer only to the sample(s) tested and such sample(s) are retained for 90 days only.

除非另有說明，此報告結果僅對測試之樣品負責，同時此樣品僅保留90天。本報告未經本公司書面許可，不可部份複製。

This document is issued by the Company subject to its General Conditions of Service printed overleaf, available on request or accessible at <http://www.sgs.com.tw/Terms-and-Conditions> and for electronic format documents, subject to Terms and Conditions for Electronic Documents at <http://www.sgs.com.tw/Terms-and-Conditions>. Attention is drawn to the limitation of liability, indemnification and jurisdiction issues defined therein. Any holder of this document is advised that information contained hereon reflects the Company's findings at the time of its intervention only and within the limits of Client's instructions, if any. The Company's sole responsibility is to its Client and this document does not exonerate parties to a transaction from exercising all their rights and obligations under the transaction documents. This document cannot be reproduced except in full, without prior written approval of the Company. Any unauthorized alteration, forgery or falsification of the content or appearance of this document is unlawful and offenders may be prosecuted to the fullest extent of the law.

1 GENERAL INFORMATION

1.1 Product Description

Product Name:	Communication Module	
Brand Name:	muRata	
Model No.:	LBEE6ZZ2AJ	
Model Difference:	N/A	
Hardware Version:	1.0	
Software Version:	1.0	
EUT Series No.:	2AJ-1	
Power Supply:	3.85 Vdc	
Modulation type	64QAM, 16QAM, QPSK, BPSK for OFDM in 802.11a 64QAM, 16QAM, QPSK, BPSK for OFDM in 802.11n 256QAM, 64QAM, 16QAM, QPSK, BPSK for OFDM in 802.11ac 1024QAM, 256QAM, 64QAM, 16QAM, QPSK, BPSK for OFDMA in 802.11ax	
Transition Rate:	802.11a: 6/9/12/18/24/36/48/54 Mbps 802.11n_20MHz: 6.5-144.4Mbps 802.11n_40MHz: 13.5-300.0Mbps	802.11ac_20MHz: 6.5-173.3Mbps 802.11ac_40MHz: 13.5-400.0Mbps 802.11ac_80MHz: 29.3-866.7Mbps 802.11ax_20MHz: 0.4-286.8Mbps 802.11ax_40MHz: 0.4-573.5Mbps 802.11ax_80MHz: 0.4-1201Mbps

Unless otherwise stated the results shown in this test report refer only to the sample(s) tested and such sample(s) are retained for 90 days only.

除非另有說明，此報告結果僅對測試之樣品負責，同時此樣品僅保留90天。本報告未經本公司書面許可，不可部份複製。

This document is issued by the Company subject to its General Conditions of Service printed overleaf, available on request or accessible at <http://www.sgs.com.tw/Terms-and-Conditions> and for electronic format documents, subject to Terms and Conditions for Electronic Documents at <http://www.sgs.com.tw/Terms-and-Conditions>. Attention is drawn to the limitation of liability, indemnification and jurisdiction issues defined therein. Any holder of this document is advised that information contained hereon reflects the Company's findings at the time of its intervention only and within the limits of Client's instructions, if any. The Company's sole responsibility is to its Client and this document does not exonerate parties to a transaction from exercising all their rights and obligations under the transaction documents. This document cannot be reproduced except in full, without prior written approval of the Company. Any unauthorized alteration, forgery or falsification of the content or appearance of this document is unlawful and offenders may be prosecuted to the fullest extent of the law.

1.2 Antenna Designation

Antenna Type	Supplier	Port	Antenna Part No.	Freq. (MHz)	Peak Antenna Gain (dBi)	Worst Case Scenario
Patch	TE	Port-WLAN1	955-011-901	5150~5250	-5.00	
				5250~5350		
				5470~5725		
				5725~5850		
Patch	TE	Port-WLAN2	955-011-901	5150~5250	-2.30	V
				5250~5350		
				5470~5725		
				5725~5850		

Note: Investigation has been done to determine the worst case scenario for the above antennas demonstrated with measurements in this report.

Unless otherwise stated the results shown in this test report refer only to the sample(s) tested and such sample(s) are retained for 90 days only.

除非另有說明，此報告結果僅對測試之樣品負責，同時此樣品僅保留90天。本報告未經本公司書面許可，不可部份複製。

This document is issued by the Company subject to its General Conditions of Service printed overleaf, available on request or accessible at <http://www.sgs.com.tw/Terms-and-Conditions> and for electronic format documents, subject to Terms and Conditions for Electronic Documents at <http://www.sgs.com.tw/Terms-and-Conditions>. Attention is drawn to the limitation of liability, indemnification and jurisdiction issues defined therein. Any holder of this document is advised that information contained hereon reflects the Company's findings at the time of its intervention only and within the limits of Client's instructions, if any. The Company's sole responsibility is to its Client and this document does not exonerate parties to a transaction from exercising all their rights and obligations under the transaction documents. This document cannot be reproduced except in full, without prior written approval of the Company. Any unauthorized alteration, forgery or falsification of the content or appearance of this document is unlawful and offenders may be prosecuted to the fullest extent of the law.

1.3 FCC worst power

IEEE 802.11	Frequency Range(MHz)	Channels	Rated Power (Avg.) (dBm) (Worst case)	Modulation Technology
a	5150~5250	4	12.99	OFDM
	5250~5350	4	12.96	
	5470~5725	12	12.98	
	5725-5850	5	12.99	
n_HT ac_VHT ax_HE 20M	5150~5250	4	HE: 15.97	OFDM / OFDMA
	5250~5350	4	HE: 15.98	
	5470~5725	12	HE: 15.99	
	5725-5850	5	HE: 15.98	
n_HT ac_VHT ax_HE 40M	5150~5250	2	HE: 15.99	OFDM / OFDMA
	5250~5350	2	HE: 15.95	
	5470~5725	6	HT: 15.91	
	5725-5850	2	HT: 15.95	
ac_VHT ax_HE 80M	5150~5250	1	HE: 15.99	OFDM / OFDMA
	5250~5350	1	HE: 15.96	
	5470~5725	3	VHT: 15.98	
	5725-5850	1	VHT: 15.97	

Unless otherwise stated the results shown in this test report refer only to the sample(s) tested and such sample(s) are retained for 90 days only.

除非另有說明，此報告結果僅對測試之樣品負責，同時此樣品僅保留90天。本報告未經本公司書面許可，不可部份複製。

This document is issued by the Company subject to its General Conditions of Service printed overleaf, available on request or accessible at <http://www.sgs.com.tw/Terms-and-Conditions> and for electronic format documents, subject to Terms and Conditions for Electronic Documents at <http://www.sgs.com.tw/Terms-and-Conditions>. Attention is drawn to the limitation of liability, indemnification and jurisdiction issues defined therein. Any holder of this document is advised that information contained hereon reflects the Company's findings at the time of its intervention only and within the limits of Client's instructions, if any. The Company's sole responsibility is to its Client and this document does not exonerate parties to a transaction from exercising all their rights and obligations under the transaction documents. This document cannot be reproduced except in full, without prior written approval of the Company. Any unauthorized alteration, forgery or falsification of the content or appearance of this document is unlawful and offenders may be prosecuted to the fullest extent of the law.

1.4 ISED worst power

IEEE 802.11	Frequency Range (MHz)	Channels	Avg. or EIRP	Rated Power(dBm) (Worst Case)	Modulation Technology
a	5150~5250	4	EIRP	7.99	OFDM
	5250~5350	4	Avg.	12.96	
	5470~5725	9	Avg.	12.98	
	5725-5850	5	Avg.	12.99	
n_HT ac_VHT 20M	5150~5250	4	EIRP	HT: 15.40	OFDM
	5250~5350	4	Avg.	HT: 15.61	
	5470~5725	9	Avg.	HT: 15.92	
	5725-5850	5	Avg.	HT: 15.76	
n_HT ac_VHT 40M	5150~5250	2	EIRP	HT: 15.29	OFDM
	5250~5350	2	Avg.	HT: 15.65	
	5470~5725	4	Avg.	HT: 15.91	
	5725-5850	2	Avg.	HT: 15.95	
ac_VHT 80M	5150~5250	1	EIRP	VHT: 15.00	OFDM
	5250~5350	1	Avg.	VHT: 15.54	
	5470~5725	2	Avg.	VHT: 15.98	
	5725-5850	1	Avg.	VHT: 15.97	
ax_HE 20M	5150~5250	4	EIRP	HE: 15.43	OFDMA
	5250~5350	4	Avg.	HE: 15.98	
	5470~5725	9	Avg.	HE: 15.99	
	5725-5850	5	Avg.	HE: 15.98	
ax_HE 40M	5150~5250	2	EIRP	HE: 15.45	OFDMA
	5250~5350	2	Avg.	HE: 15.95	
	5470~5725	4	Avg.	HE: 15.81	
	5725-5850	2	Avg.	HE: 15.89	
ax_HE 80M	5150~5250	1	EIRP	HE: 15.45	OFDMA
	5250~5350	1	Avg.	HE: 15.96	
	5470~5725	2	Avg.	HE: 15.83	
	5725-5850	1	Avg.	HE: 15.96	

Note:

As per guidance in presentation 2018-04-10-03 IC Certification updates of April 2018 TCB workshop, Client (Slave mode) devices without active scanning function, but with the capability of operating in 5600-5650 MHz solely under the control of a certified master device meeting the requirement of RSS-247, are allowed in Canada.

Unless otherwise stated the results shown in this test report refer only to the sample(s) tested and such sample(s) are retained for 90 days only.

除非另有說明，此報告結果僅對測試之樣品負責，同時此樣品僅保留90天。本報告未經本公司書面許可，不可部份複製。

This document is issued by the Company subject to its General Conditions of Service printed overleaf, available on request or accessible at <http://www.sgs.com.tw/Terms-and-Conditions> and for electronic format documents, subject to Terms and Conditions for Electronic Documents at <http://www.sgs.com.tw/Terms-and-Conditions>. Attention is drawn to the limitation of liability, indemnification and jurisdiction issues defined therein. Any holder of this document is advised that information contained hereon reflects the Company's findings at the time of its intervention only and within the limits of Client's instructions, if any. The Company's sole responsibility is to its Client and this document does not exonerate parties to a transaction from exercising all their rights and obligations under the transaction documents. This document cannot be reproduced except in full, without prior written approval of the Company. Any unauthorized alteration, forgery or falsification of the content or appearance of this document is unlawful and offenders may be prosecuted to the fullest extent of the law.

1.5 Test Methodology of Applied Standards

FCC Part 15, Subpart E §15.407
FCC KDB 789033 D02 General UNII Test Procedures New Rules v02r01
FCC KDB 662911 D01 Multiple Transmitter Output v02r01
RSS-247 issue 2 Feb. 2017
RSS-Gen. issue 5, Amendment 1, March 2019
ANSI C63.10:2013

1.6 Test Facility

SGS Taiwan Ltd. Central RF Lab (TAF code 3702)
No.134, Wu Kung Road, New Taipei Industrial Park, Wuku District, New Taipei City, Taiwan 24803
FCC Designation number: TW0027
ISED CAB identifier: TW3702

1.7 Special Accessories

There are no special accessories used while test was conducted.

1.8 Equipment Modifications

There was no modification incorporated into the EUT.

Unless otherwise stated the results shown in this test report refer only to the sample(s) tested and such sample(s) are retained for 90 days only.

除非另有說明，此報告結果僅對測試之樣品負責，同時此樣品僅保留90天。本報告未經本公司書面許可，不可部份複製。

This document is issued by the Company subject to its General Conditions of Service printed overleaf, available on request or accessible at <http://www.sgs.com.tw/Terms-and-Conditions> and for electronic format documents, subject to Terms and Conditions for Electronic Documents at <http://www.sgs.com.tw/Terms-and-Conditions>. Attention is drawn to the limitation of liability, indemnification and jurisdiction issues defined therein. Any holder of this document is advised that information contained hereon reflects the Company's findings at the time of its intervention only and within the limits of Client's instructions, if any. The Company's sole responsibility is to its Client and this document does not exonerate parties to a transaction from exercising all their rights and obligations under the transaction documents. This document cannot be reproduced except in full, without prior written approval of the Company. Any unauthorized alteration, forgery or falsification of the content or appearance of this document is unlawful and offenders may be prosecuted to the fullest extent of the law.

2 SYSTEM TEST CONFIGURATION

2.1 EUT Configuration

The EUT configuration for testing is installed on RF field strength measurement to meet the Commissions requirement and operating in a manner which intends to maximize its emission characteristics in a continuous normal application.

2.2 EUT Exercise

An engineering test mode (software/firmware) that applicant provided was utilized to manipulate the EUT into transmit, selection of the test channel, and modulation scheme.

2.3 Test Procedure

2.3.1 Conducted Emissions

The EUT is a placed on a table which is 0.8 m above ground plane. Conducted emissions from the EUT measured in the frequency range between 0.15 MHz and 30MHz. The CISPR Quasi-Peak and Average detector mode is employed. The two LISNs provide 50uH/50 ohm of coupling impedance for the measuring instrument. Both lines of the power mains connected to the EUT were checked for maximum conducted interference.

2.3.2 Conducted Test (RF)

The active antenna port of the unlicensed wireless device is connected to the spectrum analyzer with attenuator to protect the instrumentation. If a second antenna port is available, it is tested at one operating frequency, with other port(s) appropriately terminated, to verify it has similar output characteristics as the fully tested port.

2.3.3 Radiated Emissions

The EUT is a placed on a turn table. For emissions testing at or below 1 GHz, the table height shall be 0.8 m above the reference ground plane. For emission measurements above 1 GHz, the table height shall be 1.5 m. The turn table shall rotate 360 degrees to determine the position of maximum emission level. EUT is set 3m away from the receiving antenna which varied from 1m to 4m to find out the highest emission. And also, each emission was to be maximized by changing the polarization of receiving antenna both horizontal and vertical. In order to find out the max. emission, the relative positions of this transmitter (EUT) was rotated through three orthogonal axes and measurement procedures for electric field radiated emissions above 1 GHz the EUT measurement is to be made "while keeping the antenna in the 'cone of radiation' from that area and pointed at the area both in azimuth and elevation, with polarization oriented for maximum response." is still within the 3dB illumination BW of the measurement antenna.

Unless otherwise stated the results shown in this test report refer only to the sample(s) tested and such sample(s) are retained for 90 days only.

除非另有說明，此報告結果僅對測試之樣品負責，同時此樣品僅保留90天。本報告未經本公司書面許可，不可部份複製。

This document is issued by the Company subject to its General Conditions of Service printed overleaf, available on request or accessible at <http://www.sgs.com.tw/Terms-and-Conditions> and for electronic format documents, subject to Terms and Conditions for Electronic Documents at <http://www.sgs.com.tw/Terms-and-Conditions>. Attention is drawn to the limitation of liability, indemnification and jurisdiction issues defined therein. Any holder of this document is advised that information contained hereon reflects the Company's findings at the time of its intervention only and within the limits of Client's instructions, if any. The Company's sole responsibility is to its Client and this document does not exonerate parties to a transaction from exercising all their rights and obligations under the transaction documents. This document cannot be reproduced except in full, without prior written approval of the Company. Any unauthorized alteration, forgery or falsification of the content or appearance of this document is unlawful and offenders may be prosecuted to the fullest extent of the law.

2.4 Measurement Results Explanation Example

2.4.1 Radiated Emission Test Sites For Measurements From 9 kHz To 30 MHz

Radiated emission below 30MHz is measured in a 9m*9m*6m semi-anechoic chamber, the measurements correspond to those obtained at an open-field test site.

There is a comparison data of both open-field test site and semi-Anechoic chamber, and the result came out very similar.

2.4.2 For all conducted test items:

The offset level is set in the spectrum analyzer to compensate the RF cable loss and attenuation factor between EUT conducted port and spectrum analyzer. With the offset compensation, the spectrum analyzer reading level is exactly EUT RF output level.

Unless otherwise stated the results shown in this test report refer only to the sample(s) tested and such sample(s) are retained for 90 days only.

除非另有說明，此報告結果僅對測試之樣品負責，同時此樣品僅保留90天。本報告未經本公司書面許可，不可部份複製。

This document is issued by the Company subject to its General Conditions of Service printed overleaf, available on request or accessible at <http://www.sgs.com.tw/Terms-and-Conditions> and for electronic format documents, subject to Terms and Conditions for Electronic Documents at <http://www.sgs.com.tw/Terms-and-Conditions>. Attention is drawn to the limitation of liability, indemnification and jurisdiction issues defined therein. Any holder of this document is advised that information contained hereon reflects the Company's findings at the time of its intervention only and within the limits of Client's instructions, if any. The Company's sole responsibility is to its Client and this document does not exonerate parties to a transaction from exercising all their rights and obligations under the transaction documents. This document cannot be reproduced except in full, without prior written approval of the Company. Any unauthorized alteration, forgery or falsification of the content or appearance of this document is unlawful and offenders may be prosecuted to the fullest extent of the law.

2.5 Configuration of Tested System

Fig. 2-1 Radiated Emission Configuration



Fig. 2-2 Conducted (Antenna Port) Emission Configuration



Fig. 2-3 Conducted (AC powerline) Emission Configuration

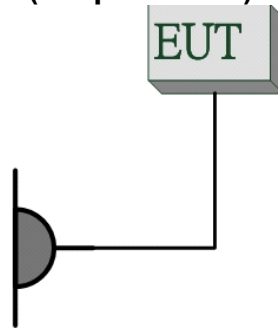

Table 2-1 Equipment Used in Tested System

Item	Equipment	Mfr/Brand	Model/Type No.	Series No.	Data Cable	Power Cord
1	WLAN Test Software	N/A	N/A	N/A	N/A	N/A
2	Notebook	Lenovo	L430	R9-XFG0X	N/A	N/A
3	DC Power Supply	Agilent	E3640A	MY52410006	N/A	N/A
4	DC Power Supply	Agilent	E3640A	KR93300208	N/A	N/A

Unless otherwise stated the results shown in this test report refer only to the sample(s) tested and such sample(s) are retained for 90 days only.

除非另有說明，此報告結果僅對測試之樣品負責，同時此樣品僅保留90天。本報告未經本公司書面許可，不可部份複製。

This document is issued by the Company subject to its General Conditions of Service printed overleaf, available on request or accessible at <http://www.sgs.com.tw/Terms-and-Conditions> and for electronic format documents, subject to Terms and Conditions for Electronic Documents at <http://www.sgs.com.tw/Terms-and-Conditions>. Attention is drawn to the limitation of liability, indemnification and jurisdiction issues defined therein. Any holder of this document is advised that information contained hereon reflects the Company's findings at the time of its intervention only and within the limits of Client's instructions, if any. The Company's sole responsibility is to its Client and this document does not exonerate parties to a transaction from exercising all their rights and obligations under the transaction documents. This document cannot be reproduced except in full, without prior written approval of the Company. Any unauthorized alteration, forgery or falsification of the content or appearance of this document is unlawful and offenders may be prosecuted to the fullest extent of the law.

3 SUMMARY OF TEST RESULT

FCC Rules	IC Rules	Description Of Test	Result
§15.207	RSS-Gen §8.8	AC Power Line Conducted Emission	Compliant
§15.403(i) §15.407(e)	RSS-Gen §6.7 RSS-247 §6.2.4.1	26 dB & 6dB & 99% Emission Bandwidth	Compliant
§15.407(a)	RSS-247 §6.2.1~ 4 (1)	Maximum Conducted Output Power	Compliant
§15.407(a)	RSS-247 §6.2.1~ 4 (1)	Power Spectral Density	Compliant
§15.205 §15.209 §15.407(b)	RSS-247 §6.2.1~ 4 (2)	Undesirable Radiated Emissions	Compliant
§15.407(c)	RSS-247 §6.4	Transmission in case of Absence of Information	Compliant
§15.203 §15.407(a)	N/A	Antenna Requirement	Compliant

Unless otherwise stated the results shown in this test report refer only to the sample(s) tested and such sample(s) are retained for 90 days only.

除非另有說明，此報告結果僅對測試之樣品負責，同時此樣品僅保留90天。本報告未經本公司書面許可，不可部份複製。

This document is issued by the Company subject to its General Conditions of Service printed overleaf, available on request or accessible at <http://www.sgs.com.tw/Terms-and-Conditions> and for electronic format documents, subject to Terms and Conditions for Electronic Documents at <http://www.sgs.com.tw/Terms-and-Conditions>. Attention is drawn to the limitation of liability, indemnification and jurisdiction issues defined therein. Any holder of this document is advised that information contained hereon reflects the Company's findings at the time of its intervention only and within the limits of Client's instructions, if any. The Company's sole responsibility is to its Client and this document does not exonerate parties to a transaction from exercising all their rights and obligations under the transaction documents. This document cannot be reproduced except in full, without prior written approval of the Company. Any unauthorized alteration, forgery or falsification of the content or appearance of this document is unlawful and offenders may be prosecuted to the fullest extent of the law.

4 DESCRIPTION OF TEST MODES

4.1 802.11a/n/ac/ax operated in U-NII Bands

Operated band in 5150 MHz ~5250 MHz:

20 M		40 M		80 M	
CH	Freq (MHz)	CH	Freq (MHz)	CH	Freq (MHz)
36	5180	38	5190	42	5210
40	5200	46	5230		
44	5220				
48	5240				

Operated band in 5250 MHz ~5350 MHz:

20 M		40 M		80 M		160 M	
CH	Freq (MHz)	CH	Freq (MHz)	CH	Freq (MHz)	CH	Freq (MHz)
52	5260	54	5270	58	5290	50	5250
56	5280	62	5310				
60	5300						
64	5320						

Operated band in 5470 MHz ~5725 MHz:

20 M		40 M		80 M		160 M	
CH	Freq (MHz)	CH	Freq (MHz)	CH	Freq (MHz)	CH	Freq (MHz)
100	5500	102	5510	106	5530	114	5570
104	5520	110	5550	122	5610		
108	5540	118	5590	138	5690		
112	5560	126	5630				
116	5580	134	5670				
120	5600	142	5710				
124	5620						
128	5640						
132	5660						
136	5680						
140	5700						
144	5720						

Operated band in 5745 MHz ~5850 MHz:

20 M		40 M		80 M	
CH	Freq (MHz)	CH	Freq (MHz)	CH	Freq (MHz)
149	5745	151	5755	155	5775
153	5765	159	5795		
157	5785				
161	5805				
165	5825				

Unless otherwise stated the results shown in this test report refer only to the sample(s) tested and such sample(s) are retained for 90 days only.

除非另有說明，此報告結果僅對測試之樣品負責，同時此樣品僅保留90天。本報告未經本公司書面許可，不可部份複製。

This document is issued by the Company subject to its General Conditions of Service printed overleaf, available on request or accessible at <http://www.sgs.com.tw/Terms-and-Conditions> and for electronic format documents, subject to Terms and Conditions for Electronic Documents at <http://www.sgs.com.tw/Terms-and-Conditions>. Attention is drawn to the limitation of liability, indemnification and jurisdiction issues defined therein. Any holder of this document is advised that information contained hereon reflects the Company's findings at the time of its intervention only and within the limits of Client's instructions, if any. The Company's sole responsibility is to its Client and this document does not exonerate parties to a transaction from exercising all their rights and obligations under the transaction documents. This document cannot be reproduced except in full, without prior written approval of the Company. Any unauthorized alteration, forgery or falsification of the content or appearance of this document is unlawful and offenders may be prosecuted to the fullest extent of the law.

4.2 The Worst Test Modes and Channel Details

1. The EUT has been tested under operating condition.
2. Test program used to control the EUT for staying in continuous transmitting mode is programmed.
3. Investigation has been done on all the possible configurations for searching the worst case. The gevin UE is pre-scanned among below modes.

Modulation	Transmission Chain				Single Transmission Spatial	Multiple Transmission Spatial
	Ch0	Ch1	Ch2	Ch3		
<input checked="" type="checkbox"/> 802.11 a	<input checked="" type="checkbox"/> Ch0	<input type="checkbox"/> Ch1	<input type="checkbox"/> Ch2	<input type="checkbox"/> Ch3	<input type="checkbox"/> 1TX	<input type="checkbox"/> 2TX
<input checked="" type="checkbox"/> 802.11 n	<input checked="" type="checkbox"/> Ch0	<input checked="" type="checkbox"/> Ch1	<input type="checkbox"/> Ch2	<input type="checkbox"/> Ch3	<input type="checkbox"/> SISO	<input checked="" type="checkbox"/> MIMO
<input checked="" type="checkbox"/> 802.11 ac	<input checked="" type="checkbox"/> Ch0	<input checked="" type="checkbox"/> Ch1	<input type="checkbox"/> Ch2	<input type="checkbox"/> Ch3	<input type="checkbox"/> SISO	<input checked="" type="checkbox"/> MIMO
<input checked="" type="checkbox"/> 802.11 ax	<input checked="" type="checkbox"/> Ch0	<input checked="" type="checkbox"/> Ch1	<input type="checkbox"/> Ch2	<input type="checkbox"/> Ch3	<input type="checkbox"/> SISO	<input checked="" type="checkbox"/> MIMO

Unless otherwise stated the results shown in this test report refer only to the sample(s) tested and such sample(s) are retained for 90 days only.

除非另有說明，此報告結果僅對測試之樣品負責，同時此樣品僅保留90天。本報告未經本公司書面許可，不可部份複製。

This document is issued by the Company subject to its General Conditions of Service printed overleaf, available on request or accessible at <http://www.sgs.com.tw/Terms-and-Conditions> and for electronic format documents, subject to Terms and Conditions for Electronic Documents at <http://www.sgs.com.tw/Terms-and-Conditions>. Attention is drawn to the limitation of liability, indemnification and jurisdiction issues defined therein. Any holder of this document is advised that information contained hereon reflects the Company's findings at the time of its intervention only and within the limits of Client's instructions, if any. The Company's sole responsibility is to its Client and this document does not exonerate parties to a transaction from exercising all their rights and obligations under the transaction documents. This document cannot be reproduced except in full, without prior written approval of the Company. Any unauthorized alteration, forgery or falsification of the content or appearance of this document is unlawful and offenders may be prosecuted to the fullest extent of the law.

4. Observations have been done for 802.11 ax available RU configurations below and found that the lowest, highest and Full RU results higher emissions.

Only one RU can be enabled at any given time. (802.11 ax)

802.11ax		20MHz				802.11ax		40MHz			
RU type		26-tone RU		52-tone RU		RU type		26-tone RU		52-tone RU	
RU index and subcarrier range	RU0	[-121: -96]	RU37	[-121: -70]	RU index and subcarrier range	RU0	[-243: -218]	RU37	[-243: -192]		
	RU1	[-95: -70]	RU38	[-68: -17]		RU1	[-217: -192]	RU38	[-189: -138]		
	RU2	[-68: -43]	RU39	[17: 68]		RU2	[-189: -164]	RU39	[-109: -58]		
	RU3	[-42: -17]	RU40	[70: 121]		RU3	[-163: -138]	RU40	[-55: -4]		
	RU4	[-16: -4, 4: 16]	RU41	N/A		RU4	[-136: -111]	RU41	[4: 55]		
	RU5	[17: 42]	RU42	N/A		RU5	[-109: -84]	RU42	[58: 109]		
	RU6	[43: 68]	RU43	N/A		RU6	[-83: -58]	RU43	[138: 189]		
	RU7	[70: 95]	RU44	N/A		RU7	[-55: -30]	RU44	[192: 243]		
	RU8	[96: 121]	RU45	N/A		RU8	[-29: -4]	RU45	N/A		
	RU9	N/A	RU46	N/A		RU9	[4: 29]	RU46	N/A		
	RU10	N/A	RU47	N/A		RU10	[30: 55]	RU47	N/A		
	RU11	N/A	RU48	N/A		RU11	[58: 83]	RU48	N/A		
	RU12	N/A	RU49	N/A		RU12	[84: 109]	RU49	N/A		
	RU13	N/A	RU50	N/A		RU13	[111: 136]	RU50	N/A		
	RU14	N/A	RU51	N/A		RU14	[138: 163]	RU51	N/A		
	RU15	N/A	RU52	N/A		RU15	[164: 189]	RU52	N/A		
	RU16	N/A				RU16	[192: 217]				
	RU17	N/A	106-tone RU			RU17	[218: 243]	106-tone RU			
	RU18	N/A	RU53	[-122: -17]		RU18	N/A	RU53	[-243: -138]		
	RU19	N/A	RU54	[17: 122]		RU19	N/A	RU54	[-109: -4]		
	RU20	N/A	RU55	N/A		RU20	N/A	RU55	[4: 109]		
	RU21	N/A	RU56	N/A		RU21	N/A	RU56	[138: 243]		
	RU22	N/A	RU57	N/A		RU22	N/A	RU57	N/A		
	RU23	N/A	RU58	N/A		RU23	N/A	RU58	N/A		
	RU24	N/A	RU59	N/A		RU24	N/A	RU59	N/A		
	RU25	N/A	RU60	N/A		RU25	N/A	RU60	N/A		
	RU26	N/A				RU26	N/A				
	RU27	N/A	242-tone RU			RU27	N/A	242-tone RU			
	RU28	N/A	RU61	[-122: -2, 2:122]		RU28	N/A	RU61	[-244: -3]		
	RU29	N/A	RU62	N/A		RU29	N/A	RU62	[3: 244]		
	RU30	N/A	RU63	N/A		RU30	N/A	RU63	N/A		
	RU31	N/A	RU64	N/A		RU31	N/A	RU64	N/A		
	RU32	N/A				RU32	N/A				
	RU33	N/A				RU33	N/A	484-tone RU			
	RU34	N/A				RU34	N/A	RU65	[-244: -3, 3: 244]		
	RU35	N/A				RU35	N/A	RU66	N/A		
RU36	N/A			RU36	N/A						

Unless otherwise stated the results shown in this test report refer only to the sample(s) tested and such sample(s) are retained for 90 days only.

除非另有說明，此報告結果僅對測試之樣品負責，同時此樣品僅保留90天。本報告未經本公司書面許可，不可部份複製。

This document is issued by the Company subject to its General Conditions of Service printed overleaf, available on request or accessible at <http://www.sgs.com.tw/Terms-and-Conditions> and for electronic format documents, subject to Terms and Conditions for Electronic Documents at <http://www.sgs.com.tw/Terms-and-Conditions>. Attention is drawn to the limitation of liability, indemnification and jurisdiction issues defined therein. Any holder of this document is advised that information contained hereon reflects the Company's findings at the time of its intervention only and within the limits of Client's instructions, if any. The Company's sole responsibility is to its Client and this document does not exonerate parties to a transaction from exercising all their rights and obligations under the transaction documents. This document cannot be reproduced except in full, without prior written approval of the Company. Any unauthorized alteration, forgery or falsification of the content or appearance of this document is unlawful and offenders may be prosecuted to the fullest extent of the law.

802.11ax	80MHz			
RU type	26-tone RU		52-tone RU	
RU index and subcarrier range	RU0	[-499: -474]	RU37	[-499: -448]
	RU1	[-473: -448]	RU38	[-445: -394]
	RU2	[-445: -420]	RU39	[-365: -314]
	RU3	[-419: -394]	RU40	[-311: -260]
	RU4	[-392: -367]	RU41	[-257: -206]
	RU5	[-365: -340]	RU42	[-203: -152]
	RU6	[-339: -314]	RU43	[-123: -72]
	RU7	[-311: -286]	RU44	[-69: -18]
	RU8	[-285: -260]	RU45	[18: 69]
	RU9	[-257: -232]	RU46	[72: 123]
	RU10	[-231: -206]	RU47	[152: 203]
	RU11	[-203: -178]	RU48	[206: 257]
	RU12	[-177: -152]	RU49	[260: 311]
	RU13	[-150: -125]	RU50	[314: 365]
	RU14	[-123: -98]	RU51	[394: 445]
	RU15	[-97: -72]	RU52	[448: 499]
	RU16	[-69: -44]	106-tone RU	
	RU17	[-43: -18]	RU53	[-499: -394]
	RU18	[-16: -4, 4: 16]	RU54	[-365: -260]
	RU19	[18: 43]	RU55	[-257: -152]
	RU20	[44: 69]	RU56	[-123: -18]
	RU21	[72: 97]	RU57	[18: 123]
	RU22	[98: 123]	RU58	[152: 257]
	RU23	[125: 150]	RU59	[260: 365]
	RU24	[152: 177]	RU60	[394: 499]
	RU25	[178: 203]	242-tone RU	
	RU26	[206: 231]	RU61	[-500: -259]
	RU27	[232: 257]	RU62	[-258: -17]
	RU28	[260: 285]	RU63	[17: 258]
	RU29	[286: 311]	RU64	[259: 500]
	RU30	[314: 339]	484-tone RU	
	RU31	[340: 365]	RU65	[-500: -17]
	RU32	[367: 392]	RU66	[17: 500]
	RU33	[394: 419]	996-tone RU	
	RU34	[420: 445]	RU67	[-500: -3, 3: 500]
	RU35	[448: 473]		
RU36	[474: 499]			

5. Therefore, below summary is the modes of test configuration that yield the highest reading and generate the highest emission chosen to carry out the relevantly mandatory test items.

Unless otherwise stated the results shown in this test report refer only to the sample(s) tested and such sample(s) are retained for 90 days only.

除非另有說明，此報告結果僅對測試之樣品負責，同時此樣品僅保留90天。本報告未經本公司書面許可，不可部份複製。

This document is issued by the Company subject to its General Conditions of Service printed overleaf, available on request or accessible at <http://www.sgs.com.tw/Terms-and-Conditions> and for electronic format documents, subject to Terms and Conditions for Electronic Documents at <http://www.sgs.com.tw/Terms-and-Conditions>. Attention is drawn to the limitation of liability, indemnification and jurisdiction issues defined therein. Any holder of this document is advised that information contained hereon reflects the Company's findings at the time of its intervention only and within the limits of Client's instructions, if any. The Company's sole responsibility is to its Client and this document does not exonerate parties to a transaction from exercising all their rights and obligations under the transaction documents. This document cannot be reproduced except in full, without prior written approval of the Company. Any unauthorized alteration, forgery or falsification of the content or appearance of this document is unlawful and offenders may be prosecuted to the fullest extent of the law.

4.2.1 RADIATED EMISSION TEST:

RADIATED EMISSION TEST (BELOW 1 GHz)						
MODE	FREQUENCY BAND (MHz)	AVAILABLE CHANNEL	TESTED CHANNEL	MODULATION	DATA RATE (Mbps)	ANTENNA PORT
802.11a	5180-5240	36 to 48	44	OFDM	6	ch0
	5260-5320	52 to 64	60			
	5500-5700	100 to 140	116			
	5745-5825	149 to 165	157			
802.11ax_HE80	5190-5230	42	42	OFDMA	MCS0	MIMO
	5270-5310	58	58			
	5530-5690	106 to 138	122			
	5775	155	155			

RADIATED EMISSION TEST (ABOVE 1 GHz)						
MODE	FREQUENCY BAND (MHz)	AVAILABLE CHANNEL	TESTED CHANNEL	MODULATION	DATA RATE (Mbps)	ANTENNA PORT
802.11a	5180-5240	36 to 48	36,44,48	OFDM	6	ch0
	5260-5320	52 to 64	52,60,64			
	5500-5700	100 to 140	100,116,140			
	5745-5825	149 to 165	149,157,165			
802.11n_HT20	5180-5240	36 to 48	36,44,48	OFDM	MCS8	MIMO
	5260-5320	52 to 64	52,60,64			
	5500-5720	100 to 144	100,116,140,144			
	5745-5825	149 to 165	149,157,165			
802.11n_HT40	5190-5230	38 to 46	38,46	OFDM	MCS8	MIMO
	5270-5310	54 to 62	54,62			
	5510-5670	102 to 142	102,110,134,142			
	5755-5795	151 to 159	151,159			
802.11ac_VHT80	5210	42	42	OFDM	MCS0	MIMO
	5290	58	58			
	5530-5610	106 to 138	106,122,138			
	5775	155	155			

Unless otherwise stated the results shown in this test report refer only to the sample(s) tested and such sample(s) are retained for 90 days only.

除非另有說明，此報告結果僅對測試之樣品負責，同時此樣品僅保留90天。本報告未經本公司書面許可，不可部份複製。

This document is issued by the Company subject to its General Conditions of Service printed overleaf, available on request or accessible at <http://www.sgs.com.tw/Terms-and-Conditions> and for electronic format documents, subject to Terms and Conditions for Electronic Documents at <http://www.sgs.com.tw/Terms-and-Conditions>. Attention is drawn to the limitation of liability, indemnification and jurisdiction issues defined therein. Any holder of this document is advised that information contained hereon reflects the Company's findings at the time of its intervention only and within the limits of Client's instructions, if any. The Company's sole responsibility is to its Client and this document does not exonerate parties to a transaction from exercising all their rights and obligations under the transaction documents. This document cannot be reproduced except in full, without prior written approval of the Company. Any unauthorized alteration, forgery or falsification of the content or appearance of this document is unlawful and offenders may be prosecuted to the fullest extent of the law.

RADIATED EMISSION TEST (ABOVE 1 GHz)							
MODE	FREQUENCY BAND (MHz)	AVAILABLE CHANNEL	TESTED CHANNEL	MODULATION	RU CONFIGURATI	DATA RATE (Mbps)	ANTENNA PORT
802.11ax_HE20	5180~5240	36 to 48	36,44,48	OFDMA	FULL RU 26/0,26/8 52/37,52/40 106/53,106/54	MCS0	MIMO
	5260~5320	52 to 64	52,60,64				
	5500~5720	100 to 144	100,116,140,144				
	5745~5825	149 to 165	149,157,165				
802.11ax_HE40	5190~5230	38 to 46	38,46	OFDMA	FULL RU 242/61,242/62	MCS0	MIMO
	5270~5310	54 to 62	54,62				
	5510~5670	102 to 142	102,110,134,142				
	5755~5795	151 to 159	151,159				
802.11ax_HE80	5210	42	42	OFDMA	FULL RU 484/65,484/66	MCS8	MIMO
	5290	58	58				
	5530~5610	106 to 138	106,122,138				
	5775	155	155				

Note:

The field strength of radiation emission was measured as EUT stand-up position (H mode) and lie down position (E1, E2 mode) for 802.11a/n/ac/ax WLAN Transmitter for channel Low, Mid and High, the worst case E2 position was reported.

Unless otherwise stated the results shown in this test report refer only to the sample(s) tested and such sample(s) are retained for 90 days only.

除非另有說明，此報告結果僅對測試之樣品負責，同時此樣品僅保留90天。本報告未經本公司書面許可，不可部份複製。

This document is issued by the Company subject to its General Conditions of Service printed overleaf, available on request or accessible at <http://www.sgs.com.tw/Terms-and-Conditions> and for electronic format documents, subject to Terms and Conditions for Electronic Documents at <http://www.sgs.com.tw/Terms-and-Conditions>. Attention is drawn to the limitation of liability, indemnification and jurisdiction issues defined therein. Any holder of this document is advised that information contained hereon reflects the Company's findings at the time of its intervention only and within the limits of Client's instructions, if any. The Company's sole responsibility is to its Client and this document does not exonerate parties to a transaction from exercising all their rights and obligations under the transaction documents. This document cannot be reproduced except in full, without prior written approval of the Company. Any unauthorized alteration, forgery or falsification of the content or appearance of this document is unlawful and offenders may be prosecuted to the fullest extent of the law.

4.2.2 ANTENNA PORT CONDUCTED MEASUREMENT:

CONDUCTED TEST						
MODE	FREQUENCY BAND (MHz)	AVAILABLE CHANNEL	TESTED CHANNEL	MODULATION	DATA RATE (Mbps)	ANTENNA PORT
802.11a	5180-5240	36 to 48	36,44,48	OFDM	6	ch0
	5260-5320	52 to 64	52,60,64			
	5500-5700	100 to 140	100,116,140			
	5745-5825	149 to 165	149,157,165			
802.11n_HT20	5180-5240	36 to 48	36,44,48	OFDM	MCS8	MIMO
	5260-5320	52 to 64	52,60,64			
	5500-5720	100 to 144	100,116,140,144			
	5745-5825	149 to 165	149,157,165			
802.11n_HT40	5190-5230	38 to 46	38,46	OFDM	MCS8	MIMO
	5270-5310	54 to 62	54,62			
	5510-5670	102 to 142	102,110,134,142			
	5755-5795	151 to 159	151,159			
802.11ac_VHT80	5210	42	42	OFDM	MCS0	MIMO
	5290	58	58			
	5530-5610	106 to 138	106,122,138			
	5775	155	155			

CONDUCTED TEST							
MODE	FREQUENCY BAND (MHz)	AVAILABLE CHANNEL	TESTED CHANNEL	MODULATION	RU CONFIGURATI	DATA RATE (Mbps)	ANTENNA PORT
802.11ax_HE20	5180-5240	36 to 48	36,44,48	OFDMA	FULL RU 26/0,26/8 52/37,52/40 106/53,106/54	MCS0	MIMO
	5260-5320	52 to 64	52,60,64				
	5500-5720	100 to 144	100,116,140,144				
	5745-5825	149 to 165	149,157,165				
802.11ax_HE40	5190-5230	38 to 46	38,46	OFDMA	FULL RU 242/61,242/62	MCS0	MIMO
	5270-5310	54 to 62	54,62				
	5510-5670	102 to 142	102,110,134,142				
	5755-5795	151 to 159	151,159				
802.11ax_HE80	5210	42	42	OFDMA	FULL RU 484/65,484/66	MCS0	MIMO
	5290	58	58				
	5530-5610	106 to 138	106,122,138				
	5775	155	155				

Unless otherwise stated the results shown in this test report refer only to the sample(s) tested and such sample(s) are retained for 90 days only.

除非另有說明，此報告結果僅對測試之樣品負責，同時此樣品僅保留90天。本報告未經本公司書面許可，不可部份複製。

This document is issued by the Company subject to its General Conditions of Service printed overleaf, available on request or accessible at <http://www.sgs.com.tw/Terms-and-Conditions> and for electronic format documents, subject to Terms and Conditions for Electronic Documents at <http://www.sgs.com.tw/Terms-and-Conditions>. Attention is drawn to the limitation of liability, indemnification and jurisdiction issues defined therein. Any holder of this document is advised that information contained hereon reflects the Company's findings at the time of its intervention only and within the limits of Client's instructions, if any. The Company's sole responsibility is to its Client and this document does not exonerate parties to a transaction from exercising all their rights and obligations under the transaction documents. This document cannot be reproduced except in full, without prior written approval of the Company. Any unauthorized alteration, forgery or falsification of the content or appearance of this document is unlawful and offenders may be prosecuted to the fullest extent of the law.

5 MEASUREMENT UNCERTAINTY

Test Items	Uncertainty
AC Power Line Conducted Emission	+/- 2.34 dB
26dB & 6dB Emission Bandwidth	+/- 1.54 Hz
The Maximum Output Power Measurement	+/- 1 dB
Peak Power Spectral Density Measurement	+/- 1.54 dB
Frequency Stability	+/- 1.54 Hz
Temperature	+/- 0.4 °C
Humidity	+/- 3.5 %
DC / AC Power Source	DC= +/- 1%, AC= +/- 1%

Radiated Spurious Emission Measurement Uncertainty		
Polarization: Vertical	+/- 2.64 dB	9kHz~30MHz: +-2.3dB
	+/- 4.93 dB	30MHz - 1000MHz: +/- 3.37dB
	+/- 4.81 dB	1GHz - 18GHz: +/- 4.04dB
	+/- 4.52 dB	18GHz - 40GHz: +/- 4.04dB
Polarization: Horizontal	+/- 2.64 dB	9kHz~30MHz: +-2.3dB
	+/- 4.45 dB	30MHz - 1000MHz: +/- 4.22dB
	+/- 4.81 dB	1GHz - 18GHz: +/- 4.08dB
	+/- 4.52 dB	18GHz - 40GHz: +/- 4.08dB

Note:

1. This uncertainty represents an expanded uncertainty expressed at approximately the 95% confidence level using a coverage factor of k=2.
2. The conformity assessment statement in this report is based solely on the test results, measurement uncertainty is excluded.

Unless otherwise stated the results shown in this test report refer only to the sample(s) tested and such sample(s) are retained for 90 days only.

除非另有說明，此報告結果僅對測試之樣品負責，同時此樣品僅保留90天。本報告未經本公司書面許可，不可部份複製。

This document is issued by the Company subject to its General Conditions of Service printed overleaf, available on request or accessible at <http://www.sgs.com.tw/Terms-and-Conditions> and for electronic format documents, subject to Terms and Conditions for Electronic Documents at <http://www.sgs.com.tw/Terms-and-Conditions>. Attention is drawn to the limitation of liability, indemnification and jurisdiction issues defined therein. Any holder of this document is advised that information contained hereon reflects the Company's findings at the time of its intervention only and within the limits of Client's instructions, if any. The Company's sole responsibility is to its Client and this document does not exonerate parties to a transaction from exercising all their rights and obligations under the transaction documents. This document cannot be reproduced except in full, without prior written approval of the Company. Any unauthorized alteration, forgery or falsification of the content or appearance of this document is unlawful and offenders may be prosecuted to the fullest extent of the law.

6 CONDUCTED EMISSION TEST

6.1 Standard Applicable

Frequency range within 150 kHz to 30 MHz shall not exceed the Limit table as below.

Frequency range MHz	Limits dB(uV)	
	Quasi-peak	Average
0.15 to 0.50	66 to 56	56 to 46
0.50 to 5	56	46
5 to 30	60	50

Note

- The lower limit shall apply at the transition frequencies
- The limit decreases linearly with the logarithm of the frequency in the range 0.15 MHz to 0.50 MHz.

6.2 Measurement Equipment Used

Conducted Emission Test Site					
EQUIPMENT TYPE	MFR	MODEL NUMBER	SERIAL NUMBER	LAST CAL.	CAL DUE.
EMI Test Receiver	R&S	ESCI 7	100759	07/13/2020	07/12/2021
LISN	SCHWARZBECK	NSLK 8127	8127-465	04/09/2020	04/08/2021
Coaxial Cables	N/A	Coaxial Cable	161207	12/07/2020	12/06/2021
Test Software	audix	e3	Ver. 6.11-20180413	N.C.R	N.C.R

NOTE: N.C.R refers to Not Calibrated Required.

6.3 EUT Setup

- The conducted emission tests were performed in the test site, using the setup in accordance with the ANSI C63.10:2013.
- The AC/DC Power adaptor of EUT was plug-in LISN. The rear of the EUT and peripherals were placed flushed with the rear of the tabletop.
- The LISN was connected with 120Vac/60Hz power source.

Unless otherwise stated the results shown in this test report refer only to the sample(s) tested and such sample(s) are retained for 90 days only.

除非另有說明，此報告結果僅對測試之樣品負責，同時此樣品僅保留90天。本報告未經本公司書面許可，不可部份複製。

This document is issued by the Company subject to its General Conditions of Service printed overleaf, available on request or accessible at <http://www.sgs.com.tw/Terms-and-Conditions> and for electronic format documents, subject to Terms and Conditions for Electronic Documents at <http://www.sgs.com.tw/Terms-and-Conditions>. Attention is drawn to the limitation of liability, indemnification and jurisdiction issues defined therein. Any holder of this document is advised that information contained hereon reflects the Company's findings at the time of its intervention only and within the limits of Client's instructions, if any. The Company's sole responsibility is to its Client and this document does not exonerate parties to a transaction from exercising all their rights and obligations under the transaction documents. This document cannot be reproduced except in full, without prior written approval of the Company. Any unauthorized alteration, forgery or falsification of the content or appearance of this document is unlawful and offenders may be prosecuted to the fullest extent of the law.

6.4 Test SET-UP

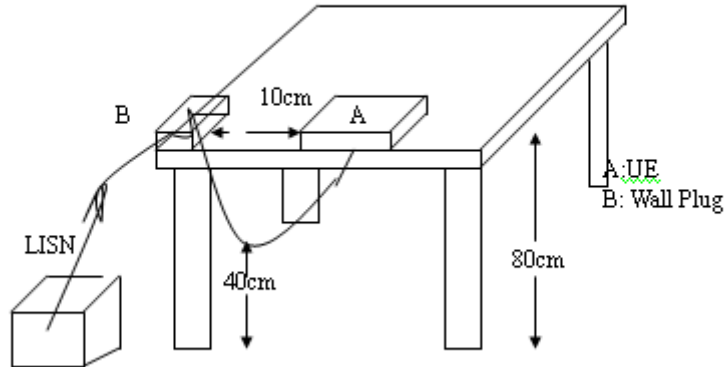

6.5 Measurement Procedure

1. The EUT was placed on a table which is 0.8m above ground plane.
2. Maximum procedure was performed on the six highest emissions to ensure EUT compliance.
3. Repeat above procedures until all phases of power being supplied by given UE are completed.

6.6 Measurement Result

Note: Refer to next page for measurement data and plots.

Note2: The * reveals the worst-case results that closet to the limit.

Unless otherwise stated the results shown in this test report refer only to the sample(s) tested and such sample(s) are retained for 90 days only.

除非另有說明，此報告結果僅對測試之樣品負責，同時此樣品僅保留90天。本報告未經本公司書面許可，不可部份複製。

This document is issued by the Company subject to its General Conditions of Service printed overleaf, available on request or accessible at <http://www.sgs.com.tw/Terms-and-Conditions> and for electronic format documents, subject to Terms and Conditions for Electronic Documents at <http://www.sgs.com.tw/Terms-and-Conditions>. Attention is drawn to the limitation of liability, indemnification and jurisdiction issues defined therein. Any holder of this document is advised that information contained hereon reflects the Company's findings at the time of its intervention only and within the limits of Client's instructions, if any. The Company's sole responsibility is to its Client and this document does not exonerate parties to a transaction from exercising all their rights and obligations under the transaction documents. This document cannot be reproduced except in full, without prior written approval of the Company. Any unauthorized alteration, forgery or falsification of the content or appearance of this document is unlawful and offenders may be prosecuted to the fullest extent of the law.

AC POWER LINE CONDUCTED EMISSION TEST DATA

Report Number :ER-2020-B0047
 Test Mode :WLAN 5G
 Power :AC 120V/60Hz
 Probe :L
 Note :

Test Site :Conduction 6F
 Test Date :2021-01-12
 Temp./Humi. :19.0/49
 Engineer :Ricky

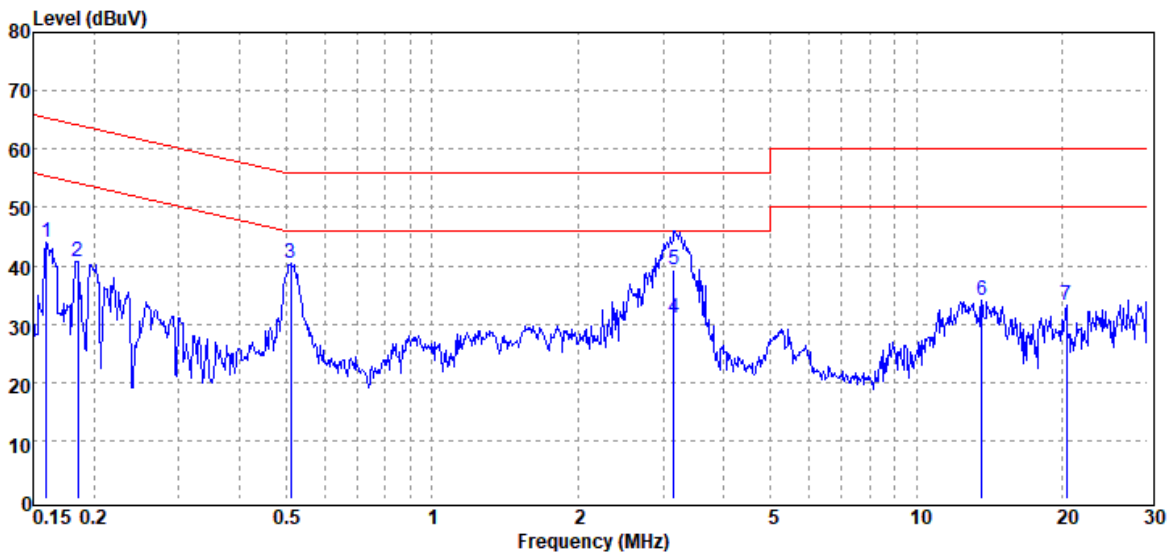

Freq. MHz	Detector Mode PK/QP/AV	Spectrum Reading Level dBµV	Factor dB	Actual FS dBµV	Limit dBµV	Margin dB
0.16	Peak	43.93	0.04	43.97	65.47	-21.50
0.19	Peak	40.59	0.04	40.63	64.24	-23.61
0.51	Peak	40.27	0.16	40.43	56.00	-15.57
3.16	Average	30.63	0.39	31.02	46.00	-14.98
3.16	QP	39.03	0.39	39.42	56.00	-16.58
13.62	Peak	33.19	0.98	34.17	60.00	-25.83
20.38	Peak	31.94	1.20	33.14	60.00	-26.86

Unless otherwise stated the results shown in this test report refer only to the sample(s) tested and such sample(s) are retained for 90 days only.

除非另有說明，此報告結果僅對測試之樣品負責，同時此樣品僅保留90天。本報告未經本公司書面許可，不可部份複製。

This document is issued by the Company subject to its General Conditions of Service printed overleaf, available on request or accessible at <http://www.sgs.com.tw/Terms-and-Conditions> and for electronic format documents, subject to Terms and Conditions for Electronic Documents at <http://www.sgs.com.tw/Terms-and-Conditions>. Attention is drawn to the limitation of liability, indemnification and jurisdiction issues defined therein. Any holder of this document is advised that information contained hereon reflects the Company's findings at the time of its intervention only and within the limits of Client's instructions, if any. The Company's sole responsibility is to its Client and this document does not exonerate parties to a transaction from exercising all their rights and obligations under the transaction documents. This document cannot be reproduced except in full, without prior written approval of the Company. Any unauthorized alteration, forgery or falsification of the content or appearance of this document is unlawful and offenders may be prosecuted to the fullest extent of the law.

Report Number :ER-2020-B0047
 Test Mode :WLAN 5G
 Power :AC 120V/60Hz
 Probe :N
 Note: :

Test Site :Conduction 6F
 Test Date :2021-01-12
 Temp./Humi. :19.0/49
 Engineer :Ricky

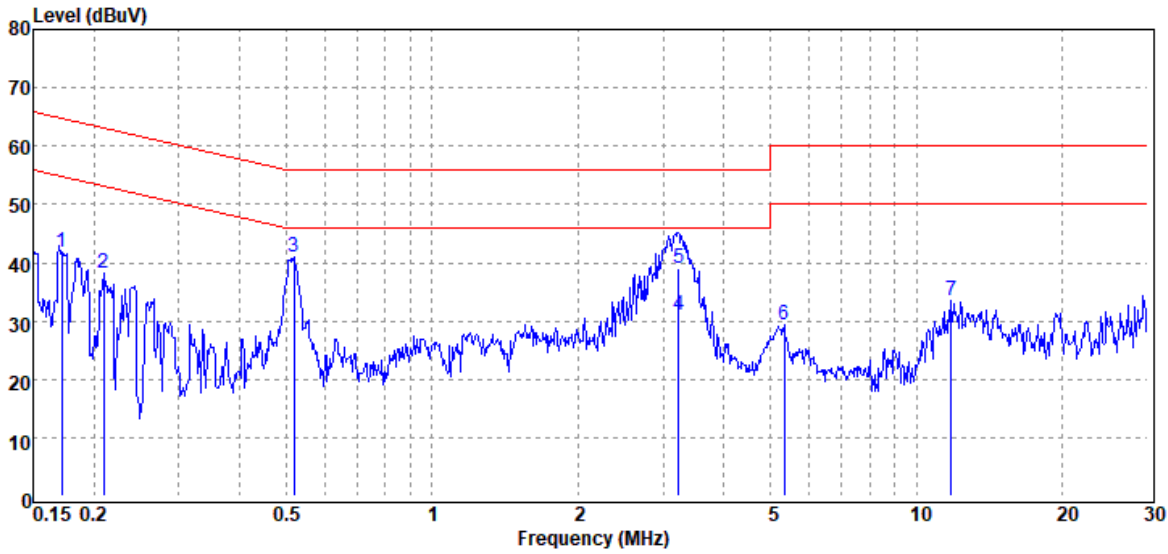

Freq. MHz	Detector Mode PK/QP/AV	Spectrum Reading Level dBμV	Factor dB	Actual FS dBμV	Limit dBμV	Margin dB
0.17	Peak	41.79	0.00	41.79	64.86	-23.07
0.21	Peak	38.17	0.00	38.17	63.23	-25.06
0.52	Peak	40.82	0.09	40.91	56.00	-15.09
3.22	Average	31.02	0.10	31.12	46.00	-14.88
3.22	QP	38.81	0.10	38.91	56.00	-17.09
5.33	Peak	29.35	0.10	29.45	60.00	-30.55
11.81	Peak	33.26	0.12	33.38	60.00	-26.62

Unless otherwise stated the results shown in this test report refer only to the sample(s) tested and such sample(s) are retained for 90 days only.

除非另有說明，此報告結果僅對測試之樣品負責，同時此樣品僅保留90天。本報告未經本公司書面許可，不可部份複製。

This document is issued by the Company subject to its General Conditions of Service printed overleaf, available on request or accessible at <http://www.sgs.com.tw/Terms-and-Conditions> and for electronic format documents, subject to Terms and Conditions for Electronic Documents at <http://www.sgs.com.tw/Terms-and-Conditions>. Attention is drawn to the limitation of liability, indemnification and jurisdiction issues defined therein. Any holder of this document is advised that information contained hereon reflects the Company's findings at the time of its intervention only and within the limits of Client's instructions, if any. The Company's sole responsibility is to its Client and this document does not exonerate parties to a transaction from exercising all their rights and obligations under the transaction documents. This document cannot be reproduced except in full, without prior written approval of the Company. Any unauthorized alteration, forgery or falsification of the content or appearance of this document is unlawful and offenders may be prosecuted to the fullest extent of the law.

7 DUTY CYCLE TEST SIGNAL

Pre-analysis Check: While conducting average power measurement, duty cycle of each mode shall be checked to ensure its duty cycle in order to compensate for the loss due to insufficient ratio of duty cycle. All duty cycle is pre-scanned, and result as obtained below shows only the most representative ones where duty cycle is conducted as the given transmission with given virtual operation that expresses the percentage.

7.1 Measurement Procedure:

1. Set span = Zero
2. RBW = 8MHz
3. VBW = 8MHz,
4. Detector = Peak

Duty Cycle:

Mode	Duty Cycle (%) =Ton / (Ton+Toff)	Duty Factor (dB) =10*log (1/Duty Cycle)	1/T (kHz)	VBW setting (kHz)
802.11a	99.00	0.04	0.51	0.01
802.11n_20	100.00	0.00	0.00	0.01
802.11ac_20	100.00	0.00	0.00	0.01
802.11n_40	100.00	0.00	0.00	0.01
802.11ac_40	100.00	0.00	0.00	0.01
802.11ac_80	100.00	0.00	0.00	0.01
802.11ax_20	100.00	0.00	0.00	0.01
802.11ax_40	100.00	0.00	0.00	0.01
802.11ax_80	100.00	0.00	0.00	0.01

Unless otherwise stated the results shown in this test report refer only to the sample(s) tested and such sample(s) are retained for 90 days only.

除非另有說明，此報告結果僅對測試之樣品負責，同時此樣品僅保留90天。本報告未經本公司書面許可，不可部份複製。

This document is issued by the Company subject to its General Conditions of Service printed overleaf, available on request or accessible at <http://www.sgs.com.tw/Terms-and-Conditions> and for electronic format documents, subject to Terms and Conditions for Electronic Documents at <http://www.sgs.com.tw/Terms-and-Conditions>. Attention is drawn to the limitation of liability, indemnification and jurisdiction issues defined therein. Any holder of this document is advised that information contained hereon reflects the Company's findings at the time of its intervention only and within the limits of Client's instructions, if any. The Company's sole responsibility is to its Client and this document does not exonerate parties to a transaction from exercising all their rights and obligations under the transaction documents. This document cannot be reproduced except in full, without prior written approval of the Company. Any unauthorized alteration, forgery or falsification of the content or appearance of this document is unlawful and offenders may be prosecuted to the fullest extent of the law.

7.2 DUTY CYCLE TEST SIGNAL MEASUREMENT RESULT

802.11a_20MHz_Chain0_5180MHz

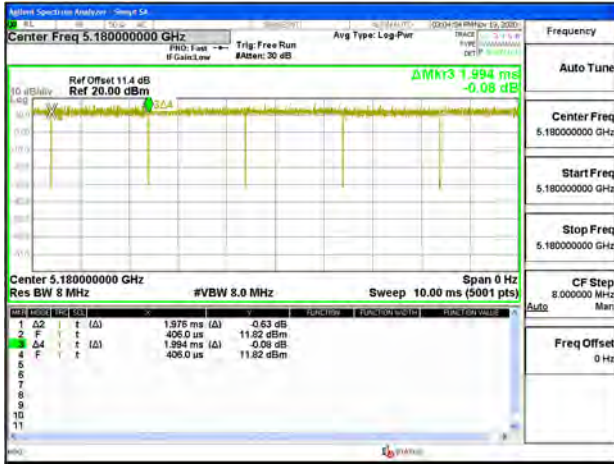

802.11ac_20MHz_Chain0_5180MHz



802.11n_20MHz_Chain0_5180MHz



802.11ac_40MHz_Chain0_5190MHz



802.11n_40MHz_Chain0_5190MHz

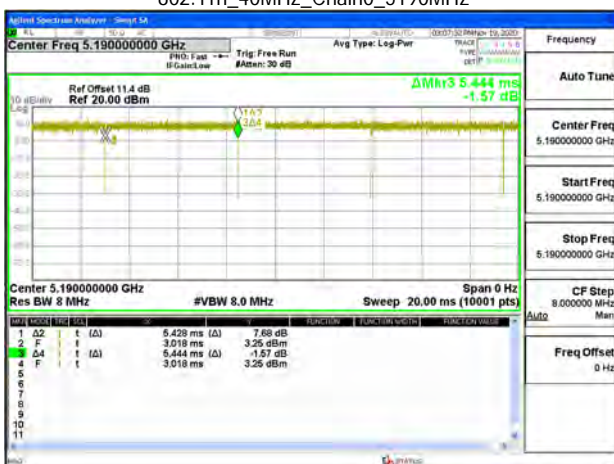

802.11ac_80MHz_Chain0_5210MHz



Unless otherwise stated the results shown in this test report refer only to the sample(s) tested and such sample(s) are retained for 90 days only.

除非另有說明，此報告結果僅對測試之樣品負責，同時此樣品僅保留90天。本報告未經本公司書面許可，不可部份複製。

This document is issued by the Company subject to its General Conditions of Service printed overleaf, available on request or accessible at <http://www.sgs.com.tw/Terms-and-Conditions> and for electronic format documents, subject to Terms and Conditions for Electronic Documents at <http://www.sgs.com.tw/Terms-and-Conditions>. Attention is drawn to the limitation of liability, indemnification and jurisdiction issues defined therein. Any holder of this document is advised that information contained hereon reflects the Company's findings at the time of its intervention only and within the limits of Client's instructions, if any. The Company's sole responsibility is to its Client and this document does not exonerate parties to a transaction from exercising all their rights and obligations under the transaction documents. This document cannot be reproduced except in full, without prior written approval of the Company. Any unauthorized alteration, forgery or falsification of the content or appearance of this document is unlawful and offenders may be prosecuted to the fullest extent of the law.

802.11ax_20MHz_Chain0_5180MHz

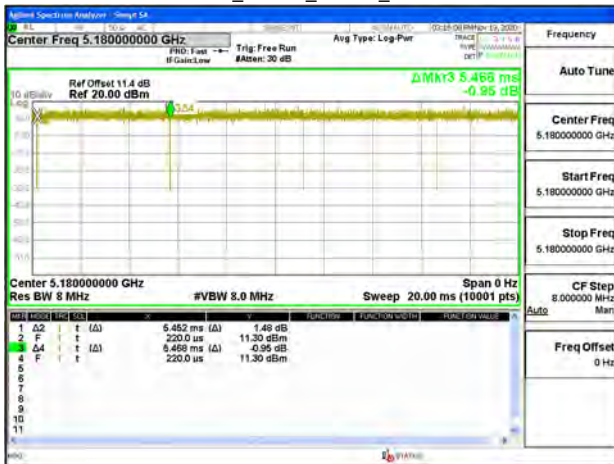

802.11ax_40MHz_Chain0_5190MHz



802.11ax_80MHz_Chain0_5210MHz

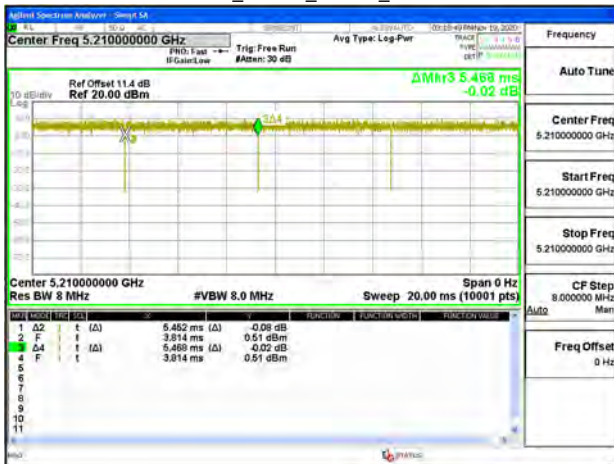

Unless otherwise stated the results shown in this test report refer only to the sample(s) tested and such sample(s) are retained for 90 days only.

除非另有說明，此報告結果僅對測試之樣品負責，同時此樣品僅保留90天。本報告未經本公司書面許可，不可部份複製。

This document is issued by the Company subject to its General Conditions of Service printed overleaf, available on request or accessible at <http://www.sgs.com.tw/Terms-and-Conditions> and for electronic format documents, subject to Terms and Conditions for Electronic Documents at <http://www.sgs.com.tw/Terms-and-Conditions>. Attention is drawn to the limitation of liability, indemnification and jurisdiction issues defined therein. Any holder of this document is advised that information contained herein reflects the Company's findings at the time of its intervention only and within the limits of Client's instructions, if any. The Company's sole responsibility is to its Client and this document does not exonerate parties to a transaction from exercising all their rights and obligations under the transaction documents. This document cannot be reproduced except in full, without prior written approval of the Company. Any unauthorized alteration, forgery or falsification of the content or appearance of this document is unlawful and offenders may be prosecuted to the fullest extent of the law.

8 26DB, 99% & 6DB EMISSION BANDWIDTH MEASUREMENT

8.1 Standard Applicable

There is no limit bandwidth for U-NII-1, U-NII-2-A and U-NII-2-C.
The minimum of 6dB Bandwidth measurement is 0.5 MHz for U-NII-3

8.2 Measurement Procedure

1. Place the EUT on the table and set it in transmitting mode.
2. The testing follows FCC KDB 789033 D02 General UNII Test Procedures New Rules.
3. Remove the antenna from the EUT and then connect a low loss RF cable from the Antenna port to the spectrum analyzer.
 - 3.a. 26dB Band width Measurement: Set the spectrum analyzer as 1% of emission BW
Sweep=auto,
Detector = Peak,
Trace Mode = Max Hold,
Manually readjust RBW until the RBW/EBW ratio is 1% based on EBW as observed on the result of pre-sequence measurement.
 - 3.b. Mark the peak frequency and -26dB (upper and lower) frequency.
4. Repeat the procedures as list above until all test default channels (low, middle, and high) are completed.
5. Minimum Emission Bandwidth for the band 5.725-5.850GHz.
 - a. Set the spectrum analyzer as
RBW = 100 kHz,
VBW = 3*RBW,
Span = 30M/50MHz,
Detector=Peak,
Sweep=auto
 - b. Mark the peak frequency and -6dB (upper and lower) frequency.
6. For 99% Bandwidth: Set the spectrum analyzer as
RBW=1%,
VBW = 3*RBW,
Span = 30M/50MHz,
Detector=Sample,
Sweep=auto.
7. Turn on the 99% bandwidth function, max reading.
8. Repeat above procedures until all frequency of interest measured was complete.

Unless otherwise stated the results shown in this test report refer only to the sample(s) tested and such sample(s) are retained for 90 days only.

除非另有說明，此報告結果僅對測試之樣品負責，同時此樣品僅保留90天。本報告未經本公司書面許可，不可部份複製。

This document is issued by the Company subject to its General Conditions of Service printed overleaf, available on request or accessible at <http://www.sgs.com.tw/Terms-and-Conditions> and for electronic format documents, subject to Terms and Conditions for Electronic Documents at <http://www.sgs.com.tw/Terms-and-Conditions>. Attention is drawn to the limitation of liability, indemnification and jurisdiction issues defined therein. Any holder of this document is advised that information contained hereon reflects the Company's findings at the time of its intervention only and within the limits of Client's instructions, if any. The Company's sole responsibility is to its Client and this document does not exonerate parties to a transaction from exercising all their rights and obligations under the transaction documents. This document cannot be reproduced except in full, without prior written approval of the Company. Any unauthorized alteration, forgery or falsification of the content or appearance of this document is unlawful and offenders may be prosecuted to the fullest extent of the law.

8.3 Measurement Equipment Used

SGS Conducted Room					
Name of Equipment	Manufacturer	Model	Serial Number	Calibration Date	Calibration Due
EXA Spectrum Analyzer	Agilent	N9010A	MY50420195	05/06/2020	05/05/2021
DC Power Supply	Agilent	E3640A	MY52410006	12/17/2020	12/16/2021
DC Power Supply	Agilent	E3640A	KR93300208	08/19/2020	08/18/2021
Attenuator	Mini-Circuit	BW-S10W2+	2	12/16/2020	12/15/2021
DC Block	Mini-Circuits	BLK-18-S+	1	12/16/2020	12/15/2021

8.4 Test Set-up

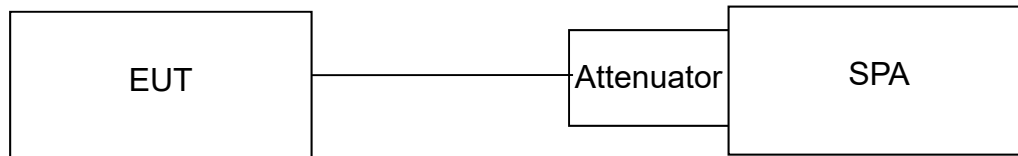

8.5 Measurement Result

8.5.1 FCC 26dB Bandwidth

802.11a_Ch0

Freq. (MHz)	26dB BW (MHz)	10 Log (B) (dB)
5180	18.41	12.650
5220	18.41	12.650
5240	18.46	12.660
5260	18.44	12.660
5300	18.43	12.660
5320	18.23	12.610
5500	18.34	12.630
5580	18.46	12.660
5700	18.49	12.670
5720(U-NII 2C)	14.20	11.520
5720(U-NII 3)	4.20	6.230

Unless otherwise stated the results shown in this test report refer only to the sample(s) tested and such sample(s) are retained for 90 days only.

除非另有說明，此報告結果僅對測試之樣品負責，同時此樣品僅保留90天。本報告未經本公司書面許可，不可部份複製。

This document is issued by the Company subject to its General Conditions of Service printed overleaf, available on request or accessible at <http://www.sgs.com.tw/Terms-and-Conditions> and for electronic format documents, subject to Terms and Conditions for Electronic Documents at <http://www.sgs.com.tw/Terms-and-Conditions>. Attention is drawn to the limitation of liability, indemnification and jurisdiction issues defined therein. Any holder of this document is advised that information contained hereon reflects the Company's findings at the time of its intervention only and within the limits of Client's instructions, if any. The Company's sole responsibility is to its Client and this document does not exonerate parties to a transaction from exercising all their rights and obligations under the transaction documents. This document cannot be reproduced except in full, without prior written approval of the Company. Any unauthorized alteration, forgery or falsification of the content or appearance of this document is unlawful and offenders may be prosecuted to the fullest extent of the law.

802.11n_HT20_Ch0

Freq. (MHz)	26dB BW (MHz)	10 Log (B) (dB)
5180	19.70	12.940
5220	19.53	12.910
5240	19.57	12.920
5260	19.69	12.940
5300	19.56	12.910
5320	19.61	12.920
5500	19.66	12.940
5580	19.62	12.930
5700	19.45	12.890
5720(U-NII 2C)	14.88	11.720
5720(U-NII 3)	4.88	6.880

802.11n_HT20_Ch1

Freq. (MHz)	26dB BW (MHz)	10 Log (B) (dB)
5180	19.52	12.900
5220	19.67	12.940
5240	19.83	12.970
5260	19.60	12.920
5300	19.65	12.930
5320	19.62	12.930
5500	19.59	12.920
5580	19.70	12.940
5700	19.79	12.960
5720(U-NII 2C)	14.77	11.700
5720(U-NII 3)	4.77	6.790

802.11n_HT40_Ch0

Freq. (MHz)	26dB BW (MHz)	10 Log (B) (dB)
5190	39.21	15.930
5230	38.84	15.890
5270	39.30	15.940
5310	39.18	15.930
5510	39.16	15.930
5550	39.23	15.940
5670	39.00	15.910
5710(U-NII 2C)	34.65	15.400
5710(U-NII 3)	4.65	6.680

802.11n_HT40_Ch1

Freq. (MHz)	26dB BW (MHz)	10 Log (B) (dB)
5190	39.26	15.940
5230	39.06	15.920
5270	38.93	15.900
5310	38.70	15.880
5510	38.76	15.880
5550	39.23	15.940
5670	38.55	15.860
5710(U-NII 2C)	34.33	15.360
5710(U-NII 3)	4.33	6.360

802.11ac_VHT80_Ch0

Freq. (MHz)	26dB BW (MHz)	10 Log (B) (dB)
5210	81.10	19.090
5290	80.45	19.060
5530	80.67	19.070
5610	81.26	19.100
5690(U-NII 2C)	75.48	18.780
5690(U-NII 3)	5.48	7.390

802.11ac_VHT80_Ch1

Freq. (MHz)	26dB BW (MHz)	10 Log (B) (dB)
5210	80.34	19.050
5290	80.45	19.060
5530	80.38	19.050
5610	80.22	19.040
5690(U-NII 2C)	75.36	18.770
5690(U-NII 3)	5.36	7.290

Unless otherwise stated the results shown in this test report refer only to the sample(s) tested and such sample(s) are retained for 90 days only.

除非另有說明，此報告結果僅對測試之樣品負責，同時此樣品僅保留90天。本報告未經本公司書面許可，不可部份複製。

This document is issued by the Company subject to its General Conditions of Service printed overleaf, available on request or accessible at <http://www.sgs.com.tw/Terms-and-Conditions> and for electronic format documents, subject to Terms and Conditions for Electronic Documents at <http://www.sgs.com.tw/Terms-and-Conditions>. Attention is drawn to the limitation of liability, indemnification and jurisdiction issues defined therein. Any holder of this document is advised that information contained hereon reflects the Company's findings at the time of its intervention only and within the limits of Client's instructions, if any. The Company's sole responsibility is to its Client and this document does not exonerate parties to a transaction from exercising all their rights and obligations under the transaction documents. This document cannot be reproduced except in full, without prior written approval of the Company. Any unauthorized alteration, forgery or falsification of the content or appearance of this document is unlawful and offenders may be prosecuted to the fullest extent of the law.

802.11ax_20_Ch0

Freq. (MHz)	RU config	26dB BW (MHz)	10 Log (B) (dB)
5180	full	20.33	13.080
5220	full	20.22	13.060
5240	full	20.30	13.070
5260	full	20.24	13.060
5300	full	20.57	13.130
5320	full	20.41	13.100
5500	full	20.48	13.110
5580	full	20.48	13.110
5700	full	20.46	13.110
5720(U-NII 2C)	full	15.15	11.800
5720(U-NII 3)	full	5.15	7.110

802.11ax_20_Ch1

Freq. (MHz)	RU config	26dB BW (MHz)	10 Log (B) (dB)
5180	full	20.27	13.070
5220	full	20.55	13.130
5240	full	20.25	13.060
5260	full	20.66	13.150
5300	full	20.27	13.070
5320	full	20.46	13.110
5500	full	20.53	13.120
5580	full	20.39	13.090
5700	full	20.35	13.090
5720(U-NII 2C)	full	15.20	11.820
5720(U-NII 3)	full	5.20	7.160

802.11ax_40_Ch0

Freq. (MHz)	RU config	26dB BW (MHz)	10 Log (B) (dB)
5190	full	40.17	16.040
5230	full	39.83	16.000
5270	full	39.82	16.000
5310	full	39.83	16.000
5510	full	39.96	16.020
5550	full	40.05	16.030
5670	full	40.03	16.020
5710(U-NII 2C)	full	35.10	15.450
5710(U-NII 3)	full	5.10	7.080

802.11ax_40_Ch1

Freq. (MHz)	RU config	26dB BW (MHz)	10 Log (B) (dB)
5190	full	39.83	16.000
5230	full	39.79	16.000
5270	full	39.91	16.010
5310	full	39.97	16.020
5510	full	40.00	16.020
5550	full	39.80	16.000
5670	full	39.90	16.010
5710(U-NII 2C)	full	34.87	15.420
5710(U-NII 3)	full	4.87	6.880

Unless otherwise stated the results shown in this test report refer only to the sample(s) tested and such sample(s) are retained for 90 days only.

除非另有說明，此報告結果僅對測試之樣品負責，同時此樣品僅保留90天。本報告未經本公司書面許可，不可部份複製。

This document is issued by the Company subject to its General Conditions of Service printed overleaf, available on request or accessible at <http://www.sgs.com.tw/Terms-and-Conditions> and for electronic format documents, subject to Terms and Conditions for Electronic Documents at <http://www.sgs.com.tw/Terms-and-Conditions>. Attention is drawn to the limitation of liability, indemnification and jurisdiction issues defined therein. Any holder of this document is advised that information contained hereon reflects the Company's findings at the time of its intervention only and within the limits of Client's instructions, if any. The Company's sole responsibility is to its Client and this document does not exonerate parties to a transaction from exercising all their rights and obligations under the transaction documents. This document cannot be reproduced except in full, without prior written approval of the Company. Any unauthorized alteration, forgery or falsification of the content or appearance of this document is unlawful and offenders may be prosecuted to the fullest extent of the law.

802.11ax_80_Ch0

Freq. (MHz)	RU config	26dB BW (MHz)	10 Log (B) (dB)
5210	full	81.68	19.120
5290	full	81.37	19.100
5530	full	81.35	19.100
5610	full	80.90	19.080
5690(U-NII 2C)	full	75.76	18.790
5690(U-NII 3)	full	5.76	7.600

802.11ax_80_Ch1

Freq. (MHz)	RU config	26dB BW (MHz)	10 Log (B) (dB)
5210	full	81.03	19.090
5290	full	81.00	19.080
5530	full	80.72	19.070
5610	full	81.01	19.090
5690(U-NII 2C)	full	75.40	18.770
5690(U-NII 3)	full	5.40	7.320

8.5.2 6dB Bandwidth (5725 MHz~ 5850 MHz) measure with Peak detector for FCC

802.11a_Ch0

Freq. (MHz)	6dB BW (MHz)	10 Log (B) (dB)
5745	16.33	12.130
5785	16.34	12.130
5825	16.33	12.130

802.11n_HT20_Ch0

Freq. (MHz)	6dB BW (MHz)	10 Log (B) (dB)
5745	17.58	12.450
5785	17.54	12.440
5825	16.92	12.280

802.11n_HT20_Ch1

Freq. (MHz)	6dB BW (MHz)	10 Log (B) (dB)
5745	17.58	12.450
5785	17.56	12.450
5825	17.54	12.440

802.11n_HT40_Ch0

Freq. (MHz)	6dB BW (MHz)	10 Log (B) (dB)
5755	35.45	15.500
5795	34.44	15.370

802.11n_HT40_Ch1

Freq. (MHz)	6dB BW (MHz)	10 Log (B) (dB)
5755	34.68	15.400
5795	36.37	15.610

802.11ac_VHT80_Ch0

Freq. (MHz)	6dB BW (MHz)	10 Log (B) (dB)
5775	73.85	18.680

802.11ac_VHT80_Ch1

Freq. (MHz)	6dB BW (MHz)	10 Log (B) (dB)
5775	75.12	18.760

Unless otherwise stated the results shown in this test report refer only to the sample(s) tested and such sample(s) are retained for 90 days only.

除非另有說明，此報告結果僅對測試之樣品負責，同時此樣品僅保留90天。本報告未經本公司書面許可，不可部份複製。

This document is issued by the Company subject to its General Conditions of Service printed overleaf, available on request or accessible at <http://www.sgs.com.tw/Terms-and-Conditions> and for electronic format documents, subject to Terms and Conditions for Electronic Documents at <http://www.sgs.com.tw/Terms-and-Conditions>. Attention is drawn to the limitation of liability, indemnification and jurisdiction issues defined therein. Any holder of this document is advised that information contained hereon reflects the Company's findings at the time of its intervention only and within the limits of Client's instructions, if any. The Company's sole responsibility is to its Client and this document does not exonerate parties to a transaction from exercising all their rights and obligations under the transaction documents. This document cannot be reproduced except in full, without prior written approval of the Company. Any unauthorized alteration, forgery or falsification of the content or appearance of this document is unlawful and offenders may be prosecuted to the fullest extent of the law.

802.11ax_20_Ch0

Freq. (MHz)	RU config	6dB BW (MHz)	10 Log (B) (dB)
5745	full	18.74	12.730
5785	full	18.11	12.580
5825	full	17.82	12.510

802.11ax_20_Ch1

Freq. (MHz)	RU config	6dB BW (MHz)	10 Log (B) (dB)
5745	full	17.37	12.400
5785	full	16.66	12.220
5825	full	18.99	12.790

802.11ax_40_Ch0

Freq. (MHz)	RU config	6dB BW (MHz)	10 Log (B) (dB)
5755	full	36.47	15.620
5795	full	37.18	15.700

802.11ax_40_Ch1

Freq. (MHz)	RU config	6dB BW (MHz)	10 Log (B) (dB)
5755	full	37.62	15.750
5795	full	37.15	15.700

802.11ax_80_Ch0

Freq. (MHz)	RU config	6dB BW (MHz)	10 Log (B) (dB)
5775	full	76.42	18.830

802.11ax_80_Ch1

Freq. (MHz)	RU config	6dB BW (MHz)	10 Log (B) (dB)
5775	full	75.74	18.790

Unless otherwise stated the results shown in this test report refer only to the sample(s) tested and such sample(s) are retained for 90 days only.

除非另有說明，此報告結果僅對測試之樣品負責，同時此樣品僅保留90天。本報告未經本公司書面許可，不可部份複製。

This document is issued by the Company subject to its General Conditions of Service printed overleaf, available on request or accessible at <http://www.sgs.com.tw/Terms-and-Conditions> and for electronic format documents, subject to Terms and Conditions for Electronic Documents at <http://www.sgs.com.tw/Terms-and-Conditions>. Attention is drawn to the limitation of liability, indemnification and jurisdiction issues defined therein. Any holder of this document is advised that information contained hereon reflects the Company's findings at the time of its intervention only and within the limits of Client's instructions, if any. The Company's sole responsibility is to its Client and this document does not exonerate parties to a transaction from exercising all their rights and obligations under the transaction documents. This document cannot be reproduced except in full, without prior written approval of the Company. Any unauthorized alteration, forgery or falsification of the content or appearance of this document is unlawful and offenders may be prosecuted to the fullest extent of the law.

802.11a_20MHz_Chain0_5180MHz

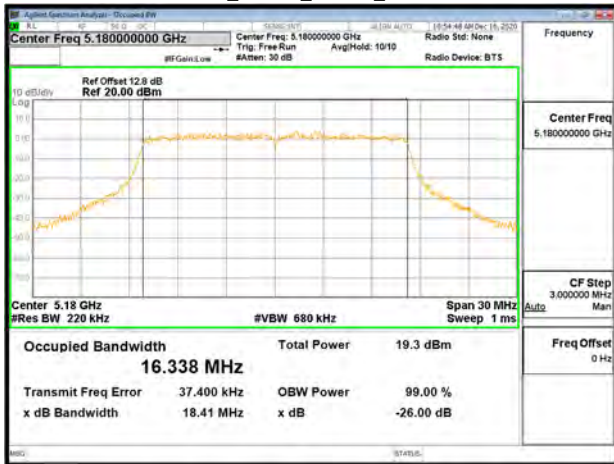

802.11a_20MHz_Chain0_5260MHz

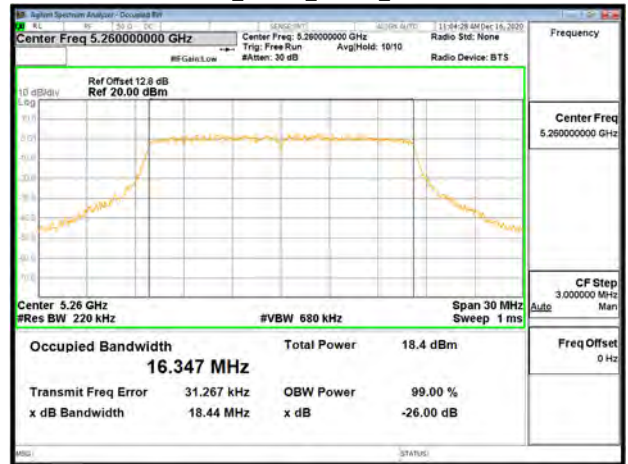

802.11a_20MHz_Chain0_5220MHz

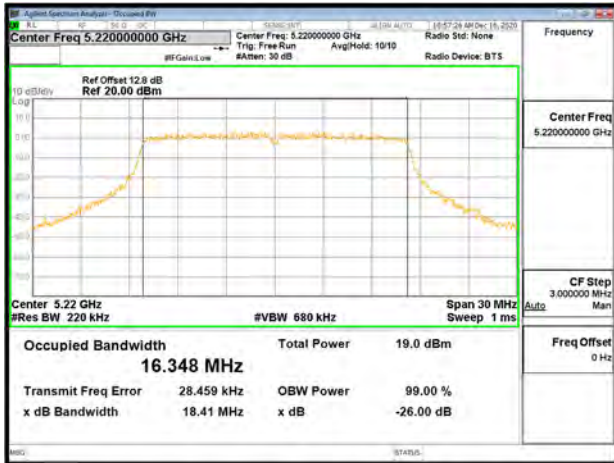

802.11a_20MHz_Chain0_5300MHz

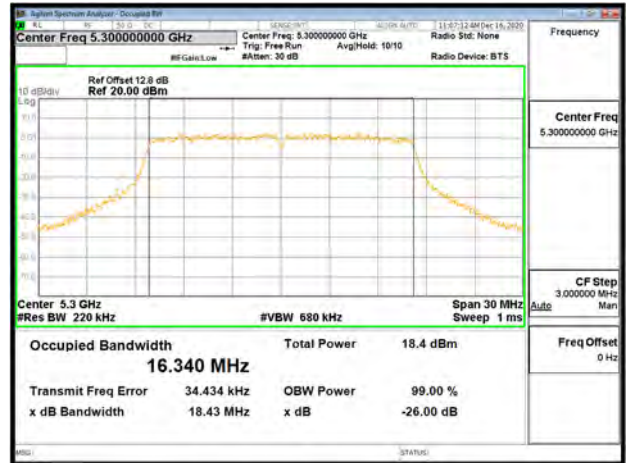

802.11a_20MHz_Chain0_5240MHz

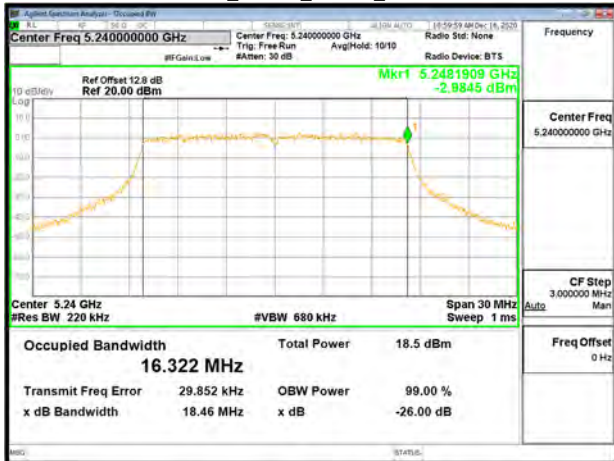

802.11a_20MHz_Chain0_5320MHz

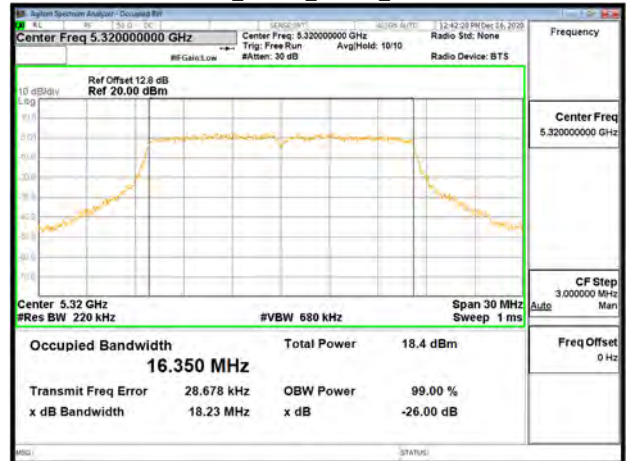

Unless otherwise stated the results shown in this test report refer only to the sample(s) tested and such sample(s) are retained for 90 days only.

除非另有說明，此報告結果僅對測試之樣品負責，同時此樣品僅保留90天。本報告未經本公司書面許可，不可部份複製。

This document is issued by the Company subject to its General Conditions of Service printed overleaf, available on request or accessible at <http://www.sgs.com.tw/Terms-and-Conditions> and for electronic format documents, subject to Terms and Conditions for Electronic Documents at <http://www.sgs.com.tw/Terms-and-Conditions>. Attention is drawn to the limitation of liability, indemnification and jurisdiction issues defined therein. Any holder of this document is advised that information contained hereon reflects the Company's findings at the time of its intervention only and within the limits of Client's instructions, if any. The Company's sole responsibility is to its Client and this document does not exonerate parties to a transaction from exercising all their rights and obligations under the transaction documents. This document cannot be reproduced except in full, without prior written approval of the Company. Any unauthorized alteration, forgery or falsification of the content or appearance of this document is unlawful and offenders may be prosecuted to the fullest extent of the law.

802.11a_20MHz_Chain0_5500MHz

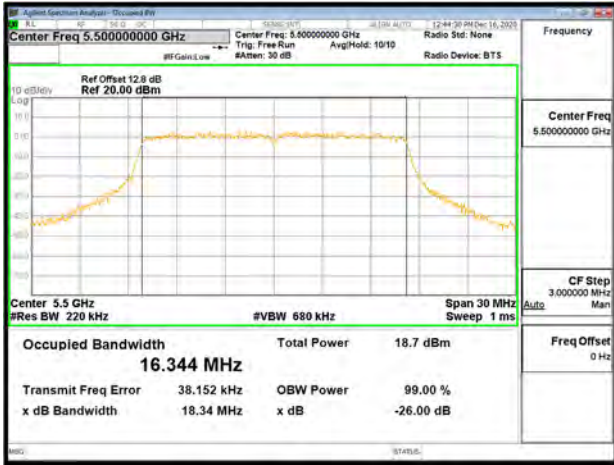

802.11a_20MHz_Chain0_5720MHz

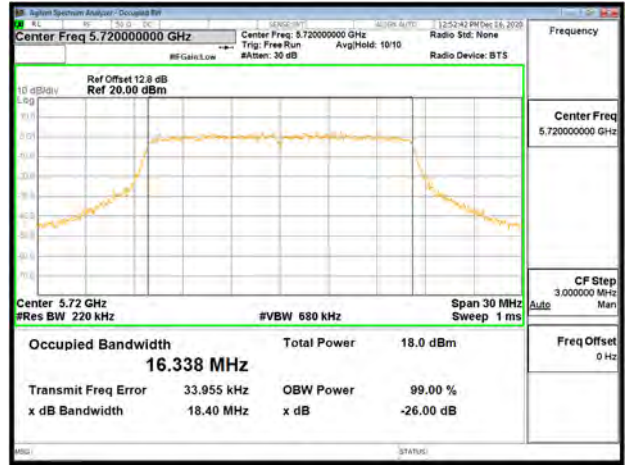

802.11a_20MHz_Chain0_5580MHz

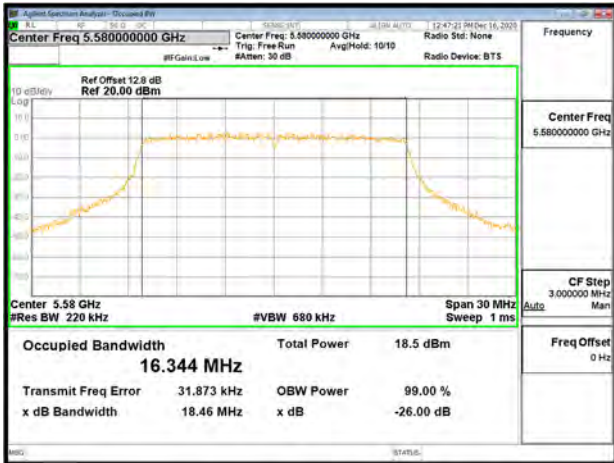

802.11a_20MHz_Chain0_5745MHz

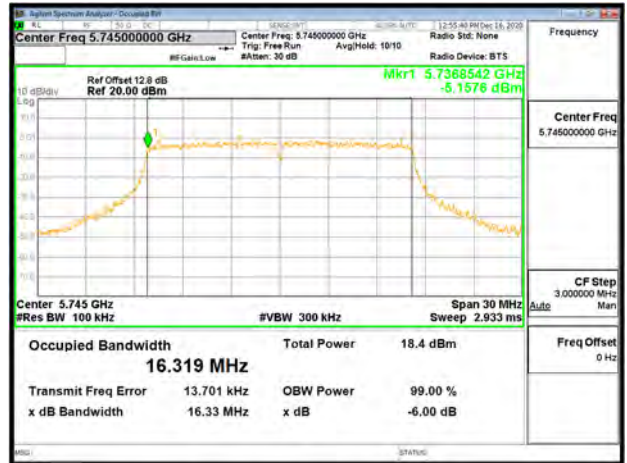

802.11a_20MHz_Chain0_5700MHz

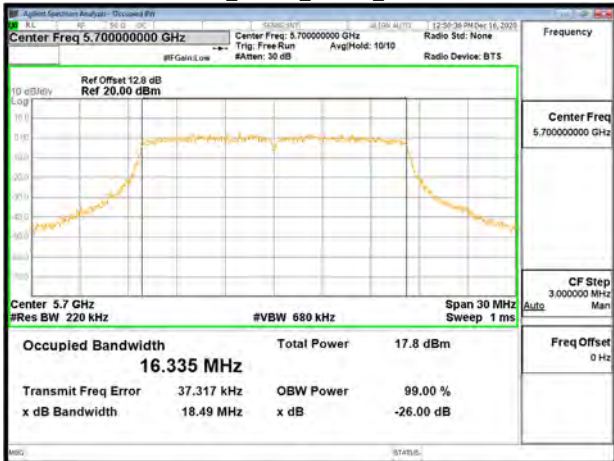

802.11a_20MHz_Chain0_5785MHz

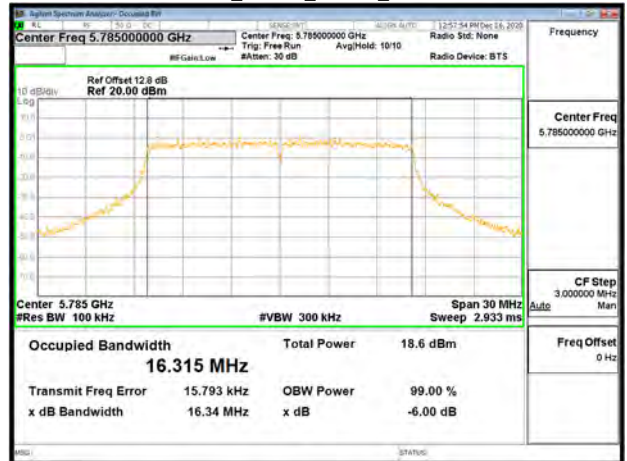

Unless otherwise stated the results shown in this test report refer only to the sample(s) tested and such sample(s) are retained for 90 days only.

除非另有說明，此報告結果僅對測試之樣品負責，同時此樣品僅保留90天。本報告未經本公司書面許可，不可部份複製。

This document is issued by the Company subject to its General Conditions of Service printed overleaf, available on request or accessible at <http://www.sgs.com.tw/Terms-and-Conditions> and for electronic format documents, subject to Terms and Conditions for Electronic Documents at <http://www.sgs.com.tw/Terms-and-Conditions>. Attention is drawn to the limitation of liability, indemnification and jurisdiction issues defined therein. Any holder of this document is advised that information contained hereon reflects the Company's findings at the time of its intervention only and within the limits of Client's instructions, if any. The Company's sole responsibility is to its Client and this document does not exonerate parties to a transaction from exercising all their rights and obligations under the transaction documents. This document cannot be reproduced except in full, without prior written approval of the Company. Any unauthorized alteration, forgery or falsification of the content or appearance of this document is unlawful and offenders may be prosecuted to the fullest extent of the law.

802.11a_20MHz_Chain0_5825MHz

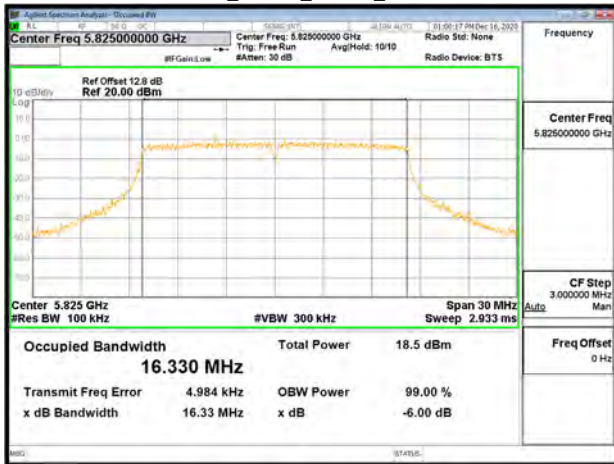

802.11n_20MHz_Chain0_5240MHz

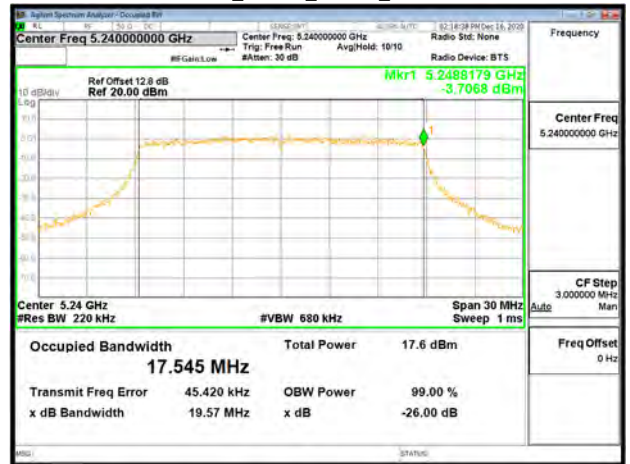

802.11n_20MHz_Chain0_5180MHz

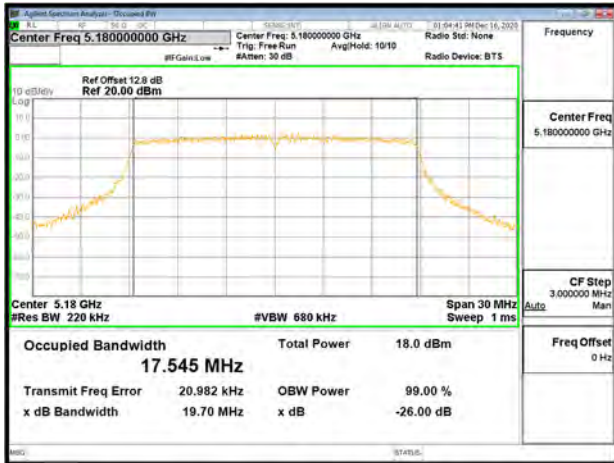

802.11n_20MHz_Chain0_5260MHz

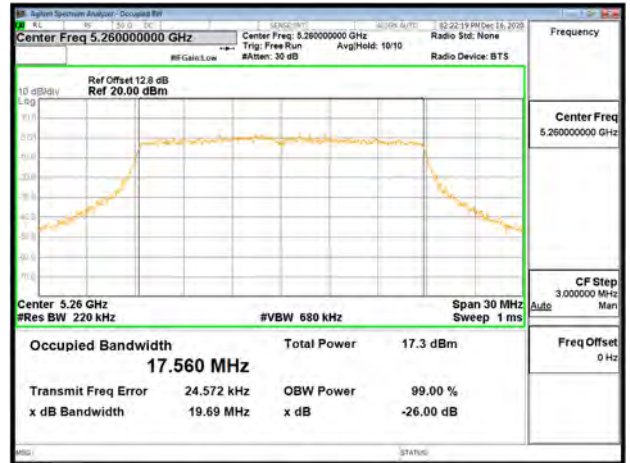

802.11n_20MHz_Chain0_5220MHz

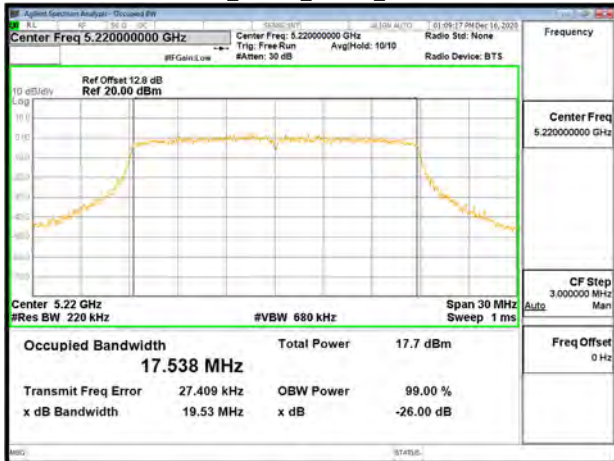

802.11n_20MHz_Chain0_5300MHz

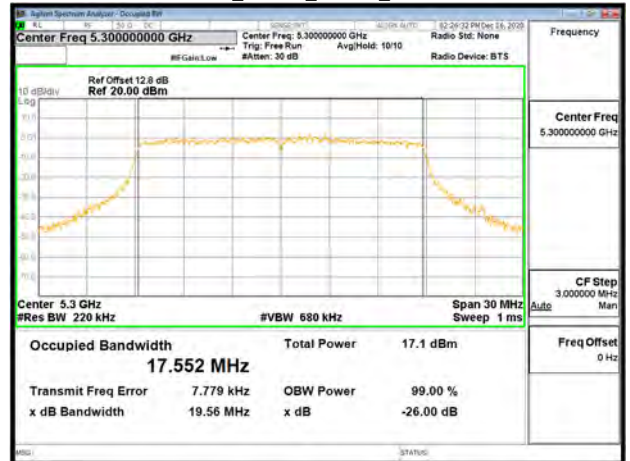

Unless otherwise stated the results shown in this test report refer only to the sample(s) tested and such sample(s) are retained for 90 days only.

除非另有說明，此報告結果僅對測試之樣品負責，同時此樣品僅保留90天。本報告未經本公司書面許可，不可部份複製。

This document is issued by the Company subject to its General Conditions of Service printed overleaf, available on request or accessible at <http://www.sgs.com.tw/Terms-and-Conditions> and for electronic format documents, subject to Terms and Conditions for Electronic Documents at <http://www.sgs.com.tw/Terms-and-Conditions>. Attention is drawn to the limitation of liability, indemnification and jurisdiction issues defined therein. Any holder of this document is advised that information contained hereon reflects the Company's findings at the time of its intervention only and within the limits of Client's instructions, if any. The Company's sole responsibility is to its Client and this document does not exonerate parties to a transaction from exercising all their rights and obligations under the transaction documents. This document cannot be reproduced except in full, without prior written approval of the Company. Any unauthorized alteration, forgery or falsification of the content or appearance of this document is unlawful and offenders may be prosecuted to the fullest extent of the law.

802.11n_20MHz_Chain0_5320MHz

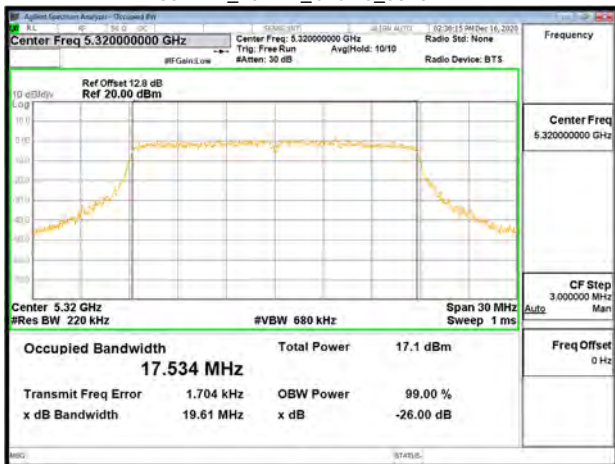

802.11n_20MHz_Chain0_5700MHz

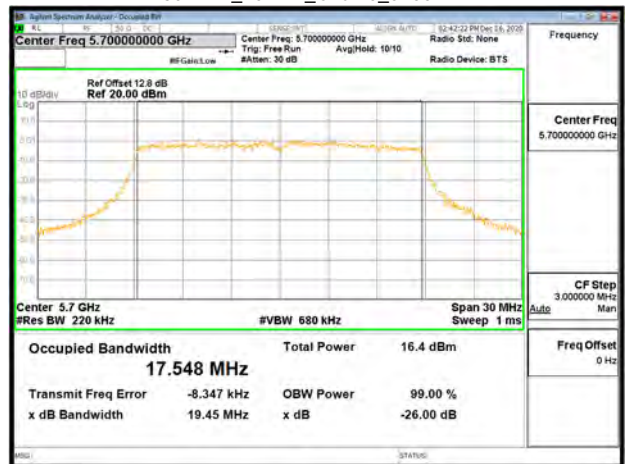

802.11n_20MHz_Chain0_5500MHz

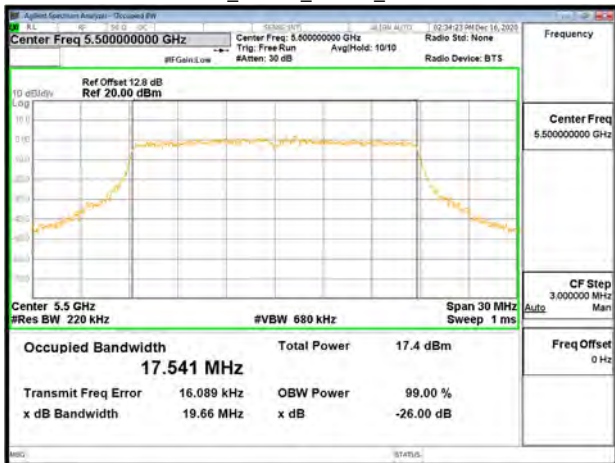

802.11n_20MHz_Chain0_5720MHz

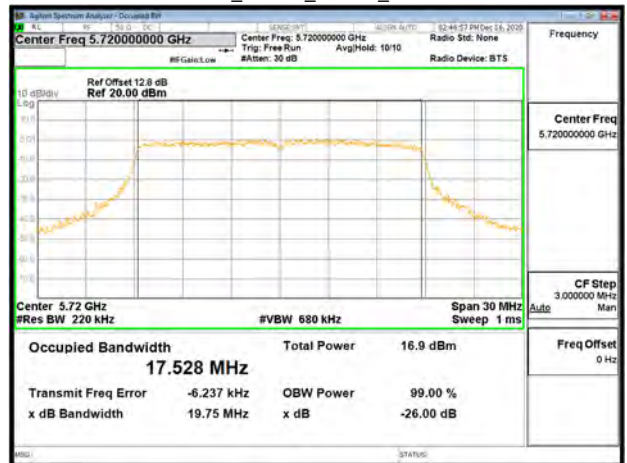

802.11n_20MHz_Chain0_5580MHz

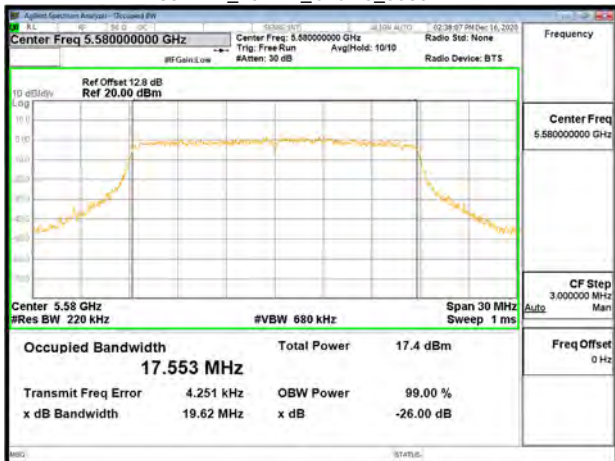

802.11n_20MHz_Chain0_5745MHz

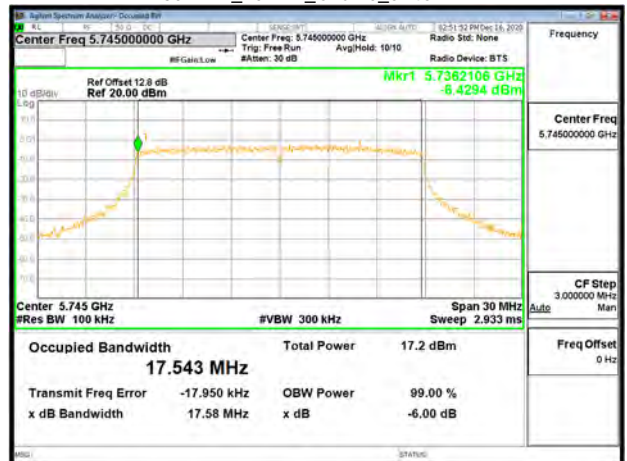

Unless otherwise stated the results shown in this test report refer only to the sample(s) tested and such sample(s) are retained for 90 days only.

除非另有說明，此報告結果僅對測試之樣品負責，同時此樣品僅保留90天。本報告未經本公司書面許可，不可部份複製。

This document is issued by the Company subject to its General Conditions of Service printed overleaf, available on request or accessible at <http://www.sgs.com.tw/Terms-and-Conditions> and for electronic format documents, subject to Terms and Conditions for Electronic Documents at <http://www.sgs.com.tw/Terms-and-Conditions>. Attention is drawn to the limitation of liability, indemnification and jurisdiction issues defined therein. Any holder of this document is advised that information contained hereon reflects the Company's findings at the time of its intervention only and within the limits of Client's instructions, if any. The Company's sole responsibility is to its Client and this document does not exonerate parties to a transaction from exercising all their rights and obligations under the transaction documents. This document cannot be reproduced except in full, without prior written approval of the Company. Any unauthorized alteration, forgery or falsification of the content or appearance of this document is unlawful and offenders may be prosecuted to the fullest extent of the law.

802.11n_20MHz_Chain0_5785MHz

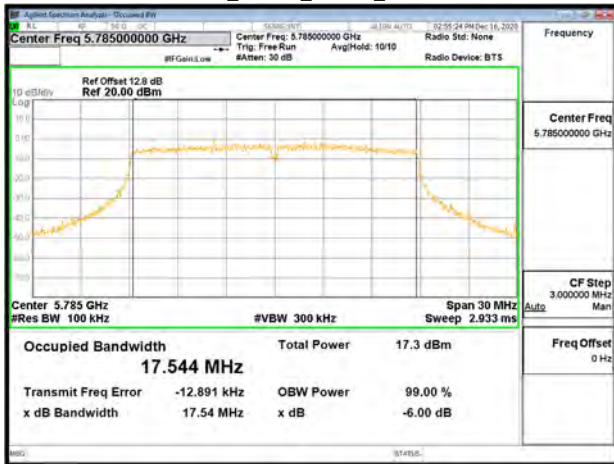

802.11n_20MHz_Chain1_5220MHz

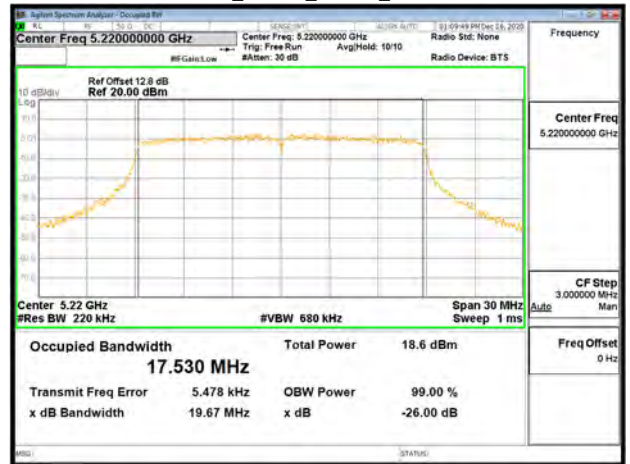

802.11n_20MHz_Chain0_5825MHz

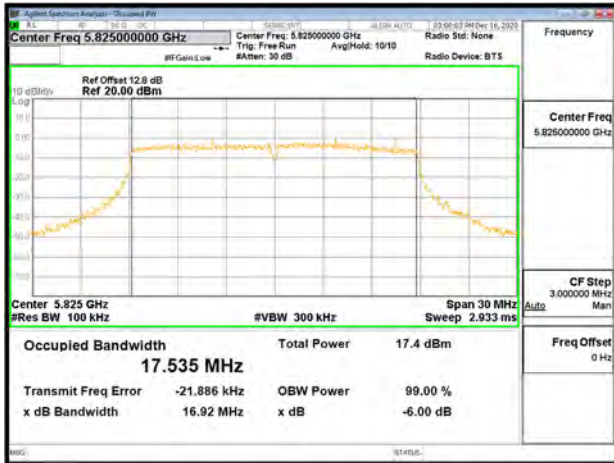

802.11n_20MHz_Chain1_5240MHz

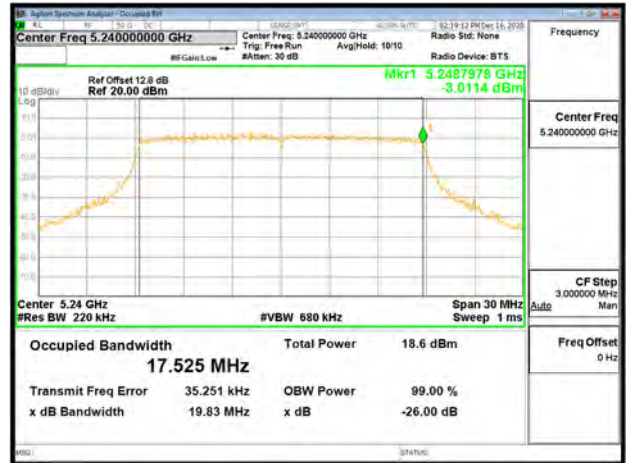

802.11n_20MHz_Chain1_5180MHz

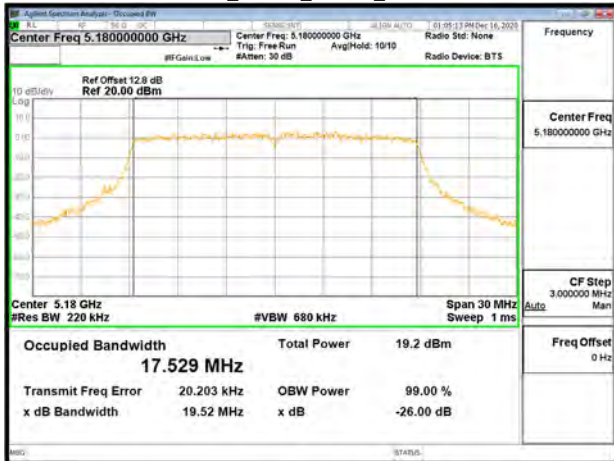

802.11n_20MHz_Chain1_5260MHz

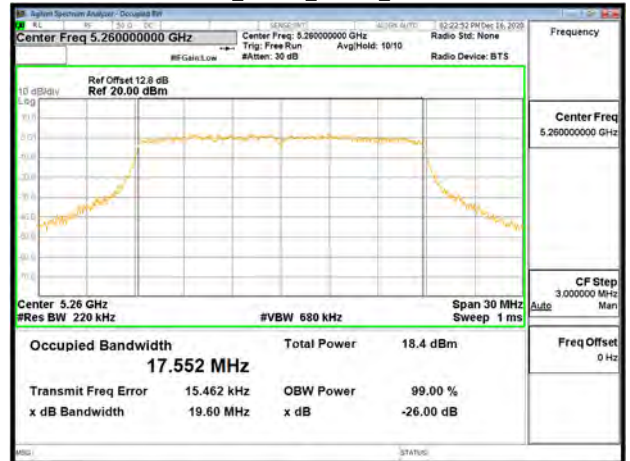

Unless otherwise stated the results shown in this test report refer only to the sample(s) tested and such sample(s) are retained for 90 days only.

除非另有說明，此報告結果僅對測試之樣品負責，同時此樣品僅保留90天。本報告未經本公司書面許可，不可部份複製。

This document is issued by the Company subject to its General Conditions of Service printed overleaf, available on request or accessible at <http://www.sgs.com.tw/Terms-and-Conditions> and for electronic format documents, subject to Terms and Conditions for Electronic Documents at <http://www.sgs.com.tw/Terms-and-Conditions>. Attention is drawn to the limitation of liability, indemnification and jurisdiction issues defined therein. Any holder of this document is advised that information contained hereon reflects the Company's findings at the time of its intervention only and within the limits of Client's instructions, if any. The Company's sole responsibility is to its Client and this document does not exonerate parties to a transaction from exercising all their rights and obligations under the transaction documents. This document cannot be reproduced except in full, without prior written approval of the Company. Any unauthorized alteration, forgery or falsification of the content or appearance of this document is unlawful and offenders may be prosecuted to the fullest extent of the law.

802.11n_20MHz_Chain1_5300MHz

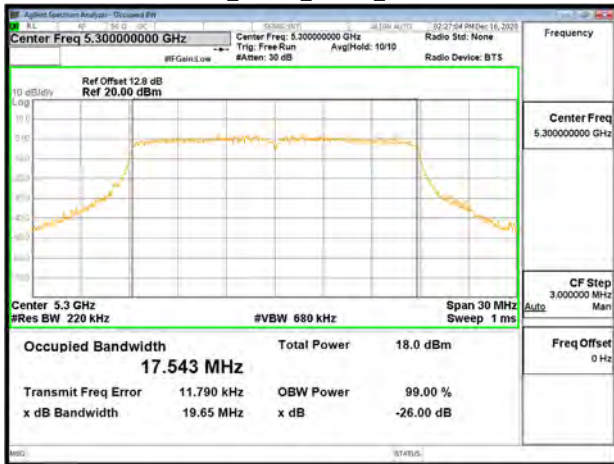

802.11n_20MHz_Chain1_5580MHz

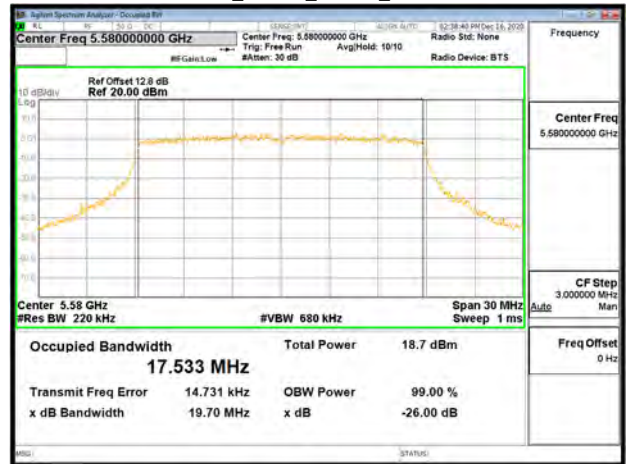

802.11n_20MHz_Chain1_5320MHz

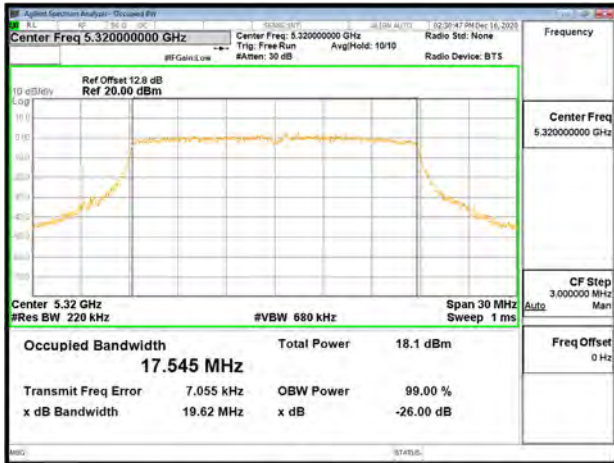

802.11n_20MHz_Chain1_5700MHz

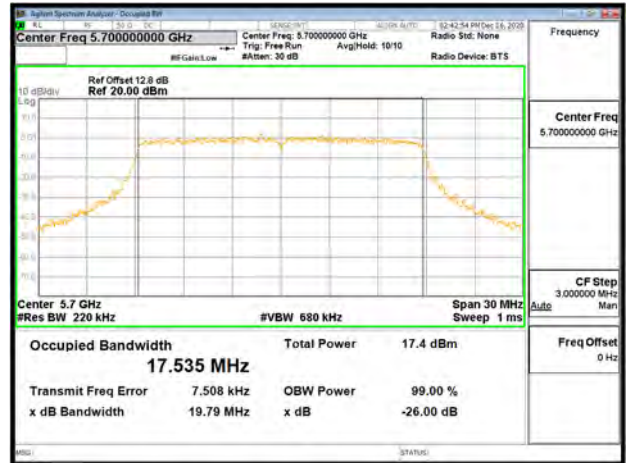

802.11n_20MHz_Chain1_5500MHz

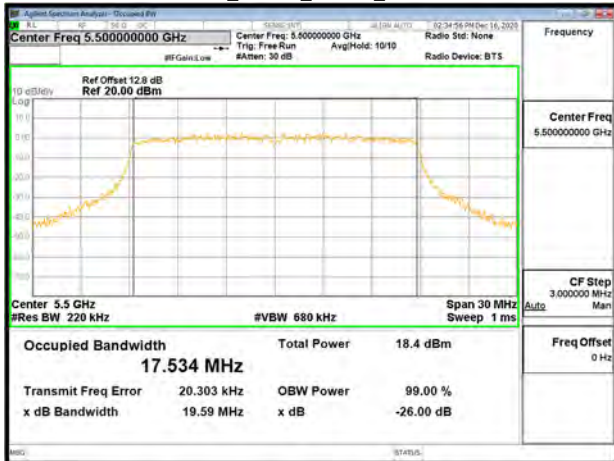

802.11n_20MHz_Chain1_5720MHz

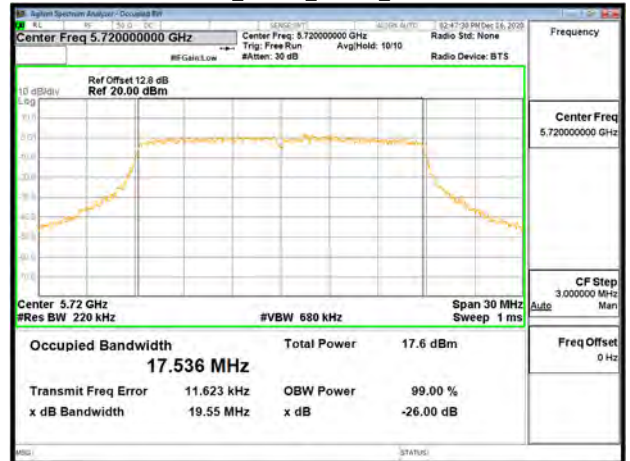

Unless otherwise stated the results shown in this test report refer only to the sample(s) tested and such sample(s) are retained for 90 days only.

除非另有說明，此報告結果僅對測試之樣品負責，同時此樣品僅保留90天。本報告未經本公司書面許可，不可部份複製。

This document is issued by the Company subject to its General Conditions of Service printed overleaf, available on request or accessible at <http://www.sgs.com.tw/Terms-and-Conditions> and for electronic format documents, subject to Terms and Conditions for Electronic Documents at <http://www.sgs.com.tw/Terms-and-Conditions>. Attention is drawn to the limitation of liability, indemnification and jurisdiction issues defined therein. Any holder of this document is advised that information contained hereon reflects the Company's findings at the time of its intervention only and within the limits of Client's instructions, if any. The Company's sole responsibility is to its Client and this document does not exonerate parties to a transaction from exercising all their rights and obligations under the transaction documents. This document cannot be reproduced except in full, without prior written approval of the Company. Any unauthorized alteration, forgery or falsification of the content or appearance of this document is unlawful and offenders may be prosecuted to the fullest extent of the law.

802.11n_20MHz_Chain1_5745MHz

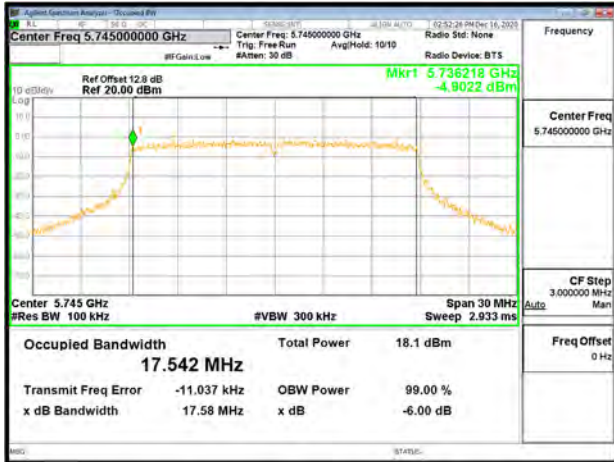

802.11n_40MHz_Chain0_5190MHz

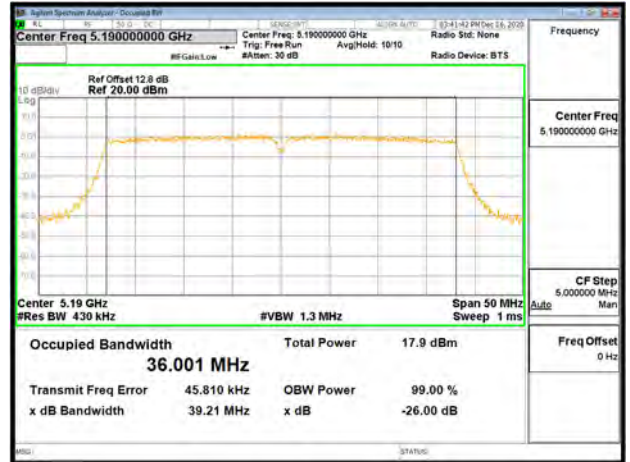

802.11n_20MHz_Chain1_5785MHz

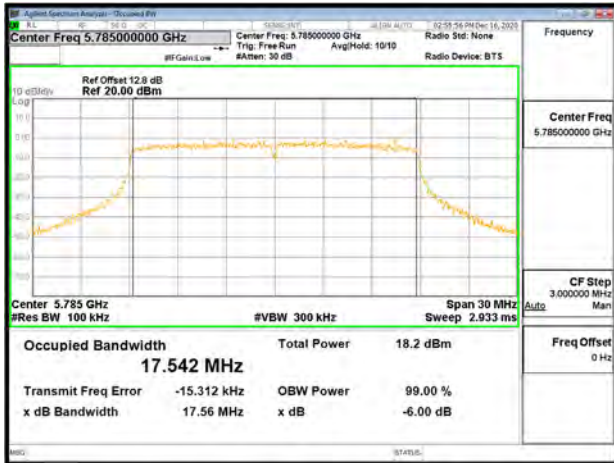

802.11n_40MHz_Chain0_5230MHz

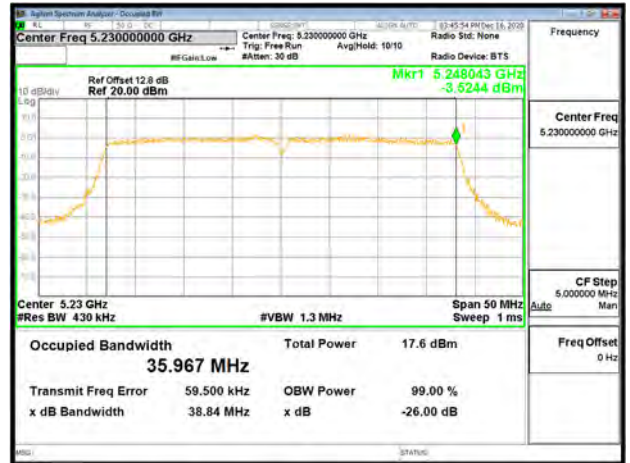

802.11n_20MHz_Chain1_5825MHz

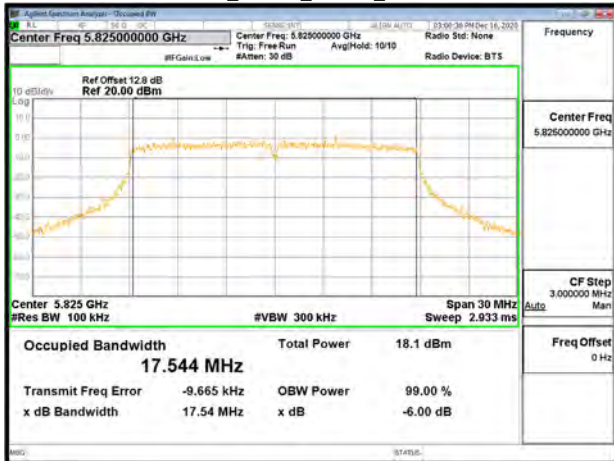

802.11n_40MHz_Chain0_5270MHz

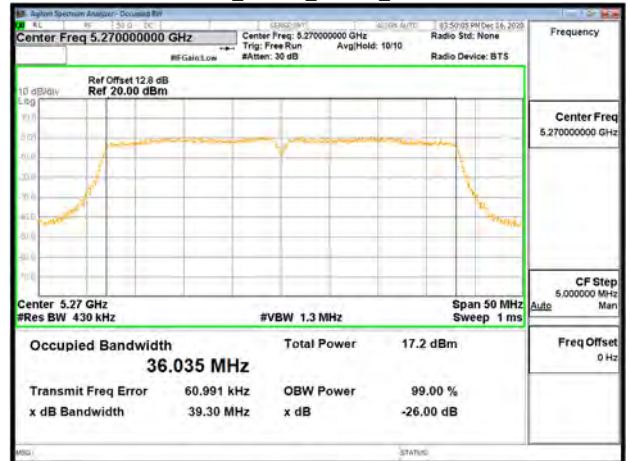

Unless otherwise stated the results shown in this test report refer only to the sample(s) tested and such sample(s) are retained for 90 days only.

除非另有說明，此報告結果僅對測試之樣品負責，同時此樣品僅保留90天。本報告未經本公司書面許可，不可部份複製。

This document is issued by the Company subject to its General Conditions of Service printed overleaf, available on request or accessible at <http://www.sgs.com.tw/Terms-and-Conditions> and for electronic format documents, subject to Terms and Conditions for Electronic Documents at <http://www.sgs.com.tw/Terms-and-Conditions>. Attention is drawn to the limitation of liability, indemnification and jurisdiction issues defined therein. Any holder of this document is advised that information contained hereon reflects the Company's findings at the time of its intervention only and within the limits of Client's instructions, if any. The Company's sole responsibility is to its Client and this document does not exonerate parties to a transaction from exercising all their rights and obligations under the transaction documents. This document cannot be reproduced except in full, without prior written approval of the Company. Any unauthorized alteration, forgery or falsification of the content or appearance of this document is unlawful and offenders may be prosecuted to the fullest extent of the law.

802.11n_40MHz_Chain0_5310MHz

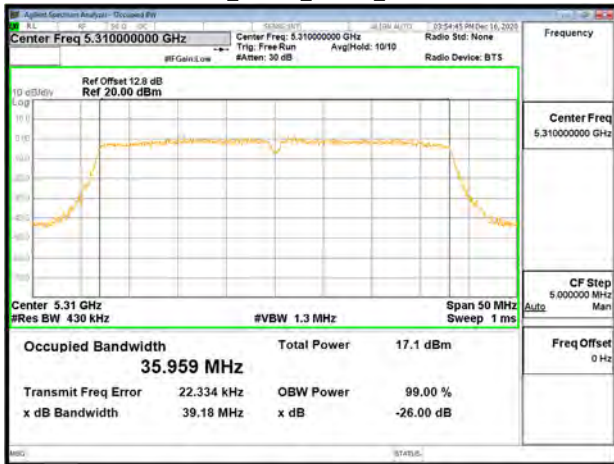

802.11n_40MHz_Chain0_5670MHz

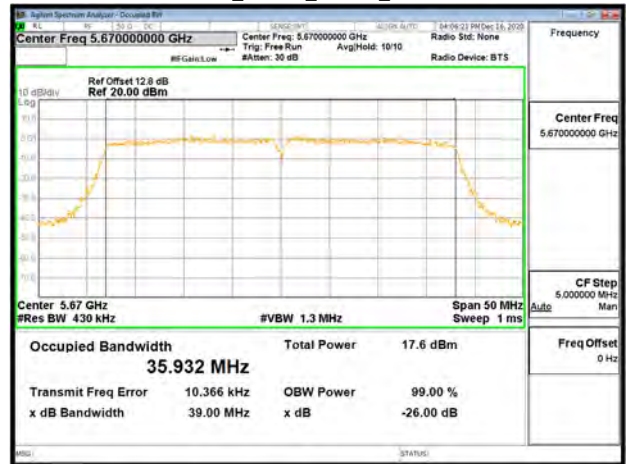

802.11n_40MHz_Chain0_5510MHz

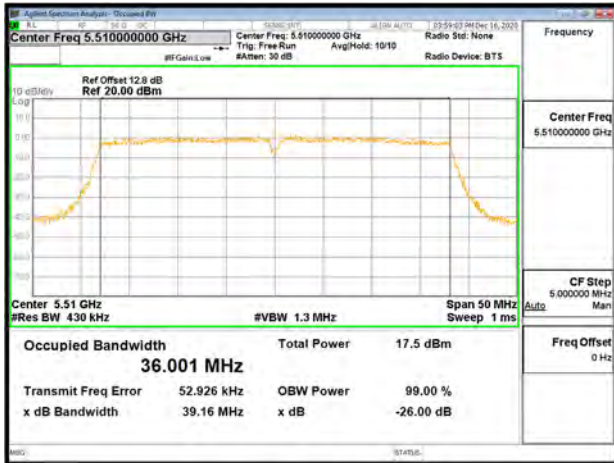

802.11n_40MHz_Chain0_5710MHz

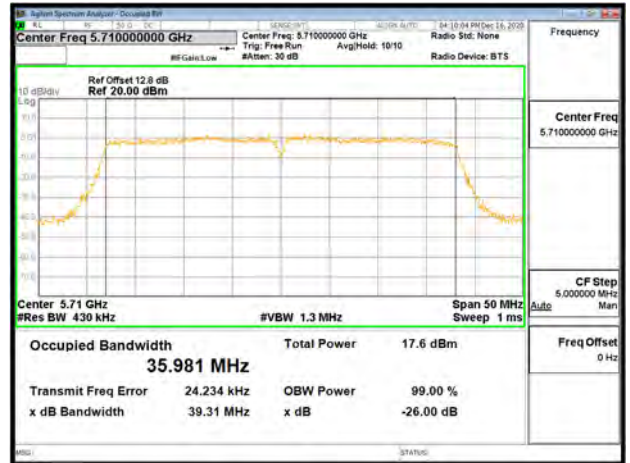

802.11n_40MHz_Chain0_5550MHz

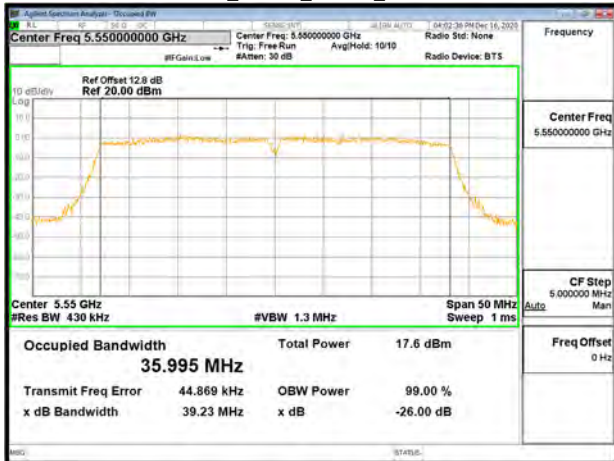

802.11n_40MHz_Chain0_5755MHz

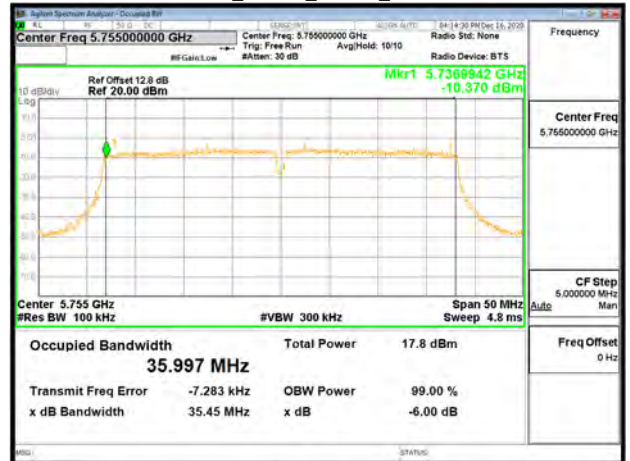

Unless otherwise stated the results shown in this test report refer only to the sample(s) tested and such sample(s) are retained for 90 days only.

除非另有說明，此報告結果僅對測試之樣品負責，同時此樣品僅保留90天。本報告未經本公司書面許可，不可部份複製。

This document is issued by the Company subject to its General Conditions of Service printed overleaf, available on request or accessible at <http://www.sgs.com.tw/Terms-and-Conditions> and for electronic format documents, subject to Terms and Conditions for Electronic Documents at <http://www.sgs.com.tw/Terms-and-Conditions>. Attention is drawn to the limitation of liability, indemnification and jurisdiction issues defined therein. Any holder of this document is advised that information contained hereon reflects the Company's findings at the time of its intervention only and within the limits of Client's instructions, if any. The Company's sole responsibility is to its Client and this document does not exonerate parties to a transaction from exercising all their rights and obligations under the transaction documents. This document cannot be reproduced except in full, without prior written approval of the Company. Any unauthorized alteration, forgery or falsification of the content or appearance of this document is unlawful and offenders may be prosecuted to the fullest extent of the law.

802.11n_40MHz_Chain0_5795MHz

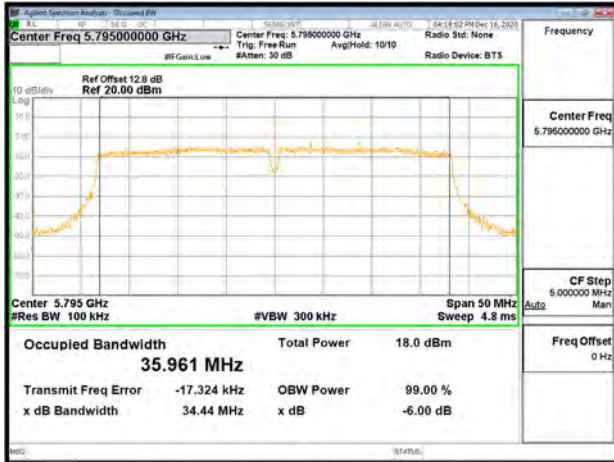

802.11n_40MHz_Chain1_5270MHz

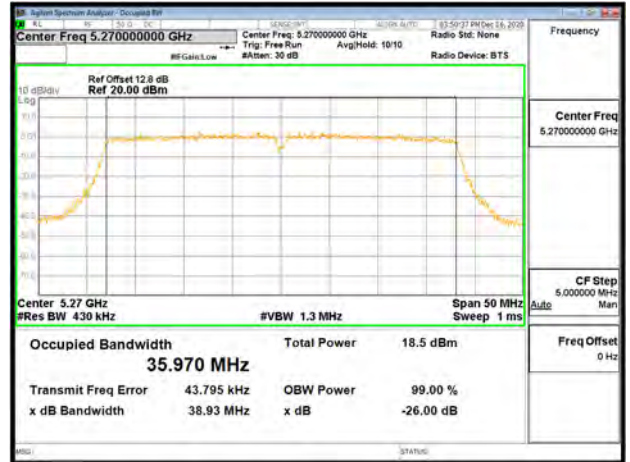

802.11n_40MHz_Chain1_5190MHz

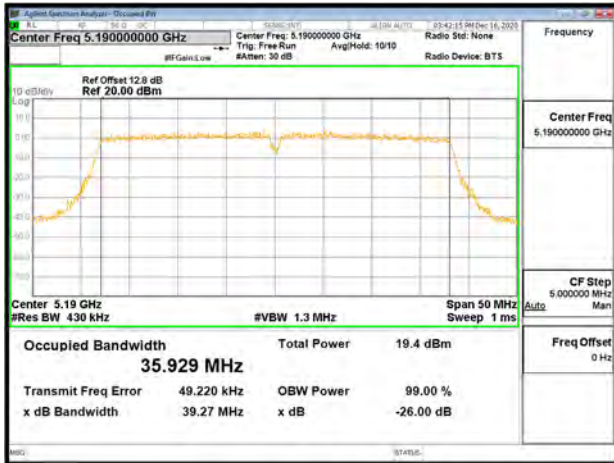

802.11n_40MHz_Chain1_5310MHz

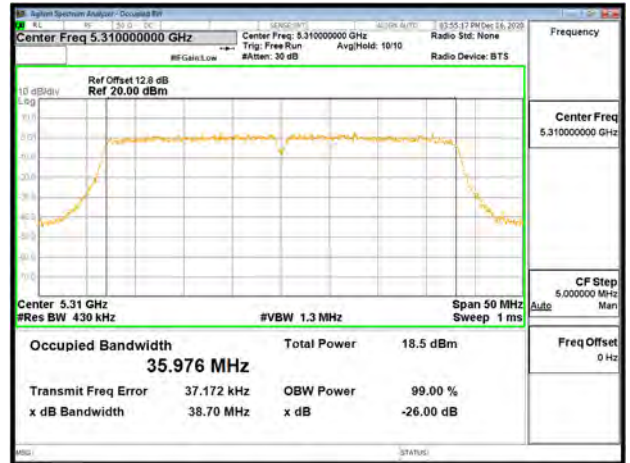

802.11n_40MHz_Chain1_5230MHz

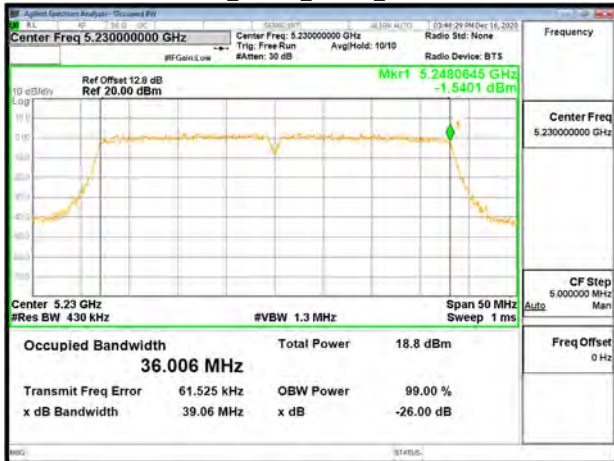

802.11n_40MHz_Chain1_5510MHz

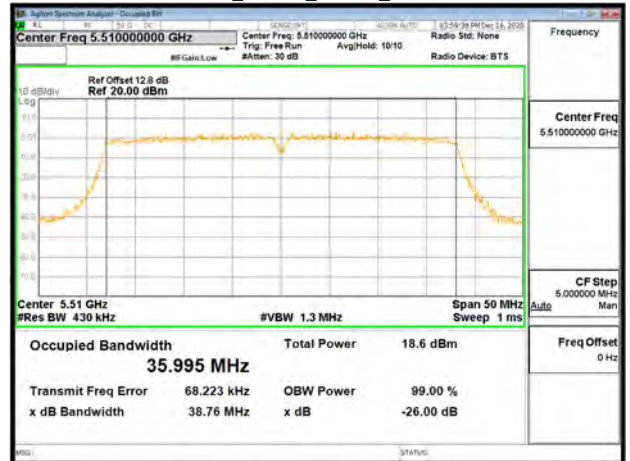

Unless otherwise stated the results shown in this test report refer only to the sample(s) tested and such sample(s) are retained for 90 days only.

除非另有說明，此報告結果僅對測試之樣品負責，同時此樣品僅保留90天。本報告未經本公司書面許可，不可部份複製。

This document is issued by the Company subject to its General Conditions of Service printed overleaf, available on request or accessible at <http://www.sgs.com.tw/Terms-and-Conditions> and for electronic format documents, subject to Terms and Conditions for Electronic Documents at <http://www.sgs.com.tw/Terms-and-Conditions>. Attention is drawn to the limitation of liability, indemnification and jurisdiction issues defined therein. Any holder of this document is advised that information contained hereon reflects the Company's findings at the time of its intervention only and within the limits of Client's instructions, if any. The Company's sole responsibility is to its Client and this document does not exonerate parties to a transaction from exercising all their rights and obligations under the transaction documents. This document cannot be reproduced except in full, without prior written approval of the Company. Any unauthorized alteration, forgery or falsification of the content or appearance of this document is unlawful and offenders may be prosecuted to the fullest extent of the law.

802.11n_40MHz_Chain1_5550MHz

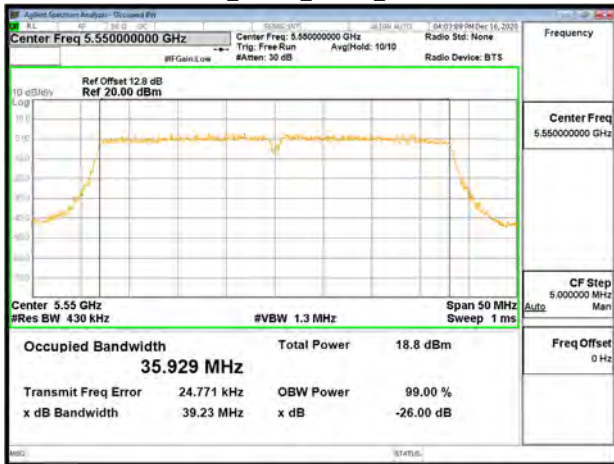

802.11n_40MHz_Chain1_5755MHz

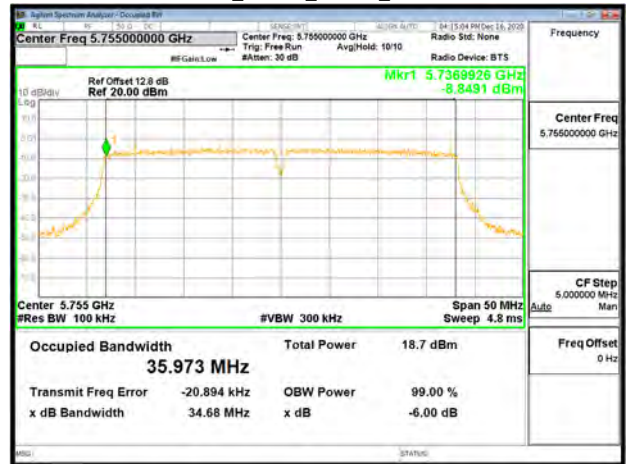

802.11n_40MHz_Chain1_5670MHz

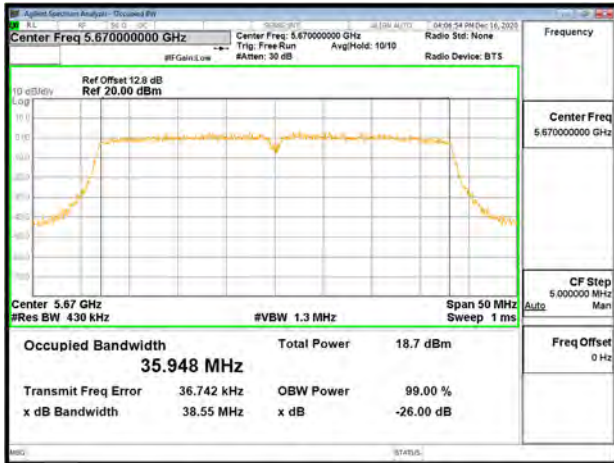

802.11n_40MHz_Chain1_5795MHz

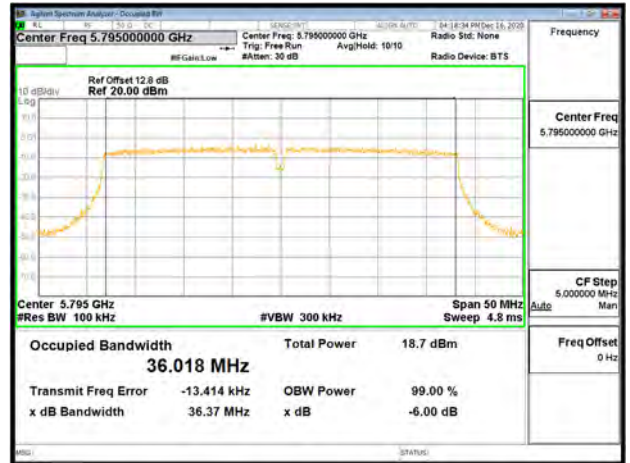

802.11n_40MHz_Chain1_5710MHz

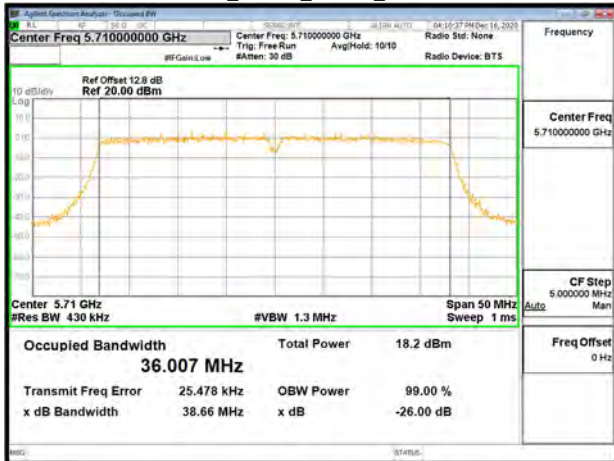

802.11ac_80MHz_Chain0_5210MHz

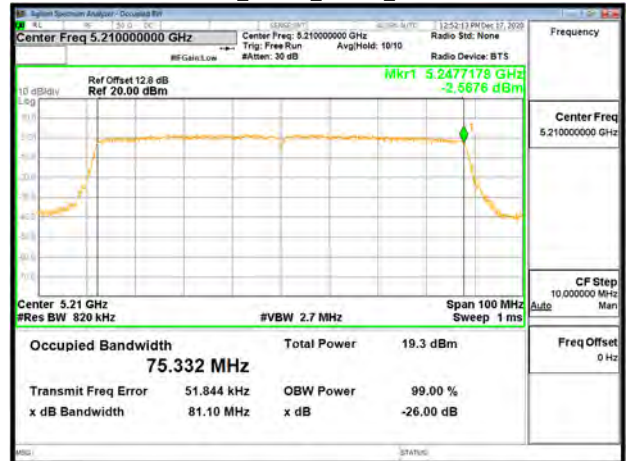

Unless otherwise stated the results shown in this test report refer only to the sample(s) tested and such sample(s) are retained for 90 days only.

除非另有說明，此報告結果僅對測試之樣品負責，同時此樣品僅保留90天。本報告未經本公司書面許可，不可部份複製。

This document is issued by the Company subject to its General Conditions of Service printed overleaf, available on request or accessible at <http://www.sgs.com.tw/Terms-and-Conditions> and for electronic format documents, subject to Terms and Conditions for Electronic Documents at <http://www.sgs.com.tw/Terms-and-Conditions>. Attention is drawn to the limitation of liability, indemnification and jurisdiction issues defined therein. Any holder of this document is advised that information contained hereon reflects the Company's findings at the time of its intervention only and within the limits of Client's instructions, if any. The Company's sole responsibility is to its Client and this document does not exonerate parties to a transaction from exercising all their rights and obligations under the transaction documents. This document cannot be reproduced except in full, without prior written approval of the Company. Any unauthorized alteration, forgery or falsification of the content or appearance of this document is unlawful and offenders may be prosecuted to the fullest extent of the law.

802.11ac_80MHz_Chain0_5290MHz

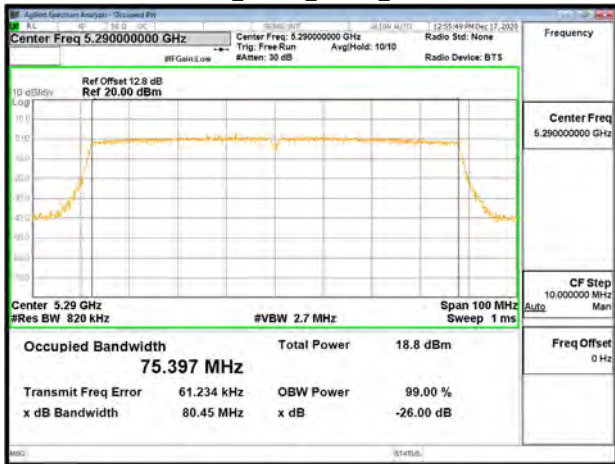

802.11ac_80MHz_Chain0_5690MHz

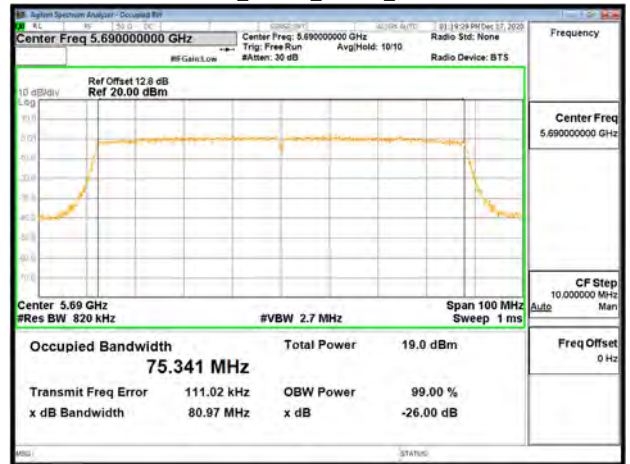

802.11ac_80MHz_Chain0_5530MHz

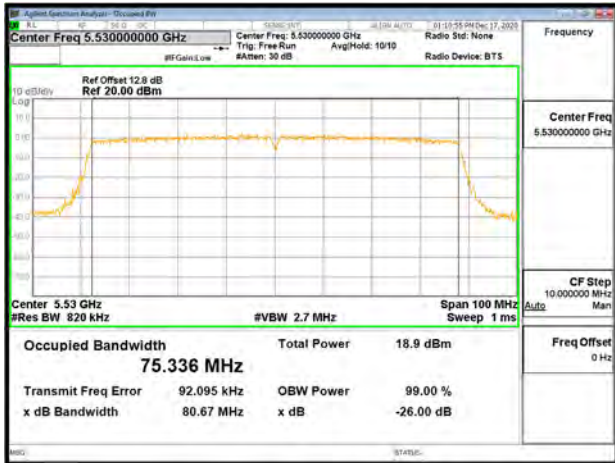

802.11ac_80MHz_Chain0_5775MHz

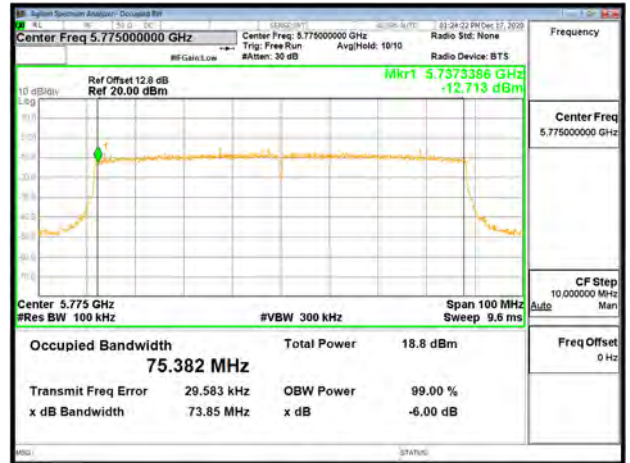

802.11ac_80MHz_Chain0_5610MHz

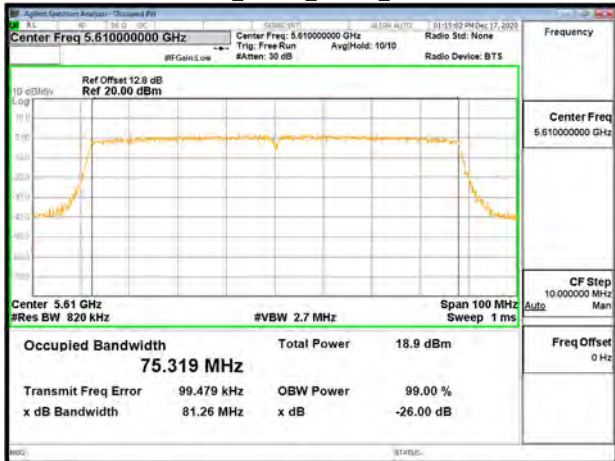

802.11ac_80MHz_Chain1_5210MHz

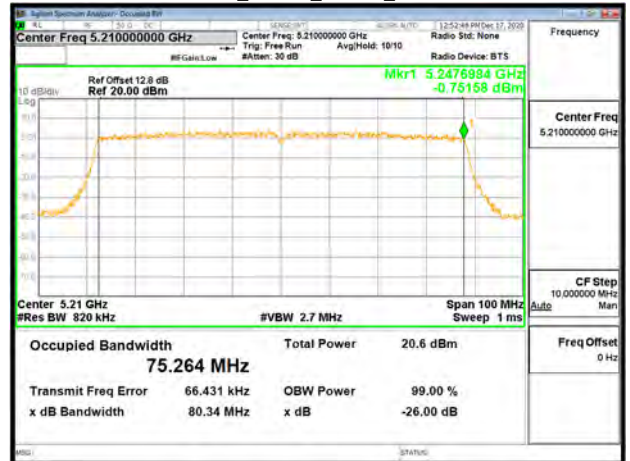

Unless otherwise stated the results shown in this test report refer only to the sample(s) tested and such sample(s) are retained for 90 days only.

除非另有說明，此報告結果僅對測試之樣品負責，同時此樣品僅保留90天。本報告未經本公司書面許可，不可部份複製。

This document is issued by the Company subject to its General Conditions of Service printed overleaf, available on request or accessible at <http://www.sgs.com.tw/Terms-and-Conditions> and for electronic format documents, subject to Terms and Conditions for Electronic Documents at <http://www.sgs.com.tw/Terms-and-Conditions>. Attention is drawn to the limitation of liability, indemnification and jurisdiction issues defined therein. Any holder of this document is advised that information contained hereon reflects the Company's findings at the time of its intervention only and within the limits of Client's instructions, if any. The Company's sole responsibility is to its Client and this document does not exonerate parties to a transaction from exercising all their rights and obligations under the transaction documents. This document cannot be reproduced except in full, without prior written approval of the Company. Any unauthorized alteration, forgery or falsification of the content or appearance of this document is unlawful and offenders may be prosecuted to the fullest extent of the law.

802.11ac_80MHz_Chain1_5290MHz

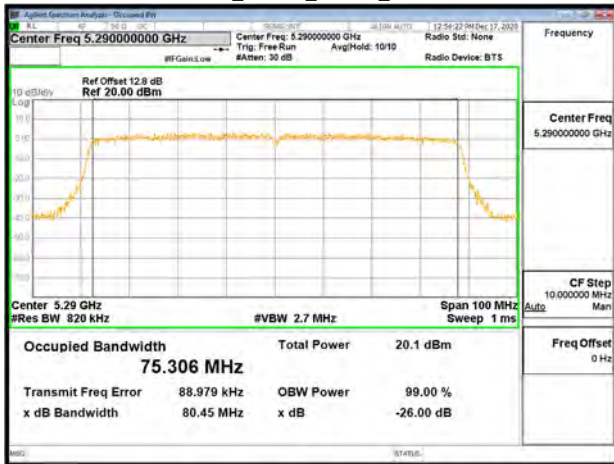

802.11ac_80MHz_Chain1_5690MHz

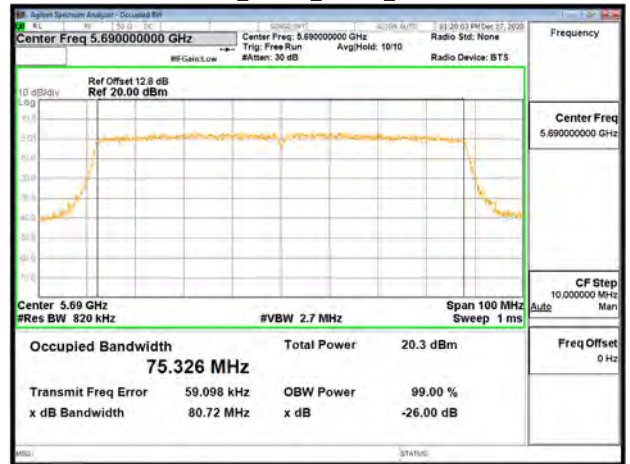

802.11ac_80MHz_Chain1_5530MHz

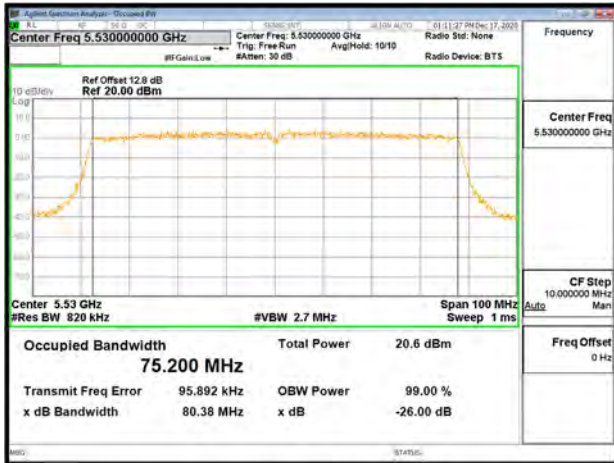

802.11ac_80MHz_Chain1_5775MHz

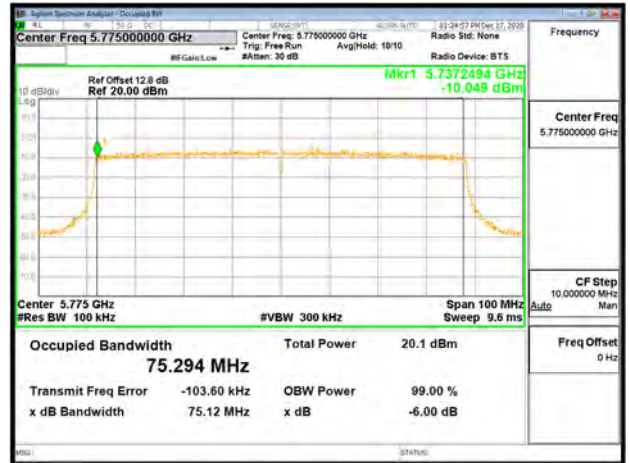

802.11ac_80MHz_Chain1_5610MHz

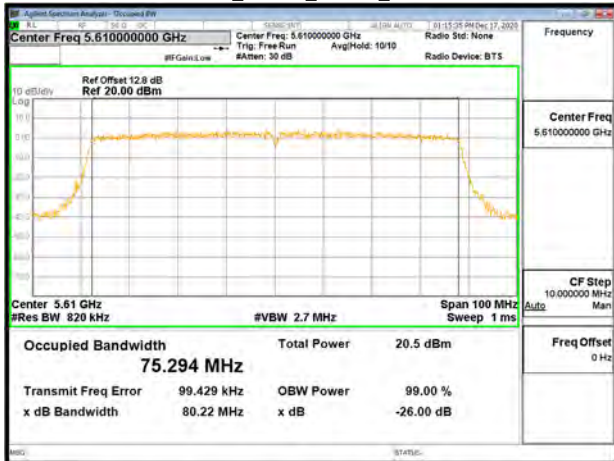

802.11ax_20MHz_Chain0_5180MHz

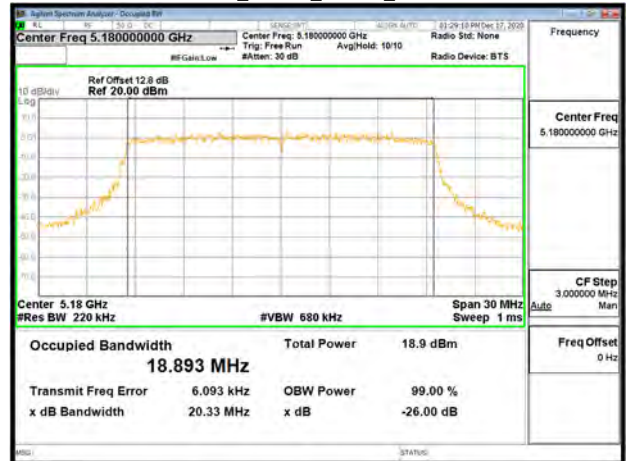

Unless otherwise stated the results shown in this test report refer only to the sample(s) tested and such sample(s) are retained for 90 days only.

除非另有說明，此報告結果僅對測試之樣品負責，同時此樣品僅保留90天。本報告未經本公司書面許可，不可部份複製。

This document is issued by the Company subject to its General Conditions of Service printed overleaf, available on request or accessible at <http://www.sgs.com.tw/Terms-and-Conditions> and for electronic format documents, subject to Terms and Conditions for Electronic Documents at <http://www.sgs.com.tw/Terms-and-Conditions>. Attention is drawn to the limitation of liability, indemnification and jurisdiction issues defined therein. Any holder of this document is advised that information contained hereon reflects the Company's findings at the time of its intervention only and within the limits of Client's instructions, if any. The Company's sole responsibility is to its Client and this document does not exonerate parties to a transaction from exercising all their rights and obligations under the transaction documents. This document cannot be reproduced except in full, without prior written approval of the Company. Any unauthorized alteration, forgery or falsification of the content or appearance of this document is unlawful and offenders may be prosecuted to the fullest extent of the law.

802.11ax_20MHz_Chain0_5220MHz

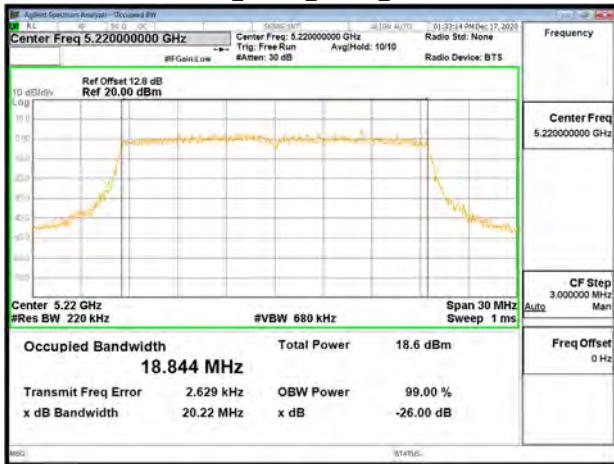

802.11ax_20MHz_Chain0_5300MHz

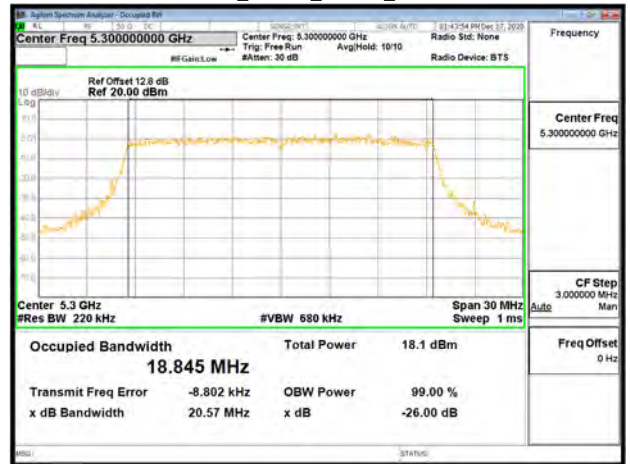

802.11ax_20MHz_Chain0_5240MHz

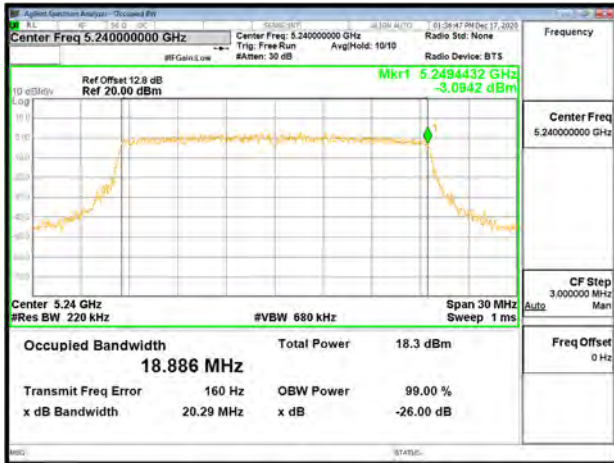

802.11ax_20MHz_Chain0_5320MHz

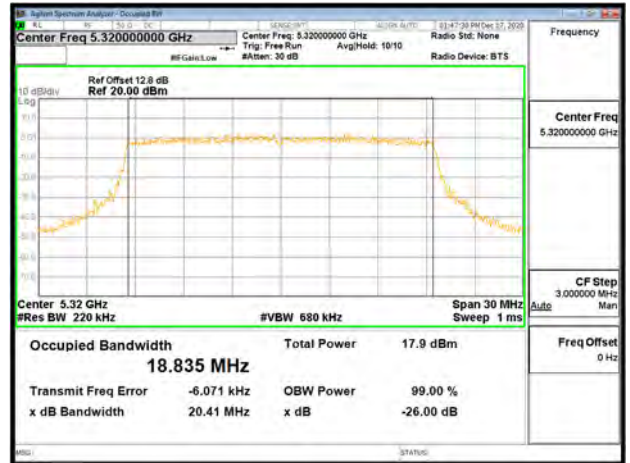

802.11ax_20MHz_Chain0_5260MHz

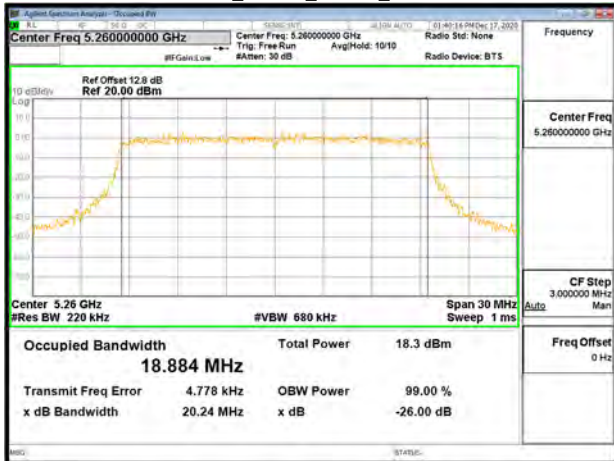

802.11ax_20MHz_Chain0_5500MHz

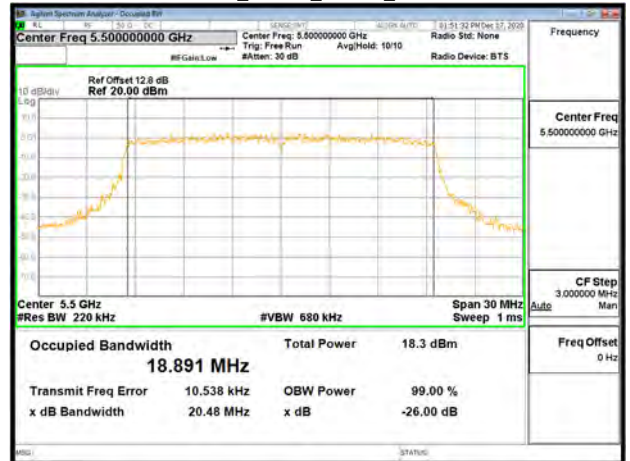

Unless otherwise stated the results shown in this test report refer only to the sample(s) tested and such sample(s) are retained for 90 days only.

除非另有說明，此報告結果僅對測試之樣品負責，同時此樣品僅保留90天。本報告未經本公司書面許可，不可部份複製。

This document is issued by the Company subject to its General Conditions of Service printed overleaf, available on request or accessible at <http://www.sgs.com.tw/Terms-and-Conditions> and for electronic format documents, subject to Terms and Conditions for Electronic Documents at <http://www.sgs.com.tw/Terms-and-Conditions>. Attention is drawn to the limitation of liability, indemnification and jurisdiction issues defined therein. Any holder of this document is advised that information contained hereon reflects the Company's findings at the time of its intervention only and within the limits of Client's instructions, if any. The Company's sole responsibility is to its Client and this document does not exonerate parties to a transaction from exercising all their rights and obligations under the transaction documents. This document cannot be reproduced except in full, without prior written approval of the Company. Any unauthorized alteration, forgery or falsification of the content or appearance of this document is unlawful and offenders may be prosecuted to the fullest extent of the law.

802.11ax_20MHz_Chain0_5580MHz

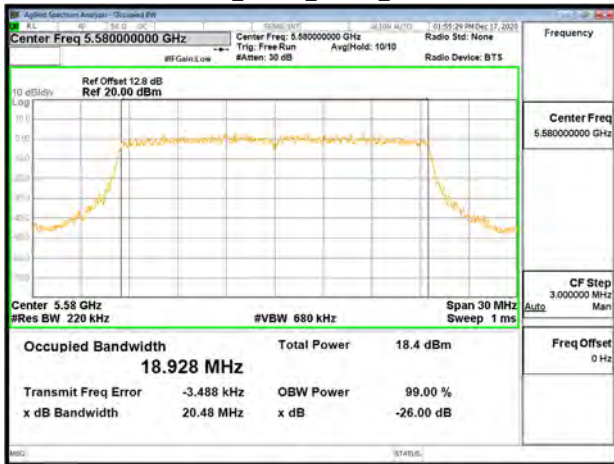

802.11ax_20MHz_Chain0_5745MHz

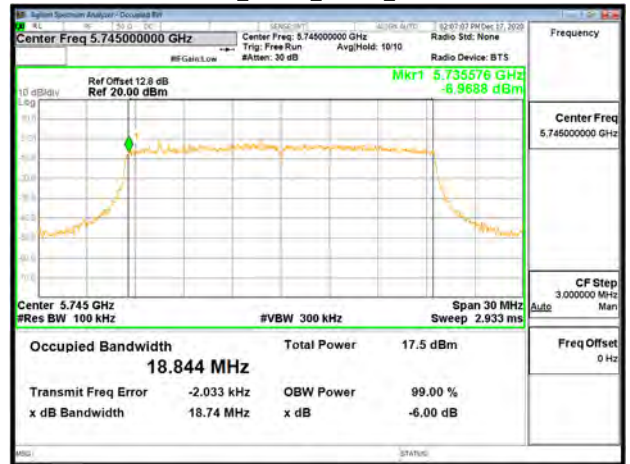

802.11ax_20MHz_Chain0_5700MHz

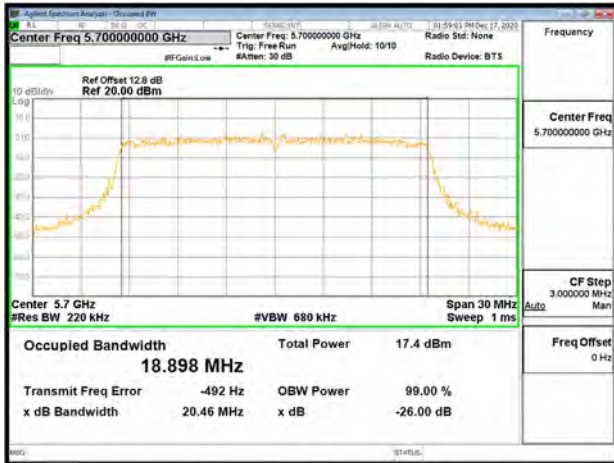

802.11ax_20MHz_Chain0_5785MHz

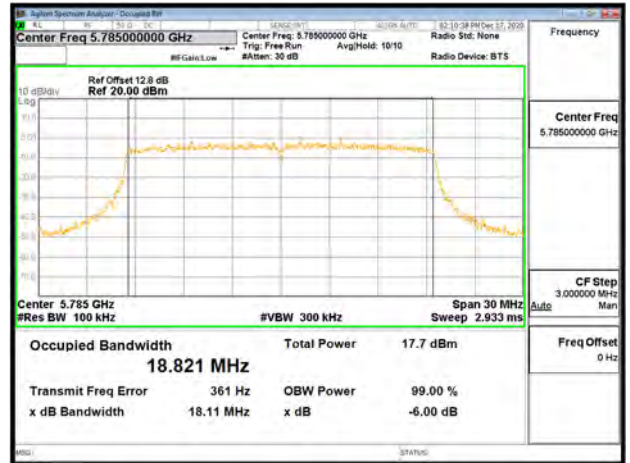

802.11ax_20MHz_Chain0_5720MHz

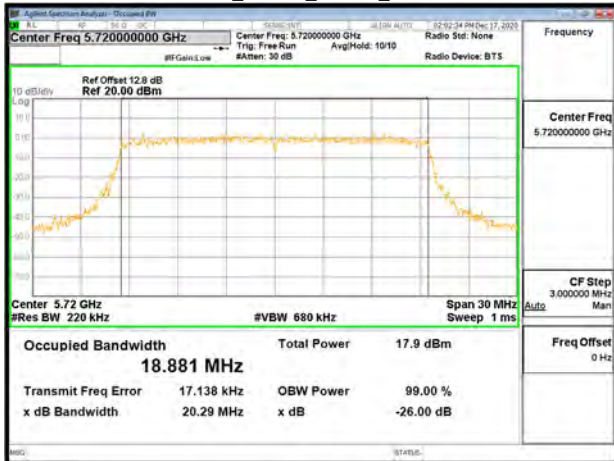

802.11ax_20MHz_Chain0_5825MHz

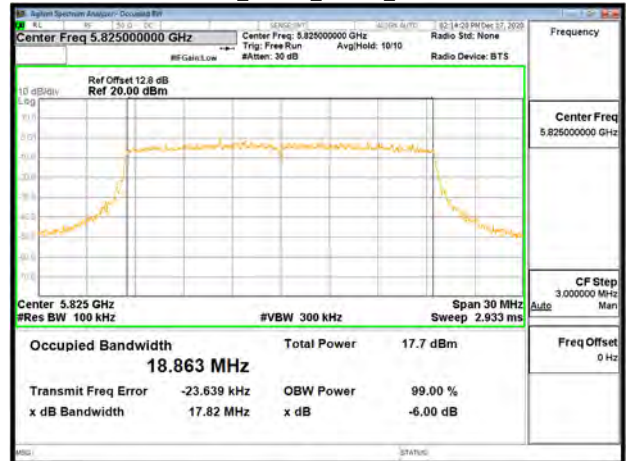

Unless otherwise stated the results shown in this test report refer only to the sample(s) tested and such sample(s) are retained for 90 days only.

除非另有說明，此報告結果僅對測試之樣品負責，同時此樣品僅保留90天。本報告未經本公司書面許可，不可部份複製。

This document is issued by the Company subject to its General Conditions of Service printed overleaf, available on request or accessible at <http://www.sgs.com.tw/Terms-and-Conditions> and for electronic format documents, subject to Terms and Conditions for Electronic Documents at <http://www.sgs.com.tw/Terms-and-Conditions>. Attention is drawn to the limitation of liability, indemnification and jurisdiction issues defined therein. Any holder of this document is advised that information contained hereon reflects the Company's findings at the time of its intervention only and within the limits of Client's instructions, if any. The Company's sole responsibility is to its Client and this document does not exonerate parties to a transaction from exercising all their rights and obligations under the transaction documents. This document cannot be reproduced except in full, without prior written approval of the Company. Any unauthorized alteration, forgery or falsification of the content or appearance of this document is unlawful and offenders may be prosecuted to the fullest extent of the law.

802.11ax_20MHz_Chain1_5180MHz

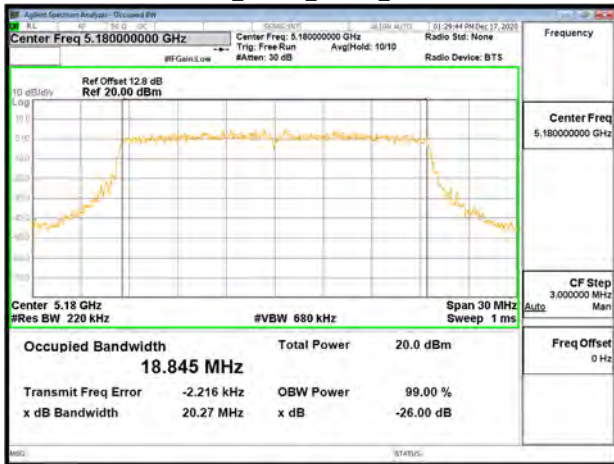

802.11ax_20MHz_Chain1_5260MHz

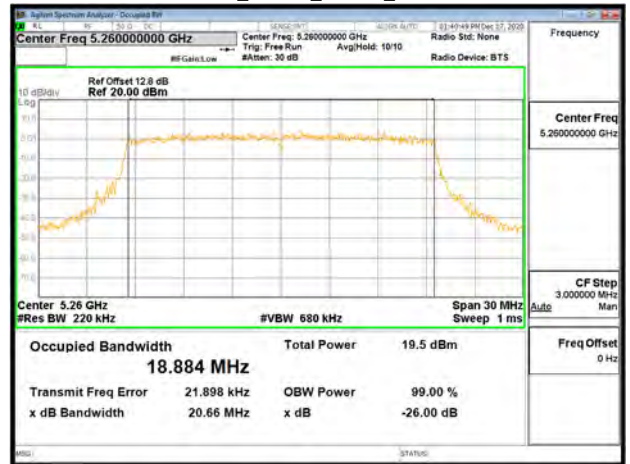

802.11ax_20MHz_Chain1_5220MHz

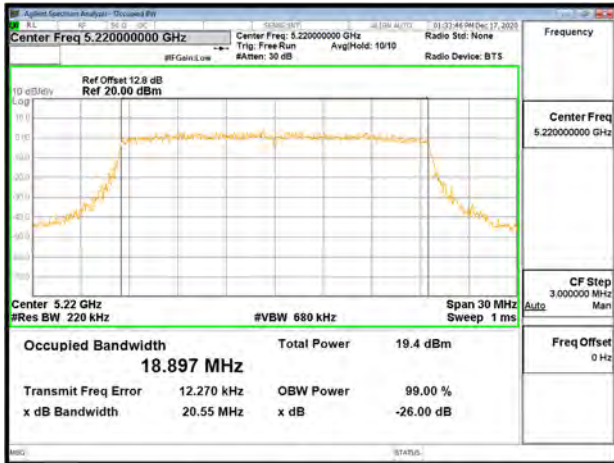

802.11ax_20MHz_Chain1_5300MHz

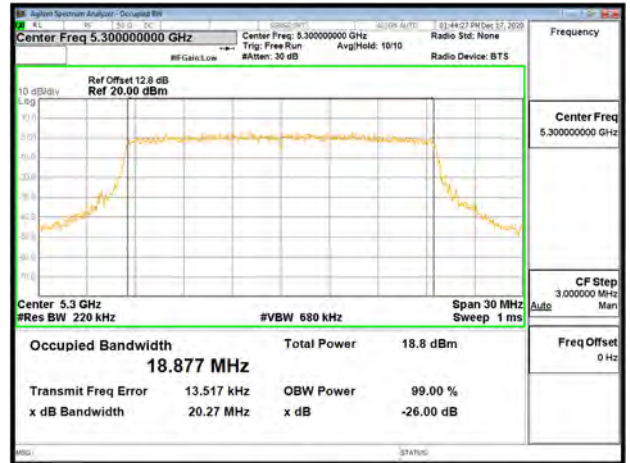

802.11ax_20MHz_Chain1_5240MHz

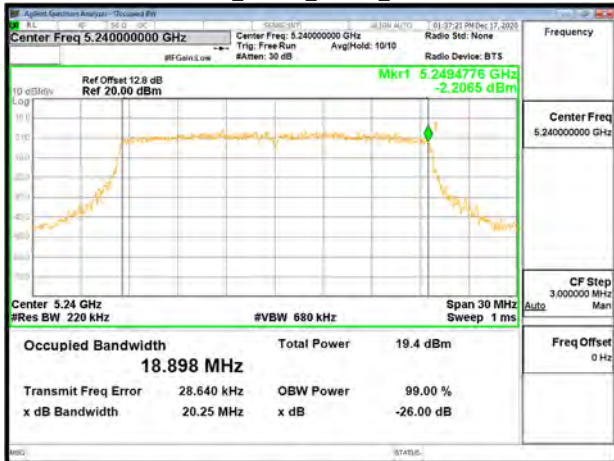

802.11ax_20MHz_Chain1_5320MHz

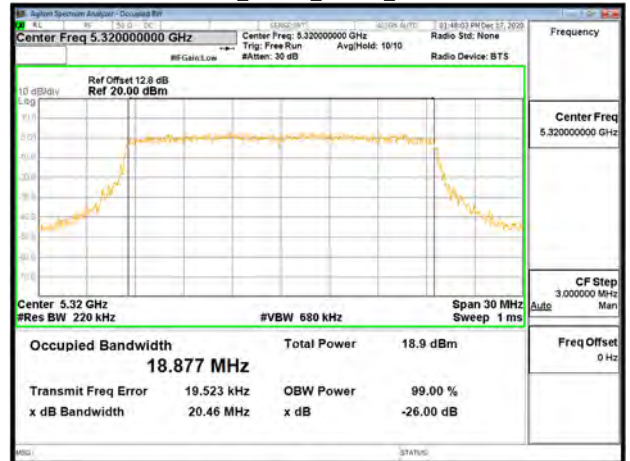

Unless otherwise stated the results shown in this test report refer only to the sample(s) tested and such sample(s) are retained for 90 days only.

除非另有說明，此報告結果僅對測試之樣品負責，同時此樣品僅保留90天。本報告未經本公司書面許可，不可部份複製。

This document is issued by the Company subject to its General Conditions of Service printed overleaf, available on request or accessible at <http://www.sgs.com.tw/Terms-and-Conditions> and for electronic format documents, subject to Terms and Conditions for Electronic Documents at <http://www.sgs.com.tw/Terms-and-Conditions>. Attention is drawn to the limitation of liability, indemnification and jurisdiction issues defined therein. Any holder of this document is advised that information contained hereon reflects the Company's findings at the time of its intervention only and within the limits of Client's instructions, if any. The Company's sole responsibility is to its Client and this document does not exonerate parties to a transaction from exercising all their rights and obligations under the transaction documents. This document cannot be reproduced except in full, without prior written approval of the Company. Any unauthorized alteration, forgery or falsification of the content or appearance of this document is unlawful and offenders may be prosecuted to the fullest extent of the law.

802.11ax_20MHz_Chain1_5500MHz

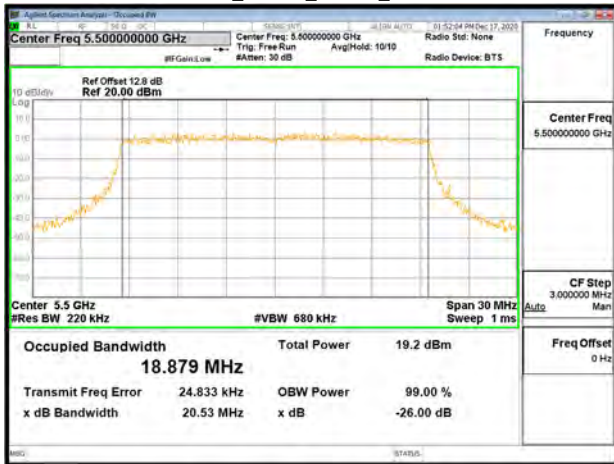

802.11ax_20MHz_Chain1_5720MHz

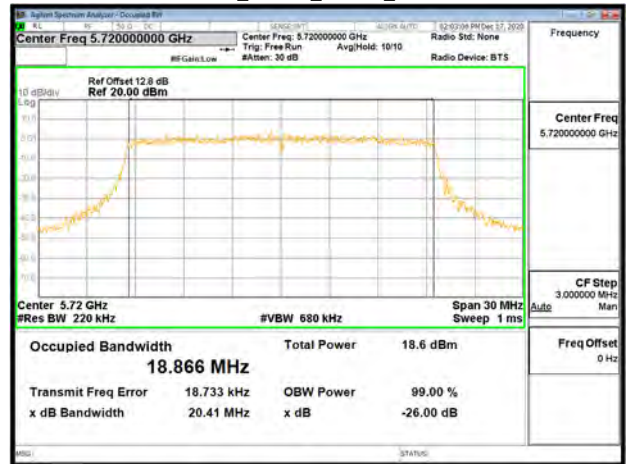

802.11ax_20MHz_Chain1_5580MHz

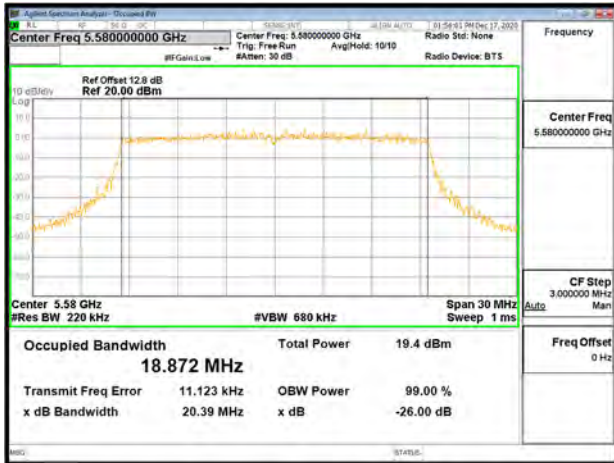

802.11ax_20MHz_Chain1_5745MHz

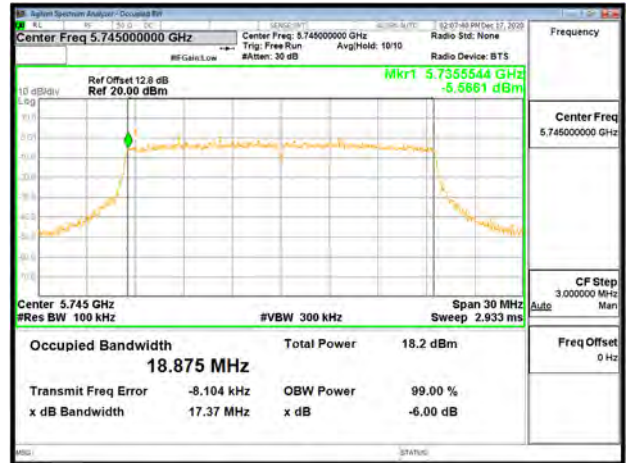

802.11ax_20MHz_Chain1_5700MHz

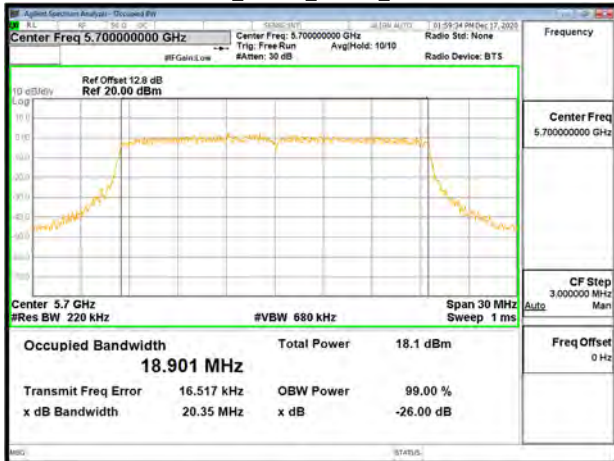

802.11ax_20MHz_Chain1_5785MHz

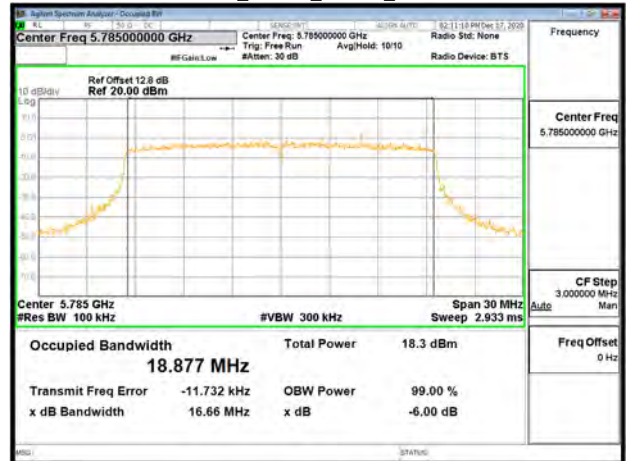

Unless otherwise stated the results shown in this test report refer only to the sample(s) tested and such sample(s) are retained for 90 days only.

除非另有說明，此報告結果僅對測試之樣品負責，同時此樣品僅保留90天。本報告未經本公司書面許可，不可部份複製。

This document is issued by the Company subject to its General Conditions of Service printed overleaf, available on request or accessible at <http://www.sgs.com.tw/Terms-and-Conditions> and for electronic format documents, subject to Terms and Conditions for Electronic Documents at <http://www.sgs.com.tw/Terms-and-Conditions>. Attention is drawn to the limitation of liability, indemnification and jurisdiction issues defined therein. Any holder of this document is advised that information contained hereon reflects the Company's findings at the time of its intervention only and within the limits of Client's instructions, if any. The Company's sole responsibility is to its Client and this document does not exonerate parties to a transaction from exercising all their rights and obligations under the transaction documents. This document cannot be reproduced except in full, without prior written approval of the Company. Any unauthorized alteration, forgery or falsification of the content or appearance of this document is unlawful and offenders may be prosecuted to the fullest extent of the law.

802.11ax_20MHz_Chain1_5825MHz

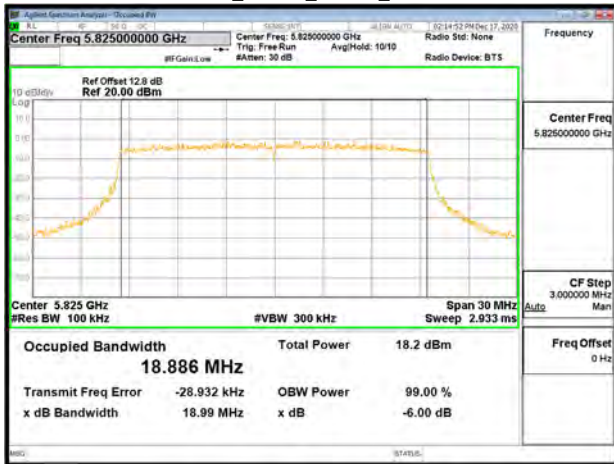

802.11ax_40MHz_Chain0_5270MHz

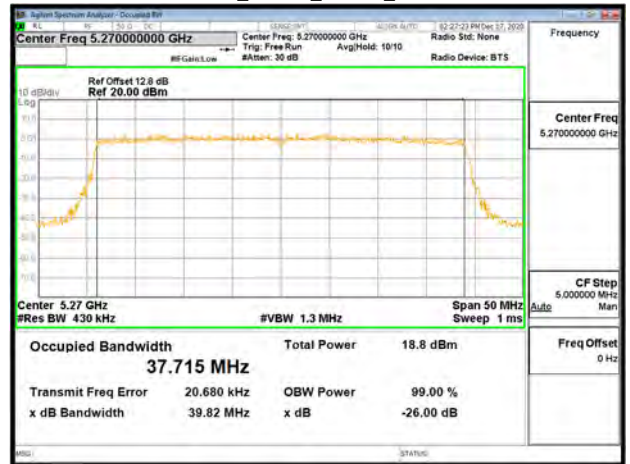

802.11ax_40MHz_Chain0_5190MHz

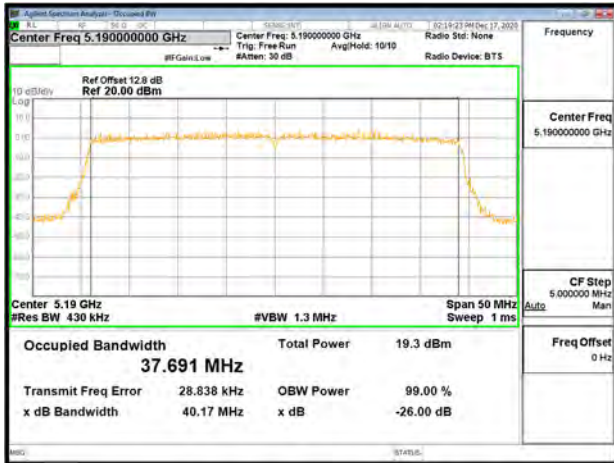

802.11ax_40MHz_Chain0_5310MHz

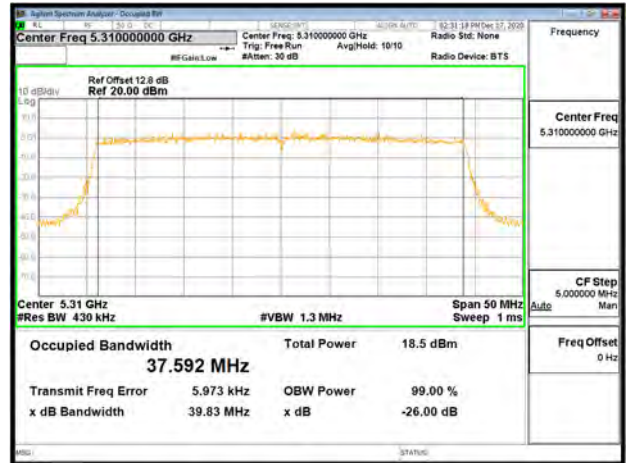

802.11ax_40MHz_Chain0_5230MHz

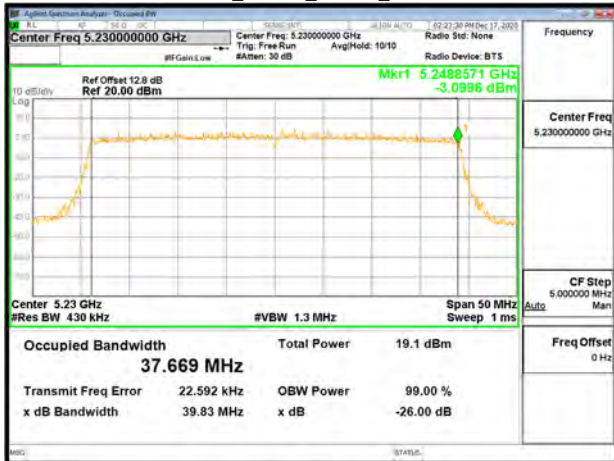

802.11ax_40MHz_Chain0_5510MHz

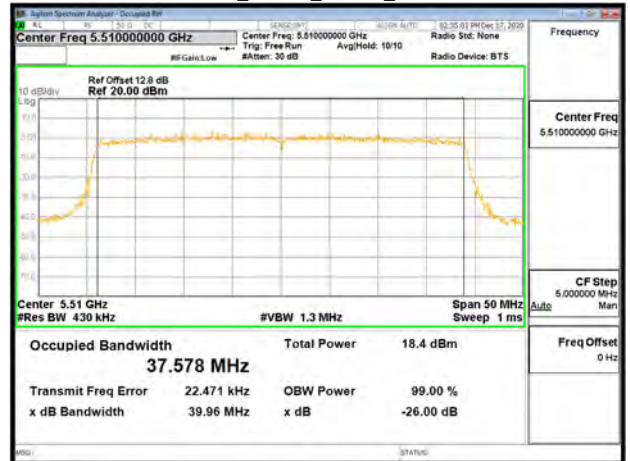

Unless otherwise stated the results shown in this test report refer only to the sample(s) tested and such sample(s) are retained for 90 days only.

除非另有說明，此報告結果僅對測試之樣品負責，同時此樣品僅保留90天。本報告未經本公司書面許可，不可部份複製。

This document is issued by the Company subject to its General Conditions of Service printed overleaf, available on request or accessible at <http://www.sgs.com.tw/Terms-and-Conditions> and for electronic format documents, subject to Terms and Conditions for Electronic Documents at <http://www.sgs.com.tw/Terms-and-Conditions>. Attention is drawn to the limitation of liability, indemnification and jurisdiction issues defined therein. Any holder of this document is advised that information contained hereon reflects the Company's findings at the time of its intervention only and within the limits of Client's instructions, if any. The Company's sole responsibility is to its Client and this document does not exonerate parties to a transaction from exercising all their rights and obligations under the transaction documents. This document cannot be reproduced except in full, without prior written approval of the Company. Any unauthorized alteration, forgery or falsification of the content or appearance of this document is unlawful and offenders may be prosecuted to the fullest extent of the law.

802.11ax_40MHz_Chain0_5550MHz

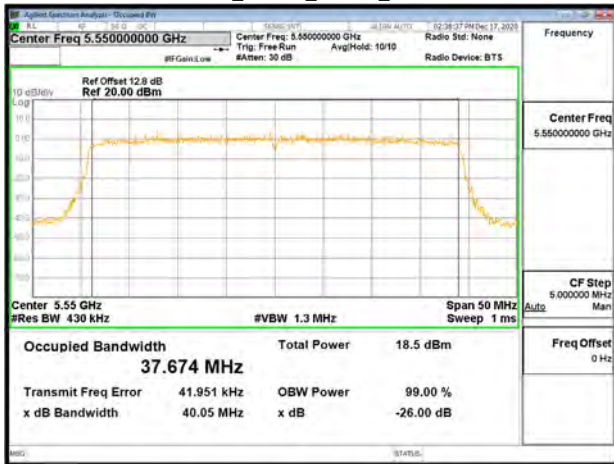

802.11ax_40MHz_Chain0_5755MHz

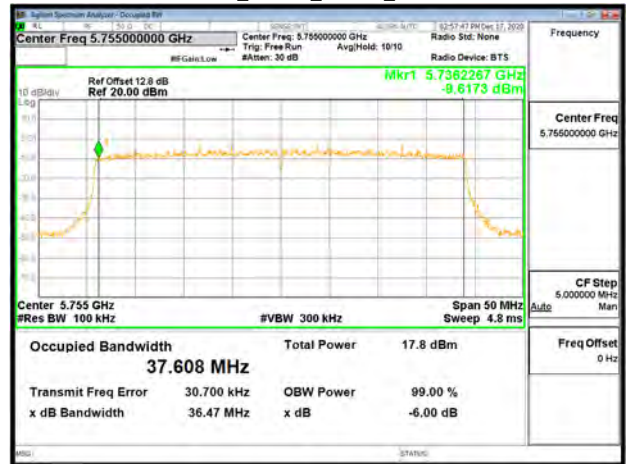

802.11ax_40MHz_Chain0_5670MHz

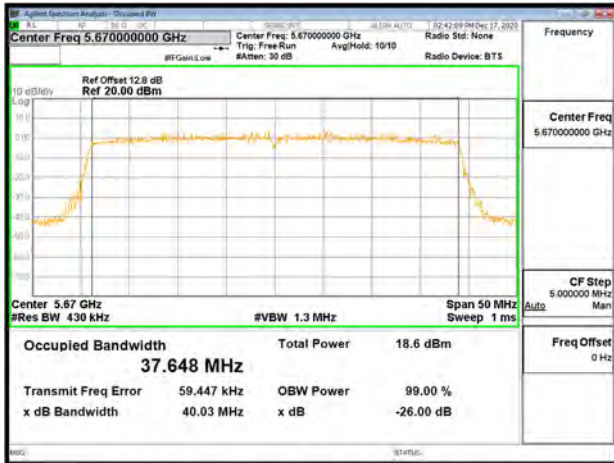

802.11ax_40MHz_Chain0_5795MHz

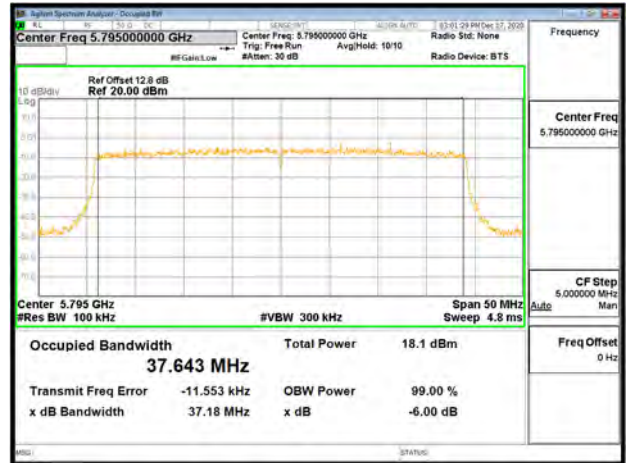

802.11ax_40MHz_Chain0_5710MHz

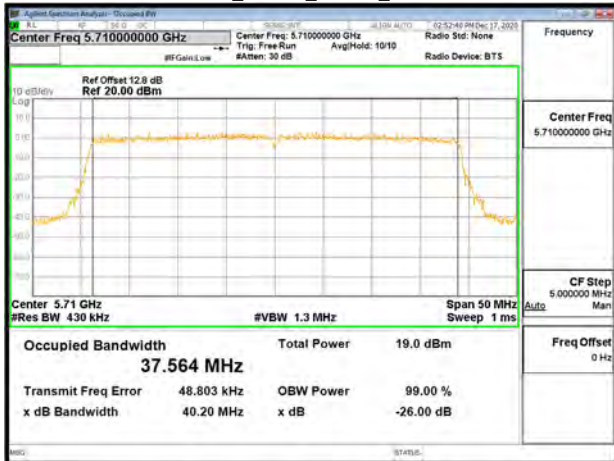

802.11ax_40MHz_Chain1_5190MHz

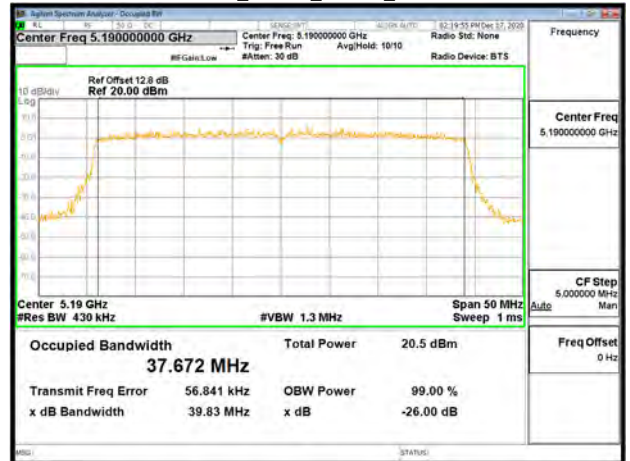

Unless otherwise stated the results shown in this test report refer only to the sample(s) tested and such sample(s) are retained for 90 days only.

除非另有說明，此報告結果僅對測試之樣品負責，同時此樣品僅保留90天。本報告未經本公司書面許可，不可部份複製。

This document is issued by the Company subject to its General Conditions of Service printed overleaf, available on request or accessible at <http://www.sgs.com.tw/Terms-and-Conditions> and for electronic format documents, subject to Terms and Conditions for Electronic Documents at <http://www.sgs.com.tw/Terms-and-Conditions>. Attention is drawn to the limitation of liability, indemnification and jurisdiction issues defined therein. Any holder of this document is advised that information contained hereon reflects the Company's findings at the time of its intervention only and within the limits of Client's instructions, if any. The Company's sole responsibility is to its Client and this document does not exonerate parties to a transaction from exercising all their rights and obligations under the transaction documents. This document cannot be reproduced except in full, without prior written approval of the Company. Any unauthorized alteration, forgery or falsification of the content or appearance of this document is unlawful and offenders may be prosecuted to the fullest extent of the law.

802.11ax_40MHz_Chain1_5230MHz

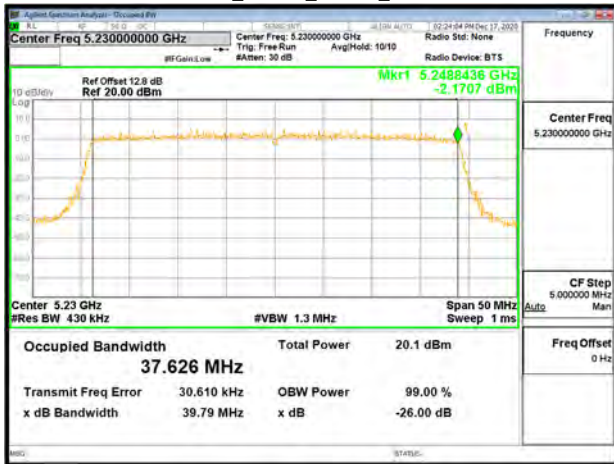

802.11ax_40MHz_Chain1_5510MHz

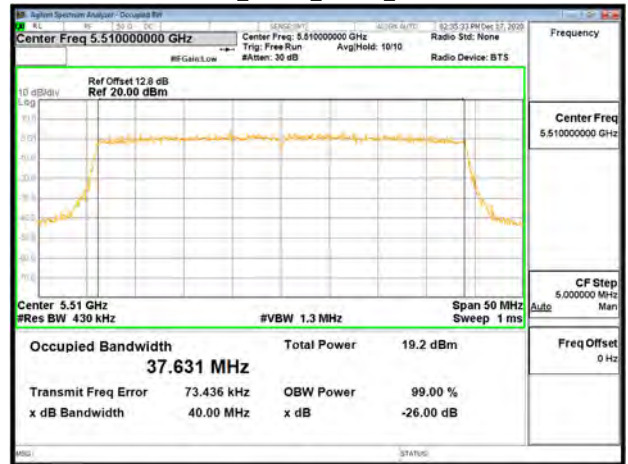

802.11ax_40MHz_Chain1_5270MHz

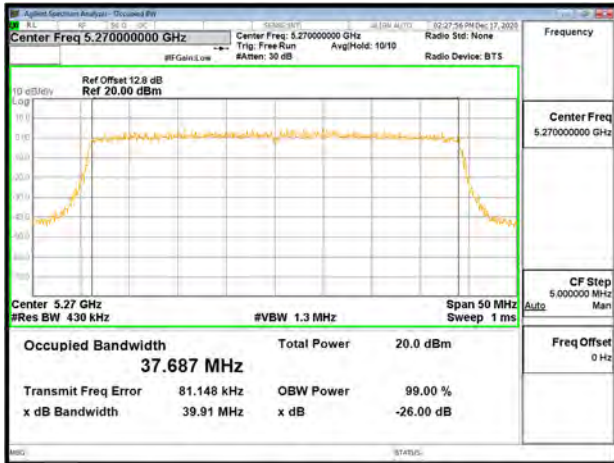

802.11ax_40MHz_Chain1_5550MHz

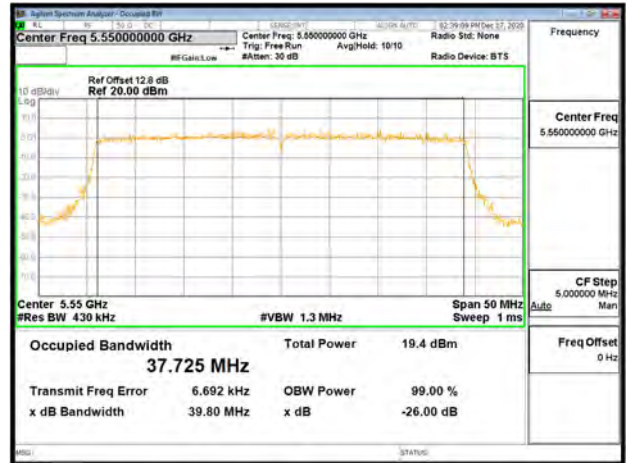

802.11ax_40MHz_Chain1_5310MHz

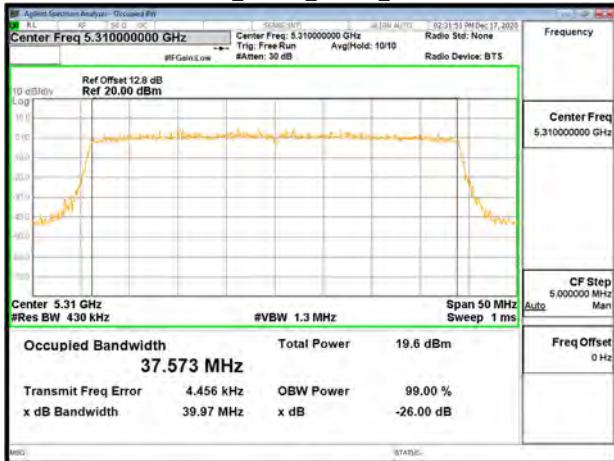

802.11ax_40MHz_Chain1_5670MHz

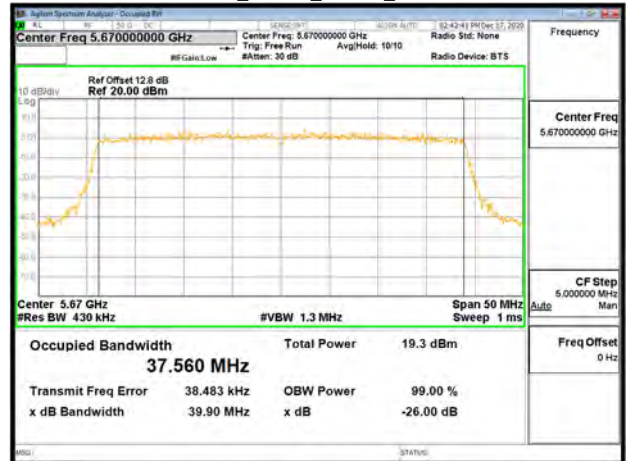

Unless otherwise stated the results shown in this test report refer only to the sample(s) tested and such sample(s) are retained for 90 days only.

除非另有說明，此報告結果僅對測試之樣品負責，同時此樣品僅保留90天。本報告未經本公司書面許可，不可部份複製。

This document is issued by the Company subject to its General Conditions of Service printed overleaf, available on request or accessible at <http://www.sgs.com.tw/Terms-and-Conditions> and for electronic format documents, subject to Terms and Conditions for Electronic Documents at <http://www.sgs.com.tw/Terms-and-Conditions>. Attention is drawn to the limitation of liability, indemnification and jurisdiction issues defined therein. Any holder of this document is advised that information contained hereon reflects the Company's findings at the time of its intervention only and within the limits of Client's instructions, if any. The Company's sole responsibility is to its Client and this document does not exonerate parties to a transaction from exercising all their rights and obligations under the transaction documents. This document cannot be reproduced except in full, without prior written approval of the Company. Any unauthorized alteration, forgery or falsification of the content or appearance of this document is unlawful and offenders may be prosecuted to the fullest extent of the law.

802.11ax_40MHz_Chain1_5710MHz

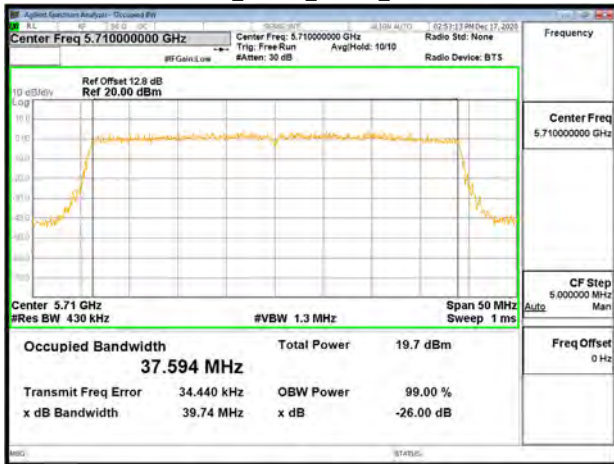

802.11ax_80MHz_Chain0_5210MHz

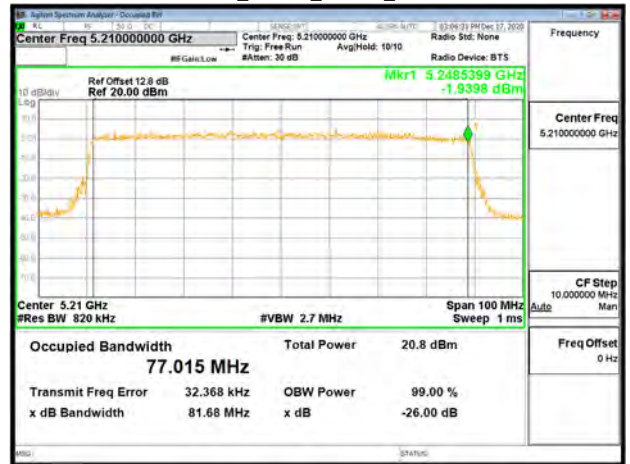

802.11ax_40MHz_Chain1_5755MHz

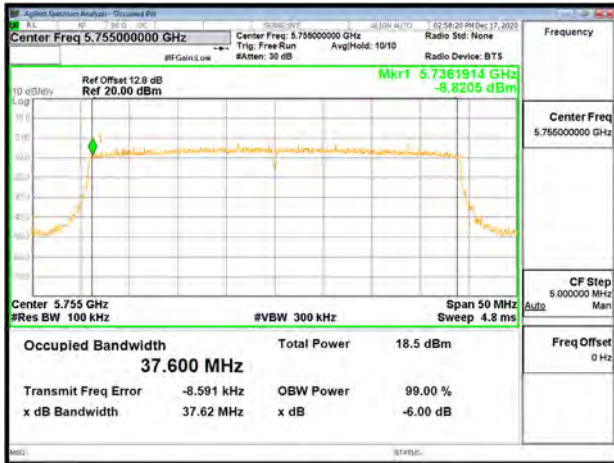

802.11ax_80MHz_Chain0_5290MHz

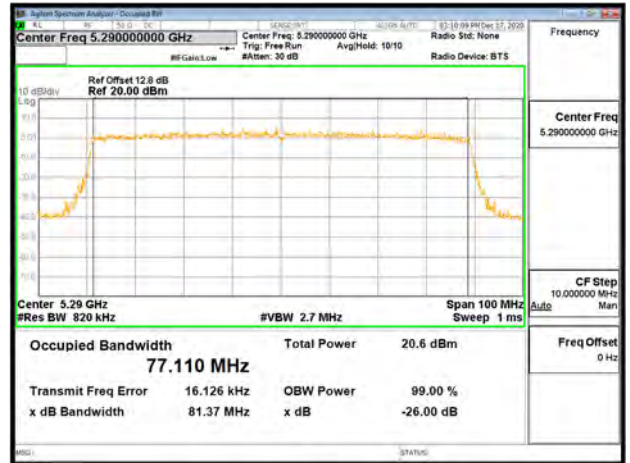

802.11ax_40MHz_Chain1_5795MHz

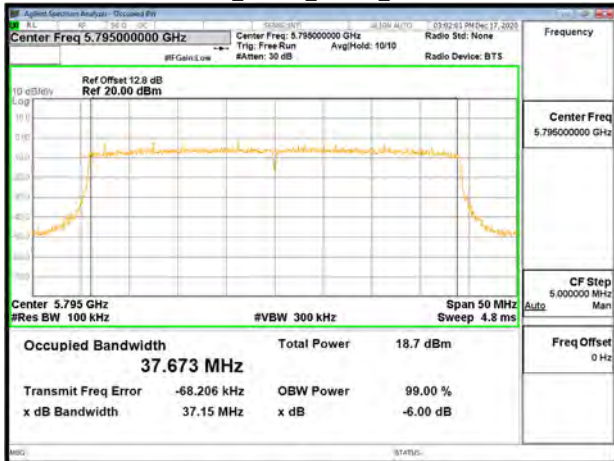

802.11ax_80MHz_Chain0_5530MHz

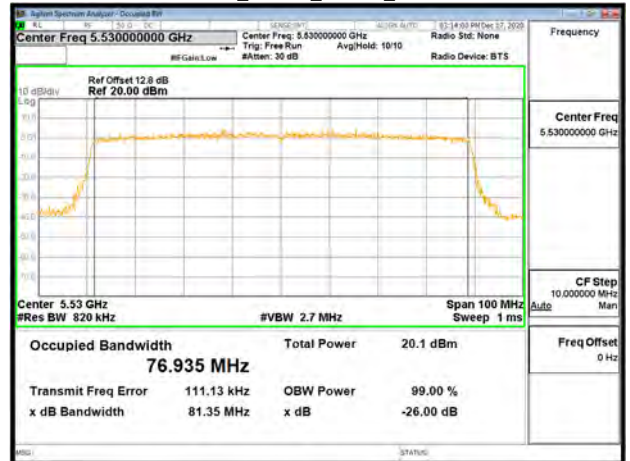

Unless otherwise stated the results shown in this test report refer only to the sample(s) tested and such sample(s) are retained for 90 days only.

除非另有說明，此報告結果僅對測試之樣品負責，同時此樣品僅保留90天。本報告未經本公司書面許可，不可部份複製。

This document is issued by the Company subject to its General Conditions of Service printed overleaf, available on request or accessible at <http://www.sgs.com.tw/Terms-and-Conditions> and for electronic format documents, subject to Terms and Conditions for Electronic Documents at <http://www.sgs.com.tw/Terms-and-Conditions>. Attention is drawn to the limitation of liability, indemnification and jurisdiction issues defined therein. Any holder of this document is advised that information contained hereon reflects the Company's findings at the time of its intervention only and within the limits of Client's instructions, if any. The Company's sole responsibility is to its Client and this document does not exonerate parties to a transaction from exercising all their rights and obligations under the transaction documents. This document cannot be reproduced except in full, without prior written approval of the Company. Any unauthorized alteration, forgery or falsification of the content or appearance of this document is unlawful and offenders may be prosecuted to the fullest extent of the law.

802.11ax_80MHz_Chain0_5610MHz

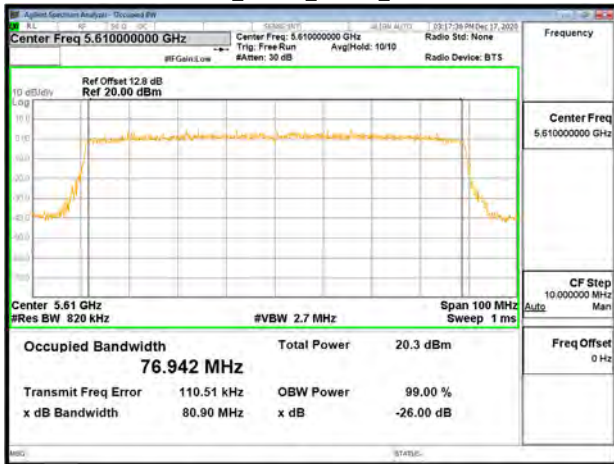

802.11ax_80MHz_Chain1_5210MHz

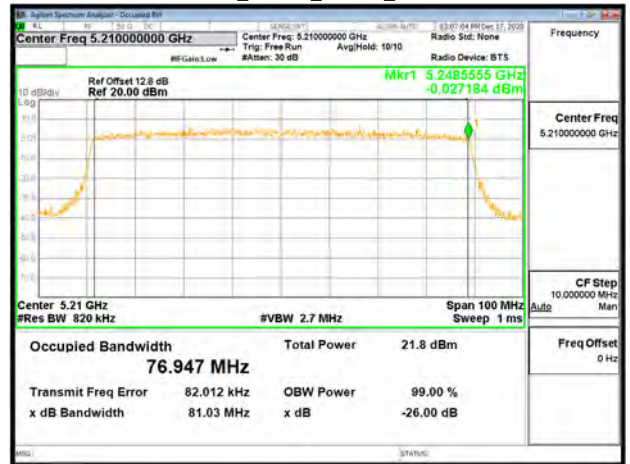

802.11ax_80MHz_Chain0_5690MHz

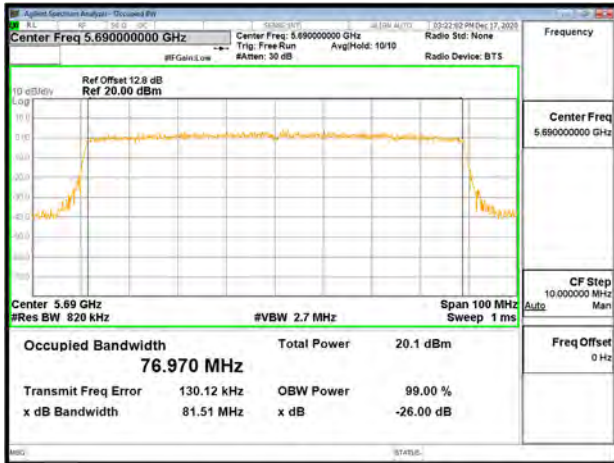

802.11ax_80MHz_Chain1_5290MHz

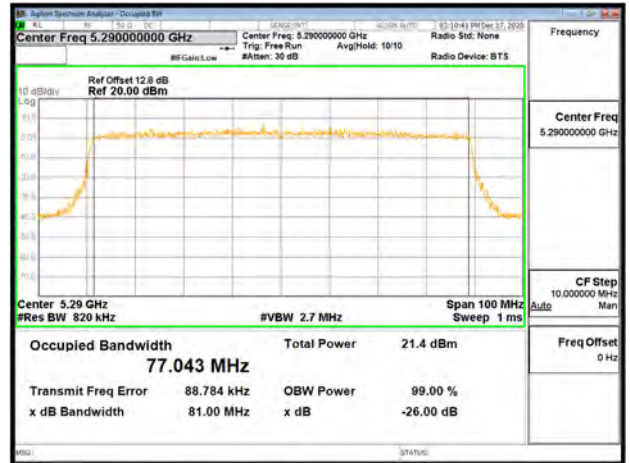

802.11ax_80MHz_Chain0_5775MHz

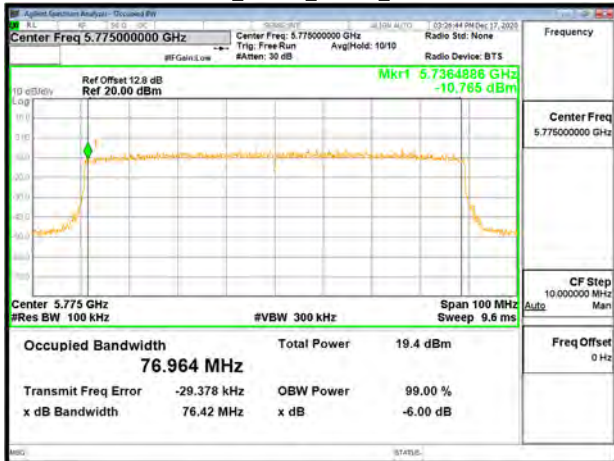

802.11ax_80MHz_Chain1_5530MHz

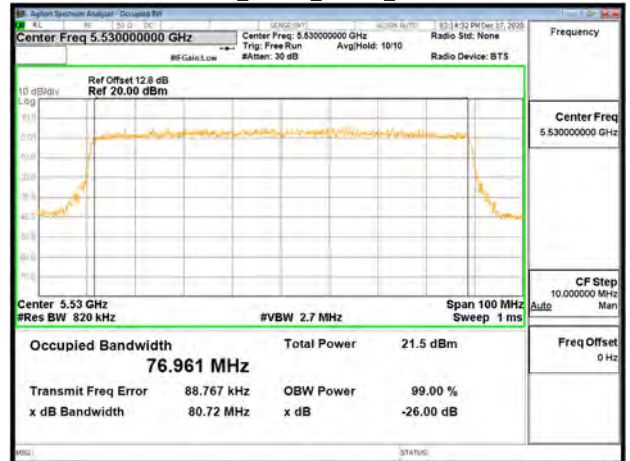

Unless otherwise stated the results shown in this test report refer only to the sample(s) tested and such sample(s) are retained for 90 days only.

除非另有說明，此報告結果僅對測試之樣品負責，同時此樣品僅保留90天。本報告未經本公司書面許可，不可部份複製。

This document is issued by the Company subject to its General Conditions of Service printed overleaf, available on request or accessible at <http://www.sgs.com.tw/Terms-and-Conditions> and for electronic format documents, subject to Terms and Conditions for Electronic Documents at <http://www.sgs.com.tw/Terms-and-Conditions>. Attention is drawn to the limitation of liability, indemnification and jurisdiction issues defined therein. Any holder of this document is advised that information contained hereon reflects the Company's findings at the time of its intervention only and within the limits of Client's instructions, if any. The Company's sole responsibility is to its Client and this document does not exonerate parties to a transaction from exercising all their rights and obligations under the transaction documents. This document cannot be reproduced except in full, without prior written approval of the Company. Any unauthorized alteration, forgery or falsification of the content or appearance of this document is unlawful and offenders may be prosecuted to the fullest extent of the law.

802.11ax_80MHz_Chain1_5610MHz

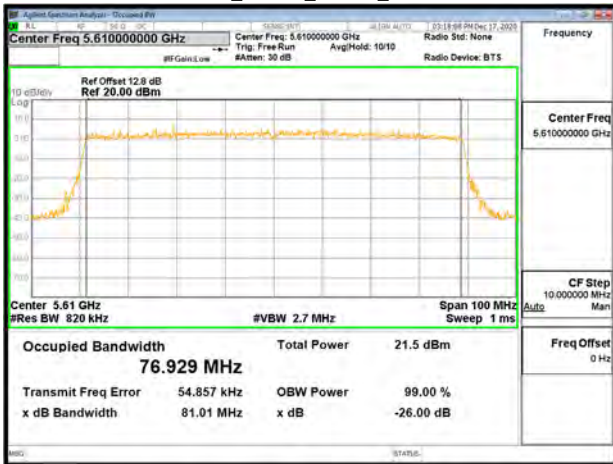

802.11ax_80MHz_Chain1_5690MHz

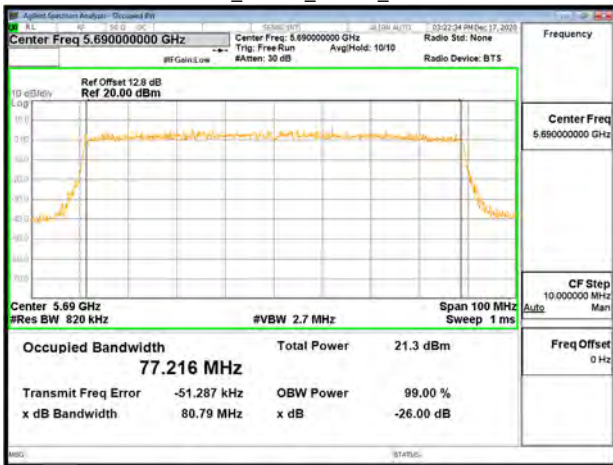

802.11ax_80MHz_Chain1_5775MHz



Unless otherwise stated the results shown in this test report refer only to the sample(s) tested and such sample(s) are retained for 90 days only.

除非另有說明，此報告結果僅對測試之樣品負責，同時此樣品僅保留90天。本報告未經本公司書面許可，不可部份複製。

This document is issued by the Company subject to its General Conditions of Service printed overleaf, available on request or accessible at <http://www.sgs.com.tw/Terms-and-Conditions> and for electronic format documents, subject to Terms and Conditions for Electronic Documents at <http://www.sgs.com.tw/Terms-and-Conditions>. Attention is drawn to the limitation of liability, indemnification and jurisdiction issues defined therein. Any holder of this document is advised that information contained hereon reflects the Company's findings at the time of its intervention only and within the limits of Client's instructions, if any. The Company's sole responsibility is to its Client and this document does not exonerate parties to a transaction from exercising all their rights and obligations under the transaction documents. This document cannot be reproduced except in full, without prior written approval of the Company. Any unauthorized alteration, forgery or falsification of the content or appearance of this document is unlawful and offenders may be prosecuted to the fullest extent of the law.

8.5.3 ISED 99% Bandwidth

802.11a_Ch0

Frequency (MHz)	99% BW (MHz)	10 Log (B) (dB)
5180	16.346	12.130
5220	16.339	12.130
5240	16.335	12.130
5260	16.340	12.130
5300	16.336	12.130
5320	16.331	12.130
5500	16.332	12.130
5580	16.327	12.130
5700	16.324	12.130
5720	16.323	12.130

802.11n_HT20_Ch0

Frequency (MHz)	99% BW (MHz)	10 Log (B) (dB)
5180	17.541	12.440
5220	17.532	12.440
5240	17.529	12.440
5260	17.555	12.440
5300	17.558	12.440
5320	17.546	12.440
5500	17.544	12.440
5580	17.551	12.440
5700	17.541	12.440
5720	17.523	12.440

802.11n_HT20_Ch1

Frequency (MHz)	99% BW (MHz)	10 Log (B) (dB)
5180	17.540	12.440
5220	17.525	12.440
5240	17.526	12.440
5260	17.540	12.440
5300	17.535	12.440
5320	17.533	12.440
5500	17.535	12.440
5580	17.518	12.430
5700	17.552	12.440
5720	17.521	12.440

Unless otherwise stated the results shown in this test report refer only to the sample(s) tested and such sample(s) are retained for 90 days only.

除非另有說明，此報告結果僅對測試之樣品負責，同時此樣品僅保留90天。本報告未經本公司書面許可，不可部份複製。

This document is issued by the Company subject to its General Conditions of Service printed overleaf, available on request or accessible at <http://www.sgs.com.tw/Terms-and-Conditions> and for electronic format documents, subject to Terms and Conditions for Electronic Documents at <http://www.sgs.com.tw/Terms-and-Conditions>. Attention is drawn to the limitation of liability, indemnification and jurisdiction issues defined therein. Any holder of this document is advised that information contained hereon reflects the Company's findings at the time of its intervention only and within the limits of Client's instructions, if any. The Company's sole responsibility is to its Client and this document does not exonerate parties to a transaction from exercising all their rights and obligations under the transaction documents. This document cannot be reproduced except in full, without prior written approval of the Company. Any unauthorized alteration, forgery or falsification of the content or appearance of this document is unlawful and offenders may be prosecuted to the fullest extent of the law.

802.11n_HT40_Ch0

Frequency (MHz)	99% BW (MHz)	10 Log (B) (dB)
5190	35.990	15.560
5230	35.970	15.560
5270	35.990	15.560
5310	35.966	15.560
5510	35.971	15.560
5550	36.003	15.560
5670	35.946	15.560
5710	35.999	15.560

802.11n_HT40_Ch1

Frequency (MHz)	99% BW (MHz)	10 Log (B) (dB)
5190	36.017	15.570
5230	35.998	15.560
5270	35.982	15.560
5310	35.996	15.560
5510	35.958	15.560
5550	35.949	15.560
5670	35.957	15.560
5710	36.004	15.560

802.11ac_VHT80_Ch0

Frequency (MHz)	99% BW (MHz)	10 Log (B) (dB)
5210	75.307	18.770
5290	75.425	18.780
5530	75.340	18.770
5610	75.316	18.770
5690	75.400	18.770

802.11ac_VHT80_Ch1

Frequency (MHz)	99% BW (MHz)	10 Log (B) (dB)
5210	75.402	18.770
5290	75.355	18.770
5530	75.404	18.770
5610	75.388	18.770
5690	75.361	18.770

802.11ax_20_Ch0

Frequency (MHz)	RU config	99% BW (MHz)	10 Log (B) (dB)
5180	full	18.879	12.760
5220	full	18.854	12.750
5240	full	18.876	12.760
5260	full	18.853	12.750
5300	full	18.903	12.770
5320	full	18.875	12.760
5500	full	18.865	12.760
5580	full	18.871	12.760
5700	full	18.891	12.760
5720	full	18.875	12.760

802.11ax_20_Ch1

Frequency (MHz)	RU config	99% BW (MHz)	10 Log (B) (dB)
5180	full	18.878	12.760
5220	full	18.856	12.750
5240	full	18.881	12.760
5260	full	18.897	12.760
5300	full	18.883	12.760
5320	full	18.857	12.750
5500	full	18.874	12.760
5580	full	18.893	12.760
5700	full	18.884	12.760
5720	full	18.883	12.760

Unless otherwise stated the results shown in this test report refer only to the sample(s) tested and such sample(s) are retained for 90 days only.

除非另有說明，此報告結果僅對測試之樣品負責，同時此樣品僅保留90天。本報告未經本公司書面許可，不可部份複製。

This document is issued by the Company subject to its General Conditions of Service printed overleaf, available on request or accessible at <http://www.sgs.com.tw/Terms-and-Conditions> and for electronic format documents, subject to Terms and Conditions for Electronic Documents at <http://www.sgs.com.tw/Terms-and-Conditions>. Attention is drawn to the limitation of liability, indemnification and jurisdiction issues defined therein. Any holder of this document is advised that information contained hereon reflects the Company's findings at the time of its intervention only and within the limits of Client's instructions, if any. The Company's sole responsibility is to its Client and this document does not exonerate parties to a transaction from exercising all their rights and obligations under the transaction documents. This document cannot be reproduced except in full, without prior written approval of the Company. Any unauthorized alteration, forgery or falsification of the content or appearance of this document is unlawful and offenders may be prosecuted to the fullest extent of the law.

802.11ax _40_Ch0

Frequency (MHz)	RU config	99% BW (MHz)	10 Log (B) (dB)
5190	full	37.607	15.750
5230	full	37.623	15.750
5270	full	37.600	15.750
5310	full	37.689	15.760
5510	full	37.632	15.760
5550	full	37.568	15.750
5670	full	37.609	15.750
5710	full	37.643	15.760

802.11ax _40_Ch1

Frequency (MHz)	RU config	99% BW (MHz)	10 Log (B) (dB)
5190	full	37.603	15.750
5230	full	37.594	15.750
5270	full	37.596	15.750
5310	full	37.648	15.760
5510	full	37.659	15.760
5550	full	37.726	15.770
5670	full	37.674	15.760
5710	full	37.703	15.760

802.11ax _80_Ch0

Frequency (MHz)	RU config	99% BW (MHz)	10 Log (B) (dB)
5210	full	77.151	18.870
5290	full	77.112	18.870
5530	full	77.147	18.870
5610	full	76.955	18.860
5690	full	77.055	18.870

802.11ax _80_Ch1

Frequency (MHz)	RU config	99% BW (MHz)	10 Log (B) (dB)
5210	full	76.975	18.860
5290	full	77.031	18.870
5530	full	77.200	18.880
5610	full	76.898	18.860
5690	full	77.199	18.880

Unless otherwise stated the results shown in this test report refer only to the sample(s) tested and such sample(s) are retained for 90 days only.

除非另有說明，此報告結果僅對測試之樣品負責，同時此樣品僅保留90天。本報告未經本公司書面許可，不可部份複製。

This document is issued by the Company subject to its General Conditions of Service printed overleaf, available on request or accessible at <http://www.sgs.com.tw/Terms-and-Conditions> and for electronic format documents, subject to Terms and Conditions for Electronic Documents at <http://www.sgs.com.tw/Terms-and-Conditions>. Attention is drawn to the limitation of liability, indemnification and jurisdiction issues defined therein. Any holder of this document is advised that information contained hereon reflects the Company's findings at the time of its intervention only and within the limits of Client's instructions, if any. The Company's sole responsibility is to its Client and this document does not exonerate parties to a transaction from exercising all their rights and obligations under the transaction documents. This document cannot be reproduced except in full, without prior written approval of the Company. Any unauthorized alteration, forgery or falsification of the content or appearance of this document is unlawful and offenders may be prosecuted to the fullest extent of the law.

8.5.4 6dB Bandwidth (5725 MHz~ 5850 MHz) measure with sample detector for ISED
802.11a_Ch0

Frequency (MHz)	6dB BW (MHz)	10 Log (B) (dB)
5745	16.250	12.110
5785	16.370	12.140
5825	16.310	12.120

802.11n_HT20_Ch0

Frequency (MHz)	6dB BW (MHz)	10 Log (B) (dB)
5745	17.530	12.440
5785	17.450	12.420
5825	17.560	12.450

802.11n_HT20_Ch1

Frequency (MHz)	6dB BW (MHz)	10 Log (B) (dB)
5745	17.450	12.420
5785	17.410	12.410
5825	17.480	12.430

802.11n_HT40_Ch0

Frequency (MHz)	6dB BW (MHz)	10 Log (B) (dB)
5755	36.160	15.580
5795	36.170	15.580

802.11n_HT40_Ch1

Frequency (MHz)	6dB BW (MHz)	10 Log (B) (dB)
5755	36.170	15.580
5795	36.140	15.580

802.11ac_VHT80_Ch0

Frequency (MHz)	6dB BW (MHz)	10 Log (B) (dB)
5775	75.950	18.810

802.11ac_VHT80_Ch1

Frequency (MHz)	6dB BW (MHz)	10 Log (B) (dB)
5775	75.720	18.790

802.11ax_20_Ch0

Frequency (MHz)	RU config	6dB BW (MHz)	10 Log (B) (dB)
5745	full	18.790	12.740
5785	full	18.750	12.730
5825	full	18.780	12.740

802.11ax_20_Ch1

Frequency (MHz)	RU config	6dB BW (MHz)	10 Log (B) (dB)
5745	full	18.810	12.740
5785	full	18.880	12.760
5825	full	18.950	12.780

802.11ax_40_Ch0

Frequency (MHz)	RU config	6dB BW (MHz)	10 Log (B) (dB)
5755	full	37.660	15.760
5795	full	37.780	15.770

802.11ax_40_Ch1

Frequency (MHz)	RU config	6dB BW (MHz)	10 Log (B) (dB)
5755	full	37.750	15.770
5795	full	37.460	15.740

Unless otherwise stated the results shown in this test report refer only to the sample(s) tested and such sample(s) are retained for 90 days only.

除非另有說明，此報告結果僅對測試之樣品負責，同時此樣品僅保留90天。本報告未經本公司書面許可，不可部份複製。

This document is issued by the Company subject to its General Conditions of Service printed overleaf, available on request or accessible at <http://www.sgs.com.tw/Terms-and-Conditions> and for electronic format documents, subject to Terms and Conditions for Electronic Documents at <http://www.sgs.com.tw/Terms-and-Conditions>. Attention is drawn to the limitation of liability, indemnification and jurisdiction issues defined therein. Any holder of this document is advised that information contained hereon reflects the Company's findings at the time of its intervention only and within the limits of Client's instructions, if any. The Company's sole responsibility is to its Client and this document does not exonerate parties to a transaction from exercising all their rights and obligations under the transaction documents. This document cannot be reproduced except in full, without prior written approval of the Company. Any unauthorized alteration, forgery or falsification of the content or appearance of this document is unlawful and offenders may be prosecuted to the fullest extent of the law.

802.11ax _80_Ch0

Frequency (MHz)	RU config	6dB BW (MHz)	10 Log (B) (dB)
5775	full	76.430	18.830

802.11ax _80_Ch1

Frequency (MHz)	RU config	6dB BW (MHz)	10 Log (B) (dB)
5775	full	77.170	18.870

Unless otherwise stated the results shown in this test report refer only to the sample(s) tested and such sample(s) are retained for 90 days only.

除非另有說明，此報告結果僅對測試之樣品負責，同時此樣品僅保留90天。本報告未經本公司書面許可，不可部份複製。

This document is issued by the Company subject to its General Conditions of Service printed overleaf, available on request or accessible at <http://www.sgs.com.tw/Terms-and-Conditions> and for electronic format documents, subject to Terms and Conditions for Electronic Documents at <http://www.sgs.com.tw/Terms-and-Conditions>. Attention is drawn to the limitation of liability, indemnification and jurisdiction issues defined therein. Any holder of this document is advised that information contained hereon reflects the Company's findings at the time of its intervention only and within the limits of Client's instructions, if any. The Company's sole responsibility is to its Client and this document does not exonerate parties to a transaction from exercising all their rights and obligations under the transaction documents. This document cannot be reproduced except in full, without prior written approval of the Company. Any unauthorized alteration, forgery or falsification of the content or appearance of this document is unlawful and offenders may be prosecuted to the fullest extent of the law.

8.5.1 BW Verification for DFS Function

802.11a_Ch0

Freq. (MHz)	Measured Freq. (MHz)	Limit (MHz)
5240	5248.19	< 5250
5745	5736.85	> 5725

802.11n_HT20_Ch0

Freq. (MHz)	Measured Freq. (MHz)	Limit (MHz)
5240	5248.82	< 5250
5745	5736.21	> 5725

802.11n_HT20_Ch1

Freq. (MHz)	Measured Freq. (MHz)	Limit (MHz)
5240	5248.80	< 5250
5745	5736.22	> 5725

802.11n_HT40_Ch0

Freq. (MHz)	Measured Freq. (MHz)	Limit (MHz)
5230	5248.43	< 5250
5755	5736.99	> 5725

802.11n_HT40_Ch1

Freq. (MHz)	Measured Freq. (MHz)	Limit (MHz)
5230	5248.06	< 5250
5755	5736.99	> 5725

802.11ac_VHT80_Ch0

Freq. (MHz)	Measured Freq. (MHz)	Limit (MHz)
5210	5247.72	< 5250
5775	5737.34	> 5725

802.11ac_VHT80_Ch1

Freq. (MHz)	Measured Freq. (MHz)	Limit (MHz)
5210	5247.70	< 5250
5775	5737.25	> 5725

802.11ax_20_Ch0

Freq. (MHz)	Measured Freq. (MHz)	Limit (MHz)
5240	5249.44	< 5250
5745	5735.58	> 5725

802.11ax_20_Ch1

Freq. (MHz)	Measured Freq. (MHz)	Limit (MHz)
5240	5249.48	< 5250
5745	5735.55	> 5725

Unless otherwise stated the results shown in this test report refer only to the sample(s) tested and such sample(s) are retained for 90 days only.

除非另有說明，此報告結果僅對測試之樣品負責，同時此樣品僅保留90天。本報告未經本公司書面許可，不可部份複製。

This document is issued by the Company subject to its General Conditions of Service printed overleaf, available on request or accessible at <http://www.sgs.com.tw/Terms-and-Conditions> and for electronic format documents, subject to Terms and Conditions for Electronic Documents at <http://www.sgs.com.tw/Terms-and-Conditions>. Attention is drawn to the limitation of liability, indemnification and jurisdiction issues defined therein. Any holder of this document is advised that information contained hereon reflects the Company's findings at the time of its intervention only and within the limits of Client's instructions, if any. The Company's sole responsibility is to its Client and this document does not exonerate parties to a transaction from exercising all their rights and obligations under the transaction documents. This document cannot be reproduced except in full, without prior written approval of the Company. Any unauthorized alteration, forgery or falsification of the content or appearance of this document is unlawful and offenders may be prosecuted to the fullest extent of the law.

802.11ax _40_Ch0

Freq. (MHz)	Measured Freq. (MHz)	Limit (MHz)
5230	5248.86	< 5250
5755	5736.23	> 5725

802.11ax _40_Ch1

Freq. (MHz)	Measured Freq. (MHz)	Limit (MHz)
5230	5248.84	< 5250
5755	5736.19	> 5725

802.11ax _VHT80_Ch0

Freq. (MHz)	Measured Freq. (MHz)	Limit (MHz)
5210	5248.54	< 5250
5775	5736.49	> 5725

802.11ax _VHT80_Ch1

Freq. (MHz)	Measured Freq. (MHz)	Limit (MHz)
5210	5248.56	< 5250
5775	5736.40	> 5725

Unless otherwise stated the results shown in this test report refer only to the sample(s) tested and such sample(s) are retained for 90 days only.

除非另有說明，此報告結果僅對測試之樣品負責，同時此樣品僅保留90天。本報告未經本公司書面許可，不可部份複製。

This document is issued by the Company subject to its General Conditions of Service printed overleaf, available on request or accessible at <http://www.sgs.com.tw/Terms-and-Conditions> and for electronic format documents, subject to Terms and Conditions for Electronic Documents at <http://www.sgs.com.tw/Terms-and-Conditions>. Attention is drawn to the limitation of liability, indemnification and jurisdiction issues defined therein. Any holder of this document is advised that information contained hereon reflects the Company's findings at the time of its intervention only and within the limits of Client's instructions, if any. The Company's sole responsibility is to its Client and this document does not exonerate parties to a transaction from exercising all their rights and obligations under the transaction documents. This document cannot be reproduced except in full, without prior written approval of the Company. Any unauthorized alteration, forgery or falsification of the content or appearance of this document is unlawful and offenders may be prosecuted to the fullest extent of the law.

802.11a_20MHz_Chain0_5180MHz

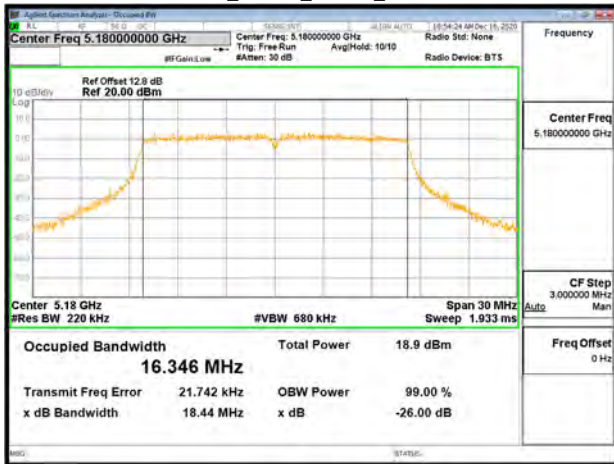

802.11a_20MHz_Chain0_5260MHz



802.11a_20MHz_Chain0_5220MHz

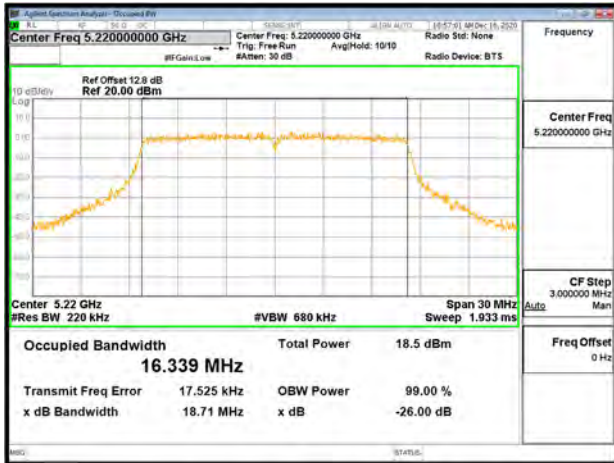

802.11a_20MHz_Chain0_5300MHz

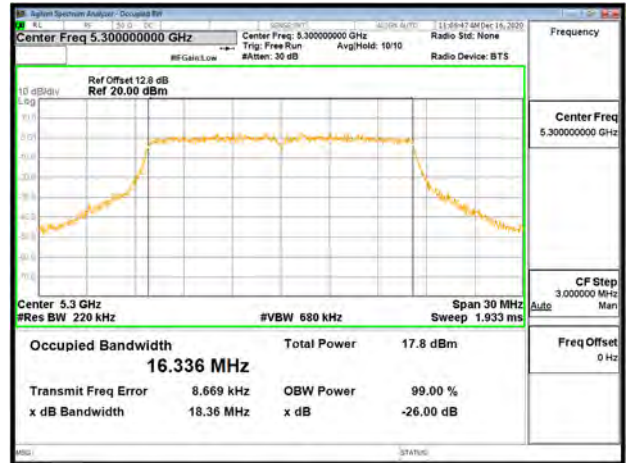

802.11a_20MHz_Chain0_5240MHz

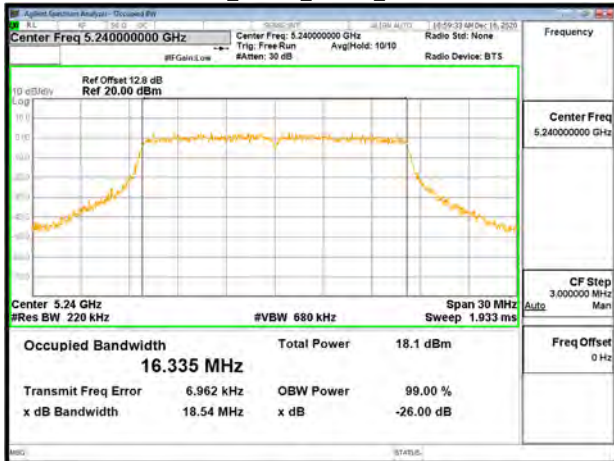

802.11a_20MHz_Chain0_5320MHz

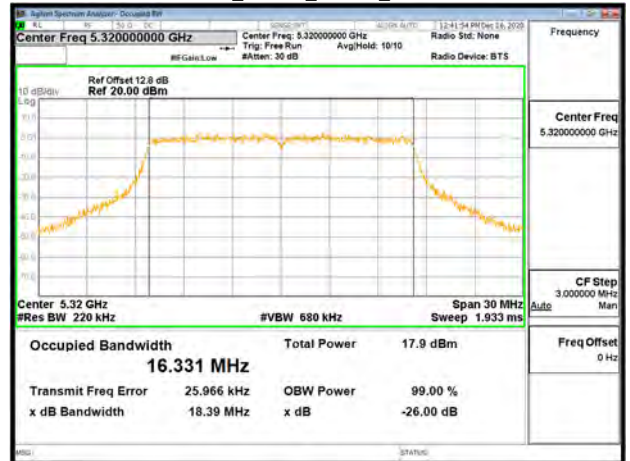

Unless otherwise stated the results shown in this test report refer only to the sample(s) tested and such sample(s) are retained for 90 days only.

除非另有說明，此報告結果僅對測試之樣品負責，同時此樣品僅保留90天。本報告未經本公司書面許可，不可部份複製。

This document is issued by the Company subject to its General Conditions of Service printed overleaf, available on request or accessible at <http://www.sgs.com.tw/Terms-and-Conditions> and for electronic format documents, subject to Terms and Conditions for Electronic Documents at <http://www.sgs.com.tw/Terms-and-Conditions>. Attention is drawn to the limitation of liability, indemnification and jurisdiction issues defined therein. Any holder of this document is advised that information contained hereon reflects the Company's findings at the time of its intervention only and within the limits of Client's instructions, if any. The Company's sole responsibility is to its Client and this document does not exonerate parties to a transaction from exercising all their rights and obligations under the transaction documents. This document cannot be reproduced except in full, without prior written approval of the Company. Any unauthorized alteration, forgery or falsification of the content or appearance of this document is unlawful and offenders may be prosecuted to the fullest extent of the law.

802.11a_20MHz_Chain0_5500MHz

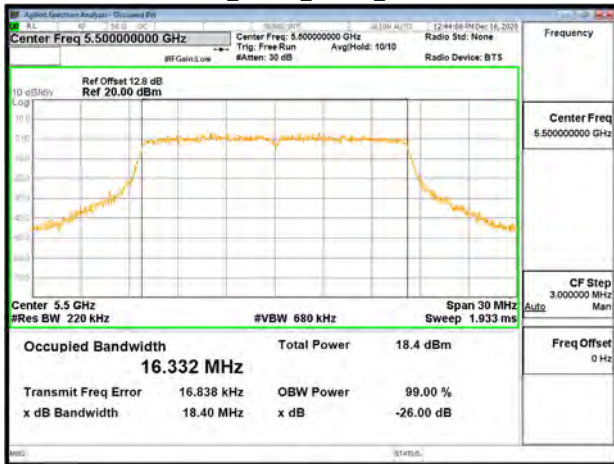

802.11a_20MHz_Chain0_5720MHz

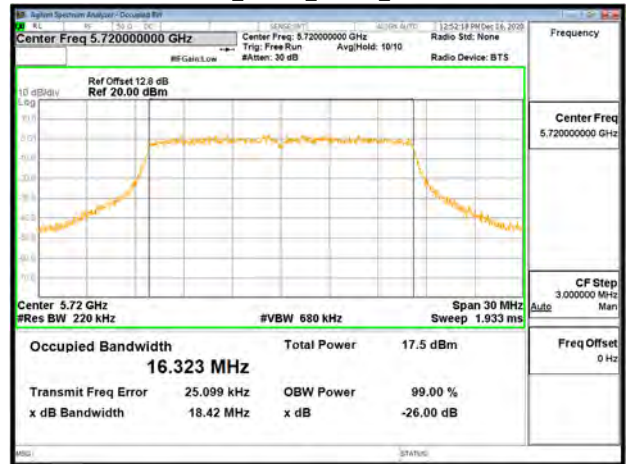

802.11a_20MHz_Chain0_5580MHz

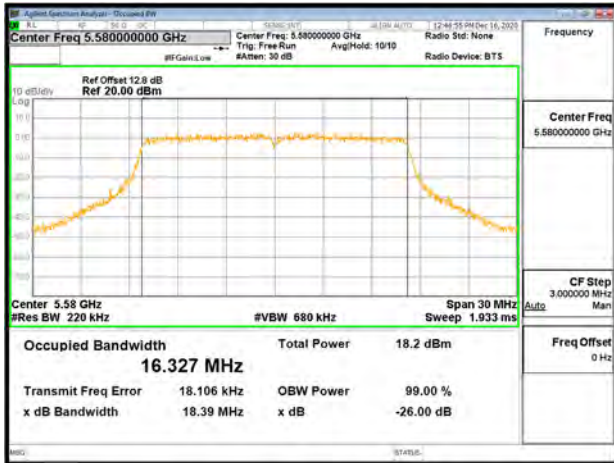

802.11a_20MHz_Chain0_5745MHz

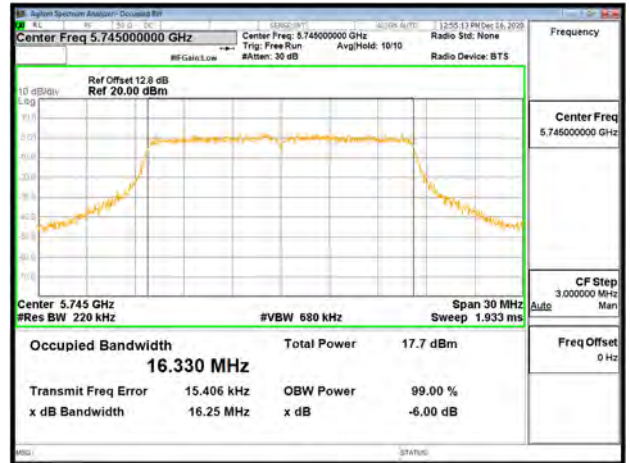

802.11a_20MHz_Chain0_5700MHz

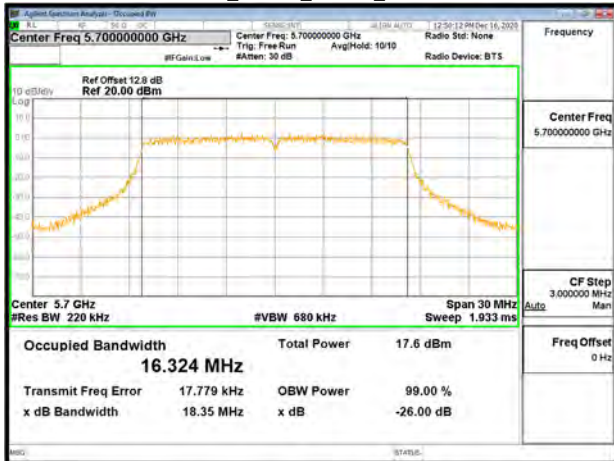

802.11a_20MHz_Chain0_5785MHz

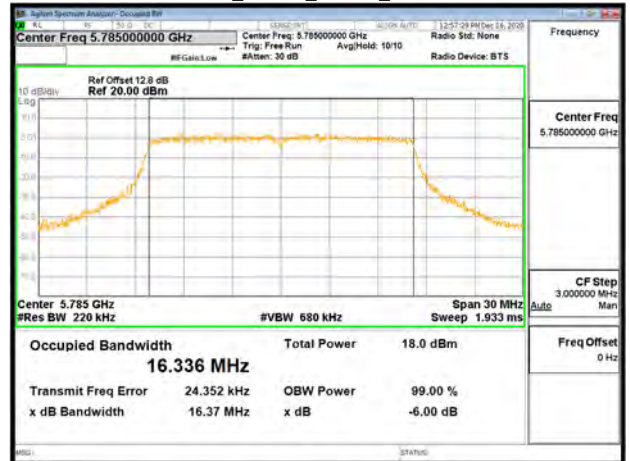

Unless otherwise stated the results shown in this test report refer only to the sample(s) tested and such sample(s) are retained for 90 days only.

除非另有說明，此報告結果僅對測試之樣品負責，同時此樣品僅保留90天。本報告未經本公司書面許可，不可部份複製。

This document is issued by the Company subject to its General Conditions of Service printed overleaf, available on request or accessible at <http://www.sgs.com.tw/Terms-and-Conditions> and for electronic format documents, subject to Terms and Conditions for Electronic Documents at <http://www.sgs.com.tw/Terms-and-Conditions>. Attention is drawn to the limitation of liability, indemnification and jurisdiction issues defined therein. Any holder of this document is advised that information contained hereon reflects the Company's findings at the time of its intervention only and within the limits of Client's instructions, if any. The Company's sole responsibility is to its Client and this document does not exonerate parties to a transaction from exercising all their rights and obligations under the transaction documents. This document cannot be reproduced except in full, without prior written approval of the Company. Any unauthorized alteration, forgery or falsification of the content or appearance of this document is unlawful and offenders may be prosecuted to the fullest extent of the law.

802.11a_20MHz_Chain0_5825MHz

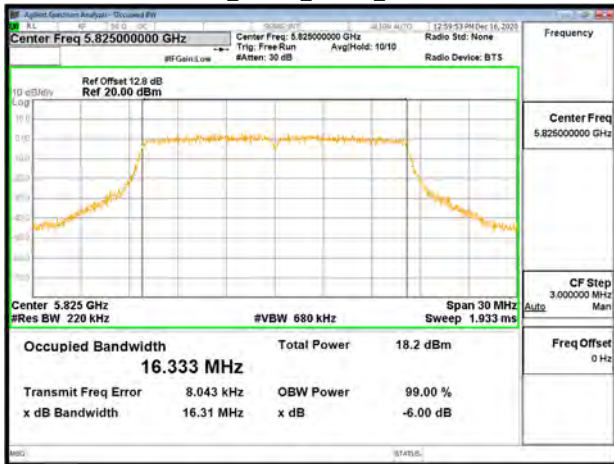

802.11n_20MHz_Chain0_5240MHz

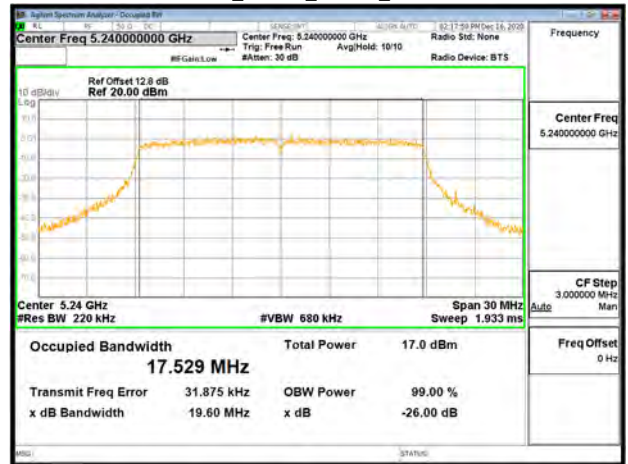

802.11n_20MHz_Chain0_5180MHz

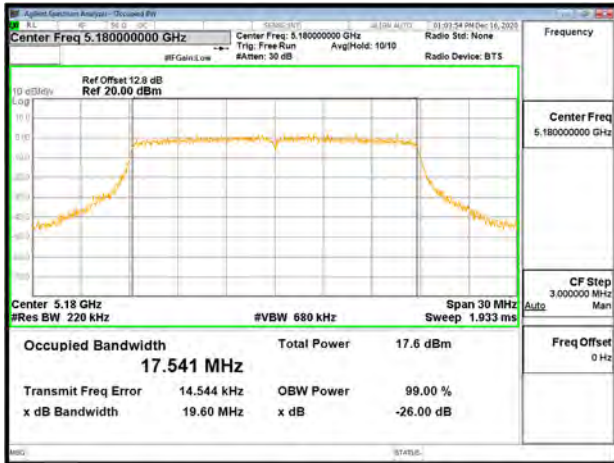

802.11n_20MHz_Chain0_5260MHz

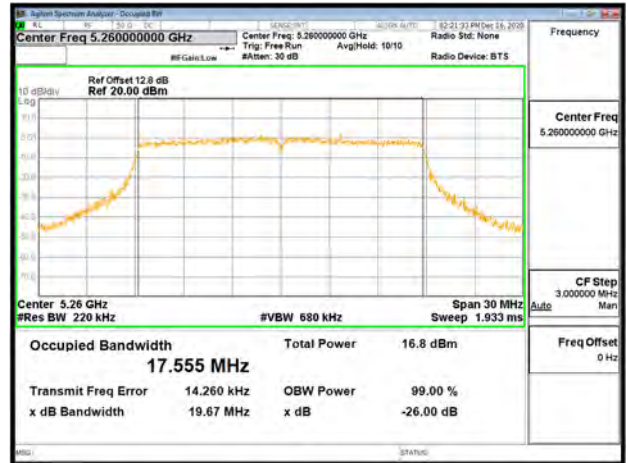

802.11n_20MHz_Chain0_5220MHz

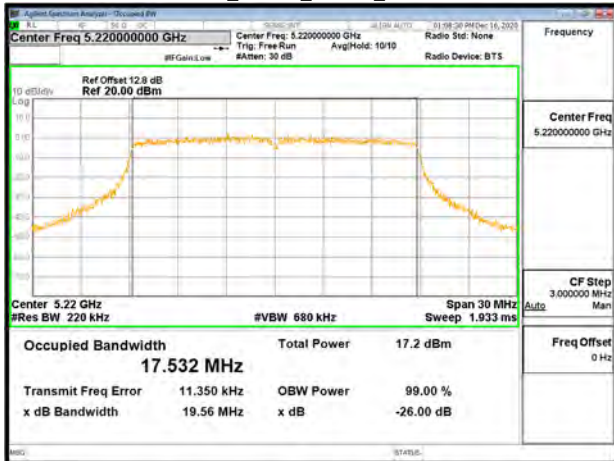

802.11n_20MHz_Chain0_5300MHz

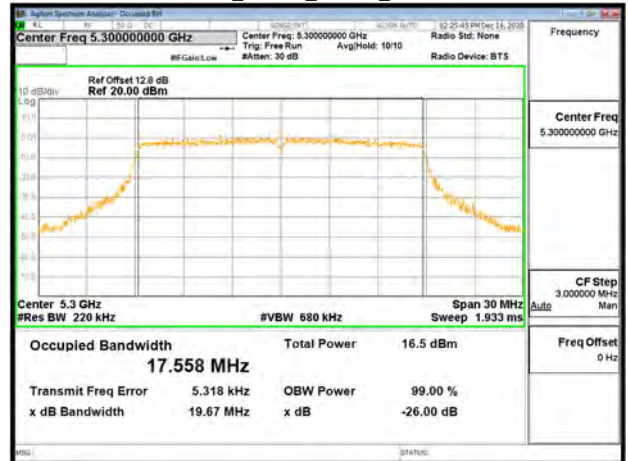

Unless otherwise stated the results shown in this test report refer only to the sample(s) tested and such sample(s) are retained for 90 days only.

除非另有說明，此報告結果僅對測試之樣品負責，同時此樣品僅保留90天。本報告未經本公司書面許可，不可部份複製。

This document is issued by the Company subject to its General Conditions of Service printed overleaf, available on request or accessible at <http://www.sgs.com.tw/Terms-and-Conditions> and for electronic format documents, subject to Terms and Conditions for Electronic Documents at <http://www.sgs.com.tw/Terms-and-Conditions>. Attention is drawn to the limitation of liability, indemnification and jurisdiction issues defined therein. Any holder of this document is advised that information contained hereon reflects the Company's findings at the time of its intervention only and within the limits of Client's instructions, if any. The Company's sole responsibility is to its Client and this document does not exonerate parties to a transaction from exercising all their rights and obligations under the transaction documents. This document cannot be reproduced except in full, without prior written approval of the Company. Any unauthorized alteration, forgery or falsification of the content or appearance of this document is unlawful and offenders may be prosecuted to the fullest extent of the law.

802.11n_20MHz_Chain0_5320MHz

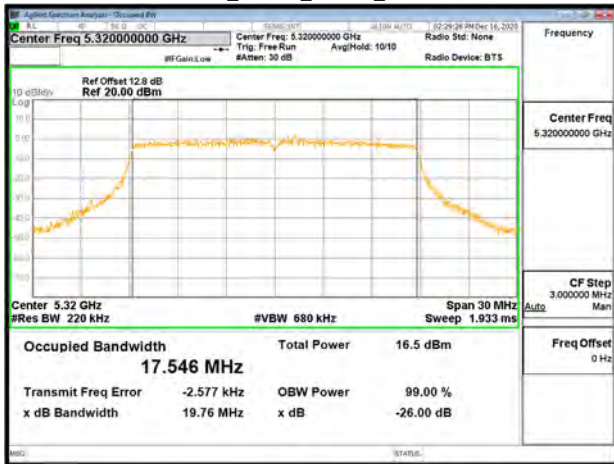

802.11n_20MHz_Chain0_5700MHz

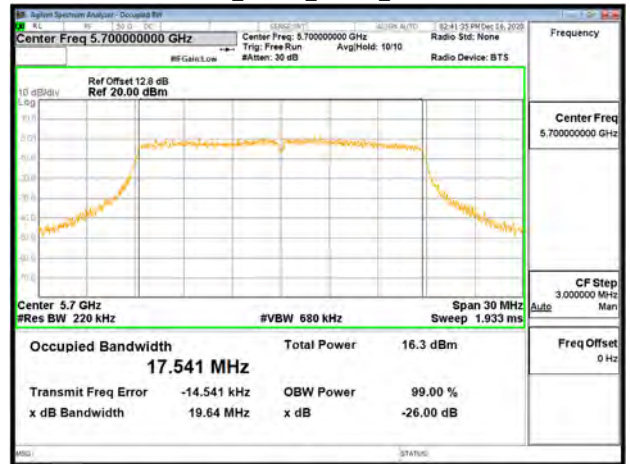

802.11n_20MHz_Chain0_5500MHz

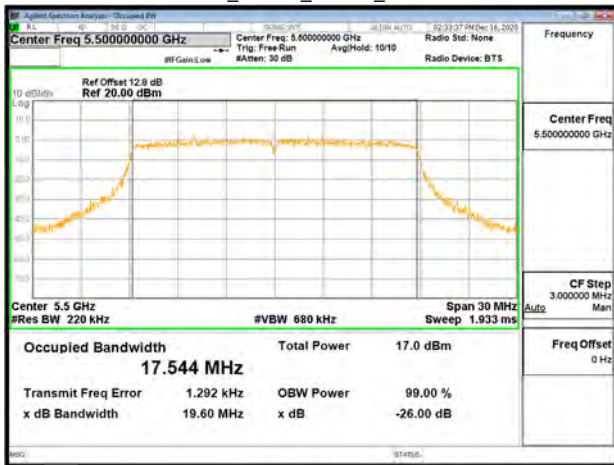

802.11n_20MHz_Chain0_5720MHz

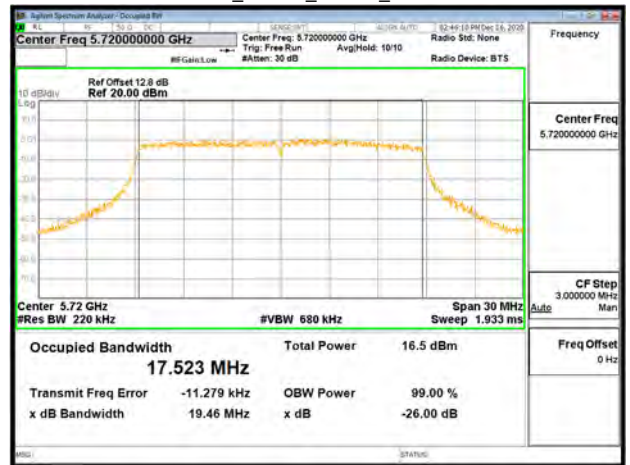

802.11n_20MHz_Chain0_5580MHz

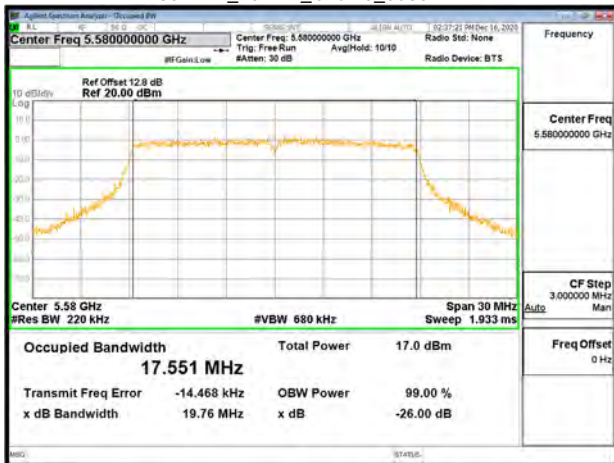

802.11n_20MHz_Chain0_5745MHz

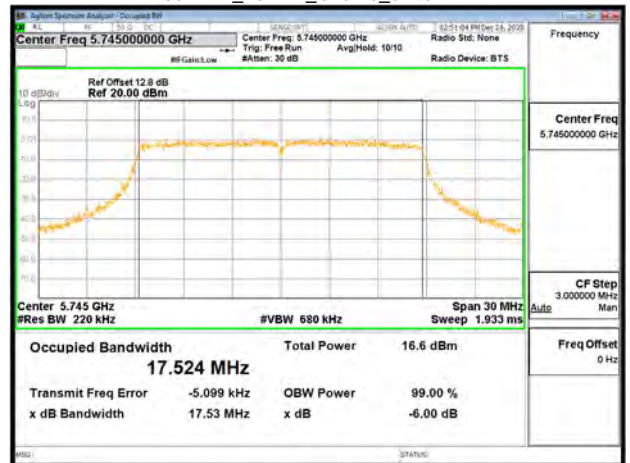

Unless otherwise stated the results shown in this test report refer only to the sample(s) tested and such sample(s) are retained for 90 days only.

除非另有說明，此報告結果僅對測試之樣品負責，同時此樣品僅保留90天。本報告未經本公司書面許可，不可部份複製。

This document is issued by the Company subject to its General Conditions of Service printed overleaf, available on request or accessible at <http://www.sgs.com.tw/Terms-and-Conditions> and for electronic format documents, subject to Terms and Conditions for Electronic Documents at <http://www.sgs.com.tw/Terms-and-Conditions>. Attention is drawn to the limitation of liability, indemnification and jurisdiction issues defined therein. Any holder of this document is advised that information contained hereon reflects the Company's findings at the time of its intervention only and within the limits of Client's instructions, if any. The Company's sole responsibility is to its Client and this document does not exonerate parties to a transaction from exercising all their rights and obligations under the transaction documents. This document cannot be reproduced except in full, without prior written approval of the Company. Any unauthorized alteration, forgery or falsification of the content or appearance of this document is unlawful and offenders may be prosecuted to the fullest extent of the law.

802.11n_20MHz_Chain0_5785MHz

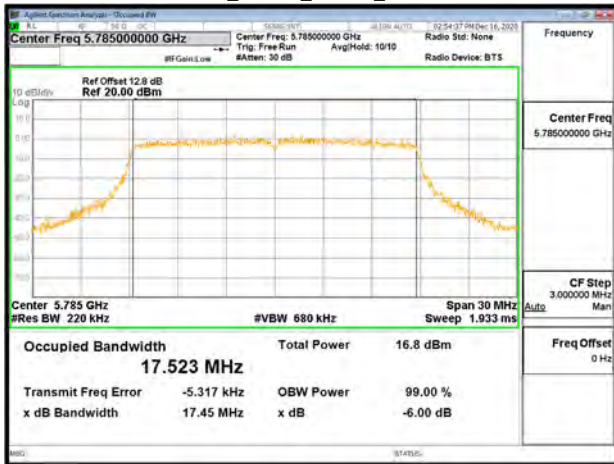

802.11n_20MHz_Chain1_5220MHz

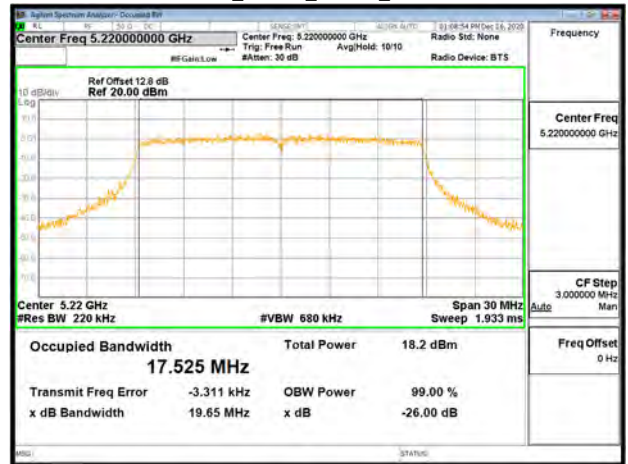

802.11n_20MHz_Chain0_5825MHz

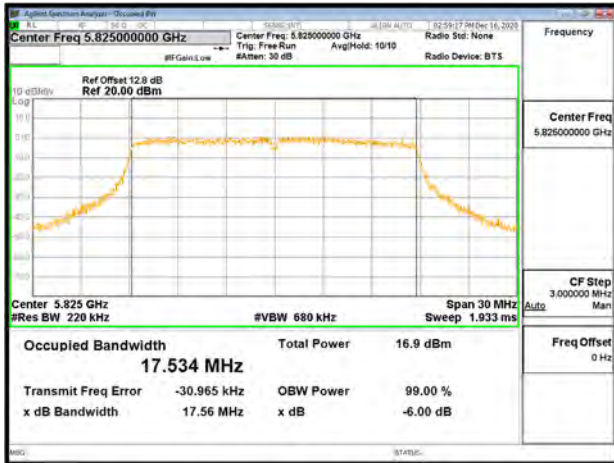

802.11n_20MHz_Chain1_5240MHz

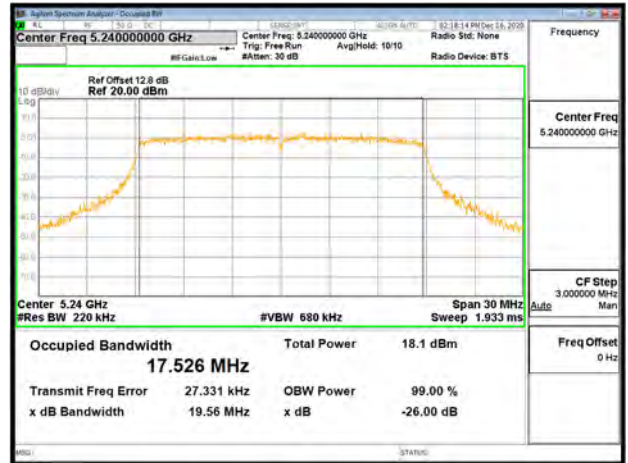

802.11n_20MHz_Chain1_5180MHz

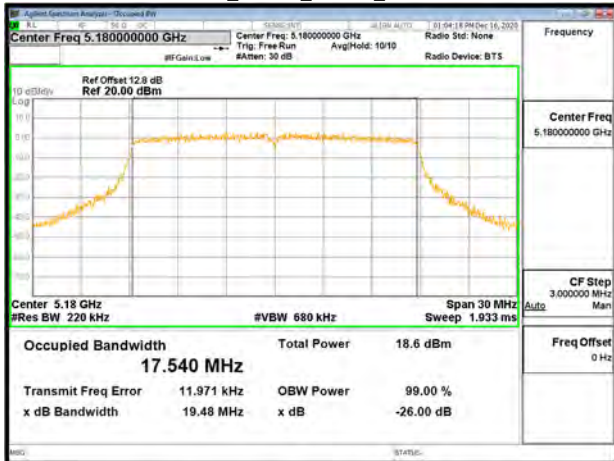

802.11n_20MHz_Chain1_5260MHz

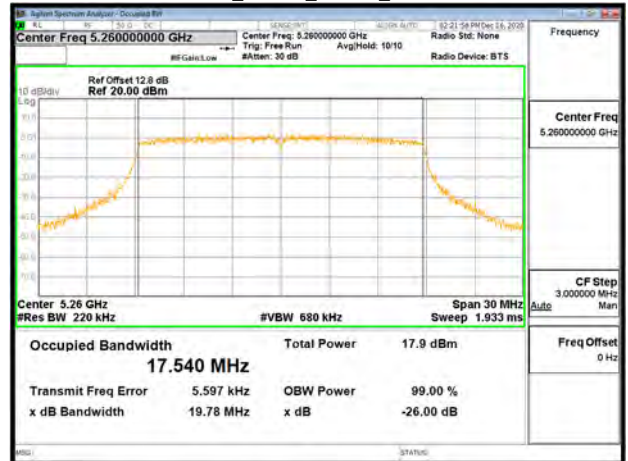

Unless otherwise stated the results shown in this test report refer only to the sample(s) tested and such sample(s) are retained for 90 days only.

除非另有說明，此報告結果僅對測試之樣品負責，同時此樣品僅保留90天。本報告未經本公司書面許可，不可部份複製。

This document is issued by the Company subject to its General Conditions of Service printed overleaf, available on request or accessible at <http://www.sgs.com.tw/Terms-and-Conditions> and for electronic format documents, subject to Terms and Conditions for Electronic Documents at <http://www.sgs.com.tw/Terms-and-Conditions>. Attention is drawn to the limitation of liability, indemnification and jurisdiction issues defined therein. Any holder of this document is advised that information contained hereon reflects the Company's findings at the time of its intervention only and within the limits of Client's instructions, if any. The Company's sole responsibility is to its Client and this document does not exonerate parties to a transaction from exercising all their rights and obligations under the transaction documents. This document cannot be reproduced except in full, without prior written approval of the Company. Any unauthorized alteration, forgery or falsification of the content or appearance of this document is unlawful and offenders may be prosecuted to the fullest extent of the law.

802.11n_20MHz_Chain1_5300MHz

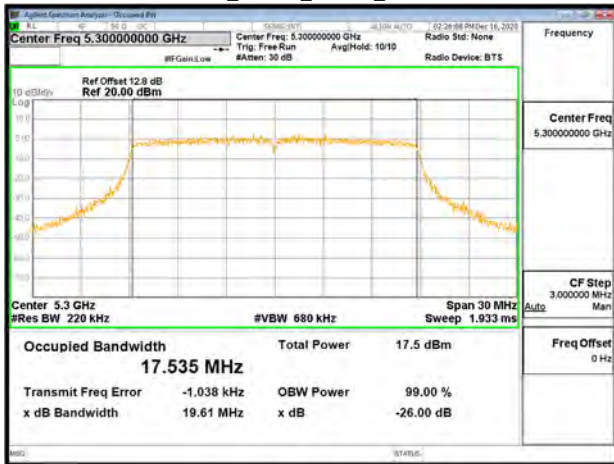

802.11n_20MHz_Chain1_5580MHz

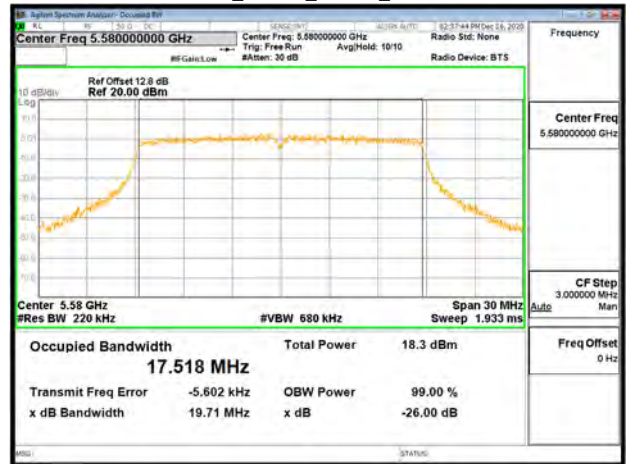

802.11n_20MHz_Chain1_5320MHz

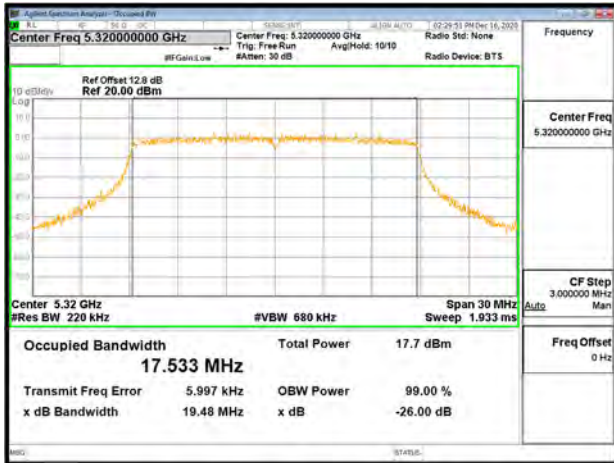

802.11n_20MHz_Chain1_5700MHz

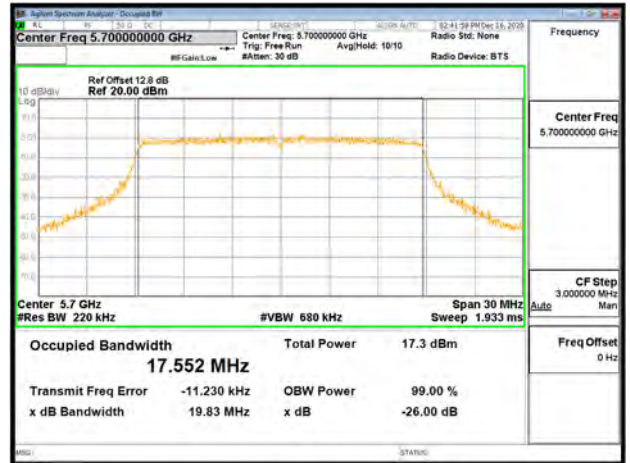

802.11n_20MHz_Chain1_5500MHz

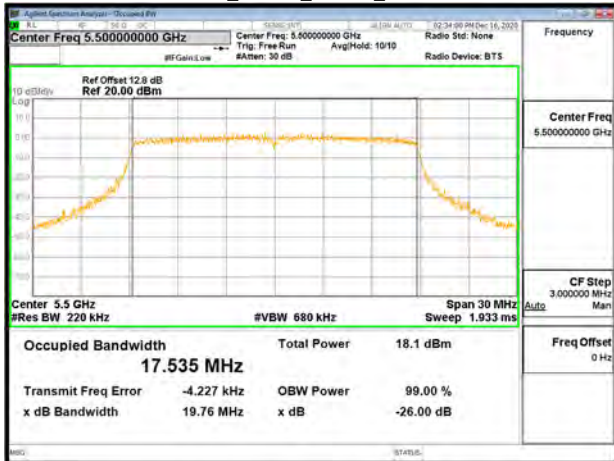

802.11n_20MHz_Chain1_5720MHz

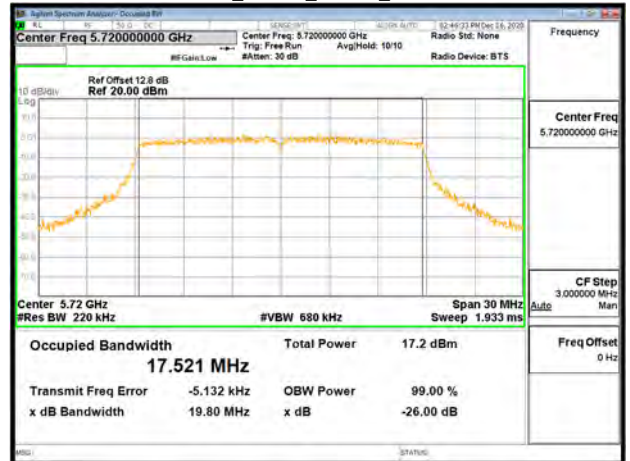

Unless otherwise stated the results shown in this test report refer only to the sample(s) tested and such sample(s) are retained for 90 days only.

除非另有說明，此報告結果僅對測試之樣品負責，同時此樣品僅保留90天。本報告未經本公司書面許可，不可部份複製。

This document is issued by the Company subject to its General Conditions of Service printed overleaf, available on request or accessible at <http://www.sgs.com.tw/Terms-and-Conditions> and for electronic format documents, subject to Terms and Conditions for Electronic Documents at <http://www.sgs.com.tw/Terms-and-Conditions>. Attention is drawn to the limitation of liability, indemnification and jurisdiction issues defined therein. Any holder of this document is advised that information contained hereon reflects the Company's findings at the time of its intervention only and within the limits of Client's instructions, if any. The Company's sole responsibility is to its Client and this document does not exonerate parties to a transaction from exercising all their rights and obligations under the transaction documents. This document cannot be reproduced except in full, without prior written approval of the Company. Any unauthorized alteration, forgery or falsification of the content or appearance of this document is unlawful and offenders may be prosecuted to the fullest extent of the law.

802.11n_20MHz_Chain1_5745MHz



802.11n_40MHz_Chain0_5190MHz

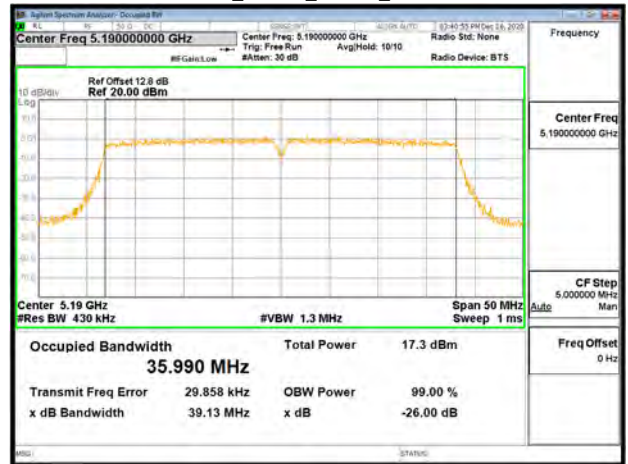

802.11n_20MHz_Chain1_5785MHz

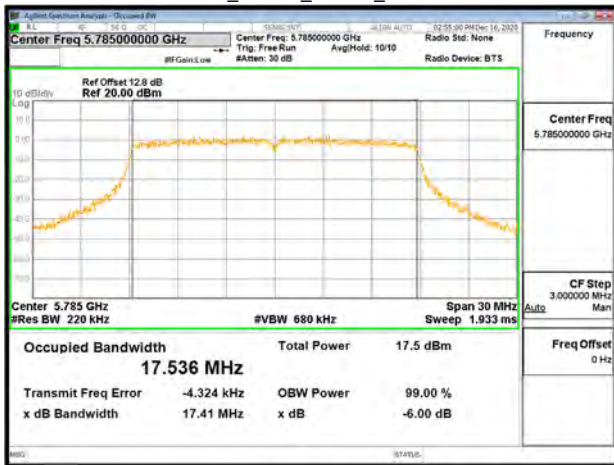

802.11n_40MHz_Chain0_5230MHz

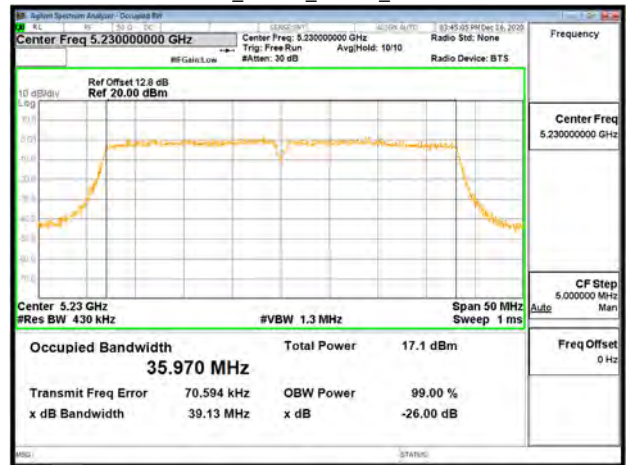

802.11n_20MHz_Chain1_5825MHz



802.11n_40MHz_Chain0_5270MHz

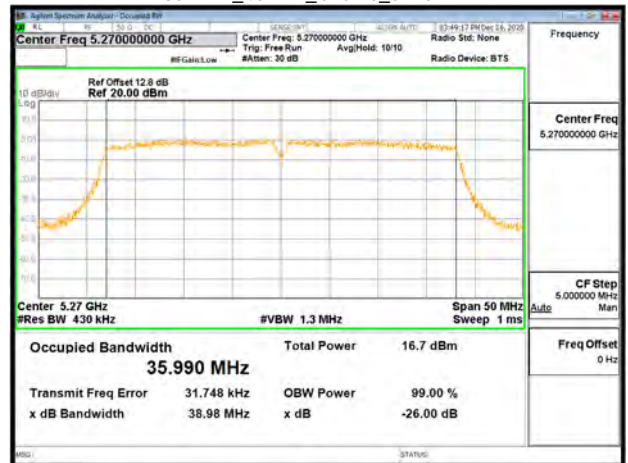

Unless otherwise stated the results shown in this test report refer only to the sample(s) tested and such sample(s) are retained for 90 days only.

除非另有說明，此報告結果僅對測試之樣品負責，同時此樣品僅保留90天。本報告未經本公司書面許可，不可部份複製。

This document is issued by the Company subject to its General Conditions of Service printed overleaf, available on request or accessible at <http://www.sgs.com.tw/Terms-and-Conditions> and for electronic format documents, subject to Terms and Conditions for Electronic Documents at <http://www.sgs.com.tw/Terms-and-Conditions>. Attention is drawn to the limitation of liability, indemnification and jurisdiction issues defined therein. Any holder of this document is advised that information contained hereon reflects the Company's findings at the time of its intervention only and within the limits of Client's instructions, if any. The Company's sole responsibility is to its Client and this document does not exonerate parties to a transaction from exercising all their rights and obligations under the transaction documents. This document cannot be reproduced except in full, without prior written approval of the Company. Any unauthorized alteration, forgery or falsification of the content or appearance of this document is unlawful and offenders may be prosecuted to the fullest extent of the law.

802.11n_40MHz_Chain0_5310MHz

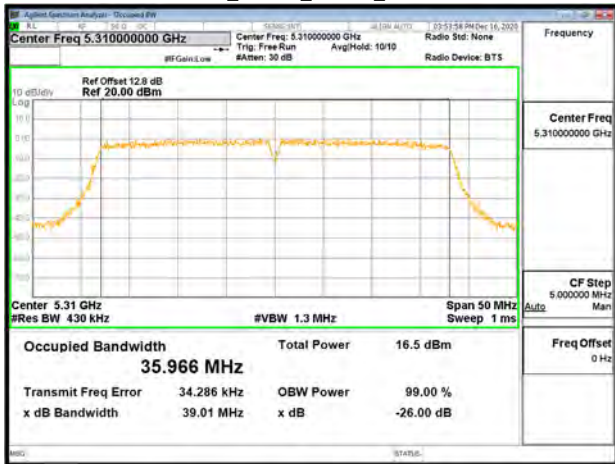

802.11n_40MHz_Chain0_5670MHz

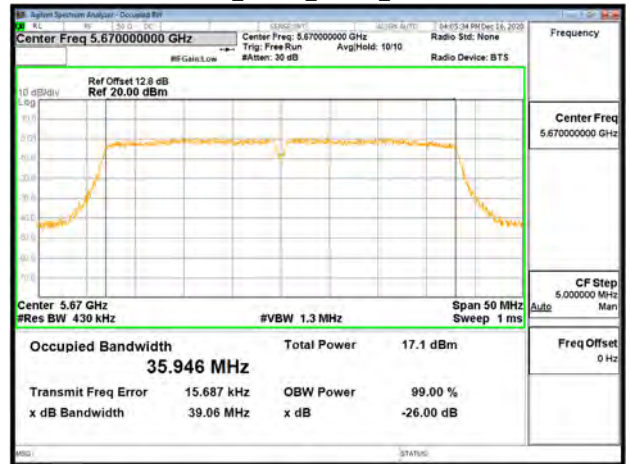

802.11n_40MHz_Chain0_5510MHz

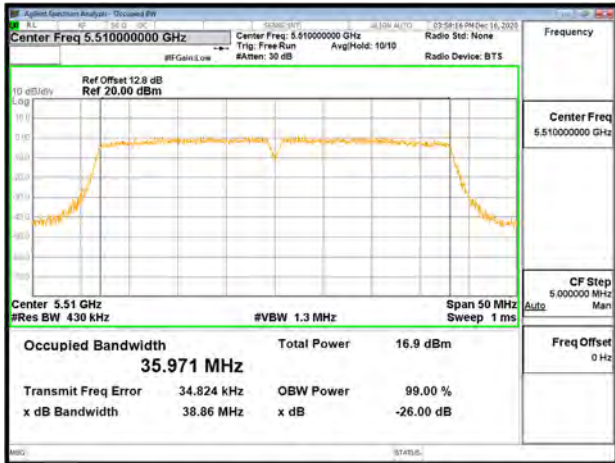

802.11n_40MHz_Chain0_5710MHz

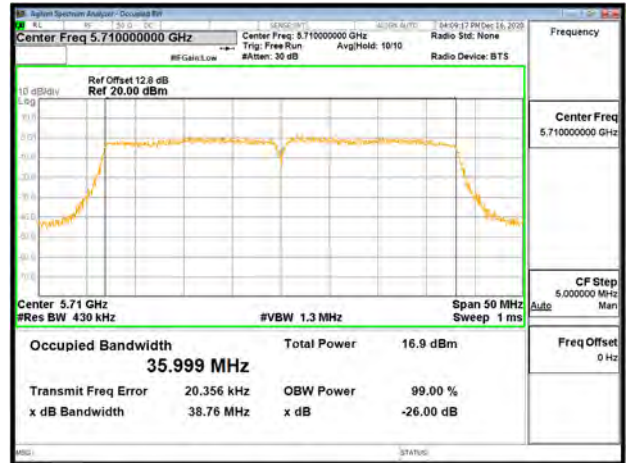

802.11n_40MHz_Chain0_5550MHz

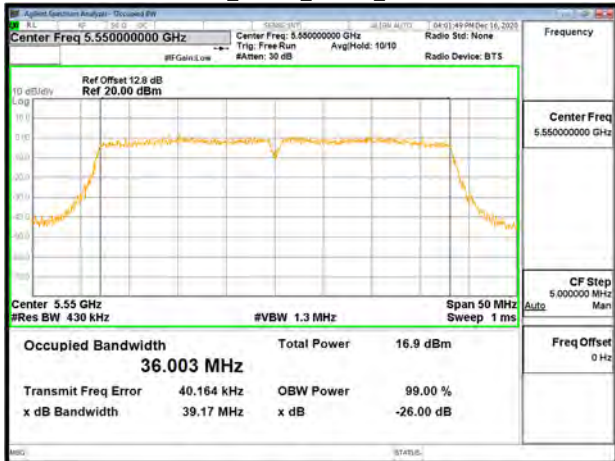

802.11n_40MHz_Chain0_5755MHz

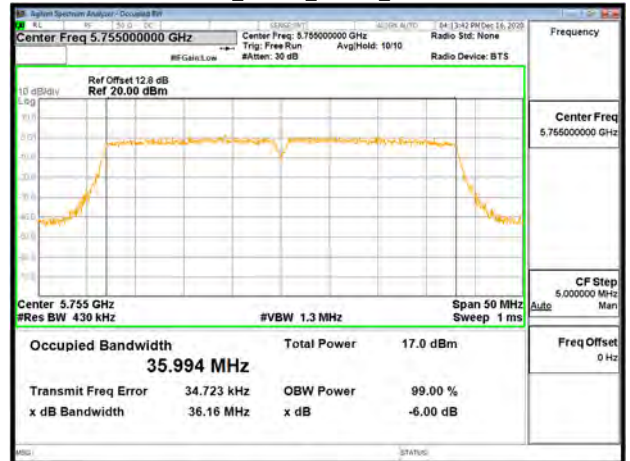

Unless otherwise stated the results shown in this test report refer only to the sample(s) tested and such sample(s) are retained for 90 days only.

除非另有說明，此報告結果僅對測試之樣品負責，同時此樣品僅保留90天。本報告未經本公司書面許可，不可部份複製。

This document is issued by the Company subject to its General Conditions of Service printed overleaf, available on request or accessible at <http://www.sgs.com.tw/Terms-and-Conditions> and for electronic format documents, subject to Terms and Conditions for Electronic Documents at <http://www.sgs.com.tw/Terms-and-Conditions>. Attention is drawn to the limitation of liability, indemnification and jurisdiction issues defined therein. Any holder of this document is advised that information contained hereon reflects the Company's findings at the time of its intervention only and within the limits of Client's instructions, if any. The Company's sole responsibility is to its Client and this document does not exonerate parties to a transaction from exercising all their rights and obligations under the transaction documents. This document cannot be reproduced except in full, without prior written approval of the Company. Any unauthorized alteration, forgery or falsification of the content or appearance of this document is unlawful and offenders may be prosecuted to the fullest extent of the law.

802.11n_40MHz_Chain0_5795MHz

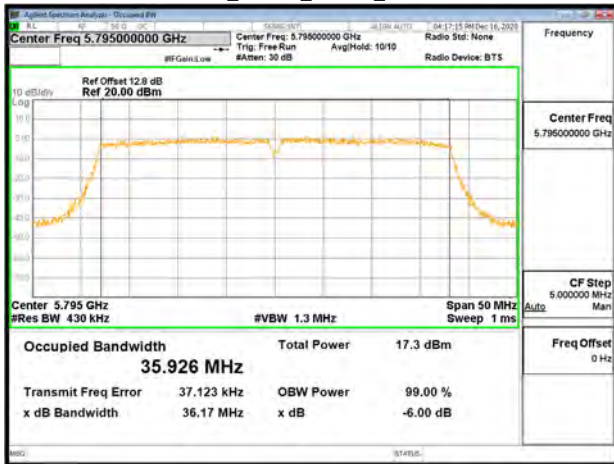

802.11n_40MHz_Chain1_5270MHz

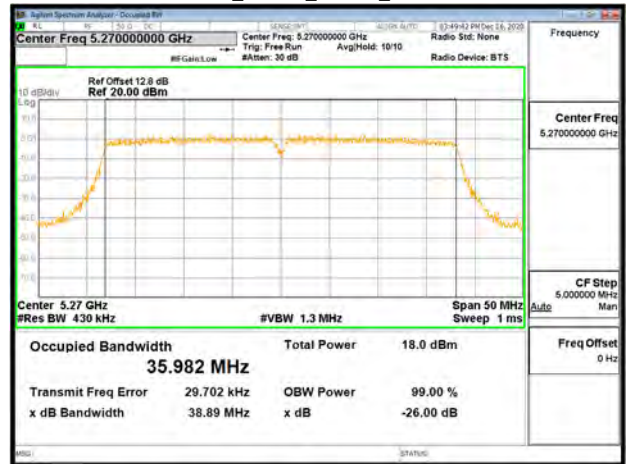

802.11n_40MHz_Chain1_5190MHz

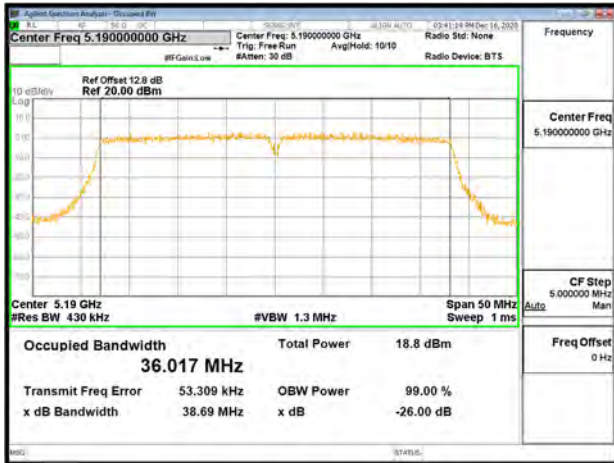

802.11n_40MHz_Chain1_5310MHz

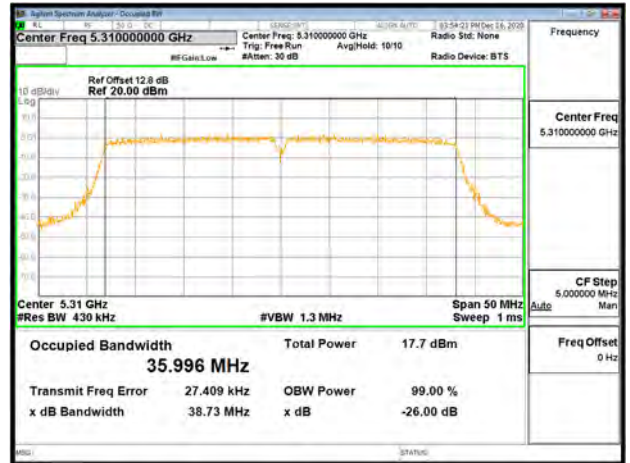

802.11n_40MHz_Chain1_5230MHz

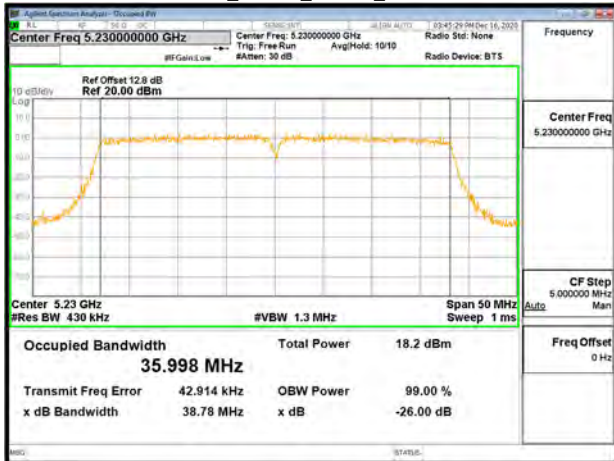

802.11n_40MHz_Chain1_5510MHz

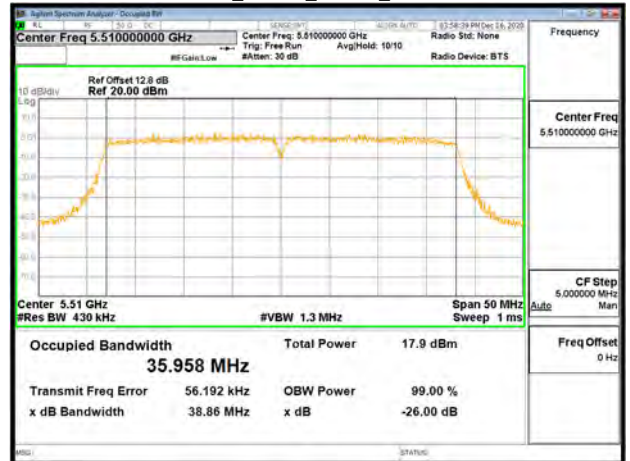

Unless otherwise stated the results shown in this test report refer only to the sample(s) tested and such sample(s) are retained for 90 days only.

除非另有說明，此報告結果僅對測試之樣品負責，同時此樣品僅保留90天。本報告未經本公司書面許可，不可部份複製。

This document is issued by the Company subject to its General Conditions of Service printed overleaf, available on request or accessible at <http://www.sgs.com.tw/Terms-and-Conditions> and for electronic format documents, subject to Terms and Conditions for Electronic Documents at <http://www.sgs.com.tw/Terms-and-Conditions>. Attention is drawn to the limitation of liability, indemnification and jurisdiction issues defined therein. Any holder of this document is advised that information contained hereon reflects the Company's findings at the time of its intervention only and within the limits of Client's instructions, if any. The Company's sole responsibility is to its Client and this document does not exonerate parties to a transaction from exercising all their rights and obligations under the transaction documents. This document cannot be reproduced except in full, without prior written approval of the Company. Any unauthorized alteration, forgery or falsification of the content or appearance of this document is unlawful and offenders may be prosecuted to the fullest extent of the law.

802.11n_40MHz_Chain1_5550MHz

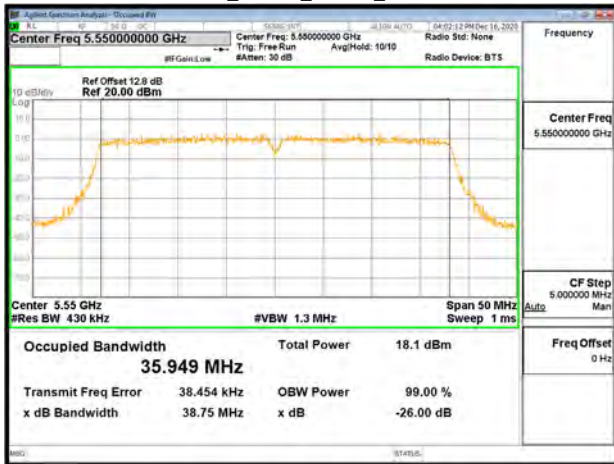

802.11n_40MHz_Chain1_5755MHz

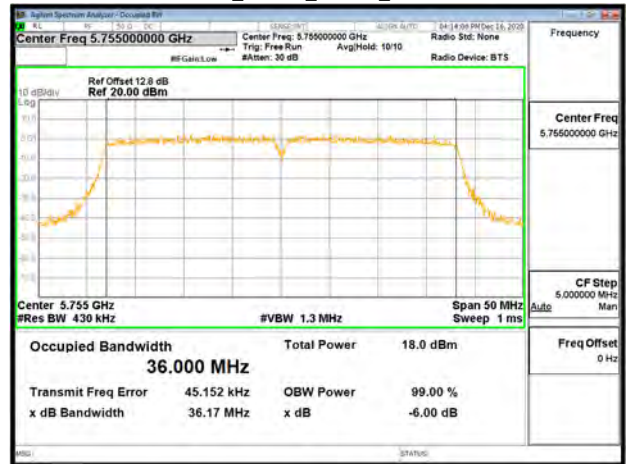

802.11n_40MHz_Chain1_5670MHz

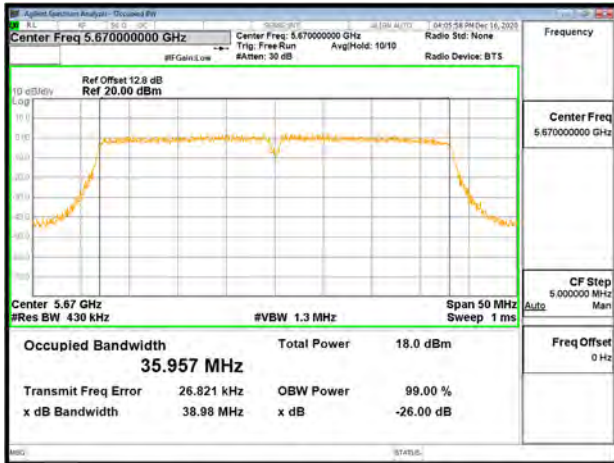

802.11n_40MHz_Chain1_5795MHz

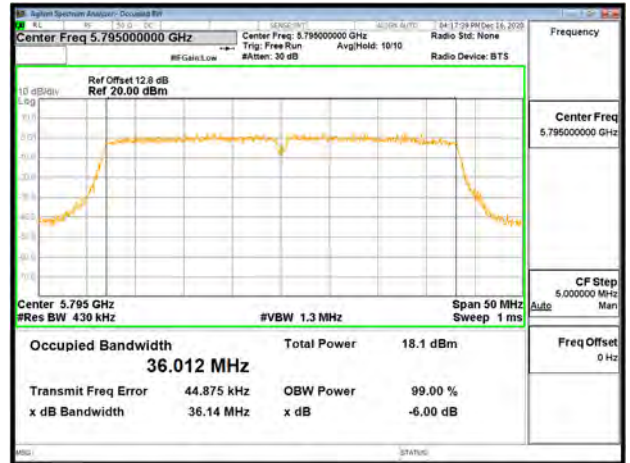

802.11n_40MHz_Chain1_5710MHz

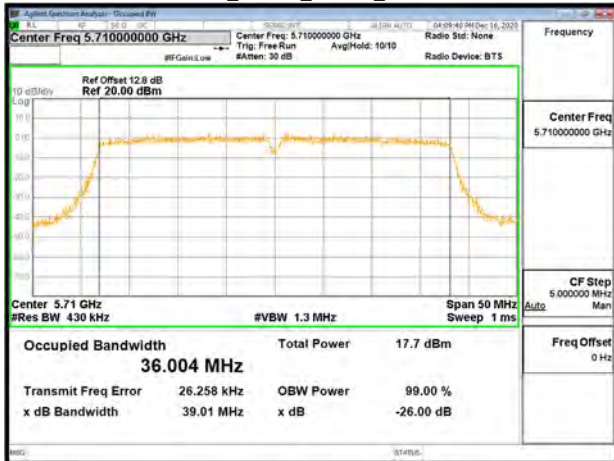

802.11ac_80MHz_Chain0_5210MHz

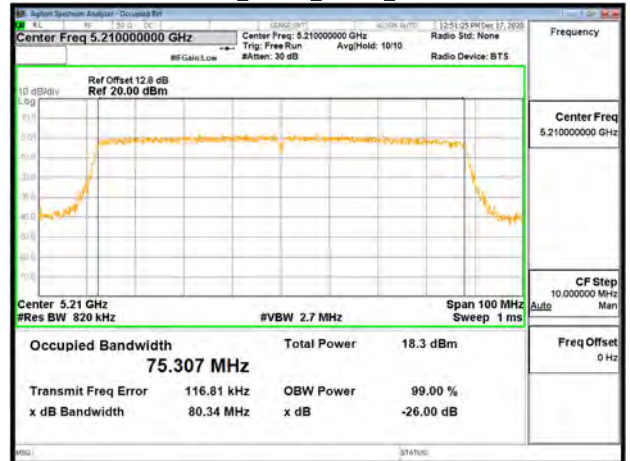

Unless otherwise stated the results shown in this test report refer only to the sample(s) tested and such sample(s) are retained for 90 days only.

除非另有說明，此報告結果僅對測試之樣品負責，同時此樣品僅保留90天。本報告未經本公司書面許可，不可部份複製。

This document is issued by the Company subject to its General Conditions of Service printed overleaf, available on request or accessible at <http://www.sgs.com.tw/Terms-and-Conditions> and for electronic format documents, subject to Terms and Conditions for Electronic Documents at <http://www.sgs.com.tw/Terms-and-Conditions>. Attention is drawn to the limitation of liability, indemnification and jurisdiction issues defined therein. Any holder of this document is advised that information contained hereon reflects the Company's findings at the time of its intervention only and within the limits of Client's instructions, if any. The Company's sole responsibility is to its Client and this document does not exonerate parties to a transaction from exercising all their rights and obligations under the transaction documents. This document cannot be reproduced except in full, without prior written approval of the Company. Any unauthorized alteration, forgery or falsification of the content or appearance of this document is unlawful and offenders may be prosecuted to the fullest extent of the law.

802.11ac_80MHz_Chain0_5290MHz

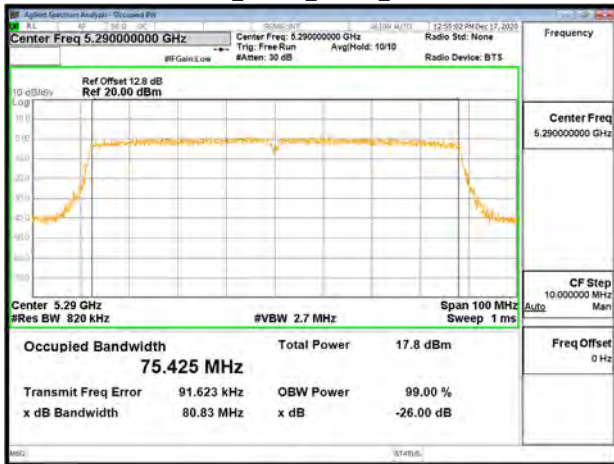

802.11ac_80MHz_Chain0_5690MHz

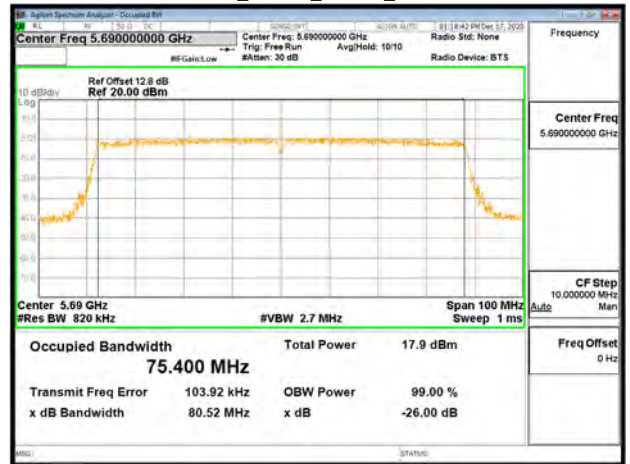

802.11ac_80MHz_Chain0_5530MHz

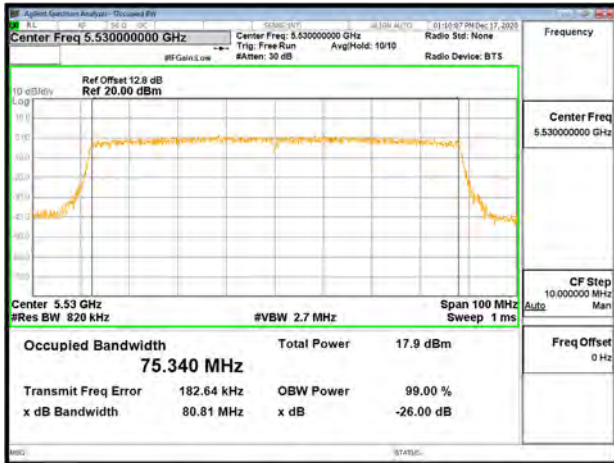

802.11ac_80MHz_Chain0_5775MHz

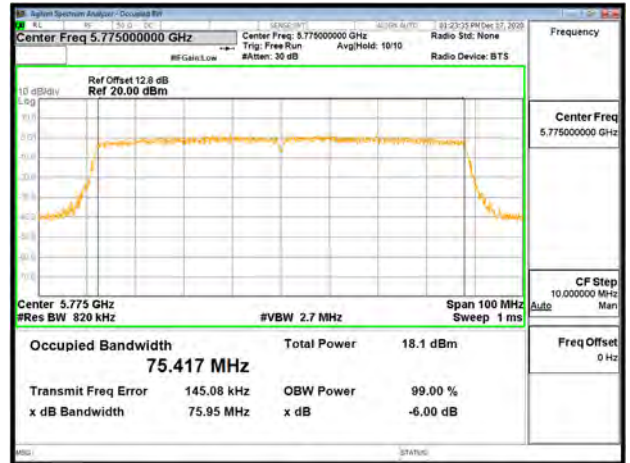

802.11ac_80MHz_Chain0_5610MHz

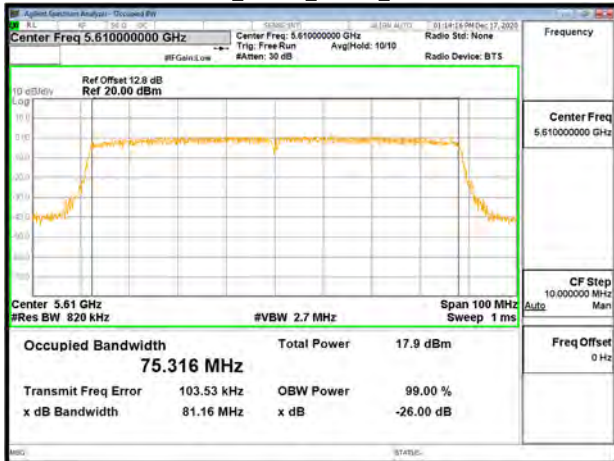

802.11ac_80MHz_Chain1_5210MHz

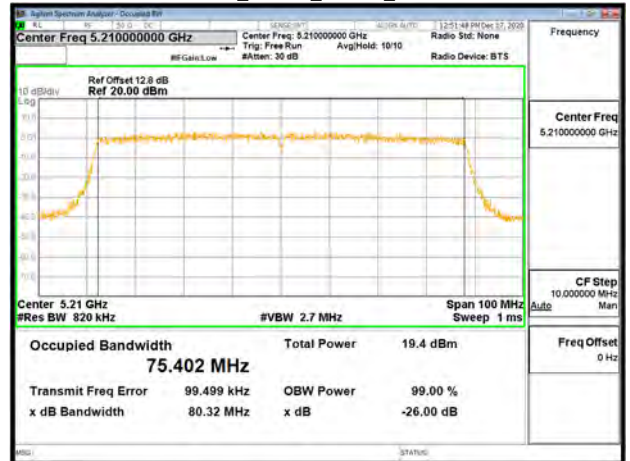

Unless otherwise stated the results shown in this test report refer only to the sample(s) tested and such sample(s) are retained for 90 days only.

除非另有說明，此報告結果僅對測試之樣品負責，同時此樣品僅保留90天。本報告未經本公司書面許可，不可部份複製。

This document is issued by the Company subject to its General Conditions of Service printed overleaf, available on request or accessible at <http://www.sgs.com.tw/Terms-and-Conditions> and for electronic format documents, subject to Terms and Conditions for Electronic Documents at <http://www.sgs.com.tw/Terms-and-Conditions>. Attention is drawn to the limitation of liability, indemnification and jurisdiction issues defined therein. Any holder of this document is advised that information contained hereon reflects the Company's findings at the time of its intervention only and within the limits of Client's instructions, if any. The Company's sole responsibility is to its Client and this document does not exonerate parties to a transaction from exercising all their rights and obligations under the transaction documents. This document cannot be reproduced except in full, without prior written approval of the Company. Any unauthorized alteration, forgery or falsification of the content or appearance of this document is unlawful and offenders may be prosecuted to the fullest extent of the law.

802.11ac_80MHz_Chain1_5290MHz

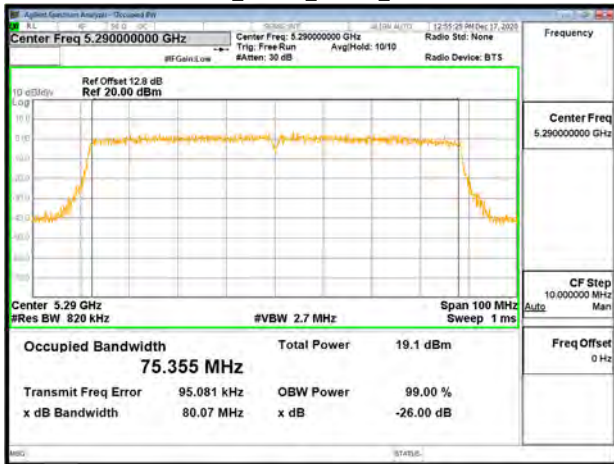

802.11ac_80MHz_Chain1_5690MHz

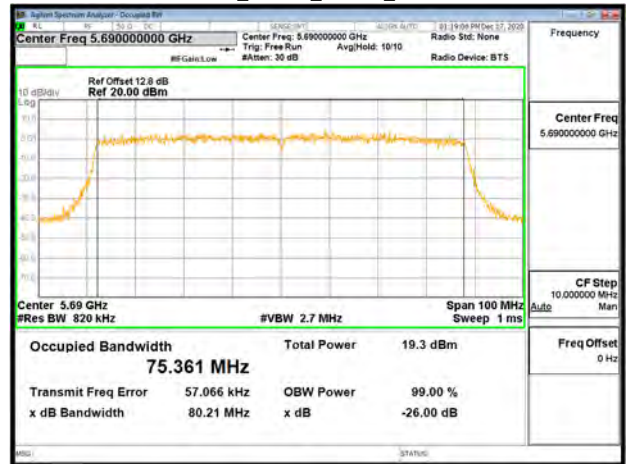

802.11ac_80MHz_Chain1_5530MHz

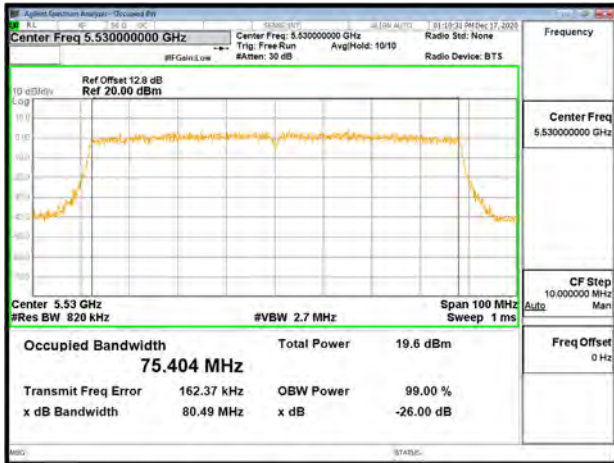

802.11ac_80MHz_Chain1_5775MHz

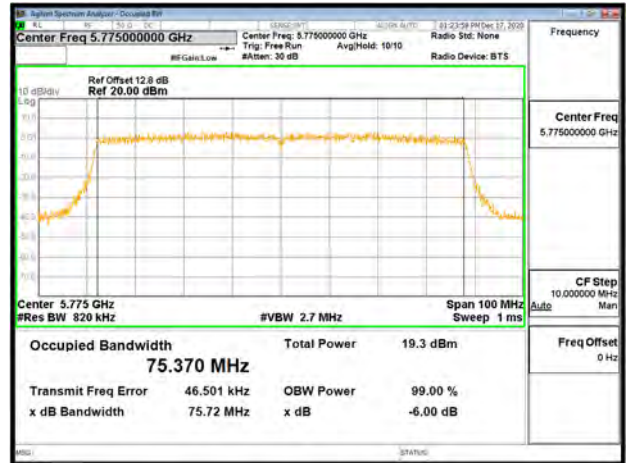

802.11ac_80MHz_Chain1_5610MHz

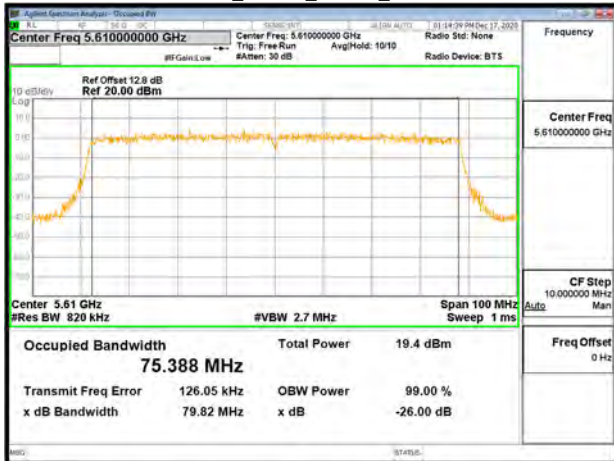

802.11ax_20MHz_Chain0_5180MHz

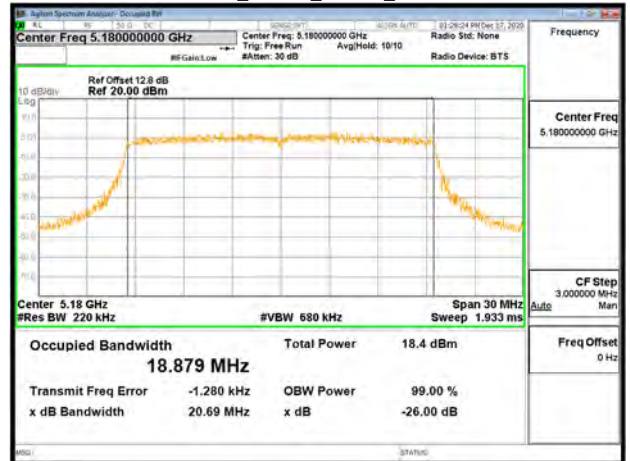

Unless otherwise stated the results shown in this test report refer only to the sample(s) tested and such sample(s) are retained for 90 days only.

除非另有說明，此報告結果僅對測試之樣品負責，同時此樣品僅保留90天。本報告未經本公司書面許可，不可部份複製。

This document is issued by the Company subject to its General Conditions of Service printed overleaf, available on request or accessible at <http://www.sgs.com.tw/Terms-and-Conditions> and for electronic format documents, subject to Terms and Conditions for Electronic Documents at <http://www.sgs.com.tw/Terms-and-Conditions>. Attention is drawn to the limitation of liability, indemnification and jurisdiction issues defined therein. Any holder of this document is advised that information contained hereon reflects the Company's findings at the time of its intervention only and within the limits of Client's instructions, if any. The Company's sole responsibility is to its Client and this document does not exonerate parties to a transaction from exercising all their rights and obligations under the transaction documents. This document cannot be reproduced except in full, without prior written approval of the Company. Any unauthorized alteration, forgery or falsification of the content or appearance of this document is unlawful and offenders may be prosecuted to the fullest extent of the law.

802.11ax_20MHz_Chain0_5220MHz

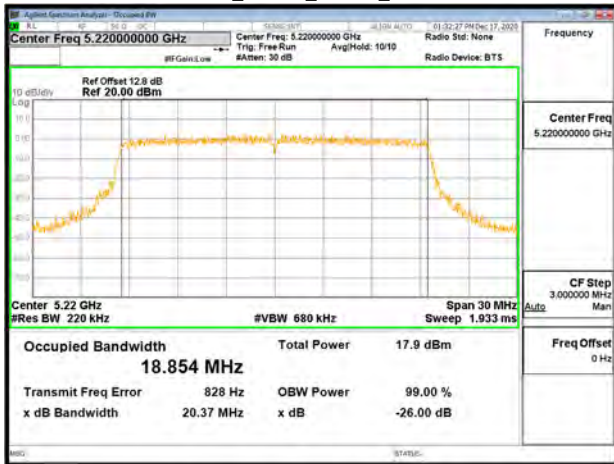

802.11ax_20MHz_Chain0_5300MHz

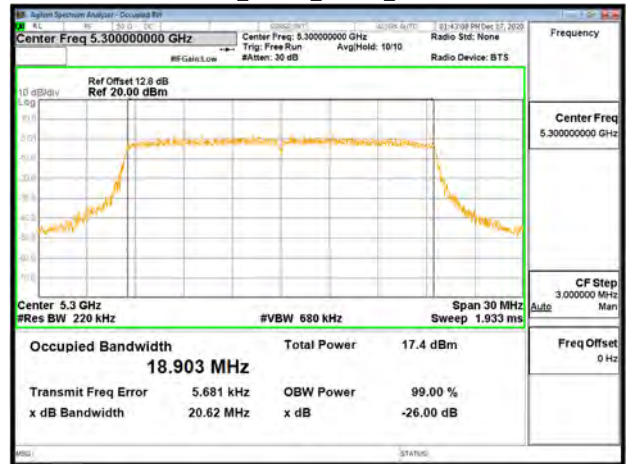

802.11ax_20MHz_Chain0_5240MHz

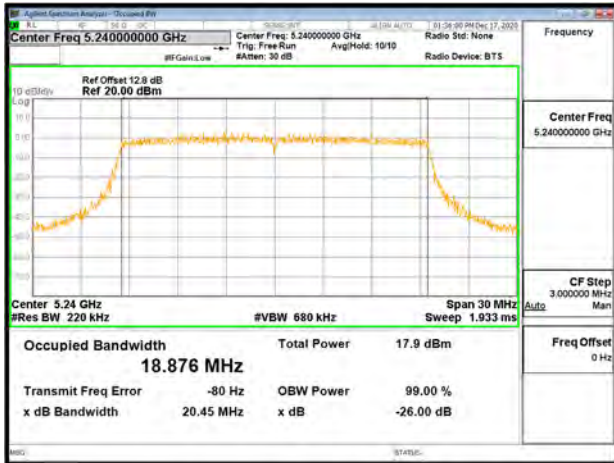

802.11ax_20MHz_Chain0_5320MHz

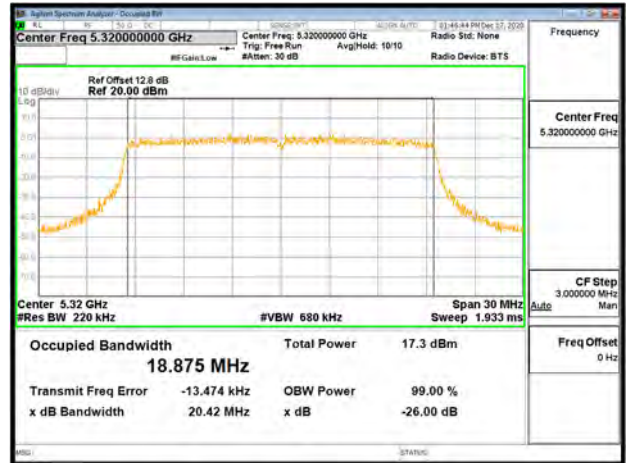

802.11ax_20MHz_Chain0_5260MHz

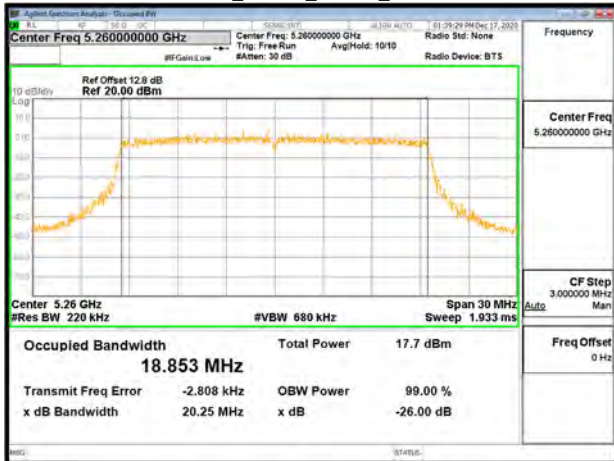

802.11ax_20MHz_Chain0_5500MHz

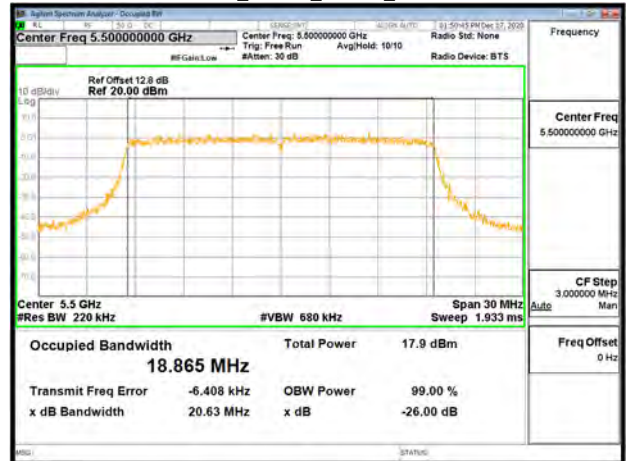

Unless otherwise stated the results shown in this test report refer only to the sample(s) tested and such sample(s) are retained for 90 days only.

除非另有說明，此報告結果僅對測試之樣品負責，同時此樣品僅保留90天。本報告未經本公司書面許可，不可部份複製。

This document is issued by the Company subject to its General Conditions of Service printed overleaf, available on request or accessible at <http://www.sgs.com.tw/Terms-and-Conditions> and for electronic format documents, subject to Terms and Conditions for Electronic Documents at <http://www.sgs.com.tw/Terms-and-Conditions>. Attention is drawn to the limitation of liability, indemnification and jurisdiction issues defined therein. Any holder of this document is advised that information contained hereon reflects the Company's findings at the time of its intervention only and within the limits of Client's instructions, if any. The Company's sole responsibility is to its Client and this document does not exonerate parties to a transaction from exercising all their rights and obligations under the transaction documents. This document cannot be reproduced except in full, without prior written approval of the Company. Any unauthorized alteration, forgery or falsification of the content or appearance of this document is unlawful and offenders may be prosecuted to the fullest extent of the law.

802.11ax_20MHz_Chain0_5580MHz

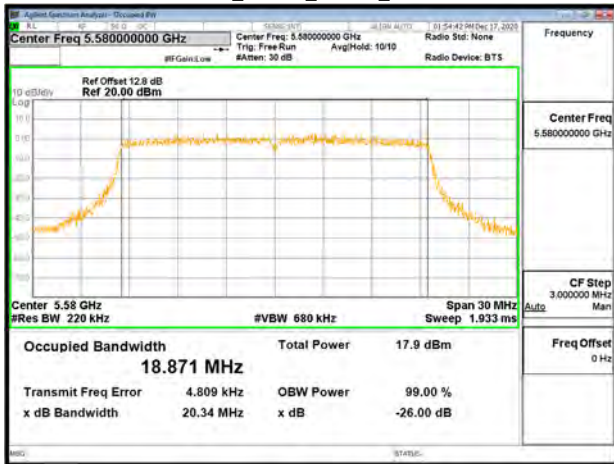

802.11ax_20MHz_Chain0_5745MHz

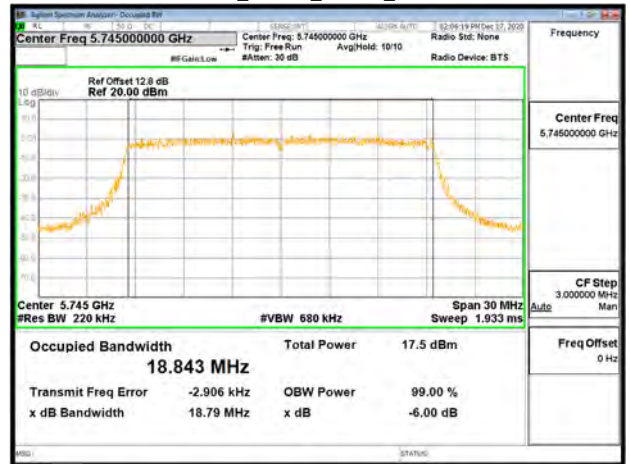

802.11ax_20MHz_Chain0_5700MHz

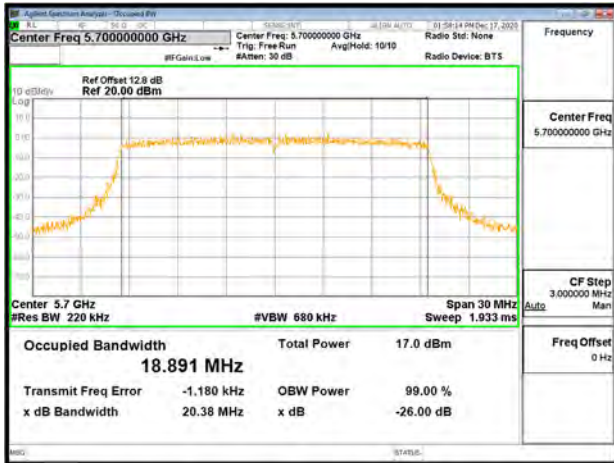

802.11ax_20MHz_Chain0_5785MHz

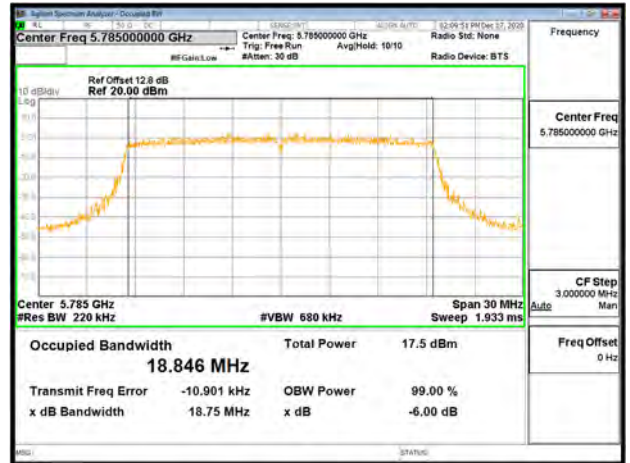

802.11ax_20MHz_Chain0_5720MHz

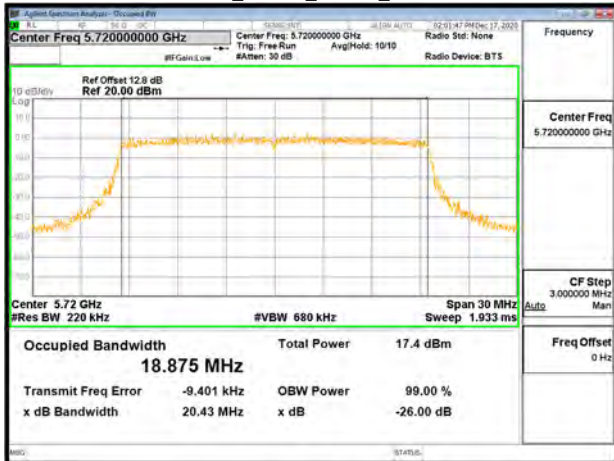

802.11ax_20MHz_Chain0_5825MHz

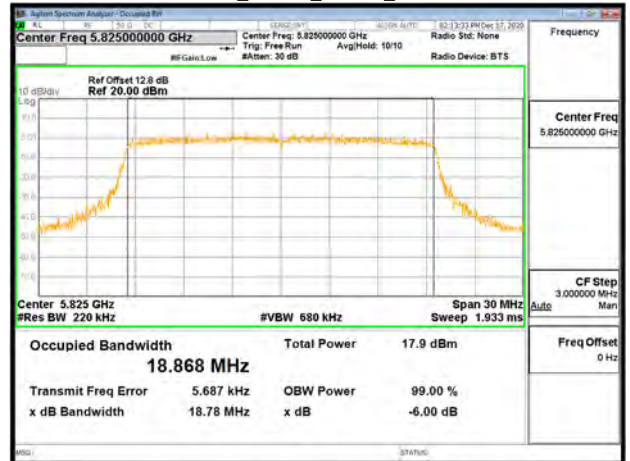

Unless otherwise stated the results shown in this test report refer only to the sample(s) tested and such sample(s) are retained for 90 days only.

除非另有說明，此報告結果僅對測試之樣品負責，同時此樣品僅保留90天。本報告未經本公司書面許可，不可部份複製。

This document is issued by the Company subject to its General Conditions of Service printed overleaf, available on request or accessible at <http://www.sgs.com.tw/Terms-and-Conditions> and for electronic format documents, subject to Terms and Conditions for Electronic Documents at <http://www.sgs.com.tw/Terms-and-Conditions>. Attention is drawn to the limitation of liability, indemnification and jurisdiction issues defined therein. Any holder of this document is advised that information contained hereon reflects the Company's findings at the time of its intervention only and within the limits of Client's instructions, if any. The Company's sole responsibility is to its Client and this document does not exonerate parties to a transaction from exercising all their rights and obligations under the transaction documents. This document cannot be reproduced except in full, without prior written approval of the Company. Any unauthorized alteration, forgery or falsification of the content or appearance of this document is unlawful and offenders may be prosecuted to the fullest extent of the law.

802.11ax_20MHz_Chain1_5180MHz

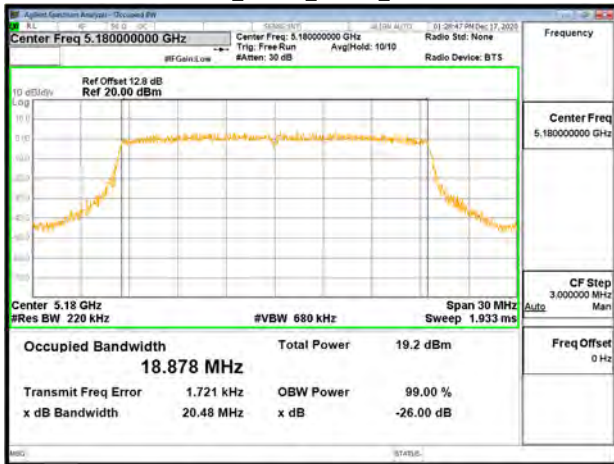

802.11ax_20MHz_Chain1_5260MHz

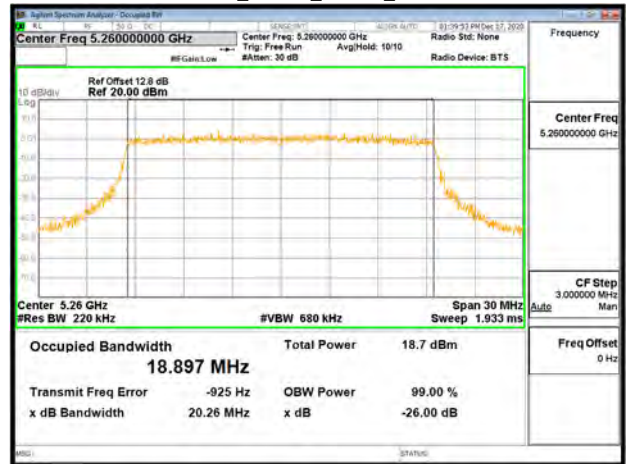

802.11ax_20MHz_Chain1_5220MHz

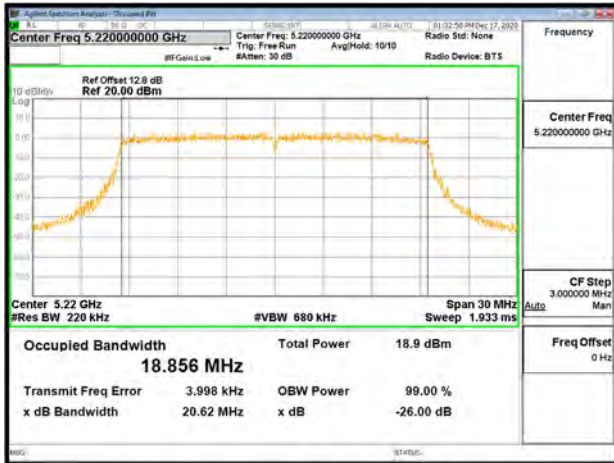

802.11ax_20MHz_Chain1_5300MHz

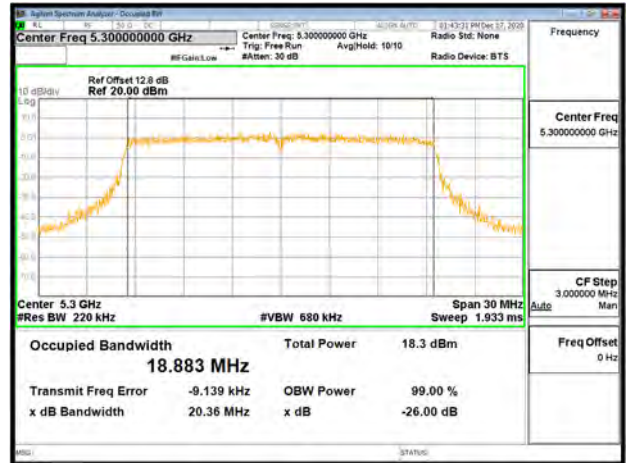

802.11ax_20MHz_Chain1_5240MHz

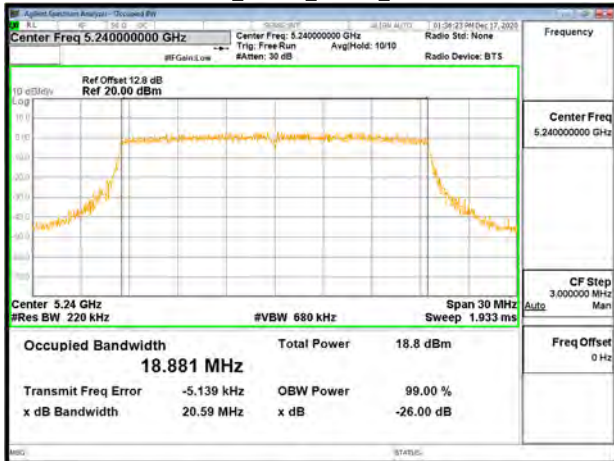

802.11ax_20MHz_Chain1_5320MHz

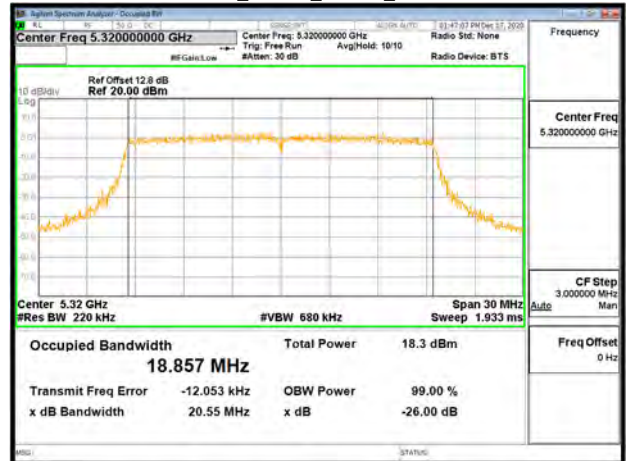

Unless otherwise stated the results shown in this test report refer only to the sample(s) tested and such sample(s) are retained for 90 days only.

除非另有說明，此報告結果僅對測試之樣品負責，同時此樣品僅保留90天。本報告未經本公司書面許可，不可部份複製。

This document is issued by the Company subject to its General Conditions of Service printed overleaf, available on request or accessible at <http://www.sgs.com.tw/Terms-and-Conditions> and for electronic format documents, subject to Terms and Conditions for Electronic Documents at <http://www.sgs.com.tw/Terms-and-Conditions>. Attention is drawn to the limitation of liability, indemnification and jurisdiction issues defined therein. Any holder of this document is advised that information contained hereon reflects the Company's findings at the time of its intervention only and within the limits of Client's instructions, if any. The Company's sole responsibility is to its Client and this document does not exonerate parties to a transaction from exercising all their rights and obligations under the transaction documents. This document cannot be reproduced except in full, without prior written approval of the Company. Any unauthorized alteration, forgery or falsification of the content or appearance of this document is unlawful and offenders may be prosecuted to the fullest extent of the law.

802.11ax_20MHz_Chain1_5500MHz

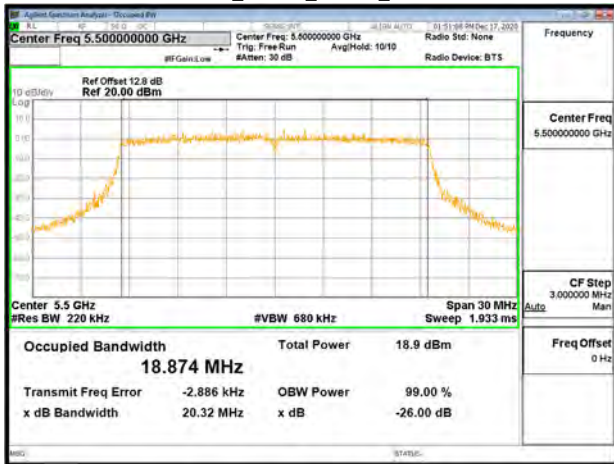

802.11ax_20MHz_Chain1_5720MHz

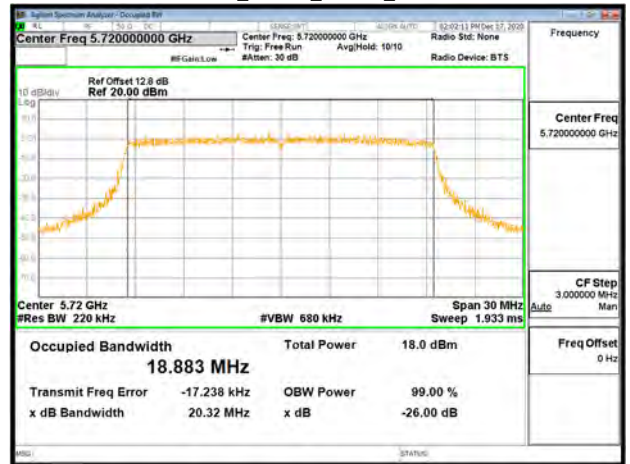

802.11ax_20MHz_Chain1_5580MHz

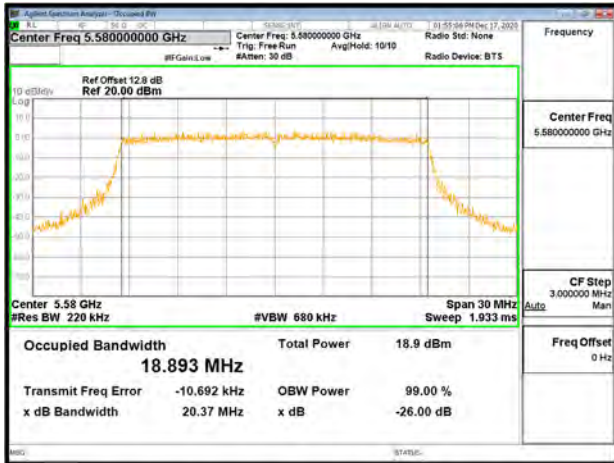

802.11ax_20MHz_Chain1_5745MHz

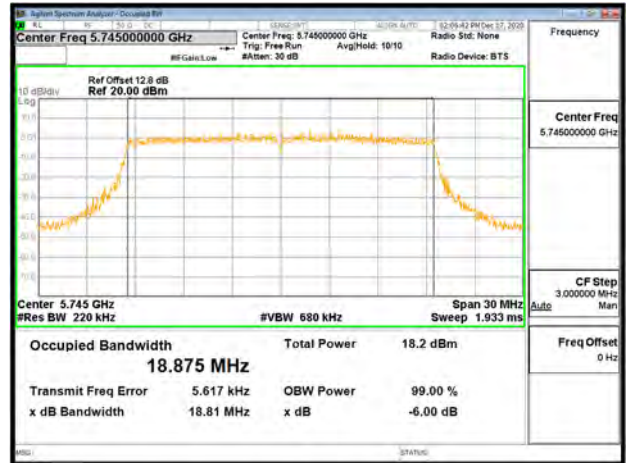

802.11ax_20MHz_Chain1_5700MHz

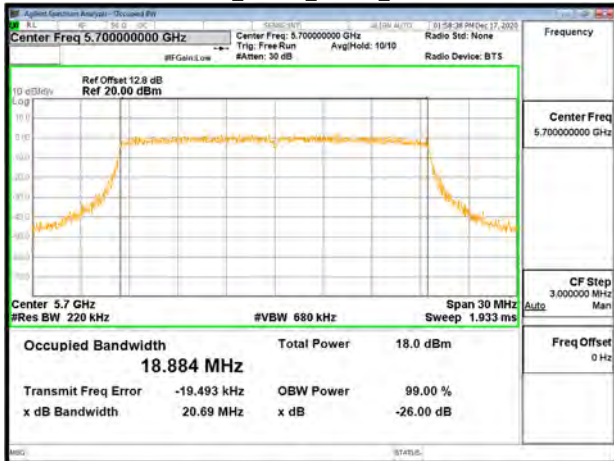

802.11ax_20MHz_Chain1_5785MHz

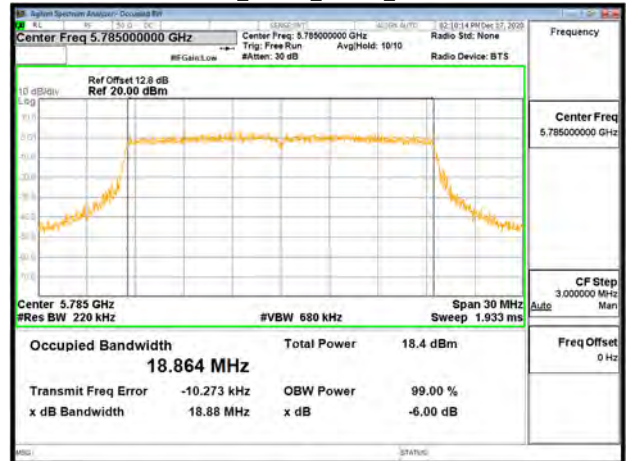

Unless otherwise stated the results shown in this test report refer only to the sample(s) tested and such sample(s) are retained for 90 days only.

除非另有說明，此報告結果僅對測試之樣品負責，同時此樣品僅保留90天。本報告未經本公司書面許可，不可部份複製。

This document is issued by the Company subject to its General Conditions of Service printed overleaf, available on request or accessible at <http://www.sgs.com.tw/Terms-and-Conditions> and for electronic format documents, subject to Terms and Conditions for Electronic Documents at <http://www.sgs.com.tw/Terms-and-Conditions>. Attention is drawn to the limitation of liability, indemnification and jurisdiction issues defined therein. Any holder of this document is advised that information contained hereon reflects the Company's findings at the time of its intervention only and within the limits of Client's instructions, if any. The Company's sole responsibility is to its Client and this document does not exonerate parties to a transaction from exercising all their rights and obligations under the transaction documents. This document cannot be reproduced except in full, without prior written approval of the Company. Any unauthorized alteration, forgery or falsification of the content or appearance of this document is unlawful and offenders may be prosecuted to the fullest extent of the law.

802.11ax_20MHz_Chain1_5825MHz

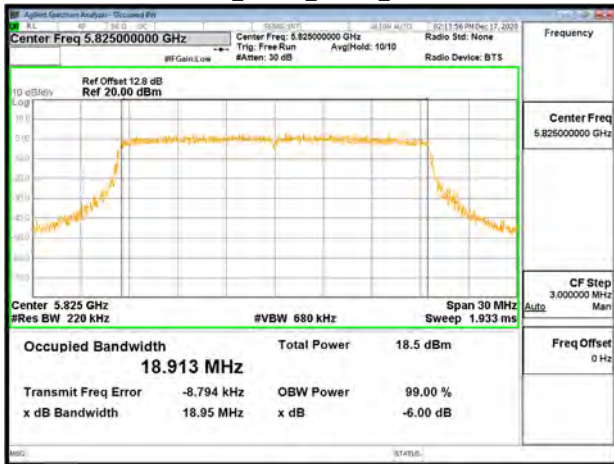

802.11ax_40MHz_Chain0_5270MHz

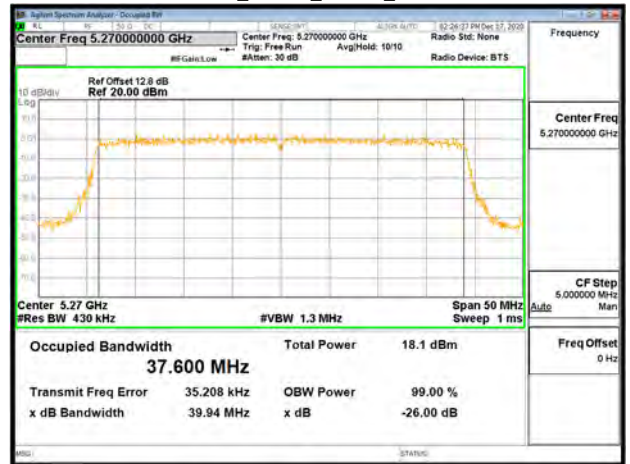

802.11ax_40MHz_Chain0_5190MHz

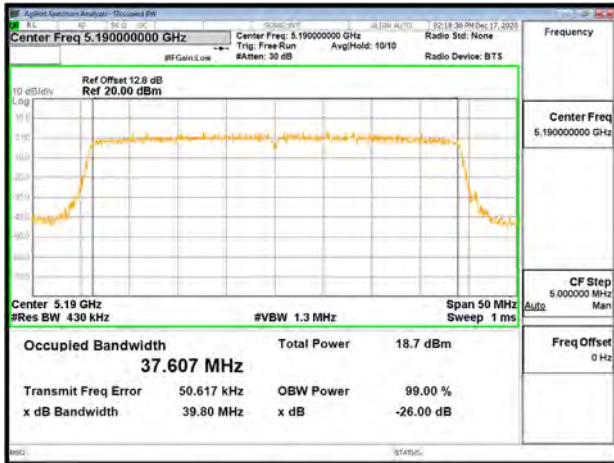

802.11ax_40MHz_Chain0_5310MHz

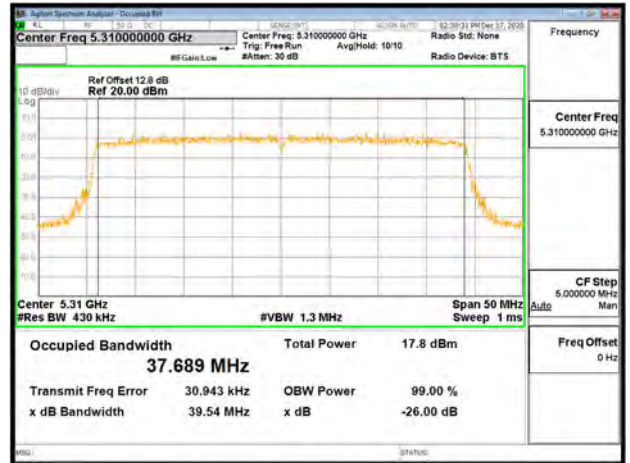

802.11ax_40MHz_Chain0_5230MHz

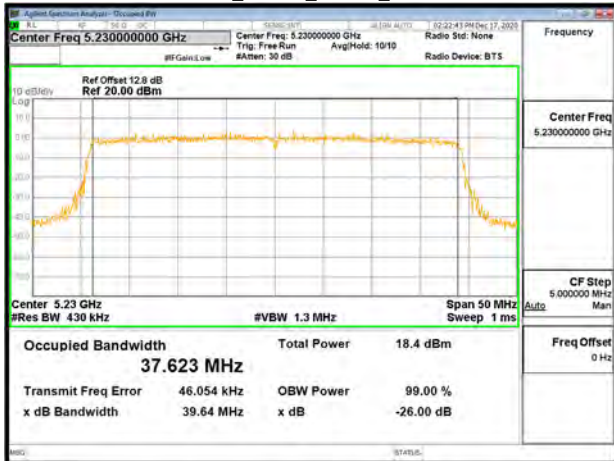

802.11ax_40MHz_Chain0_5510MHz

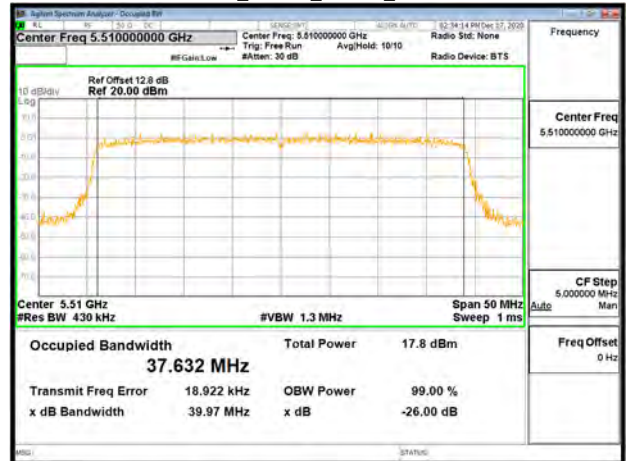

Unless otherwise stated the results shown in this test report refer only to the sample(s) tested and such sample(s) are retained for 90 days only.

除非另有說明，此報告結果僅對測試之樣品負責，同時此樣品僅保留90天。本報告未經本公司書面許可，不可部份複製。

This document is issued by the Company subject to its General Conditions of Service printed overleaf, available on request or accessible at <http://www.sgs.com.tw/Terms-and-Conditions> and for electronic format documents, subject to Terms and Conditions for Electronic Documents at <http://www.sgs.com.tw/Terms-and-Conditions>. Attention is drawn to the limitation of liability, indemnification and jurisdiction issues defined therein. Any holder of this document is advised that information contained hereon reflects the Company's findings at the time of its intervention only and within the limits of Client's instructions, if any. The Company's sole responsibility is to its Client and this document does not exonerate parties to a transaction from exercising all their rights and obligations under the transaction documents. This document cannot be reproduced except in full, without prior written approval of the Company. Any unauthorized alteration, forgery or falsification of the content or appearance of this document is unlawful and offenders may be prosecuted to the fullest extent of the law.

802.11ax_40MHz_Chain0_5550MHz

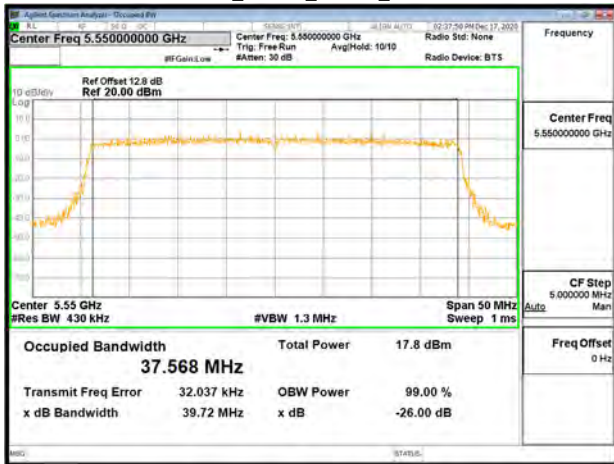

802.11ax_40MHz_Chain0_5755MHz

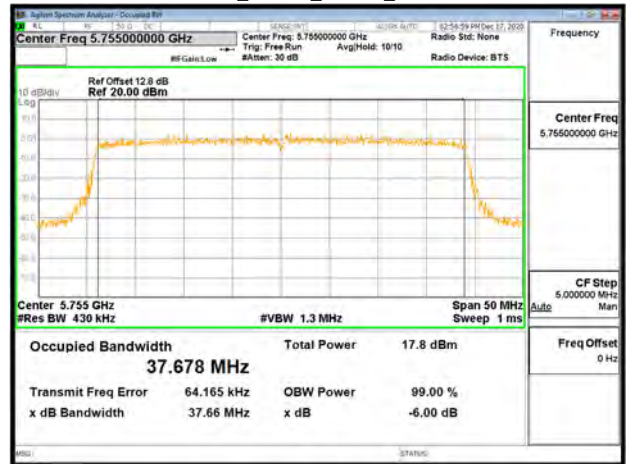

802.11ax_40MHz_Chain0_5670MHz

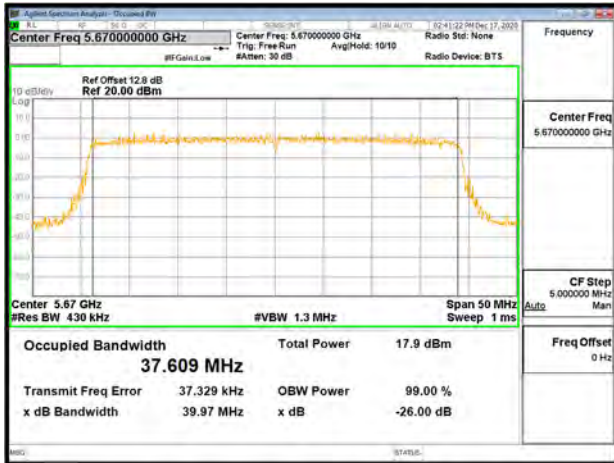

802.11ax_40MHz_Chain0_5795MHz

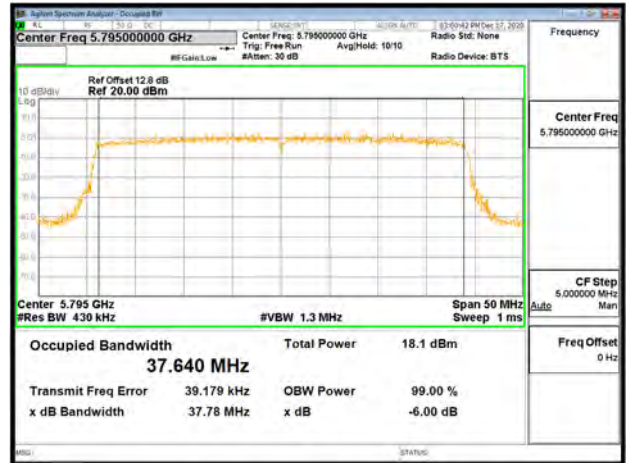

802.11ax_40MHz_Chain0_5710MHz

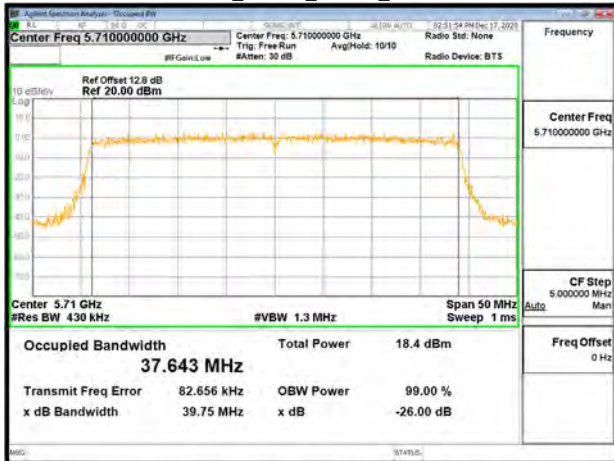

802.11ax_40MHz_Chain1_5190MHz

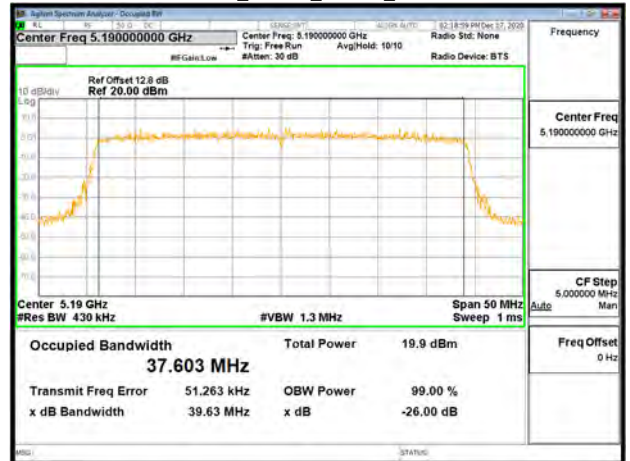

Unless otherwise stated the results shown in this test report refer only to the sample(s) tested and such sample(s) are retained for 90 days only.

除非另有說明，此報告結果僅對測試之樣品負責，同時此樣品僅保留90天。本報告未經本公司書面許可，不可部份複製。

This document is issued by the Company subject to its General Conditions of Service printed overleaf, available on request or accessible at <http://www.sgs.com.tw/Terms-and-Conditions> and for electronic format documents, subject to Terms and Conditions for Electronic Documents at <http://www.sgs.com.tw/Terms-and-Conditions>. Attention is drawn to the limitation of liability, indemnification and jurisdiction issues defined therein. Any holder of this document is advised that information contained hereon reflects the Company's findings at the time of its intervention only and within the limits of Client's instructions, if any. The Company's sole responsibility is to its Client and this document does not exonerate parties to a transaction from exercising all their rights and obligations under the transaction documents. This document cannot be reproduced except in full, without prior written approval of the Company. Any unauthorized alteration, forgery or falsification of the content or appearance of this document is unlawful and offenders may be prosecuted to the fullest extent of the law.

802.11ax_40MHz_Chain1_5230MHz

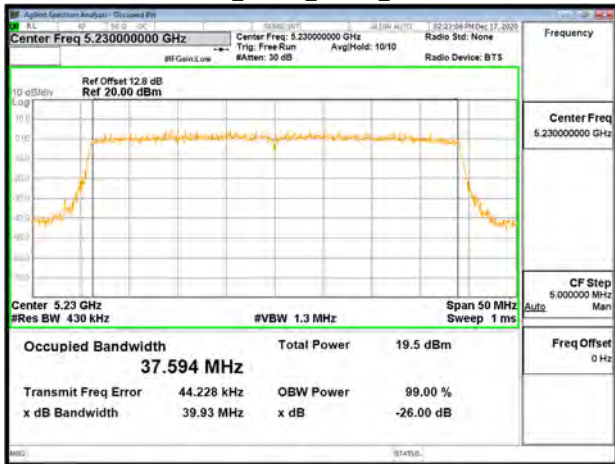

802.11ax_40MHz_Chain1_5510MHz

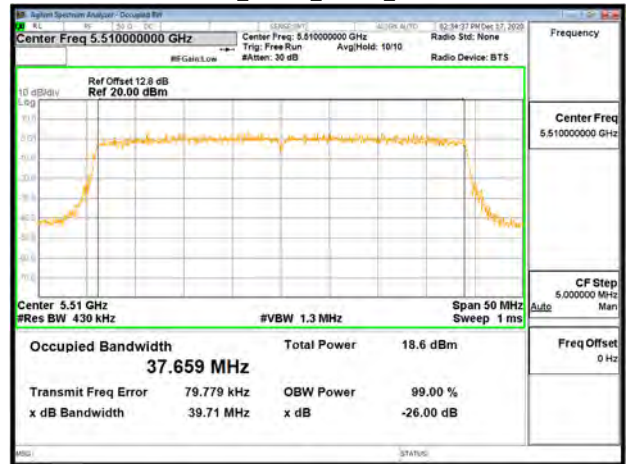

802.11ax_40MHz_Chain1_5270MHz

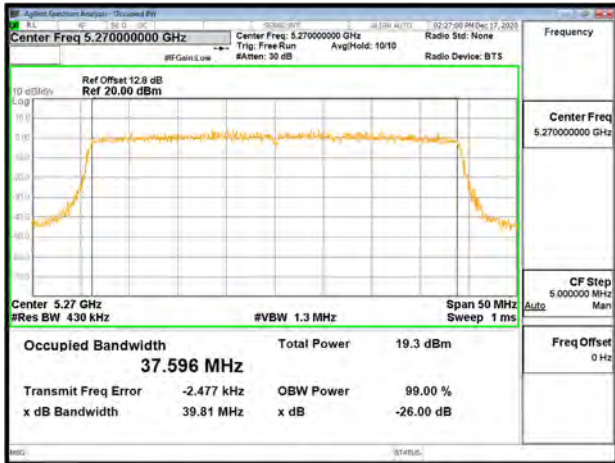

802.11ax_40MHz_Chain1_5550MHz

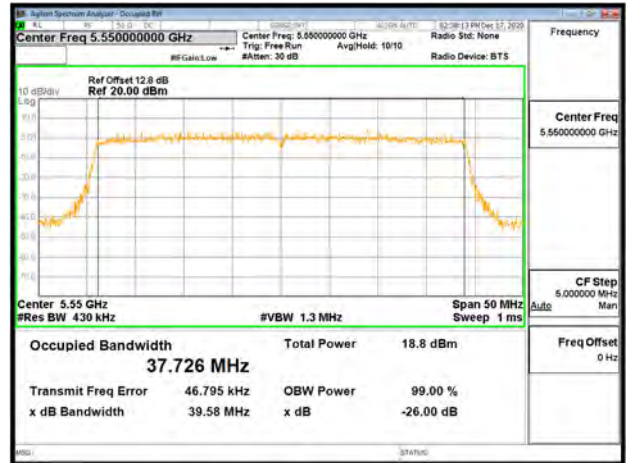

802.11ax_40MHz_Chain1_5310MHz

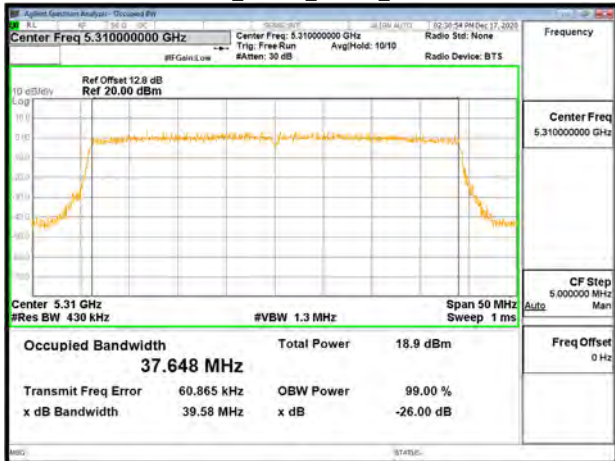

802.11ax_40MHz_Chain1_5670MHz

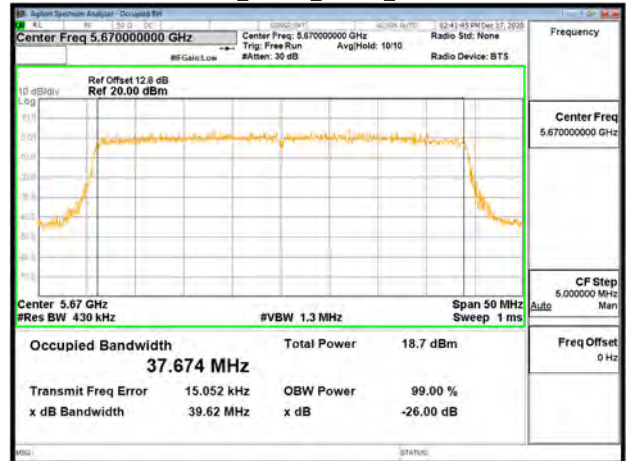

Unless otherwise stated the results shown in this test report refer only to the sample(s) tested and such sample(s) are retained for 90 days only.

除非另有說明，此報告結果僅對測試之樣品負責，同時此樣品僅保留90天。本報告未經本公司書面許可，不可部份複製。

This document is issued by the Company subject to its General Conditions of Service printed overleaf, available on request or accessible at <http://www.sgs.com.tw/Terms-and-Conditions> and for electronic format documents, subject to Terms and Conditions for Electronic Documents at <http://www.sgs.com.tw/Terms-and-Conditions>. Attention is drawn to the limitation of liability, indemnification and jurisdiction issues defined therein. Any holder of this document is advised that information contained hereon reflects the Company's findings at the time of its intervention only and within the limits of Client's instructions, if any. The Company's sole responsibility is to its Client and this document does not exonerate parties to a transaction from exercising all their rights and obligations under the transaction documents. This document cannot be reproduced except in full, without prior written approval of the Company. Any unauthorized alteration, forgery or falsification of the content or appearance of this document is unlawful and offenders may be prosecuted to the fullest extent of the law.

802.11ax_40MHz_Chain1_5710MHz

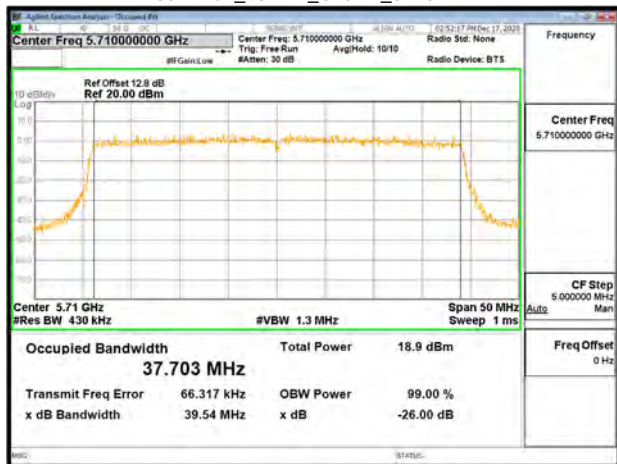

802.11ax_80MHz_Chain0_5210MHz

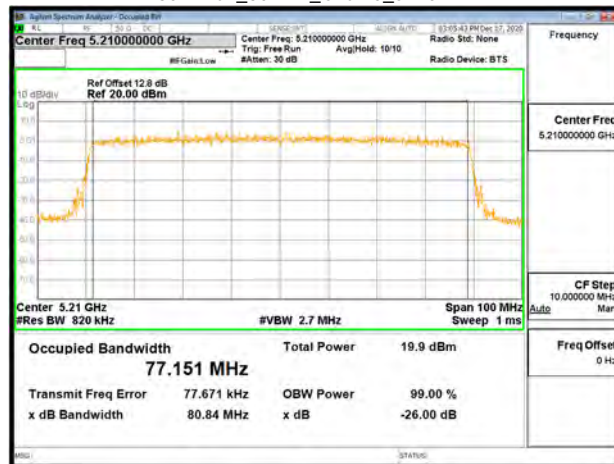

802.11ax_40MHz_Chain1_5755MHz

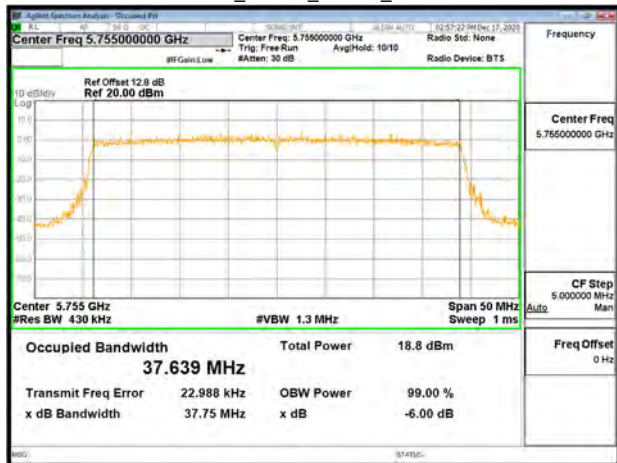

802.11ax_80MHz_Chain0_5290MHz



802.11ax_40MHz_Chain1_5795MHz

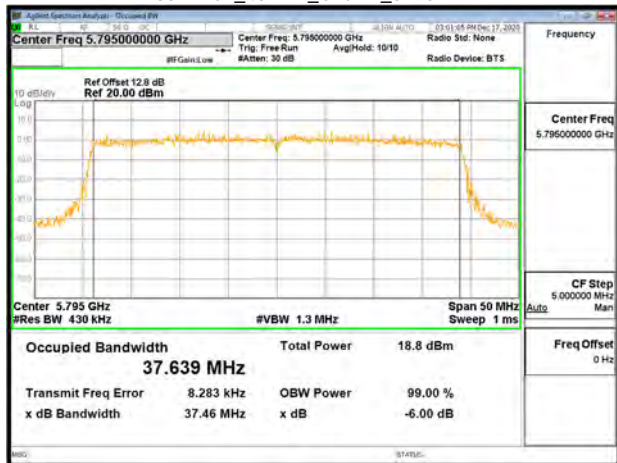

802.11ax_80MHz_Chain0_5530MHz

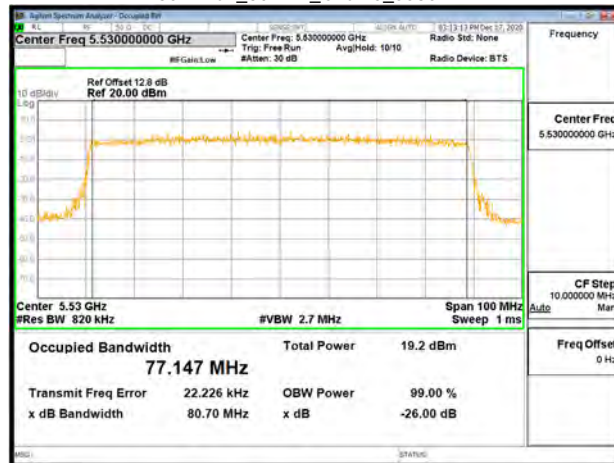

Unless otherwise stated the results shown in this test report refer only to the sample(s) tested and such sample(s) are retained for 90 days only.

除非另有說明，此報告結果僅對測試之樣品負責，同時此樣品僅保留90天。本報告未經本公司書面許可，不可部份複製。

This document is issued by the Company subject to its General Conditions of Service printed overleaf, available on request or accessible at <http://www.sgs.com.tw/Terms-and-Conditions> and for electronic format documents, subject to Terms and Conditions for Electronic Documents at <http://www.sgs.com.tw/Terms-and-Conditions>. Attention is drawn to the limitation of liability, indemnification and jurisdiction issues defined therein. Any holder of this document is advised that information contained hereon reflects the Company's findings at the time of its intervention only and within the limits of Client's instructions, if any. The Company's sole responsibility is to its Client and this document does not exonerate parties to a transaction from exercising all their rights and obligations under the transaction documents. This document cannot be reproduced except in full, without prior written approval of the Company. Any unauthorized alteration, forgery or falsification of the content or appearance of this document is unlawful and offenders may be prosecuted to the fullest extent of the law.

802.11ax_80MHz_Chain0_5610MHz

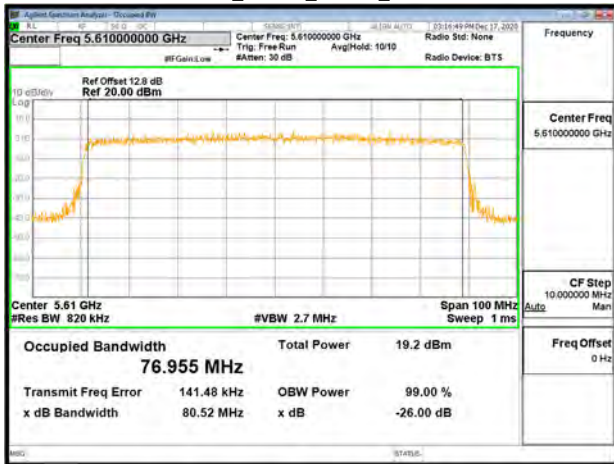

802.11ax_80MHz_Chain1_5210MHz

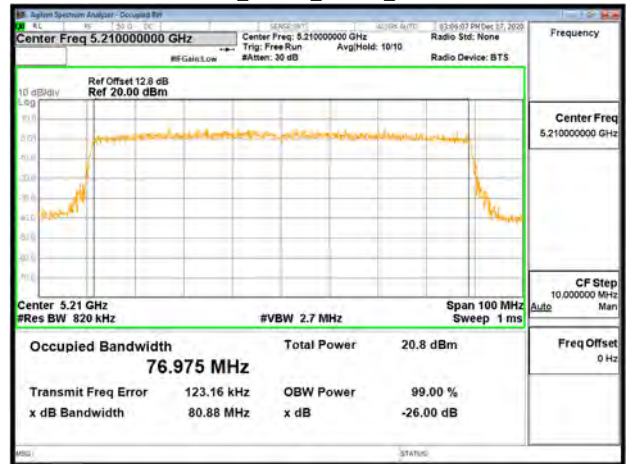

802.11ax_80MHz_Chain0_5690MHz

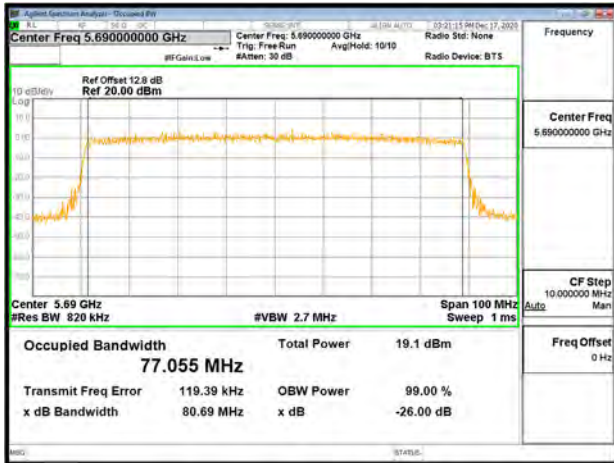

802.11ax_80MHz_Chain1_5290MHz

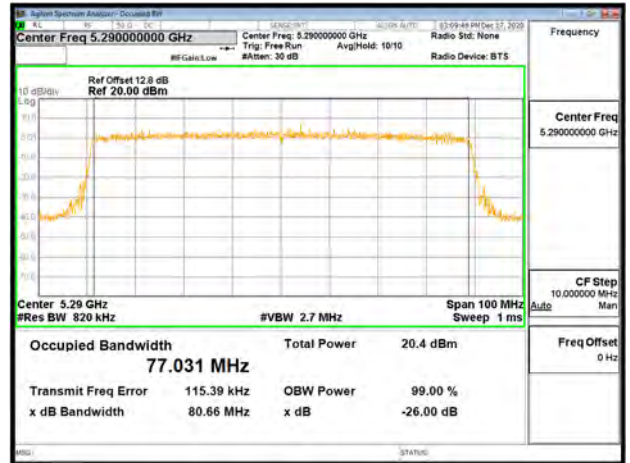

802.11ax_80MHz_Chain0_5775MHz

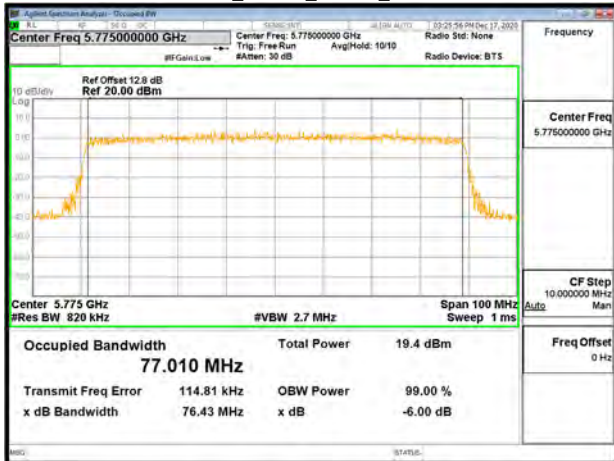

802.11ax_80MHz_Chain1_5530MHz

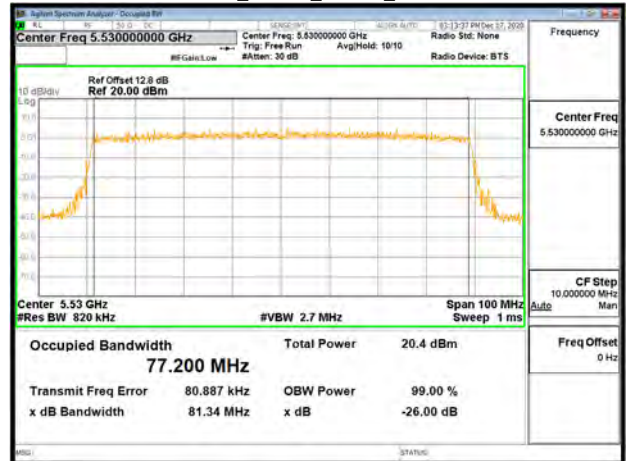

Unless otherwise stated the results shown in this test report refer only to the sample(s) tested and such sample(s) are retained for 90 days only.

除非另有說明，此報告結果僅對測試之樣品負責，同時此樣品僅保留90天。本報告未經本公司書面許可，不可部份複製。

This document is issued by the Company subject to its General Conditions of Service printed overleaf, available on request or accessible at <http://www.sgs.com.tw/Terms-and-Conditions> and for electronic format documents, subject to Terms and Conditions for Electronic Documents at <http://www.sgs.com.tw/Terms-and-Conditions>. Attention is drawn to the limitation of liability, indemnification and jurisdiction issues defined therein. Any holder of this document is advised that information contained hereon reflects the Company's findings at the time of its intervention only and within the limits of Client's instructions, if any. The Company's sole responsibility is to its Client and this document does not exonerate parties to a transaction from exercising all their rights and obligations under the transaction documents. This document cannot be reproduced except in full, without prior written approval of the Company. Any unauthorized alteration, forgery or falsification of the content or appearance of this document is unlawful and offenders may be prosecuted to the fullest extent of the law.

802.11ax_80MHz_Chain1_5610MHz

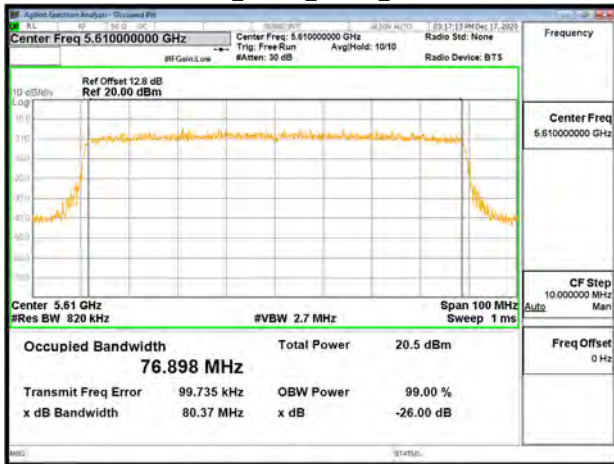

802.11ax_80MHz_Chain1_5690MHz

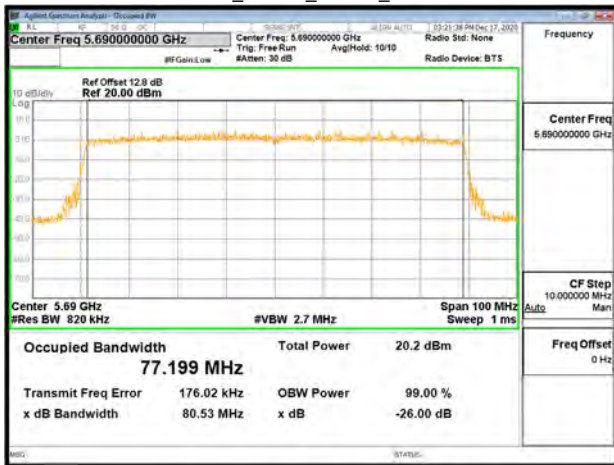

802.11ax_80MHz_Chain1_5775MHz

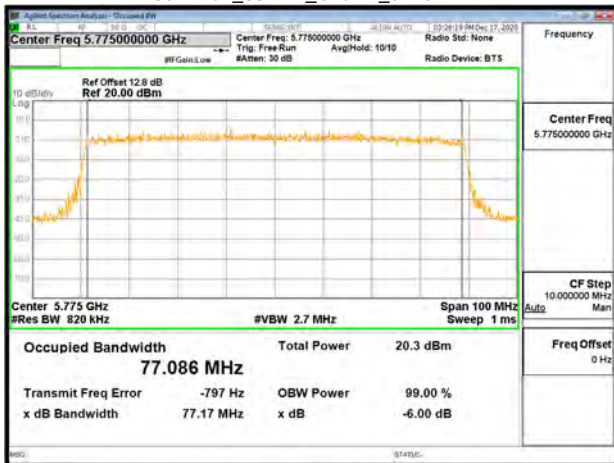

Unless otherwise stated the results shown in this test report refer only to the sample(s) tested and such sample(s) are retained for 90 days only.

除非另有說明，此報告結果僅對測試之樣品負責，同時此樣品僅保留90天。本報告未經本公司書面許可，不可部份複製。

This document is issued by the Company subject to its General Conditions of Service printed overleaf, available on request or accessible at <http://www.sgs.com.tw/Terms-and-Conditions> and for electronic format documents, subject to Terms and Conditions for Electronic Documents at <http://www.sgs.com.tw/Terms-and-Conditions>. Attention is drawn to the limitation of liability, indemnification and jurisdiction issues defined therein. Any holder of this document is advised that information contained hereon reflects the Company's findings at the time of its intervention only and within the limits of Client's instructions, if any. The Company's sole responsibility is to its Client and this document does not exonerate parties to a transaction from exercising all their rights and obligations under the transaction documents. This document cannot be reproduced except in full, without prior written approval of the Company. Any unauthorized alteration, forgery or falsification of the content or appearance of this document is unlawful and offenders may be prosecuted to the fullest extent of the law.

9 MAXIMUM CONDUCTED OUTPUT POWER MEASUREMENT

9.1 Standard Applicable

FCC

OPERZTION Band	EUT CATEGORY	LIMIT
U-NII-1	Access Point (Master device)	1 Watt(30dBm)
	Fixed point-to-point Access Ponit	1 Watt(30dBm)
	√ Mobile and portable client device	250mW(23.98dBm)
U-NII-2A	√	250mW(23.98dBm) or 11dBm+10 log B
U-NII-2C	√	250mW(23.98dBm) or 11dBm+10 log B
U-NII-3	√	1 Watt(30dBm)

If transmitting antennas of directional gain greater than 6 dBi are used, the Maximum transmit power shall be reduced by the amount in dB that the direction-al gain of the antenna exceeds 6 dBi.

ISED

OPERZTION FREQUENCY BAND	LIMIT
5150~5250 MHz	EIRP shall not exceed 200 mW or $10 + 10 \log_{10}B$, dBm
5250~5350 MHz	Conducted output power shall not exceed 250 mW or $11 + 10 \log_{10}B$ EIRP shall not exceed 1.0 W or $17 + 10 \log_{10}B$, dBm
5470-5600 MHz and 5650-5725 MHz	Conducted output power shall not exceed 250 mW or $11 + 10 \log_{10} B$ EIRP shall not exceed 1.0 W or $17 + 10 \log_{10}B$, dBm
5725~5850 MHz	Conducted output power shall not exceed 1 W

For equipment operating in the band **5725-5850** MHz, If transmitting antennas of directional gain greater than 6 dBi are used, the Maximum transmit power shall be reduced by the amount in dB that the directional gain of the antenna exceeds 6 dBi.

Unless otherwise stated the results shown in this test report refer only to the sample(s) tested and such sample(s) are retained for 90 days only.

除非另有說明，此報告結果僅對測試之樣品負責，同時此樣品僅保留90天。本報告未經本公司書面許可，不可部份複製。

This document is issued by the Company subject to its General Conditions of Service printed overleaf, available on request or accessible at <http://www.sgs.com.tw/Terms-and-Conditions> and for electronic format documents, subject to Terms and Conditions for Electronic Documents at <http://www.sgs.com.tw/Terms-and-Conditions>. Attention is drawn to the limitation of liability, indemnification and jurisdiction issues defined therein. Any holder of this document is advised that information contained hereon reflects the Company's findings at the time of its intervention only and within the limits of Client's instructions, if any. The Company's sole responsibility is to its Client and this document does not exonerate parties to a transaction from exercising all their rights and obligations under the transaction documents. This document cannot be reproduced except in full, without prior written approval of the Company. Any unauthorized alteration, forgery or falsification of the content or appearance of this document is unlawful and offenders may be prosecuted to the fullest extent of the law.

Note:

As per section F. 2). e). (ii) of FCC KDB 662911 D01

If antenna gains are not equal and each transmit antenna is driven by only one spatial stream, directional gain may be calculated by either of the following formulas.

$$DirectionalGain = 10 \cdot \log \left[\frac{\sum_{j=1}^{N_{SS}} \left\{ \sum_{k=1}^{N_{ANT}} g_{j,k} \right\}^2}{N_{ANT}} \right]$$

where

Each antenna is driven by no more than one spatial stream;

NSS = the number of independent spatial streams of data;

NANT = the total number of antennas

$g_{j,k} = \sqrt{10} G_k$ if the kth antenna is being fed by spatial stream j, or zero if it is not;

G_k is the gain in dBi of the kth antenna.

The antenna gain is not greater than 6 dBi. Therefore, reduction of power is not required.

9.2 Measurement Procedure

1. Place the EUT on the table and set it in transmitting mode.
2. The testing follows FCC KDB 789033 D02 General UNII Test Procedures New Rules .
3. Remove the antenna from the EUT and then connect a low loss RF cable from the antenna port to the power meter
4. Power Meter is used as the auxiliary test equipment to conduct the output power measurement.
5. Record the max. reading and add $10 \log(1/\text{duty cycle})$.
6. Repeat above procedures until all frequency (low, middle, and high channel) measured were complete.

9.3 Measurement Equipment Used

SGS Conducted Room					
Name of Equipment	Manufacturer	Model	Serial Number	Calibration Date	Calibration Due
Power Meter	Anritsu	ML2496A	1804001	02/20/2020	02/19/2021
Power Sensor	Anritsu	MA2411B	1726104	02/20/2020	02/19/2021
Power Sensor	Anritsu	MA2411B	1726107	02/20/2020	02/19/2021
DC Power Supply	Agilent	E3640A	MY52410006	12/17/2020	12/16/2021
DC Power Supply	Agilent	E3640A	KR93300208	08/19/2020	08/18/2021
Attenuator	Mini-Circuit	BW-S10W2+	2	12/16/2020	12/15/2021

Unless otherwise stated the results shown in this test report refer only to the sample(s) tested and such sample(s) are retained for 90 days only.

除非另有說明，此報告結果僅對測試之樣品負責，同時此樣品僅保留90天。本報告未經本公司書面許可，不可部份複製。

This document is issued by the Company subject to its General Conditions of Service printed overleaf, available on request or accessible at <http://www.sgs.com.tw/Terms-and-Conditions> and for electronic format documents, subject to Terms and Conditions for Electronic Documents at <http://www.sgs.com.tw/Terms-and-Conditions>. Attention is drawn to the limitation of liability, indemnification and jurisdiction issues defined therein. Any holder of this document is advised that information contained hereon reflects the Company's findings at the time of its intervention only and within the limits of Client's instructions, if any. The Company's sole responsibility is to its Client and this document does not exonerate parties to a transaction from exercising all their rights and obligations under the transaction documents. This document cannot be reproduced except in full, without prior written approval of the Company. Any unauthorized alteration, forgery or falsification of the content or appearance of this document is unlawful and offenders may be prosecuted to the fullest extent of the law.

9.4 Test Set-up

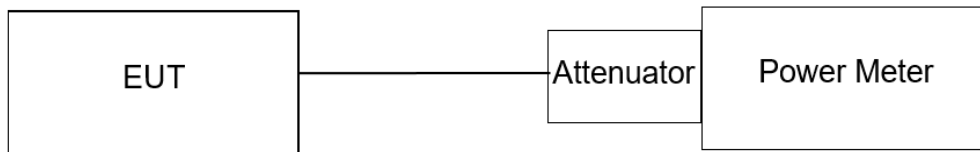

9.5 Measurement Result

9.5.1 Conducted output power (FCC)

802.11a_Ch0

CH	Frequency (MHz)	Data Rate	TOTAL POWER (dBm)	TOTAL POWER (mW)	REQUIRED LIMIT (dBm)	RESULT
36	5180	6	12.99	19.923	23.98	PASS
44	5220	6	12.96	19.786	23.98	PASS
48	5240	6	12.94	19.695	23.98	PASS
52	5260	6	12.93	19.650	23.98 or 11+10log(B) = 23.66	PASS
60	5300	6	12.96	19.786	23.98 or 11+10log(B) = 23.66	PASS
64	5320	6	12.93	19.650	23.98 or 11+10log(B) = 23.61	PASS
100	5500	6	12.98	19.878	23.98 or 11+10log(B) = 23.63	PASS
116	5580	6	12.95	19.741	23.98 or 11+10log(B) = 23.66	PASS
140	5700	6	12.93	19.650	23.98 or 11+10log(B) = 23.67	PASS
144	5720(U-NII 2C)	6	11.83	15.23	23.98 or 11+10log(B) = 22.52	PASS
144	5720 (U-NII 3)	6	6.54	4.51	30	PASS
149	5745	6	12.96	19.786	30	PASS
157	5785	6	12.95	19.741	30	PASS
165	5825	6	12.99	19.923	30	PASS

802.11n_HT20_Ch0

CH	Frequency (MHz)	Data Rate	TOTAL POWER (dBm)	TOTAL POWER (mW)	REQUIRED LIMIT (dBm)	RESULT
36	5180	MCS0	12.98	19.861	23.98	PASS
44	5220	MCS0	12.95	19.724	23.98	PASS
48	5240	MCS0	12.83	19.187	23.98	PASS
52	5260	MCS0	12.81	19.099	23.98 or 11+10log(B) = 23.94	PASS
60	5300	MCS0	12.98	19.861	23.98 or 11+10log(B) = 23.91	PASS
64	5320	MCS0	12.99	19.907	23.98 or 11+10log(B) = 23.92	PASS
100	5500	MCS0	12.89	19.454	23.98 or 11+10log(B) = 23.94	PASS
116	5580	MCS0	12.87	19.364	23.98 or 11+10log(B) = 23.93	PASS
140	5700	MCS0	12.94	19.679	23.98 or 11+10log(B) = 23.89	PASS
144	5720(U-NII 2C)	MCS0	11.61	14.48	23.98 or 11+10log(B) = 22.72	PASS
144	5720 (U-NII 3)	MCS0	6.76	4.75	30	PASS
149	5745	MCS0	12.92	19.588	30	PASS
157	5785	MCS0	12.98	19.861	30	PASS
165	5825	MCS0	12.99	19.907	30	PASS

Unless otherwise stated the results shown in this test report refer only to the sample(s) tested and such sample(s) are retained for 90 days only.

除非另有說明，此報告結果僅對測試之樣品負責，同時此樣品僅保留90天。本報告未經本公司書面許可，不可部份複製。

This document is issued by the Company subject to its General Conditions of Service printed overleaf, available on request or accessible at <http://www.sgs.com.tw/Terms-and-Conditions> and for electronic format documents, subject to Terms and Conditions for Electronic Documents at <http://www.sgs.com.tw/Terms-and-Conditions>. Attention is drawn to the limitation of liability, indemnification and jurisdiction issues defined therein. Any holder of this document is advised that information contained hereon reflects the Company's findings at the time of its intervention only and within the limits of Client's instructions, if any. The Company's sole responsibility is to its Client and this document does not exonerate parties to a transaction from exercising all their rights and obligations under the transaction documents. This document cannot be reproduced except in full, without prior written approval of the Company. Any unauthorized alteration, forgery or falsification of the content or appearance of this document is unlawful and offenders may be prosecuted to the fullest extent of the law.

802.11n_HT20_Ch1

CH	Frequency (MHz)	Data Rate	TOTAL POWER (dBm)	TOTAL POWER (mW)	REQUIRED LIMIT (dBm)	RESULT
36	5180	MCS0	12.58	18.113	23.98	PASS
44	5220	MCS0	12.82	19.143	23.98	PASS
48	5240	MCS0	12.56	18.030	23.98	PASS
52	5260	MCS0	12.54	17.947	23.98 or 11+10log(B) = 23.92	PASS
60	5300	MCS0	12.81	19.099	23.98 or 11+10log(B) = 23.93	PASS
64	5320	MCS0	12.79	19.011	23.98 or 11+10log(B) = 23.93	PASS
100	5500	MCS0	12.44	17.539	23.98 or 11+10log(B) = 23.92	PASS
116	5580	MCS0	12.72	18.707	23.98 or 11+10log(B) = 23.94	PASS
140	5700	MCS0	12.63	18.323	23.98 or 11+10log(B) = 23.96	PASS
144	5720(U-NII 2C)	MCS0	11.51	14.17	23.98 or 11+10log(B) = 22.70	PASS
144	5720 (U-NII 3)	MCS0	6.61	4.58	30	PASS
149	5745	MCS0	12.58	18.113	30	PASS
157	5785	MCS0	12.64	18.365	30	PASS
165	5825	MCS0	12.67	18.493	30	PASS

802.11n_HT20_MIMO

CH	Frequency (MHz)	Data Rate	Avg. POWER (dBm)		TOTAL POWER (dBm)	TOTAL POWER (mW)	REQUIRED LIMIT (dBm)	RESULT
			CH 0	CH 1				
36	5180	MCS0	12.12	13.62	15.94	39.307	23.98	PASS
44	5220	MCS0	11.96	13.36	15.73	37.381	23.98	PASS
48	5240	MCS0	11.94	13.65	15.89	38.805	23.98	PASS
52	5260	MCS0	11.61	13.35	15.58	36.115	23.98 or 11+10log(B) = 23.92	PASS
60	5300	MCS0	11.71	13.27	15.57	36.058	23.98 or 11+10log(B) = 23.91	PASS
64	5320	MCS0	11.61	13.41	15.61	36.416	23.98 or 11+10log(B) = 23.92	PASS
100	5500	MCS0	11.74	13.22	15.55	35.917	23.98 or 11+10log(B) = 23.92	PASS
116	5580	MCS0	11.91	13.72	15.92	39.074	23.98 or 11+10log(B) = 23.93	PASS
140	5700	MCS0	11.8	13.14	15.53	35.742	23.98 or 11+10log(B) = 23.89	PASS
144	5720(U-NII 2C)	MCS0	10.74	12.00	14.43	27.718	23.98 or 11+10log(B) = 22.70	PASS
144	5720 (U-NII 3)	MCS0	5.89	7.10	9.55	9.012	30	PASS
149	5745	MCS0	11.98	13.4	15.76	37.654	30	PASS
157	5785	MCS0	11.93	13.37	15.72	37.323	30	PASS
165	5825	MCS0	12.05	13.23	15.69	37.070	30	PASS

802.11n_HT40_Ch0

CH	Frequency (MHz)	Data Rate	TOTAL POWER (dBm)	TOTAL POWER (mW)	REQUIRED LIMIT (dBm)	RESULT
38	5190	MCS0	12.76	18.880	23.98	PASS
46	5230	MCS0	12.78	18.967	23.98	PASS
54	5270	MCS0	12.72	18.707	23.98 or 11+10log(B) = 26.94	PASS
62	5310	MCS0	12.90	19.498	23.98 or 11+10log(B) = 26.93	PASS
102	5510	MCS0	12.99	19.907	23.98 or 11+10log(B) = 26.93	PASS
110	5550	MCS0	12.97	19.815	23.98 or 11+10log(B) = 26.94	PASS
134	5670	MCS0	12.94	19.679	23.98 or 11+10log(B) = 26.91	PASS
142	5710(U-NII 2C)	MCS0	12.41	17.43	23.98 or 11+10log(B) = 26.40	PASS
142	5710 (U-NII 3)	MCS0	3.69	2.34	30	PASS
151	5755	MCS0	12.98	19.861	30	PASS
159	5795	MCS0	12.97	19.815	30	PASS

Unless otherwise stated the results shown in this test report refer only to the sample(s) tested and such sample(s) are retained for 90 days only.

除非另有說明，此報告結果僅對測試之樣品負責，同時此樣品僅保留90天。本報告未經本公司書面許可，不可部份複製。

This document is issued by the Company subject to its General Conditions of Service printed overleaf, available on request or accessible at <http://www.sgs.com.tw/Terms-and-Conditions> and for electronic format documents, subject to Terms and Conditions for Electronic Documents at <http://www.sgs.com.tw/Terms-and-Conditions>. Attention is drawn to the limitation of liability, indemnification and jurisdiction issues defined therein. Any holder of this document is advised that information contained hereon reflects the Company's findings at the time of its intervention only and within the limits of Client's instructions, if any. The Company's sole responsibility is to its Client and this document does not exonerate parties to a transaction from exercising all their rights and obligations under the transaction documents. This document cannot be reproduced except in full, without prior written approval of the Company. Any unauthorized alteration, forgery or falsification of the content or appearance of this document is unlawful and offenders may be prosecuted to the fullest extent of the law.

802.11n_HT40_Ch1

CH	Frequency (MHz)	Data Rate	TOTAL POWER (dBm)	TOTAL POWER (mW)	REQUIRED LIMIT (dBm)	RESULT
38	5190	MCS0	12.72	18.707	23.98	PASS
46	5230	MCS0	12.76	18.880	23.98	PASS
54	5270	MCS0	12.68	18.535	23.98 or 11+10log(B) = 26.90	PASS
62	5310	MCS0	12.54	17.947	23.98 or 11+10log(B) = 26.88	PASS
102	5510	MCS0	12.57	18.072	23.98 or 11+10log(B) = 26.88	PASS
110	5550	MCS0	12.56	18.030	23.98 or 11+10log(B) = 26.94	PASS
134	5670	MCS0	12.59	18.155	23.98 or 11+10log(B) = 26.86	PASS
142	5710(U-NII 2C)	MCS0	12.36	17.24	23.98 or 11+10log(B) = 26.36	PASS
142	5710 (U-NII 3)	MCS0	3.37	2.17	30	PASS
151	5755	MCS0	12.81	19.099	30	PASS
159	5795	MCS0	12.84	19.231	30	PASS

802.11n_HT40_MIMO

CH	Frequency (MHz)	Data Rate	Avg. POWER (dBm)		TOTAL POWER (dBm)	TOTAL POWER (mW)	REQUIRED LIMIT (dBm)	RESULT
			CH 0	CH 1				
38	5190	MCS0	11.67	13.73	15.83	38.294	23.98	PASS
46	5230	MCS0	11.67	13.44	15.65	36.769	23.98	PASS
54	5270	MCS0	11.65	13.42	15.63	36.600	23.98 or 11+10log(B) = 26.90	PASS
62	5310	MCS0	11.46	13.57	15.65	36.747	23.98 or 11+10log(B) = 26.88	PASS
102	5510	MCS0	12.01	13.25	15.68	37.020	23.98 or 11+10log(B) = 26.88	PASS
110	5550	MCS0	12.07	13.6	15.91	39.015	23.98 or 11+10log(B) = 26.94	PASS
134	5670	MCS0	12.02	13.39	15.77	37.749	23.98 or 11+10log(B) = 26.86	PASS
142	5710(U-NII 2C)	MCS0	11.48	12.52	15.04	31.951	23.98 or 11+10log(B) = 26.36	PASS
142	5720 (U-NII 3)	MCS0	2.76	3.53	6.18	4.145	30	PASS
151	5755	MCS0	12.28	13.52	15.95	39.395	30	PASS
159	5795	MCS0	12.22	13.45	15.89	38.803	30	PASS

802.11ac_VHT80_Ch0

CH	Frequency (MHz)	Data Rate	TOTAL POWER (dBm)	TOTAL POWER (mW)	REQUIRED LIMIT (dBm)	RESULT
42	5210	MCS0	12.80	19.055	23.98	PASS
58	5290	MCS0	12.72	18.707	23.98 or 11+10log(B) = 30.06	PASS
106	5530	MCS0	12.95	19.724	23.98 or 11+10log(B) = 30.07	PASS
122	5610	MCS0	12.98	19.861	23.98 or 11+10log(B) = 30.10	PASS
138	5690(U-NII 2C)	MCS0	12.67	18.47	23.98 or 11+10log(B) = 30.08	PASS
138	5690 (U-NII 3)	MCS0	1.28	1.34	30	PASS
155	5775	MCS0	12.98	19.861	30	PASS

802.11ac_VHT80_Ch1

CH	Frequency (MHz)	Data Rate	TOTAL POWER (dBm)	TOTAL POWER (mW)	REQUIRED LIMIT (dBm)	RESULT
42	5210	MCS0	12.74	18.793	23.98	PASS
58	5290	MCS0	12.68	18.535	23.98 or 11+10log(B) = 30.06	PASS
106	5530	MCS0	12.91	19.543	23.98 or 11+10log(B) = 30.05	PASS
122	5610	MCS0	12.62	18.281	23.98 or 11+10log(B) = 30.04	PASS
138	5690(U-NII 2C)	MCS0	12.27	16.87	23.98 or 11+10log(B) = 30.07	PASS
138	5690 (U-NII 3)	MCS0	0.79	1.20	30	PASS
155	5775	MCS0	12.75	18.836	30	PASS

Unless otherwise stated the results shown in this test report refer only to the sample(s) tested and such sample(s) are retained for 90 days only.

除非另有說明，此報告結果僅對測試之樣品負責，同時此樣品僅保留90天。本報告未經本公司書面許可，不可部份複製。

This document is issued by the Company subject to its General Conditions of Service printed overleaf, available on request or accessible at <http://www.sgs.com.tw/Terms-and-Conditions> and for electronic format documents, subject to Terms and Conditions for Electronic Documents at <http://www.sgs.com.tw/Terms-and-Conditions>. Attention is drawn to the limitation of liability, indemnification and jurisdiction issues defined therein. Any holder of this document is advised that information contained hereon reflects the Company's findings at the time of its intervention only and within the limits of Client's instructions, if any. The Company's sole responsibility is to its Client and this document does not exonerate parties to a transaction from exercising all their rights and obligations under the transaction documents. This document cannot be reproduced except in full, without prior written approval of the Company. Any unauthorized alteration, forgery or falsification of the content or appearance of this document is unlawful and offenders may be prosecuted to the fullest extent of the law.

802.11ac_VHT80_MIMO

CH	Frequency (MHz)	Data Rate	Avg. POWER (dBm)		TOTAL POWER (dBm)	TOTAL POWER (mW)	REQUIRED LIMIT (dBm)	RESULT
			CH 0	CH 1				
42	5210	MCS0	11.74	13.19	15.54	35.773	23.98	PASS
58	5290	MCS0	11.66	13.25	15.54	35.790	23.98 or 11+10log(B) = 30.06	PASS
106	5530	MCS0	11.78	13.53	15.75	37.608	23.98 or 11+10log(B) = 30.05	PASS
122	5610	MCS0	12.05	13.73	15.98	39.637	23.98 or 11+10log(B) = 30.04	PASS
138	5690(U-NII 2C)	MCS0	11.75	13.17	15.53	35.703	23.98 or 11+10log(B) = 30.07	PASS
138	5690 (U-NII 3)	MCS0	0.36	1.69	4.09	2.562	30	PASS
155	5775	MCS0	12.15	13.64	15.97	39.527	30	PASS

802.11ax_20_Ch0

CH	Frequency (MHz)	Data Rate	RU config.	TOTAL POWER (dBm)	TOTAL POWER (mW)	REQUIRED LIMIT (dBm)	RESULT
36	5180	MCS0	full	12.98	19.861	23.98	PASS
		MCS0	26/0	11.74	14.928	23.98	PASS
		MCS0	52/37	12.73	18.750	23.98	PASS
		MCS0	106/53	12.88	19.409	23.98	PASS
44	5220	MCS0	full	12.99	19.907	23.98	PASS
48	5240	MCS0	full	12.85	19.275	23.98	PASS
52	5260	MCS0	full	12.83	19.187	23.98 or 11+10log(B) = 24.06	PASS
60	5300	MCS0	full	12.82	19.143	23.98 or 11+10log(B) = 24.13	PASS
64	5320	MCS0	full	12.85	19.275	23.98 or 11+10log(B) = 24.10	PASS
		MCS0	26/8	11.74	14.928	23.98 or 11+10log(B) = 24.10	PASS
		MCS0	52/40	12.88	19.409	23.98 or 11+10log(B) = 24.10	PASS
		MCS0	106/54	12.95	19.724	23.98 or 11+10log(B) = 24.10	PASS
100	5500	MCS0	full	12.97	19.815	23.98 or 11+10log(B) = 24.11	PASS
		MCS0	26/0	11.94	15.631	23.98 or 11+10log(B) = 24.11	PASS
		MCS0	52/37	12.86	19.320	23.98 or 11+10log(B) = 24.11	PASS
		MCS0	106/53	12.97	19.815	23.98 or 11+10log(B) = 24.11	PASS
116	5580	MCS0	full	12.93	19.634	23.98 or 11+10log(B) = 24.11	PASS
140	5700	MCS0	full	12.92	19.588	23.98 or 11+10log(B) = 24.11	PASS
		MCS0	26/8	11.94	15.631	23.98 or 11+10log(B) = 24.11	PASS
		MCS0	52/40	12.94	19.679	23.98 or 11+10log(B) = 24.11	PASS
		MCS0	106/54	12.76	18.880	23.98 or 11+10log(B) = 24.11	PASS
144	5720(U-NII 2C)	MCS0	full	11.70	14.791	23.98 or 11+10log(B) = 22.80	PASS
144	5720 (U-NII 3)	MCS0	full	7.01	5.025	30	PASS
149	5745	MCS0	full	12.99	19.907	30	PASS
		MCS0	26/0	11.81	15.171	30	PASS
		MCS0	52/37	12.72	18.707	30	PASS
		MCS0	106/53	12.81	19.099	30	PASS
157	5785	MCS0	full	12.98	19.861	30	PASS
165	5825	MCS0	full	12.81	19.099	30	PASS
		MCS0	26/8	11.81	15.171	30	PASS
		MCS0	52/40	12.81	19.099	30	PASS
		MCS0	106/54	12.93	19.634	30	PASS

Unless otherwise stated the results shown in this test report refer only to the sample(s) tested and such sample(s) are retained for 90 days only.

除非另有說明，此報告結果僅對測試之樣品負責，同時此樣品僅保留90天。本報告未經本公司書面許可，不可部份複製。

This document is issued by the Company subject to its General Conditions of Service printed overleaf, available on request or accessible at <http://www.sgs.com.tw/Terms-and-Conditions> and for electronic format documents, subject to Terms and Conditions for Electronic Documents at <http://www.sgs.com.tw/Terms-and-Conditions>. Attention is drawn to the limitation of liability, indemnification and jurisdiction issues defined therein. Any holder of this document is advised that information contained hereon reflects the Company's findings at the time of its intervention only and within the limits of Client's instructions, if any. The Company's sole responsibility is to its Client and this document does not exonerate parties to a transaction from exercising all their rights and obligations under the transaction documents. This document cannot be reproduced except in full, without prior written approval of the Company. Any unauthorized alteration, forgery or falsification of the content or appearance of this document is unlawful and offenders may be prosecuted to the fullest extent of the law.

802.11ax_20_Ch1

CH	Frequency (MHz)	Data Rate	RU config.	TOTAL POWER (dBm)	TOTAL POWER (mW)	REQUIRED LIMIT (dBm)	RESULT
36	5180	MCS0	full	12.78	18.967	23.98	PASS
		MCS0	26/0	11.98	15.776	23.98	PASS
		MCS0	52/37	12.93	19.634	23.98	PASS
		MCS0	106/53	12.97	19.815	23.98	PASS
44	5220	MCS0	full	12.54	17.947	23.98	PASS
48	5240	MCS0	full	12.67	18.493	23.98	PASS
52	5260	MCS0	full	12.65	18.408	23.98 or 11+10log(B) = 24.15	PASS
60	5300	MCS0	full	12.51	17.824	23.98 or 11+10log(B) = 24.07	PASS
64	5320	MCS0	full	12.67	18.493	23.98 or 11+10log(B) = 24.11	PASS
		MCS0	26/8	11.95	15.668	23.98 or 11+10log(B) = 24.11	PASS
		MCS0	52/40	12.75	18.836	23.98 or 11+10log(B) = 24.11	PASS
		MCS0	106/54	12.82	19.143	23.98 or 11+10log(B) = 24.11	PASS
100	5500	MCS0	full	12.60	18.197	23.98 or 11+10log(B) = 24.12	PASS
		MCS0	26/0	11.84	15.276	23.98 or 11+10log(B) = 24.12	PASS
		MCS0	52/37	12.89	19.454	23.98 or 11+10log(B) = 24.12	PASS
		MCS0	106/53	12.94	19.679	23.98 or 11+10log(B) = 24.12	PASS
116	5580	MCS0	full	12.77	18.923	23.98 or 11+10log(B) = 24.09	PASS
140	5700	MCS0	full	12.77	18.923	23.98 or 11+10log(B) = 24.09	PASS
		MCS0	26/8	11.85	15.311	23.98 or 11+10log(B) = 24.09	PASS
		MCS0	52/40	12.91	19.543	23.98 or 11+10log(B) = 24.09	PASS
		MCS0	106/54	12.93	19.634	23.98 or 11+10log(B) = 24.09	PASS
144	5720(U-NII 2C)	MCS0	full	11.64	14.593	23.98 or 11+10log(B) = 22.82	PASS
144	5720 (U-NII 3)	MCS0	full	6.99	4.995	30	PASS
149	5745	MCS0	full	12.78	18.967	30	PASS
		MCS0	26/0	11.97	15.740	30	PASS
		MCS0	52/37	12.99	19.907	30	PASS
		MCS0	106/53	12.65	18.408	30	PASS
157	5785	MCS0	full	12.77	18.923	30	PASS
165	5825	MCS0	full	12.77	18.923	30	PASS
		MCS0	26/8	11.79	15.101	30	PASS
		MCS0	52/40	12.81	19.099	30	PASS
		MCS0	106/54	12.91	19.543	30	PASS

Unless otherwise stated the results shown in this test report refer only to the sample(s) tested and such sample(s) are retained for 90 days only.

除非另有說明，此報告結果僅對測試之樣品負責，同時此樣品僅保留90天。本報告未經本公司書面許可，不可部份複製。

This document is issued by the Company subject to its General Conditions of Service printed overleaf, available on request or accessible at <http://www.sgs.com.tw/Terms-and-Conditions> and for electronic format documents, subject to Terms and Conditions for Electronic Documents at <http://www.sgs.com.tw/Terms-and-Conditions>. Attention is drawn to the limitation of liability, indemnification and jurisdiction issues defined therein. Any holder of this document is advised that information contained hereon reflects the Company's findings at the time of its intervention only and within the limits of Client's instructions, if any. The Company's sole responsibility is to its Client and this document does not exonerate parties to a transaction from exercising all their rights and obligations under the transaction documents. This document cannot be reproduced except in full, without prior written approval of the Company. Any unauthorized alteration, forgery or falsification of the content or appearance of this document is unlawful and offenders may be prosecuted to the fullest extent of the law.

802.11ax_20_MIMO

CH	Frequency (MHz)	Data Rate	RU config.	Avg. POWER (dBm)		TOTAL POWER (dBm)	TOTAL POWER (mW)	REQUIRED LIMIT (dBm)	RESULT
				CH 0	CH 1				
36	5180	MCS0	full	12.05	13.71	15.97	39.529	23.98	PASS
		MCS0	26/0	11.45	11.94	14.71	29.595	23.98	PASS
		MCS0	52/37	12.37	13.22	15.83	38.248	23.98	PASS
		MCS0	106/53	12.48	13.23	15.88	38.739	23.98	PASS
44	5220	MCS0	full	12.03	13.53	15.85	38.501	23.98	PASS
48	5240	MCS0	full	11.95	13.68	15.91	39.002	23.98	PASS
52	5260	MCS0	full	11.95	13.68	15.91	39.002	23.98 or 11+10log(B) = 24.06	PASS
60	5300	MCS0	full	11.8	13.41	15.69	37.064	23.98 or 11+10log(B) = 24.07	PASS
64	5320	MCS0	full	11.78	13.51	15.74	37.505	23.98 or 11+10log(B) = 24.10	PASS
		MCS0	26/8	11.4	12.49	14.99	31.546	23.98 or 11+10log(B) = 24.10	PASS
		MCS0	52/40	12.46	13.42	15.98	39.598	23.98 or 11+10log(B) = 24.10	PASS
		MCS0	106/54	12.23	13.21	15.76	37.652	23.98 or 11+10log(B) = 24.10	PASS
100	5500	MCS0	full	11.84	13.35	15.67	36.903	23.98 or 11+10log(B) = 24.11	PASS
		MCS0	26/0	11.63	12.29	14.98	31.498	23.98 or 11+10log(B) = 24.11	PASS
		MCS0	52/37	12.59	13.28	15.96	39.437	23.98 or 11+10log(B) = 24.11	PASS
		MCS0	106/53	12.64	13.29	15.99	39.696	23.98 or 11+10log(B) = 24.11	PASS
116	5580	MCS0	full	11.97	13.74	15.95	39.399	23.98 or 11+10log(B) = 24.09	PASS
140	5700	MCS0	full	11.93	13.39	15.73	37.423	23.98 or 11+10log(B) = 24.09	PASS
		MCS0	26/8	11.68	12.24	14.98	31.473	23.98 or 11+10log(B) = 24.09	PASS
		MCS0	52/40	12.55	13.37	15.99	39.716	23.98 or 11+10log(B) = 24.09	PASS
		MCS0	106/54	12.58	13.35	15.99	39.741	23.98 or 11+10log(B) = 24.09	PASS
144	5720(U-NII 2C)	MCS0	full	10.59	12.08	14.41	27.604	23.98 or 11+10log(B) = 22.80	PASS
144	5720 (U-NII 3)	MCS0	full	5.90	7.43	9.74	9.420	30	PASS
149	5745	MCS0	full	12.07	13.54	15.88	38.701	30	PASS
		MCS0	26/0	11.21	12.06	14.67	29.282	30	PASS
		MCS0	52/37	12.25	13.12	15.72	37.300	30	PASS
		MCS0	106/53	12.39	13.09	15.76	37.708	30	PASS
157	5785	MCS0	full	12.05	13.42	15.80	38.011	30	PASS
165	5825	MCS0	full	12.15	13.41	15.84	38.334	30	PASS
		MCS0	26/8	11.41	12.49	14.99	31.578	30	PASS
		MCS0	52/40	12.58	13.33	15.98	39.641	30	PASS
		MCS0	106/54	12.26	13.12	15.72	37.338	30	PASS

802.11ax_40_Ch0

CH	Frequency (MHz)	Data Rate	RU config.	TOTAL POWER (dBm)	TOTAL POWER (mW)	REQUIRED LIMIT (dBm)	RESULT
38	5190	MCS0	full	12.98	19.861	23.98	PASS
		MCS0	242/61	12.81	19.099	23.98	PASS
46	5230	MCS0	full	12.96	19.770	23.98	PASS
54	5270	MCS0	full	12.92	19.588	23.98 or 11+10log(B) = 27.00	PASS
62	5310	MCS0	full	12.81	19.099	23.98 or 11+10log(B) = 27.00	PASS
		MCS0	242/62	12.91	19.543	23.98 or 11+10log(B) = 27.00	PASS
102	5510	MCS0	full	12.97	19.815	23.98 or 11+10log(B) = 27.02	PASS
		MCS0	242/61	12.67	18.493	23.98 or 11+10log(B) = 27.02	PASS
110	5550	MCS0	full	12.99	19.907	23.98 or 11+10log(B) = 27.03	PASS
134	5670	MCS0	full	12.97	19.815	23.98 or 11+10log(B) = 27.02	PASS
		MCS0	242/62	12.84	19.231	23.98 or 11+10log(B) = 27.02	PASS
142	5710(U-NII 2C)	MCS0	full	12.40	17.381	23.98 or 11+10log(B) = 26.45	PASS
142	5710 (U-NII 3)	MCS0	full	4.02	2.525	30	PASS
151	5755	MCS0	full	12.96	19.770	30	PASS
		MCS0	242/61	12.94	19.679	30	PASS
159	5795	MCS0	full	12.98	19.861	30	PASS
		MCS0	242/62	12.90	19.498	30	PASS

Unless otherwise stated the results shown in this test report refer only to the sample(s) tested and such sample(s) are retained for 90 days only.

除非另有說明，此報告結果僅對測試之樣品負責，同時此樣品僅保留90天。本報告未經本公司書面許可，不可部份複製。

This document is issued by the Company subject to its General Conditions of Service printed overleaf, available on request or accessible at <http://www.sgs.com.tw/Terms-and-Conditions> and for electronic format documents, subject to Terms and Conditions for Electronic Documents at <http://www.sgs.com.tw/Terms-and-Conditions>. Attention is drawn to the limitation of liability, indemnification and jurisdiction issues defined therein. Any holder of this document is advised that information contained hereon reflects the Company's findings at the time of its intervention only and within the limits of Client's instructions, if any. The Company's sole responsibility is to its Client and this document does not exonerate parties to a transaction from exercising all their rights and obligations under the transaction documents. This document cannot be reproduced except in full, without prior written approval of the Company. Any unauthorized alteration, forgery or falsification of the content or appearance of this document is unlawful and offenders may be prosecuted to the fullest extent of the law.

802.11ax_40_Ch1

CH	Frequency (MHz)	Data Rate	RU config.	TOTAL POWER (dBm)	TOTAL POWER (mW)	REQUIRED LIMIT (dBm)	RESULT
38	5190	MCS0	full	12.96	19.770	23.98	PASS
		MCS0	242/61	12.81	19.099	23.98	PASS
46	5230	MCS0	full	12.72	18.707	23.98	PASS
54	5270	MCS0	full	12.73	18.750	23.98 or 11+10log(B) = 27.01	PASS
62	5310	MCS0	full	12.77	18.923	23.98 or 11+10log(B) = 27.02	PASS
		MCS0	242/62	12.98	19.861	23.98 or 11+10log(B) = 27.02	PASS
102	5510	MCS0	full	12.56	18.030	23.98 or 11+10log(B) = 27.02	PASS
		MCS0	242/61	12.88	19.409	23.98 or 11+10log(B) = 27.02	PASS
110	5550	MCS0	full	12.86	19.320	23.98 or 11+10log(B) = 27.00	PASS
134	5670	MCS0	full	12.89	19.454	23.98 or 11+10log(B) = 27.01	PASS
		MCS0	242/62	12.97	19.815	23.98 or 11+10log(B) = 27.01	PASS
142	5710(U-NII 2C)	MCS0	full	12.27	16.874	23.98 or 11+10log(B) = 26.42	PASS
142	5710 (U-NII 3)	MCS0	full	3.72	2.357	30	PASS
151	5755	MCS0	full	12.82	19.143	30	PASS
		MCS0	242/61	12.73	18.750	30	PASS
159	5795	MCS0	full	12.81	19.099	30	PASS
		MCS0	242/62	12.99	19.907	30	PASS

802.11ax_40_MIMO

CH	Frequency (MHz)	Data Rate	RU config.	Avg. POWER (dBm)		TOTAL POWER (dBm)	TOTAL POWER (mW)	REQUIRED LIMIT (dBm)	RESULT
				CH 0	CH 1				
38	5190	MCS0	full	12.04	13.76	15.99	39.764	23.98	PASS
		MCS0	242/61	12.49	13.42	15.99	39.720	23.98	PASS
46	5230	MCS0	full	11.95	13.78	15.97	39.546	23.98	PASS
54	5270	MCS0	full	11.94	13.76	15.95	39.400	23.98 or 11+10log(B) = 27.00	PASS
62	5310	MCS0	full	11.89	13.72	15.91	39.003	23.98 or 11+10log(B) = 27.00	PASS
		MCS0	242/62	12.3	13.45	15.92	39.113	23.98 or 11+10log(B) = 27.00	PASS
102	5510	MCS0	full	11.96	13.21	15.64	36.645	23.98 or 11+10log(B) = 27.02	PASS
		MCS0	242/61	12.47	12.89	15.70	37.114	23.98 or 11+10log(B) = 27.02	PASS
110	5550	MCS0	full	12.07	13.42	15.81	38.085	23.98 or 11+10log(B) = 27.00	PASS
134	5670	MCS0	full	11.99	13.36	15.74	37.490	23.98 or 11+10log(B) = 27.01	PASS
		MCS0	242/62	12.44	12.96	15.72	37.309	23.98 or 11+10log(B) = 27.01	PASS
142	5710(U-NII 2C)	MCS0	full	11.82	12.91	15.41	34.762	23.98 or 11+10log(B) = 26.42	PASS
142	5710 (U-NII 3)	MCS0	full	3.44	4.36	6.94	4.941	30	PASS
151	5755	MCS0	full	12.08	13.49	15.85	38.479	30	PASS
		MCS0	242/61	12.3	13.39	15.89	38.810	30	PASS
159	5795	MCS0	full	12.23	13.44	15.89	38.791	30	PASS
		MCS0	242/62	12.41	13.22	15.84	38.407	30	PASS

802.11ax_80_Ch0

CH	Frequency (MHz)	Data Rate	RU config.	TOTAL POWER (dBm)	TOTAL POWER (mW)	REQUIRED LIMIT (dBm)	RESULT
42	5210	MCS0	full	12.76	18.880	23.98	PASS
		MCS0	484/65	12.88	19.409	23.98	PASS
58	5290	MCS0	full	12.75	18.836	23.98 or 11+10log(B) = 30.10	PASS
		MCS0	484/66	12.82	19.143	23.98 or 11+10log(B) = 30.10	PASS
106	5530	MCS0	full	12.99	19.907	23.98 or 11+10log(B) = 30.10	PASS
		MCS0	484/65	12.97	19.815	23.98 or 11+10log(B) = 30.10	PASS
122	5610	MCS0	full	12.97	19.815	23.98 or 11+10log(B) = 30.08	PASS
		MCS0	484/66	12.83	19.187	23.98 or 11+10log(B) = 30.08	PASS
138	5690(U-NII 2C)	MCS0	full	12.66	18.459	23.98 or 11+10log(B) = 30.11	PASS
138	5690 (U-NII 3)	MCS0	full	1.47	1.402	30	PASS
155	5775	MCS0	full	12.99	19.907	30	PASS
		MCS0	484/65	12.81	19.099	30	PASS
		MCS0	484/66	12.93	19.634	30	PASS

Unless otherwise stated the results shown in this test report refer only to the sample(s) tested and such sample(s) are retained for 90 days only.

除非另有說明，此報告結果僅對測試之樣品負責，同時此樣品僅保留90天。本報告未經本公司書面許可，不可部份複製。

This document is issued by the Company subject to its General Conditions of Service printed overleaf, available on request or accessible at <http://www.sgs.com.tw/Terms-and-Conditions> and for electronic format documents, subject to Terms and Conditions for Electronic Documents at <http://www.sgs.com.tw/Terms-and-Conditions>. Attention is drawn to the limitation of liability, indemnification and jurisdiction issues defined therein. Any holder of this document is advised that information contained hereon reflects the Company's findings at the time of its intervention only and within the limits of Client's instructions, if any. The Company's sole responsibility is to its Client and this document does not exonerate parties to a transaction from exercising all their rights and obligations under the transaction documents. This document cannot be reproduced except in full, without prior written approval of the Company. Any unauthorized alteration, forgery or falsification of the content or appearance of this document is unlawful and offenders may be prosecuted to the fullest extent of the law.

802.11ax_80_Ch1

CH	Frequency (MHz)	Data Rate	RU config.	TOTAL POWER (dBm)	TOTAL POWER (mW)	REQUIRED LIMIT (dBm)		RESULT
42	5210	MCS0	full	12.72	18.707	23.98		PASS
		MCS0	484/65	12.88	19.409	23.98		PASS
58	5290	MCS0	full	12.70	18.621	23.98	or 11+10log(B) = 30.08	PASS
		MCS0	484/66	12.84	19.231	23.98	or 11+10log(B) = 30.08	PASS
106	5530	MCS0	full	12.96	19.770	23.98	or 11+10log(B) = 30.07	PASS
		MCS0	484/65	12.95	19.724	23.98	or 11+10log(B) = 30.07	PASS
122	5610	MCS0	full	12.61	18.239	23.98	or 11+10log(B) = 30.09	PASS
		MCS0	484/66	12.76	18.880	23.98	or 11+10log(B) = 30.09	PASS
138	5690(U-NII 2C)	MCS0	full	12.21	16.634	23.98	or 11+10log(B) = 30.07	PASS
138	5690 (U-NII 3)	MCS0	full	0.76	1.190	30		PASS
155	5775	MCS0	full	12.67	18.493	30		PASS
		MCS0	484/65	12.88	19.409	30		PASS
		MCS0	484/66	12.81	19.099	30		PASS

802.11ax_80_MIMO

CH	Frequency (MHz)	Data Rate	RU config.	Avg. POWER (dBm)		TOTAL POWER (dBm)	TOTAL POWER (mW)	REQUIRED LIMIT (dBm)	RESULT
				CH 0	CH 1				
42	5210	MCS0	full	12.09	13.72	15.99	39.731	23.98	PASS
		MCS0	484/65	12.55	13.16	15.88	38.690	23.98	PASS
58	5290	MCS0	full	12.11	13.66	15.96	39.483	23.98 or 11+10log(B) = 30.08	PASS
		MCS0	484/66	12.51	13.22	15.89	38.813	23.98 or 11+10log(B) = 30.08	PASS
106	5530	MCS0	full	11.84	13.53	15.78	37.818	23.98 or 11+10log(B) = 30.07	PASS
		MCS0	484/65	12.3	13.04	15.70	37.120	23.98 or 11+10log(B) = 30.07	PASS
122	5610	MCS0	full	12.04	13.48	15.83	38.280	23.98 or 11+10log(B) = 30.08	PASS
		MCS0	484/66	12.55	13.32	15.96	39.467	23.98 or 11+11log(B) = 30.08	PASS
138	5690(U-NII 2C)	MCS0	full	11.71	13.14	15.49	35.438	23.98 or 11+10log(B) = 30.07	PASS
138	5690 (U-NII 3)	MCS0	full	0.52	1.69	4.15	2.601	30	PASS
155	5775	MCS0	full	12.16	13.61	15.96	39.405	30	PASS
		MCS0	484/65	12.27	13.54	15.96	39.460	30	PASS
		MCS0	484/66	12.26	13.27	15.80	38.059	30	PASS

Unless otherwise stated the results shown in this test report refer only to the sample(s) tested and such sample(s) are retained for 90 days only.

除非另有說明，此報告結果僅對測試之樣品負責，同時此樣品僅保留90天。本報告未經本公司書面許可，不可部份複製。

This document is issued by the Company subject to its General Conditions of Service printed overleaf, available on request or accessible at <http://www.sgs.com.tw/Terms-and-Conditions> and for electronic format documents, subject to Terms and Conditions for Electronic Documents at <http://www.sgs.com.tw/Terms-and-Conditions>. Attention is drawn to the limitation of liability, indemnification and jurisdiction issues defined therein. Any holder of this document is advised that information contained hereon reflects the Company's findings at the time of its intervention only and within the limits of Client's instructions, if any. The Company's sole responsibility is to its Client and this document does not exonerate parties to a transaction from exercising all their rights and obligations under the transaction documents. This document cannot be reproduced except in full, without prior written approval of the Company. Any unauthorized alteration, forgery or falsification of the content or appearance of this document is unlawful and offenders may be prosecuted to the fullest extent of the law.

9.5.2 ISED EIRP

802.11a_Ch0

CH	Frequency (MHz)	TOTAL POWER (dBm)	Antenna Gain (dBi)	EIRP (dBm)	EIRP (mW)	REQUIRED LIMIT (dBm)	RESULT
36	5180	12.99	-5.000	7.99	6.300	23.01 or 10+10log(B)= 22.13	PASS
44	5220	12.96	-5.000	7.96	6.257	23.01 or 10+10log(B)= 22.13	PASS
48	5240	12.94	-5.000	7.94	6.228	23.01 or 10+10log(B)= 22.13	PASS
52	5260	12.93	-5.000	7.93	6.214	30 or 17+10log(B)= 29.13	PASS
60	5300	12.96	-5.000	7.96	6.257	30 or 17+10log(B)= 29.13	PASS
64	5320	12.93	-5.000	7.93	6.214	30 or 17+10log(B)= 29.13	PASS
100	5500	12.98	-5.000	7.98	6.286	30 or 17+10log(B)= 29.13	PASS
116	5580	12.95	-5.000	7.95	6.243	30 or 17+10log(B)= 29.13	PASS
140	5700	12.93	-5.000	7.93	6.214	30 or 17+10log(B)= 29.13	PASS

802.11n_HT20_Ch0

CH	Frequency (MHz)	TOTAL POWER (dBm)	Antenna Gain (dBi)	EIRP (dBm)	EIRP (mW)	REQUIRED LIMIT (dBm)	RESULT
36	5180	12.98	-5.000	7.98	6.281	23.01 or 10+10log(B)= 22.44	PASS
44	5220	12.95	-5.000	7.95	6.237	23.01 or 10+10log(B)= 22.44	PASS
48	5240	12.83	-5.000	7.83	6.067	23.01 or 10+10log(B)= 22.44	PASS
52	5260	12.81	-5.000	7.81	6.039	30 or 17+10log(B)= 29.44	PASS
60	5300	12.98	-5.000	7.98	6.281	30 or 17+10log(B)= 29.44	PASS
64	5320	12.99	-5.000	7.99	6.295	30 or 17+10log(B)= 29.44	PASS
100	5500	12.89	-5.000	7.89	6.152	30 or 17+10log(B)= 29.44	PASS
116	5580	12.87	-5.000	7.87	6.124	30 or 17+10log(B)= 29.44	PASS
140	5700	12.94	-5.000	7.94	6.223	30 or 17+10log(B)= 29.44	PASS

802.11n_HT20_Ch1

CH	Frequency (MHz)	TOTAL POWER (dBm)	Antenna Gain (dBi)	EIRP (dBm)	EIRP (mW)	REQUIRED LIMIT (dBm)	RESULT
36	5180	12.58	-2.300	10.28	10.666	23.01 or 10+10log(B)= 22.44	PASS
44	5220	12.82	-2.300	10.52	11.272	23.01 or 10+10log(B)= 22.44	PASS
48	5240	12.56	-2.300	10.26	10.617	23.01 or 10+10log(B)= 22.44	PASS
52	5260	12.54	-2.300	10.24	10.568	30 or 17+10log(B)= 22.44	PASS
60	5300	12.81	-2.300	10.51	11.246	30 or 17+10log(B)= 22.44	PASS
64	5320	12.79	-2.300	10.49	11.194	30 or 17+10log(B)= 22.44	PASS
100	5500	12.44	-2.300	10.14	10.328	30 or 17+10log(B)= 22.44	PASS
116	5580	12.72	-2.300	10.42	11.015	30 or 17+10log(B)= 22.43	PASS
140	5700	12.63	-2.300	10.33	10.789	30 or 17+10log(B)= 22.44	PASS

802.11n_HT20_MIMO

CH	Frequency (MHz)	TOTAL POWER (dBm)	Antenna Gain (dBi)	EIRP (dBm)	EIRP (mW)	REQUIRED LIMIT (dBm)	RESULT
36	5180	15.94	-0.540	15.40	34.712	23.01 or 10+10log(B)= 22.44	PASS
44	5220	15.73	-0.540	15.19	33.010	23.01 or 10+10log(B)= 22.44	PASS
48	5240	15.89	-0.540	15.35	34.268	23.01 or 10+10log(B)= 22.44	PASS
52	5260	15.58	-0.540	15.04	31.892	30 or 17+10log(B)= 29.44	PASS
60	5300	15.57	-0.540	15.03	31.842	30 or 17+10log(B)= 29.44	PASS
64	5320	15.61	-0.540	15.07	32.158	30 or 17+10log(B)= 29.44	PASS
100	5500	15.55	-0.540	15.01	31.718	30 or 17+10log(B)= 29.44	PASS
116	5580	15.92	-0.540	15.38	34.506	30 or 17+10log(B)= 29.43	PASS
140	5700	15.53	-0.540	14.99	31.563	30 or 17+10log(B)= 29.44	PASS

Unless otherwise stated the results shown in this test report refer only to the sample(s) tested and such sample(s) are retained for 90 days only.

除非另有說明，此報告結果僅對測試之樣品負責，同時此樣品僅保留90天。本報告未經本公司書面許可，不可部份複製。

This document is issued by the Company subject to its General Conditions of Service printed overleaf, available on request or accessible at <http://www.sgs.com.tw/Terms-and-Conditions> and for electronic format documents, subject to Terms and Conditions for Electronic Documents at <http://www.sgs.com.tw/Terms-and-Conditions>. Attention is drawn to the limitation of liability, indemnification and jurisdiction issues defined therein. Any holder of this document is advised that information contained hereon reflects the Company's findings at the time of its intervention only and within the limits of Client's instructions, if any. The Company's sole responsibility is to its Client and this document does not exonerate parties to a transaction from exercising all their rights and obligations under the transaction documents. This document cannot be reproduced except in full, without prior written approval of the Company. Any unauthorized alteration, forgery or falsification of the content or appearance of this document is unlawful and offenders may be prosecuted to the fullest extent of the law.

802.11n_HT40_Ch0

CH	Frequency (MHz)	TOTAL POWER (dBm)	Antenna Gain (dBi)	EIRP (dBm)	EIRP (mW)	REQUIRED LIMIT (dBm)	RESULT
38	5190	12.76	-5.000	7.76	5.970	23.01 or 10+10log(B)= 25.56	PASS
46	5230	12.78	-5.000	7.78	5.998	23.01 or 10+10log(B)= 25.56	PASS
54	5270	12.72	-5.000	7.72	5.916	30 or 17+10log(B)= 32.56	PASS
62	5310	12.90	-5.000	7.90	6.166	30 or 17+10log(B)= 32.56	PASS
102	5510	12.99	-5.000	7.99	6.295	30 or 17+10log(B)= 32.56	PASS
110	5550	12.97	-5.000	7.97	6.266	30 or 17+10log(B)= 32.56	PASS
134	5670	12.94	-5.000	7.94	6.223	30 or 17+10log(B)= 32.56	PASS

802.11n_HT40_Ch1

CH	Frequency (MHz)	TOTAL POWER (dBm)	Antenna Gain (dBi)	EIRP (dBm)	EIRP (mW)	REQUIRED LIMIT (dBm)	RESULT
38	5190	12.72	-2.300	10.42	11.015	23.01 or 10+10log(B)= 25.57	PASS
46	5230	12.76	-2.300	10.46	11.117	23.01 or 10+10log(B)= 25.56	PASS
54	5270	12.68	-2.300	10.38	10.914	30 or 17+10log(B)= 32.56	PASS
62	5310	12.54	-2.300	10.24	10.568	30 or 17+10log(B)= 32.56	PASS
102	5510	12.57	-2.300	10.27	10.641	30 or 17+10log(B)= 32.56	PASS
110	5550	12.56	-2.300	10.26	10.617	30 or 17+10log(B)= 32.56	PASS
134	5670	12.59	-2.300	10.29	10.691	30 or 17+10log(B)= 32.56	PASS

802.11n_HT40_MIMO

CH	Frequency (MHz)	TOTAL POWER (dBm)	Antenna Gain (dBi)	EIRP (dBm)	EIRP (mW)	REQUIRED LIMIT (dBm)	RESULT
38	5190	15.83	-0.540	15.29	33.817	23.01 or 10+10log(B)= 25.56	PASS
46	5230	15.65	-0.540	15.11	32.470	23.01 or 10+10log(B)= 25.56	PASS
54	5270	15.63	-0.540	15.09	32.321	30 or 17+10log(B)= 32.56	PASS
62	5310	15.65	-0.540	15.11	32.450	30 or 17+10log(B)= 32.56	PASS
102	5510	15.68	-0.540	15.14	32.692	30 or 17+10log(B)= 32.56	PASS
110	5550	15.91	-0.540	15.37	34.453	30 or 17+10log(B)= 32.56	PASS
134	5670	15.77	-0.540	15.23	33.336	30 or 17+10log(B)= 32.56	PASS

802.11ac_VHT80_Ch0

CH	Frequency (MHz)	TOTAL POWER (dBm)	Antenna Gain (dBi)	EIRP (dBm)	EIRP (mW)	REQUIRED LIMIT (dBm)	RESULT
42	5210	12.80	-5.000	7.80	6.026	23.01 or 10+10log(B)= 28.77	PASS
58	5290	12.72	-5.000	7.72	5.916	30 or 17+10log(B)= 35.78	PASS
106	5530	12.95	-5.000	7.95	6.237	30 or 17+10log(B)= 35.77	PASS

802.11ac_VHT80_Ch1

CH	Frequency (MHz)	TOTAL POWER (dBm)	Antenna Gain (dBi)	EIRP (dBm)	EIRP (mW)	REQUIRED LIMIT (dBm)	RESULT
42	5210	12.74	-2.300	10.44	11.066	23.01 or 10+10log(B)= 28.77	PASS
58	5290	12.68	-2.300	10.38	10.914	30 or 17+10log(B)= 35.77	PASS
106	5530	12.91	-2.300	10.61	11.508	30 or 17+10log(B)= 35.77	PASS

802.11ac_VHT80_MIMO

CH	Frequency (MHz)	TOTAL POWER (dBm)	Antenna Gain (dBi)	EIRP (dBm)	EIRP (mW)	REQUIRED LIMIT (dBm)	RESULT
42	5210	15.54	-0.540	15.00	31.590	23.01 or 10+10log(B)= 28.77	PASS
58	5290	15.54	-0.540	15.00	31.606	30 or 17+10log(B)= 35.77	PASS
106	5530	15.75	-0.540	15.21	33.211	30 or 17+10log(B)= 35.77	PASS

Unless otherwise stated the results shown in this test report refer only to the sample(s) tested and such sample(s) are retained for 90 days only.

除非另有說明，此報告結果僅對測試之樣品負責，同時此樣品僅保留90天。本報告未經本公司書面許可，不可部份複製。

This document is issued by the Company subject to its General Conditions of Service printed overleaf, available on request or accessible at <http://www.sgs.com.tw/Terms-and-Conditions> and for electronic format documents, subject to Terms and Conditions for Electronic Documents at <http://www.sgs.com.tw/Terms-and-Conditions>. Attention is drawn to the limitation of liability, indemnification and jurisdiction issues defined therein. Any holder of this document is advised that information contained hereon reflects the Company's findings at the time of its intervention only and within the limits of Client's instructions, if any. The Company's sole responsibility is to its Client and this document does not exonerate parties to a transaction from exercising all their rights and obligations under the transaction documents. This document cannot be reproduced except in full, without prior written approval of the Company. Any unauthorized alteration, forgery or falsification of the content or appearance of this document is unlawful and offenders may be prosecuted to the fullest extent of the law.

802.11ax_20_Ch0

CH	Frequency (MHz)	RU config.	TOTAL POWER (dBm)	Antenna Gain (dBi)	EIRP (dBm)	EIRP (mW)	REQUIRED LIMIT (dBm)		RESULT
36	5180	full	12.98	-5.000	7.98	6.281	23.01	or 10+10log(B)= 22.76	PASS
		26/0	11.74	-5.000	6.74	4.721	23.01	or 10+10log(B)= 22.76	PASS
		52/37	12.73	-5.000	7.73	5.929	23.01	or 10+10log(B)= 22.76	PASS
		106/53	12.88	-5.000	7.88	6.138	23.01	or 10+10log(B)= 22.76	PASS
44	5220	full	12.99	-5.000	7.99	6.295	23.01	or 10+10log(B)= 22.75	PASS
48	5240	full	12.85	-5.000	7.85	6.095	23.01	or 10+10log(B)= 22.76	PASS
52	5260	full	12.83	-5.000	7.83	6.067	30	or 17+10log(B)= 29.75	PASS
60	5300	full	12.82	-5.000	7.82	6.053	30	or 17+10log(B)= 29.77	PASS
64	5320	full	12.85	-5.000	7.85	6.095	30	or 17+10log(B)= 29.76	PASS
		26/8	11.74	-5.000	6.74	4.721	30	or 17+10log(B)= 29.76	PASS
		52/40	12.88	-5.000	7.88	6.138	30	or 17+10log(B)= 29.76	PASS
		106/54	12.95	-5.000	7.95	6.237	30	or 17+10log(B)= 29.76	PASS
100	5500	full	12.97	-5.000	7.97	6.266	30	or 17+10log(B)= 29.76	PASS
		26/0	11.94	-5.000	6.94	4.943	30	or 17+10log(B)= 29.76	PASS
		52/37	12.86	-5.000	7.86	6.109	30	or 17+10log(B)= 29.76	PASS
		106/53	12.97	-5.000	7.97	6.266	30	or 17+10log(B)= 29.76	PASS
116	5580	full	12.93	-5.000	7.93	6.209	30	or 17+10log(B)= 29.76	PASS
140	5700	full	12.92	-5.000	7.92	6.194	30	or 17+10log(B)= 29.76	PASS
		26/8	11.94	-5.000	6.94	4.943	30	or 17+10log(B)= 29.76	PASS
		52/40	12.94	-5.000	7.94	6.223	30	or 17+10log(B)= 29.76	PASS
		106/54	12.76	-5.000	7.76	5.970	30	or 17+10log(B)= 29.76	PASS

802.11ax_20_Ch1

CH	Frequency (MHz)	RU config.	TOTAL POWER (dBm)	Antenna Gain (dBi)	EIRP (dBm)	EIRP (mW)	REQUIRED LIMIT (dBm)		RESULT
36	5180	full	12.78	-2.300	10.48	11.169	23.01	or 10+10log(B)= 22.76	PASS
		26/0	11.98	-2.300	9.68	9.290	23.01	or 10+10log(B)= 22.76	PASS
		52/37	12.93	-2.300	10.63	11.561	23.01	or 10+10log(B)= 22.76	PASS
		106/53	12.97	-2.300	10.67	11.668	23.01	or 10+10log(B)= 22.76	PASS
44	5220	full	12.54	-2.300	10.24	10.568	23.01	or 10+10log(B)= 22.75	PASS
48	5240	full	12.67	-2.300	10.37	10.889	23.01	or 10+10log(B)= 22.76	PASS
52	5260	full	12.65	-2.300	10.35	10.839	30	or 17+10log(B)= 29.76	PASS
60	5300	full	12.51	-2.300	10.21	10.495	30	or 17+10log(B)= 29.76	PASS
64	5320	full	12.67	-2.300	10.37	10.889	30	or 17+10log(B)= 29.75	PASS
		26/8	11.95	-2.300	9.65	9.226	30	or 17+10log(B)= 29.75	PASS
		52/40	12.75	-2.300	10.45	11.092	30	or 17+10log(B)= 29.75	PASS
		106/54	12.82	-2.300	10.52	11.272	30	or 17+10log(B)= 29.75	PASS
100	5500	full	12.60	-2.300	10.30	10.715	30	or 17+10log(B)= 29.76	PASS
		26/0	11.84	-2.300	9.54	8.995	30	or 17+10log(B)= 29.76	PASS
		52/37	12.89	-2.300	10.59	11.455	30	or 17+10log(B)= 29.76	PASS
		106/53	12.94	-2.300	10.64	11.588	30	or 17+10log(B)= 29.76	PASS
116	5580	full	12.77	-2.300	10.47	11.143	30	or 17+10log(B)= 29.76	PASS
140	5700	full	12.77	-2.300	10.47	11.143	30	or 17+10log(B)= 29.76	PASS
		26/8	11.85	-2.300	9.55	9.016	30	or 17+10log(B)= 29.76	PASS
		52/40	12.91	-2.300	10.61	11.508	30	or 17+10log(B)= 29.76	PASS
		106/54	12.93	-2.300	10.63	11.561	30	or 17+10log(B)= 29.76	PASS

Unless otherwise stated the results shown in this test report refer only to the sample(s) tested and such sample(s) are retained for 90 days only.

除非另有說明，此報告結果僅對測試之樣品負責，同時此樣品僅保留90天。本報告未經本公司書面許可，不可部份複製。

This document is issued by the Company subject to its General Conditions of Service printed overleaf, available on request or accessible at <http://www.sgs.com.tw/Terms-and-Conditions> and for electronic format documents, subject to Terms and Conditions for Electronic Documents at <http://www.sgs.com.tw/Terms-and-Conditions>. Attention is drawn to the limitation of liability, indemnification and jurisdiction issues defined therein. Any holder of this document is advised that information contained hereon reflects the Company's findings at the time of its intervention only and within the limits of Client's instructions, if any. The Company's sole responsibility is to its Client and this document does not exonerate parties to a transaction from exercising all their rights and obligations under the transaction documents. This document cannot be reproduced except in full, without prior written approval of the Company. Any unauthorized alteration, forgery or falsification of the content or appearance of this document is unlawful and offenders may be prosecuted to the fullest extent of the law.

802.11ax_20_MIMO

CH	Frequency (MHz)	RU config.	TOTAL POWER (dBm)	Antenna Gain (dBi)	EIRP (dBm)	EIRP (mW)	REQUIRED LIMIT (dBm)		RESULT
36	5180	full	15.97	-0.540	15.43	34.907	23.01	or 10+10log(B)= 22.76	PASS
		26/0	14.71	-0.540	14.17	26.135	23.01	or 10+10log(B)= 22.76	PASS
		52/37	15.83	-0.540	15.29	33.776	23.01	or 10+10log(B)= 22.76	PASS
		106/53	15.88	-0.540	15.34	34.210	23.01	or 10+10log(B)= 22.76	PASS
44	5220	full	15.85	-0.540	15.31	34.000	23.01	or 10+10log(B)= 22.75	PASS
48	5240	full	15.91	-0.540	15.37	34.442	23.01	or 10+10log(B)= 22.76	PASS
52	5260	full	15.91	-0.540	15.37	34.442	30	or 17+10log(B)= 29.75	PASS
60	5300	full	15.69	-0.540	15.15	32.730	30	or 17+10log(B)= 29.76	PASS
64	5320	full	15.74	-0.540	15.20	33.120	30	or 17+10log(B)= 29.75	PASS
		26/8	14.99	-0.540	14.45	27.857	30	or 17+10log(B)= 29.75	PASS
		52/40	15.98	-0.540	15.44	34.969	30	or 17+10log(B)= 29.75	PASS
		106/54	15.76	-0.540	15.22	33.250	30	or 17+10log(B)= 29.75	PASS
100	5500	full	15.67	-0.540	15.13	32.588	30	or 17+10log(B)= 29.76	PASS
		26/0	14.98	-0.540	14.44	27.815	30	or 17+10log(B)= 29.76	PASS
		52/37	15.96	-0.540	15.42	34.826	30	or 17+10log(B)= 29.76	PASS
		106/53	15.99	-0.540	15.45	35.055	30	or 17+10log(B)= 29.76	PASS
116	5580	full	15.95	-0.540	15.41	34.792	30	or 17+10log(B)= 29.76	PASS
140	5700	full	15.73	-0.540	15.19	33.047	30	or 17+10log(B)= 29.76	PASS
		26/8	14.98	-0.540	14.44	27.793	30	or 17+10log(B)= 29.76	PASS
		52/40	15.99	-0.540	15.45	35.072	30	or 17+10log(B)= 29.76	PASS
		106/54	15.99	-0.540	15.45	35.094	30	or 17+10log(B)= 29.76	PASS

802.11ax_40_Ch0

CH	Frequency (MHz)	RU config.	TOTAL POWER (dBm)	Antenna Gain (dBi)	EIRP (dBm)	EIRP (mW)	REQUIRED LIMIT (dBm)		RESULT
38	5190	full	12.98	-5.000	7.98	6.281	23.01	or 10+10log(B)= 25.75	PASS
		242/61	12.81	-5.000	7.81	6.039	23.01	or 10+10log(B)= 25.75	PASS
46	5230	full	12.96	-5.000	7.96	6.252	23.01	or 10+10log(B)= 25.75	PASS
54	5270	full	12.92	-5.000	7.92	6.194	30	or 17+10log(B)= 32.75	PASS
62	5310	full	12.81	-5.000	7.81	6.039	30	or 17+10log(B)= 32.76	PASS
		242/62	12.91	-5.000	7.91	6.180	30	or 17+10log(B)= 32.76	PASS
102	5510	full	12.97	-5.000	7.97	6.266	30	or 17+10log(B)= 32.76	PASS
		242/61	12.67	-5.000	7.67	5.848	30	or 17+10log(B)= 32.76	PASS
110	5550	full	12.99	-5.000	7.99	6.295	30	or 17+10log(B)= 32.75	PASS
134	5670	full	12.97	-5.000	7.97	6.266	30	or 17+10log(B)= 32.75	PASS
		242/62	12.84	-5.000	7.84	6.081	30	or 17+10log(B)= 32.75	PASS

802.11ax_40_Ch1

CH	Frequency (MHz)	RU config.	TOTAL POWER (dBm)	Antenna Gain (dBi)	EIRP (dBm)	EIRP (mW)	REQUIRED LIMIT (dBm)		RESULT
38	5190	full	12.96	-2.300	10.66	11.641	23.01	or 10+10log(B)= 25.75	PASS
		242/61	12.81	-2.300	10.51	11.246	23.01	or 10+10log(B)= 25.75	PASS
46	5230	full	12.72	-2.300	10.42	11.015	23.01	or 10+10log(B)= 25.75	PASS
54	5270	full	12.73	-2.300	10.43	11.041	30	or 17+10log(B)= 32.75	PASS
62	5310	full	12.77	-2.300	10.47	11.143	30	or 17+10log(B)= 32.76	PASS
		242/62	12.98	-2.300	10.68	11.695	30	or 17+10log(B)= 32.76	PASS
102	5510	full	12.56	-2.300	10.26	10.617	30	or 17+10log(B)= 32.76	PASS
		242/61	12.88	-2.300	10.58	11.429	30	or 17+10log(B)= 32.76	PASS
110	5550	full	12.86	-2.300	10.56	11.376	30	or 17+10log(B)= 32.77	PASS
134	5670	full	12.89	-2.300	10.59	11.455	30	or 17+10log(B)= 32.76	PASS
		242/62	12.97	-2.300	10.67	11.668	30	or 17+10log(B)= 32.76	PASS

Unless otherwise stated the results shown in this test report refer only to the sample(s) tested and such sample(s) are retained for 90 days only.

除非另有說明，此報告結果僅對測試之樣品負責，同時此樣品僅保留90天。本報告未經本公司書面許可，不可部份複製。

This document is issued by the Company subject to its General Conditions of Service printed overleaf, available on request or accessible at <http://www.sgs.com.tw/Terms-and-Conditions> and for electronic format documents, subject to Terms and Conditions for Electronic Documents at <http://www.sgs.com.tw/Terms-and-Conditions>. Attention is drawn to the limitation of liability, indemnification and jurisdiction issues defined therein. Any holder of this document is advised that information contained hereon reflects the Company's findings at the time of its intervention only and within the limits of Client's instructions, if any. The Company's sole responsibility is to its Client and this document does not exonerate parties to a transaction from exercising all their rights and obligations under the transaction documents. This document cannot be reproduced except in full, without prior written approval of the Company. Any unauthorized alteration, forgery or falsification of the content or appearance of this document is unlawful and offenders may be prosecuted to the fullest extent of the law.

802.11ax_40_MIMO

CH	Frequency (MHz)	RU config.	TOTAL POWER (dBm)	Antenna Gain (dBi)	EIRP (dBm)	EIRP (mW)	REQUIRED LIMIT (dBm)		RESULT
38	5190	full	15.99	-0.540	15.45	35.115	23.01	or 10+10log(B)= 25.75	PASS
		242/61	15.99	-0.540	15.45	35.076	23.01	or 10+10log(B)= 25.75	PASS
46	5230	full	15.97	-0.540	15.43	34.922	23.01	or 10+10log(B)= 25.75	PASS
54	5270	full	15.95	-0.540	15.41	34.793	30	or 17+10log(B)= 32.75	PASS
62	5310	full	15.91	-0.540	15.37	34.443	30	or 17+10log(B)= 32.76	PASS
		242/62	15.92	-0.540	15.38	34.540	30	or 17+10log(B)= 32.76	PASS
102	5510	full	15.64	-0.540	15.10	32.360	30	or 17+10log(B)= 32.76	PASS
		242/61	15.70	-0.540	15.16	32.775	30	or 17+10log(B)= 32.76	PASS
110	5550	full	15.81	-0.540	15.27	33.632	30	or 17+10log(B)= 32.75	PASS
134	5670	full	15.74	-0.540	15.20	33.106	30	or 17+10log(B)= 32.75	PASS
		242/62	15.72	-0.540	15.18	32.946	30	or 17+10log(B)= 32.75	PASS

802.11ax_80_Ch0

CH	Frequency (MHz)	RU config.	TOTAL POWER (dBm)	Antenna Gain (dBi)	EIRP (dBm)	EIRP (mW)	REQUIRED LIMIT (dBm)		RESULT
42	5210	full	12.76	-5.000	7.76	5.970	23.01	or 10+10log(B)= 28.87	PASS
		484/65	12.88	-5.000	7.88	6.138	23.01	or 10+10log(B)= 28.87	PASS
58	5290	full	12.75	-5.000	7.75	5.957	30	or 17+10log(B)= 35.87	PASS
		484/66	12.82	-5.000	7.82	6.053	30	or 17+10log(B)= 35.87	PASS
106	5530	full	12.99	-5.000	7.99	6.295	30	or 17+10log(B)= 35.87	PASS
		484/65	12.97	-5.000	7.97	6.266	30	or 17+10log(B)= 35.87	PASS

802.11ax_80_Ch1

CH	Frequency (MHz)	RU config.	TOTAL POWER (dBm)	Antenna Gain (dBi)	EIRP (dBm)	EIRP (mW)	REQUIRED LIMIT (dBm)		RESULT
42	5210	full	12.72	-2.300	10.42	11.015	23.01	or 10+10log(B)= 28.86	PASS
		484/65	12.88	-2.300	10.58	11.429	23.01	or 10+10log(B)= 28.86	PASS
58	5290	full	12.70	-2.300	10.40	10.965	30	or 17+10log(B)= 35.87	PASS
		484/66	12.84	-2.300	10.54	11.324	30	or 17+10log(B)= 35.87	PASS
106	5530	full	12.96	-2.300	10.66	11.641	30	or 17+10log(B)= 35.88	PASS
		484/65	12.95	-2.300	10.65	11.614	30	or 17+10log(B)= 35.88	PASS

802.11ax_80_MIMO

CH	Frequency (MHz)	RU config.	TOTAL POWER (dBm)	Antenna Gain (dBi)	EIRP (dBm)	EIRP (mW)	REQUIRED LIMIT (dBm)		RESULT
42	5210	full	15.99	-0.540	15.45	35.086	23.01	or 10+10log(B)= 28.86	PASS
		484/65	15.88	-0.540	15.34	34.166	23.01	or 10+10log(B)= 28.86	PASS
58	5290	full	15.96	-0.540	15.42	34.867	30	or 17+10log(B)= 35.87	PASS
		484/66	15.89	-0.540	15.35	34.275	30	or 17+10log(B)= 35.87	PASS
106	5530	full	15.78	-0.540	15.24	33.396	30	or 17+10log(B)= 35.87	PASS
		484/65	15.70	-0.540	15.16	32.780	30	or 17+10log(B)= 35.87	PASS

Unless otherwise stated the results shown in this test report refer only to the sample(s) tested and such sample(s) are retained for 90 days only.

除非另有說明，此報告結果僅對測試之樣品負責，同時此樣品僅保留90天。本報告未經本公司書面許可，不可部份複製。

This document is issued by the Company subject to its General Conditions of Service printed overleaf, available on request or accessible at <http://www.sgs.com.tw/Terms-and-Conditions> and for electronic format documents, subject to Terms and Conditions for Electronic Documents at <http://www.sgs.com.tw/Terms-and-Conditions>. Attention is drawn to the limitation of liability, indemnification and jurisdiction issues defined therein. Any holder of this document is advised that information contained hereon reflects the Company's findings at the time of its intervention only and within the limits of Client's instructions, if any. The Company's sole responsibility is to its Client and this document does not exonerate parties to a transaction from exercising all their rights and obligations under the transaction documents. This document cannot be reproduced except in full, without prior written approval of the Company. Any unauthorized alteration, forgery or falsification of the content or appearance of this document is unlawful and offenders may be prosecuted to the fullest extent of the law.

9.5.3 Conducted output power (ISED)

802.11a_Ch0

CH	Frequency (MHz)	TOTAL POWER (dBm)	TOTAL POWER (mW)	REQUIRED LIMIT (dBm)	RESULT
52	5260	12.93	19.650	23.98 or 11+10log(B) = 23.13	PASS
60	5300	12.96	19.786	23.98 or 11+10log(B) = 23.13	PASS
64	5320	12.93	19.650	23.98 or 11+10log(B) = 23.13	PASS
100	5500	12.98	19.878	23.98 or 11+10log(B) = 23.13	PASS
116	5580	12.95	19.741	23.98 or 11+10log(B) = 23.13	PASS
140	5700	12.93	19.650	23.98 or 11+10log(B) = 23.13	PASS
144	5720(U-NII 2C)	11.83	15.235	23.98 or 11+10log(B) = 23.13	PASS
144	5720 (U-NII 3)	6.54	4.506	30	PASS
149	5745	12.96	19.786	30	PASS
157	5785	12.95	19.741	30	PASS
165	5825	12.99	19.923	30	PASS

802.11n_HT20_Ch0

CH	Frequency (MHz)	TOTAL POWER (dBm)	TOTAL POWER (mW)	REQUIRED LIMIT (dBm)	RESULT
52	5260	12.81	19.099	23.98 or 11+10log(B) = 23.44	PASS
60	5300	12.98	19.861	23.98 or 11+10log(B) = 23.44	PASS
64	5320	12.99	19.907	23.98 or 11+10log(B) = 23.44	PASS
100	5500	12.89	19.454	23.98 or 11+10log(B) = 23.44	PASS
116	5580	12.87	19.364	23.98 or 11+10log(B) = 23.44	PASS
140	5700	12.94	19.679	23.98 or 11+10log(B) = 23.44	PASS
144	5720(U-NII 2C)	11.61	14.484	23.98 or 11+10log(B) = 23.44	PASS
144	5720 (U-NII 3)	6.76	4.747	30	PASS
149	5745	12.92	19.588	30	PASS
157	5785	12.98	19.861	30	PASS
165	5825	12.99	19.907	30	PASS

802.11n_HT20_Ch1

CH	Frequency (MHz)	TOTAL POWER (dBm)	TOTAL POWER (mW)	REQUIRED LIMIT (dBm)	RESULT
52	5260	12.54	17.947	23.98 or 11+10log(B) = 23.44	PASS
60	5300	12.81	19.099	23.98 or 11+10log(B) = 23.44	PASS
64	5320	12.79	19.011	23.98 or 11+10log(B) = 23.44	PASS
100	5500	12.44	17.539	23.98 or 11+10log(B) = 23.44	PASS
116	5580	12.72	18.707	23.98 or 11+10log(B) = 23.43	PASS
140	5700	12.63	18.323	23.98 or 11+10log(B) = 23.44	PASS
144	5720(U-NII 2C)	11.51	14.170	23.98 or 11+10log(B) = 23.44	PASS
144	5720 (U-NII 3)	6.61	4.580	30	PASS
149	5745	12.58	18.113	30	PASS
157	5785	12.64	18.365	30	PASS
165	5825	12.67	18.493	30	PASS

Unless otherwise stated the results shown in this test report refer only to the sample(s) tested and such sample(s) are retained for 90 days only.

除非另有說明，此報告結果僅對測試之樣品負責，同時此樣品僅保留90天。本報告未經本公司書面許可，不可部份複製。

This document is issued by the Company subject to its General Conditions of Service printed overleaf, available on request or accessible at <http://www.sgs.com.tw/Terms-and-Conditions> and for electronic format documents, subject to Terms and Conditions for Electronic Documents at <http://www.sgs.com.tw/Terms-and-Conditions>. Attention is drawn to the limitation of liability, indemnification and jurisdiction issues defined therein. Any holder of this document is advised that information contained hereon reflects the Company's findings at the time of its intervention only and within the limits of Client's instructions, if any. The Company's sole responsibility is to its Client and this document does not exonerate parties to a transaction from exercising all their rights and obligations under the transaction documents. This document cannot be reproduced except in full, without prior written approval of the Company. Any unauthorized alteration, forgery or falsification of the content or appearance of this document is unlawful and offenders may be prosecuted to the fullest extent of the law.

802.11n_HT20_MIMO

CH	Frequency (MHz)	AVERAGE POWER (dBm)				TOTAL POWER (dBm)	TOTAL POWER (mW)	REQUIRED LIMIT (dBm)	RESULT
		CH 0	CH 1	CH 2	CH 3				
52	5260	11.61	13.35	0	0	15.58	36.115	23.98 or 11+10log(B) = 23.44	PASS
60	5300	11.71	13.27	0	0	15.57	36.058	23.98 or 11+10log(B) = 23.44	PASS
64	5320	11.61	13.41	0	0	15.61	36.416	23.98 or 11+10log(B) = 23.44	PASS
100	5500	11.74	13.22	0	0	15.55	35.917	23.98 or 11+10log(B) = 23.44	PASS
116	5580	11.91	13.72	0	0	15.92	39.074	23.98 or 11+10log(B) = 23.43	PASS
140	5700	11.8	13.14	0	0	15.53	35.742	23.98 or 11+10log(B) = 23.44	PASS
144	5720(U-NII 2C)	10.7389	12.00381			14.43	27.718	23.98 or 11+10log(B) = 23.44	PASS
144	5720 (U-NII 3)	5.894075	7.098266			9.55	9.012	30	PASS
149	5745	11.98	13.4	0	0	15.76	37.654	30	PASS
157	5785	11.93	13.37	0	0	15.72	37.323	30	PASS
165	5825	12.05	13.23	0	0	15.69	37.070	30	PASS

802.11n_HT40_Ch0

CH	Frequency (MHz)	TOTAL POWER (dBm)	TOTAL POWER (mW)	REQUIRED LIMIT (dBm)	RESULT
54	5270	12.72	18.707	23.98 or 11+10log(B) = 26.56	PASS
62	5310	12.90	19.498	23.98 or 11+10log(B) = 26.56	PASS
102	5510	12.99	19.907	23.98 or 11+10log(B) = 26.56	PASS
110	5550	12.97	19.815	23.98 or 11+10log(B) = 26.56	PASS
134	5670	12.94	19.679	23.98 or 11+10log(B) = 26.56	PASS
142	5710(U-NII 2C)	12.41	17.429	23.98 or 11+10log(B) = 26.56	PASS
142	5710 (U-NII 3)	3.69	2.341	30	PASS
151	5755	12.98	19.861	30	PASS
159	5795	12.97	19.815	30	PASS

802.11n_HT40_Ch1

CH	Frequency (MHz)	TOTAL POWER (dBm)	TOTAL POWER (mW)	REQUIRED LIMIT (dBm)	RESULT
54	5270	12.68	18.535	23.98 or 11+10log(B) = 26.56	PASS
62	5310	12.54	17.947	23.98 or 11+10log(B) = 26.56	PASS
102	5510	12.57	18.072	23.98 or 11+10log(B) = 26.56	PASS
110	5550	12.56	18.030	23.98 or 11+10log(B) = 26.56	PASS
134	5670	12.59	18.155	23.98 or 11+10log(B) = 26.56	PASS
142	5710(U-NII 2C)	12.36	17.235	23.98 or 11+10log(B) = 26.56	PASS
142	5710 (U-NII 3)	3.37	2.174	30	PASS
151	5755	12.81	19.099	30	PASS
159	5795	12.84	19.231	30	PASS

802.11n_HT40_MIMO

CH	Frequency (MHz)	AVERAGE POWER (dBm)				TOTAL POWER (dBm)	TOTAL POWER (mW)	REQUIRED LIMIT (dBm)	RESULT
		CH 0	CH 1	CH 2	CH 3				
54	5270	11.65	13.42	0	0	15.63	36.600	23.98 or 11+10log(B) = 26.56	PASS
62	5310	11.46	13.57	0	0	15.65	36.747	23.98 or 11+10log(B) = 26.56	PASS
102	5510	12.01	13.25	0	0	15.68	37.020	23.98 or 11+10log(B) = 26.56	PASS
110	5550	12.07	13.6	0	0	15.91	39.015	23.98 or 11+10log(B) = 26.56	PASS
134	5670	12.02	13.39	0	0	15.77	37.749	23.98 or 11+10log(B) = 26.56	PASS
142	5710(U-NII 2C)	11.48263	12.52412			15.04	31.951	23.98 or 11+10log(B) = 26.56	PASS
142	5710 (U-NII 3)	2.764166	3.53226			6.18	4.145	30	PASS
151	5755	12.28	13.52	0	0	15.95	39.395	30	PASS
159	5795	12.22	13.45	0	0	15.89	38.803	30	PASS

Unless otherwise stated the results shown in this test report refer only to the sample(s) tested and such sample(s) are retained for 90 days only.

除非另有說明，此報告結果僅對測試之樣品負責，同時此樣品僅保留90天。本報告未經本公司書面許可，不可部份複製。

This document is issued by the Company subject to its General Conditions of Service printed overleaf, available on request or accessible at <http://www.sgs.com.tw/Terms-and-Conditions> and for electronic format documents, subject to Terms and Conditions for Electronic Documents at <http://www.sgs.com.tw/Terms-and-Conditions>. Attention is drawn to the limitation of liability, indemnification and jurisdiction issues defined therein. Any holder of this document is advised that information contained hereon reflects the Company's findings at the time of its intervention only and within the limits of Client's instructions, if any. The Company's sole responsibility is to its Client and this document does not exonerate parties to a transaction from exercising all their rights and obligations under the transaction documents. This document cannot be reproduced except in full, without prior written approval of the Company. Any unauthorized alteration, forgery or falsification of the content or appearance of this document is unlawful and offenders may be prosecuted to the fullest extent of the law.

802.11ac_VHT80_Ch0

CH	Frequency (MHz)	TOTAL POWER (dBm)	TOTAL POWER (mW)	REQUIRED LIMIT (dBm)	RESULT
58	5290	12.72	18.707	23.98 or 11+10log(B) = 29.78	PASS
106	5530	12.95	19.724	23.98 or 11+10log(B) = 29.77	PASS
122	5610	12.98	19.861	23.98 or 11+10log(B) = 29.77	PASS
138	5690(U-NII 2C)	12.67	18.473	23.98 or 11+10log(B) = 29.77	PASS
138	5690 (U-NII 3)	1.28	1.342	30	PASS
155	5775	12.98	19.861	30	PASS

802.11ac_VHT80_Ch1

CH	Frequency (MHz)	TOTAL POWER (dBm)	TOTAL POWER (mW)	REQUIRED LIMIT (dBm)	RESULT
58	5290	12.68	18.535	23.98 or 11+10log(B) = 29.77	PASS
106	5530	12.91	19.543	23.98 or 11+10log(B) = 29.77	PASS
122	5610	12.62	18.281	23.98 or 11+10log(B) = 29.77	PASS
138	5690(U-NII 2C)	12.27	16.872	23.98 or 11+10log(B) = 29.77	PASS
138	5690 (U-NII 3)	0.79	1.200	30	PASS
155	5775	12.75	18.836	30	PASS

802.11ac_VHT80_MIMO

CH	Frequency (MHz)	AVERAGE POWER (dBm)				TOTAL POWER (dBm)	TOTAL POWER (mW)	REQUIRED LIMIT (dBm)	RESULT
		CH 0	CH 1	CH 2	CH 3				
58	5290	11.66	13.25	0	0	15.54	35.790	23.98 or 11+10log(B) = 29.77	PASS
106	5530	11.78	13.53	0	0	15.75	37.608	23.98 or 11+10log(B) = 29.77	PASS
122	5610	12.05	13.73	0	0	15.98	39.637	23.98 or 11+10log(B) = 29.77	PASS
138	5690(U-NII 2C)	11.74537	13.1716			15.53	35.703	23.98 or 11+10log(B) = 29.77	PASS
138	5690 (U-NII 3)	0.358525	1.691836			4.09	2.562	30	PASS
155	5775	12.15	13.64	0	0	15.97	39.527	30	PASS

Unless otherwise stated the results shown in this test report refer only to the sample(s) tested and such sample(s) are retained for 90 days only.

除非另有說明，此報告結果僅對測試之樣品負責，同時此樣品僅保留90天。本報告未經本公司書面許可，不可部份複製。

This document is issued by the Company subject to its General Conditions of Service printed overleaf, available on request or accessible at <http://www.sgs.com.tw/Terms-and-Conditions> and for electronic format documents, subject to Terms and Conditions for Electronic Documents at <http://www.sgs.com.tw/Terms-and-Conditions>. Attention is drawn to the limitation of liability, indemnification and jurisdiction issues defined therein. Any holder of this document is advised that information contained hereon reflects the Company's findings at the time of its intervention only and within the limits of Client's instructions, if any. The Company's sole responsibility is to its Client and this document does not exonerate parties to a transaction from exercising all their rights and obligations under the transaction documents. This document cannot be reproduced except in full, without prior written approval of the Company. Any unauthorized alteration, forgery or falsification of the content or appearance of this document is unlawful and offenders may be prosecuted to the fullest extent of the law.

802.11ax_20_Ch0

CH	Frequency (MHz)	RU config.	TOTAL POWER (dBm)	TOTAL POWER (mW)	REQUIRED LIMIT (dBm)	RESULT
52	5260	full	12.83	19.187	23.98 or 11+10log(B) = 23.75	PASS
60	5300	full	12.82	19.143	23.98 or 11+10log(B) = 23.77	PASS
64	5320	full	12.85	19.275	23.98 or 11+10log(B) = 23.76	PASS
		26/8	11.74	14.928	23.98 or 11+10log(B) = 23.76	PASS
		52/40	12.88	19.409	23.98 or 11+10log(B) = 23.76	PASS
		106/54	12.95	19.724	23.98 or 11+10log(B) = 23.76	PASS
100	5500	full	12.97	19.815	23.98 or 11+10log(B) = 23.76	PASS
		26/0	11.94	15.631	23.98 or 11+10log(B) = 23.76	PASS
		52/37	12.86	19.320	23.98 or 11+10log(B) = 23.76	PASS
		106/53	12.97	19.815	23.98 or 11+10log(B) = 23.76	PASS
116	5580	full	12.93	19.634	23.98 or 11+10log(B) = 23.76	PASS
140	5700	full	12.92	19.588	23.98 or 11+10log(B) = 23.76	PASS
		26/8	11.94	15.631	23.98 or 11+10log(B) = 23.76	PASS
		52/40	12.94	19.679	23.98 or 11+10log(B) = 23.76	PASS
		106/54	12.76	18.880	23.98 or 11+10log(B) = 23.76	PASS
144	5720(U-NII 2C)	full	11.70	14.791	23.98 or 11+10log(B) = 23.76	PASS
144	5720 (U-NII 3)	full	7.01	5.025	30	PASS
149	5745	full	12.99	19.907	30	PASS
		26/0	11.81	15.171	30	PASS
		52/37	12.72	18.707	30	PASS
		106/53	12.81	19.099	30	PASS
157	5785	full	12.98	19.861	30	PASS
165	5825	full	12.81	19.099	30	PASS
		26/8	11.81	15.171	30	PASS
		52/40	12.81	19.099	30	PASS
		106/54	12.93	19.634	30	PASS

Unless otherwise stated the results shown in this test report refer only to the sample(s) tested and such sample(s) are retained for 90 days only.

除非另有說明，此報告結果僅對測試之樣品負責，同時此樣品僅保留90天。本報告未經本公司書面許可，不可部份複製。

This document is issued by the Company subject to its General Conditions of Service printed overleaf, available on request or accessible at <http://www.sgs.com.tw/Terms-and-Conditions> and for electronic format documents, subject to Terms and Conditions for Electronic Documents at <http://www.sgs.com.tw/Terms-and-Conditions>. Attention is drawn to the limitation of liability, indemnification and jurisdiction issues defined therein. Any holder of this document is advised that information contained hereon reflects the Company's findings at the time of its intervention only and within the limits of Client's instructions, if any. The Company's sole responsibility is to its Client and this document does not exonerate parties to a transaction from exercising all their rights and obligations under the transaction documents. This document cannot be reproduced except in full, without prior written approval of the Company. Any unauthorized alteration, forgery or falsification of the content or appearance of this document is unlawful and offenders may be prosecuted to the fullest extent of the law.

802.11ax_20_Ch1

CH	Frequency (MHz)	RU config.	TOTAL POWER (dBm)	TOTAL POWER (mW)	REQUIRED LIMIT (dBm)	RESULT
52	5260	full	12.65	18.408	23.98 or 11+10log(B) = 23.76	PASS
60	5300	full	12.51	17.824	23.98 or 11+10log(B) = 23.76	PASS
64	5320	full	12.67	18.493	23.98 or 11+10log(B) = 23.75	PASS
		26/8	11.95	15.668	23.98 or 11+10log(B) = 23.75	PASS
		52/40	12.75	18.836	23.98 or 11+10log(B) = 23.75	PASS
		106/54	12.82	19.143	23.98 or 11+10log(B) = 23.75	PASS
100	5500	full	12.60	18.197	23.98 or 11+10log(B) = 23.76	PASS
		26/0	11.84	15.276	23.98 or 11+10log(B) = 23.76	PASS
		52/37	12.89	19.454	23.98 or 11+10log(B) = 23.76	PASS
		106/53	12.94	19.679	23.98 or 11+10log(B) = 23.76	PASS
116	5580	full	12.77	18.923	23.98 or 11+10log(B) = 23.76	PASS
140	5700	full	12.77	18.923	23.98 or 11+10log(B) = 23.76	PASS
		26/8	11.85	15.311	23.98 or 11+10log(B) = 23.76	PASS
		52/40	12.91	19.543	23.98 or 11+10log(B) = 23.76	PASS
		106/54	12.93	19.634	23.98 or 11+10log(B) = 23.76	PASS
144	5720(U-NII 2C)	full	11.64	14.593	23.98 or 11+10log(B) = 23.76	PASS
144	5720 (U-NII 3)	full	6.99	4.995	30	PASS
149	5745	full	12.78	18.967	30	PASS
		26/0	11.97	15.740	30	PASS
		52/37	12.99	19.907	30	PASS
		106/53	12.65	18.408	30	PASS
157	5785	full	12.77	18.923	30	PASS
165	5825	full	12.77	18.923	30	PASS
		26/8	11.79	15.101	30	PASS
		52/40	12.81	19.099	30	PASS
		106/54	12.91	19.543	30	PASS

Unless otherwise stated the results shown in this test report refer only to the sample(s) tested and such sample(s) are retained for 90 days only.

除非另有說明，此報告結果僅對測試之樣品負責，同時此樣品僅保留90天。本報告未經本公司書面許可，不可部份複製。

This document is issued by the Company subject to its General Conditions of Service printed overleaf, available on request or accessible at <http://www.sgs.com.tw/Terms-and-Conditions> and for electronic format documents, subject to Terms and Conditions for Electronic Documents at <http://www.sgs.com.tw/Terms-and-Conditions>. Attention is drawn to the limitation of liability, indemnification and jurisdiction issues defined therein. Any holder of this document is advised that information contained hereon reflects the Company's findings at the time of its intervention only and within the limits of Client's instructions, if any. The Company's sole responsibility is to its Client and this document does not exonerate parties to a transaction from exercising all their rights and obligations under the transaction documents. This document cannot be reproduced except in full, without prior written approval of the Company. Any unauthorized alteration, forgery or falsification of the content or appearance of this document is unlawful and offenders may be prosecuted to the fullest extent of the law.

802.11ax_20_MIMO

CH	Frequency (MHz)	RU config.	AVERAGE POWER (dBm)		TOTAL POWER (dBm)	TOTAL POWER (mW)	REQUIRED LIMIT (dBm)	RESULT
			CH 0	CH 1				
52	5260	full	11.95	13.68	15.91	39.002	23.98 or 11+10log(B) = 23.75	PASS
60	5300	full	11.8	13.41	15.69	37.064	23.98 or 11+10log(B) = 23.76	PASS
64	5320	full	11.78	13.51	15.74	37.505	23.98 or 11+10log(B) = 23.75	PASS
		26/8	11.4	12.49	14.99	31.546	23.98 or 11+10log(B) = 23.75	PASS
		52/40	12.46	13.42	15.98	39.598	23.98 or 11+10log(B) = 23.75	PASS
		106/54	12.23	13.21	15.76	37.652	23.98 or 11+10log(B) = 23.75	PASS
100	5500	full	11.84	13.35	15.67	36.903	23.98 or 11+10log(B) = 23.76	PASS
		26/0	11.63	12.29	14.98	31.498	23.98 or 11+10log(B) = 23.76	PASS
		52/37	12.59	13.28	15.96	39.437	23.98 or 11+10log(B) = 23.76	PASS
		106/53	12.64	13.29	15.99	39.696	23.98 or 11+10log(B) = 23.76	PASS
116	5580	full	11.97	13.74	15.95	39.399	23.98 or 11+10log(B) = 23.76	PASS
140	5700	full	11.93	13.39	15.73	37.423	23.98 or 11+10log(B) = 23.76	PASS
		26/8	11.68	12.24	14.98	31.473	23.98 or 11+10log(B) = 23.76	PASS
		52/40	12.55	13.37	15.99	39.716	23.98 or 11+10log(B) = 23.76	PASS
		106/54	12.58	13.35	15.99	39.741	23.98 or 11+10log(B) = 23.76	PASS
144	5720(U-NII 2C)	full	10.58987	12.08143	14.41	27.604	23.98 or 11+10log(B) = 23.76	PASS
144	5720 (U-NII 3)	full	5.901033	7.425777	9.74	9.420	30	PASS
149	5745	full	12.07	13.54	15.88	38.701	30	PASS
		26/0	11.21	12.06	14.67	29.282	30	PASS
		52/37	12.25	13.12	15.72	37.300	30	PASS
		106/53	12.39	13.09	15.76	37.708	30	PASS
157	5785	full	12.05	13.42	15.80	38.011	30	PASS
165	5825	full	12.15	13.41	15.84	38.334	30	PASS
		26/8	11.41	12.49	14.99	31.578	30	PASS
		52/40	12.58	13.33	15.98	39.641	30	PASS
		106/54	12.26	13.12	15.72	37.338	30	PASS

802.11ax_40_Ch0

CH	Frequency (MHz)	RU config.	TOTAL POWER (dBm)	TOTAL POWER (mW)	REQUIRED LIMIT (dBm)	RESULT
54	5270	full	12.92	19.588	23.98 or 11+10log(B) = 26.75	PASS
62	5310	full	12.81	19.099	23.98 or 11+10log(B) = 26.76	PASS
		242/62	12.91	19.543	23.98 or 11+10log(B) = 26.76	PASS
102	5510	full	12.97	19.815	23.98 or 11+10log(B) = 26.76	PASS
		242/61	12.67	18.493	23.98 or 11+10log(B) = 26.76	PASS
110	5550	full	12.99	19.907	23.98 or 11+10log(B) = 26.75	PASS
134	5670	full	12.97	19.815	23.98 or 11+10log(B) = 26.75	PASS
		242/62	12.84	19.231	23.98 or 11+10log(B) = 26.75	PASS
142	5710(U-NII 2C)	full	12.40	17.381	23.98 or 11+10log(B) = 26.76	PASS
142	5710 (U-NII 3)	full	4.02	2.525	30	PASS
151	5755	full	12.96	19.770	30	PASS
		242/61	12.94	19.679	30	PASS
159	5795	full	12.98	19.861	30	PASS
		242/62	12.90	19.498	30	PASS

Unless otherwise stated the results shown in this test report refer only to the sample(s) tested and such sample(s) are retained for 90 days only.

除非另有說明，此報告結果僅對測試之樣品負責，同時此樣品僅保留90天。本報告未經本公司書面許可，不可部份複製。

This document is issued by the Company subject to its General Conditions of Service printed overleaf, available on request or accessible at <http://www.sgs.com.tw/Terms-and-Conditions> and for electronic format documents, subject to Terms and Conditions for Electronic Documents at <http://www.sgs.com.tw/Terms-and-Conditions>. Attention is drawn to the limitation of liability, indemnification and jurisdiction issues defined therein. Any holder of this document is advised that information contained hereon reflects the Company's findings at the time of its intervention only and within the limits of Client's instructions, if any. The Company's sole responsibility is to its Client and this document does not exonerate parties to a transaction from exercising all their rights and obligations under the transaction documents. This document cannot be reproduced except in full, without prior written approval of the Company. Any unauthorized alteration, forgery or falsification of the content or appearance of this document is unlawful and offenders may be prosecuted to the fullest extent of the law.

802.11ax_40_Ch1

CH	Frequency (MHz)	RU config.	TOTAL POWER (dBm)	TOTAL POWER (mW)	REQUIRED LIMIT (dBm)	RESULT
54	5270	full	12.73	18.750	23.98 or 11+10log(B) = 26.75	PASS
62	5310	full	12.77	18.923	23.98 or 11+10log(B) = 26.76	PASS
		242/62	12.98	19.861	23.98 or 11+10log(B) = 26.76	PASS
102	5510	full	12.56	18.030	23.98 or 11+10log(B) = 26.76	PASS
		242/61	12.88	19.409	23.98 or 11+10log(B) = 26.76	PASS
110	5550	full	12.86	19.320	23.98 or 11+10log(B) = 26.77	PASS
134	5670	full	12.89	19.454	23.98 or 11+10log(B) = 26.76	PASS
		242/62	12.97	19.815	23.98 or 11+10log(B) = 26.76	PASS
142	5710(U-NII 2C)	full	12.27	16.874	23.98 or 11+10log(B) = 26.76	PASS
142	5710 (U-NII 3)	full	3.72	2.357	30	PASS
151	5755	full	12.82	19.143	30	PASS
		242/61	12.73	18.750	30	PASS
159	5795	full	12.81	19.099	30	PASS
		242/62	12.99	19.907	30	PASS

802.11ax_40_MIMO

CH	Frequency (MHz)	RU config.	AVERAGE POWER (dBm)				TOTAL POWER (dBm)	TOTAL POWER (mW)	REQUIRED LIMIT (dBm)	RESULT
			CH 0	CH 1	CH 2	CH 3				
54	5270	full	11.94	13.76	0	0	15.95	39.400	23.98 or 11+10log(B) = 26.75	PASS
62	5310	full	11.89	13.72	0	0	15.91	39.003	23.98 or 11+10log(B) = 26.76	PASS
		242/62	12.3	13.45	0	0	15.92	39.113	23.98 or 11+10log(B) = 26.76	PASS
102	5510	full	11.96	13.21	0	0	15.64	36.645	23.98 or 11+10log(B) = 26.76	PASS
		242/61	12.47	12.89	0	0	15.70	37.114	23.98 or 11+10log(B) = 26.76	PASS
110	5550	full	12.07	13.42	0	0	15.81	38.085	23.98 or 11+10log(B) = 26.75	PASS
134	5670	full	11.99	13.36	0	0	15.74	37.490	23.98 or 11+10log(B) = 26.75	PASS
		242/62	12.44	12.96	0	0	15.72	37.309	23.98 or 11+10log(B) = 26.75	PASS
142	5710(U-NII 2C)	full	11.82081	12.91224			15.41	34.762	23.98 or 11+10log(B) = 26.76	PASS
142	5710 (U-NII 3)	full	3.443441	4.363011			6.94	4.941	30	PASS
151	5755	full	12.08	13.49	0	0	15.85	38.479	30	PASS
		242/61	12.3	13.39	0	0	15.89	38.810	30	PASS
159	5795	full	12.23	13.44	0	0	15.89	38.791	30	PASS
		242/62	12.41	13.22	0	0	15.84	38.407	30	PASS

802.11ax_80_Ch0

CH	Frequency (MHz)	RU config.	TOTAL POWER (dBm)	TOTAL POWER (mW)	REQUIRED LIMIT (dBm)	RESULT
58	5290	full	12.75	18.836	23.98 or 11+10log(B) = 29.87	PASS
		484/66	12.82	19.143	23.98 or 11+10log(B) = 29.87	PASS
106	5530	full	12.99	19.907	23.98 or 11+10log(B) = 29.87	PASS
		484/65	12.97	19.815	23.98 or 11+10log(B) = 29.87	PASS
122	5610	full	12.97	19.815	23.98 or 11+10log(B) = 29.86	PASS
138	5690(U-NII 2C)	full	12.66	18.459	23.98 or 11+10log(B) = 29.87	PASS
138	5690 (U-NII 3)	full	1.47	1.402	30	PASS
155	5775	full	12.99	19.907	30	PASS
		484/65	12.81	19.099	30	PASS
		484/66	12.93	19.634	30	PASS

Unless otherwise stated the results shown in this test report refer only to the sample(s) tested and such sample(s) are retained for 90 days only.

除非另有說明，此報告結果僅對測試之樣品負責，同時此樣品僅保留90天。本報告未經本公司書面許可，不可部份複製。

This document is issued by the Company subject to its General Conditions of Service printed overleaf, available on request or accessible at <http://www.sgs.com.tw/Terms-and-Conditions> and for electronic format documents, subject to Terms and Conditions for Electronic Documents at <http://www.sgs.com.tw/Terms-and-Conditions>. Attention is drawn to the limitation of liability, indemnification and jurisdiction issues defined therein. Any holder of this document is advised that information contained hereon reflects the Company's findings at the time of its intervention only and within the limits of Client's instructions, if any. The Company's sole responsibility is to its Client and this document does not exonerate parties to a transaction from exercising all their rights and obligations under the transaction documents. This document cannot be reproduced except in full, without prior written approval of the Company. Any unauthorized alteration, forgery or falsification of the content or appearance of this document is unlawful and offenders may be prosecuted to the fullest extent of the law.

802.11ax_80_Ch1

CH	Frequency (MHz)	RU config.	TOTAL POWER (dBm)	TOTAL POWER (mW)	REQUIRED LIMIT (dBm)		RESULT
58	5290	full	12.70	18.621	23.98	or 11+10log(B) = 29.87	PASS
		484/66	12.84	19.231	23.98	or 11+10log(B) = 29.87	PASS
106	5530	full	12.96	19.770	23.98	or 11+10log(B) = 29.88	PASS
		484/65	12.95	19.724	23.98	or 11+10log(B) = 29.88	PASS
122	5610	full	12.61	18.239	23.98	or 11+10log(B) = 29.86	PASS
138	5690(U-NII 2C)	full	12.21	16.634	23.98	or 11+10log(B) = 29.88	PASS
138	5690 (U-NII 3)	full	0.76	1.190	30		PASS
155	5775	full	12.67	18.493	30		PASS
		484/65	12.88	19.409	30		PASS
		484/66	12.81	19.099	30		PASS

802.11ax_80_MIMO

CH	Frequency (MHz)	RU config.	AVERAGE POWER (dBm)				TOTAL POWER (dBm)	TOTAL POWER (mW)	REQUIRED LIMIT (dBm)		RESULT
			CH 0	CH 1	CH 2	CH 3					
58	5290	full	12.11	13.66	0	0	15.96	39.483	23.98	or 11+10log(B) = 29.87	PASS
		484/66	12.51	13.22	0	0	15.89	38.813	23.98	or 11+10log(B) = 29.87	PASS
106	5530	full	11.84	13.53	0	0	15.78	37.818	23.98	or 11+10log(B) = 29.87	PASS
		484/65	12.3	13.04	0	0	15.70	37.120	23.98	or 11+10log(B) = 29.87	PASS
122	5610	full	12.04	13.48	0	0	15.83	38.280	23.98	or 11+10log(B) = 29.86	PASS
138	5690(U-NII 2C)	full	11.712	13.13985			15.49	35.438	23.98	or 11+10log(B) = 29.87	PASS
138	5690 (U-NII 3)	full	0.518344	1.686338			4.15	2.601	30		PASS
155	5775	full	12.16	13.61	0	0	15.96	39.405	30		PASS
		484/65	12.27	13.54	0	0	15.96	39.460	30		PASS
		484/66	12.26	13.27	0	0	15.80	38.059	30		PASS

Unless otherwise stated the results shown in this test report refer only to the sample(s) tested and such sample(s) are retained for 90 days only.

除非另有說明，此報告結果僅對測試之樣品負責，同時此樣品僅保留90天。本報告未經本公司書面許可，不可部份複製。

This document is issued by the Company subject to its General Conditions of Service printed overleaf, available on request or accessible at <http://www.sgs.com.tw/Terms-and-Conditions> and for electronic format documents, subject to Terms and Conditions for Electronic Documents at <http://www.sgs.com.tw/Terms-and-Conditions>. Attention is drawn to the limitation of liability, indemnification and jurisdiction issues defined therein. Any holder of this document is advised that information contained hereon reflects the Company's findings at the time of its intervention only and within the limits of Client's instructions, if any. The Company's sole responsibility is to its Client and this document does not exonerate parties to a transaction from exercising all their rights and obligations under the transaction documents. This document cannot be reproduced except in full, without prior written approval of the Company. Any unauthorized alteration, forgery or falsification of the content or appearance of this document is unlawful and offenders may be prosecuted to the fullest extent of the law.

10 MAXIMUM POWER SPECTRAL DENSITY

10.1 Standard Applicable

FCC

OPERZTION Band	EUT CATEGORY		LIMIT
U-NII-1		Access Point (Master device)	17dBm/ MHz
		Fixed point-to-point Access Ponit	
	√	Mobile and portable client device	11dBm/ MHz
U-NII-2A	√		11dBm/ MHz
U-NII-2C	√		11dBm/ MHz
U-NII-3	√		30dBm/ 500kHz

If transmitting antennas of directional gain greater than 6 dBi are used, the Maximum power spectral density shall be reduced by the amount in dB that the directional gain of the antenna exceeds 6 dBi.

ISED

OPERZTION FREQUENCY BAND	LIMIT
5150~5250 MHz	EIRP spectral density 10 dBm / MHz
5250~5350 MHz	11dBm / MHz
5470-5600 MHz and 5650-5725 MHz	11dBm / MHz
5725~5850 MHz	30dBm / 500 kHz

For equipment operating in the band **5725-5850** MHz, If transmitting antennas of directional gain greater than 6 dBi are used, the Maximum power spectral density shall be reduced by the amount in dB that the directional gain of the antenna exceeds 6 dBi.

Note:

As per section F. 2). e). (ii) of FCC KDB 662911 D01

If antenna gains are not equal and each transmit antenna is driven by only one spatial stream, directional gain may be calculated by either of the following formulas.

Unless otherwise stated the results shown in this test report refer only to the sample(s) tested and such sample(s) are retained for 90 days only.

除非另有說明，此報告結果僅對測試之樣品負責，同時此樣品僅保留90天。本報告未經本公司書面許可，不可部份複製。

This document is issued by the Company subject to its General Conditions of Service printed overleaf, available on request or accessible at <http://www.sgs.com.tw/Terms-and-Conditions> and for electronic format documents, subject to Terms and Conditions for Electronic Documents at <http://www.sgs.com.tw/Terms-and-Conditions>. Attention is drawn to the limitation of liability, indemnification and jurisdiction issues defined therein. Any holder of this document is advised that information contained hereon reflects the Company's findings at the time of its intervention only and within the limits of Client's instructions, if any. The Company's sole responsibility is to its Client and this document does not exonerate parties to a transaction from exercising all their rights and obligations under the transaction documents. This document cannot be reproduced except in full, without prior written approval of the Company. Any unauthorized alteration, forgery or falsification of the content or appearance of this document is unlawful and offenders may be prosecuted to the fullest extent of the law.

$$DirectionalGain = 10 \cdot \log \left[\frac{\sum_{j=1}^{N_{SS}} \left\{ \sum_{k=1}^{N_{ANT}} g_{j,k} \right\}^2}{N_{ANT}} \right]$$

where

Each antenna is driven by no more than one spatial stream;

NSS = the number of independent spatial streams of data;

NANT = the total number of antennas

$g_{j,k} = 1/20 \cdot 10G_k$ if the kth antenna is being fed by spatial stream j, or zero if it is not;

G_k is the gain in dBi of the kth antenna.

The antenna gain is not greater than 6 dBi. Therefore, reduction of power is not required.

10.2 Measurement Procedure

1. Place the EUT on the table and set it in transmitting mode.
2. The testing follows FCC KDB 789033 D02 General UNII Test Procedures New Rules .
3. Remove the antenna from the EUT and then connect a low loss RF cable from the antenna port to Spectrum.
4. **For U-NII1, U-NII-2A, U-NII-2C Band:**
Set RBW=1MHz, VBW=3MHz, where span is enough to capture the entire bandwidth, Sweep time = Auto (601 pts), detector = sample, traces 100 sweeps of video averaging. (SA-2 with the omission of procedure x, the integration with 26dB EBW bandwidth)
For U-NII-3 Band:
Set RBW=300kHz, VBW \geq 3RBW, where span is enough to capture the entire bandwidth, Sweep time = Auto, detector = RMS or sample, traces 100 sweeps of video averaging.

Set RBW=500kHz, VBW \geq 3RBW, where span is enough to capture the entire bandwidth, Sweep time = Auto, detector = RMS or sample, traces 100 sweeps of video averaging.
5. Use the cursor on spectrum to peak search the highest level of trace
6. Record the max. reading and add 10 log(1/duty cycle).
7. Repeat above procedures until all default test channel (low, middle, and high) was complete.
8. MIMO mode: offset is set following "measure and add 10 Log (N)" on spectrum to measure the PSD for MIMO mode. Offset = cable loss + 10 log (N), where N is number of transmitting antenna.

Note: For the test of PSD at MIMO mode, the highest emission of worst case employing Measure and add 10 log (N) technical is reported on this report after the comparison between Main Antenna at single transmitting mode and Aux that yields the higher value. The MIMO transmitting mode produces higher value of outcome

Unless otherwise stated the results shown in this test report refer only to the sample(s) tested and such sample(s) are retained for 90 days only.

除非另有說明，此報告結果僅對測試之樣品負責，同時此樣品僅保留90天。本報告未經本公司書面許可，不可部份複製。

This document is issued by the Company subject to its General Conditions of Service printed overleaf, available on request or accessible at <http://www.sgs.com.tw/Terms-and-Conditions> and for electronic format documents, subject to Terms and Conditions for Electronic Documents at <http://www.sgs.com.tw/Terms-and-Conditions>. Attention is drawn to the limitation of liability, indemnification and jurisdiction issues defined therein. Any holder of this document is advised that information contained hereon reflects the Company's findings at the time of its intervention only and within the limits of Client's instructions, if any. The Company's sole responsibility is to its Client and this document does not exonerate parties to a transaction from exercising all their rights and obligations under the transaction documents. This document cannot be reproduced except in full, without prior written approval of the Company. Any unauthorized alteration, forgery or falsification of the content or appearance of this document is unlawful and offenders may be prosecuted to the fullest extent of the law.

10.3 Measurement Equipment Used

SGS Conducted Room					
Name of Equipment	Manufacturer	Model	Serial Number	Calibration Date	Calibration Due
EXA Spectrum Analyzer	Agilent	N9010A	MY50420195	05/06/2020	05/05/2021
DC Power Supply	Agilent	E3640A	MY52410006	12/17/2020	12/16/2021
DC Power Supply	Agilent	E3640A	KR93300208	08/19/2020	08/18/2021
Attenuator	Mini-Circuit	BW-S10W2+	2	12/16/2020	12/15/2021
DC Block	Mini-Circuits	BLK-18-S+	1	12/16/2020	12/15/2021

10.4 Test Set-up

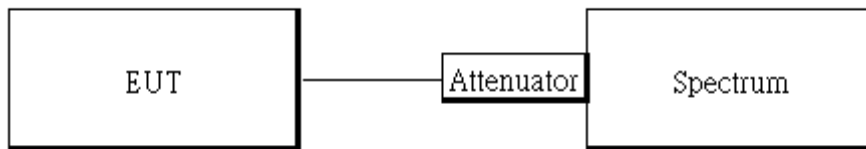

Unless otherwise stated the results shown in this test report refer only to the sample(s) tested and such sample(s) are retained for 90 days only.

除非另有說明，此報告結果僅對測試之樣品負責，同時此樣品僅保留90天。本報告未經本公司書面許可，不可部份複製。

This document is issued by the Company subject to its General Conditions of Service printed overleaf, available on request or accessible at <http://www.sgs.com.tw/Terms-and-Conditions> and for electronic format documents, subject to Terms and Conditions for Electronic Documents at <http://www.sgs.com.tw/Terms-and-Conditions>. Attention is drawn to the limitation of liability, indemnification and jurisdiction issues defined therein. Any holder of this document is advised that information contained hereon reflects the Company's findings at the time of its intervention only and within the limits of Client's instructions, if any. The Company's sole responsibility is to its Client and this document does not exonerate parties to a transaction from exercising all their rights and obligations under the transaction documents. This document cannot be reproduced except in full, without prior written approval of the Company. Any unauthorized alteration, forgery or falsification of the content or appearance of this document is unlawful and offenders may be prosecuted to the fullest extent of the law.

10.5 Measurement Result

10.5.1 Power spectral density

POWER DENSITY 802.11a MODE							
Frequency (MHz)	ch0 meas PSD (dBm/MHz)		Duty Factor (dB)	Total Corr'd PSD(dBm/MHz)	Limit	Margin (dB)	
5180.00	1.50		0.00	1.50	11.00 dBm/MHz	-9.50	
5220.00	0.87		0.00	0.87	11.00 dBm/MHz	-10.13	
5240.00	0.48		0.00	0.48	11.00 dBm/MHz	-10.52	
5260.00	0.11		0.00	0.11	11.00 dBm/MHz	-10.89	
5300.00	0.74		0.00	0.74	11.00 dBm/MHz	-10.26	
5320.00	0.43		0.00	0.43	11.00 dBm/MHz	-10.57	
5500.00	0.32		0.00	0.32	11.00 dBm/MHz	-10.68	
5580.00	-0.13		0.00	-0.13	11.00 dBm/MHz	-11.13	
5700.00	0.13		0.00	0.13	11.00 dBm/MHz	-10.87	
5720 (U-NII 2C)	1.27		0.00	1.27	11.00 dBm/MHz	-9.73	
Frequency (MHz)	ch0 meas PSD (dBm/300kHz)		Duty Factor (dB)	10log (500kHz/RBW) Factor(dB)	Total Corr'd PSD(dBm/500 kHz)	Limit	Margin (dB)
5720 (U-NII 3)	-3.98		0.00	2.22	-1.76	30.00 dBm/500kHz	-31.76
5745.00	-3.98		0.00	2.22	-1.76	30.00 dBm/500kHz	-31.76
5785.00	-3.82		0.00	2.22	-1.60	30.00 dBm/500kHz	-31.60
5825.00	-4.16		0.00	2.22	-1.94	30.00 dBm/500kHz	-31.94

Unless otherwise stated the results shown in this test report refer only to the sample(s) tested and such sample(s) are retained for 90 days only.

除非另有說明，此報告結果僅對測試之樣品負責，同時此樣品僅保留90天。本報告未經本公司書面許可，不可部份複製。

This document is issued by the Company subject to its General Conditions of Service printed overleaf, available on request or accessible at <http://www.sgs.com.tw/Terms-and-Conditions> and for electronic format documents, subject to Terms and Conditions for Electronic Documents at <http://www.sgs.com.tw/Terms-and-Conditions>. Attention is drawn to the limitation of liability, indemnification and jurisdiction issues defined therein. Any holder of this document is advised that information contained hereon reflects the Company's findings at the time of its intervention only and within the limits of Client's instructions, if any. The Company's sole responsibility is to its Client and this document does not exonerate parties to a transaction from exercising all their rights and obligations under the transaction documents. This document cannot be reproduced except in full, without prior written approval of the Company. Any unauthorized alteration, forgery or falsification of the content or appearance of this document is unlawful and offenders may be prosecuted to the fullest extent of the law.

POWER DENSITY 802.11n HT20 MODE							
Frequency (MHz)	ch0 meas PSD (dBm/MHz)	ch1 meas PSD (dBm/MHz)	Duty Factor (dB)	Total Corr'd PSD(dBm/MHz)		Limit	Margin (dB)
5180.00	-0.07	1.20	0.00	3.62		11.00 dBm/MHz	-7.38
5220.00	0.32	0.45	0.00	3.40		11.00 dBm/MHz	-7.60
5240.00	-0.43	0.46	0.00	3.05		11.00 dBm/MHz	-7.95
5260.00	-0.39	0.18	0.00	2.91		11.00 dBm/MHz	-8.09
5300.00	-0.55	-0.28	0.00	2.60		11.00 dBm/MHz	-8.40
5320.00	-1.02	-0.06	0.00	2.50		11.00 dBm/MHz	-8.50
5500.00	-0.98	-0.09	0.00	2.50		11.00 dBm/MHz	-8.50
5580.00	-0.94	0.48	0.00	2.84		11.00 dBm/MHz	-8.16
5700.00	-1.08	0.73	0.00	2.93		11.00 dBm/MHz	-8.07
5720 (U-NII 2C)	0.02	0.18	0.00	3.11		11.00 dBm/MHz	-7.89
Frequency (MHz)	ch0 meas PSD (dBm/300kHz)	ch1 meas PSD (dBm/300kHz)	Duty Factor (dB)	10log (500kHz/RBW) Factor(dB)	Total Corr'd PSD(dBm/500 kHz)	Limit	Margin (dB)
5720 (U-NII 3)	-5.94	-5.57	0.00	2.22	-0.52	30.00 dBm/500kHz	-30.52
5745.00	-5.30	-4.72	0.00	2.22	0.23	30.00 dBm/500kHz	-29.77
5785.00	-5.30	-4.82	0.00	2.22	0.18	30.00 dBm/500kHz	-29.82
5825.00	-5.23	-4.72	0.00	2.22	0.26	30.00 dBm/500kHz	-29.74
POWER DENSITY 802.11n HT40 MODE							
Frequency (MHz)	ch0 meas PSD (dBm/MHz)	ch1 meas PSD (dBm/MHz)	Duty Factor (dB)	Total Corr'd PSD(dBm/MHz)		Limit	Margin (dB)
5190.00	-2.84	-1.96	0.00	0.63		11.00 dBm/MHz	-10.37
5230.00	-3.57	-2.27	0.00	0.14		11.00 dBm/MHz	-10.86
5270.00	-3.54	-2.62	0.00	-0.05		11.00 dBm/MHz	-11.05
5310.00	-3.73	-3.07	0.00	-0.38		11.00 dBm/MHz	-11.38
5510.00	-3.65	-2.21	0.00	0.14		11.00 dBm/MHz	-10.86
5550.00	-3.00	-2.88	0.00	0.07		11.00 dBm/MHz	-10.93
5670.00	-3.58	-2.54	0.00	-0.02		11.00 dBm/MHz	-11.02
5710 (U-NII 2C)	-3.50	-3.48	0.00	-0.48		11.00 dBm/MHz	-11.48
Frequency (MHz)	ch0 meas PSD (dBm/300kHz)	ch1 meas PSD (dBm/300kHz)	Duty Factor (dB)	10log (500kHz/RBW) Factor(dB)	Total Corr'd PSD(dBm/500 kHz)	Limit	Margin (dB)
5710 (U-NII 3)	-9.88	-10.16	0.00	2.22	-4.79	30.00 dBm/500kHz	-34.79
5755.00	-8.08	-7.27	0.00	2.22	-2.43	30.00 dBm/500kHz	-32.43
5795.00	-7.96	-7.56	0.00	2.22	-2.53	30.00 dBm/500kHz	-32.53

Unless otherwise stated the results shown in this test report refer only to the sample(s) tested and such sample(s) are retained for 90 days only.

除非另有說明，此報告結果僅對測試之樣品負責，同時此樣品僅保留90天。本報告未經本公司書面許可，不可部份複製。

This document is issued by the Company subject to its General Conditions of Service printed overleaf, available on request or accessible at <http://www.sgs.com.tw/Terms-and-Conditions> and for electronic format documents, subject to Terms and Conditions for Electronic Documents at <http://www.sgs.com.tw/Terms-and-Conditions>. Attention is drawn to the limitation of liability, indemnification and jurisdiction issues defined therein. Any holder of this document is advised that information contained hereon reflects the Company's findings at the time of its intervention only and within the limits of Client's instructions, if any. The Company's sole responsibility is to its Client and this document does not exonerate parties to a transaction from exercising all their rights and obligations under the transaction documents. This document cannot be reproduced except in full, without prior written approval of the Company. Any unauthorized alteration, forgery or falsification of the content or appearance of this document is unlawful and offenders may be prosecuted to the fullest extent of the law.

POWER DENSITY 802.11ac VHT80 MODE							
Frequency (MHz)	ch0 meas PSD (dBm/MHz)	ch1 meas PSD (dBm/MHz)	Duty Factor (dB)	Total Corr'd PSD(dBm/MHz)		Limit	Margin (dB)
5210.00	-5.75	-5.35	0.00	-2.54		11.00 dBm/MHz	-13.54
5290.00	-6.46	-5.71	0.00	-3.06		11.00 dBm/MHz	-14.06
5530.00	-6.16	-5.31	0.00	-2.70		11.00 dBm/MHz	-13.70
5610.00	-6.46	-5.23	0.00	-2.79		11.00 dBm/MHz	-13.79
5690 (U-NII 2C)	-5.59	-5.60	0.00	-2.58		11.00 dBm/MHz	-13.58
Frequency (MHz)	ch0 meas PSD (dBm/300kHz)	ch1 meas PSD (dBm/300kHz)	Duty Factor (dB)	10log (500kHz/RBW) Factor(dB)	Total Corr'd PSD(dBm/500 kHz)	Limit	Margin (dB)
5690 (U-NII 3)	-11.93	-11.84	0.00	2.22	-6.65	30.00 dBm/500kHz	-36.65
5775.00	-10.79	-9.74	0.00	2.22	-5.00	30.00 dBm/500kHz	-35.00

Unless otherwise stated the results shown in this test report refer only to the sample(s) tested and such sample(s) are retained for 90 days only.

除非另有說明，此報告結果僅對測試之樣品負責，同時此樣品僅保留90天。本報告未經本公司書面許可，不可部份複製。

This document is issued by the Company subject to its General Conditions of Service printed overleaf, available on request or accessible at <http://www.sgs.com.tw/Terms-and-Conditions> and for electronic format documents, subject to Terms and Conditions for Electronic Documents at <http://www.sgs.com.tw/Terms-and-Conditions>. Attention is drawn to the limitation of liability, indemnification and jurisdiction issues defined therein. Any holder of this document is advised that information contained hereon reflects the Company's findings at the time of its intervention only and within the limits of Client's instructions, if any. The Company's sole responsibility is to its Client and this document does not exonerate parties to a transaction from exercising all their rights and obligations under the transaction documents. This document cannot be reproduced except in full, without prior written approval of the Company. Any unauthorized alteration, forgery or falsification of the content or appearance of this document is unlawful and offenders may be prosecuted to the fullest extent of the law.

POWER DENSITY 802.11ax 20 MODE								
Frequency (MHz)	RU config.	ch0 meas PSD (dBm/MHz)	ch1 meas PSD (dBm/MHz)	Duty Factor (dB)	Total Corr'd PSD(dBm/MHz)		Limit	Margin (dB)
5180	full	-0.44	0.62	0.00	3.13		11.00 dBm/MHz	-7.87
	26/0	6.80	8.00	0.00	10.45		11.00 dBm/MHz	-0.55
	52/37	6.09	6.57	0.00	9.35		11.00 dBm/MHz	-1.65
	106/53	3.26	3.99	0.00	6.65		11.00 dBm/MHz	-4.35
5220	full	-0.82	0.23	0.00	2.75		11.00 dBm/MHz	-8.25
5240	full	-0.93	0.61	0.00	2.92		11.00 dBm/MHz	-8.08
5260	full	-0.69	0.28	0.00	2.83		11.00 dBm/MHz	-8.17
5300	full	-1.25	0.02	0.00	2.44		11.00 dBm/MHz	-8.56
5320	full	-1.28	-0.16	0.00	2.33		11.00 dBm/MHz	-8.67
	26/8	5.50	5.01	0.00	8.27		11.00 dBm/MHz	-2.73
	52/40	5.12	6.28	0.00	8.75		11.00 dBm/MHz	-2.25
	106/54	1.96	3.11	0.00	5.58		11.00 dBm/MHz	-5.42
5500	full	-0.87	0.12	0.00	2.66		11.00 dBm/MHz	-8.34
	26/0	6.32	6.42	0.00	9.38		11.00 dBm/MHz	-1.62
	52/37	6.01	5.86	0.00	8.95		11.00 dBm/MHz	-2.05
	106/53	2.60	3.42	0.00	6.04		11.00 dBm/MHz	-4.96
5580	full	-0.59	0.06	0.00	2.76		11.00 dBm/MHz	-8.24
5700	full	-1.44	-0.34	0.00	2.16		11.00 dBm/MHz	-8.84
	26/8	5.36	5.39	0.00	8.39		11.00 dBm/MHz	-2.61
	52/40	5.55	6.52	0.00	9.07		11.00 dBm/MHz	-1.93
	106/54	2.29	2.71	0.00	5.52		11.00 dBm/MHz	-5.48
5720 (U-NII 2C)	full	-0.71	-0.06	0.00	2.64		11.00 dBm/MHz	-8.36
Frequency (MHz)	RU config.	ch0 meas PSD (dBm/300kHz)	ch1 meas PSD (dBm/300kHz)	Duty Factor (dB)	10log (500kHz/RBW) Factor(dB)	Total Corr'd PSD(dBm/500 kHz)	Limit	Margin (dB)
5720 (U-NII 3)	full	-6.72	-6.63	0.00	2.22	-1.44	30.00 dBm/500kHz	-31.44
5745	full	-6.19	-5.27	0.00	2.22	-0.48	30.00 dBm/500kHz	-30.48
	26/0	-1.26	1.71	0.00	2.22	5.70	30.00 dBm/500kHz	-24.30
	52/37	-0.32	1.23	0.00	2.22	5.75	30.00 dBm/500kHz	-24.25
	106/53	-2.73	-1.25	0.00	2.22	3.30	30.00 dBm/500kHz	-26.70
5785	full	-5.87	-5.60	0.00	2.22	-0.50	30.00 dBm/500kHz	-30.50
5825	full	-5.71	-5.40	0.00	2.22	-0.32	30.00 dBm/500kHz	-30.32
	26/8	0.45	0.67	0.00	2.22	5.79	30.00 dBm/500kHz	-24.21
	52/40	0.15	1.10	0.00	2.22	5.88	30.00 dBm/500kHz	-24.12
	106/54	-2.82	-2.07	0.00	2.22	2.80	30.00 dBm/500kHz	-27.20

Unless otherwise stated the results shown in this test report refer only to the sample(s) tested and such sample(s) are retained for 90 days only.

除非另有說明，此報告結果僅對測試之樣品負責，同時此樣品僅保留90天。本報告未經本公司書面許可，不可部份複製。

This document is issued by the Company subject to its General Conditions of Service printed overleaf, available on request or accessible at <http://www.sgs.com.tw/Terms-and-Conditions> and for electronic format documents, subject to Terms and Conditions for Electronic Documents at <http://www.sgs.com.tw/Terms-and-Conditions>. Attention is drawn to the limitation of liability, indemnification and jurisdiction issues defined therein. Any holder of this document is advised that information contained hereon reflects the Company's findings at the time of its intervention only and within the limits of Client's instructions, if any. The Company's sole responsibility is to its Client and this document does not exonerate parties to a transaction from exercising all their rights and obligations under the transaction documents. This document cannot be reproduced except in full, without prior written approval of the Company. Any unauthorized alteration, forgery or falsification of the content or appearance of this document is unlawful and offenders may be prosecuted to the fullest extent of the law.

POWER DENSITY 802.11ax 40 MODE								
Frequency (MHz)	RU config.	ch0 meas PSD (dBm/MHz)	ch1 meas PSD (dBm/MHz)	Duty Factor (dB)	Total Corr'd PSD(dBm/MHz)		Limit	Margin (dB)
5190	full	-2.87	-1.71	0.00	0.76		11.00 dBm/MHz	-10.24
	242/61	-0.29	0.73	0.00	3.26		11.00 dBm/MHz	-7.74
5230	full	-3.16	-2.23	0.00	0.34		11.00 dBm/MHz	-10.66
5270	full	-3.58	-2.58	0.00	-0.04		11.00 dBm/MHz	-11.04
5310	full	-3.63	-3.16	0.00	-0.38		11.00 dBm/MHz	-11.38
	242/62	-1.06	-0.04	0.00	2.49		11.00 dBm/MHz	-8.51
5510	full	-3.19	-3.03	0.00	-0.10		11.00 dBm/MHz	-11.10
	242/61	-1.19	-0.54	0.00	2.16		11.00 dBm/MHz	-8.84
5550	full	-4.00	-3.18	0.00	-0.56		11.00 dBm/MHz	-11.56
5670	full	-3.12	-2.64	0.00	0.14		11.00 dBm/MHz	-10.86
	242/62	-0.74	-0.57	0.00	2.36		11.00 dBm/MHz	-8.64
5710 (U-NII 2C)	full	-3.11	-3.14	0.00	-0.11		11.00 dBm/MHz	-11.11
Frequency (MHz)	RU config.	ch0 meas PSD (dBm/300kHz)	ch1 meas PSD (dBm/300kHz)	Duty Factor (dB)	10log (500kHz/RBW) Factor(dB)	Total Corr'd PSD(dBm/500 kHz)	Limit	Margin (dB)
5710 (U-NII 3)	full	-10.12	-9.90	0.00	2.22	-4.78	30.00 dBm/500kHz	-34.78
5755	full	-9.10	-7.33	0.00	2.22	-2.90	30.00 dBm/500kHz	-32.90
	242/61	-5.62	-5.12	0.00	2.22	-0.13	30.00 dBm/500kHz	-30.13
5795	full	-8.24	-8.06	0.00	2.22	-2.92	30.00 dBm/500kHz	-32.92
	242/62	-6.32	-5.08	0.00	2.22	-0.43	30.00 dBm/500kHz	-30.43
POWER DENSITY 802.11ax 80 MODE								
Frequency (MHz)	RU config.	ch0 meas PSD (dBm/MHz)	ch1 meas PSD (dBm/MHz)	Duty Factor (dB)	Total Corr'd PSD(dBm/MHz)		Limit	Margin (dB)
5210	full	-4.70	-3.05	0.00	-0.79		11.00 dBm/MHz	-11.79
	484/65	-3.08	-2.23	0.00	0.38		11.00 dBm/MHz	-10.62
5290	full	-5.44	-4.90	0.00	-2.15		11.00 dBm/MHz	-13.15
	484/66	-3.81	-2.83	0.00	-0.28		11.00 dBm/MHz	-11.28
5530	full	-5.80	-4.75	0.00	-2.23		11.00 dBm/MHz	-13.23
	484/65	-4.03	-3.18	0.00	-0.57		11.00 dBm/MHz	-11.57
5610	full	-6.02	-4.69	0.00	-2.29		11.00 dBm/MHz	-13.29
	484/66	-3.75	-2.78	0.00	-0.23		11.00 dBm/MHz	-11.23
5690 (U-NII 2C)	full	-5.48	-5.23	0.00	-2.34		11.00 dBm/MHz	-13.34
Frequency (MHz)	RU config.	ch0 meas PSD (dBm/300kHz)	ch1 meas PSD (dBm/300kHz)	Duty Factor (dB)	10log (500kHz/RBW) Factor(dB)	Total Corr'd PSD(dBm/500 kHz)	Limit	Margin (dB)
5690 (U-NII 3)	full	-12.94	-12.28	0.00	2.22	-7.37	30.00 dBm/500kHz	-37.37
5775	full	-10.41	-9.15	0.00	2.22	-4.50	30.00 dBm/500kHz	-34.50
	484/65	-9.18	-7.70	0.00	2.22	-3.15	30.00 dBm/500kHz	-33.15
	484/66	-8.97	-7.95	0.00	2.22	-3.20	30.00 dBm/500kHz	-33.20

Unless otherwise stated the results shown in this test report refer only to the sample(s) tested and such sample(s) are retained for 90 days only.

除非另有說明，此報告結果僅對測試之樣品負責，同時此樣品僅保留90天。本報告未經本公司書面許可，不可部份複製。

This document is issued by the Company subject to its General Conditions of Service printed overleaf, available on request or accessible at <http://www.sgs.com.tw/Terms-and-Conditions> and for electronic format documents, subject to Terms and Conditions for Electronic Documents at <http://www.sgs.com.tw/Terms-and-Conditions>. Attention is drawn to the limitation of liability, indemnification and jurisdiction issues defined therein. Any holder of this document is advised that information contained hereon reflects the Company's findings at the time of its intervention only and within the limits of Client's instructions, if any. The Company's sole responsibility is to its Client and this document does not exonerate parties to a transaction from exercising all their rights and obligations under the transaction documents. This document cannot be reproduced except in full, without prior written approval of the Company. Any unauthorized alteration, forgery or falsification of the content or appearance of this document is unlawful and offenders may be prosecuted to the fullest extent of the law.

10.5.2 EIRP spectral density (ISED)

EIRP spectral density 802.11a MODE					
Freq. (MHz)	PSD (dBm)	Ant. Gain (dBi)	EIRP PSD (dBm)	Limit (dBm)	Margin (dB)
5180	1.50	-0.54	0.96	10	-9.04
5220	0.87	-0.54	0.33	10	-9.67
5240	0.48	-0.54	-0.06	10	-10.06
EIRP spectral density 802.11n HT20 MODE					
Freq. (MHz)	PSD (dBm)	Ant. Gain (dBi)	EIRP SD (dBm)	Limit (dBm)	Margin (dB)
5180	3.62	-0.54	3.08	10	-6.92
5220	3.40	-0.54	2.86	10	-7.14
5240	3.05	-0.54	2.51	10	-7.49
EIRP spectral density 802.11n HT40 MODE					
Freq. (MHz)	PSD (dBm)	Ant. Gain (dBi)	EIRP SD (dBm)	Limit (dBm)	Margin (dB)
5190	0.63	-0.54	0.09	10	-9.91
5230	0.14	-0.54	-0.40	10	-10.40
EIRP spectral density 802.11ac VHT80 MODE					
Freq. (MHz)	PSD (dBm)	Ant. Gain (dBi)	EIRP SD (dBm)	Limit (dBm)	Margin (dB)
5210	-2.54	-0.54	-3.08	10	-13.08

Unless otherwise stated the results shown in this test report refer only to the sample(s) tested and such sample(s) are retained for 90 days only.

除非另有說明，此報告結果僅對測試之樣品負責，同時此樣品僅保留90天。本報告未經本公司書面許可，不可部份複製。

This document is issued by the Company subject to its General Conditions of Service printed overleaf, available on request or accessible at <http://www.sgs.com.tw/Terms-and-Conditions> and for electronic format documents, subject to Terms and Conditions for Electronic Documents at <http://www.sgs.com.tw/Terms-and-Conditions>. Attention is drawn to the limitation of liability, indemnification and jurisdiction issues defined therein. Any holder of this document is advised that information contained hereon reflects the Company's findings at the time of its intervention only and within the limits of Client's instructions, if any. The Company's sole responsibility is to its Client and this document does not exonerate parties to a transaction from exercising all their rights and obligations under the transaction documents. This document cannot be reproduced except in full, without prior written approval of the Company. Any unauthorized alteration, forgery or falsification of the content or appearance of this document is unlawful and offenders may be prosecuted to the fullest extent of the law.

EIRP spectral density 802.11ax 20 MODE						
Freq. (MHz)	RU config.	PSD (dBm)	Ant. Gain (dBi)	EIRP SD (dBm)	Limit (dBm)	Margin (dB)
5180	full	3.13	-0.54	2.59	10	-7.41
	26/0	10.45	-0.54	9.91	10	-0.09
	52/37	9.35	-0.54	8.81	10	-1.19
	106/53	6.65	-0.54	6.11	10	-3.89
5220	full	2.75	-0.54	2.21	10	-7.79
5240	full	2.92	-0.54	2.38	10	-7.62
EIRP spectral density 802.11ax 40 MODE						
Freq. (MHz)	RU config.	PSD (dBm)	Ant. Gain (dBi)	EIRP SD (dBm)	Limit (dBm)	Margin (dB)
5190	full	0.76	-0.54	0.22	10	-9.78
	242/61	3.26	-0.54	2.72	10	-7.28
5230	full	0.34	-0.54	-0.20	10	-10.20
EIRP spectral density 802.11ax 80 MODE						
Freq. (MHz)	RU config.	PSD (dBm)	Ant. Gain (dBi)	EIRP SD (dBm)	Limit (dBm)	Margin (dB)
5210	full	-0.79	-0.54	-1.33	10	-11.33
	484/65	0.38	-0.54	-0.16	10	-10.16

Unless otherwise stated the results shown in this test report refer only to the sample(s) tested and such sample(s) are retained for 90 days only.

除非另有說明，此報告結果僅對測試之樣品負責，同時此樣品僅保留90天。本報告未經本公司書面許可，不可部份複製。

This document is issued by the Company subject to its General Conditions of Service printed overleaf, available on request or accessible at <http://www.sgs.com.tw/Terms-and-Conditions> and for electronic format documents, subject to Terms and Conditions for Electronic Documents at <http://www.sgs.com.tw/Terms-and-Conditions>. Attention is drawn to the limitation of liability, indemnification and jurisdiction issues defined therein. Any holder of this document is advised that information contained hereon reflects the Company's findings at the time of its intervention only and within the limits of Client's instructions, if any. The Company's sole responsibility is to its Client and this document does not exonerate parties to a transaction from exercising all their rights and obligations under the transaction documents. This document cannot be reproduced except in full, without prior written approval of the Company. Any unauthorized alteration, forgery or falsification of the content or appearance of this document is unlawful and offenders may be prosecuted to the fullest extent of the law.