

ELECTROMAGNETIC EMISSIONS COMPLIANCE REPORT

Applicant: Murata Manufacturing Co., Ltd.
1-10-1, Higashikotari, Nagaokakyo-shi, Kyoto 617-8555 Japan

Product Name: Communication Module

Brand Name: muRata

Model No.: LBEE6ZZ2AJ

Model Difference: N/A

Report Number: ER/2020/B0044

FCC ID VPLYB2AJ

IC: 772C-LB2AJ

FCC Rule Part: §15.247, Cat: DSS

IC RSS: RSS-247 issue 2 Feb 2017

Issue Date: Jan. 28, 2021

Date of Test: Nov. 19, 2020 ~ Jan. 12, 2021

Date of EUT Received: Nov. 19, 2020

We hereby certify that:

The above equipment was tested by SGS Taiwan Ltd. Central RF Lab The test data, data evaluation, test procedures, and equipment configurations shown in this report were made in accordance with the procedures given in ANSI C63.10:2013 and the energy emitted by the sample EUT tested as described in this report is in compliance with conducted and radiated emission limits.

The test results of this report relate only to the tested sample identified in this report.

Approved By: _____



Jim Chang / Manager



Unless otherwise stated the results shown in this test report refer only to the sample(s) tested and such sample(s) are retained for 90 days only.

除非另有說明，此報告結果僅對測試之樣品負責，同時此樣品僅保留90天。本報告未經本公司書面許可，不可部份複製。

This document is issued by the Company subject to its General Conditions of Service printed overleaf, available on request or accessible at <http://www.sgs.com.tw/Terms-and-Conditions> and for electronic format documents, subject to Terms and Conditions for Electronic Documents at <http://www.sgs.com.tw/Terms-and-Conditions>. Attention is drawn to the limitation of liability, indemnification and jurisdiction issues defined therein. Any holder of this document is advised that information contained hereon reflects the Company's findings at the time of its intervention only and within the limits of Client's instructions, if any. The Company's sole responsibility is to its Client and this document does not exonerate parties to a transaction from exercising all their rights and obligations under the transaction documents. This document cannot be reproduced except in full, without prior written approval of the Company. Any unauthorized alteration, forgery or falsification of the content or appearance of this document is unlawful and offenders may be prosecuted to the fullest extent of the law.

Revision History

Report Number	Revision	Description	Issue Date	Remark
ER/2020/B0044	Rev.00	Original.	Jan. 28, 2021	Revised By: Yuri Tsai

Note:

1、Disclaimer

Antenna information is provided by the applicant, test results of this report are applicable to the sample EUT received.

Unless otherwise stated the results shown in this test report refer only to the sample(s) tested and such sample(s) are retained for 90 days only.

除非另有說明，此報告結果僅對測試之樣品負責，同時此樣品僅保留90天。本報告未經本公司書面許可，不可部份複製。

This document is issued by the Company subject to its General Conditions of Service printed overleaf, available on request or accessible at <http://www.sgs.com.tw/Terms-and-Conditions> and for electronic format documents, subject to Terms and Conditions for Electronic Documents at <http://www.sgs.com.tw/Terms-and-Conditions>. Attention is drawn to the limitation of liability, indemnification and jurisdiction issues defined therein. Any holder of this document is advised that information contained hereon reflects the Company's findings at the time of its intervention only and within the limits of Client's instructions, if any. The Company's sole responsibility is to its Client and this document does not exonerate parties to a transaction from exercising all their rights and obligations under the transaction documents. This document cannot be reproduced except in full, without prior written approval of the Company. Any unauthorized alteration, forgery or falsification of the content or appearance of this document is unlawful and offenders may be prosecuted to the fullest extent of the law.

Table of Contents

1	GENERAL INFORMATION.....	4
2	SYSTEM TEST CONFIGURATION.....	6
3	SUMMARY OF TEST RESULTS	9
4	DESCRIPTION OF TEST MODES	10
5	MEASUREMENT UNCERTAINTY	12
6	CONDUCTED EMISSION TEST	13
7	PEAK OUTPUT POWER MEASUREMENT	17
8	20DB & 99% BANDWIDTH MEASUREMENT.....	20
9	CONDUCTED BAND EDGES AND SPURIOUS EMISSION MEASUREMENT	26
10	RADIATED BANDEDGE AND SPURIOUS EMISSION MEASUREMENT.....	32
11	FREQUENCY SEPARATION.....	61
12	NUMBER OF HOPPING FREQUENCY	63
13	TIME OF OCCUPANCY (DWELL TIME)	65
14	ANTENNA REQUIREMENT.....	75

Unless otherwise stated the results shown in this test report refer only to the sample(s) tested and such sample(s) are retained for 90 days only.

除非另有說明，此報告結果僅對測試之樣品負責，同時此樣品僅保留90天。本報告未經本公司書面許可，不可部份複製。

This document is issued by the Company subject to its General Conditions of Service printed overleaf, available on request or accessible at <http://www.sgs.com.tw/Terms-and-Conditions> and for electronic format documents, subject to Terms and Conditions for Electronic Documents at <http://www.sgs.com.tw/Terms-and-Conditions>. Attention is drawn to the limitation of liability, indemnification and jurisdiction issues defined therein. Any holder of this document is advised that information contained hereon reflects the Company's findings at the time of its intervention only and within the limits of Client's instructions, if any. The Company's sole responsibility is to its Client and this document does not exonerate parties to a transaction from exercising all their rights and obligations under the transaction documents. This document cannot be reproduced except in full, without prior written approval of the Company. Any unauthorized alteration, forgery or falsification of the content or appearance of this document is unlawful and offenders may be prosecuted to the fullest extent of the law.

1 GENERAL INFORMATION

1.1 Product description

Product Name:	Communication Module
Brand Name:	muRata
Model No.:	LBEE6ZZ2AJ
Model Difference:	N/A
Hardware Version:	1.0
Software Version:	1.0
EUT Series No.:	2AJ-1
Power Supply:	3.85Vdc

Radio Technology:	Bluetooth BR+EDR
Channel number:	79 channels
Modulation type:	GFSK + $\pi/4$ DQPSK + 8DPSK
Transmit Power:	6.19 dBm
Frequency Range:	2.402GHz – 2.480GHz
Dwell Time:	$\leq 0.4s$

1.2 Antenna Designation

Antenna Type	Supplier	Antenna Part No.	Freq. (MHz)	Peak Antenna Gain (dBi)
Patch	TE	955-011-901	2402-2480	-1.9

Unless otherwise stated the results shown in this test report refer only to the sample(s) tested and such sample(s) are retained for 90 days only.

除非另有說明，此報告結果僅對測試之樣品負責，同時此樣品僅保留90天。本報告未經本公司書面許可，不可部份複製。

This document is issued by the Company subject to its General Conditions of Service printed overleaf, available on request or accessible at <http://www.sgs.com.tw/Terms-and-Conditions> and for electronic format documents, subject to Terms and Conditions for Electronic Documents at <http://www.sgs.com.tw/Terms-and-Conditions>. Attention is drawn to the limitation of liability, indemnification and jurisdiction issues defined therein. Any holder of this document is advised that information contained hereon reflects the Company's findings at the time of its intervention only and within the limits of Client's instructions, if any. The Company's sole responsibility is to its Client and this document does not exonerate parties to a transaction from exercising all their rights and obligations under the transaction documents. This document cannot be reproduced except in full, without prior written approval of the Company. Any unauthorized alteration, forgery or falsification of the content or appearance of this document is unlawful and offenders may be prosecuted to the fullest extent of the law.

1.3 Test Methodology of Applied Standards

FCC Part 15, Subpart C §15.247
FCC KDB 558074 D01 15.247 Meas. Guidance v05r02
RSS-247 issue 2 Feb. 2017
RSS-Gen. issue 5, Amendment 1, March 2019
ANSI C63.10:2013

1.4 Test Facility

SGS Taiwan Ltd. Central RF Lab (TAF code 3702)
No.134, Wu Kung Road, New Taipei Industrial Park, Wuku District, New Taipei City, Taiwan 24803

FCC Designation number: TW0027

ISED CAB identifier: TW3702

1.5 Special Accessories

There is no special accessory used while test was conducted.

1.6 Equipment Modifications

There was no modification incorporated into the EUT.

Unless otherwise stated the results shown in this test report refer only to the sample(s) tested and such sample(s) are retained for 90 days only.

除非另有說明，此報告結果僅對測試之樣品負責，同時此樣品僅保留90天。本報告未經本公司書面許可，不可部份複製。

This document is issued by the Company subject to its General Conditions of Service printed overleaf, available on request or accessible at <http://www.sgs.com.tw/Terms-and-Conditions> and for electronic format documents, subject to Terms and Conditions for Electronic Documents at <http://www.sgs.com.tw/Terms-and-Conditions>. Attention is drawn to the limitation of liability, indemnification and jurisdiction issues defined therein. Any holder of this document is advised that information contained hereon reflects the Company's findings at the time of its intervention only and within the limits of Client's instructions, if any. The Company's sole responsibility is to its Client and this document does not exonerate parties to a transaction from exercising all their rights and obligations under the transaction documents. This document cannot be reproduced except in full, without prior written approval of the Company. Any unauthorized alteration, forgery or falsification of the content or appearance of this document is unlawful and offenders may be prosecuted to the fullest extent of the law.

2 SYSTEM TEST CONFIGURATION

2.1 EUT Configuration

The EUT configuration for testing is installed on RF field strength measurement to meet the Commissions requirement and operating in a manner which intends to maximize its emission characteristics in a continuous normal application.

2.2 EUT Exercise

An engineering test mode (software/firmware) that applicant provided was utilized to manipulate the EUT into transmit, selection of the test channel, and modulation scheme.

2.3 Test Procedure

2.3.1 Conducted Emissions

The EUT is placed on a table which is 0.8 m above ground plane. Conducted emissions from the EUT measured in the frequency range between 0.15 MHz and 30MHz. The CISPR Quasi-Peak and Average detector mode is employed. The two LISNs provide 50uH/50 ohm of coupling impedance for the measuring instrument. Both lines of the power mains connected to the EUT were checked for maximum conducted interference.

2.3.2 Conducted Test (RF)

The active antenna port of the unlicensed wireless device is connected to the spectrum analyzer with attenuator to protect the instrumentation. If a second antenna port is available, it is tested at one operating frequency, with other port(s) appropriately terminated, to verify it has similar output characteristics as the fully tested port.

2.3.3 Radiated Emissions

The EUT is placed on a turn table. For emissions testing at or below 1 GHz, the table height shall be 0.8 m above the reference ground plane. For emission measurements above 1 GHz, the table height shall be 1.5 m. The turn table shall rotate 360 degrees to determine the position of maximum emission level. EUT is set 3m away from the receiving antenna which varied from 1m to 4m to find out the highest emission. And also, each emission was to be maximized by changing the polarization of receiving antenna both horizontal and vertical. In order to find out the max. emission, the relative positions of this transmitter (EUT) was rotated through three orthogonal axes and measurement procedures for electric field radiated emissions above 1 GHz the EUT measurement is to be made "while keeping the antenna in the 'cone of radiation' from that area and pointed at the area both in azimuth and elevation, with polarization oriented for maximum response." is still within the 3dB illumination BW of the measurement antenna.

Unless otherwise stated the results shown in this test report refer only to the sample(s) tested and such sample(s) are retained for 90 days only.

除非另有說明，此報告結果僅對測試之樣品負責，同時此樣品僅保留90天。本報告未經本公司書面許可，不可部份複製。

This document is issued by the Company subject to its General Conditions of Service printed overleaf, available on request or accessible at <http://www.sgs.com.tw/Terms-and-Conditions> and for electronic format documents, subject to Terms and Conditions for Electronic Documents at <http://www.sgs.com.tw/Terms-and-Conditions>. Attention is drawn to the limitation of liability, indemnification and jurisdiction issues defined therein. Any holder of this document is advised that information contained hereon reflects the Company's findings at the time of its intervention only and within the limits of Client's instructions, if any. The Company's sole responsibility is to its Client and this document does not exonerate parties to a transaction from exercising all their rights and obligations under the transaction documents. This document cannot be reproduced except in full, without prior written approval of the Company. Any unauthorized alteration, forgery or falsification of the content or appearance of this document is unlawful and offenders may be prosecuted to the fullest extent of the law.

2.4 Measurement Results Explanation Example

2.4.1 Radiated Emission Test Sites For Measurements From 9 kHz To 30 MHz

Radiated emission below 30MHz is measured in a 9m*9m*6m semi-anechoic chamber, the measurements correspond to those obtained at an open-field test site.

There is a comparison data of both open-field test site and semi-Anechoic chamber, and the result came out very similar.

2.4.2 For all conducted test items:

The offset level is set in the spectrum analyzer to compensate the RF cable loss and attenuation factor between EUT conducted port and spectrum analyzer. With the offset compensation, the spectrum analyzer reading level is exactly EUT RF output level.

Unless otherwise stated the results shown in this test report refer only to the sample(s) tested and such sample(s) are retained for 90 days only.

除非另有說明，此報告結果僅對測試之樣品負責，同時此樣品僅保留90天。本報告未經本公司書面許可，不可部份複製。

This document is issued by the Company subject to its General Conditions of Service printed overleaf, available on request or accessible at <http://www.sgs.com.tw/Terms-and-Conditions> and for electronic format documents, subject to Terms and Conditions for Electronic Documents at <http://www.sgs.com.tw/Terms-and-Conditions>. Attention is drawn to the limitation of liability, indemnification and jurisdiction issues defined therein. Any holder of this document is advised that information contained hereon reflects the Company's findings at the time of its intervention only and within the limits of Client's instructions, if any. The Company's sole responsibility is to its Client and this document does not exonerate parties to a transaction from exercising all their rights and obligations under the transaction documents. This document cannot be reproduced except in full, without prior written approval of the Company. Any unauthorized alteration, forgery or falsification of the content or appearance of this document is unlawful and offenders may be prosecuted to the fullest extent of the law.

2.5 Configuration of Tested System

Fig. 2-1 Radiated Emission



Fig. 2-2 Conducted (Antenna Port) Configuration



Fig 2-3 Conduction (AC Power Line) Radiated Emission

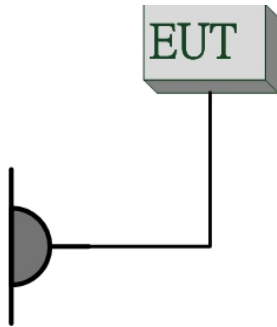

Table 2-1 Equipment Used in Tested System

Item	Equipment	Mfr/Brand	Model/Type No.	Series No.	Data Cable	Power Cord
1	Bluetooth Test Software	N/A	N/A	N/A	N/A	N/A
2	Notebook	Lenovo	L430	R9-XFG0X	N/A	N/A
3	DC Power Supply	Agilent	E3640A	MY52410006	N/A	N/A
4	DC Power Supply	Agilent	E3640A	KR93300208	N/A	N/A

Unless otherwise stated the results shown in this test report refer only to the sample(s) tested and such sample(s) are retained for 90 days only.

除非另有說明，此報告結果僅對測試之樣品負責，同時此樣品僅保留90天。本報告未經本公司書面許可，不可部份複製。

This document is issued by the Company subject to its General Conditions of Service printed overleaf, available on request or accessible at <http://www.sgs.com.tw/Terms-and-Conditions> and for electronic format documents, subject to Terms and Conditions for Electronic Documents at <http://www.sgs.com.tw/Terms-and-Conditions>. Attention is drawn to the limitation of liability, indemnification and jurisdiction issues defined therein. Any holder of this document is advised that information contained hereon reflects the Company's findings at the time of its intervention only and within the limits of Client's instructions, if any. The Company's sole responsibility is to its Client and this document does not exonerate parties to a transaction from exercising all their rights and obligations under the transaction documents. This document cannot be reproduced except in full, without prior written approval of the Company. Any unauthorized alteration, forgery or falsification of the content or appearance of this document is unlawful and offenders may be prosecuted to the fullest extent of the law.

3 SUMMARY OF TEST RESULTS

FCC Rules	IC Rules	Description Of Test	Result
§15.207(a)	RSS-Gen §8.8	AC Power Line Conducted Emission	Compliant
§15.247(b)(1)	RSS-247 §5.4 b	Peak Output Power	Compliant
§15.247(a)(1)	RSS-247 §5.1 b RSS-Gen §6.7	20dB & 99% Bandwidth	Compliant
§15.205 §15.209 §15.247(d)	RSS-247 §5.5 RSS-Gen §8.9 RSS-Gen §8.10	Conducted & Radiated Band Edge and Spurious Emission	Compliant
§15.247(a)(1)	RSS-247 §5.1 b	Frequency Separation	Compliant
§15.247(a)(1)(iii)	RSS-247 §5.1 d	Number of hopping frequency Time of Occupancy	Compliant
§15.203	N/A	Antenna Requirement	Compliant

Unless otherwise stated the results shown in this test report refer only to the sample(s) tested and such sample(s) are retained for 90 days only.

除非另有說明，此報告結果僅對測試之樣品負責，同時此樣品僅保留90天。本報告未經本公司書面許可，不可部份複製。

This document is issued by the Company subject to its General Conditions of Service printed overleaf, available on request or accessible at <http://www.sgs.com.tw/Terms-and-Conditions> and for electronic format documents, subject to Terms and Conditions for Electronic Documents at <http://www.sgs.com.tw/Terms-and-Conditions>. Attention is drawn to the limitation of liability, indemnification and jurisdiction issues defined therein. Any holder of this document is advised that information contained hereon reflects the Company's findings at the time of its intervention only and within the limits of Client's instructions, if any. The Company's sole responsibility is to its Client and this document does not exonerate parties to a transaction from exercising all their rights and obligations under the transaction documents. This document cannot be reproduced except in full, without prior written approval of the Company. Any unauthorized alteration, forgery or falsification of the content or appearance of this document is unlawful and offenders may be prosecuted to the fullest extent of the law.

4 DESCRIPTION OF TEST MODES

4.1 Operated in 2400 ~ 2483.5MHz Band

79 channels are provided for Bluetooth

ITEM	FREQUENCY	ITEM	FREQUENCY	ITEM	FREQUENCY	ITEM	FREQUENCY
1	2402 MHz	21	2422 MHz	41	2442 MHz	71	2462 MHz
2	2403 MHz	22	2423 MHz	42	2443 MHz	72	2463 MHz
3	2404 MHz	23	2424 MHz	43	2444 MHz	73	2464 MHz
4	2405 MHz	24	2425 MHz	44	2445 MHz	74	2465 MHz
5	2406 MHz	25	2426 MHz	45	2446 MHz	75	2466 MHz
6	2407 MHz	26	2427 MHz	46	2447 MHz	76	2467 MHz
7	2408 MHz	27	2428 MHz	47	2448 MHz	77	2468 MHz
8	2409 MHz	28	2429 MHz	48	2449 MHz	78	2469 MHz
9	2410 MHz	29	2430 MHz	49	2450 MHz	79	2470 MHz
10	2411 MHz	30	2431 MHz	50	2451 MHz	70	2471 MHz
11	2412 MHz	31	2432 MHz	51	2452 MHz	71	2472 MHz
12	2413 MHz	32	2433 MHz	52	2453 MHz	72	2473 MHz
13	2414 MHz	33	2434 MHz	53	2454 MHz	73	2474 MHz
14	2415 MHz	34	2435 MHz	54	2455 MHz	74	2475 MHz
15	2416 MHz	35	2436 MHz	55	2456 MHz	75	2476 MHz
16	2417 MHz	36	2437 MHz	56	2457 MHz	76	2477 MHz
17	2418 MHz	37	2438 MHz	57	2458 MHz	77	2478 MHz
18	2419 MHz	38	2439 MHz	58	2459 MHz	78	2479 MHz
19	2420 MHz	39	2440 MHz	59	2460 MHz	79	2480 MHz
20	2421 MHz	40	2441 MHz	60	2461 MHz		

Unless otherwise stated the results shown in this test report refer only to the sample(s) tested and such sample(s) are retained for 90 days only.

除非另有說明，此報告結果僅對測試之樣品負責，同時此樣品僅保留90天。本報告未經本公司書面許可，不可部份複製。

This document is issued by the Company subject to its General Conditions of Service printed overleaf, available on request or accessible at <http://www.sgs.com.tw/Terms-and-Conditions> and for electronic format documents, subject to Terms and Conditions for Electronic Documents at <http://www.sgs.com.tw/Terms-and-Conditions>. Attention is drawn to the limitation of liability, indemnification and jurisdiction issues defined therein. Any holder of this document is advised that information contained hereon reflects the Company's findings at the time of its intervention only and within the limits of Client's instructions, if any. The Company's sole responsibility is to its Client and this document does not exonerate parties to a transaction from exercising all their rights and obligations under the transaction documents. This document cannot be reproduced except in full, without prior written approval of the Company. Any unauthorized alteration, forgery or falsification of the content or appearance of this document is unlawful and offenders may be prosecuted to the fullest extent of the law.

4.2 The Worst Test Modes and Channel Details

- 1 The EUT has been tested under operating condition.
- 2 Test program used to control the EUT for staying in continuous transmitting and receiving mode is programmed.
- 3 Investigation has been done on all the possible configurations for searching the worst case.

MODE	AVAILABLE CHANNEL	TESTED CHANNEL	MODULATION	PACKET TYPE
RADIATED EMISSION TEST (BELOW 1 GHz)				
Bluetooth	0 to 78	39	8-DPSK	3DH5
RADIATED EMISSION TEST (ABOVE 1 GHz)				
Bluetooth	0 to 78	0,39,78	8-DPSK	3DH5
<p>Note: The field strength of radiation emission was measured as EUT stand-up position (H mode) and lie down position (E1, E2 mode) for Bluetooth BR+EDR Transmitter for channel Low, Mid and High, the worst case H position was reported.</p>				

ANTENNA PORT CONDUCTED TEST				
MODE	AVAILABLE CHANNEL	TESTED CHANNEL	MODULATION	PACKET TYPE
Peak Output Power, 20dB Band Width				
Bluetooth	0 to 78	0,39,78	GFSK, $\pi/4$ -DQPSK, 8-DPSK	DH5/2DH5/3DH5
Band Edge				
Bluetooth	0 to 78	0,78	GFSK, 8-DPSK	DH5/3DH5
Frequency Separation				
Bluetooth	0 to 78	0,1,2	8-DPSK	3DH5
Number of hopping frequency				
Bluetooth	0 to 78	0 to 78	8-DPSK	3DH5
Time of Occupancy (Dwell time)				
Bluetooth	0 to 78	0,39,78	GFSK, $\pi/4$ -DQPSK, 8-DPSK	DH5/2DH5/3DH5 2DH1/2DH3/2DH5 3DH1/3DH3/3DH5

Unless otherwise stated the results shown in this test report refer only to the sample(s) tested and such sample(s) are retained for 90 days only.

除非另有說明，此報告結果僅對測試之樣品負責，同時此樣品僅保留90天。本報告未經本公司書面許可，不可部份複製。

This document is issued by the Company subject to its General Conditions of Service printed overleaf, available on request or accessible at <http://www.sgs.com.tw/Terms-and-Conditions> and for electronic format documents, subject to Terms and Conditions for Electronic Documents at <http://www.sgs.com.tw/Terms-and-Conditions>. Attention is drawn to the limitation of liability, indemnification and jurisdiction issues defined therein. Any holder of this document is advised that information contained hereon reflects the Company's findings at the time of its intervention only and within the limits of Client's instructions, if any. The Company's sole responsibility is to its Client and this document does not exonerate parties to a transaction from exercising all their rights and obligations under the transaction documents. This document cannot be reproduced except in full, without prior written approval of the Company. Any unauthorized alteration, forgery or falsification of the content or appearance of this document is unlawful and offenders may be prosecuted to the fullest extent of the law.

5 MEASUREMENT UNCERTAINTY

Test Items	Uncertainty
AC Power Line Conducted Emission	+/- 2.34 dB
Peak Output Power	+/- 1 dB
20dB Bandwidth	+/- 1.54 Hz
100 KHz Bandwidth Of Frequency Band Edges	+/- 1.69 dB
Frequency Separation	+/- 1.54 Hz
Number of hopping frequency	+/- 1.54 Hz
Time of Occupancy	+/- 1.54 Hz
Temperature	+/- 0.4 °C
Humidity	+/- 3.5 %
DC / AC Power Source	DC= +/- 1%, AC= +/- 1%

Radiated Spurious Emission Measurement Uncertainty		
Polarization: Vertical	+/- 2.64 dB	9kHz~30MHz: +-2.3dB
	+/- 4.93 dB	30MHz - 1000MHz: +/- 3.37dB
	+/- 4.81 dB	1GHz - 18GHz: +/- 4.04dB
	+/- 4.52 dB	18GHz - 40GHz: +/- 4.04dB
Polarization: Horizontal	+/- 2.64 dB	9kHz~30MHz: +-2.3dB
	+/- 4.45 dB	30MHz - 1000MHz: +/- 4.22dB
	+/- 4.81 dB	1GHz - 18GHz: +/- 4.08dB
	+/- 4.52 dB	18GHz - 40GHz: +/- 4.08dB

Note:

1. This uncertainty represents an expanded uncertainty expressed at approximately the 95% confidence level using a coverage factor of k=2.
2. The conformity assessment statement in this report is based solely on the test results, measurement uncertainty is excluded.

Unless otherwise stated the results shown in this test report refer only to the sample(s) tested and such sample(s) are retained for 90 days only.

除非另有說明，此報告結果僅對測試之樣品負責，同時此樣品僅保留90天。本報告未經本公司書面許可，不可部份複製。

This document is issued by the Company subject to its General Conditions of Service printed overleaf, available on request or accessible at <http://www.sgs.com.tw/Terms-and-Conditions> and for electronic format documents, subject to Terms and Conditions for Electronic Documents at <http://www.sgs.com.tw/Terms-and-Conditions>. Attention is drawn to the limitation of liability, indemnification and jurisdiction issues defined therein. Any holder of this document is advised that information contained hereon reflects the Company's findings at the time of its intervention only and within the limits of Client's instructions, if any. The Company's sole responsibility is to its Client and this document does not exonerate parties to a transaction from exercising all their rights and obligations under the transaction documents. This document cannot be reproduced except in full, without prior written approval of the Company. Any unauthorized alteration, forgery or falsification of the content or appearance of this document is unlawful and offenders may be prosecuted to the fullest extent of the law.

6 CONDUCTED EMISSION TEST

6.1 Standard Applicable

Frequency within 150 kHz to 30MHz shall not exceed the limit table as below.

Frequency range MHz	Limits dB(uV)	
	Quasi-peak	Average
0.15 to 0.50	66 to 56	56 to 46
0.50 to 5	56	46
5 to 30	60	50

Note

- 1.The lower limit shall apply at the transition frequencies
- 2.The limit decreases linearly with the logarithm of the frequency in the range 0.15 MHz to 0.50 MHz.

6.2 Measurement Equipment Used

Conducted Emission Test Site					
EQUIPMENT TYPE	MFR	MODEL NUMBER	SERIAL NUMBER	LAST CAL.	CAL DUE.
EMI Test Receiver	R&S	ESCI 7	100759	07/13/2020	07/12/2021
LISN	SCHWARZBECK	NSLK 8127	8127-465	04/09/2020	04/08/2021
Coaxial Cables	N/A	Coaxial Cable	161207	12/07/2020	12/06/2021
Test Software	audix	e3	Ver. 6.11-20180413	N.C.R	N.C.R

NOTE: N.C.R refers to Not Calibrated Required.

6.3 EUT Setup

1. The conducted emission tests were performed in the test site, using the setup in accordance with the ANSI 63.10:2013.
2. The AC/DC Power adaptor of EUT was plug-in LISN. The EUT was placed flushed with the rear of the table.
3. The LISN was connected with 120Vac/60Hz power source.

Unless otherwise stated the results shown in this test report refer only to the sample(s) tested and such sample(s) are retained for 90 days only.

除非另有說明，此報告結果僅對測試之樣品負責，同時此樣品僅保留90天。本報告未經本公司書面許可，不可部份複製。

This document is issued by the Company subject to its General Conditions of Service printed overleaf, available on request or accessible at <http://www.sgs.com.tw/Terms-and-Conditions> and for electronic format documents, subject to Terms and Conditions for Electronic Documents at <http://www.sgs.com.tw/Terms-and-Conditions>. Attention is drawn to the limitation of liability, indemnification and jurisdiction issues defined therein. Any holder of this document is advised that information contained hereon reflects the Company's findings at the time of its intervention only and within the limits of Client's instructions, if any. The Company's sole responsibility is to its Client and this document does not exonerate parties to a transaction from exercising all their rights and obligations under the transaction documents. This document cannot be reproduced except in full, without prior written approval of the Company. Any unauthorized alteration, forgery or falsification of the content or appearance of this document is unlawful and offenders may be prosecuted to the fullest extent of the law.

6.4 Test SET-UP (Block Diagram of Configuration)

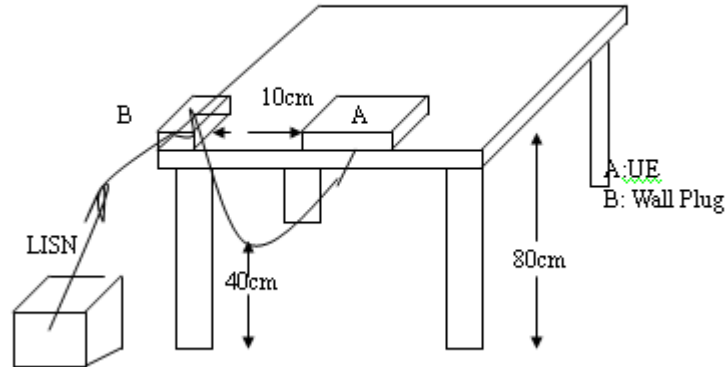

6.5 Measurement Procedure

1. The EUT was placed on a table which is 0.8m above ground plan.
2. Maximum procedure was performed on the six highest emissions to ensure EUT compliance.
3. Repeat above procedures until all frequency measured were complete.

6.6 Measurement Result

Note: Refer to next page for measurement data and plots.

Note2: The * reveals the worst-case results that closet to the limit.

Unless otherwise stated the results shown in this test report refer only to the sample(s) tested and such sample(s) are retained for 90 days only.

除非另有說明，此報告結果僅對測試之樣品負責，同時此樣品僅保留90天。本報告未經本公司書面許可，不可部份複製。

This document is issued by the Company subject to its General Conditions of Service printed overleaf, available on request or accessible at <http://www.sgs.com.tw/Terms-and-Conditions> and for electronic format documents, subject to Terms and Conditions for Electronic Documents at <http://www.sgs.com.tw/Terms-and-Conditions>. Attention is drawn to the limitation of liability, indemnification and jurisdiction issues defined therein. Any holder of this document is advised that information contained hereon reflects the Company's findings at the time of its intervention only and within the limits of Client's instructions, if any. The Company's sole responsibility is to its Client and this document does not exonerate parties to a transaction from exercising all their rights and obligations under the transaction documents. This document cannot be reproduced except in full, without prior written approval of the Company. Any unauthorized alteration, forgery or falsification of the content or appearance of this document is unlawful and offenders may be prosecuted to the fullest extent of the law.

AC POWER LINE CONDUCTED EMISSION TEST DATA

Report Number :ER-2020-B0044
 Test Mode :BT
 Power :AC 120V/60Hz
 Probe :L
 Note :

Test Site :Conduction 6F
 Test Date :2021-01-12
 Temp./Humi. :19.0/49
 Engineer :Ricky

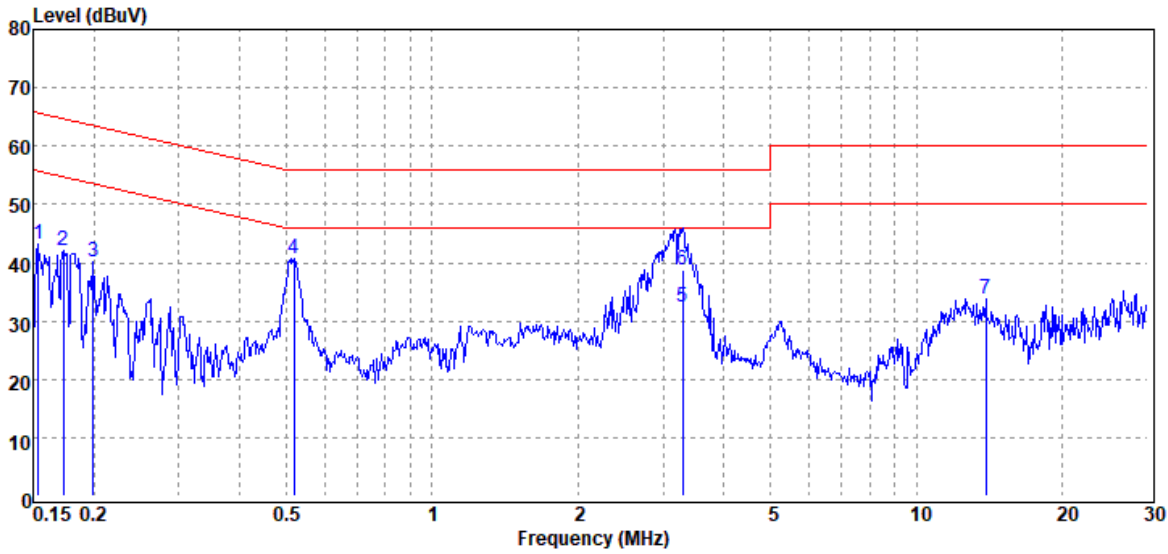

Freq. MHz	Detector Mode PK/QP/AV	Spectrum Reading Level dB μ V	Factor dB	Actual FS dB μ V	Limit dB μ V	Margin dB
0.15	Peak	43.08	0.04	43.12	65.78	-22.66
0.17	Peak	42.10	0.04	42.14	64.81	-22.67
0.20	Peak	40.23	0.04	40.27	63.62	-23.35
0.52	Peak	40.55	0.15	40.70	56.00	-15.30
3.29	Average	31.91	0.40	32.31	46.00	-13.69
3.29	QP	38.41	0.40	38.81	56.00	-17.19
13.92	Peak	32.91	1.00	33.91	60.00	-26.09

Unless otherwise stated the results shown in this test report refer only to the sample(s) tested and such sample(s) are retained for 90 days only.

除非另有說明，此報告結果僅對測試之樣品負責，同時此樣品僅保留90天。本報告未經本公司書面許可，不可部份複製。

This document is issued by the Company subject to its General Conditions of Service printed overleaf, available on request or accessible at <http://www.sgs.com.tw/Terms-and-Conditions> and for electronic format documents, subject to Terms and Conditions for Electronic Documents at <http://www.sgs.com.tw/Terms-and-Conditions>. Attention is drawn to the limitation of liability, indemnification and jurisdiction issues defined therein. Any holder of this document is advised that information contained hereon reflects the Company's findings at the time of its intervention only and within the limits of Client's instructions, if any. The Company's sole responsibility is to its Client and this document does not exonerate parties to a transaction from exercising all their rights and obligations under the transaction documents. This document cannot be reproduced except in full, without prior written approval of the Company. Any unauthorized alteration, forgery or falsification of the content or appearance of this document is unlawful and offenders may be prosecuted to the fullest extent of the law.

Report Number :ER-2020-B0044
 Test Mode :BT
 Power :AC 120V/60Hz
 Probe :N
 Note: :

Test Site :Conduction 6F
 Test Date :2021-01-12
 Temp./Humi. :19.0/49
 Engineer :Ricky

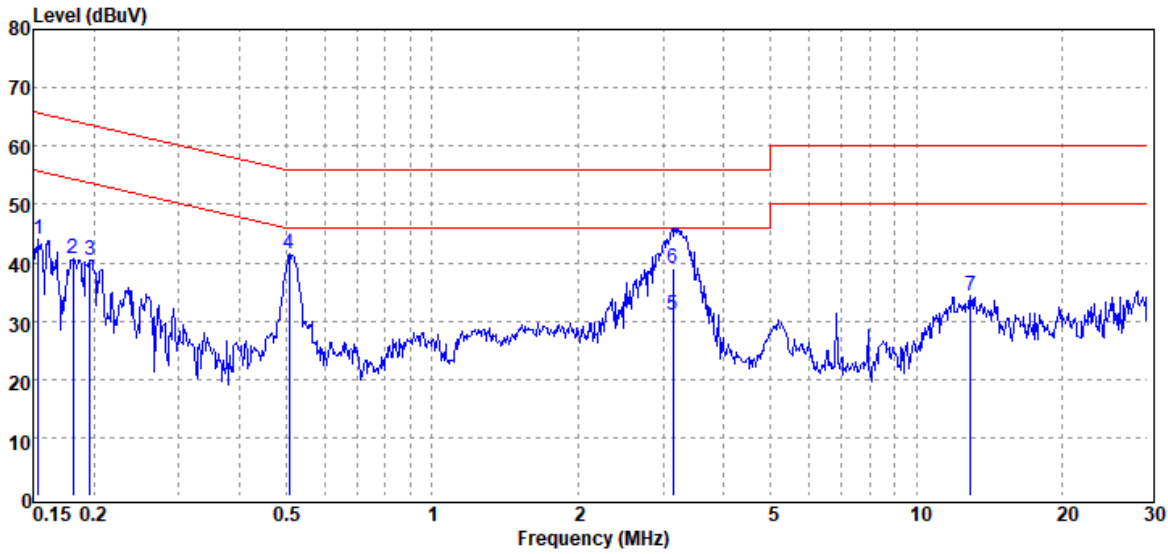

Freq. MHz	Detector Mode PK/QP/AV	Spectrum Reading Level dBµV	Factor dB	Actual FS dBµV	Limit dBµV	Margin dB
0.15	Peak	43.89	0.11	44.00	65.78	-21.78
0.18	Peak	40.47	0.11	40.58	64.42	-23.84
0.20	Peak	40.41	0.11	40.52	63.76	-23.24
0.51	Peak	41.18	0.22	41.40	56.00	-14.60
3.14	Average	30.61	0.37	30.98	46.00	-15.02
3.14	QP	38.79	0.37	39.16	56.00	-16.84
12.92	Peak	33.53	0.88	34.41	60.00	-25.59

Unless otherwise stated the results shown in this test report refer only to the sample(s) tested and such sample(s) are retained for 90 days only.

除非另有說明，此報告結果僅對測試之樣品負責，同時此樣品僅保留90天。本報告未經本公司書面許可，不可部份複製。

This document is issued by the Company subject to its General Conditions of Service printed overleaf, available on request or accessible at <http://www.sgs.com.tw/Terms-and-Conditions> and for electronic format documents, subject to Terms and Conditions for Electronic Documents at <http://www.sgs.com.tw/Terms-and-Conditions>. Attention is drawn to the limitation of liability, indemnification and jurisdiction issues defined therein. Any holder of this document is advised that information contained hereon reflects the Company's findings at the time of its intervention only and within the limits of Client's instructions, if any. The Company's sole responsibility is to its Client and this document does not exonerate parties to a transaction from exercising all their rights and obligations under the transaction documents. This document cannot be reproduced except in full, without prior written approval of the Company. Any unauthorized alteration, forgery or falsification of the content or appearance of this document is unlawful and offenders may be prosecuted to the fullest extent of the law.

7 PEAK OUTPUT POWER MEASUREMENT

7.1 Standard Applicable

For frequency hopping systems operating in the 2400-2483.5 MHz band employing at least 75 hopping channels, The Limit: 1Watt. For all other frequency hopping systems in the 2400 – 2483.5MHz band: The Limit: 0.125 Watts. The power limit for 1Mbps is 1watt, and 2Mbps, 3Mbps and AFH mode are 0.125 watts.

The e.i.r.p. shall not exceed 4 W.

7.2 Measurement Equipment Used

Conducted Emission Test Site					
EQUIPMENT TYPE	MFR	MODEL NUMBER	SERIAL NUMBER	LAST CAL.	CAL DUE.
Power Meter	Anritsu	ML2496A	1804001	02/20/2020	02/19/2021
Power Sensor	Anritsu	MA2411B	1726104	02/20/2020	02/19/2021
Power Sensor	Anritsu	MA2411B	1726107	02/20/2020	02/19/2021
DC Power Supply	Agilent	E3640A	MY52410006	12/17/2020	12/16/2021
DC Power Supply	Agilent	E3640A	KR93300208	08/19/2020	08/18/2021

7.3 Test Set-up:

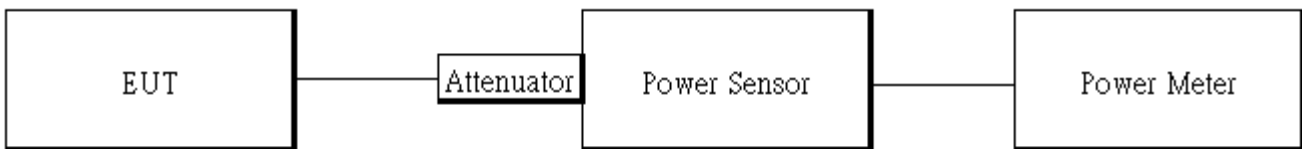

7.4 Measurement Procedure:

1. Place the EUT on the table and set it in transmitting mode.
2. The testing follows ANSI C63.10 Measurement Guidelines.
3. Remove the antenna from the EUT and then connect a low loss RF cable from the antenna port to the power meter or spectrum. (Max Hold, Detector = Peak, RBW >=20dB bandwidth)
4. Record the max. reading.
5. Repeat above procedures until all default test channel is completed.

Unless otherwise stated the results shown in this test report refer only to the sample(s) tested and such sample(s) are retained for 90 days only.

除非另有說明，此報告結果僅對測試之樣品負責，同時此樣品僅保留90天。本報告未經本公司書面許可，不可部份複製。

This document is issued by the Company subject to its General Conditions of Service printed overleaf, available on request or accessible at <http://www.sgs.com.tw/Terms-and-Conditions> and for electronic format documents, subject to Terms and Conditions for Electronic Documents at <http://www.sgs.com.tw/Terms-and-Conditions>. Attention is drawn to the limitation of liability, indemnification and jurisdiction issues defined therein. Any holder of this document is advised that information contained hereon reflects the Company's findings at the time of its intervention only and within the limits of Client's instructions, if any. The Company's sole responsibility is to its Client and this document does not exonerate parties to a transaction from exercising all their rights and obligations under the transaction documents. This document cannot be reproduced except in full, without prior written approval of the Company. Any unauthorized alteration, forgery or falsification of the content or appearance of this document is unlawful and offenders may be prosecuted to the fullest extent of the law.

7.5 Peak & Average Power Measurement Result

1M BR mode (Peak):

CH	Freq. (MHz)	Peak Output Power (dBm)	Output Power (mW)	Limit (mW)
Low	2402	3.74	2.366	1000
Mid	2441	3.84	2.421	1000
High	2480	3.47	2.223	1000

1M BR mode (Average):

CH	Freq. (MHz)	Max. Output include tune up tolerance Power (dBm)	Output Power (mW)	Limit (mW)
Low	2402	3.72	2.357	1000
Mid	2441	3.80	2.401	1000
High	2480	3.44	2.210	1000

2M EDR mode (Peak):

CH	Freq. (MHz)	Peak Output Power (dBm)	Output Power (mW)	Limit (mW)
Low	2402	5.69	3.707	125
Mid	2441	5.82	3.819	125
High	2480	5.46	3.516	125

2M EDR mode (Average):

CH	Freq. (MHz)	Max. Avg. Output include tune up tolerance Power (dBm)	Output Power (mW)	Limit (mW)
Low	2402	3.64	2.310	125
Mid	2441	3.73	2.359	125
High	2480	3.38	2.176	125

3M EDR mode (Peak):

CH	Freq. (MHz)	Peak Output Power (dBm)	Output Power (mW)	Limit (mW)
Low	2402	6.08	4.055	125
Mid	2441	6.19	4.159	125
High	2480	5.81	3.811	125

3M EDR mode (Average):

CH	Freq. (MHz)	Max. Avg. Output include tune up tolerance Power (dBm)	Output Power (mW)	Limit (mW)
Low	2402	3.61	2.298	125
Mid	2441	3.68	2.336	125
High	2480	3.35	2.165	125

NOTE: cable loss as 0.6dB that offsets in the spectrum

**Note: Max. Output include tune up tolerance Power measured by using average detector.*

Unless otherwise stated the results shown in this test report refer only to the sample(s) tested and such sample(s) are retained for 90 days only.

除非另有說明，此報告結果僅對測試之樣品負責，同時此樣品僅保留90天。本報告未經本公司書面許可，不可部份複製。

This document is issued by the Company subject to its General Conditions of Service printed overleaf, available on request or accessible at <http://www.sgs.com.tw/Terms-and-Conditions> and for electronic format documents, subject to Terms and Conditions for Electronic Documents at <http://www.sgs.com.tw/Terms-and-Conditions>. Attention is drawn to the limitation of liability, indemnification and jurisdiction issues defined therein. Any holder of this document is advised that information contained hereon reflects the Company's findings at the time of its intervention only and within the limits of Client's instructions, if any. The Company's sole responsibility is to its Client and this document does not exonerate parties to a transaction from exercising all their rights and obligations under the transaction documents. This document cannot be reproduced except in full, without prior written approval of the Company. Any unauthorized alteration, forgery or falsification of the content or appearance of this document is unlawful and offenders may be prosecuted to the fullest extent of the law.

7.6 EIRP Measurement Result

1M BR mode EIRP

Channel	Frequency (MHz)	Max. Output include tune up tolerance Power (dBm)	Antenna Gain (dBi)	EIRP (mW)	Limit (mW)
Low	2402	3.72	-1.90	1.522	1000
Mid	2441	3.80	-1.90	1.550	1000
High	2480	3.44	-1.90	1.427	1000

2M EDR mode EIRP

Channel	Frequency (MHz)	Max. Avg. Output include tune up tolerance Power (dBm)	Antenna Gain (dBi)	EIRP (mW)	Limit (mW)
Low	2402	3.64	-1.90	1.492	4000
Mid	2441	3.73	-1.90	1.523	4000
High	2480	3.38	-1.90	1.405	4000

3M EDR mode EIRP

Channel	Frequency (MHz)	Max. Avg. Output include tune up tolerance Power (dBm)	Antenna Gain (dBi)	EIRP (mW)	Limit (mW)
Low	2402	3.61	-1.90	1.484	4000
Mid	2441	3.68	-1.90	1.508	4000
High	2480	3.35	-1.90	1.398	4000

* **Note:** EIRP = Average Power + Gain

Unless otherwise stated the results shown in this test report refer only to the sample(s) tested and such sample(s) are retained for 90 days only.

除非另有說明，此報告結果僅對測試之樣品負責，同時此樣品僅保留90天。本報告未經本公司書面許可，不可部份複製。

This document is issued by the Company subject to its General Conditions of Service printed overleaf, available on request or accessible at <http://www.sgs.com.tw/Terms-and-Conditions> and for electronic format documents, subject to Terms and Conditions for Electronic Documents at <http://www.sgs.com.tw/Terms-and-Conditions>. Attention is drawn to the limitation of liability, indemnification and jurisdiction issues defined therein. Any holder of this document is advised that information contained hereon reflects the Company's findings at the time of its intervention only and within the limits of Client's instructions, if any. The Company's sole responsibility is to its Client and this document does not exonerate parties to a transaction from exercising all their rights and obligations under the transaction documents. This document cannot be reproduced except in full, without prior written approval of the Company. Any unauthorized alteration, forgery or falsification of the content or appearance of this document is unlawful and offenders may be prosecuted to the fullest extent of the law.

8 20dB & 99% BANDWIDTH MEASUREMENT

8.1 Standard Applicable

For frequency hopping systems operating in the 2400 MHz-2483.5 MHz no limit for 20dB bandwidth.

8.2 Measurement Equipment Used

Conducted Emission Test Site					
EQUIPMENT TYPE	MFR	MODEL NUMBER	SERIAL NUMBER	LAST CAL.	CAL DUE.
EXA Spectrum Analyzer	Agilent	N9010A	MY50420195	05/06/2020	05/05/2021
DC Power Supply	Agilent	E3640A	MY52410006	12/17/2020	12/16/2021
DC Power Supply	Agilent	E3640A	KR93300208	08/19/2020	08/18/2021
DC Block	Mini-Circuits	BLK-18-S+	1	12/16/2020	12/15/2021

8.3 Test Set-up

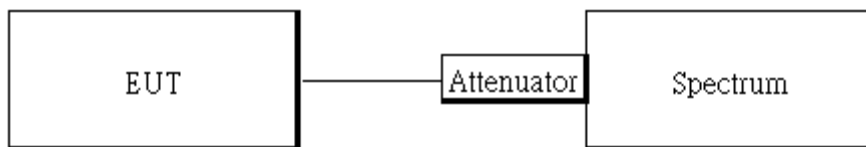

8.4 Measurement Procedure

1. Place the EUT on the table and set it in transmitting mode.
2. The testing follows ANSI C63.10:2013.
3. Remove the antenna from the EUT and then connect a low loss RF cable from the antenna port to the spectrum analyzer.
4. Set the spectrum analyzer as
 RBW= 1 % to 5% of OBW ,
 VBW = 3 X RBW,
 Span= 2 to 5 times of the OBW,
 Sweep=auto,
 Detector = Peak, and Max hold for 20dB Bandwidth test.
5. Mark the peak frequency and -20dB (upper and lower) frequency
6. Set the spectrum analyzer as
 RBW= 1 % to 5% of 99% Bandwidth ,
 VBW ≥ 3 X RBW,
 Span= large enough to capture all products of the modulation process,
 Sweep=auto,
 Detector = Peak, and Max hold for 99% Bandwidth test.
7. Mark the peak frequency and 99%dB (upper and lower) frequency
8. Repeat above procedures until all test default channel is completed

Unless otherwise stated the results shown in this test report refer only to the sample(s) tested and such sample(s) are retained for 90 days only.

除非另有說明，此報告結果僅對測試之樣品負責，同時此樣品僅保留90天。本報告未經本公司書面許可，不可部份複製。

This document is issued by the Company subject to its General Conditions of Service printed overleaf, available on request or accessible at <http://www.sgs.com.tw/Terms-and-Conditions> and for electronic format documents, subject to Terms and Conditions for Electronic Documents at <http://www.sgs.com.tw/Terms-and-Conditions>. Attention is drawn to the limitation of liability, indemnification and jurisdiction issues defined therein. Any holder of this document is advised that information contained hereon reflects the Company's findings at the time of its intervention only and within the limits of Client's instructions, if any. The Company's sole responsibility is to its Client and this document does not exonerate parties to a transaction from exercising all their rights and obligations under the transaction documents. This document cannot be reproduced except in full, without prior written approval of the Company. Any unauthorized alteration, forgery or falsification of the content or appearance of this document is unlawful and offenders may be prosecuted to the fullest extent of the law.

8.5 20dB Bandwidth

GFSK

CH	20 dB BW (MHz)	2/3 BW (MHz)
Low	0.8775	0.59
Mid	0.8776	0.59
High	0.8781	0.59

$\pi/4$ -DQPSK

CH	20 dB BW (MHz)	2/3 BW (MHz)
Low	1.284	0.86
Mid	1.284	0.86
High	1.303	0.87

8-DPSK

CH	20 dB BW (MHz)	2/3 BW (MHz)
Low	1.256	0.84
Mid	1.255	0.84
High	1.256	0.84

8.6 99% Bandwidth

GFSK

CH	99% BW (MHz)
Low	0.80711
Mid	0.80902
High	0.80825

$\pi/4$ -DQPSK

CH	99% BW (MHz)
Low	1.1772
Mid	1.1770
High	1.1771

8-DPSK

CH	99% BW (MHz)
Low	1.1795
Mid	1.1796
High	1.1794

Unless otherwise stated the results shown in this test report refer only to the sample(s) tested and such sample(s) are retained for 90 days only.

除非另有說明，此報告結果僅對測試之樣品負責，同時此樣品僅保留90天。本報告未經本公司書面許可，不可部份複製。

This document is issued by the Company subject to its General Conditions of Service printed overleaf, available on request or accessible at <http://www.sgs.com.tw/Terms-and-Conditions> and for electronic format documents, subject to Terms and Conditions for Electronic Documents at <http://www.sgs.com.tw/Terms-and-Conditions>. Attention is drawn to the limitation of liability, indemnification and jurisdiction issues defined therein. Any holder of this document is advised that information contained hereon reflects the Company's findings at the time of its intervention only and within the limits of Client's instructions, if any. The Company's sole responsibility is to its Client and this document does not exonerate parties to a transaction from exercising all their rights and obligations under the transaction documents. This document cannot be reproduced except in full, without prior written approval of the Company. Any unauthorized alteration, forgery or falsification of the content or appearance of this document is unlawful and offenders may be prosecuted to the fullest extent of the law.

GFSK 1M_DH5_2402MHz

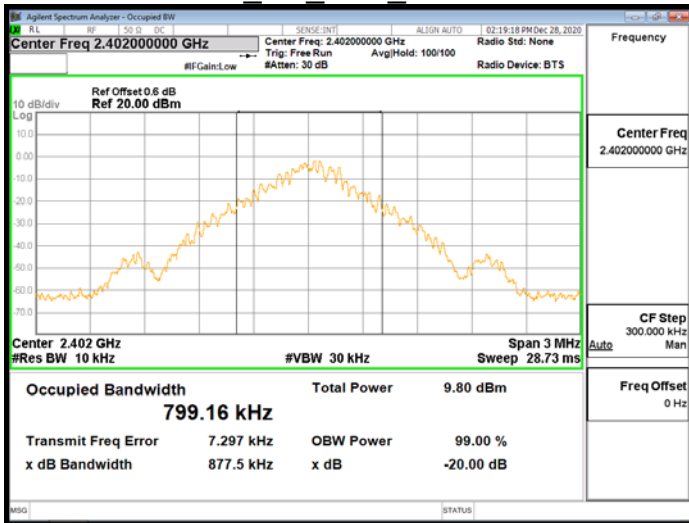

π /4DQPSK_2M_DH5_2402MHz

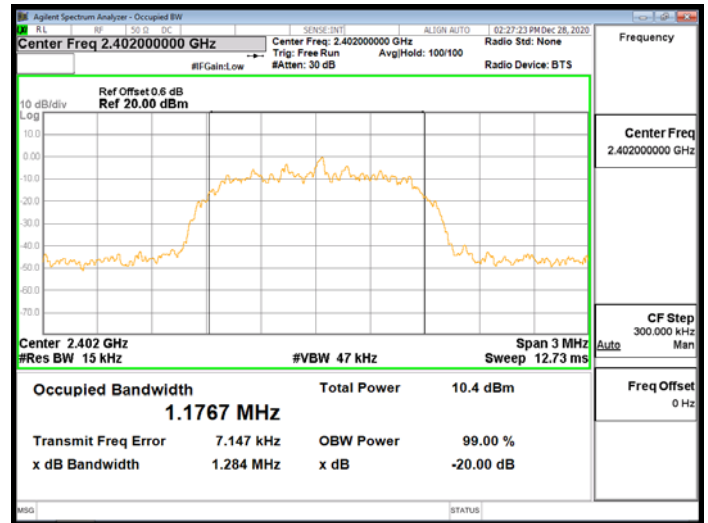

GFSK 1M_DH5_2441MHz

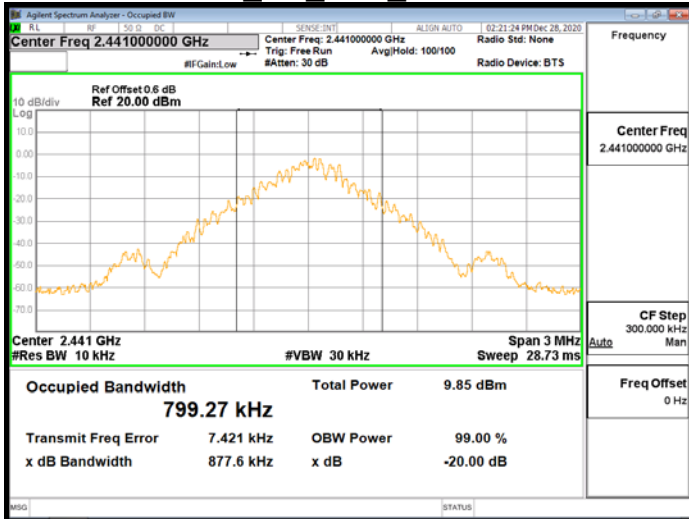

π /4DQPSK_2M_DH5_2441MHz

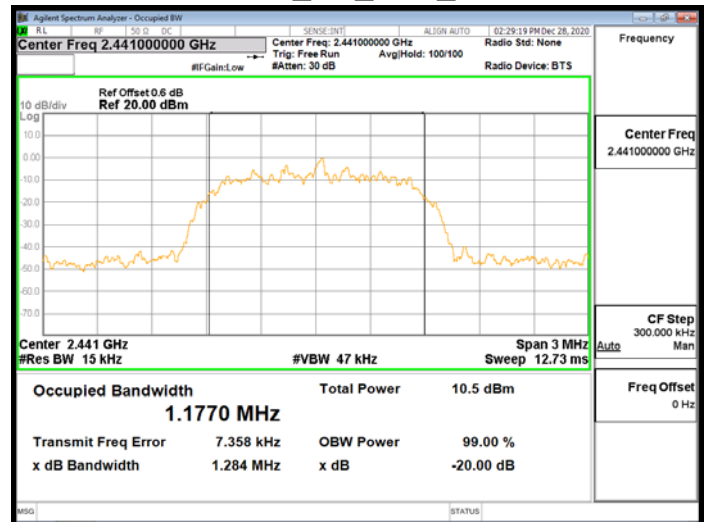

GFSK 1M_DH5_2480MHz

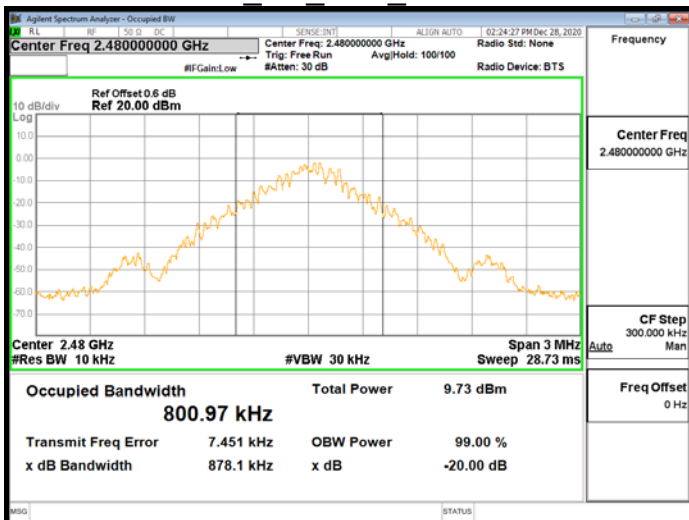

π /4DQPSK_2M_DH5_2480MHz

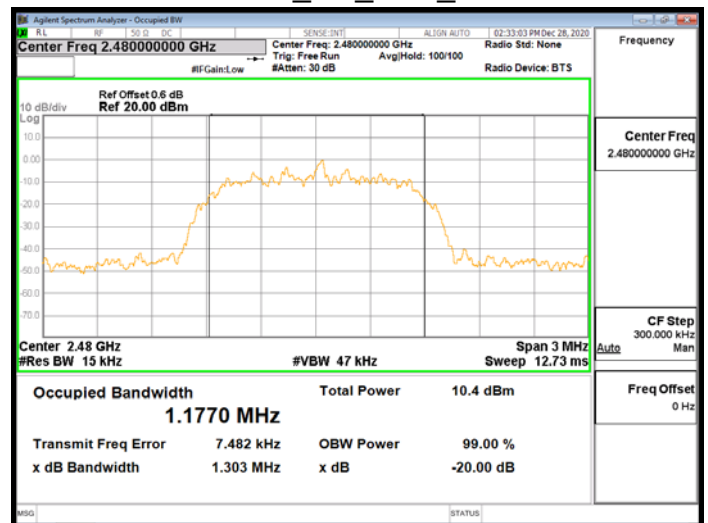

Unless otherwise stated the results shown in this test report refer only to the sample(s) tested and such sample(s) are retained for 90 days only.

除非另有說明，此報告結果僅對測試之樣品負責，同時此樣品僅保留90天。本報告未經本公司書面許可，不可部份複製。

This document is issued by the Company subject to its General Conditions of Service printed overleaf, available on request or accessible at <http://www.sgs.com.tw/Terms-and-Conditions> and for electronic format documents, subject to Terms and Conditions for Electronic Documents at <http://www.sgs.com.tw/Terms-and-Conditions>. Attention is drawn to the limitation of liability, indemnification and jurisdiction issues defined therein. Any holder of this document is advised that information contained hereon reflects the Company's findings at the time of its intervention only and within the limits of Client's instructions, if any. The Company's sole responsibility is to its Client and this document does not exonerate parties to a transaction from exercising all their rights and obligations under the transaction documents. This document cannot be reproduced except in full, without prior written approval of the Company. Any unauthorized alteration, forgery or falsification of the content or appearance of this document is unlawful and offenders may be prosecuted to the fullest extent of the law.

8DPSK 3M DH5 2402MHz

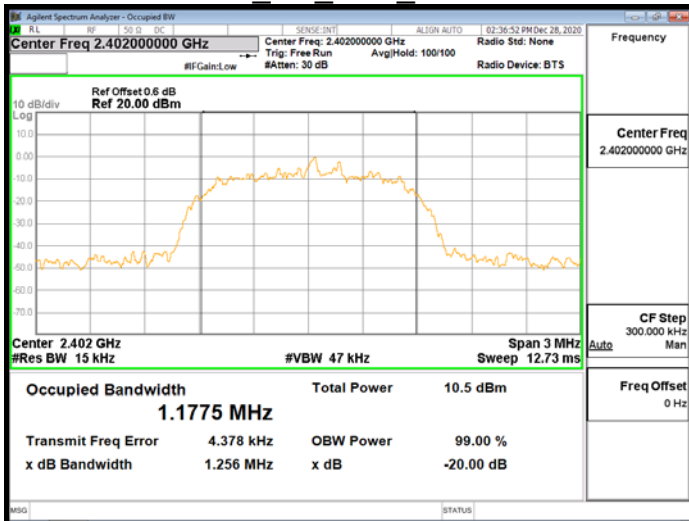

8DPSK 3M DH5 2441MHz

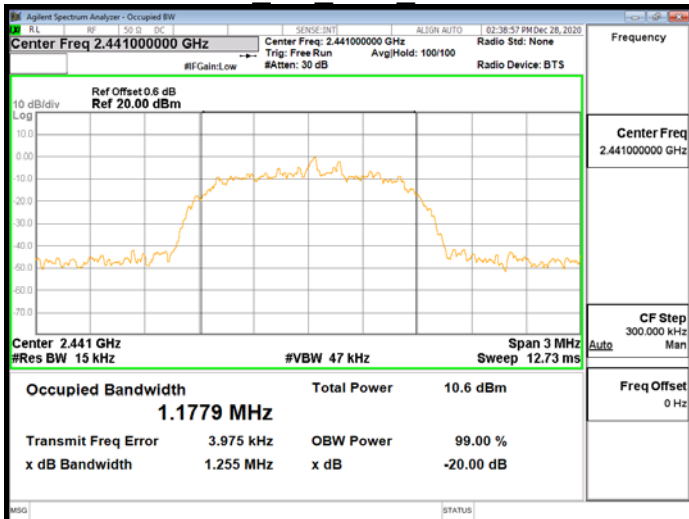

8DPSK 3M DH5 2480MHz

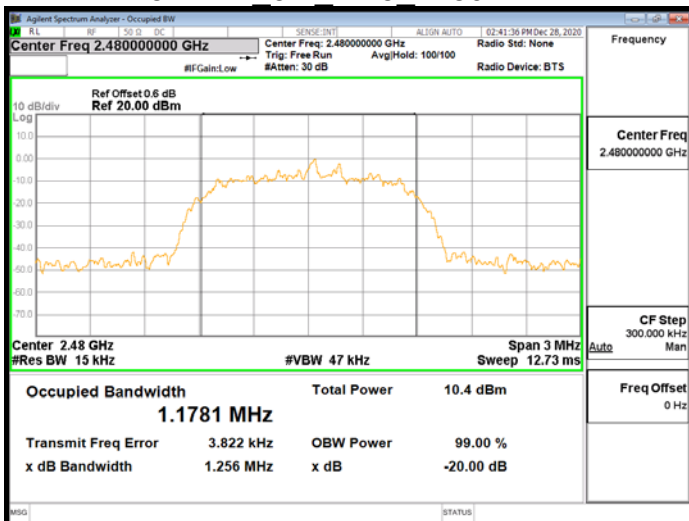

Unless otherwise stated the results shown in this test report refer only to the sample(s) tested and such sample(s) are retained for 90 days only.

除非另有說明，此報告結果僅對測試之樣品負責，同時此樣品僅保留90天。本報告未經本公司書面許可，不可部份複製。

This document is issued by the Company subject to its General Conditions of Service printed overleaf, available on request or accessible at <http://www.sgs.com.tw/Terms-and-Conditions> and for electronic format documents, subject to Terms and Conditions for Electronic Documents at <http://www.sgs.com.tw/Terms-and-Conditions>. Attention is drawn to the limitation of liability, indemnification and jurisdiction issues defined therein. Any holder of this document is advised that information contained hereon reflects the Company's findings at the time of its intervention only and within the limits of Client's instructions, if any. The Company's sole responsibility is to its Client and this document does not exonerate parties to a transaction from exercising all their rights and obligations under the transaction documents. This document cannot be reproduced except in full, without prior written approval of the Company. Any unauthorized alteration, forgery or falsification of the content or appearance of this document is unlawful and offenders may be prosecuted to the fullest extent of the law.

99% GFSK 1M DH5 2402MHz

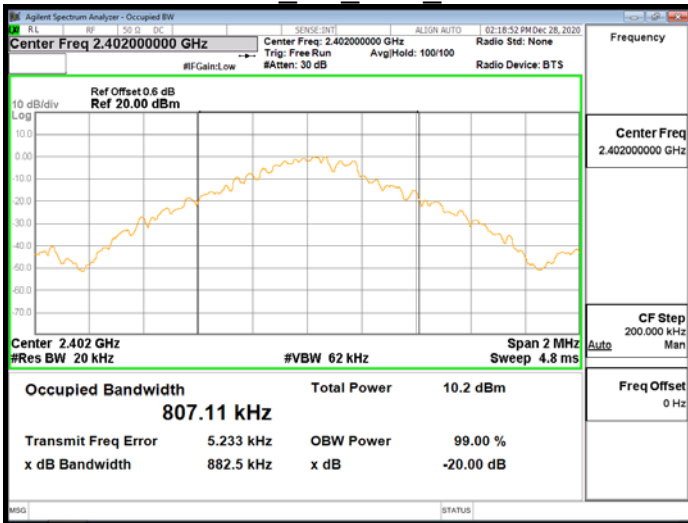

π /4DQPSK_2M_DH5_2402MHz

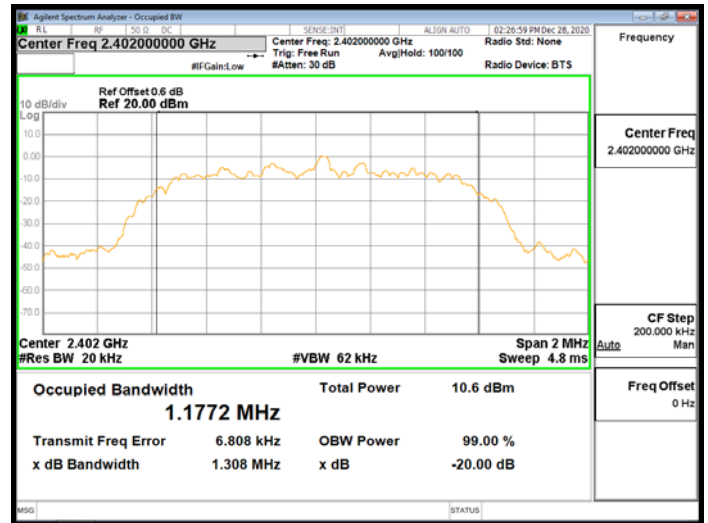

GFSK 1M DH5 2441MHz

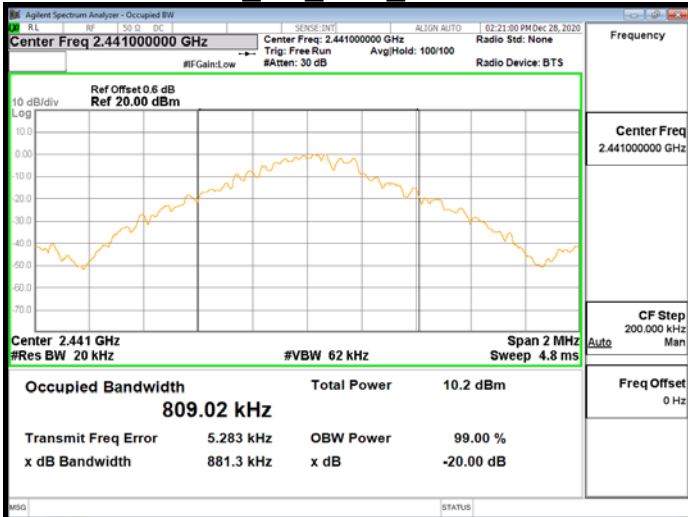

π /4DQPSK_2M_DH5_2441MHz

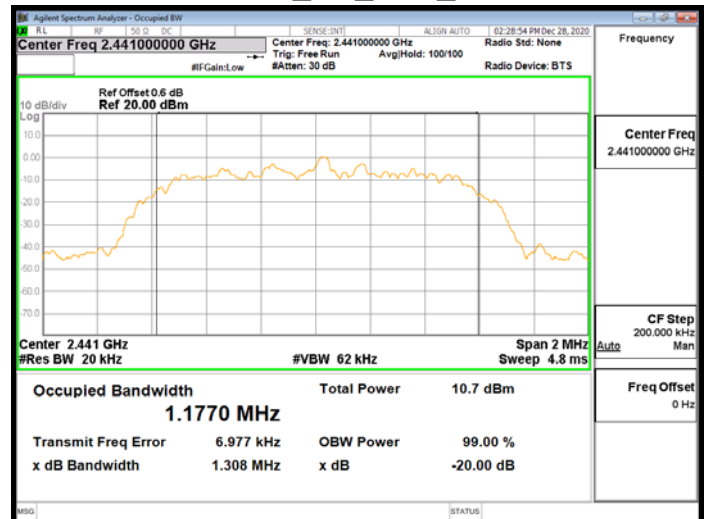

GFSK 1M DH5 2480MHz

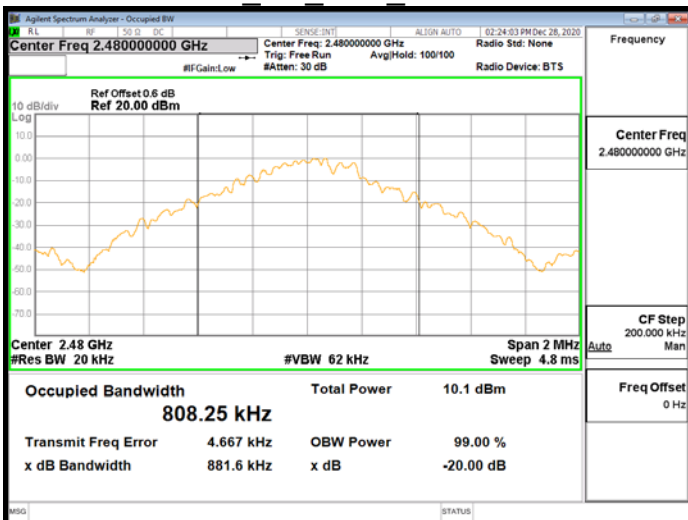

π /4DQPSK_2M_DH5_2480MHz

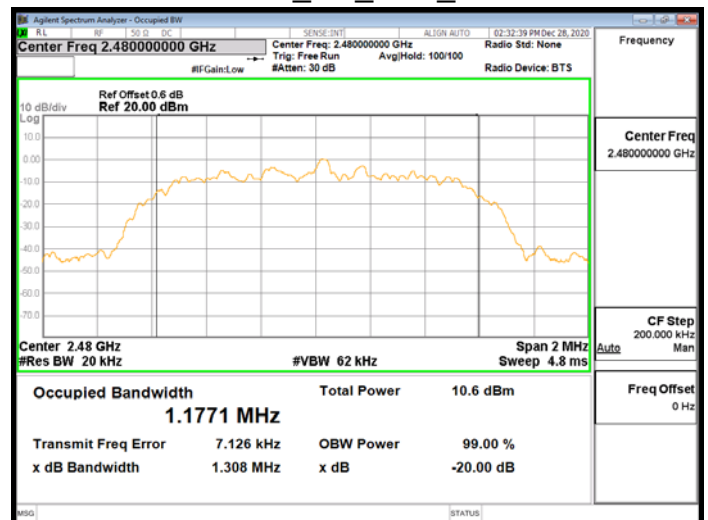

Unless otherwise stated the results shown in this test report refer only to the sample(s) tested and such sample(s) are retained for 90 days only.

除非另有說明，此報告結果僅對測試之樣品負責，同時此樣品僅保留90天。本報告未經本公司書面許可，不可部份複製。

This document is issued by the Company subject to its General Conditions of Service printed overleaf, available on request or accessible at <http://www.sgs.com.tw/Terms-and-Conditions> and for electronic format documents, subject to Terms and Conditions for Electronic Documents at <http://www.sgs.com.tw/Terms-and-Conditions>. Attention is drawn to the limitation of liability, indemnification and jurisdiction issues defined therein. Any holder of this document is advised that information contained hereon reflects the Company's findings at the time of its intervention only and within the limits of Client's instructions, if any. The Company's sole responsibility is to its Client and this document does not exonerate parties to a transaction from exercising all their rights and obligations under the transaction documents. This document cannot be reproduced except in full, without prior written approval of the Company. Any unauthorized alteration, forgery or falsification of the content or appearance of this document is unlawful and offenders may be prosecuted to the fullest extent of the law.

8DPSK 3M DH5 2402MHz

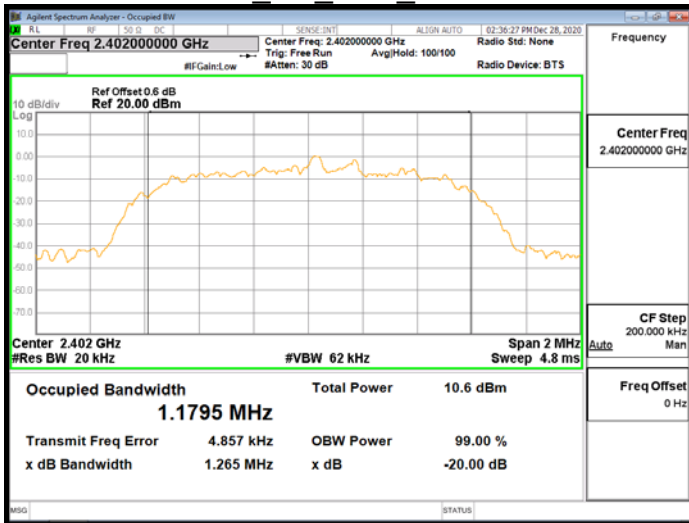

8DPSK 3M DH5 2441MHz

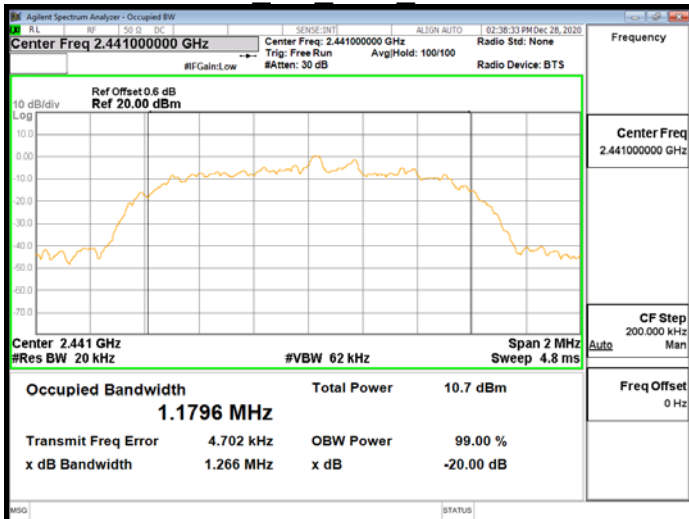

8DPSK 3M DH5 2480MHz

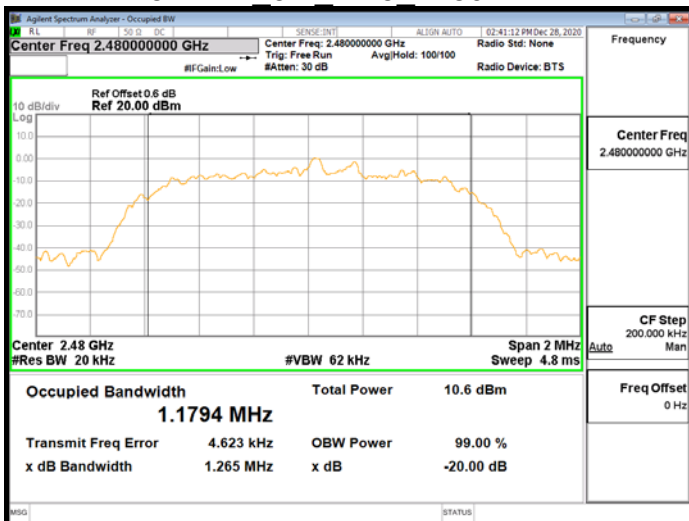

Unless otherwise stated the results shown in this test report refer only to the sample(s) tested and such sample(s) are retained for 90 days only.

除非另有說明，此報告結果僅對測試之樣品負責，同時此樣品僅保留90天。本報告未經本公司書面許可，不可部份複製。

This document is issued by the Company subject to its General Conditions of Service printed overleaf, available on request or accessible at <http://www.sgs.com.tw/Terms-and-Conditions> and for electronic format documents, subject to Terms and Conditions for Electronic Documents at <http://www.sgs.com.tw/Terms-and-Conditions>. Attention is drawn to the limitation of liability, indemnification and jurisdiction issues defined therein. Any holder of this document is advised that information contained hereon reflects the Company's findings at the time of its intervention only and within the limits of Client's instructions, if any. The Company's sole responsibility is to its Client and this document does not exonerate parties to a transaction from exercising all their rights and obligations under the transaction documents. This document cannot be reproduced except in full, without prior written approval of the Company. Any unauthorized alteration, forgery or falsification of the content or appearance of this document is unlawful and offenders may be prosecuted to the fullest extent of the law.

9 CONDUCTED BAND EDGES AND SPURIOUS EMISSION MEASUREMENT

9.1 Standard Applicable

In any 100 kHz bandwidth outside the frequency band in which the spread spectrum or digitally modulated intentional radiator is operating, the radio frequency power that is produced by the intentional radiator shall be at least 20 dB below that in the 100 kHz bandwidth within the band that contains the highest level of the desired power, based on either an RF conducted or a radiated measurement, provided the transmitter demonstrates compliance with the peak conducted power limits. In addition, radiated emissions which fall in the restricted bands, as defined in §15.205(a) & RSS-Gen §8.10, must also comply with the radiated emission limits specified in §15.209(a) & RSS-Gen §8.9.

9.2 Measurement Equipment Used

Conducted Emission Test Site					
EQUIPMENT TYPE	MFR	MODEL NUMBER	SERIAL NUMBER	LAST CAL.	CAL DUE.
EXA Spectrum Analyzer	Agilent	N9010A	MY50420195	05/06/2020	05/05/2021
DC Power Supply	Agilent	E3640A	MY52410006	12/17/2020	12/16/2021
DC Power Supply	Agilent	E3640A	KR93300208	08/19/2020	08/18/2021
DC Block	Mini-Circuits	BLK-18-S+	1	12/16/2020	12/15/2021

9.3 Test SET-UP

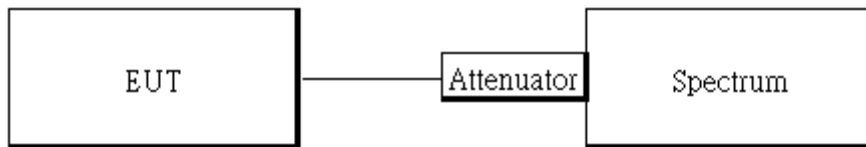

Unless otherwise stated the results shown in this test report refer only to the sample(s) tested and such sample(s) are retained for 90 days only.

除非另有說明，此報告結果僅對測試之樣品負責，同時此樣品僅保留90天。本報告未經本公司書面許可，不可部份複製。

This document is issued by the Company subject to its General Conditions of Service printed overleaf, available on request or accessible at <http://www.sgs.com.tw/Terms-and-Conditions> and for electronic format documents, subject to Terms and Conditions for Electronic Documents at <http://www.sgs.com.tw/Terms-and-Conditions>. Attention is drawn to the limitation of liability, indemnification and jurisdiction issues defined therein. Any holder of this document is advised that information contained hereon reflects the Company's findings at the time of its intervention only and within the limits of Client's instructions, if any. The Company's sole responsibility is to its Client and this document does not exonerate parties to a transaction from exercising all their rights and obligations under the transaction documents. This document cannot be reproduced except in full, without prior written approval of the Company. Any unauthorized alteration, forgery or falsification of the content or appearance of this document is unlawful and offenders may be prosecuted to the fullest extent of the law.

9.4 Measurement Procedure

9.4.1 Conducted Band Edge:

1. Place the EUT on the table and set it in transmitting mode.
2. The testing follows ANSI C63.10:2013.
3. Remove the antenna from the EUT and then connect a low loss RF cable from the antenna port to the spectrum analyzer.
4. Set center frequency of spectrum analyzer = operating frequency.
5. Set the spectrum analyzer as RBW=100 kHz, VBW=300 kHz, Sweep = auto
6. Mark Peak, 2.3999GHz and 2.4836GHz and record the max. level.
7. Repeat above procedures until all frequency measured were complete.

9.4.2 Conducted Spurious Emission:

1. To connect Antenna Port of EUT to Spectrum.
2. The testing follows ANSI C63.10:2013.
3. Set RBW = 100 kHz & VBW = 300 kHz, Detector =Peak, Sweep = Auto
4. Allow trace to fully stabilize.
5. Use the peak marker function to determine the maximum power level in any 100 kHz band segment within the fundamental EBW.
6. Repeat above procedures until all default test channel measured were complete.

9.5 Measurement Result

See next page for test plots.

Unless otherwise stated the results shown in this test report refer only to the sample(s) tested and such sample(s) are retained for 90 days only.

除非另有說明，此報告結果僅對測試之樣品負責，同時此樣品僅保留90天。本報告未經本公司書面許可，不可部份複製。

This document is issued by the Company subject to its General Conditions of Service printed overleaf, available on request or accessible at <http://www.sgs.com.tw/Terms-and-Conditions> and for electronic format documents, subject to Terms and Conditions for Electronic Documents at <http://www.sgs.com.tw/Terms-and-Conditions>. Attention is drawn to the limitation of liability, indemnification and jurisdiction issues defined therein. Any holder of this document is advised that information contained hereon reflects the Company's findings at the time of its intervention only and within the limits of Client's instructions, if any. The Company's sole responsibility is to its Client and this document does not exonerate parties to a transaction from exercising all their rights and obligations under the transaction documents. This document cannot be reproduced except in full, without prior written approval of the Company. Any unauthorized alteration, forgery or falsification of the content or appearance of this document is unlawful and offenders may be prosecuted to the fullest extent of the law.

Non-Hopping
GFSK 1M DH5 2402MHz

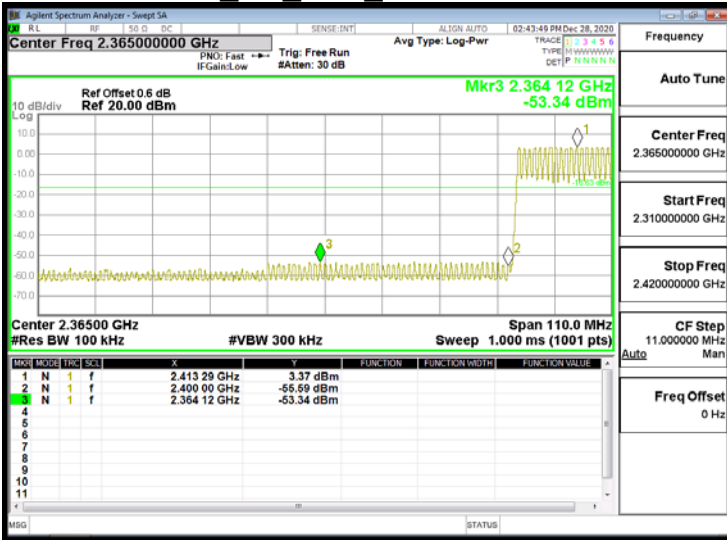

8DPSK 3M DH5 2402MHz

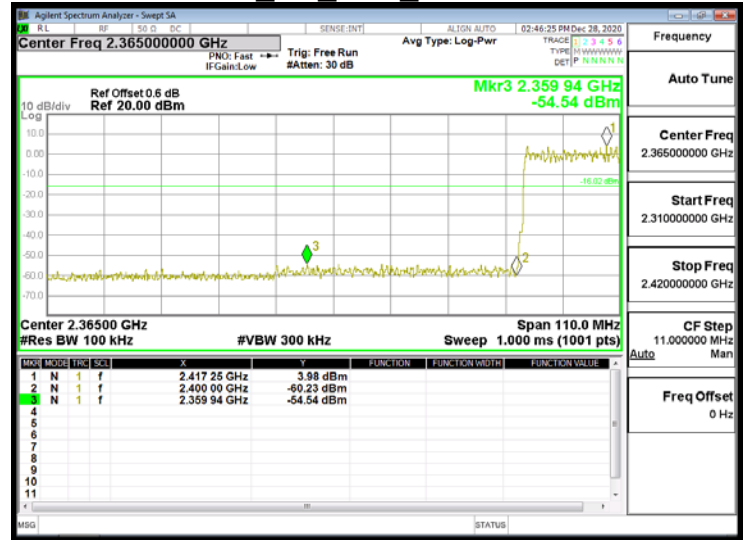

GFSK 1M DH5 2480MHz

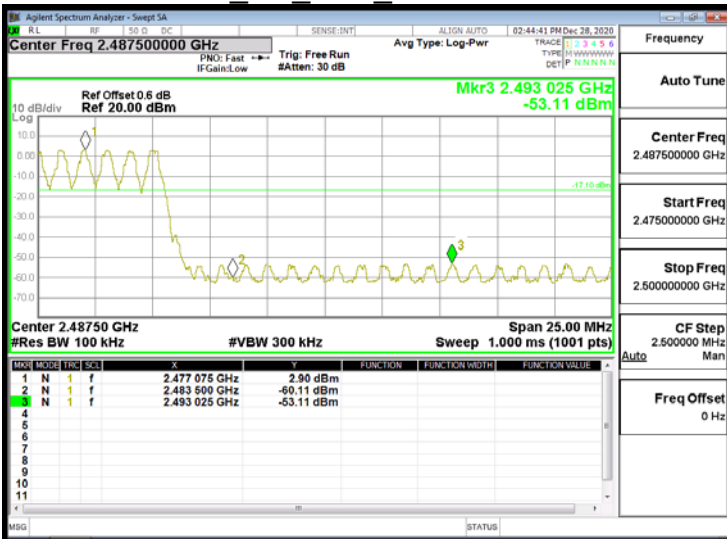

8DPSK 3M DH5 2480MHz

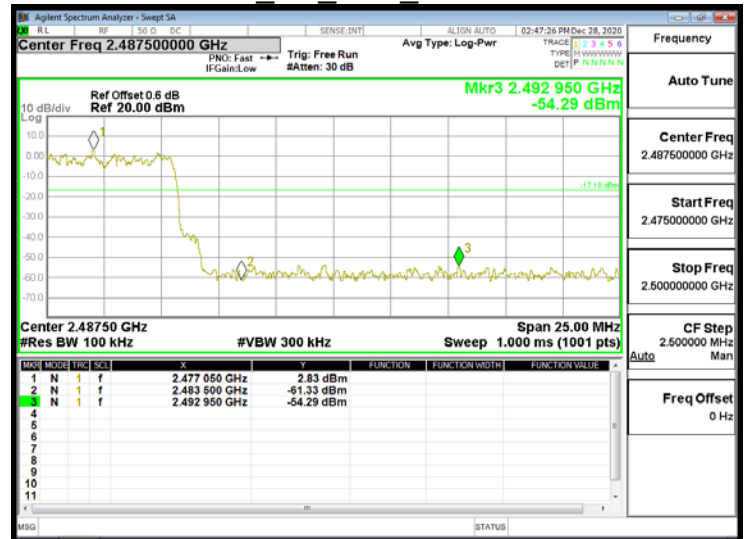

Unless otherwise stated the results shown in this test report refer only to the sample(s) tested and such sample(s) are retained for 90 days only.

除非另有說明，此報告結果僅對測試之樣品負責，同時此樣品僅保留90天。本報告未經本公司書面許可，不可部份複製。

This document is issued by the Company subject to its General Conditions of Service printed overleaf, available on request or accessible at <http://www.sgs.com.tw/Terms-and-Conditions> and for electronic format documents, subject to Terms and Conditions for Electronic Documents at <http://www.sgs.com.tw/Terms-and-Conditions>. Attention is drawn to the limitation of liability, indemnification and jurisdiction issues defined therein. Any holder of this document is advised that information contained hereon reflects the Company's findings at the time of its intervention only and within the limits of Client's instructions, if any. The Company's sole responsibility is to its Client and this document does not exonerate parties to a transaction from exercising all their rights and obligations under the transaction documents. This document cannot be reproduced except in full, without prior written approval of the Company. Any unauthorized alteration, forgery or falsification of the content or appearance of this document is unlawful and offenders may be prosecuted to the fullest extent of the law.

Hopping GFSK 1M DH5 2402MHz

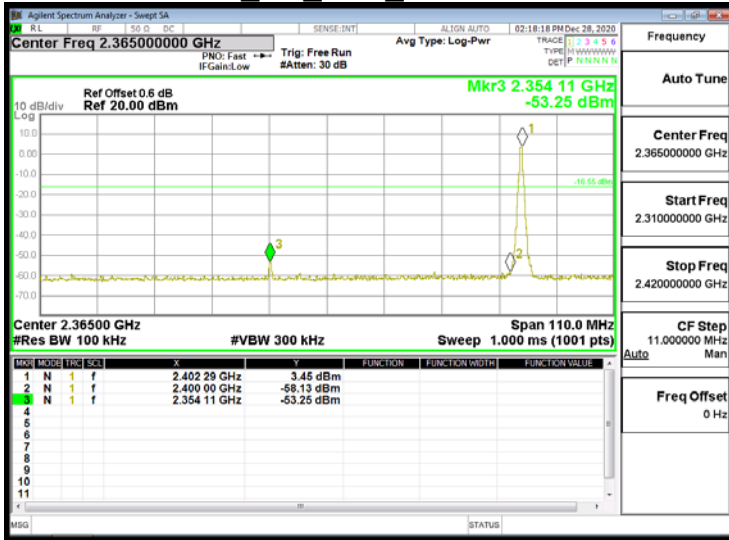

8DPSK 3M DH5 2402MHz

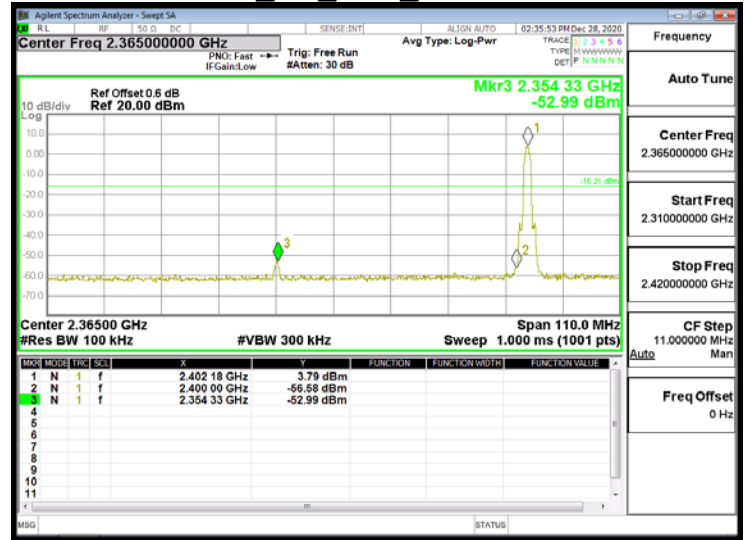

GFSK 1M DH5 2480MHz

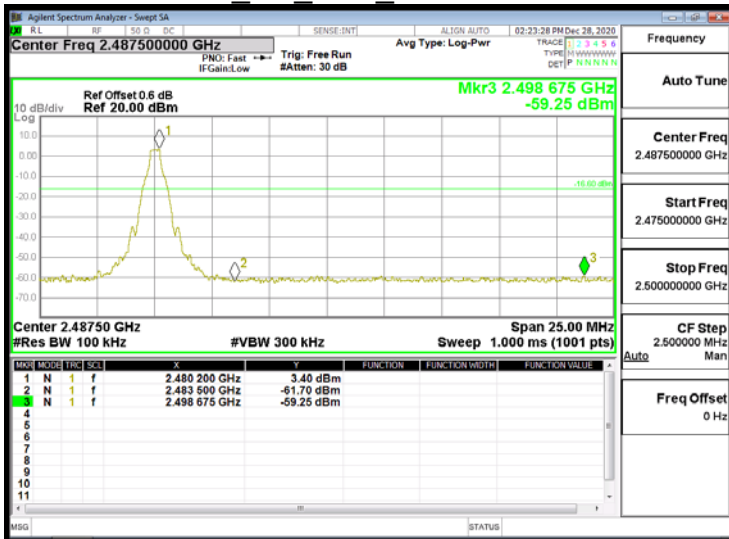

8DPSK 3M DH5 2480MHz

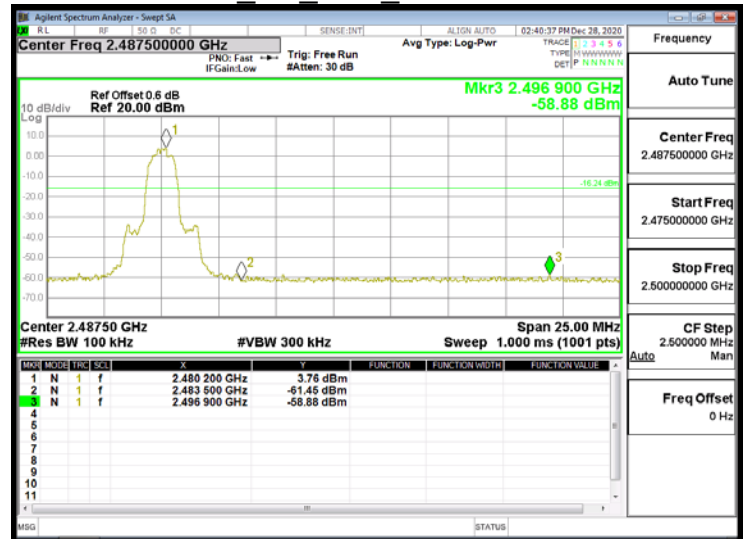

Unless otherwise stated the results shown in this test report refer only to the sample(s) tested and such sample(s) are retained for 90 days only.

除非另有說明，此報告結果僅對測試之樣品負責，同時此樣品僅保留90天。本報告未經本公司書面許可，不可部份複製。

This document is issued by the Company subject to its General Conditions of Service printed overleaf, available on request or accessible at <http://www.sgs.com.tw/Terms-and-Conditions> and for electronic format documents, subject to Terms and Conditions for Electronic Documents at <http://www.sgs.com.tw/Terms-and-Conditions>. Attention is drawn to the limitation of liability, indemnification and jurisdiction issues defined therein. Any holder of this document is advised that information contained hereon reflects the Company's findings at the time of its intervention only and within the limits of Client's instructions, if any. The Company's sole responsibility is to its Client and this document does not exonerate parties to a transaction from exercising all their rights and obligations under the transaction documents. This document cannot be reproduced except in full, without prior written approval of the Company. Any unauthorized alteration, forgery or falsification of the content or appearance of this document is unlawful and offenders may be prosecuted to the fullest extent of the law.

GFSK 1M DH5 2402MHz

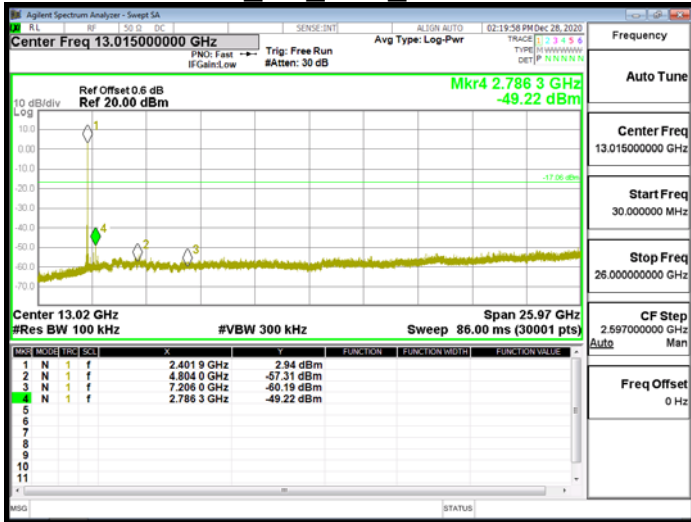

$\pi/4$ DQPSK_2M_DH5_2402MHz

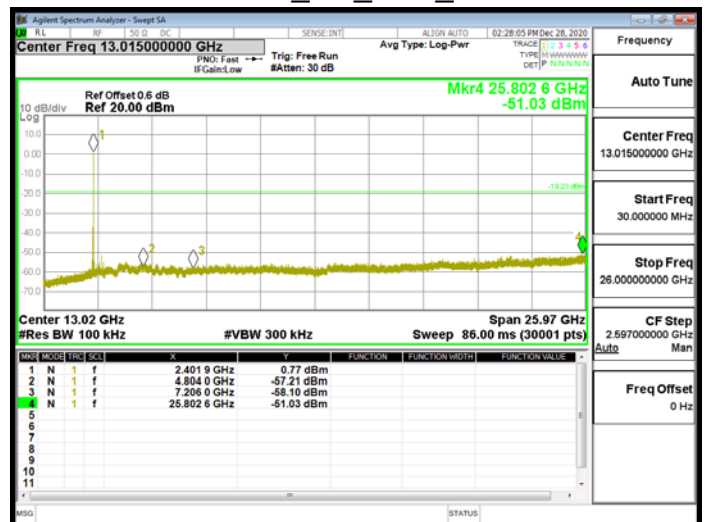

GFSK 1M DH5 2441MHz

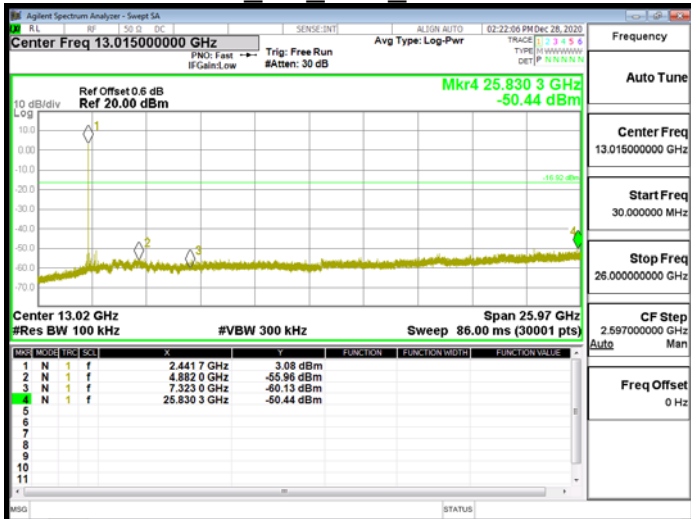

$\pi/4$ DQPSK_2M_DH5_2441MHz

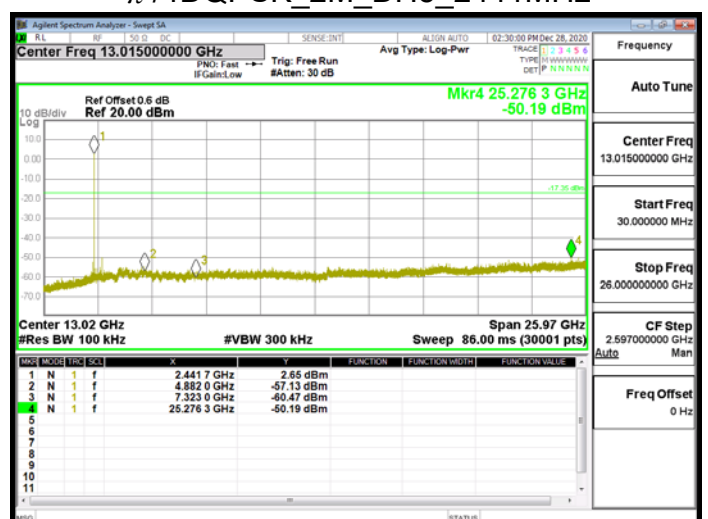

GFSK 1M DH5 2480MHz

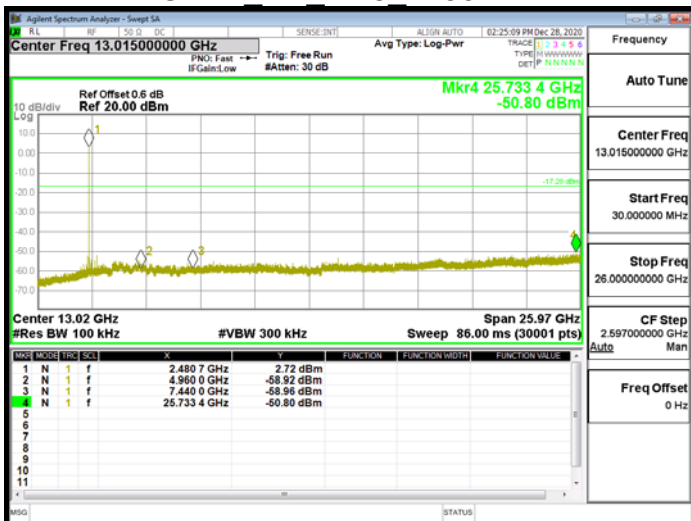

$\pi/4$ DQPSK_2M_DH5_2480MHz

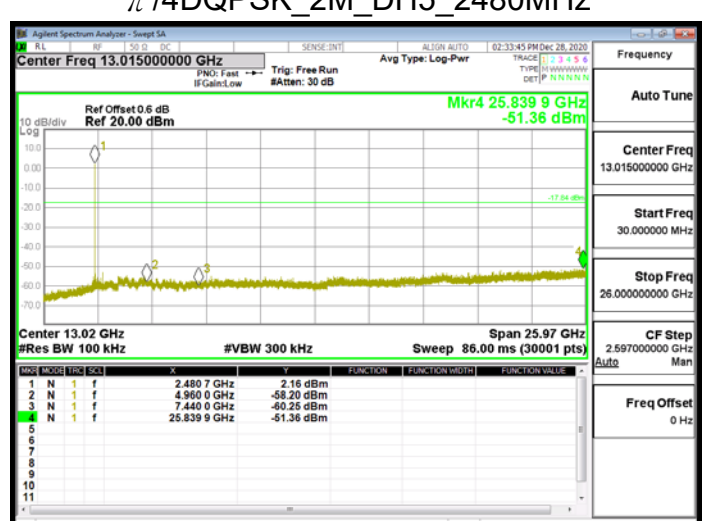

Unless otherwise stated the results shown in this test report refer only to the sample(s) tested and such sample(s) are retained for 90 days only.

除非另有說明，此報告結果僅對測試之樣品負責，同時此樣品僅保留90天。本報告未經本公司書面許可，不可部份複製。

This document is issued by the Company subject to its General Conditions of Service printed overleaf, available on request or accessible at <http://www.sgs.com.tw/Terms-and-Conditions> and for electronic format documents, subject to Terms and Conditions for Electronic Documents at <http://www.sgs.com.tw/Terms-and-Conditions>. Attention is drawn to the limitation of liability, indemnification and jurisdiction issues defined therein. Any holder of this document is advised that information contained hereon reflects the Company's findings at the time of its intervention only and within the limits of Client's instructions, if any. The Company's sole responsibility is to its Client and this document does not exonerate parties to a transaction from exercising all their rights and obligations under the transaction documents. This document cannot be reproduced except in full, without prior written approval of the Company. Any unauthorized alteration, forgery or falsification of the content or appearance of this document is unlawful and offenders may be prosecuted to the fullest extent of the law.

8DPSK 3M DH5 2402MHz

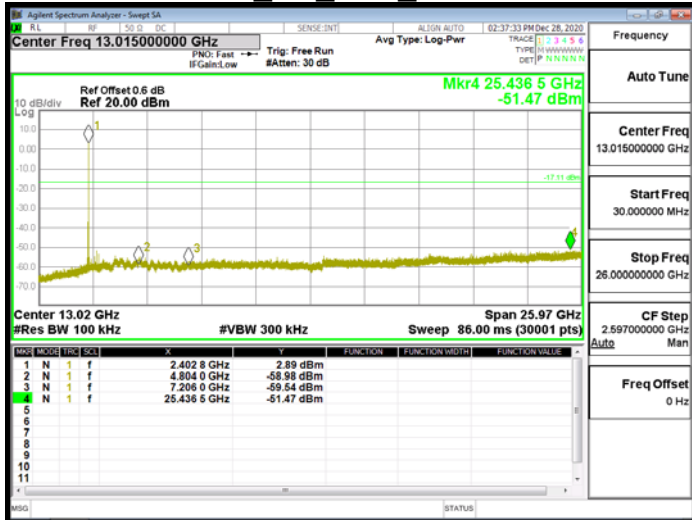

8DPSK 3M DH5 2441MHz

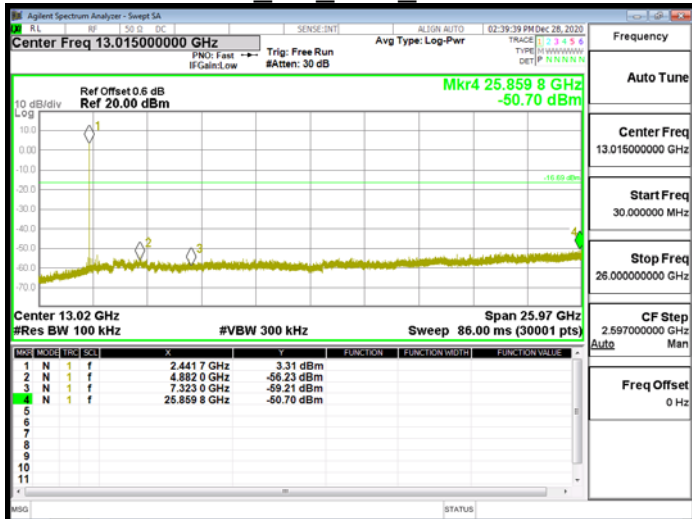

8DPSK 3M DH5 2480MHz

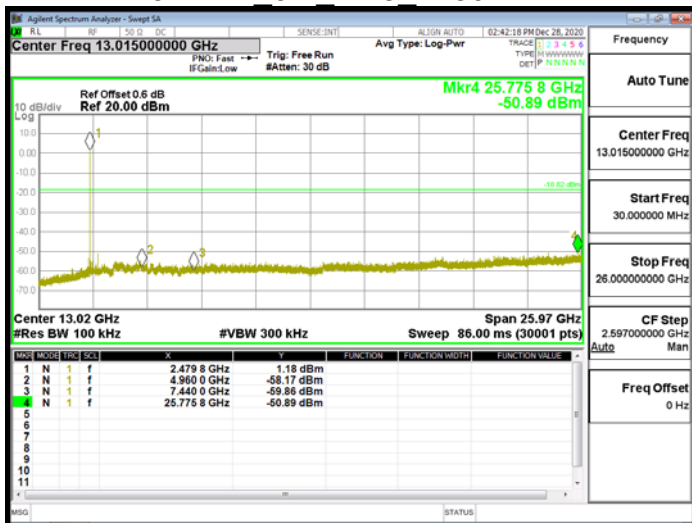

Unless otherwise stated the results shown in this test report refer only to the sample(s) tested and such sample(s) are retained for 90 days only.

除非另有說明，此報告結果僅對測試之樣品負責，同時此樣品僅保留90天。本報告未經本公司書面許可，不可部份複製。

This document is issued by the Company subject to its General Conditions of Service printed overleaf, available on request or accessible at <http://www.sgs.com.tw/Terms-and-Conditions> and for electronic format documents, subject to Terms and Conditions for Electronic Documents at <http://www.sgs.com.tw/Terms-and-Conditions>. Attention is drawn to the limitation of liability, indemnification and jurisdiction issues defined therein. Any holder of this document is advised that information contained hereon reflects the Company's findings at the time of its intervention only and within the limits of Client's instructions, if any. The Company's sole responsibility is to its Client and this document does not exonerate parties to a transaction from exercising all their rights and obligations under the transaction documents. This document cannot be reproduced except in full, without prior written approval of the Company. Any unauthorized alteration, forgery or falsification of the content or appearance of this document is unlawful and offenders may be prosecuted to the fullest extent of the law.

10 RADIATED BANDEDGE AND SPURIOUS EMISSION MEASUREMENT

10.1 Standard Applicable

In any 100 kHz bandwidth outside the frequency band in which the spread spectrum or digitally modulated intentional radiator is operating, the radio frequency power that is produced by the intentional radiator shall be at least 20 dB below that in the 100 kHz bandwidth within the band that contains the highest level of the desired power, based on either an RF conducted or a radiated measurement, provided the transmitter demonstrates compliance with the peak conducted power limits. In addition, radiated emissions which fall in the restricted bands must also comply with the §15.209 and RSS-Gen §8.9 Table 5 and 6 limit as below.

And according to §15.33(a) (1) & RSS-Gen §6.13.2.a, for an intentional radiator operates below 10GHz, the frequency range of measurements: to the tenth harmonic of the highest fundamental frequency or to 40GHz, whichever is lower.

Frequency (MHz)	Field strength (microvolts/meter)	Distance (meters)
0.009-0.490	2400/F(kHz)	300
0.490-1.705	24000/F(kHz)	30
1.705-30	30	30
30-88	100	3
88-216	150	3
216-960	200	3
Above 960	500	3

Note:

1. The lower limit shall apply at the transition frequencies.
2. Emission level (dBµV/m) = 20 log Emission level (µV/m)

Unless otherwise stated the results shown in this test report refer only to the sample(s) tested and such sample(s) are retained for 90 days only.

除非另有說明，此報告結果僅對測試之樣品負責，同時此樣品僅保留90天。本報告未經本公司書面許可，不可部份複製。

This document is issued by the Company subject to its General Conditions of Service printed overleaf, available on request or accessible at <http://www.sgs.com.tw/Terms-and-Conditions> and for electronic format documents, subject to Terms and Conditions for Electronic Documents at <http://www.sgs.com.tw/Terms-and-Conditions>. Attention is drawn to the limitation of liability, indemnification and jurisdiction issues defined therein. Any holder of this document is advised that information contained hereon reflects the Company's findings at the time of its intervention only and within the limits of Client's instructions, if any. The Company's sole responsibility is to its Client and this document does not exonerate parties to a transaction from exercising all their rights and obligations under the transaction documents. This document cannot be reproduced except in full, without prior written approval of the Company. Any unauthorized alteration, forgery or falsification of the content or appearance of this document is unlawful and offenders may be prosecuted to the fullest extent of the law.

10.2 Measurement Equipment Used

966 Chamber					
EQUIPMENT TYPE	MFR	MODEL NUMBER	SERIAL NUMBER	LAST CAL.	CAL DUE.
Horn Antenna	Schwarzbeck	BBHA9170	184	12/11/2020	12/10/2021
Horn Antenna	Schwarzbeck	BBHA9120D	1441	10/16/2020	10/15/2021
Bi-log Antenna	SCHWAZBECK	VULB9168	378	08/06/2020	08/05/2021
Loop Antenna	ETS.LINDGREN	6502	148045	10/19/2020	10/18/2021
PXA Spectrum Analyzer	Agilent	N9030A	MY53120760	04/21/2020	04/20/2021
EMI Test Receiver	R&S	ESCI 7	100759	07/13/2020	07/12/2021
Pre-Amplifier	HP	8449B	3008A00578	12/16/2020	12/15/2021
Pre-Amplifier	EMC Instruments	EMC184045B	980135	12/16/2020	12/15/2021
Pre-Amplifier	HP	8447D	2944A07676	12/16/2020	12/15/2021
Attenuator	Mini-Circuit	BW-S10W2+	4	12/16/2020	12/15/2021
Filter 2400-2483.5 MHz	EWT	EWT-14-0166	M1	12/16/2020	12/15/2021
High Pass Filter	WI	WHKX4.0/18G-10SS	22	12/16/2020	12/15/2021
Coaxial Cable	Huber Suhner	SUCOFLEX 102	MY2636/2	12/16/2020	12/15/2021
Coaxial Cable	Huber Suhner	SUCOFLEX 104	340057/4	12/16/2020	12/15/2021
Coaxial Cable	Huber Suhner	SUCOFLEX 104PEA	800052/2	12/16/2020	12/15/2021
Coaxial Cable	Huber Suhner	SUCOFLEX 102	MY2621/2	12/16/2020	12/15/2021
Coaxial Cable	Huber Suhner	SUCOFLEX 102	MY2617/2	12/16/2020	12/15/2021
Test Software	audix	e3	Ver. 6.11-20180413	N.C.R	N.C.R
Site Cal	SGS	SAC III chamber	N/A	01/01/2021	12/31/2021
DC Power Supply	Agilent	E3640A	KR93300208	08/19/2020	08/18/2021
DC Power Supply	Agilent	E3640A	MY40005907	10/29/2020	10/28/2021

NOTE: N.C.R refers to Not Calibrated Required.

Unless otherwise stated the results shown in this test report refer only to the sample(s) tested and such sample(s) are retained for 90 days only.

除非另有說明，此報告結果僅對測試之樣品負責，同時此樣品僅保留90天。本報告未經本公司書面許可，不可部份複製。

This document is issued by the Company subject to its General Conditions of Service printed overleaf, available on request or accessible at <http://www.sgs.com.tw/Terms-and-Conditions> and for electronic format documents, subject to Terms and Conditions for Electronic Documents at <http://www.sgs.com.tw/Terms-and-Conditions>. Attention is drawn to the limitation of liability, indemnification and jurisdiction issues defined therein. Any holder of this document is advised that information contained hereon reflects the Company's findings at the time of its intervention only and within the limits of Client's instructions, if any. The Company's sole responsibility is to its Client and this document does not exonerate parties to a transaction from exercising all their rights and obligations under the transaction documents. This document cannot be reproduced except in full, without prior written approval of the Company. Any unauthorized alteration, forgery or falsification of the content or appearance of this document is unlawful and offenders may be prosecuted to the fullest extent of the law.

10.3 Test SET-UP

(A) Radiated Emission Test Set-UP Frequency Below 30MHz.

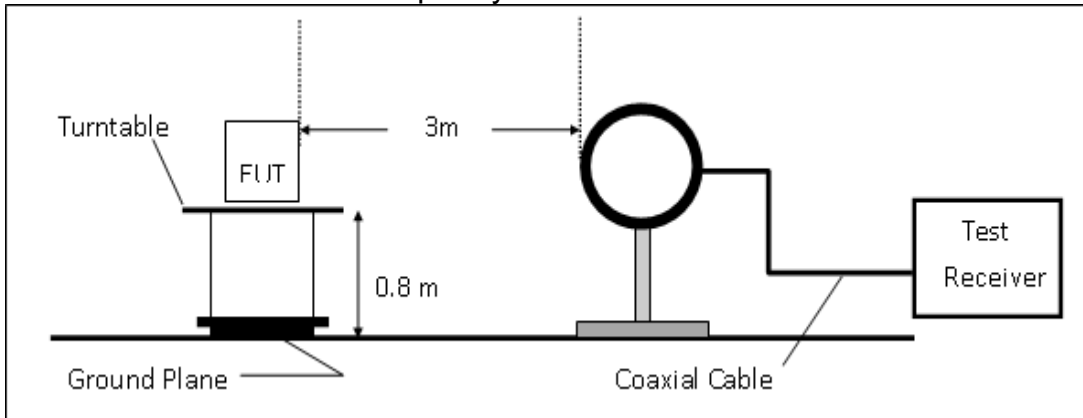

(B) Radiated Emission Test Set-Up, Frequency form 30MHz to 1000MHz

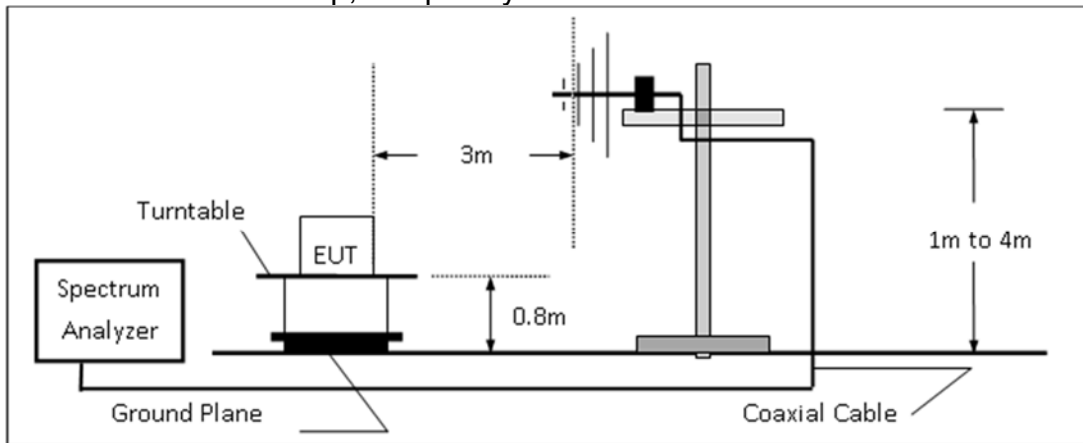

(C) Radiated Emission Test Set-UP Frequency Over 1 GHz

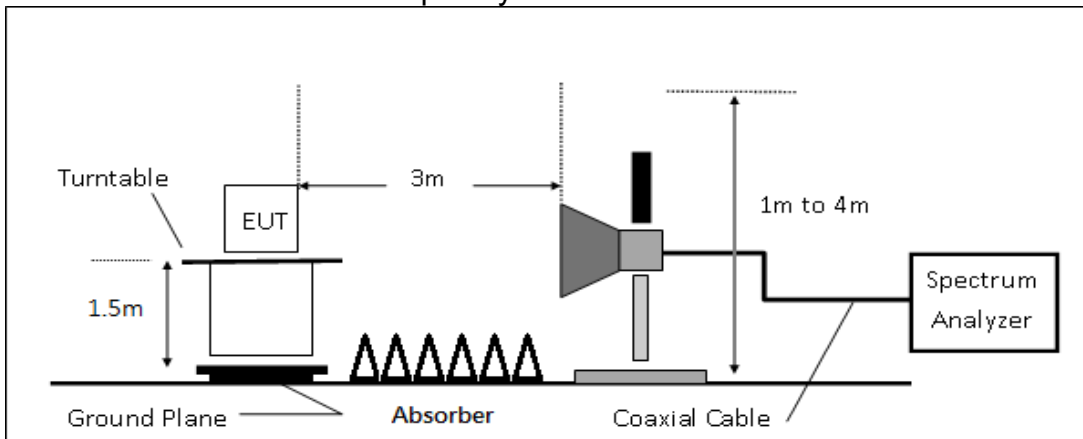

Unless otherwise stated the results shown in this test report refer only to the sample(s) tested and such sample(s) are retained for 90 days only.

除非另有說明，此報告結果僅對測試之樣品負責，同時此樣品僅保留90天。本報告未經本公司書面許可，不可部份複製。

This document is issued by the Company subject to its General Conditions of Service printed overleaf, available on request or accessible at <http://www.sgs.com.tw/Terms-and-Conditions> and for electronic format documents, subject to Terms and Conditions for Electronic Documents at <http://www.sgs.com.tw/Terms-and-Conditions>. Attention is drawn to the limitation of liability, indemnification and jurisdiction issues defined therein. Any holder of this document is advised that information contained hereon reflects the Company's findings at the time of its intervention only and within the limits of Client's instructions, if any. The Company's sole responsibility is to its Client and this document does not exonerate parties to a transaction from exercising all their rights and obligations under the transaction documents. This document cannot be reproduced except in full, without prior written approval of the Company. Any unauthorized alteration, forgery or falsification of the content or appearance of this document is unlawful and offenders may be prosecuted to the fullest extent of the law.

10.4 Measurement Procedure

10.4.1 Radiated Emission

1. The testing follows the Measurement Procedure of ANSI C63.10:2013.
2. The EUT was placed on a turn table with 0.8m for frequency < 1GHz and 1.5m for frequency > 1GHz above ground plan.
3. The turn table shall rotate 360 degrees to determine the position of maximum emission level.
4. EUT is set 3m away from the receiving antenna which varied from 1m to 4m to find out the highest emissions.
5. Set the spectrum analyzer as RBW=120 kHz and VBW=300 kHz for Peak Detector (PK) and Quasi-peak (QP) at frequency below 1 GHz.
6. Set the spectrum analyzer as RBW=1 MHz, VBW=3 MHz for Peak Detector at frequency above 1 GHz.
7. Set the spectrum analyzer as RBW=1 MHz, VBW=10 Hz (Duty cycle > 98%) or VBW ≥ 1/T (Duty cycle < 98%) for Average Detector at frequency above 1 GHz.
8. When measurement procedures for electric field radiated emissions above 1 GHz the EUT measurement is to be made “while keeping the antenna in the ‘cone of radiation’ from that area and pointed at the area both in azimuth and elevation, with polarization oriented for maximum response.” is still within the 3dB illumination BW of the measurement antenna.
9. Maximum procedure was performed on the six highest emissions to ensure EUT compliance.
10. And also, each emission was to be maximized by changing the polarization of receiving antenna both horizontal and vertical. On spectrum, change spectrum mode in linear display mode, and reduce VBW = 10Hz if average reading is measured.
11. Repeat above procedures until all default test channel measured were complete.

Unless otherwise stated the results shown in this test report refer only to the sample(s) tested and such sample(s) are retained for 90 days only.

除非另有說明，此報告結果僅對測試之樣品負責，同時此樣品僅保留90天。本報告未經本公司書面許可，不可部份複製。

This document is issued by the Company subject to its General Conditions of Service printed overleaf, available on request or accessible at <http://www.sgs.com.tw/Terms-and-Conditions> and for electronic format documents, subject to Terms and Conditions for Electronic Documents at <http://www.sgs.com.tw/Terms-and-Conditions>. Attention is drawn to the limitation of liability, indemnification and jurisdiction issues defined therein. Any holder of this document is advised that information contained hereon reflects the Company's findings at the time of its intervention only and within the limits of Client's instructions, if any. The Company's sole responsibility is to its Client and this document does not exonerate parties to a transaction from exercising all their rights and obligations under the transaction documents. This document cannot be reproduced except in full, without prior written approval of the Company. Any unauthorized alteration, forgery or falsification of the content or appearance of this document is unlawful and offenders may be prosecuted to the fullest extent of the law.

10.5 Field Strength Calculation

The field strength is calculated by adding the Antenna Factor and Cable Factor and subtracting the Amplifier Gain and Duty Cycle Correction Factor (if any) from the measured reading. The basic equation with a sample calculation is as follows:

$$FS = RA + AF + CL - AG$$

Where *FS* = Field Strength

CL = Cable Attenuation Factor (Cable Loss)

RA = Reading Amplitude

AG = Amplifier Gain

AF = Antenna Factor

The limit of the emission level is expressed in dBuV/m, which converts $20 \cdot \log(uV/m)$

Actual FS(dBμV/m) = SPA. Reading level(dBμV) + Factor(dB)

Factor(dB) = Antenna Factor(dBμV/m) + Cable Loss(dB) – Pre_Amplifier Gain(dB)

10.6 Test Results of Radiated Spurious Emissions form 9 kHz to 30 MHz

The low frequency, which started from 9 kHz to 30MHz, was pre-scanned and the result which was 20dB lower than the limit per 15.31(o) & RSS-GEN §6.13.2 was not reported.

Unless otherwise stated the results shown in this test report refer only to the sample(s) tested and such sample(s) are retained for 90 days only.

除非另有說明，此報告結果僅對測試之樣品負責，同時此樣品僅保留90天。本報告未經本公司書面許可，不可部份複製。

This document is issued by the Company subject to its General Conditions of Service printed overleaf, available on request or accessible at <http://www.sgs.com.tw/Terms-and-Conditions> and for electronic format documents, subject to Terms and Conditions for Electronic Documents at <http://www.sgs.com.tw/Terms-and-Conditions>. Attention is drawn to the limitation of liability, indemnification and jurisdiction issues defined therein. Any holder of this document is advised that information contained hereon reflects the Company's findings at the time of its intervention only and within the limits of Client's instructions, if any. The Company's sole responsibility is to its Client and this document does not exonerate parties to a transaction from exercising all their rights and obligations under the transaction documents. This document cannot be reproduced except in full, without prior written approval of the Company. Any unauthorized alteration, forgery or falsification of the content or appearance of this document is unlawful and offenders may be prosecuted to the fullest extent of the law.

10.7 Measurement Result:

10.7.1 Radiated Bandedge Result (Hopping Mode)

Report Number	:ER-2020-B0044	Test Site	:SAC III Chamber
Operation Mode	:BR Hopping	Test Date	:2021-01-12
Test Frequency	:2402 MHz	Temp./Humi.	:21.0/39
Test Mode	:Bandedge CH Low	Antenna Pol.	:VERTICAL
EUT Pol	:H Plane	Engineer	:Nick

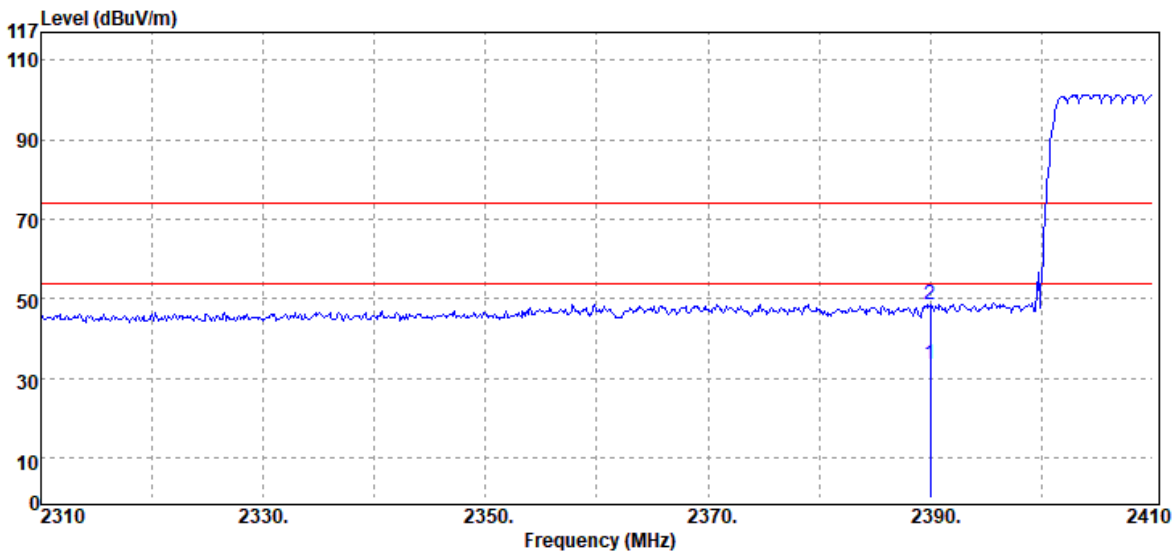

Freq. MHz	Detector Mode PK/QP/AV	Spectrum Reading Level dB μ V	Factor dB	Actual FS dB μ V/m	Limit @3m dB μ V/m	Margin dB
2390.00	Average	32.76	0.92	33.68	54.00	-20.32
2390.00	Peak	47.57	0.92	48.49	74.00	-25.51

Unless otherwise stated the results shown in this test report refer only to the sample(s) tested and such sample(s) are retained for 90 days only.

除非另有說明，此報告結果僅對測試之樣品負責，同時此樣品僅保留90天。本報告未經本公司書面許可，不可部份複製。

This document is issued by the Company subject to its General Conditions of Service printed overleaf, available on request or accessible at <http://www.sgs.com.tw/Terms-and-Conditions> and for electronic format documents, subject to Terms and Conditions for Electronic Documents at <http://www.sgs.com.tw/Terms-and-Conditions>. Attention is drawn to the limitation of liability, indemnification and jurisdiction issues defined therein. Any holder of this document is advised that information contained hereon reflects the Company's findings at the time of its intervention only and within the limits of Client's instructions, if any. The Company's sole responsibility is to its Client and this document does not exonerate parties to a transaction from exercising all their rights and obligations under the transaction documents. This document cannot be reproduced except in full, without prior written approval of the Company. Any unauthorized alteration, forgery or falsification of the content or appearance of this document is unlawful and offenders may be prosecuted to the fullest extent of the law.

Report Number :ER-2020-B0044
 Operation Mode :BR Hopping
 Test Frequency :2402 MHz
 Test Mode :Bandedge CH Low
 EUT Pol :H Plane

Test Site :SAC III Chamber
 Test Date :2021-01-12
 Temp./Humi. :21.0/39
 Antenna Pol. :HORIZONTAL
 Engineer :Nick

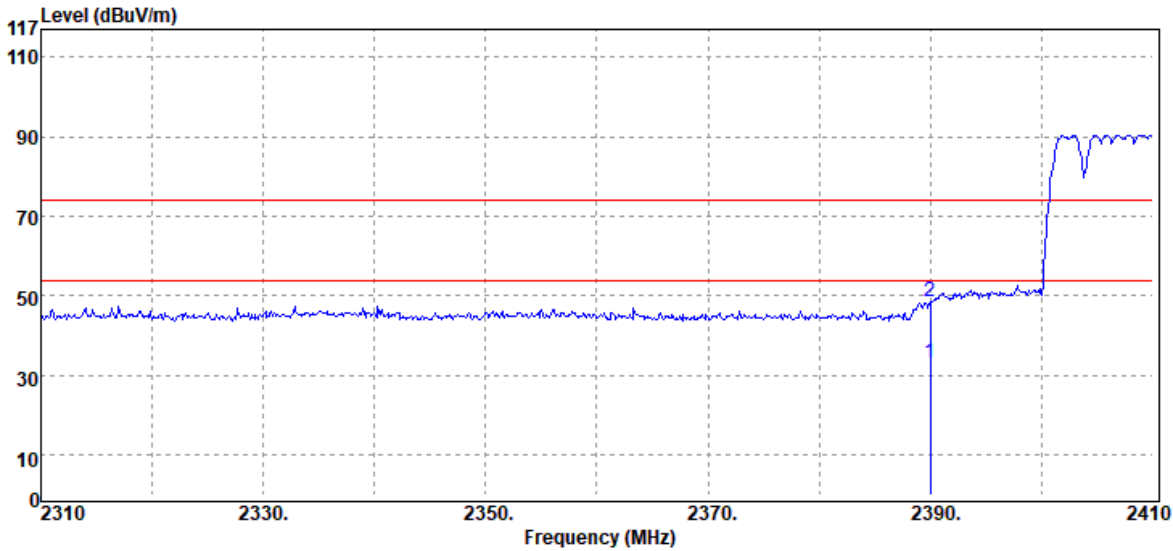

Freq. MHz	Detector Mode PK/QP/AV	Spectrum Reading Level dB μ V	Factor dB	Actual FS dB μ V/m	Limit @3m dB μ V/m	Margin dB
2390.00	Average	32.28	0.92	33.20	54.00	-20.80
2390.00	Peak	47.78	0.92	48.70	74.00	-25.30

Unless otherwise stated the results shown in this test report refer only to the sample(s) tested and such sample(s) are retained for 90 days only.

除非另有說明，此報告結果僅對測試之樣品負責，同時此樣品僅保留90天。本報告未經本公司書面許可，不可部份複製。

This document is issued by the Company subject to its General Conditions of Service printed overleaf, available on request or accessible at <http://www.sgs.com.tw/Terms-and-Conditions> and for electronic format documents, subject to Terms and Conditions for Electronic Documents at <http://www.sgs.com.tw/Terms-and-Conditions>. Attention is drawn to the limitation of liability, indemnification and jurisdiction issues defined therein. Any holder of this document is advised that information contained hereon reflects the Company's findings at the time of its intervention only and within the limits of Client's instructions, if any. The Company's sole responsibility is to its Client and this document does not exonerate parties to a transaction from exercising all their rights and obligations under the transaction documents. This document cannot be reproduced except in full, without prior written approval of the Company. Any unauthorized alteration, forgery or falsification of the content or appearance of this document is unlawful and offenders may be prosecuted to the fullest extent of the law.

Report Number :ER-2020-B0044
 Operation Mode :BR Hopping
 Test Frequency :2480 MHz
 Test Mode :Bandedge CH High
 EUT Pol :H Plane

Test Site :SAC III Chamber
 Test Date :2021-01-12
 Temp./Humi. :21.0/39
 Antenna Pol. :VERTICAL
 Engineer :Nick

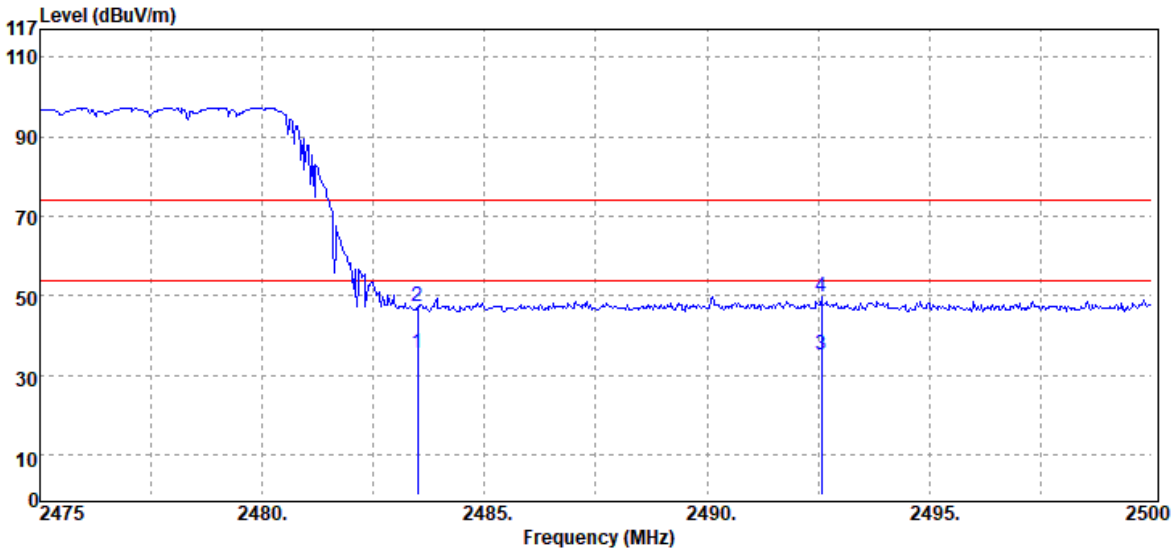

Freq. MHz	Detector Mode PK/QP/AV	Spectrum Reading Level dB μ V	Factor dB	Actual FS dB μ V/m	Limit @3m dB μ V/m	Margin dB
2483.50	Average	35.14	0.67	35.81	54.00	-18.19
2483.50	Peak	46.53	0.67	47.20	74.00	-26.80
2492.58	Average	34.74	0.63	35.37	54.00	-18.63
2492.58	Peak	49.27	0.63	49.90	74.00	-24.10

Unless otherwise stated the results shown in this test report refer only to the sample(s) tested and such sample(s) are retained for 90 days only.

除非另有說明，此報告結果僅對測試之樣品負責，同時此樣品僅保留90天。本報告未經本公司書面許可，不可部份複製。

This document is issued by the Company subject to its General Conditions of Service printed overleaf, available on request or accessible at <http://www.sgs.com.tw/Terms-and-Conditions> and for electronic format documents, subject to Terms and Conditions for Electronic Documents at <http://www.sgs.com.tw/Terms-and-Conditions>. Attention is drawn to the limitation of liability, indemnification and jurisdiction issues defined therein. Any holder of this document is advised that information contained hereon reflects the Company's findings at the time of its intervention only and within the limits of Client's instructions, if any. The Company's sole responsibility is to its Client and this document does not exonerate parties to a transaction from exercising all their rights and obligations under the transaction documents. This document cannot be reproduced except in full, without prior written approval of the Company. Any unauthorized alteration, forgery or falsification of the content or appearance of this document is unlawful and offenders may be prosecuted to the fullest extent of the law.

Report Number :ER-2020-B0044
 Operation Mode :BR Hopping
 Test Frequency :2480 MHz
 Test Mode :Bandedge CH High
 EUT Pol :H Plane

Test Site :SAC III Chamber
 Test Date :2021-01-12
 Temp./Humi. :21.0/39
 Antenna Pol. :HORIZONTAL
 Engineer :Nick

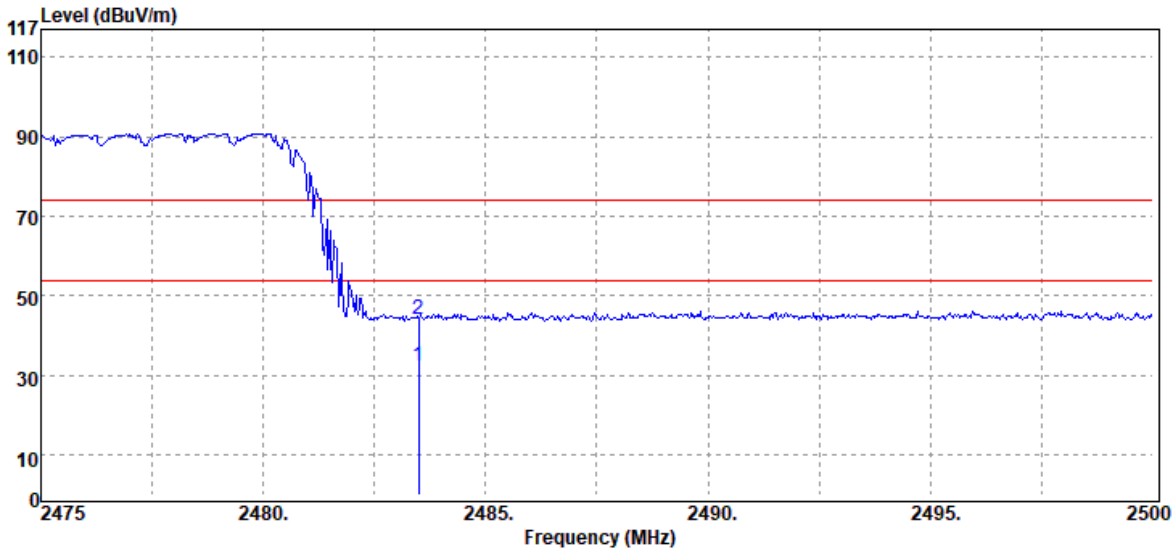

Freq. MHz	Detector Mode PK/QP/AV	Spectrum Reading Level dB μ V	Factor dB	Actual FS dB μ V/m	Limit @3m dB μ V/m	Margin dB
2483.50	Average	31.58	0.67	32.25	54.00	-21.75
2483.50	Peak	43.35	0.67	44.02	74.00	-29.98

Unless otherwise stated the results shown in this test report refer only to the sample(s) tested and such sample(s) are retained for 90 days only.

除非另有說明，此報告結果僅對測試之樣品負責，同時此樣品僅保留90天。本報告未經本公司書面許可，不可部份複製。

This document is issued by the Company subject to its General Conditions of Service printed overleaf, available on request or accessible at <http://www.sgs.com.tw/Terms-and-Conditions> and for electronic format documents, subject to Terms and Conditions for Electronic Documents at <http://www.sgs.com.tw/Terms-and-Conditions>. Attention is drawn to the limitation of liability, indemnification and jurisdiction issues defined therein. Any holder of this document is advised that information contained hereon reflects the Company's findings at the time of its intervention only and within the limits of Client's instructions, if any. The Company's sole responsibility is to its Client and this document does not exonerate parties to a transaction from exercising all their rights and obligations under the transaction documents. This document cannot be reproduced except in full, without prior written approval of the Company. Any unauthorized alteration, forgery or falsification of the content or appearance of this document is unlawful and offenders may be prosecuted to the fullest extent of the law.

Report Number :ER-2020-B0044
 Operation Mode :EDR Hopping
 Test Frequency :2402 MHz
 Test Mode :Bandedge CH Low
 EUT Pol :H Plane

Test Site :SAC III Chamber
 Test Date :2021-01-12
 Temp./Humi. :21.0/39
 Antenna Pol. :VERTICAL
 Engineer :Nick

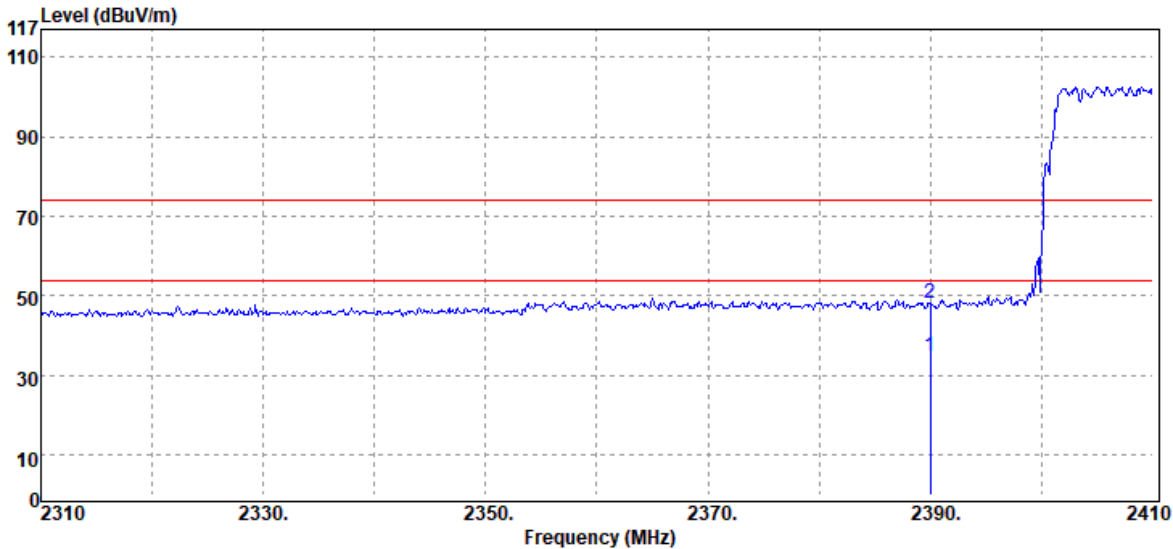

Freq. MHz	Detector Mode PK/QP/AV	Spectrum Reading Level dB μ V	Factor dB	Actual FS dB μ V/m	Limit @3m dB μ V/m	Margin dB
2390.00	Average	33.78	0.92	34.70	54.00	-19.30
2390.00	Peak	47.15	0.92	48.07	74.00	-25.93

Unless otherwise stated the results shown in this test report refer only to the sample(s) tested and such sample(s) are retained for 90 days only.

除非另有說明，此報告結果僅對測試之樣品負責，同時此樣品僅保留90天。本報告未經本公司書面許可，不可部份複製。

This document is issued by the Company subject to its General Conditions of Service printed overleaf, available on request or accessible at <http://www.sgs.com.tw/Terms-and-Conditions> and for electronic format documents, subject to Terms and Conditions for Electronic Documents at <http://www.sgs.com.tw/Terms-and-Conditions>. Attention is drawn to the limitation of liability, indemnification and jurisdiction issues defined therein. Any holder of this document is advised that information contained hereon reflects the Company's findings at the time of its intervention only and within the limits of Client's instructions, if any. The Company's sole responsibility is to its Client and this document does not exonerate parties to a transaction from exercising all their rights and obligations under the transaction documents. This document cannot be reproduced except in full, without prior written approval of the Company. Any unauthorized alteration, forgery or falsification of the content or appearance of this document is unlawful and offenders may be prosecuted to the fullest extent of the law.

Report Number :ER-2020-B0044
 Operation Mode :EDR Hopping
 Test Frequency :2402 MHz
 Test Mode :Bandedge CH Low
 EUT Pol :H Plane

Test Site :SAC III Chamber
 Test Date :2021-01-12
 Temp./Humi. :21.0/39
 Antenna Pol. :HORIZONTAL
 Engineer :Nick

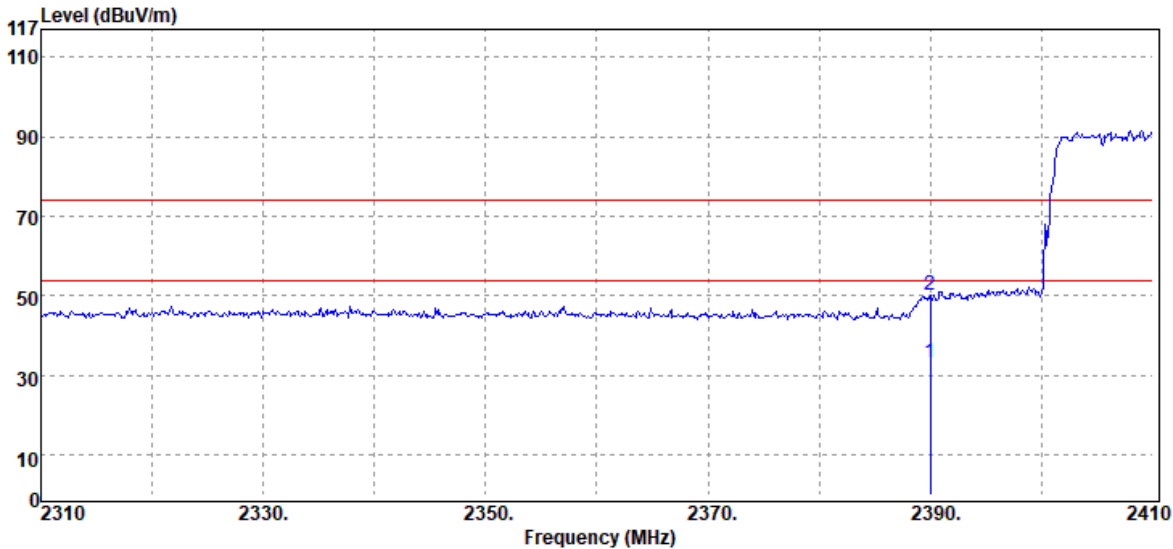

Freq. MHz	Detector Mode PK/QP/AV	Spectrum Reading Level dB μ V	Factor dB	Actual FS dB μ V/m	Limit @3m dB μ V/m	Margin dB
2390.00	Average	32.12	0.92	33.04	54.00	-20.96
2390.00	Peak	49.13	0.92	50.05	74.00	-23.95

Unless otherwise stated the results shown in this test report refer only to the sample(s) tested and such sample(s) are retained for 90 days only.

除非另有說明，此報告結果僅對測試之樣品負責，同時此樣品僅保留90天。本報告未經本公司書面許可，不可部份複製。

This document is issued by the Company subject to its General Conditions of Service printed overleaf, available on request or accessible at <http://www.sgs.com.tw/Terms-and-Conditions> and for electronic format documents, subject to Terms and Conditions for Electronic Documents at <http://www.sgs.com.tw/Terms-and-Conditions>. Attention is drawn to the limitation of liability, indemnification and jurisdiction issues defined therein. Any holder of this document is advised that information contained hereon reflects the Company's findings at the time of its intervention only and within the limits of Client's instructions, if any. The Company's sole responsibility is to its Client and this document does not exonerate parties to a transaction from exercising all their rights and obligations under the transaction documents. This document cannot be reproduced except in full, without prior written approval of the Company. Any unauthorized alteration, forgery or falsification of the content or appearance of this document is unlawful and offenders may be prosecuted to the fullest extent of the law.

Report Number :ER-2020-B0044
 Operation Mode :EDR Hopping
 Test Frequency :2480 MHz
 Test Mode :Bandedge CH High
 EUT Pol :H Plane

Test Site :SAC III Chamber
 Test Date :2021-01-12
 Temp./Humi. :21.0/39
 Antenna Pol. :VERTICAL
 Engineer :Nick

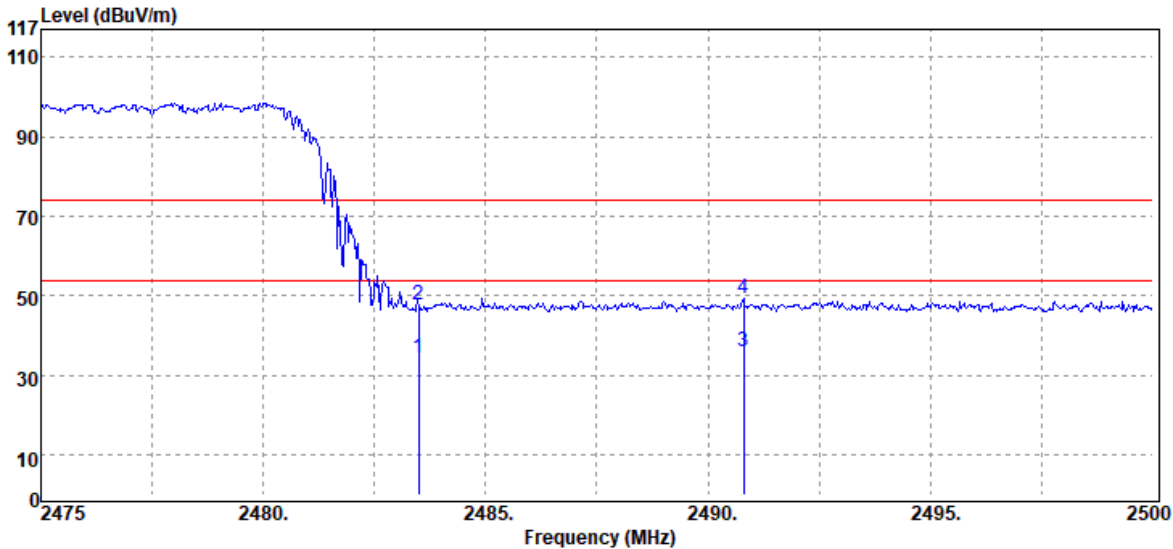

Freq. MHz	Detector Mode PK/QP/AV	Spectrum Reading Level dB μ V	Factor dB	Actual FS dB μ V/m	Limit @3m dB μ V/m	Margin dB
2483.50	Average	33.87	0.67	34.54	54.00	-19.46
2483.50	Peak	47.21	0.67	47.88	74.00	-26.12
2490.80	Average	35.43	0.64	36.07	54.00	-17.93
2490.80	Peak	48.75	0.64	49.39	74.00	-24.61

Unless otherwise stated the results shown in this test report refer only to the sample(s) tested and such sample(s) are retained for 90 days only.

除非另有說明，此報告結果僅對測試之樣品負責，同時此樣品僅保留90天。本報告未經本公司書面許可，不可部份複製。

This document is issued by the Company subject to its General Conditions of Service printed overleaf, available on request or accessible at <http://www.sgs.com.tw/Terms-and-Conditions> and for electronic format documents, subject to Terms and Conditions for Electronic Documents at <http://www.sgs.com.tw/Terms-and-Conditions>. Attention is drawn to the limitation of liability, indemnification and jurisdiction issues defined therein. Any holder of this document is advised that information contained hereon reflects the Company's findings at the time of its intervention only and within the limits of Client's instructions, if any. The Company's sole responsibility is to its Client and this document does not exonerate parties to a transaction from exercising all their rights and obligations under the transaction documents. This document cannot be reproduced except in full, without prior written approval of the Company. Any unauthorized alteration, forgery or falsification of the content or appearance of this document is unlawful and offenders may be prosecuted to the fullest extent of the law.

Report Number :ER-2020-B0044
 Operation Mode :EDR Hopping
 Test Frequency :2480 MHz
 Test Mode :Bandedge CH High
 EUT Pol :H Plane

Test Site :SAC III Chamber
 Test Date :2021-01-12
 Temp./Humi. :21.0/39
 Antenna Pol. :HORIZONTAL
 Engineer :Nick

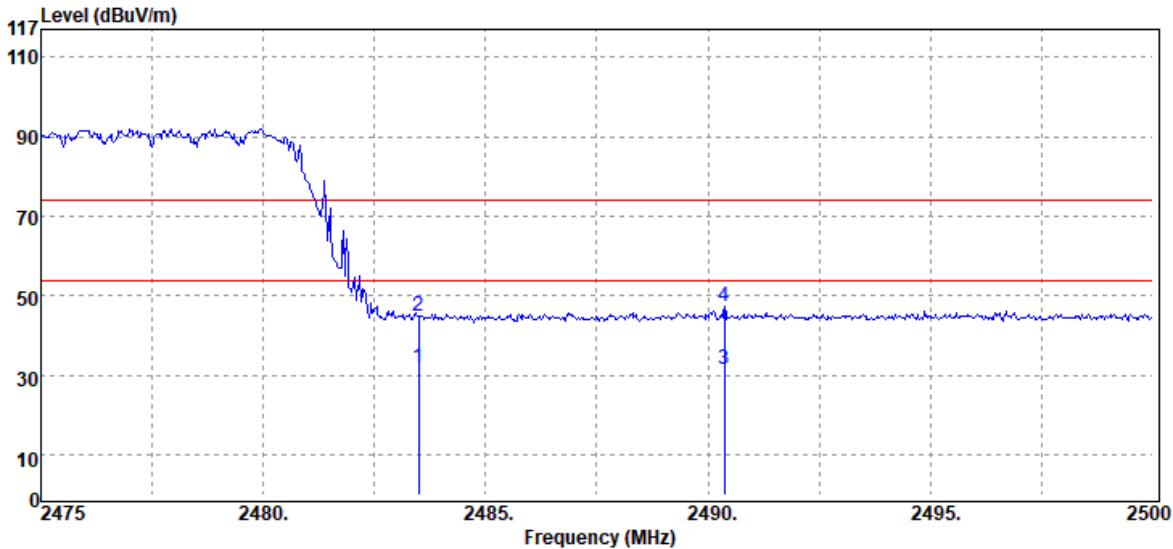

Freq. MHz	Detector Mode PK/QP/AV	Spectrum Reading Level dB μ V	Factor dB	Actual FS dB μ V/m	Limit @3m dB μ V/m	Margin dB
2483.50	Average	31.31	0.67	31.98	54.00	-22.02
2483.50	Peak	44.14	0.67	44.81	74.00	-29.19
2490.38	Average	31.04	0.64	31.68	54.00	-22.32
2490.38	Peak	46.61	0.64	47.25	74.00	-26.75

Unless otherwise stated the results shown in this test report refer only to the sample(s) tested and such sample(s) are retained for 90 days only.

除非另有說明，此報告結果僅對測試之樣品負責，同時此樣品僅保留90天。本報告未經本公司書面許可，不可部份複製。

This document is issued by the Company subject to its General Conditions of Service printed overleaf, available on request or accessible at <http://www.sgs.com.tw/Terms-and-Conditions> and for electronic format documents, subject to Terms and Conditions for Electronic Documents at <http://www.sgs.com.tw/Terms-and-Conditions>. Attention is drawn to the limitation of liability, indemnification and jurisdiction issues defined therein. Any holder of this document is advised that information contained hereon reflects the Company's findings at the time of its intervention only and within the limits of Client's instructions, if any. The Company's sole responsibility is to its Client and this document does not exonerate parties to a transaction from exercising all their rights and obligations under the transaction documents. This document cannot be reproduced except in full, without prior written approval of the Company. Any unauthorized alteration, forgery or falsification of the content or appearance of this document is unlawful and offenders may be prosecuted to the fullest extent of the law.

10.7.2 Radiated Bandedge Result (Non-Hopping Mode)

Report Number	:ER-2020-B0044	Test Site	:SAC III Chamber
Operation Mode	:BR	Test Date	:2021-01-12
Test Frequency	:2402 MHz	Temp./Humi.	:21.0/39
Test Mode	:Bandedge CH Low	Antenna Pol.	:VERTICAL
EUT Pol	:H Plane	Engineer	:Nick

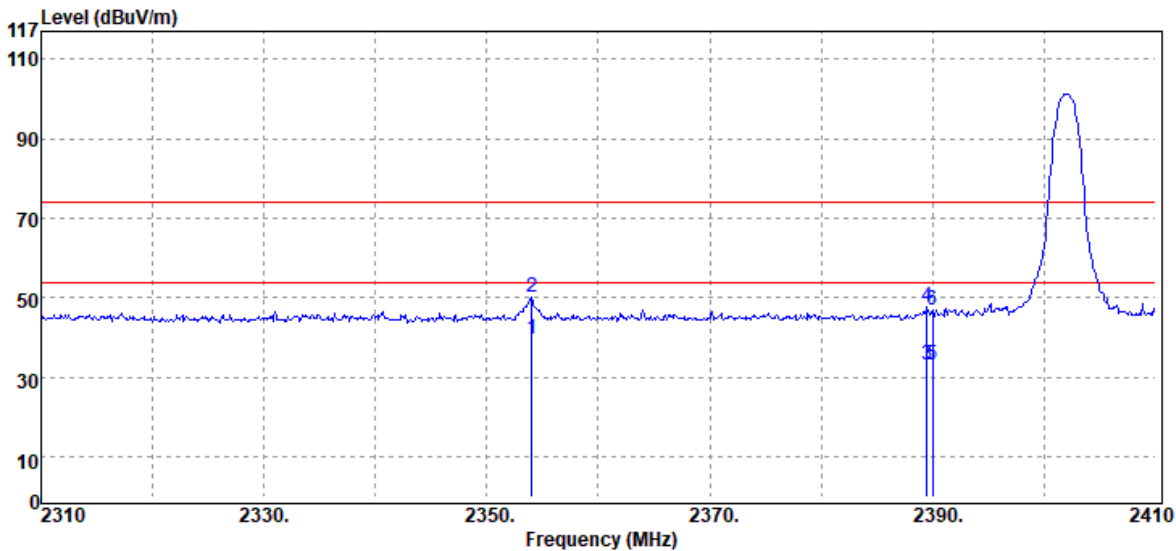

Freq. MHz	Detector Mode PK/QP/AV	Spectrum Reading Level dB μ V	Factor dB	Actual FS dB μ V/m	Limit @3m dB μ V/m	Margin dB
2354.00	Average	38.51	0.99	39.50	54.00	-14.50
2354.00	Peak	49.05	0.99	50.04	74.00	-23.96
2389.50	Average	32.39	0.91	33.30	54.00	-20.70
2389.50	Peak	46.96	0.91	47.87	74.00	-26.13
2390.00	Average	32.43	0.92	33.35	54.00	-20.65
2390.00	Peak	45.88	0.92	46.80	74.00	-27.20

Unless otherwise stated the results shown in this test report refer only to the sample(s) tested and such sample(s) are retained for 90 days only.

除非另有說明，此報告結果僅對測試之樣品負責，同時此樣品僅保留90天。本報告未經本公司書面許可，不可部份複製。

This document is issued by the Company subject to its General Conditions of Service printed overleaf, available on request or accessible at <http://www.sgs.com.tw/Terms-and-Conditions> and for electronic format documents, subject to Terms and Conditions for Electronic Documents at <http://www.sgs.com.tw/Terms-and-Conditions>. Attention is drawn to the limitation of liability, indemnification and jurisdiction issues defined therein. Any holder of this document is advised that information contained hereon reflects the Company's findings at the time of its intervention only and within the limits of Client's instructions, if any. The Company's sole responsibility is to its Client and this document does not exonerate parties to a transaction from exercising all their rights and obligations under the transaction documents. This document cannot be reproduced except in full, without prior written approval of the Company. Any unauthorized alteration, forgery or falsification of the content or appearance of this document is unlawful and offenders may be prosecuted to the fullest extent of the law.

Report Number :ER-2020-B0044
 Operation Mode :BR
 Test Frequency :2402 MHz
 Test Mode :Bandedge CH Low
 EUT Pol :H Plane

Test Site :SAC III Chamber
 Test Date :2021-01-12
 Temp./Humi. :21.0/39
 Antenna Pol. :HORIZONTAL
 Engineer :Nick

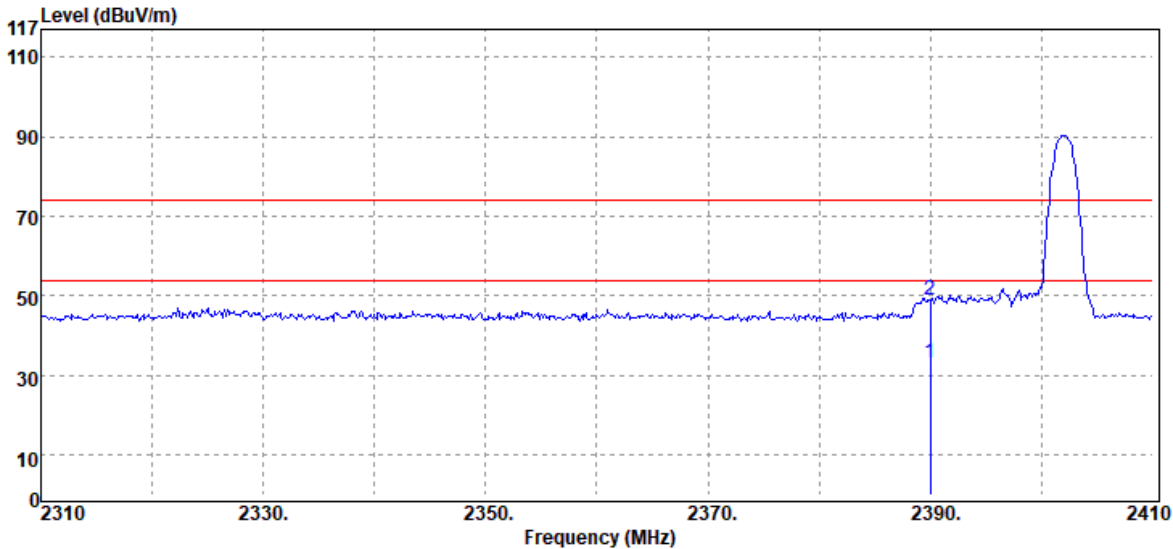

Freq. MHz	Detector Mode PK/QP/AV	Spectrum Reading Level dB μ V	Factor dB	Actual FS dB μ V/m	Limit @3m dB μ V/m	Margin dB
2390.00	Average	32.45	0.92	33.37	54.00	-20.63
2390.00	Peak	48.05	0.92	48.97	74.00	-25.03

Unless otherwise stated the results shown in this test report refer only to the sample(s) tested and such sample(s) are retained for 90 days only.

除非另有說明，此報告結果僅對測試之樣品負責，同時此樣品僅保留90天。本報告未經本公司書面許可，不可部份複製。

This document is issued by the Company subject to its General Conditions of Service printed overleaf, available on request or accessible at <http://www.sgs.com.tw/Terms-and-Conditions> and for electronic format documents, subject to Terms and Conditions for Electronic Documents at <http://www.sgs.com.tw/Terms-and-Conditions>. Attention is drawn to the limitation of liability, indemnification and jurisdiction issues defined therein. Any holder of this document is advised that information contained hereon reflects the Company's findings at the time of its intervention only and within the limits of Client's instructions, if any. The Company's sole responsibility is to its Client and this document does not exonerate parties to a transaction from exercising all their rights and obligations under the transaction documents. This document cannot be reproduced except in full, without prior written approval of the Company. Any unauthorized alteration, forgery or falsification of the content or appearance of this document is unlawful and offenders may be prosecuted to the fullest extent of the law.

Report Number :ER-2020-B0044
 Operation Mode :BR
 Test Frequency :2480 MHz
 Test Mode :Bandedge CH High
 EUT Pol :H Plane

Test Site :SAC III Chamber
 Test Date :2021-01-12
 Temp./Humi. :21.0/39
 Antenna Pol. :VERTICAL
 Engineer :Nick

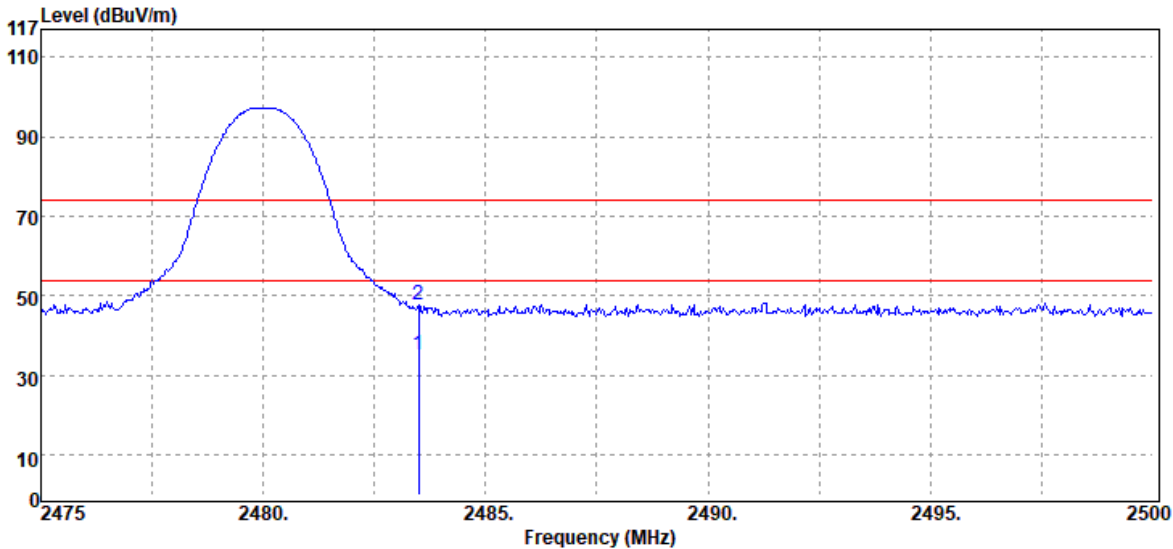

Freq. MHz	Detector Mode PK/QP/AV	Spectrum Reading Level dB μ V	Factor dB	Actual FS dB μ V/m	Limit @3m dB μ V/m	Margin dB
2483.50	Average	34.37	0.67	35.04	54.00	-18.96
2483.50	Peak	47.09	0.67	47.76	74.00	-26.24

Unless otherwise stated the results shown in this test report refer only to the sample(s) tested and such sample(s) are retained for 90 days only.

除非另有說明，此報告結果僅對測試之樣品負責，同時此樣品僅保留90天。本報告未經本公司書面許可，不可部份複製。

This document is issued by the Company subject to its General Conditions of Service printed overleaf, available on request or accessible at <http://www.sgs.com.tw/Terms-and-Conditions> and for electronic format documents, subject to Terms and Conditions for Electronic Documents at <http://www.sgs.com.tw/Terms-and-Conditions>. Attention is drawn to the limitation of liability, indemnification and jurisdiction issues defined therein. Any holder of this document is advised that information contained hereon reflects the Company's findings at the time of its intervention only and within the limits of Client's instructions, if any. The Company's sole responsibility is to its Client and this document does not exonerate parties to a transaction from exercising all their rights and obligations under the transaction documents. This document cannot be reproduced except in full, without prior written approval of the Company. Any unauthorized alteration, forgery or falsification of the content or appearance of this document is unlawful and offenders may be prosecuted to the fullest extent of the law.

Report Number :ER-2020-B0044
 Operation Mode :BR
 Test Frequency :2480 MHz
 Test Mode :Bandedge CH High
 EUT Pol :H Plane

Test Site :SAC III Chamber
 Test Date :2021-01-12
 Temp./Humi. :21.0/39
 Antenna Pol. :HORIZONTAL
 Engineer :Nick

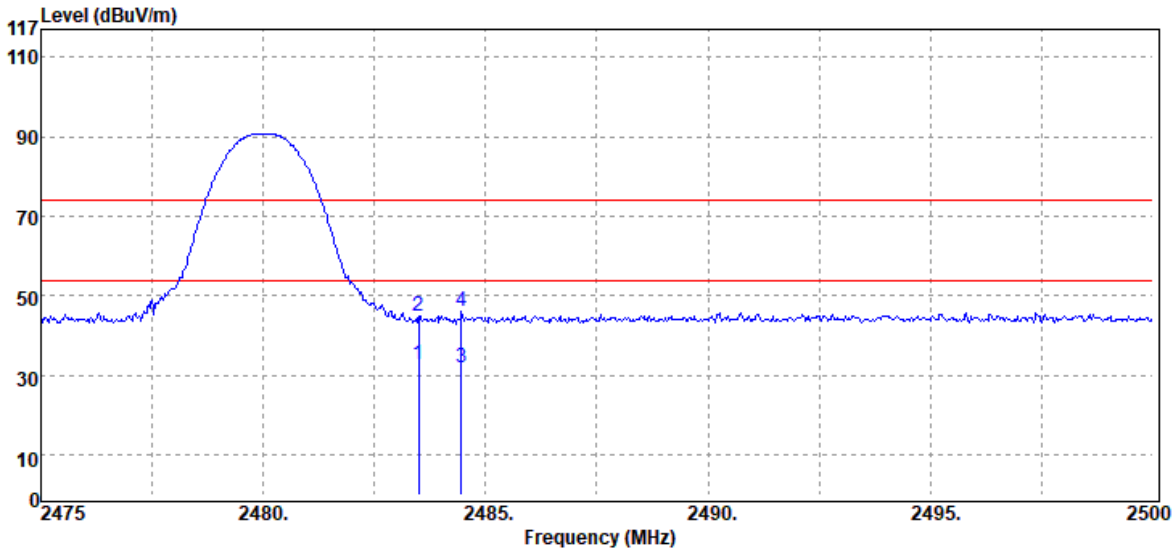

Freq. MHz	Detector Mode PK/QP/AV	Spectrum Reading Level dB μ V	Factor dB	Actual FS dB μ V/m	Limit @3m dB μ V/m	Margin dB
2483.50	Average	32.02	0.67	32.69	54.00	-21.31
2483.50	Peak	44.22	0.67	44.89	74.00	-29.11
2484.45	Average	31.38	0.66	32.04	54.00	-21.96
2484.45	Peak	45.46	0.66	46.12	74.00	-27.88

Unless otherwise stated the results shown in this test report refer only to the sample(s) tested and such sample(s) are retained for 90 days only.

除非另有說明，此報告結果僅對測試之樣品負責，同時此樣品僅保留90天。本報告未經本公司書面許可，不可部份複製。

This document is issued by the Company subject to its General Conditions of Service printed overleaf, available on request or accessible at <http://www.sgs.com.tw/Terms-and-Conditions> and for electronic format documents, subject to Terms and Conditions for Electronic Documents at <http://www.sgs.com.tw/Terms-and-Conditions>. Attention is drawn to the limitation of liability, indemnification and jurisdiction issues defined therein. Any holder of this document is advised that information contained hereon reflects the Company's findings at the time of its intervention only and within the limits of Client's instructions, if any. The Company's sole responsibility is to its Client and this document does not exonerate parties to a transaction from exercising all their rights and obligations under the transaction documents. This document cannot be reproduced except in full, without prior written approval of the Company. Any unauthorized alteration, forgery or falsification of the content or appearance of this document is unlawful and offenders may be prosecuted to the fullest extent of the law.

Report Number :ER-2020-B0044
 Operation Mode :EDR
 Test Frequency :2402 MHz
 Test Mode :Bandedge CH Low
 EUT Pol :H Plane

Test Site :SAC III Chamber
 Test Date :2021-01-12
 Temp./Humi. :21.0/39
 Antenna Pol. :VERTICAL
 Engineer :Nick

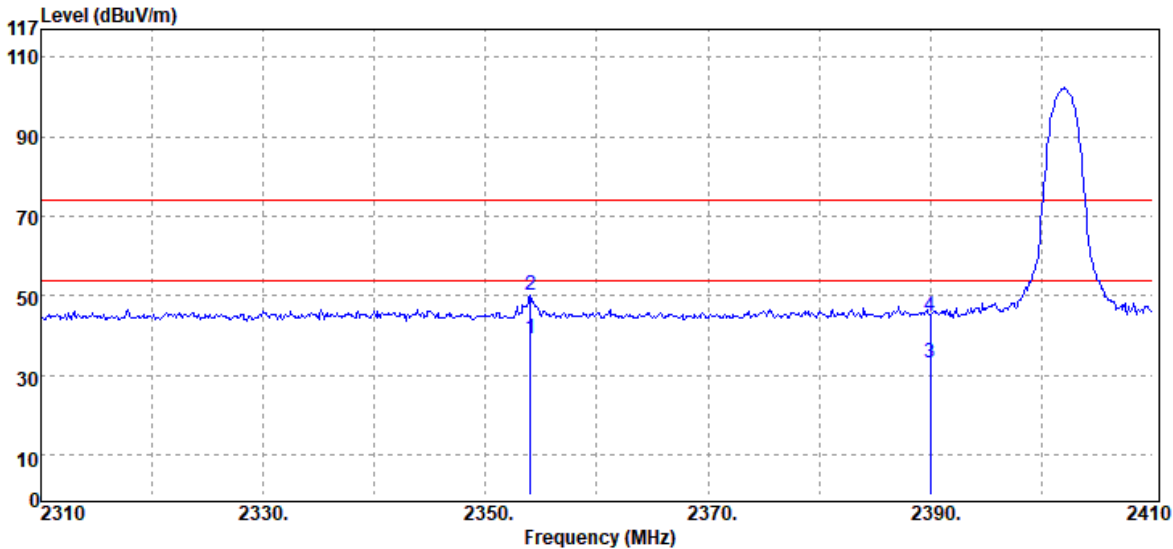

Freq. MHz	Detector Mode PK/QP/AV	Spectrum Reading Level dB μ V	Factor dB	Actual FS dB μ V/m	Limit @3m dB μ V/m	Margin dB
2354.00	Average	38.45	0.99	39.44	54.00	-14.56
2354.00	Peak	49.05	0.99	50.04	74.00	-23.96
2390.00	Average	32.36	0.92	33.28	54.00	-20.72
2390.00	Peak	44.00	0.92	44.92	74.00	-29.08

Unless otherwise stated the results shown in this test report refer only to the sample(s) tested and such sample(s) are retained for 90 days only.

除非另有說明，此報告結果僅對測試之樣品負責，同時此樣品僅保留90天。本報告未經本公司書面許可，不可部份複製。

This document is issued by the Company subject to its General Conditions of Service printed overleaf, available on request or accessible at <http://www.sgs.com.tw/Terms-and-Conditions> and for electronic format documents, subject to Terms and Conditions for Electronic Documents at <http://www.sgs.com.tw/Terms-and-Conditions>. Attention is drawn to the limitation of liability, indemnification and jurisdiction issues defined therein. Any holder of this document is advised that information contained hereon reflects the Company's findings at the time of its intervention only and within the limits of Client's instructions, if any. The Company's sole responsibility is to its Client and this document does not exonerate parties to a transaction from exercising all their rights and obligations under the transaction documents. This document cannot be reproduced except in full, without prior written approval of the Company. Any unauthorized alteration, forgery or falsification of the content or appearance of this document is unlawful and offenders may be prosecuted to the fullest extent of the law.

Report Number :ER-2020-B0044
 Operation Mode :EDR
 Test Frequency :2402 MHz
 Test Mode :Bandedge CH Low
 EUT Pol :H Plane

Test Site :SAC III Chamber
 Test Date :2021-01-12
 Temp./Humi. :21.0/39
 Antenna Pol. :HORIZONTAL
 Engineer :Nick

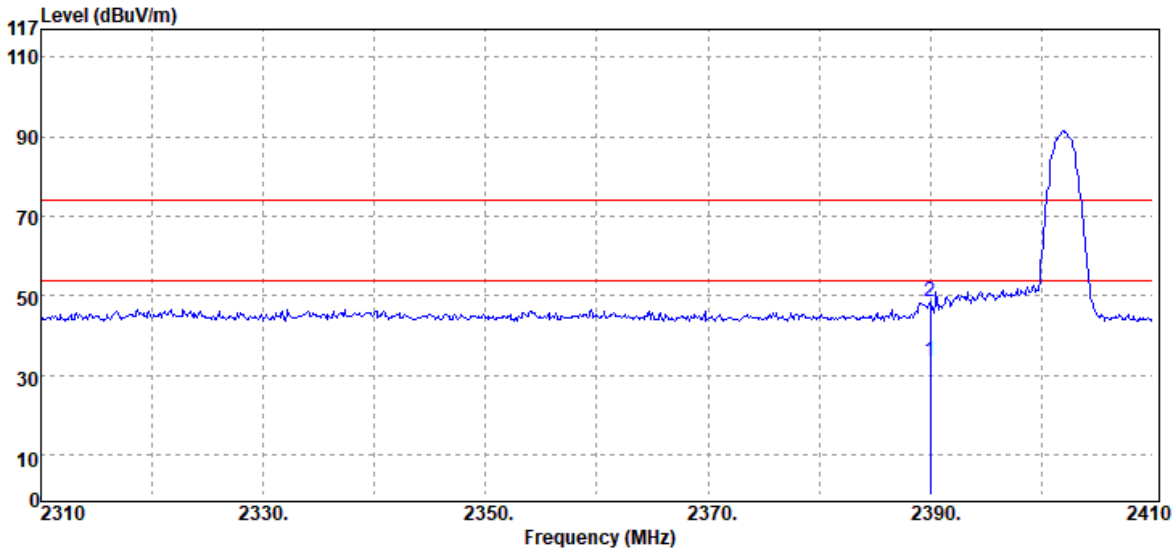

Freq. MHz	Detector Mode PK/QP/AV	Spectrum Reading Level dB μ V	Factor dB	Actual FS dB μ V/m	Limit @3m dB μ V/m	Margin dB
2390.00	Average	32.49	0.92	33.41	54.00	-20.59
2390.00	Peak	47.62	0.92	48.54	74.00	-25.46

Unless otherwise stated the results shown in this test report refer only to the sample(s) tested and such sample(s) are retained for 90 days only.

除非另有說明，此報告結果僅對測試之樣品負責，同時此樣品僅保留90天。本報告未經本公司書面許可，不可部份複製。

This document is issued by the Company subject to its General Conditions of Service printed overleaf, available on request or accessible at <http://www.sgs.com.tw/Terms-and-Conditions> and for electronic format documents, subject to Terms and Conditions for Electronic Documents at <http://www.sgs.com.tw/Terms-and-Conditions>. Attention is drawn to the limitation of liability, indemnification and jurisdiction issues defined therein. Any holder of this document is advised that information contained hereon reflects the Company's findings at the time of its intervention only and within the limits of Client's instructions, if any. The Company's sole responsibility is to its Client and this document does not exonerate parties to a transaction from exercising all their rights and obligations under the transaction documents. This document cannot be reproduced except in full, without prior written approval of the Company. Any unauthorized alteration, forgery or falsification of the content or appearance of this document is unlawful and offenders may be prosecuted to the fullest extent of the law.

Report Number :ER-2020-B0044
 Operation Mode :EDR
 Test Frequency :2480 MHz
 Test Mode :Bandedge CH High
 EUT Pol :H Plane

Test Site :SAC III Chamber
 Test Date :2021-01-12
 Temp./Humi. :21.0/39
 Antenna Pol. :VERTICAL
 Engineer :Nick

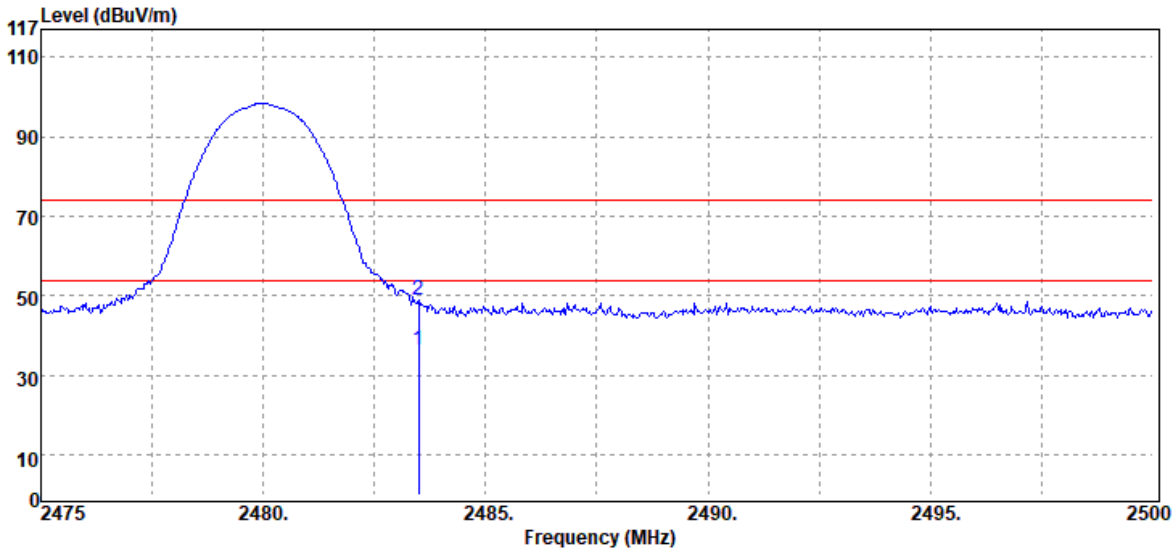

Freq. MHz	Detector Mode PK/QP/AV	Spectrum Reading Level dB μ V	Factor dB	Actual FS dB μ V/m	Limit @3m dB μ V/m	Margin dB
2483.50	Average	35.64	0.67	36.31	54.00	-17.69
2483.50	Peak	48.17	0.67	48.84	74.00	-25.16

Unless otherwise stated the results shown in this test report refer only to the sample(s) tested and such sample(s) are retained for 90 days only.

除非另有說明，此報告結果僅對測試之樣品負責，同時此樣品僅保留90天。本報告未經本公司書面許可，不可部份複製。

This document is issued by the Company subject to its General Conditions of Service printed overleaf, available on request or accessible at <http://www.sgs.com.tw/Terms-and-Conditions> and for electronic format documents, subject to Terms and Conditions for Electronic Documents at <http://www.sgs.com.tw/Terms-and-Conditions>. Attention is drawn to the limitation of liability, indemnification and jurisdiction issues defined therein. Any holder of this document is advised that information contained hereon reflects the Company's findings at the time of its intervention only and within the limits of Client's instructions, if any. The Company's sole responsibility is to its Client and this document does not exonerate parties to a transaction from exercising all their rights and obligations under the transaction documents. This document cannot be reproduced except in full, without prior written approval of the Company. Any unauthorized alteration, forgery or falsification of the content or appearance of this document is unlawful and offenders may be prosecuted to the fullest extent of the law.

Report Number :ER-2020-B0044
 Operation Mode :EDR
 Test Frequency :2480 MHz
 Test Mode :Bandedge CH High
 EUT Pol :H Plane

Test Site :SAC III Chamber
 Test Date :2021-01-12
 Temp./Humi. :21.0/39
 Antenna Pol. :HORIZONTAL
 Engineer :Nick

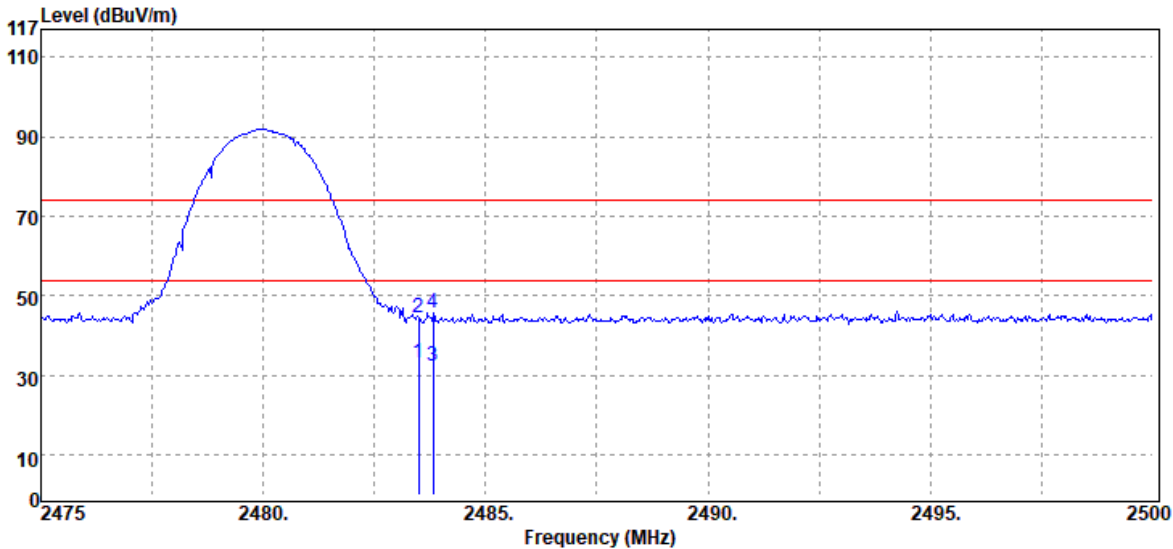

Freq. MHz	Detector Mode PK/QP/AV	Spectrum Reading Level dB μ V	Factor dB	Actual FS dB μ V/m	Limit @3m dB μ V/m	Margin dB
2483.50	Average	32.61	0.67	33.28	54.00	-20.72
2483.50	Peak	43.92	0.67	44.59	74.00	-29.41
2483.83	Average	31.73	0.66	32.39	54.00	-21.61
2483.83	Peak	44.94	0.66	45.60	74.00	-28.40

Unless otherwise stated the results shown in this test report refer only to the sample(s) tested and such sample(s) are retained for 90 days only.

除非另有說明，此報告結果僅對測試之樣品負責，同時此樣品僅保留90天。本報告未經本公司書面許可，不可部份複製。

This document is issued by the Company subject to its General Conditions of Service printed overleaf, available on request or accessible at <http://www.sgs.com.tw/Terms-and-Conditions> and for electronic format documents, subject to Terms and Conditions for Electronic Documents at <http://www.sgs.com.tw/Terms-and-Conditions>. Attention is drawn to the limitation of liability, indemnification and jurisdiction issues defined therein. Any holder of this document is advised that information contained hereon reflects the Company's findings at the time of its intervention only and within the limits of Client's instructions, if any. The Company's sole responsibility is to its Client and this document does not exonerate parties to a transaction from exercising all their rights and obligations under the transaction documents. This document cannot be reproduced except in full, without prior written approval of the Company. Any unauthorized alteration, forgery or falsification of the content or appearance of this document is unlawful and offenders may be prosecuted to the fullest extent of the law.

10.7.3 Radiated Spurious Emission form 30MHz to 1000MHz:

Report Number	:ER-2020-B0044	Test Site	:SAC III Chamber
Operation Mode	:EDR	Test Date	:2021-01-12
Test Frequency	:2441 MHz	Temp./Humi.	:21.0/39
Test Mode	:Tx CH Mid	Antenna Pol.	:VERTICAL
EUT Pol	:H Plane	Engineer	:Nick

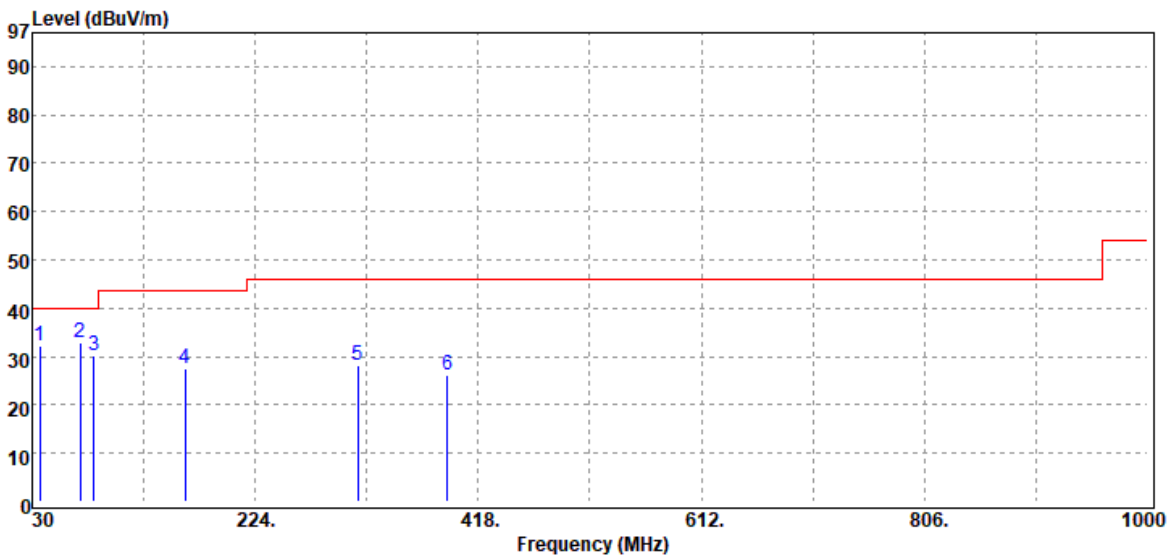

Freq. MHz	Detector Mode PK/QP/AV	Spectrum Reading Level dB μ V	Factor dB	Actual FS dB μ V/m	Limit @3m dB μ V/m	Margin dB
36.79	Peak	41.04	-8.93	32.11	40.00	-7.89
71.71	Peak	43.43	-10.62	32.81	40.00	-7.19
83.35	Peak	43.25	-12.95	30.30	40.00	-9.70
162.89	Peak	34.86	-7.29	27.57	43.50	-15.93
313.24	Peak	34.67	-6.31	28.36	46.00	-17.64
390.84	Peak	31.25	-5.09	26.16	46.00	-19.84

Unless otherwise stated the results shown in this test report refer only to the sample(s) tested and such sample(s) are retained for 90 days only.

除非另有說明，此報告結果僅對測試之樣品負責，同時此樣品僅保留90天。本報告未經本公司書面許可，不可部份複製。

This document is issued by the Company subject to its General Conditions of Service printed overleaf, available on request or accessible at <http://www.sgs.com.tw/Terms-and-Conditions> and for electronic format documents, subject to Terms and Conditions for Electronic Documents at <http://www.sgs.com.tw/Terms-and-Conditions>. Attention is drawn to the limitation of liability, indemnification and jurisdiction issues defined therein. Any holder of this document is advised that information contained hereon reflects the Company's findings at the time of its intervention only and within the limits of Client's instructions, if any. The Company's sole responsibility is to its Client and this document does not exonerate parties to a transaction from exercising all their rights and obligations under the transaction documents. This document cannot be reproduced except in full, without prior written approval of the Company. Any unauthorized alteration, forgery or falsification of the content or appearance of this document is unlawful and offenders may be prosecuted to the fullest extent of the law.

Report Number :ER-2020-B0044
 Operation Mode :EDR
 Test Frequency :2441 MHz
 Test Mode :Tx CH Mid
 EUT Pol :H Plane

Test Site :SAC III Chamber
 Test Date :2021-01-12
 Temp./Humi. :21.0/39
 Antenna Pol. :HORIZONTAL
 Engineer :Nick

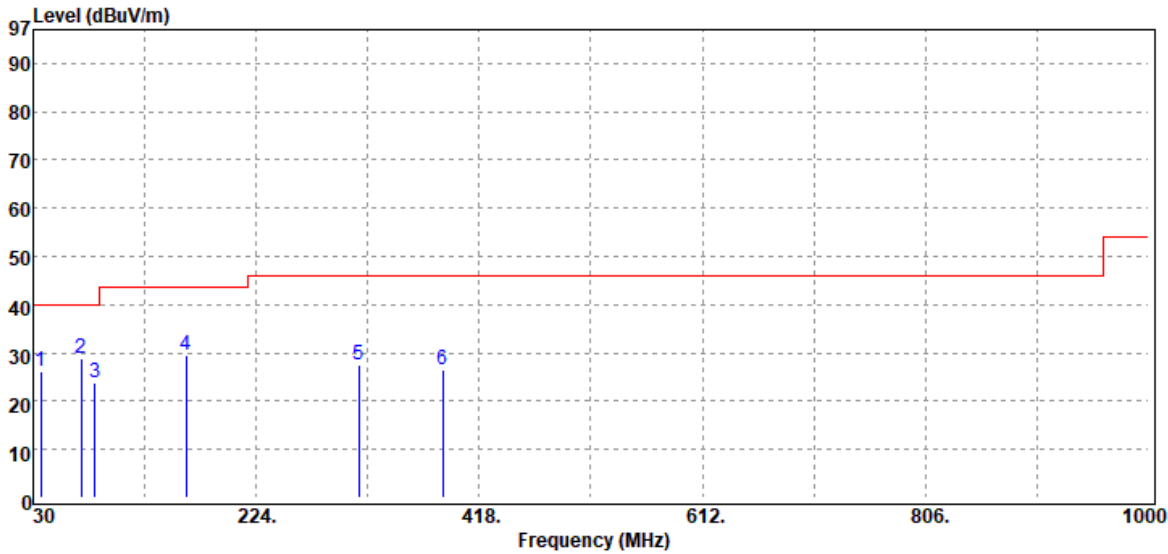

Freq. MHz	Detector Mode PK/QP/AV	Spectrum Reading Level dBµV	Factor dB	Actual FS dBµV/m	Limit @3m dBµV/m	Margin dB
36.79	Peak	35.27	-8.93	26.34	40.00	-13.66
71.71	Peak	39.44	-10.62	28.82	40.00	-11.18
83.35	Peak	36.79	-12.95	23.84	40.00	-16.16
162.89	Peak	36.94	-7.29	29.65	43.50	-13.85
313.24	Peak	33.48	-5.89	27.59	46.00	-18.41
385.99	Peak	30.86	-4.50	26.36	46.00	-19.64

Unless otherwise stated the results shown in this test report refer only to the sample(s) tested and such sample(s) are retained for 90 days only.

除非另有說明，此報告結果僅對測試之樣品負責，同時此樣品僅保留90天。本報告未經本公司書面許可，不可部份複製。

This document is issued by the Company subject to its General Conditions of Service printed overleaf, available on request or accessible at <http://www.sgs.com.tw/Terms-and-Conditions> and for electronic format documents, subject to Terms and Conditions for Electronic Documents at <http://www.sgs.com.tw/Terms-and-Conditions>. Attention is drawn to the limitation of liability, indemnification and jurisdiction issues defined therein. Any holder of this document is advised that information contained hereon reflects the Company's findings at the time of its intervention only and within the limits of Client's instructions, if any. The Company's sole responsibility is to its Client and this document does not exonerate parties to a transaction from exercising all their rights and obligations under the transaction documents. This document cannot be reproduced except in full, without prior written approval of the Company. Any unauthorized alteration, forgery or falsification of the content or appearance of this document is unlawful and offenders may be prosecuted to the fullest extent of the law.

10.7.4 Radiated Spurious Emission above 1 GHz:

Report Number	:ER-2020-B0044	Test Site	:SAC III Chamber
Operation Mode	:EDR	Test Date	:2021-01-12
Test Frequency	:2402 MHz	Temp./Humi.	:21.0/39
Test Mode	:Tx CH Low	Antenna Pol.	:VERTICAL
EUT Pol	:H Plane	Engineer	:Nick

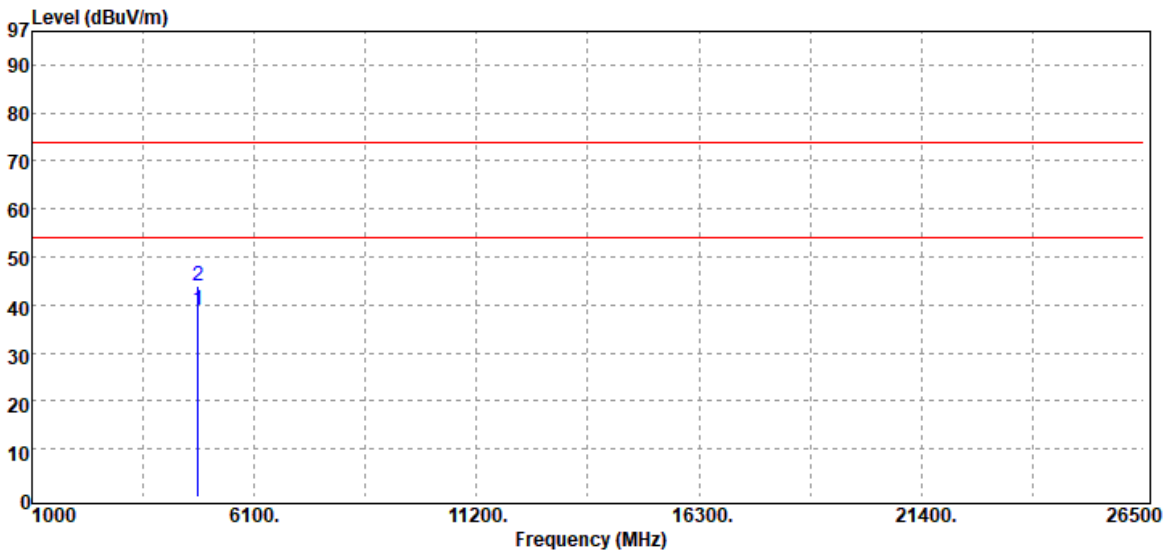

Freq. MHz	Detector Mode PK/QP/AV	Spectrum Reading Level dB μ V	Factor dB	Actual FS dB μ V/m	Limit @3m dB μ V/m	Margin dB
4804.00	Average	31.65	7.14	38.79	54.00	-15.21
4804.00	Peak	36.83	7.14	43.97	74.00	-30.03

Unless otherwise stated the results shown in this test report refer only to the sample(s) tested and such sample(s) are retained for 90 days only.

除非另有說明，此報告結果僅對測試之樣品負責，同時此樣品僅保留90天。本報告未經本公司書面許可，不可部份複製。

This document is issued by the Company subject to its General Conditions of Service printed overleaf, available on request or accessible at <http://www.sgs.com.tw/Terms-and-Conditions> and for electronic format documents, subject to Terms and Conditions for Electronic Documents at <http://www.sgs.com.tw/Terms-and-Conditions>. Attention is drawn to the limitation of liability, indemnification and jurisdiction issues defined therein. Any holder of this document is advised that information contained hereon reflects the Company's findings at the time of its intervention only and within the limits of Client's instructions, if any. The Company's sole responsibility is to its Client and this document does not exonerate parties to a transaction from exercising all their rights and obligations under the transaction documents. This document cannot be reproduced except in full, without prior written approval of the Company. Any unauthorized alteration, forgery or falsification of the content or appearance of this document is unlawful and offenders may be prosecuted to the fullest extent of the law.

Report Number :ER-2020-B0044
 Operation Mode :EDR
 Test Frequency :2402 MHz
 Test Mode :Tx CH Low
 EUT Pol :H Plane

Test Site :SAC III Chamber
 Test Date :2021-01-12
 Temp./Humi. :21.0/39
 Antenna Pol. :HORIZONTAL
 Engineer :Nick

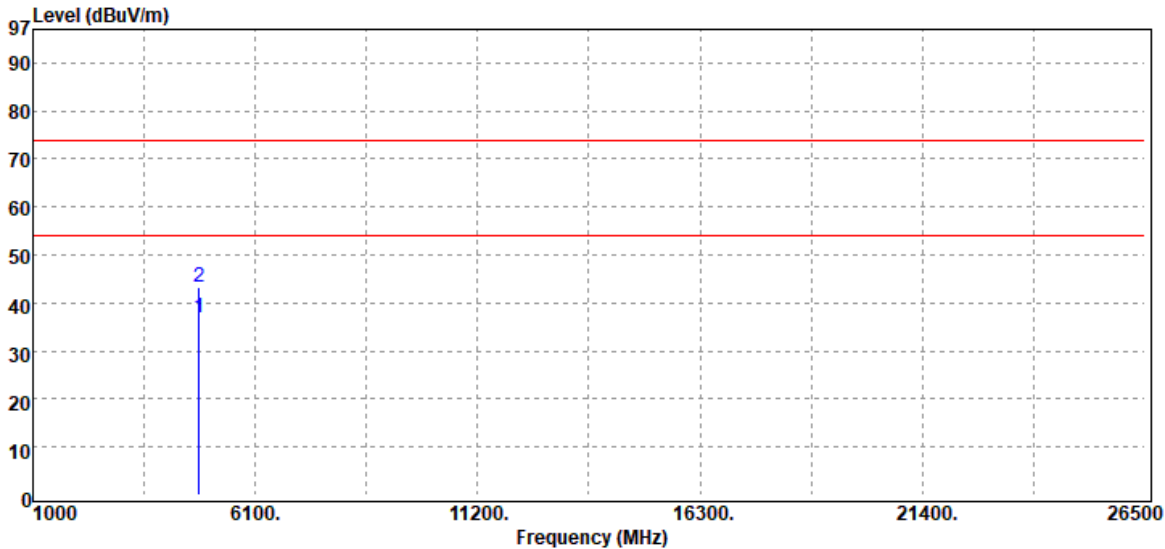

Freq. MHz	Detector Mode PK/QP/AV	Spectrum Reading Level dB μ V	Factor dB	Actual FS dB μ V/m	Limit @3m dB μ V/m	Margin dB
4804.00	Average	29.93	7.14	37.07	54.00	-16.93
4804.00	Peak	36.30	7.14	43.44	74.00	-30.56

Unless otherwise stated the results shown in this test report refer only to the sample(s) tested and such sample(s) are retained for 90 days only.

除非另有說明，此報告結果僅對測試之樣品負責，同時此樣品僅保留90天。本報告未經本公司書面許可，不可部份複製。

This document is issued by the Company subject to its General Conditions of Service printed overleaf, available on request or accessible at <http://www.sgs.com.tw/Terms-and-Conditions> and for electronic format documents, subject to Terms and Conditions for Electronic Documents at <http://www.sgs.com.tw/Terms-and-Conditions>. Attention is drawn to the limitation of liability, indemnification and jurisdiction issues defined therein. Any holder of this document is advised that information contained hereon reflects the Company's findings at the time of its intervention only and within the limits of Client's instructions, if any. The Company's sole responsibility is to its Client and this document does not exonerate parties to a transaction from exercising all their rights and obligations under the transaction documents. This document cannot be reproduced except in full, without prior written approval of the Company. Any unauthorized alteration, forgery or falsification of the content or appearance of this document is unlawful and offenders may be prosecuted to the fullest extent of the law.

Report Number :ER-2020-B0044
 Operation Mode :EDR
 Test Frequency :2441 MHz
 Test Mode :Tx CH Mid
 EUT Pol :H Plane

Test Site :SAC III Chamber
 Test Date :2021-01-12
 Temp./Humi. :21.0/39
 Antenna Pol. :VERTICAL
 Engineer :Nick

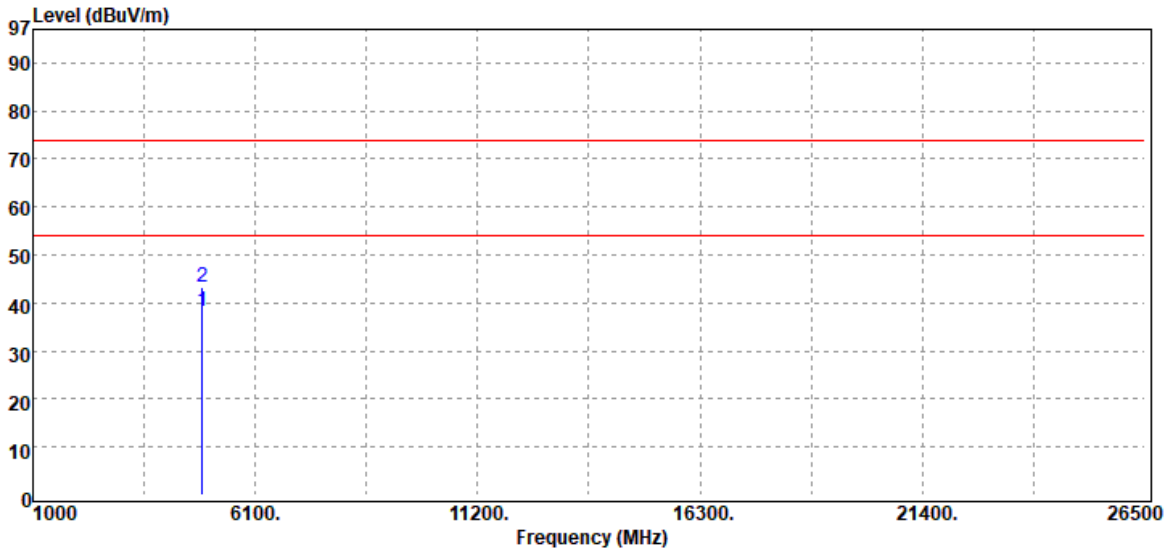

Freq. MHz	Detector Mode PK/QP/AV	Spectrum Reading Level dB μ V	Factor dB	Actual FS dB μ V/m	Limit @3m dB μ V/m	Margin dB
4882.00	Average	30.69	7.65	38.34	54.00	-15.66
4882.00	Peak	35.56	7.65	43.21	74.00	-30.79

Unless otherwise stated the results shown in this test report refer only to the sample(s) tested and such sample(s) are retained for 90 days only.

除非另有說明，此報告結果僅對測試之樣品負責，同時此樣品僅保留90天。本報告未經本公司書面許可，不可部份複製。

This document is issued by the Company subject to its General Conditions of Service printed overleaf, available on request or accessible at <http://www.sgs.com.tw/Terms-and-Conditions> and for electronic format documents, subject to Terms and Conditions for Electronic Documents at <http://www.sgs.com.tw/Terms-and-Conditions>. Attention is drawn to the limitation of liability, indemnification and jurisdiction issues defined therein. Any holder of this document is advised that information contained hereon reflects the Company's findings at the time of its intervention only and within the limits of Client's instructions, if any. The Company's sole responsibility is to its Client and this document does not exonerate parties to a transaction from exercising all their rights and obligations under the transaction documents. This document cannot be reproduced except in full, without prior written approval of the Company. Any unauthorized alteration, forgery or falsification of the content or appearance of this document is unlawful and offenders may be prosecuted to the fullest extent of the law.

Report Number :ER-2020-B0044
 Operation Mode :EDR
 Test Frequency :2441 MHz
 Test Mode :Tx CH Mid
 EUT Pol :H Plane

Test Site :SAC III Chamber
 Test Date :2021-01-12
 Temp./Humi. :21.0/39
 Antenna Pol. :HORIZONTAL
 Engineer :Nick

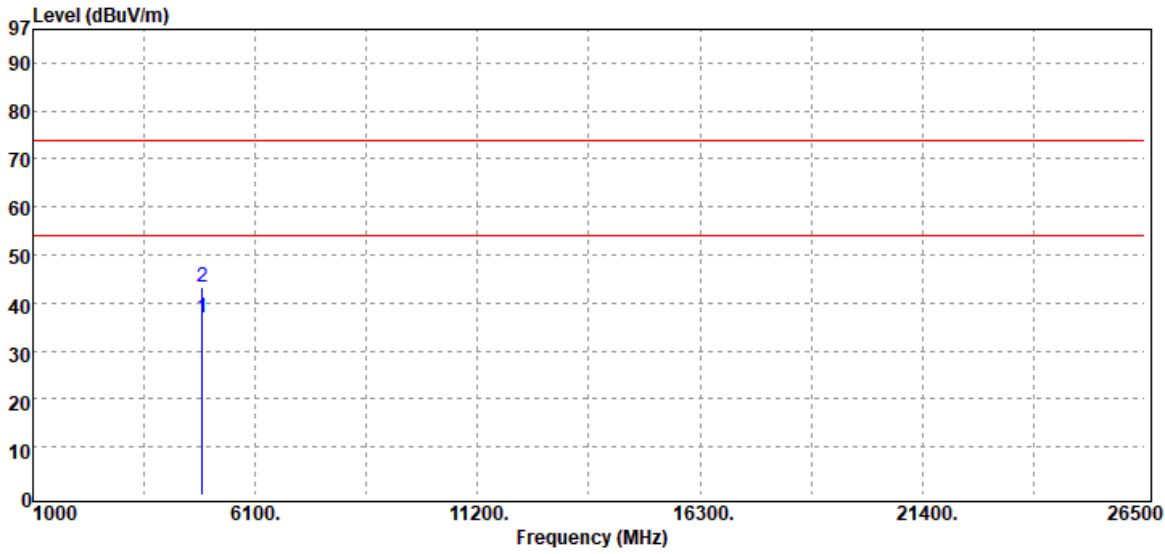

Freq. MHz	Detector Mode PK/QP/AV	Spectrum Reading Level dB μ V	Factor dB	Actual FS dB μ V/m	Limit @3m dB μ V/m	Margin dB
4882.00	Average	29.22	7.65	36.87	54.00	-17.13
4882.00	Peak	35.67	7.65	43.32	74.00	-30.68

Unless otherwise stated the results shown in this test report refer only to the sample(s) tested and such sample(s) are retained for 90 days only.

除非另有說明，此報告結果僅對測試之樣品負責，同時此樣品僅保留90天。本報告未經本公司書面許可，不可部份複製。

This document is issued by the Company subject to its General Conditions of Service printed overleaf, available on request or accessible at <http://www.sgs.com.tw/Terms-and-Conditions> and for electronic format documents, subject to Terms and Conditions for Electronic Documents at <http://www.sgs.com.tw/Terms-and-Conditions>. Attention is drawn to the limitation of liability, indemnification and jurisdiction issues defined therein. Any holder of this document is advised that information contained hereon reflects the Company's findings at the time of its intervention only and within the limits of Client's instructions, if any. The Company's sole responsibility is to its Client and this document does not exonerate parties to a transaction from exercising all their rights and obligations under the transaction documents. This document cannot be reproduced except in full, without prior written approval of the Company. Any unauthorized alteration, forgery or falsification of the content or appearance of this document is unlawful and offenders may be prosecuted to the fullest extent of the law.

Report Number :ER-2020-B0044
 Operation Mode :EDR
 Test Frequency :2480 MHz
 Test Mode :Tx CH High
 EUT Pol :H Plane

Test Site :SAC III Chamber
 Test Date :2021-01-12
 Temp./Humi. :21.0/39
 Antenna Pol. :VERTICAL
 Engineer :Nick

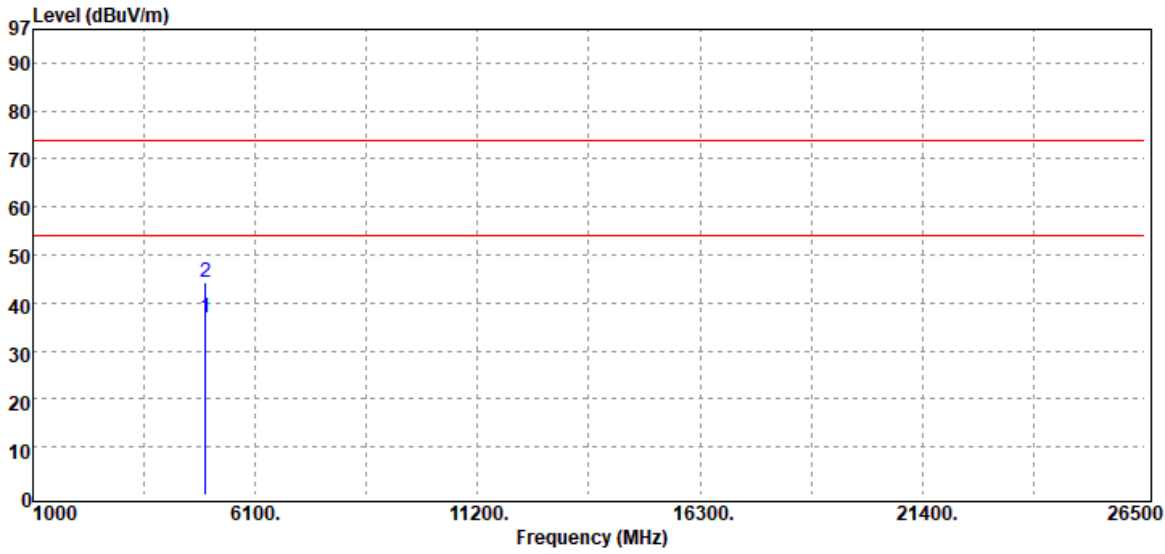

Freq. MHz	Detector Mode PK/QP/AV	Spectrum Reading Level dB μ V	Factor dB	Actual FS dB μ V/m	Limit @3m dB μ V/m	Margin dB
4960.00	Average	29.00	7.94	36.94	54.00	-17.06
4960.00	Peak	36.23	7.94	44.17	74.00	-29.83

Unless otherwise stated the results shown in this test report refer only to the sample(s) tested and such sample(s) are retained for 90 days only.

除非另有說明，此報告結果僅對測試之樣品負責，同時此樣品僅保留90天。本報告未經本公司書面許可，不可部份複製。

This document is issued by the Company subject to its General Conditions of Service printed overleaf, available on request or accessible at <http://www.sgs.com.tw/Terms-and-Conditions> and for electronic format documents, subject to Terms and Conditions for Electronic Documents at <http://www.sgs.com.tw/Terms-and-Conditions>. Attention is drawn to the limitation of liability, indemnification and jurisdiction issues defined therein. Any holder of this document is advised that information contained hereon reflects the Company's findings at the time of its intervention only and within the limits of Client's instructions, if any. The Company's sole responsibility is to its Client and this document does not exonerate parties to a transaction from exercising all their rights and obligations under the transaction documents. This document cannot be reproduced except in full, without prior written approval of the Company. Any unauthorized alteration, forgery or falsification of the content or appearance of this document is unlawful and offenders may be prosecuted to the fullest extent of the law.

Report Number :ER-2020-B0044
 Operation Mode :EDR
 Test Frequency :2480 MHz
 Test Mode :Tx CH High
 EUT Pol :H Plane

Test Site :SAC III Chamber
 Test Date :2021-01-12
 Temp./Humi. :21.0/39
 Antenna Pol. :HORIZONTAL
 Engineer :Nick

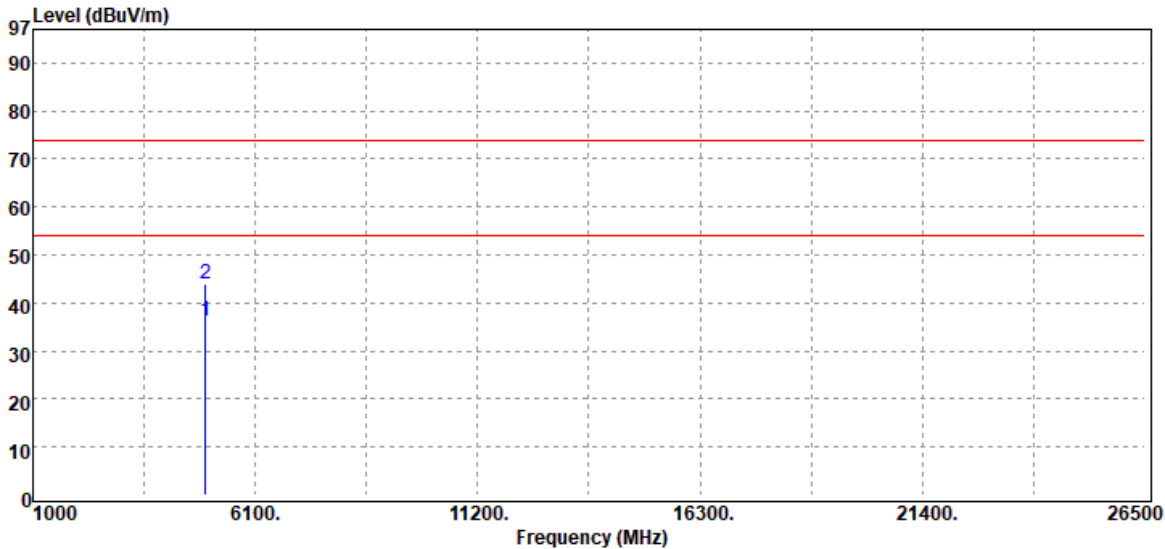

Freq. MHz	Detector Mode PK/QP/AV	Spectrum Reading Level dB μ V	Factor dB	Actual FS dB μ V/m	Limit @3m dB μ V/m	Margin dB
4960.00	Average	28.24	7.94	36.18	54.00	-17.82
4960.00	Peak	36.18	7.94	44.12	74.00	-29.88

Unless otherwise stated the results shown in this test report refer only to the sample(s) tested and such sample(s) are retained for 90 days only.

除非另有說明，此報告結果僅對測試之樣品負責，同時此樣品僅保留90天。本報告未經本公司書面許可，不可部份複製。

This document is issued by the Company subject to its General Conditions of Service printed overleaf, available on request or accessible at <http://www.sgs.com.tw/Terms-and-Conditions> and for electronic format documents, subject to Terms and Conditions for Electronic Documents at <http://www.sgs.com.tw/Terms-and-Conditions>. Attention is drawn to the limitation of liability, indemnification and jurisdiction issues defined therein. Any holder of this document is advised that information contained hereon reflects the Company's findings at the time of its intervention only and within the limits of Client's instructions, if any. The Company's sole responsibility is to its Client and this document does not exonerate parties to a transaction from exercising all their rights and obligations under the transaction documents. This document cannot be reproduced except in full, without prior written approval of the Company. Any unauthorized alteration, forgery or falsification of the content or appearance of this document is unlawful and offenders may be prosecuted to the fullest extent of the law.

11 FREQUENCY SEPARATION

11.1 Standard Applicable

Frequency hopping systems shall have hopping channel carrier frequencies separated by minimum of 25 kHz or the $2/3 \times 20\text{dB}$ bandwidth of the hopping channel, whichever is greater.

11.2 Measurement Equipment Used

Conducted Emission Test Site					
EQUIPMENT TYPE	MFR	MODEL NUMBER	SERIAL NUMBER	LAST CAL.	CAL DUE.
EXA Spectrum Analyzer	Agilent	N9010A	MY50420195	05/06/2020	05/05/2021
DC Power Supply	Agilent	E3640A	MY52410006	12/17/2020	12/16/2021
DC Power Supply	Agilent	E3640A	KR93300208	08/19/2020	08/18/2021
DC Block	Mini-Circuits	BLK-18-S+	1	12/16/2020	12/15/2021

11.3 Test Set-up

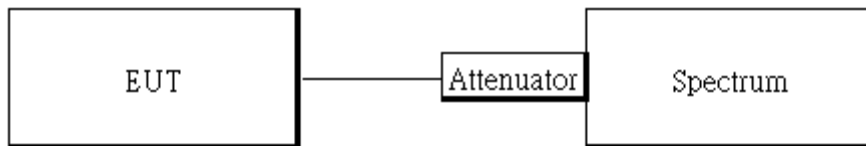

11.4 Measurement Procedure

1. Place the EUT on the table and set it in transmitting mode.
2. The testing follows ANSI C63.10:2013.
3. Remove the antenna from the EUT and then connect a low loss RF cable from the antenna port to the spectrum analyzer.
4. Set center frequency of spectrum analyzer = middle of hopping channel.
5. Set the spectrum analyzer as RBW, VBW=100 kHz, Adjust Span to 5MHz, Sweep = auto.
6. Max hold. Mark 3 Peaks of hopping channel and record the 3 peaks frequency.

11.5 Measurement Result

Channel separation (MHz)	Limit	Result
1	$\geq 25 \text{ kHz}$ or $2/3 \text{ times } 20\text{dB bandwidth}$	PASS

Unless otherwise stated the results shown in this test report refer only to the sample(s) tested and such sample(s) are retained for 90 days only.

除非另有說明，此報告結果僅對測試之樣品負責，同時此樣品僅保留90天。本報告未經本公司書面許可，不可部份複製。

This document is issued by the Company subject to its General Conditions of Service printed overleaf, available on request or accessible at <http://www.sgs.com.tw/Terms-and-Conditions> and for electronic format documents, subject to Terms and Conditions for Electronic Documents at <http://www.sgs.com.tw/Terms-and-Conditions>. Attention is drawn to the limitation of liability, indemnification and jurisdiction issues defined therein. Any holder of this document is advised that information contained hereon reflects the Company's findings at the time of its intervention only and within the limits of Client's instructions, if any. The Company's sole responsibility is to its Client and this document does not exonerate parties to a transaction from exercising all their rights and obligations under the transaction documents. This document cannot be reproduced except in full, without prior written approval of the Company. Any unauthorized alteration, forgery or falsification of the content or appearance of this document is unlawful and offenders may be prosecuted to the fullest extent of the law.

11.6 Frequency Separation Test Plots

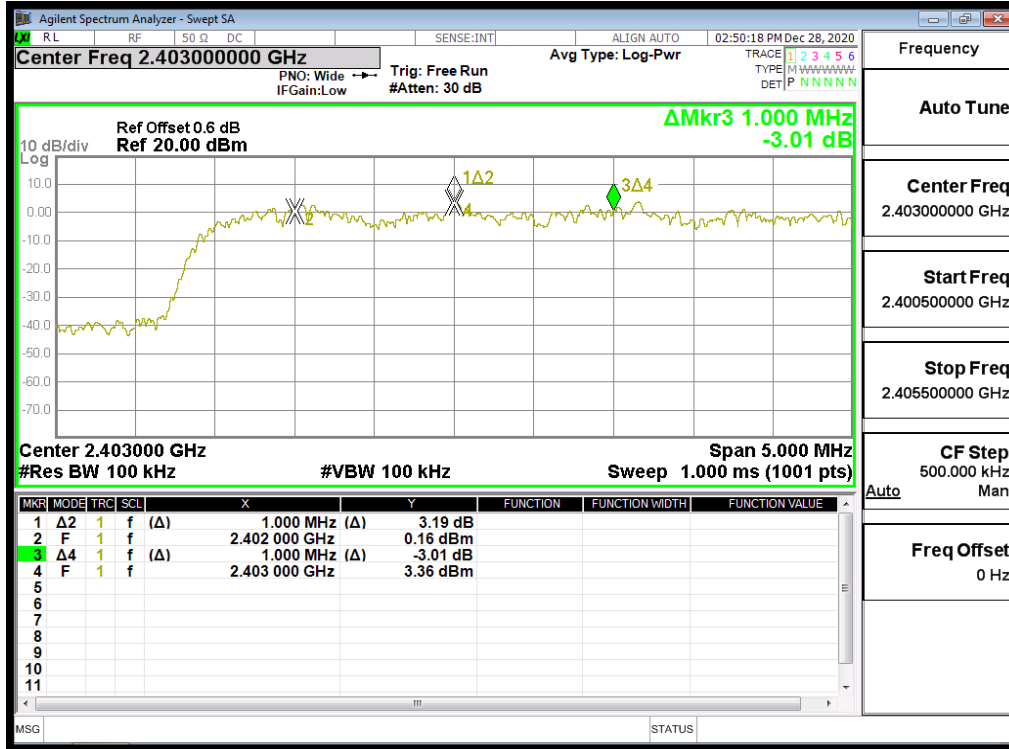

Unless otherwise stated the results shown in this test report refer only to the sample(s) tested and such sample(s) are retained for 90 days only.

除非另有說明，此報告結果僅對測試之樣品負責，同時此樣品僅保留90天。本報告未經本公司書面許可，不可部份複製。

This document is issued by the Company subject to its General Conditions of Service printed overleaf, available on request or accessible at <http://www.sgs.com.tw/Terms-and-Conditions> and for electronic format documents, subject to Terms and Conditions for Electronic Documents at <http://www.sgs.com.tw/Terms-and-Conditions>. Attention is drawn to the limitation of liability, indemnification and jurisdiction issues defined therein. Any holder of this document is advised that information contained hereon reflects the Company's findings at the time of its intervention only and within the limits of Client's instructions, if any. The Company's sole responsibility is to its Client and this document does not exonerate parties to a transaction from exercising all their rights and obligations under the transaction documents. This document cannot be reproduced except in full, without prior written approval of the Company. Any unauthorized alteration, forgery or falsification of the content or appearance of this document is unlawful and offenders may be prosecuted to the fullest extent of the law.

12 NUMBER OF HOPPING FREQUENCY

12.1 Standard Applicable

Frequency hopping systems operating in the 2400MHz-2483.5 MHz bands shall use at least 15 hopping frequencies.

12.2 Measurement Equipment Used

Conducted Emission Test Site					
EQUIPMENT TYPE	MFR	MODEL NUMBER	SERIAL NUMBER	LAST CAL.	CAL DUE.
EXA Spectrum Analyzer	Agilent	N9010A	MY50420195	05/06/2020	05/05/2021
DC Power Supply	Agilent	E3640A	MY52410006	12/17/2020	12/16/2021
DC Power Supply	Agilent	E3640A	KR93300208	08/19/2020	08/18/2021
DC Block	Mini-Circuits	BLK-18-S+	1	12/16/2020	12/15/2021

12.3 Test Set-up

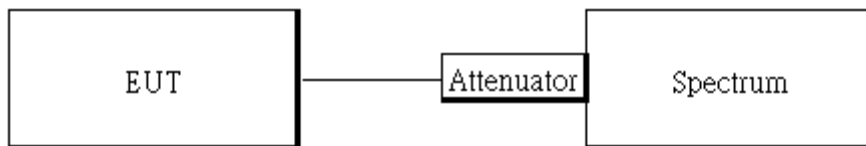

12.4 Measurement Procedure

1. Place the EUT on the table and set it in transmitting mode.
2. The testing follows ANSI C63.10:2013.
3. Remove the antenna from the EUT and then connect a low loss RF cable from the antenna port to the spectrum analyzer.
4. Set spectrum analyzer Start=2400MHz, Stop = 2483.5MHz, Sweep = auto.
5. Set the spectrum analyzer as RBW=430kHz, VBW=1.5MHz., Detector = Peak
6. Max hold, view and count how many channel in the band.

12.5 Measurement Result

Tabular Data of Total Channel Number

	Channel Number	Limit
2.4 GHz – 2.441 GHz	40	>15
2.441 GHz – 2.4835 GHz	39	
2.4 GHz ~2.4835 GHz	(40+39) = 79	

Unless otherwise stated the results shown in this test report refer only to the sample(s) tested and such sample(s) are retained for 90 days only.

除非另有說明，此報告結果僅對測試之樣品負責，同時此樣品僅保留90天。本報告未經本公司書面許可，不可部份複製。

This document is issued by the Company subject to its General Conditions of Service printed overleaf, available on request or accessible at <http://www.sgs.com.tw/Terms-and-Conditions> and for electronic format documents, subject to Terms and Conditions for Electronic Documents at <http://www.sgs.com.tw/Terms-and-Conditions>. Attention is drawn to the limitation of liability, indemnification and jurisdiction issues defined therein. Any holder of this document is advised that information contained hereon reflects the Company's findings at the time of its intervention only and within the limits of Client's instructions, if any. The Company's sole responsibility is to its Client and this document does not exonerate parties to a transaction from exercising all their rights and obligations under the transaction documents. This document cannot be reproduced except in full, without prior written approval of the Company. Any unauthorized alteration, forgery or falsification of the content or appearance of this document is unlawful and offenders may be prosecuted to the fullest extent of the law.

12.6 Channel Number Test Plots

2400-2441

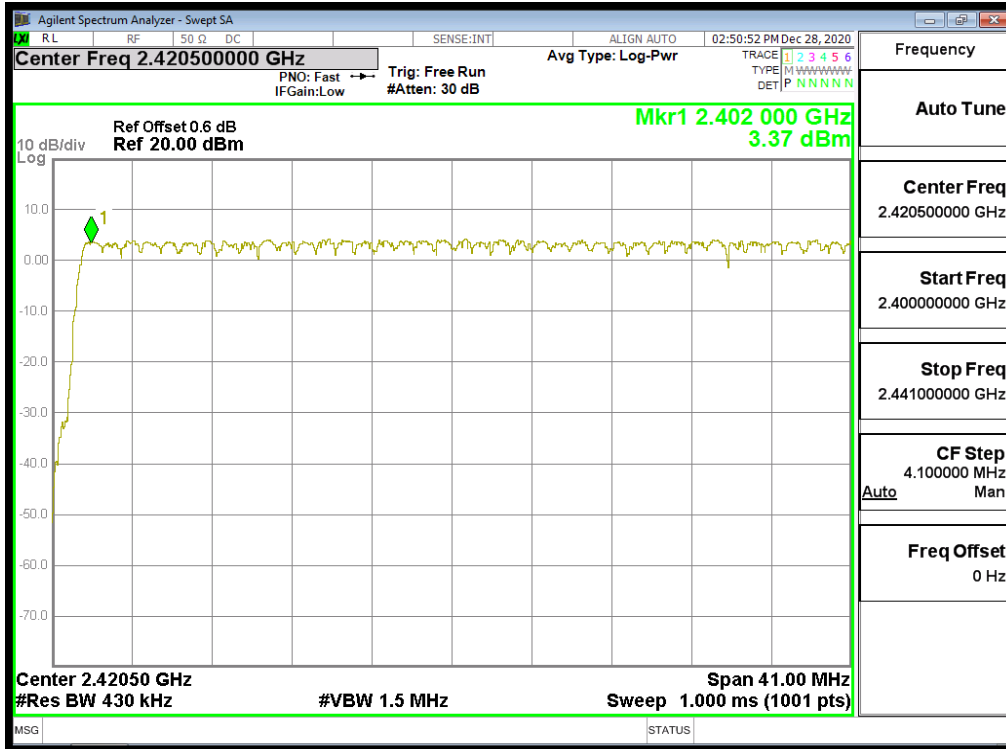

2441-2480

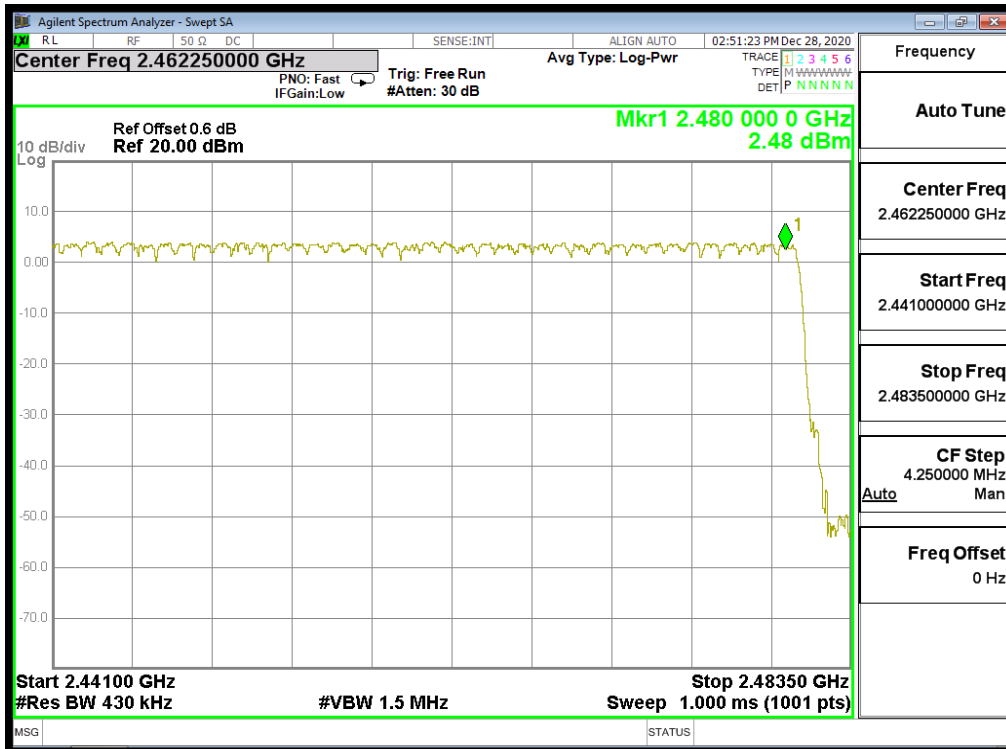

Unless otherwise stated the results shown in this test report refer only to the sample(s) tested and such sample(s) are retained for 90 days only.

除非另有說明，此報告結果僅對測試之樣品負責，同時此樣品僅保留90天。本報告未經本公司書面許可，不可部份複製。

This document is issued by the Company subject to its General Conditions of Service printed overleaf, available on request or accessible at <http://www.sgs.com.tw/Terms-and-Conditions> and for electronic format documents, subject to Terms and Conditions for Electronic Documents at <http://www.sgs.com.tw/Terms-and-Conditions>. Attention is drawn to the limitation of liability, indemnification and jurisdiction issues defined therein. Any holder of this document is advised that information contained hereon reflects the Company's findings at the time of its intervention only and within the limits of Client's instructions, if any. The Company's sole responsibility is to its Client and this document does not exonerate parties to a transaction from exercising all their rights and obligations under the transaction documents. This document cannot be reproduced except in full, without prior written approval of the Company. Any unauthorized alteration, forgery or falsification of the content or appearance of this document is unlawful and offenders may be prosecuted to the fullest extent of the law.

13 TIME OF OCCUPANCY (DWEELL TIME)

13.1 Standard Applicable

Frequency hopping systems operating in the 2400MHz-2483.5MHz. The average time of occupancy on any frequency shall not greater than 0.4 s within period of 0.4 seconds multiplied by the number of hopping channel employed.

13.2 Measurement Equipment Used

Conducted Emission Test Site					
EQUIPMENT TYPE	MFR	MODEL NUMBER	SERIAL NUMBER	LAST CAL.	CAL DUE.
EXA Spectrum Analyzer	Agilent	N9010A	MY50420195	05/06/2020	05/05/2021
DC Power Supply	Agilent	E3640A	MY52410006	12/17/2020	12/16/2021
DC Power Supply	Agilent	E3640A	KR93300208	08/19/2020	08/18/2021
DC Block	Mini-Circuits	BLK-18-S+	1	12/16/2020	12/15/2021

13.3 Test Set-up

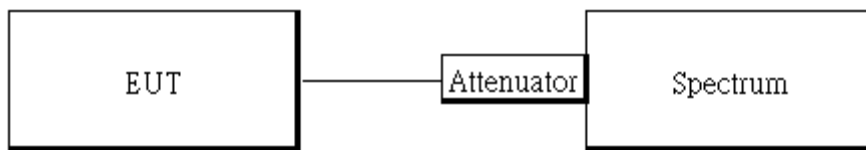

Unless otherwise stated the results shown in this test report refer only to the sample(s) tested and such sample(s) are retained for 90 days only.

除非另有說明，此報告結果僅對測試之樣品負責，同時此樣品僅保留90天。本報告未經本公司書面許可，不可部份複製。

This document is issued by the Company subject to its General Conditions of Service printed overleaf, available on request or accessible at <http://www.sgs.com.tw/Terms-and-Conditions> and for electronic format documents, subject to Terms and Conditions for Electronic Documents at <http://www.sgs.com.tw/Terms-and-Conditions>. Attention is drawn to the limitation of liability, indemnification and jurisdiction issues defined therein. Any holder of this document is advised that information contained hereon reflects the Company's findings at the time of its intervention only and within the limits of Client's instructions, if any. The Company's sole responsibility is to its Client and this document does not exonerate parties to a transaction from exercising all their rights and obligations under the transaction documents. This document cannot be reproduced except in full, without prior written approval of the Company. Any unauthorized alteration, forgery or falsification of the content or appearance of this document is unlawful and offenders may be prosecuted to the fullest extent of the law.

13.4 Measurement Procedure

1. Place the EUT on the table and set it in transmitting mode.
2. The testing follows ANSI C6310:2015.
3. Remove the antenna from the EUT and then connect a low loss RF cable from the antenna port to the spectrum analyzer.
4. Set center frequency of spectrum analyzer = operating frequency.
5. Set the spectrum analyzer as RBW, VBW=1MHz, 3MHz, Span = 0Hz , Detector = Peak, Adjust Sweep = 2~8ms.
6. Repeat above procedures until all frequency of the interest measured were complete.

Formula Deduced: time occupancy of one time slot X Hopping rate / total slot in one channel / total channel that hops X period of working channels.

Where, standard hopping rate is 1600 hops/s, slot in one channel for DH1, DH3, and DH5 is 2, 4, and 6, respectively.

DH1 consists of single time slot of the uplink, and one slot of the downlink Total Slot: 2

DH3 consists of three time slot of the uplink, and one slot of the downlink. Total Slot: 4

DH5 consists of five time slot of the uplink, and one slot of the downlink. Total Slot: 6

In AFH mode, hopping rate is 800 hop/s with 6 slots in 20 hopping channels with channel hopping rate (800 / 6 / 20) in Occupancy Time Limit (0.4 * 20) (S), Hop Over Occupancy Time comes to (800 / 6 / 20)*(0.4 *20) =53.33

Note: the result of the complete test default channel at 1Mbps is recorded on the test report, 2Mbps, and 3Mbps only records the measurement result at middle channel that reveals no much deviation.

Unless otherwise stated the results shown in this test report refer only to the sample(s) tested and such sample(s) are retained for 90 days only.

除非另有說明，此報告結果僅對測試之樣品負責，同時此樣品僅保留90天。本報告未經本公司書面許可，不可部份複製。

This document is issued by the Company subject to its General Conditions of Service printed overleaf, available on request or accessible at <http://www.sgs.com.tw/Terms-and-Conditions> and for electronic format documents, subject to Terms and Conditions for Electronic Documents at <http://www.sgs.com.tw/Terms-and-Conditions>. Attention is drawn to the limitation of liability, indemnification and jurisdiction issues defined therein. Any holder of this document is advised that information contained hereon reflects the Company's findings at the time of its intervention only and within the limits of Client's instructions, if any. The Company's sole responsibility is to its Client and this document does not exonerate parties to a transaction from exercising all their rights and obligations under the transaction documents. This document cannot be reproduced except in full, without prior written approval of the Company. Any unauthorized alteration, forgery or falsification of the content or appearance of this document is unlawful and offenders may be prosecuted to the fullest extent of the law.

13.5 Tabular Result of the Measurement

GFSK (1Mbps)

Channel	PACKET TYPE	Measurement Result (ms)	Limit (ms)	1/T (kHz)	VBW setting (kHz)
Low	DH1	121.60	400ms	2.632	3.00
	DH3	262.40	400ms	0.610	1.00
	DH5	307.20	400ms	0.347	1.00
Mid	DH1	121.60	400ms	2.632	3.00
	DH3	262.40	400ms	0.610	1.00
	DH5	307.20	400ms	0.347	1.00
High	DH1	123.20	400ms	2.597	3.00
	DH3	260.80	400ms	0.613	1.00
	DH5	307.20	400ms	0.003	1.00

$\pi/4$ DQPSK (2Mbps)

Channel	PACKET TYPE	Measurement Result (ms)	Limit (ms)	1/T (kHz)	VBW setting (kHz)
Mid	2DH1	124.80	400ms	2.564	3.00
	2DH3	262.40	400ms	0.610	1.00
	2DH5	307.20	400ms	0.347	1.00

8-DPSK (3Mbps)

Channel	PACKET TYPE	Measurement Result (ms)	Limit (ms)	1/T (kHz)	VBW setting (kHz)
Mid	3DH1	124.80	400ms	2.564	3.00
	3DH3	260.80	400ms	0.613	1.00
	3DH5	307.20	400ms	0.347	1.00

Unless otherwise stated the results shown in this test report refer only to the sample(s) tested and such sample(s) are retained for 90 days only.

除非另有說明，此報告結果僅對測試之樣品負責，同時此樣品僅保留90天。本報告未經本公司書面許可，不可部份複製。

This document is issued by the Company subject to its General Conditions of Service printed overleaf, available on request or accessible at <http://www.sgs.com.tw/Terms-and-Conditions> and for electronic format documents, subject to Terms and Conditions for Electronic Documents at <http://www.sgs.com.tw/Terms-and-Conditions>. Attention is drawn to the limitation of liability, indemnification and jurisdiction issues defined therein. Any holder of this document is advised that information contained hereon reflects the Company's findings at the time of its intervention only and within the limits of Client's instructions, if any. The Company's sole responsibility is to its Client and this document does not exonerate parties to a transaction from exercising all their rights and obligations under the transaction documents. This document cannot be reproduced except in full, without prior written approval of the Company. Any unauthorized alteration, forgery or falsification of the content or appearance of this document is unlawful and offenders may be prosecuted to the fullest extent of the law.

GFSK (1Mbps):

CH Low	DH1 time slot =	0.380	*	(1600/2/79)	*	31.6	=	121.60	(ms)
	DH3 time slot =	1.640	*	(1600/4/79)	*	31.6	=	262.40	(ms)
	DH5 time slot =	2.880	*	(1600/6/79)	*	31.6	=	307.20	(ms)
CH Mid	DH1 time slot =	0.380	*	(1600/2/79)	*	31.6	=	121.60	(ms)
	DH3 time slot =	1.640	*	(1600/4/79)	*	31.6	=	262.40	(ms)
	DH5 time slot =	2.880	*	(1600/6/79)	*	31.6	=	307.20	(ms)
CH High	DH1 time slot =	0.385	*	(1600/2/79)	*	31.6	=	123.20	(ms)
	DH3 time slot =	1.630	*	(1600/4/79)	*	31.6	=	260.80	(ms)
	DH5 time slot =	2.880	*	(1600/6/79)	*	31.6	=	307.20	(ms)

$\pi/4$ -DQPSK (2Mbps):

CH Mid	2DH1 time slot =	0.390	*	(1600/2/79)	*	31.6	=	124.80	(ms)
	2DH3 time slot =	1.640	*	(1600/4/79)	*	31.6	=	262.40	(ms)
	2DH5 time slot =	2.880	*	(1600/6/79)	*	31.6	=	307.20	(ms)

8-DPSK (3Mbps):

CH Mid	3DH1 time slot =	0.390	*	(1600/2/79)	*	31.6	=	124.80	(ms)
	3DH3 time slot =	1.630	*	(1600/4/79)	*	31.6	=	260.80	(ms)
	3DH5 time slot =	2.880	*	(1600/6/79)	*	31.6	=	307.20	(ms)

A period time = 0.4 (s) * 79 = 31.6 (s)

Unless otherwise stated the results shown in this test report refer only to the sample(s) tested and such sample(s) are retained for 90 days only.

除非另有說明，此報告結果僅對測試之樣品負責，同時此樣品僅保留90天。本報告未經本公司書面許可，不可部份複製。

This document is issued by the Company subject to its General Conditions of Service printed overleaf, available on request or accessible at <http://www.sgs.com.tw/Terms-and-Conditions> and for electronic format documents, subject to Terms and Conditions for Electronic Documents at <http://www.sgs.com.tw/Terms-and-Conditions>. Attention is drawn to the limitation of liability, indemnification and jurisdiction issues defined therein. Any holder of this document is advised that information contained hereon reflects the Company's findings at the time of its intervention only and within the limits of Client's instructions, if any. The Company's sole responsibility is to its Client and this document does not exonerate parties to a transaction from exercising all their rights and obligations under the transaction documents. This document cannot be reproduced except in full, without prior written approval of the Company. Any unauthorized alteration, forgery or falsification of the content or appearance of this document is unlawful and offenders may be prosecuted to the fullest extent of the law.

GFSK (1Mbps) for AFH Mode			
Hopping Channel Number	PACKET TYPE	Measurement Result (ms)	Limit (ms)
20	DH5	153.60	400ms
$\pi/4$ DQPSK (2Mbps) for AFH Mode			
Hopping Channel Number	PACKET TYPE	Measurement Result (ms)	Limit (ms)
20	2DH5	153.60	400ms
8-DPSK (3Mbps) for AFH Mode			
Hopping Channel Number	PACKET TYPE	Measurement Result (ms)	Limit (ms)
20	3DH5	153.60	400ms

13.6 Measurement Result

Note: Refer to next page for plots.

Unless otherwise stated the results shown in this test report refer only to the sample(s) tested and such sample(s) are retained for 90 days only.

除非另有說明，此報告結果僅對測試之樣品負責，同時此樣品僅保留90天。本報告未經本公司書面許可，不可部份複製。

This document is issued by the Company subject to its General Conditions of Service printed overleaf, available on request or accessible at <http://www.sgs.com.tw/Terms-and-Conditions> and for electronic format documents, subject to Terms and Conditions for Electronic Documents at <http://www.sgs.com.tw/Terms-and-Conditions>. Attention is drawn to the limitation of liability, indemnification and jurisdiction issues defined therein. Any holder of this document is advised that information contained hereon reflects the Company's findings at the time of its intervention only and within the limits of Client's instructions, if any. The Company's sole responsibility is to its Client and this document does not exonerate parties to a transaction from exercising all their rights and obligations under the transaction documents. This document cannot be reproduced except in full, without prior written approval of the Company. Any unauthorized alteration, forgery or falsification of the content or appearance of this document is unlawful and offenders may be prosecuted to the fullest extent of the law.

GFSK_1M_DH1_2402MHz

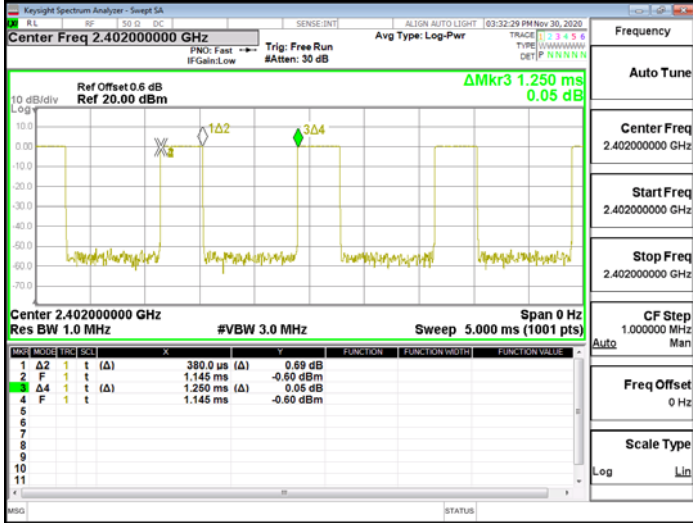

GFSK_1M_DH3_2402MHz



GFSK_1M_DH1_2441MHz



GFSK_1M_DH3_2441MHz

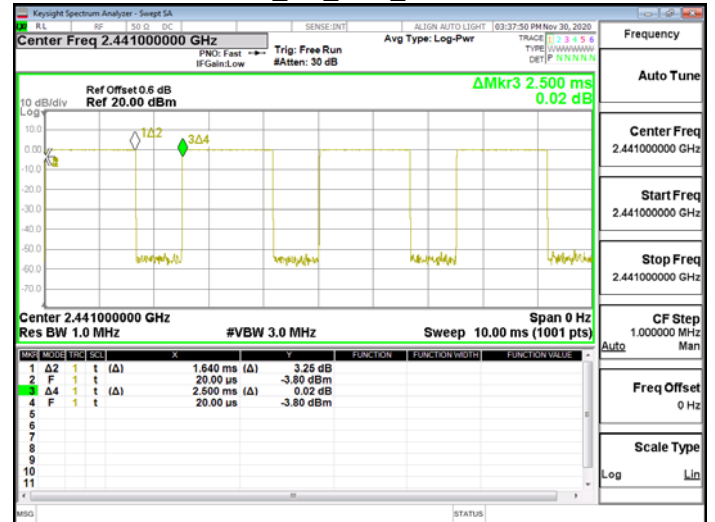

GFSK_1M_DH1_2480MHz

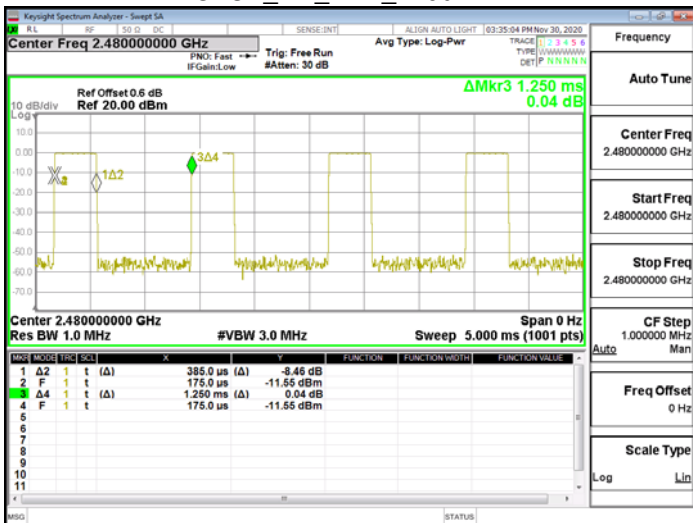

GFSK_1M_DH3_2480MHz

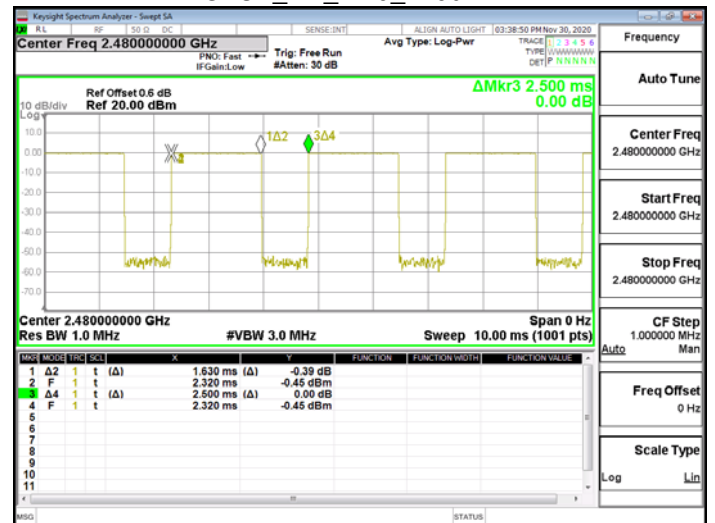

Unless otherwise stated the results shown in this test report refer only to the sample(s) tested and such sample(s) are retained for 90 days only.

除非另有說明，此報告結果僅對測試之樣品負責，同時此樣品僅保留90天。本報告未經本公司書面許可，不可部份複製。

This document is issued by the Company subject to its General Conditions of Service printed overleaf, available on request or accessible at <http://www.sgs.com.tw/Terms-and-Conditions> and for electronic format documents, subject to Terms and Conditions for Electronic Documents at <http://www.sgs.com.tw/Terms-and-Conditions>. Attention is drawn to the limitation of liability, indemnification and jurisdiction issues defined therein. Any holder of this document is advised that information contained hereon reflects the Company's findings at the time of its intervention only and within the limits of Client's instructions, if any. The Company's sole responsibility is to its Client and this document does not exonerate parties to a transaction from exercising all their rights and obligations under the transaction documents. This document cannot be reproduced except in full, without prior written approval of the Company. Any unauthorized alteration, forgery or falsification of the content or appearance of this document is unlawful and offenders may be prosecuted to the fullest extent of the law.

GFSK_1M_DH5_2402MHz

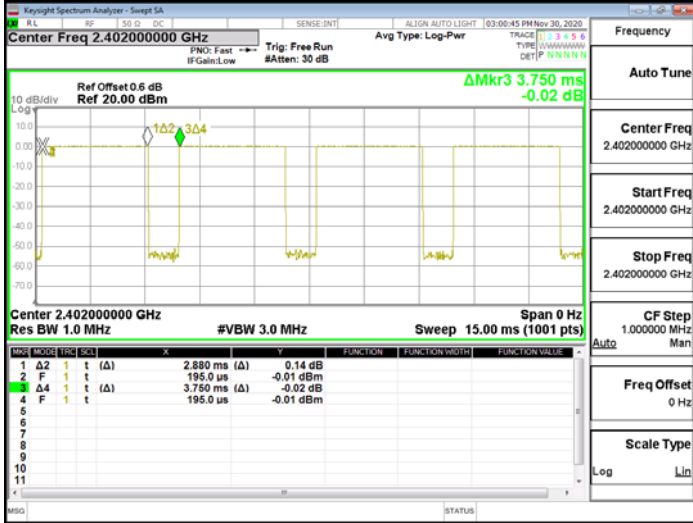

π /4DQPSK_2M_DH1_2402MHz

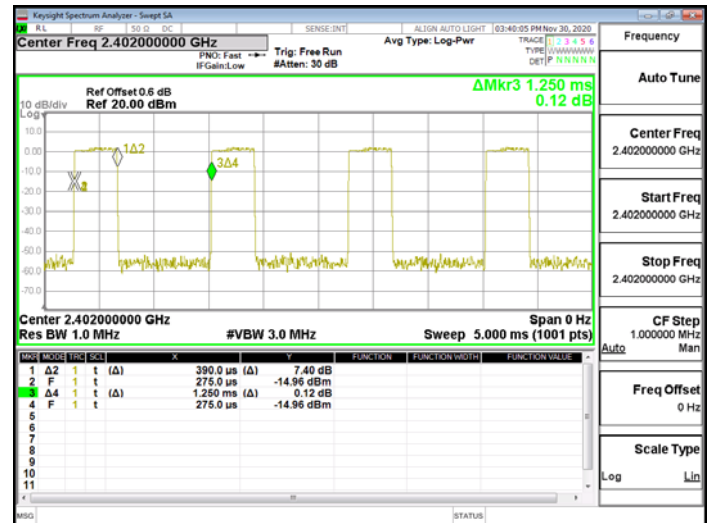

GFSK_1M_DH5_2441MHz

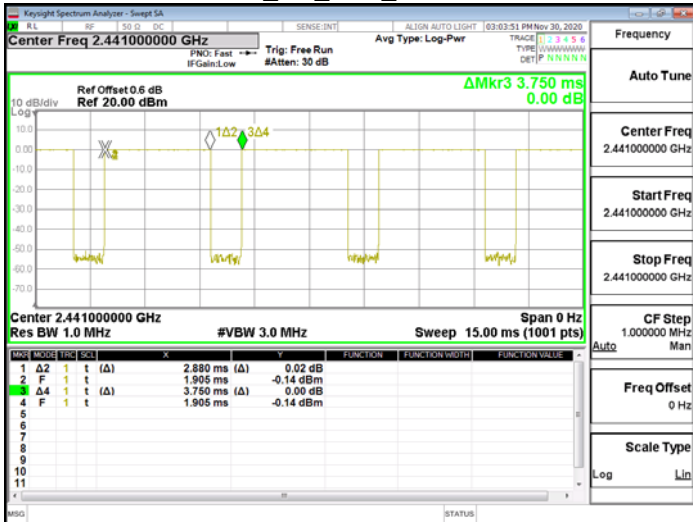

π /4DQPSK_2M_DH1_2441MHz

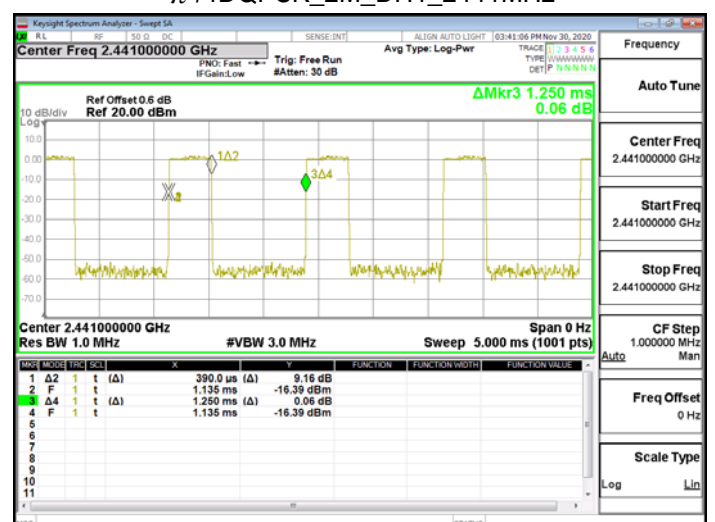

GFSK_1M_DH5_2480MHz

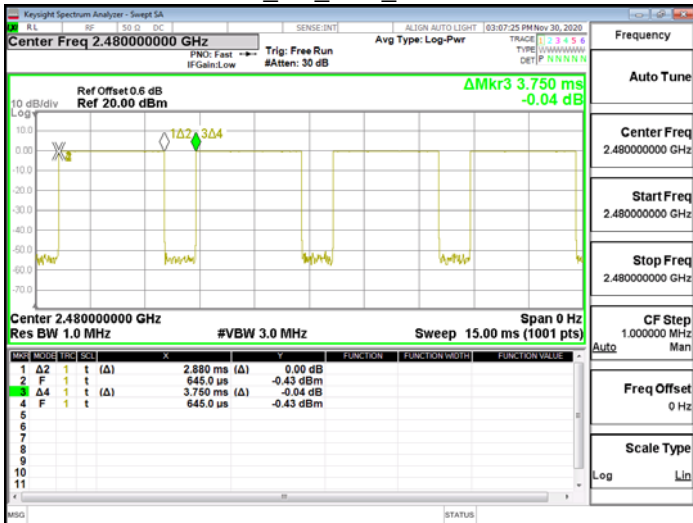

π /4DQPSK_2M_DH1_2480MHz

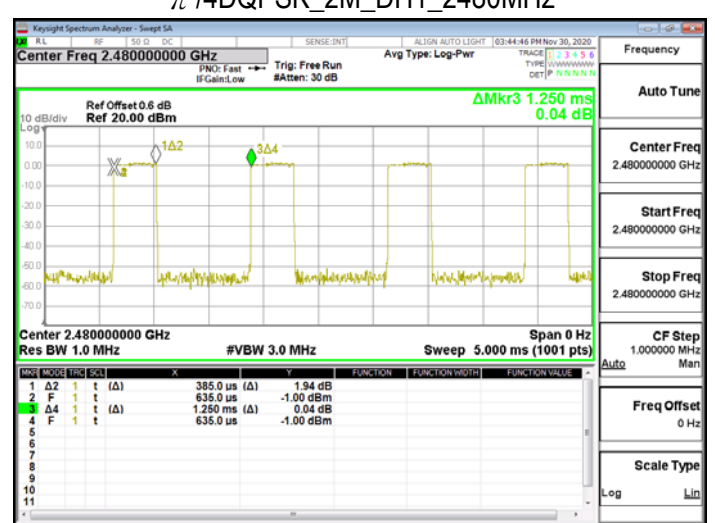

Unless otherwise stated the results shown in this test report refer only to the sample(s) tested and such sample(s) are retained for 90 days only.

除非另有說明，此報告結果僅對測試之樣品負責，同時此樣品僅保留90天。本報告未經本公司書面許可，不可部份複製。

This document is issued by the Company subject to its General Conditions of Service printed overleaf, available on request or accessible at <http://www.sgs.com.tw/Terms-and-Conditions> and for electronic format documents, subject to Terms and Conditions for Electronic Documents at <http://www.sgs.com.tw/Terms-and-Conditions>. Attention is drawn to the limitation of liability, indemnification and jurisdiction issues defined therein. Any holder of this document is advised that information contained hereon reflects the Company's findings at the time of its intervention only and within the limits of Client's instructions, if any. The Company's sole responsibility is to its Client and this document does not exonerate parties to a transaction from exercising all their rights and obligations under the transaction documents. This document cannot be reproduced except in full, without prior written approval of the Company. Any unauthorized alteration, forgery or falsification of the content or appearance of this document is unlawful and offenders may be prosecuted to the fullest extent of the law.

π /4DQPSK_2M_DH3_2402MHz

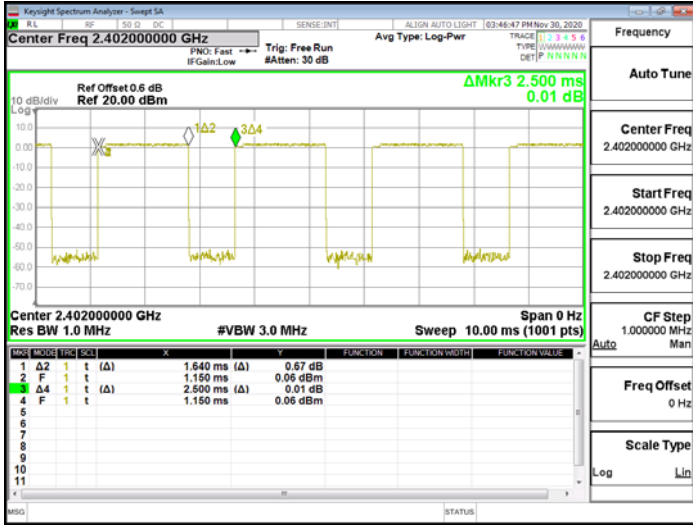

π /4DQPSK_2M_DH5_2402MHz



π /4DQPSK_2M_DH3_2441MHz

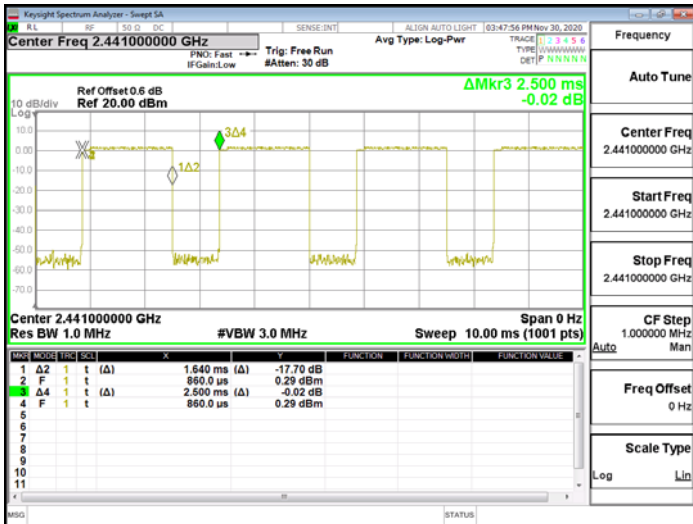

π /4DQPSK_2M_DH5_2441MHz

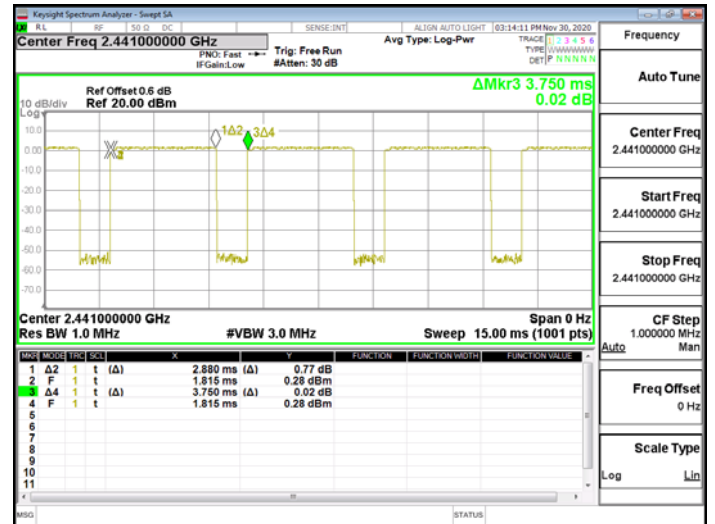

π /4DQPSK_2M_DH3_2480MHz

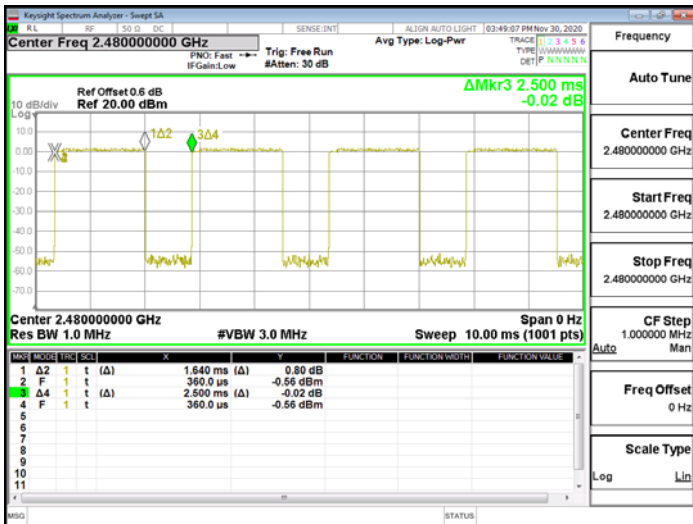

π /4DQPSK_2M_DH5_2480MHz

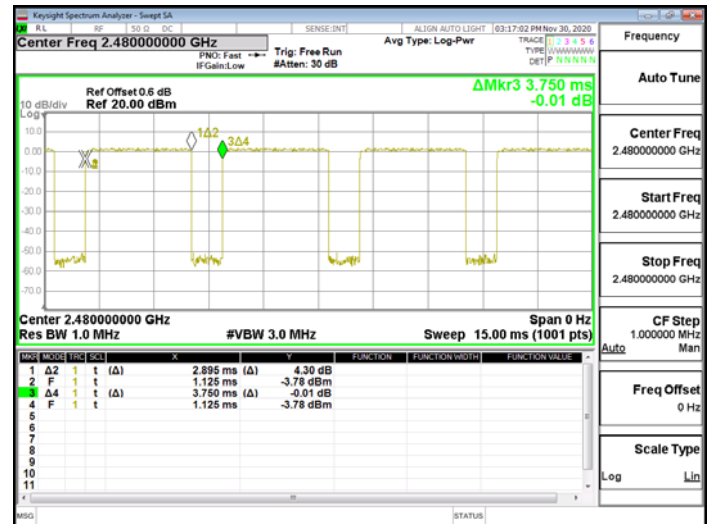

Unless otherwise stated the results shown in this test report refer only to the sample(s) tested and such sample(s) are retained for 90 days only.

除非另有說明，此報告結果僅對測試之樣品負責，同時此樣品僅保留90天。本報告未經本公司書面許可，不可部份複製。

This document is issued by the Company subject to its General Conditions of Service printed overleaf, available on request or accessible at <http://www.sgs.com.tw/Terms-and-Conditions> and for electronic format documents, subject to Terms and Conditions for Electronic Documents at <http://www.sgs.com.tw/Terms-and-Conditions>. Attention is drawn to the limitation of liability, indemnification and jurisdiction issues defined therein. Any holder of this document is advised that information contained hereon reflects the Company's findings at the time of its intervention only and within the limits of Client's instructions, if any. The Company's sole responsibility is to its Client and this document does not exonerate parties to a transaction from exercising all their rights and obligations under the transaction documents. This document cannot be reproduced except in full, without prior written approval of the Company. Any unauthorized alteration, forgery or falsification of the content or appearance of this document is unlawful and offenders may be prosecuted to the fullest extent of the law.

8DPSK_3M_DH1_2402MHz

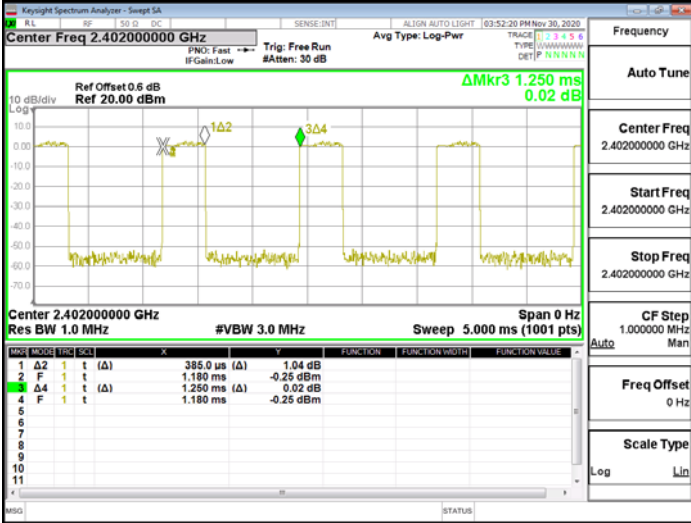

8DPSK_3M_DH3_2402MHz

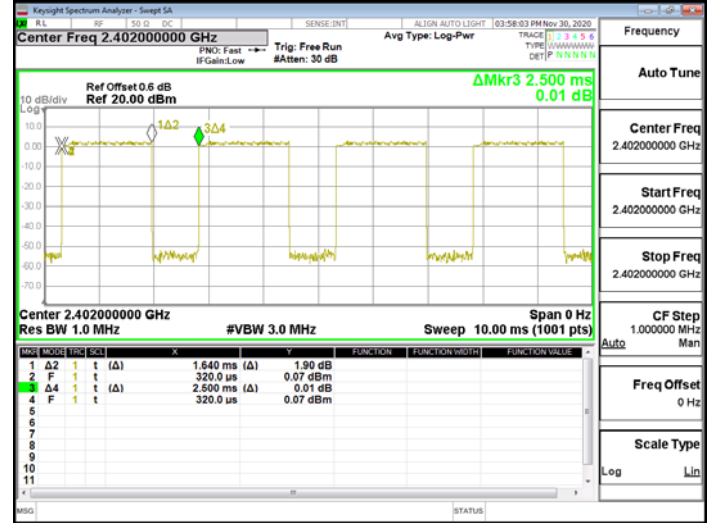

8DPSK_3M_DH1_2441MHz

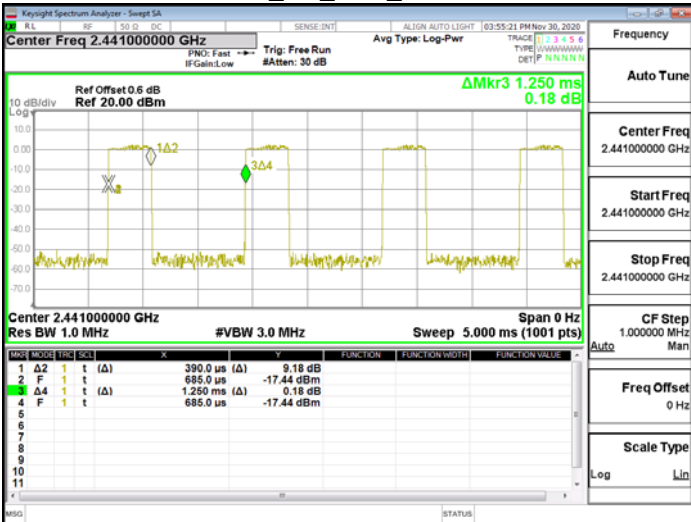

8DPSK_3M_DH3_2441MHz



8DPSK_3M_DH1_2480MHz

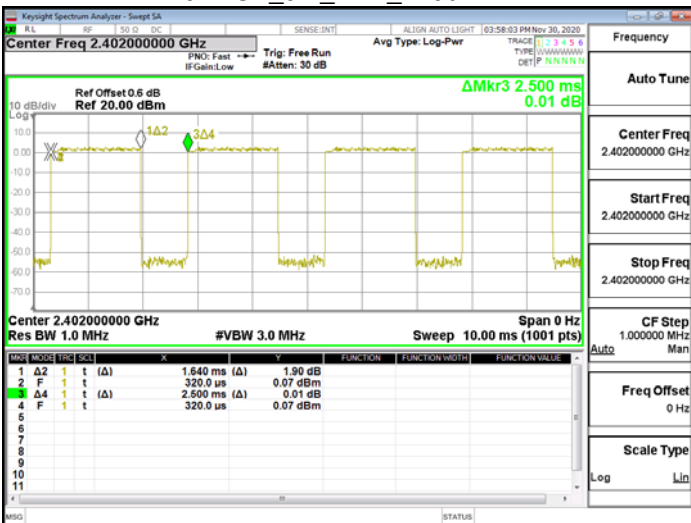

8DPSK_3M_DH3_2480MHz

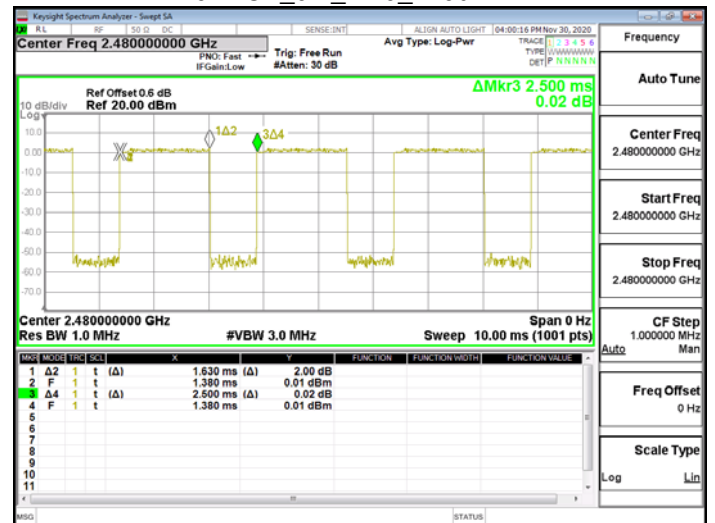

Unless otherwise stated the results shown in this test report refer only to the sample(s) tested and such sample(s) are retained for 90 days only.

除非另有說明，此報告結果僅對測試之樣品負責，同時此樣品僅保留90天。本報告未經本公司書面許可，不可部份複製。

This document is issued by the Company subject to its General Conditions of Service printed overleaf, available on request or accessible at <http://www.sgs.com.tw/Terms-and-Conditions> and for electronic format documents, subject to Terms and Conditions for Electronic Documents at <http://www.sgs.com.tw/Terms-and-Conditions>. Attention is drawn to the limitation of liability, indemnification and jurisdiction issues defined therein. Any holder of this document is advised that information contained hereon reflects the Company's findings at the time of its intervention only and within the limits of Client's instructions, if any. The Company's sole responsibility is to its Client and this document does not exonerate parties to a transaction from exercising all their rights and obligations under the transaction documents. This document cannot be reproduced except in full, without prior written approval of the Company. Any unauthorized alteration, forgery or falsification of the content or appearance of this document is unlawful and offenders may be prosecuted to the fullest extent of the law.

8DPSK_3M_DH5_2402MHz



8DPSK_3M_DH5_2441MHz

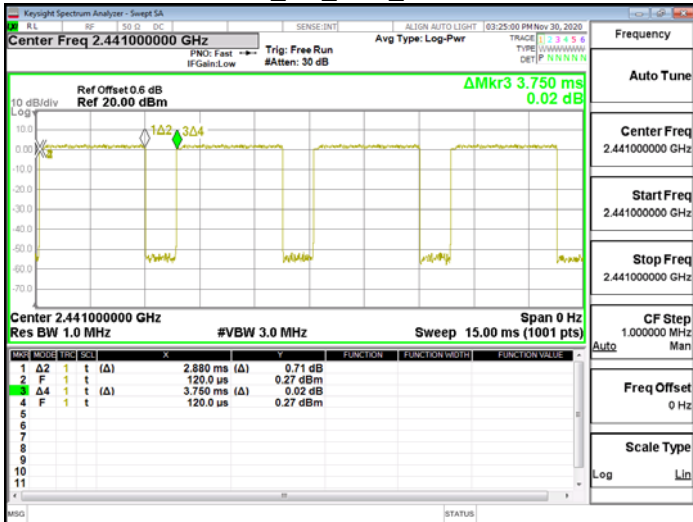

8DPSK_3M_DH5_2480MHz

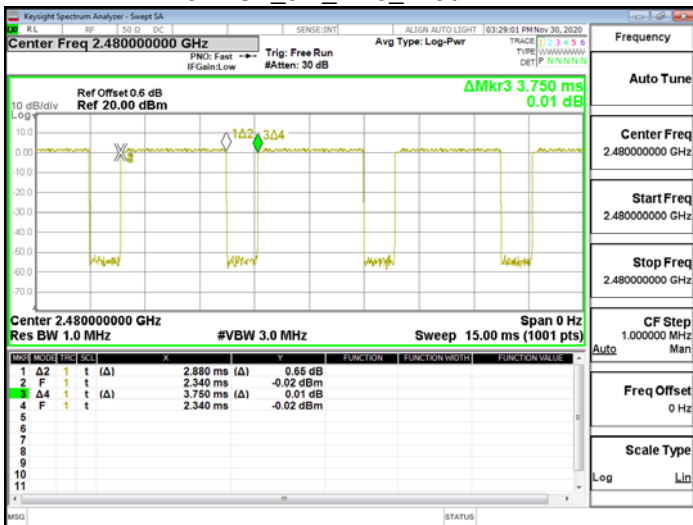

Unless otherwise stated the results shown in this test report refer only to the sample(s) tested and such sample(s) are retained for 90 days only.

除非另有說明，此報告結果僅對測試之樣品負責，同時此樣品僅保留90天。本報告未經本公司書面許可，不可部份複製。

This document is issued by the Company subject to its General Conditions of Service printed overleaf, available on request or accessible at <http://www.sgs.com.tw/Terms-and-Conditions> and for electronic format documents, subject to Terms and Conditions for Electronic Documents at <http://www.sgs.com.tw/Terms-and-Conditions>. Attention is drawn to the limitation of liability, indemnification and jurisdiction issues defined therein. Any holder of this document is advised that information contained hereon reflects the Company's findings at the time of its intervention only and within the limits of Client's instructions, if any. The Company's sole responsibility is to its Client and this document does not exonerate parties to a transaction from exercising all their rights and obligations under the transaction documents. This document cannot be reproduced except in full, without prior written approval of the Company. Any unauthorized alteration, forgery or falsification of the content or appearance of this document is unlawful and offenders may be prosecuted to the fullest extent of the law.

14 ANTENNA REQUIREMENT

14.1 Standard Applicable

For intentional device, according to §15.203, an intentional radiator shall be designed to ensure that no antenna other than furnished by the responsible party shall be used with the device.

If the transmitting antenna is greater than 6dBi, the power shall be reduced by the same level in dB comparing to gain minus 6dBi.

14.2 Antenna Connected Construction

The antenna is designed with unique RF connector and no consideration of replacement. Please see EUT photo for details.

~ End of Report ~

Unless otherwise stated the results shown in this test report refer only to the sample(s) tested and such sample(s) are retained for 90 days only.

除非另有說明，此報告結果僅對測試之樣品負責，同時此樣品僅保留90天。本報告未經本公司書面許可，不可部份複製。

This document is issued by the Company subject to its General Conditions of Service printed overleaf, available on request or accessible at <http://www.sgs.com.tw/Terms-and-Conditions> and for electronic format documents, subject to Terms and Conditions for Electronic Documents at <http://www.sgs.com.tw/Terms-and-Conditions>. Attention is drawn to the limitation of liability, indemnification and jurisdiction issues defined therein. Any holder of this document is advised that information contained hereon reflects the Company's findings at the time of its intervention only and within the limits of Client's instructions, if any. The Company's sole responsibility is to its Client and this document does not exonerate parties to a transaction from exercising all their rights and obligations under the transaction documents. This document cannot be reproduced except in full, without prior written approval of the Company. Any unauthorized alteration, forgery or falsification of the content or appearance of this document is unlawful and offenders may be prosecuted to the fullest extent of the law.