

PERMISSIVE CHANGE TEST REPORT

FCC 47 CFR PART 15 SUBPART C INDUSTRY CANADA RSS-247

Test Standard	FCC Part 15.247 RSS-247 issue 2 and RSS-GEN issue 5
FCC ID:	VPYLB1ZM
IC:	772C-LB1ZM
Product name	Communication Module
Brand Name	muRata
Model No.	LBEE5QD1ZM
Test Result	Pass
Statements of Conformity	Determination of compliance is based on the results of the compliance measurement, not taking into account measurement instrumentation uncertainty.

The test Result was tested by Compliance Certification Services Inc. The test data, data evaluation, test procedures, and equipment configurations shown in this report were given in ANSI C63.10: 2013 and compliance standards.

The test results of this report relate only to the tested sample (EUT) identified in this report.

The test Report of full or partial shall not copy. Without written approval of Compliance Certification Services Inc. (Wugu Laboratory)

Approved by:



Shawn Wu
Supervisor

Unless otherwise stated the results shown in this test report refer only to the sample(s) tested and such sample(s) are retained for 90 days only.
 除非另有說明，此報告結果僅對測試之樣品負責，同時此樣品僅保留90天。本報告未經本公司書面許可，不可部份複製。

This document is issued by the Company subject to its General Conditions of Service printed overleaf, available on request or accessible at <http://www.sgs.com.tw/Terms-and-Conditions> and, for electronic format documents, subject to Terms and Conditions for Electronic Documents at <http://www.sgs.com.tw/Terms-and-Conditions>. Attention is drawn to the limitation of liability, indemnification and jurisdiction issues defined therein. Any holder of this document is advised that information contained hereon reflects the Company's findings at the time of its intervention only and within the limits of client's instruction, if any. The Company's sole responsibility is to its Client and this document does not exonerate parties to a transaction from exercising all their rights and obligations under the transaction documents. This document cannot be reproduced, except in full, without prior written approval of the Company. Any unauthorized alteration, forgery or falsification of the content or appearance of this document is unlawful and offenders may be prosecuted to the fullest extent of the law.

Revision History

Rev.	Issue Date	Revisions	Effect Page	Revised By
00	December 11, 2020	Initial Issue	ALL	Mita Wu
01	January 7, 2021	See the following Note Rev.(01)	ALL	Allison Chen
02	November 22, 2022	See the following Note Rev.(02)	ALL	Doris Chu

Note:

Rev.(01)

1. This test report is an addendum to the original test report T200915W04-RP2, the EUTs represent the original and this test report are assessed as identical in hardware and software, measurement results in the original report are fully leveraged in this test report without further verification test.

Rev.(02)

1. Changed antenna type to chip antenna (molex / 2119640001), and only re-test radiation. Other Test data is referenced from cross authorization(s) Measurement results in the original test report (T201215W01-RP2) under issue date (January 7, 2021) are fully leveraged in this test report.
2. Other information, please refer to the T201215W01 and this test report.

Table of contents

1.	GENERAL INFORMATION	4
1.1	EUT INFORMATION	4
1.2	EUT CHANNEL INFORMATION	5
1.3	ANTENNA INFORMATION	5
1.4	MEASUREMENT UNCERTAINTY.....	6
1.5	FACILITIES AND TEST LOCATION	7
1.6	INSTRUMENT CALIBRATION	7
1.7	SUPPORT AND EUT ACCESSORIES EQUIPMENT	8
1.8	TEST METHODOLOGY AND APPLIED STANDARDS	8
2.	TEST SUMMARY	9
3.	DESCRIPTION OF TEST MODES.....	10
3.1	THE WORST MODE OF OPERATING CONDITION	10
3.2	THE WORST MODE OF MEASUREMENT	11
4.	TEST RESULT	12
4.1	RADIATION BANDEDGE AND SPURIOUS EMISSION	12
APPENDIX 1 - PHOTOGRAPHS OF EUT		

1. GENERAL INFORMATION

1.1 EUT INFORMATION

Applicant	Murata Manufacturing Co., Ltd. 1-10-1, Higashikotari, Nagaokakyo-shi, Kyoto 617-8555 Japan
Manufacturer	Murata Manufacturing Co., Ltd. 1-10-1, Higashikotari, Nagaokakyo-shi, Kyoto 617-8555 Japan
Equipment	Communication Module
Model No.	LBEE5QD1ZM
Model Discrepancy	N/A
Trade Name	muRata
Received Date	October 19, 2022
Date of Test	October 26 ~ November 1, 2022
Power Supply	Power from power supply.
HW Version	1.0
SW Version	1.0
EUT Serial #	Radiated : 2610 #1

Remark:

1. For more details, refer to the User's manual of the EUT.
2. Disclaimer: Antenna information is provided by the applicant, test results of this report are applicable to the sample EUT received.

1.2 EUT CHANNEL INFORMATION

Frequency Range	2402MHz-2480MHz
Modulation Type	GFSK for BLE 1 Mbps & 2 Mbps
Number of channels	40 Channels

Remark:

Refer as ANSI C63.10: 2013 clause 5.6.1 Table 4 for test channels

Number of frequencies to be tested		
Frequency range in which device operates	Number of frequencies	Location in frequency range of operation
<input type="checkbox"/> 1 MHz or less	1	Middle
<input type="checkbox"/> 1 MHz to 10 MHz	2	1 near top and 1 near bottom
<input checked="" type="checkbox"/> More than 10 MHz	3	1 near top, 1 near middle, and 1 near bottom

1.3 ANTENNA INFORMATION

Antenna Specification	<input type="checkbox"/> PIFA <input checked="" type="checkbox"/> Chip <input type="checkbox"/> Dipole <input type="checkbox"/> Coils
Antenna Gain	molex / 2119640001 Gain: 2.7 dBi

Remark:

1.The antenna(s) of the EUT are permanently attached and there are no provisions for connection to an external antenna. So the EUT complies with the requirements of §15.203 and RSS-Gen 6.8.

1.4 MEASUREMENT UNCERTAINTY

PARAMETER	UNCERTAINTY
Radiated Emission_9kHz-30MHz	± 3.814
Radiated Emission_30MHz-200MHz	± 4.272
Radiated Emission_200MHz-1GHz	± 4.619
Radiated Emission_1GHz-6GHz	± 5.522
Radiated Emission_6GHz-18GHz	± 5.228
Radiated Emission_18GHz-26GHz	± 4.089
Radiated Emission_26GHz-40GHz	± 4.019

Remark:

- 1.This uncertainty represents an expanded uncertainty expressed at approximately the 95% confidence level using a coverage factor of k=2
2. ISO/IEC 17025 requires that an estimate of the measurement uncertainties associated with the emissions test results be included in the report.

1.5 FACILITIES AND TEST LOCATION

All measurement facilities used to collect the measurement data are located at

No.11, Wugong 6th Rd., Wugu Dist., New Taipei City, Taiwan.

No. 12, Ln. 116, Wugong 3rd Rd., Wugu Dist., New Taipei City, Taiwan 24803

CAB identifier: TW1309

Test site	Test Engineer	Remark
Radiation	Ray Li, Tony Chao	-

Remark:

1. The lab has been recognized as the FCC accredited lab under the KDB 974614 D01 and is listed in the FCC public Access Link (PAL) database, FCC Registration No. :444940, the FCC Designation No.:TW1309

2. The sites are constructed in conformance with the requirements of ANSI C63.7, ANSI C63.4 and CISPR Publication 22.

1.6 INSTRUMENT CALIBRATION

3M 966 Chamber Test Site					
Equipment	Manufacturer	Model	Serial Number	Cal Date	Cal Due
K-Type Cable	Huber+Suhner	SUCOFLEX 102	29406/2	2021-12-05	2022-12-04
Bi-Log Antenna	Sunol Sciences	JB3	A030105	2022-08-03	2023-08-02
Spectrum Analyzer	Agilent	E4446A	MY46180323	2021-12-06	2022-12-05
Thermo-Hygro Meter	WISEWIND	1206	D07	2021-12-28	2022-12-27
Loop Antenna	COM-POWER	AL-130	121051	2022-04-13	2023-04-12
Coaxial Cable	EMCI	EMC101G- KM-KM-500	211041	2021-12-23	2022-12-22
Coaxial Cable	EMC	EMC101G-KM-KM-9000	211042	2021-12-23	2022-12-22
Horn Antenna	ETS LINDGREN	3116	00026370	2021-11-30	2022-11-29
Cable	Woken	J-1099	201709090004	2021-12-23	2022-12-22
Preamplifier	EMEC	EM330	060609	2022-02-23	2023-02-22
Preamplifier	HP	8449B	3008A00965	2021-12-24	2022-12-23
Band Reject Filter	MICRO TRONICS	BRM 50702	112	2021-11-23	2022-11-22
Cable	Huber+Suhner	104PEA	20995+11112+182330	2022-02-23	2023-02-22
Coaxial Cable	EMCI	EMC105	190914+33953	2022-06-15	2023-06-14
Horn Antenna	ETC	MCTD 1209	DRH13M02003	2022-01-25	2023-01-24
Turn Table	CCS	CC-T-1F	N/A	N.C.R	N.C.R
Controller	CCS	CC-C-1F	N/A	N.C.R	N.C.R
Antenna Tower	CCS	CC-A-1F	N/A	N.C.R	N.C.R
Software	e3 6.11-20180419c				

Remark: Each piece of equipment is scheduled for calibration once a year.

1.7 SUPPORT AND EUT ACCESSORIES EQUIPMENT

EUT Accessories Equipment					
No.	Equipment	Brand	Model	Series No.	FCC ID
	N/A				

Support Equipment					
No.	Equipment	Brand	Model	Series No.	FCC ID
1	NB(G)	Lenovo	IBM 1951	N/A	N/A

1.8 TEST METHODOLOGY AND APPLIED STANDARDS

The test methodology, setups and results comply with all requirements in accordance with ANSI C63.10:2013, FCC Part 2, FCC Part 15.247, RSS-247 Issue 2 and RSS-GEN Issue 5

2. TEST SUMMARY

FCC Standard Section	IC Standard Section	Report Section	Test Item	Result
15.203	-	1.3	Antenna Requirement	Pass
15.247(d)	RSS-GEN 8.9, 8.10	4.1	Radiation Band Edge	Pass
15.247(d)	RSS-GEN 8.9, 8.10	4.1	Radiation Spurious Emission	Pass

3. DESCRIPTION OF TEST MODES

3.1 THE WORST MODE OF OPERATING CONDITION

Operation mode	BLE Mode (1Mbps) BLE Mode (2Mbps)
Test Channel Frequencies	1.Lowest Channel : 2402MHz 2.Middle Channel : 2440MHz 3.Highest Channel : 2480MHz

Remark:

1. EUT pre-scanned data rate of output power for each mode, the worst data rate were recorded in this report.

3.2 THE WORST MODE OF MEASUREMENT

Radiated Emission Measurement Above 1G	
Test Condition	Radiated Emission Above 1G
Power supply Mode	Mode 1: EUT power by Power supply
Worst Mode	<input checked="" type="checkbox"/> Mode 1 <input type="checkbox"/> Mode 2 <input type="checkbox"/> Mode 3 <input type="checkbox"/> Mode 4
Worst Position	<input type="checkbox"/> Placed in fixed position. <input checked="" type="checkbox"/> Placed in fixed position at X-Plane (E2-Plane) <input type="checkbox"/> Placed in fixed position at Y-Plane (E1-Plane) <input type="checkbox"/> Placed in fixed position at Z-Plane (H-Plane)

Radiated Emission Measurement Below 1G	
Test Condition	Radiated Emission Below 1G
Power supply Mode	Mode 1: EUT power by Power supply
Worst Mode	<input checked="" type="checkbox"/> Mode 1 <input type="checkbox"/> Mode 2 <input type="checkbox"/> Mode 3 <input type="checkbox"/> Mode 4

Remark:

- 1. The worst mode was record in this test report.*
- 2. EUT pre-scanned in three axis ,X,Y, Z and two polarity, for radiated measurement. The worst case(X-Plane) were recorded in this report*

4. TEST RESULT

4.1 RADIATION BANDEDGE AND SPURIOUS EMISSION

4.1.1 Test Limit

FCC according to §15.247(d), §15.209 and §15.205,

IC according to RSS-247 section 5.5, RSS-Gen, Section 8.9 and 8.10

In any 100 kHz bandwidth outside the authorized frequency band, all harmonic and spurious must be least 20 dB below the highest emission level with the authorized frequency band. Radiation emission which fall in the restricted bands must also follow the FCC section 15.209 as below limit in table.

Below 30 MHz

Frequency	Field Strength (microvolts/m)	Magnetic H-Field (microamperes/m)	Measurement Distance (metres)
9-490 kHz	2,400/F (F in kHz)	2,400/F (F in kHz)	300
490-1,705 kHz	24,000/F (F in kHz)	24,000/F (F in kHz)	30
1.705-30 MHz	30	N/A	30

Above 30 MHz

Frequency (MHz)	Field Strength microvolts/m at 3 metres (watts, e.i.r.p.)	
	Transmitters	Receivers
30-88	100 (3 nW)	100 (3 nW)
88-216	150 (6.8 nW)	150 (6.8 nW)
216-960	200 (12 nW)	200 (12 nW)
Above 960	500 (75 nW)	500 (75 nW)

Remark:

Although these tests were performed other than open area test site, adequate comparison measurements were confirmed against 30 m open are test site. Therefore sufficient tests were made to demonstrate that the alternative site produces results that correlate with the ones of tests made in an open field based on KDB 414788.

IC according to RSS-247 section 5.5, RSS-Gen, Section 8.9 and 8.10

RSS-Gen Table 3 and Table 5 – General Field Strength Limits for Transmitters and Receivers at Frequencies Above 30 MHz (Note)

Frequency (MHz)	Field Strength microvolts/m at 3 metres (watts, e.i.r.p.)	
	Transmitters	Receivers
30-88	100 (3 nW)	100 (3 nW)
88-216	150 (6.8 nW)	150 (6.8 nW)
216-960	200 (12 nW)	200 (12 nW)
Above 960	500 (75 nW)	500 (75 nW)

Note: Measurements for compliance with the limits in table 3 may be performed at distances other than 3 metres, in accordance with Section 6.6.

RSS-Gen Table 6: General Field Strength Limits for Transmitters at Frequencies Below 30 MHz (Transmit)

Frequency	Magnetic field strength (H-Field) (µA/m)	Measurement Distance (m)
9-490 kHz ^{Note}	6.37/F (F in kHz)	300
490-1,705 kHz	63.7/F (F in kHz)	30
1.705-30 MHz	0.08	30

Note: The emission limits for the ranges 9-90 kHz and 110-490 kHz are based on measurements employing a linear average detector.

4.1.2 Test Procedure

Test method Refer as ANSI C63.10:2013.

1. The EUT is placed on a turntable, Above 1 GHz is 1.5m and below 1 GHz is 0.8m above ground plane. The EUT Configured un accordance with ANSI C63.10: 2013, and the EUT set in a continuous mode.
2. The turntable shall be rotated for 360 degrees to determine the position of maximum emission level. And EUT is set 3m away from the receiving antenna, which is scanned from 1m to 4m above the ground plane to find out the highest emissions. Measurement are made polarized in both the vertical and the horizontal positions with antenna.
3. Span shall wide enough to full capture the emission measured. The SA from 9KHz to 26.5GHz set to the low, Mid and High channels with the EUT transmit.

Remark:

1. Although these tests were performed other than open area test site, adequate comparison measurements were confirmed against 30 m open are test site. Therefore sufficient tests were made to demonstrate that the alternative site produces results that correlate with the ones of tests made in an open field based on KDB 414788.
 2. No emission found between lowest internal used/generated frequency to 30MHz (9kHz~30MHz).
4. The SA setting following :
- (1) Below 1G : RBW = 100kHz, VBW \geq 3 RBW, Sweep = Auto, Detector = Peak, Trace = Max hold.
 - (2) Above 1G :
 - (2.1) For Peak measurement : RBW = 1MHz, VBW \geq 3 RBW, Sweep = Auto, Detector = Peak, Trace = Max hold.
 - (2.2) For Average measurement : RBW = 1MHz, VBW
 - If Duty Cycle \geq 98%, VBW=10Hz.
 - If Duty Cycle < 98%, VBW=1/T.

5. Data result

Actual FS=Spectrum Reading Level+Factor

Margin=Actual FS- Limit

4.1.3 Test Setup

9kHz ~ 30MHz

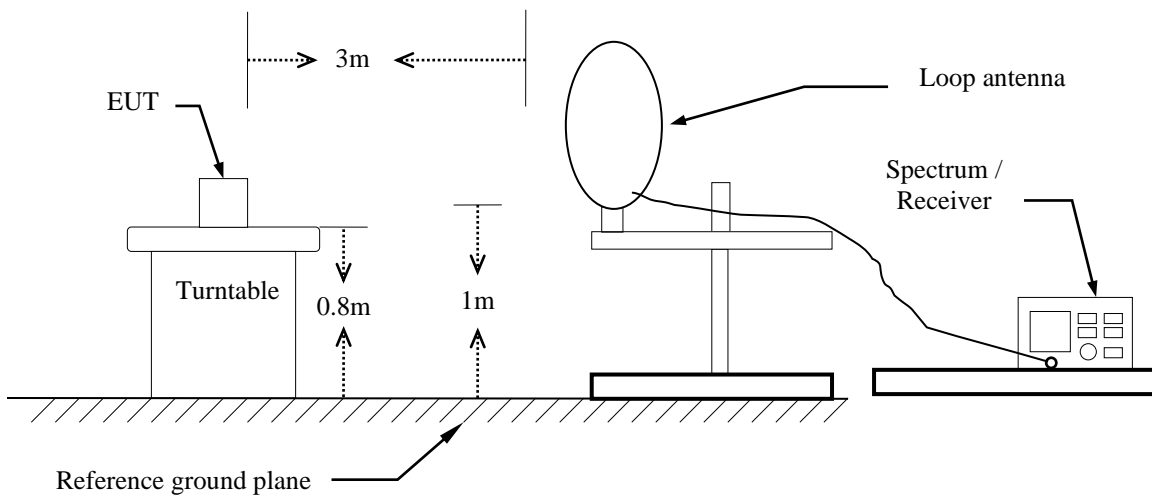

30MHz ~ 1GHz

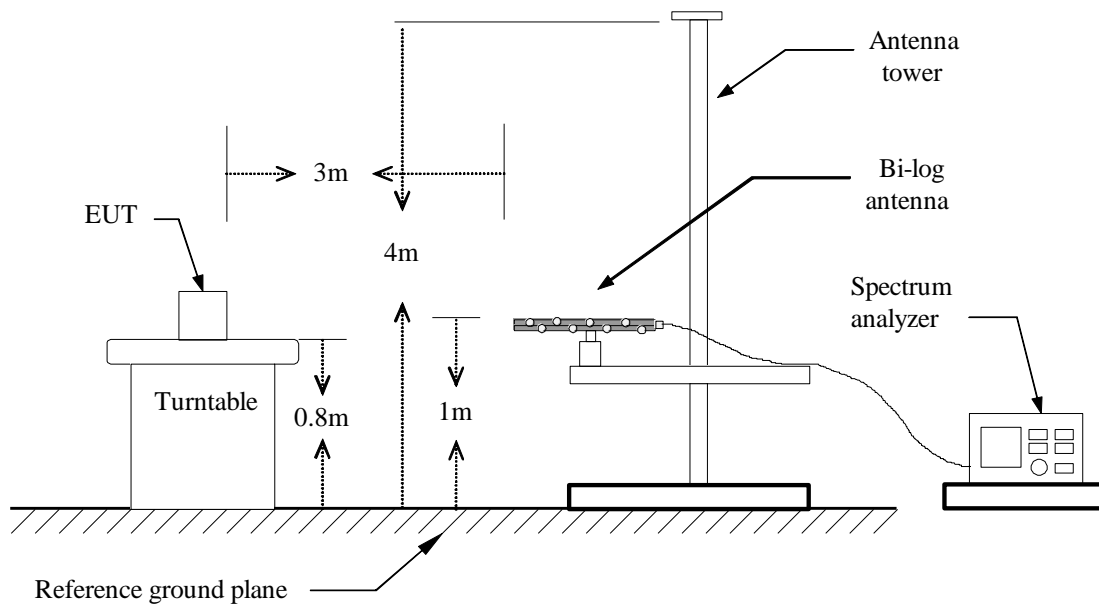

Above 1 GHz

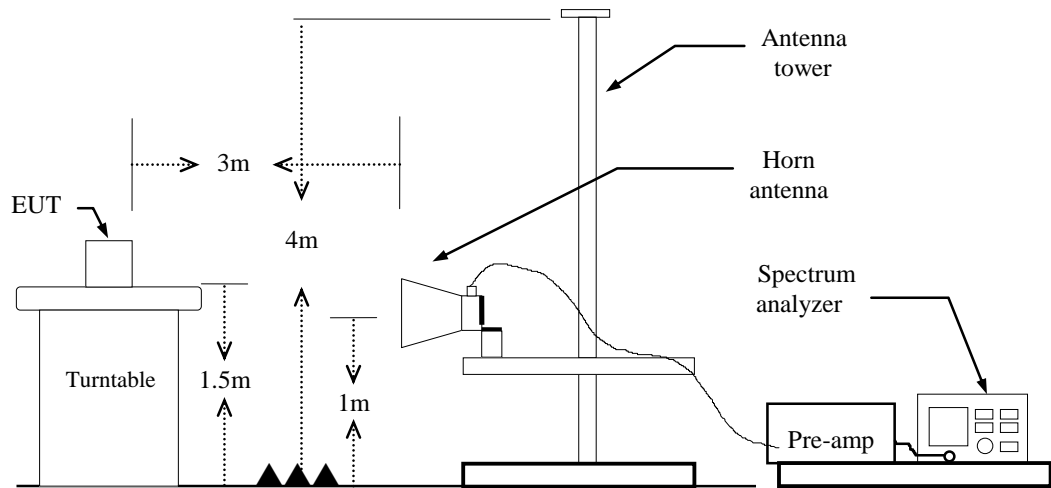

4.1.4 Test Result

Band Edge Test Data

Test Mode:	BLE-1Mbps Low CH	Temp/Hum	25.2(°C)/ 61%RH
Test Item	Band Edge	Test Date	November 1, 2022
Polarize	Vertical	Test Engineer	Ray Li
Detector	Peak / Average		

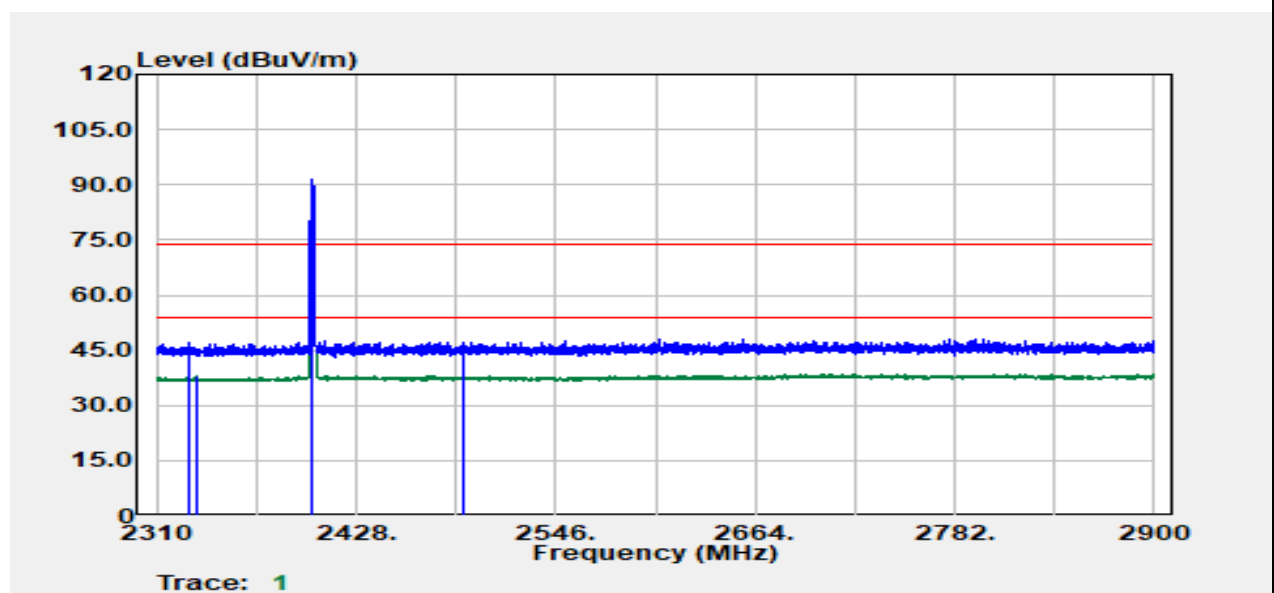

Freq. MHz	Detector Mode PK/QP/AV	Spectrum Reading Level dB μ V	Factor dB	Actual FS dB μ V/m	Limit @3m dB μ V/m	Margin dB
2329.59	Peak	39.43	7.61	47.04	74.00	-26.96
2334.43	Average	30.52	7.62	38.13	54.00	-15.87
2402.00	Peak	83.77	7.79	91.56	--	--
2402.00	Average	83.28	7.79	91.07	--	--
2490.78	Peak	38.86	8.30	47.16	74.00	-26.84
2491.01	Average	29.56	8.30	37.85	54.00	-16.15

Test Mode:	BLE-1Mbps Low CH	Temp/Hum	25.2(°C)/ 61%RH
Test Item	Band Edge	Test Date	November 1, 2022
Polarize	Horizontal	Test Engineer	Ray Li
Detector	Peak / Average		

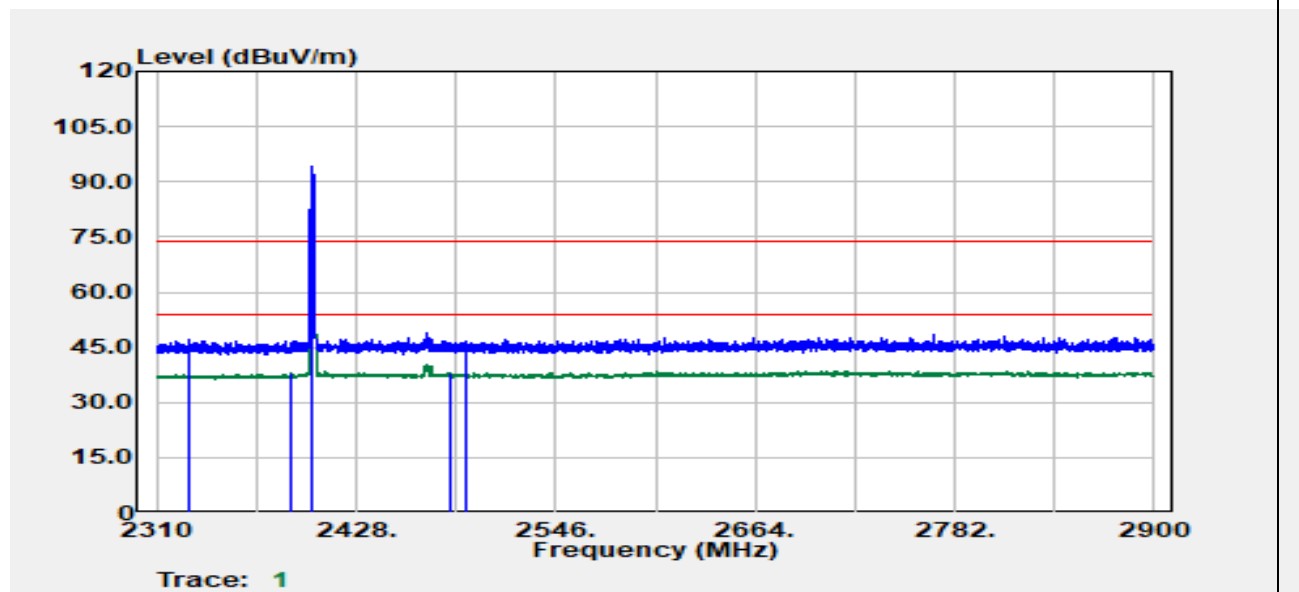

Freq. MHz	Detector Mode PK/QP/AV	Spectrum Reading Level dBμV	Factor dB	Actual FS dBμV/m	Limit @3m dBμV/m	Margin dB
2329.71	Peak	39.35	7.61	46.96	74.00	-27.04
2389.65	Average	30.07	7.75	37.82	54.00	-16.18
2402.00	Peak	86.17	7.79	93.97	--	--
2402.00	Average	85.63	7.79	93.42	--	--
2483.50	Average	29.71	8.26	37.97	54.00	-16.03
2492.19	Peak	38.16	8.30	46.46	74.00	-27.54

Test Mode:	BLE-1Mbps High CH	Temp/Hum	25.2(°C)/ 61%RH
Test Item	Band Edge	Test Date	November 1, 2022
Polarize	Vertical	Test Engineer	Ray Li
Detector	Peak / Average		

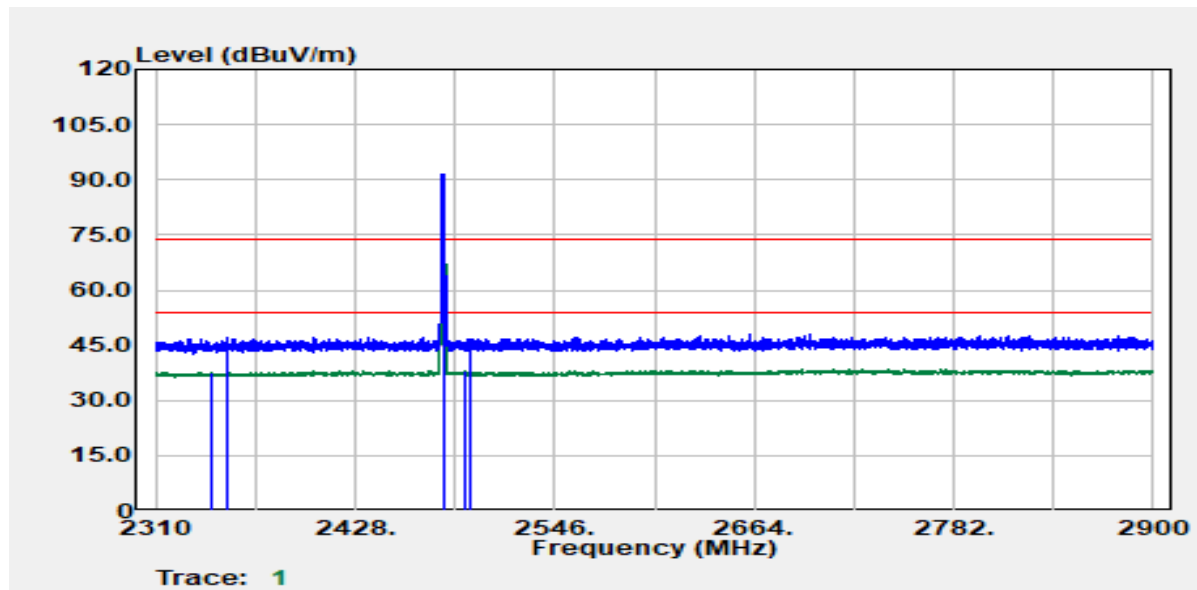

Freq. MHz	Detector Mode PK/QP/AV	Spectrum Reading Level dB μ V	Factor dB	Actual FS dB μ V/m	Limit @3m dB μ V/m	Margin dB
2343.63	Average	30.03	7.63	37.66	54.00	-16.34
2352.01	Peak	39.26	7.65	46.90	74.00	-27.10
2480.00	Peak	83.34	8.24	91.59	--	--
2480.00	Average	82.80	8.24	91.05	--	--
2493.02	Average	29.57	8.31	37.88	54.00	-16.12
2496.20	Peak	38.44	8.32	46.76	74.00	-27.24

Test Mode:	BLE-1Mbps High CH	Temp/Hum	25.2(°C)/ 61%RH
Test Item	Band Edge	Test Date	October 26, 2022
Polarize	Horizontal	Test Engineer	Tony Chao
Detector	Peak / Average		

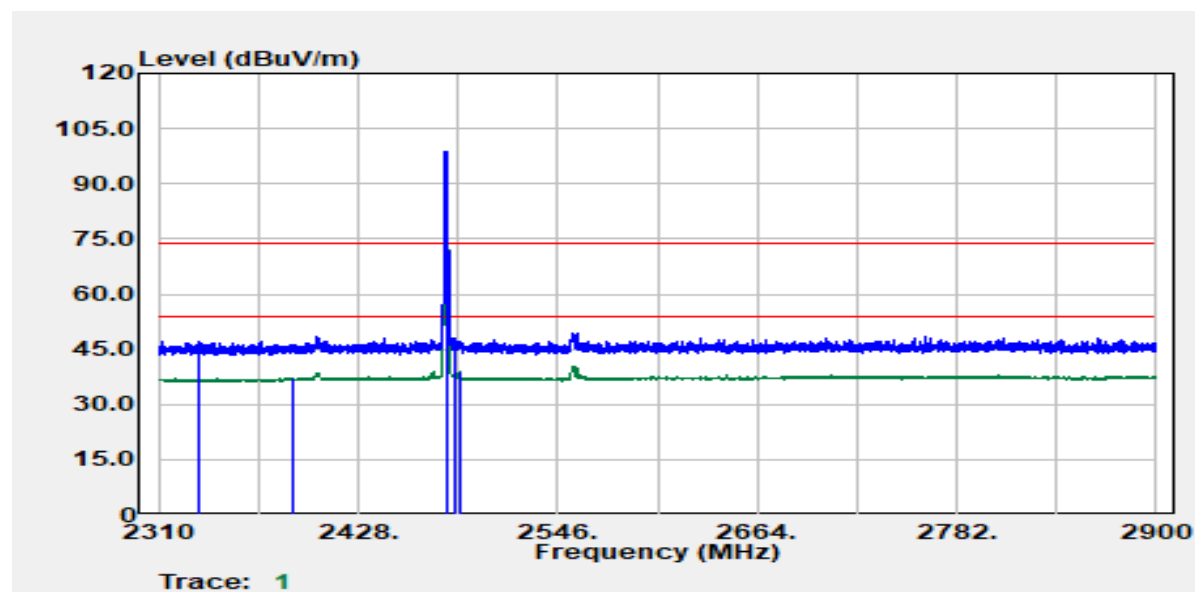

Freq. MHz	Detector Mode PK/QP/AV	Spectrum Reading Level dB μ V	Factor dB	Actual FS dB μ V/m	Limit @3m dB μ V/m	Margin dB
2333.25	Peak	39.63	7.61	47.24	74.00	-26.76
2389.41	Average	29.35	7.75	37.10	54.00	-16.90
2480.00	Peak	90.56	8.24	98.80	--	--
2480.00	Average	89.66	8.24	97.91	--	--
2484.76	Peak	39.67	8.27	47.94	74.00	-26.06
2487.83	Average	30.63	8.28	38.91	54.00	-15.09

Test Mode:	BLE-2Mbps Low CH	Temp/Hum	25.2(°C)/ 61%RH
Test Item	Band Edge	Test Date	November 1, 2022
Polarize	Vertical	Test Engineer	Ray Li
Detector	Peak / Average		

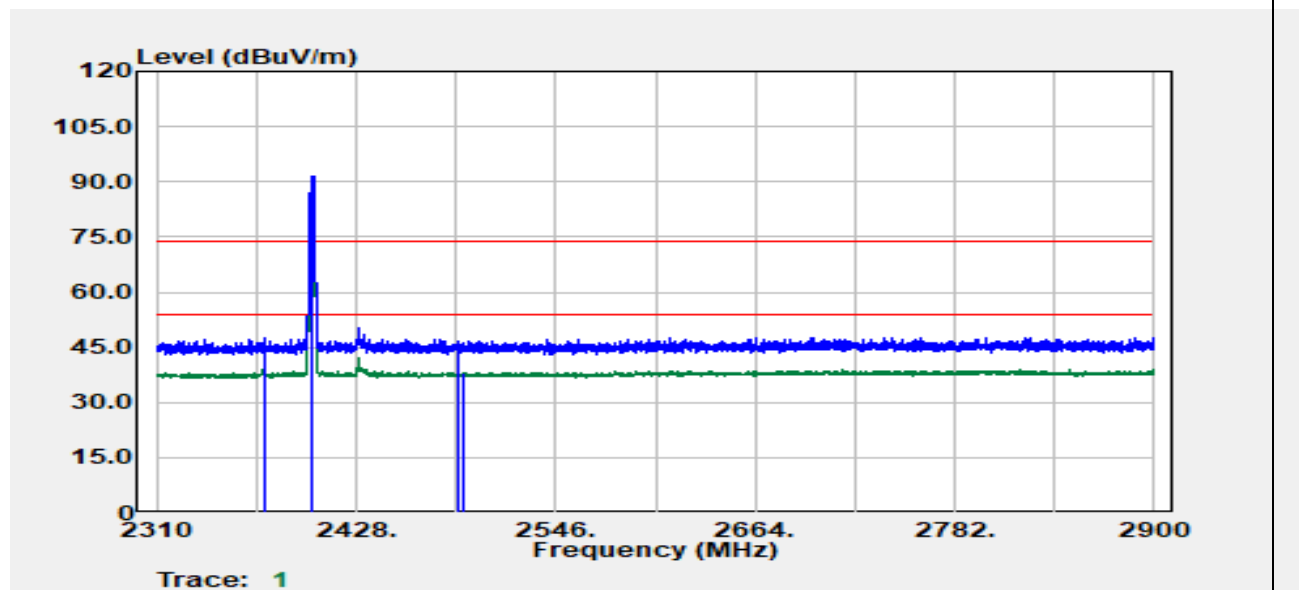

Freq. MHz	Detector Mode PK/QP/AV	Spectrum Reading Level dB μ V	Factor dB	Actual FS dB μ V/m	Limit @3m dB μ V/m	Margin dB
2373.25	Average	31.61	7.71	39.32	54.00	-14.68
2374.07	Peak	40.00	7.71	47.70	74.00	-26.30
2402.00	Peak	83.74	7.79	91.54	--	--
2402.00	Average	81.83	7.79	89.62	--	--
2487.59	Peak	38.29	8.28	46.57	74.00	-27.43
2491.13	Average	29.84	8.30	38.14	54.00	-15.86

Test Mode:	BLE-2Mbps Low CH	Temp/Hum	25.2(°C)/ 61%RH
Test Item	Band Edge	Test Date	November 1, 2022
Polarize	Horizontal	Test Engineer	Ray Li
Detector	Peak / Average		

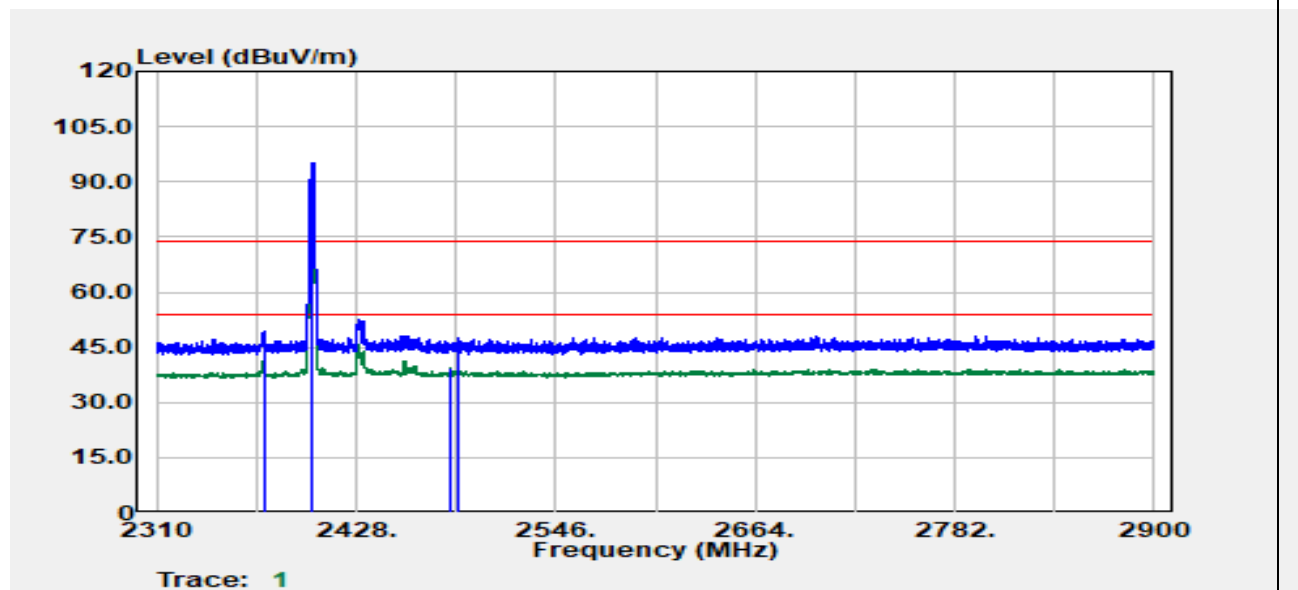

Freq. MHz	Detector Mode PK/QP/AV	Spectrum Reading Level dBμV	Factor dB	Actual FS dBμV/m	Limit @3m dBμV/m	Margin dB
2373.60	Peak	41.80	7.71	49.50	74.00	-24.50
2373.72	Average	34.41	7.71	42.11	54.00	-11.89
2402.00	Peak	87.32	7.79	95.11	--	--
2402.00	Average	85.41	7.79	93.21	--	--
2484.40	Average	31.03	8.27	39.29	54.00	-14.71
2487.83	Peak	39.09	8.28	47.37	74.00	-26.63

Test Mode:	BLE-2Mbps High CH	Temp/Hum	25.2(°C)/ 61%RH
Test Item	Band Edge	Test Date	November 1, 2022
Polarize	Vertical	Test Engineer	Ray Li
Detector	Peak / Average		

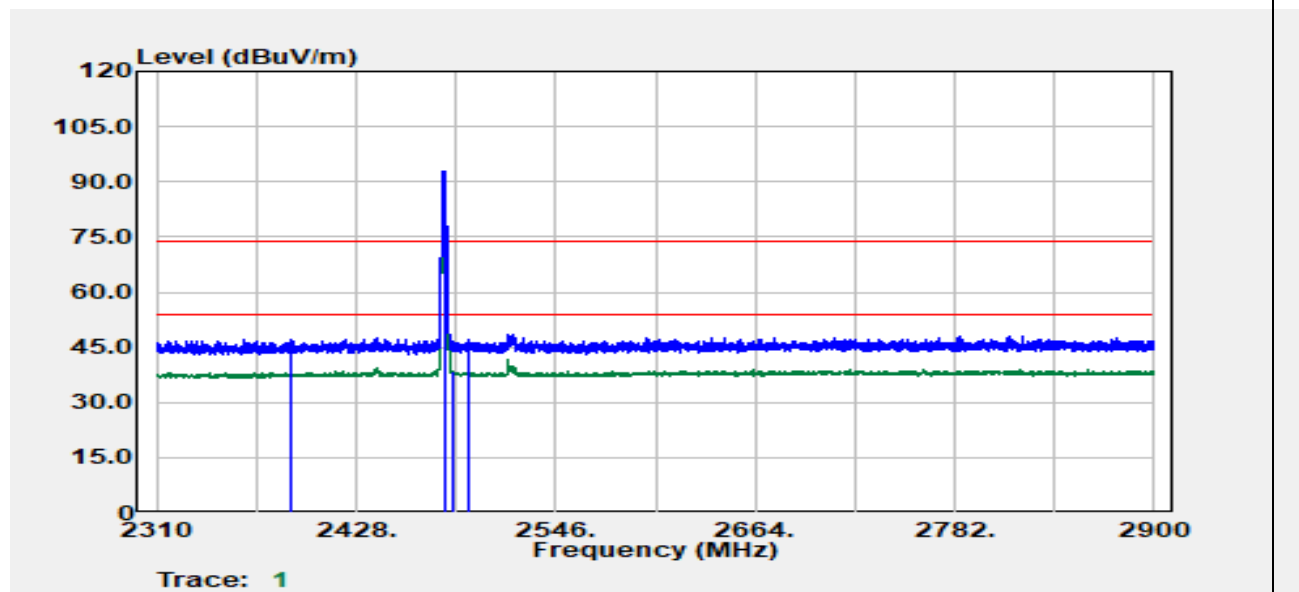

Freq. MHz	Detector Mode PK/QP/AV	Spectrum Reading Level dBμV	Factor dB	Actual FS dBμV/m	Limit @3m dBμV/m	Margin dB
2389.65	Average	30.42	7.75	38.18	54.00	-15.82
2389.77	Peak	39.51	7.75	47.26	74.00	-26.74
2480.00	Peak	84.60	8.24	92.85	--	--
2480.00	Average	82.71	8.24	90.95	--	--
2484.52	Average	30.03	8.27	38.29	54.00	-15.71
2494.20	Peak	38.75	8.31	47.06	74.00	-26.94

Test Mode:	BLE-2Mbps High CH	Temp/Hum	25.2(°C)/ 61%RH
Test Item	Band Edge	Test Date	October 26, 2022
Polarize	Horizontal	Test Engineer	Tony Chao
Detector	Peak / Average		

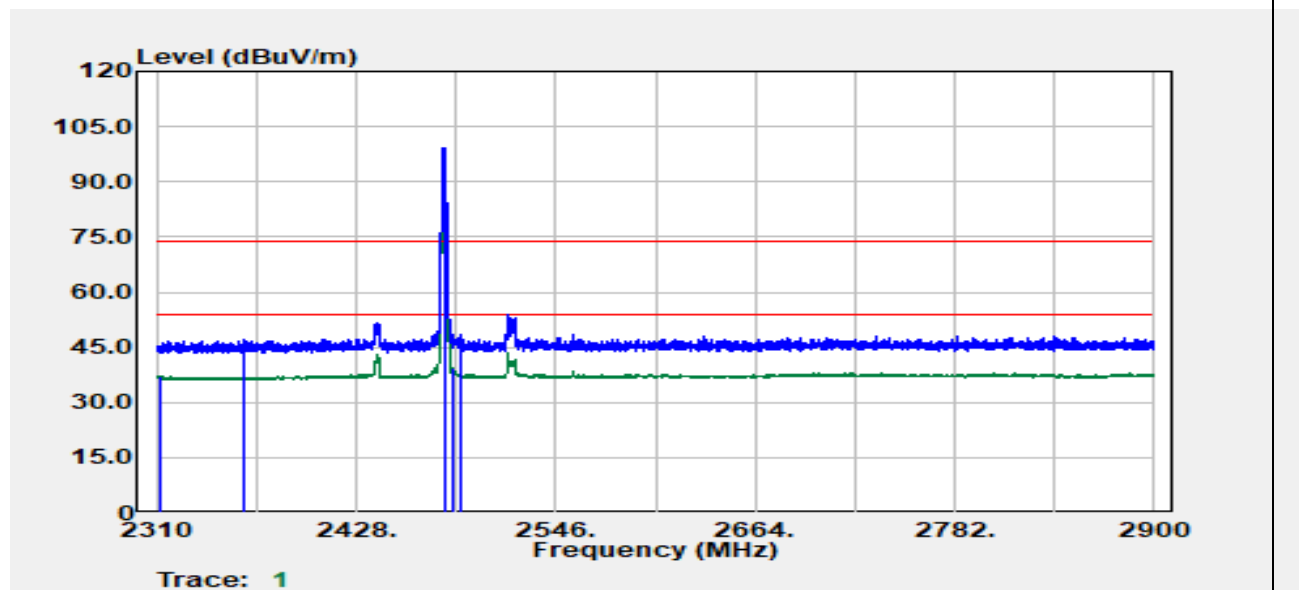

Freq. MHz	Detector Mode PK/QP/AV	Spectrum Reading Level dB μ V	Factor dB	Actual FS dB μ V/m	Limit @3m dB μ V/m	Margin dB
2311.42	Average	29.50	7.58	37.08	54.00	-16.92
2361.33	Peak	39.25	7.67	46.92	74.00	-27.08
2480.00	Peak	91.02	8.24	99.27	--	--
2480.00	Average	87.57	8.24	95.81	--	--
2485.47	Average	31.02	8.27	39.29	54.00	-14.71
2489.60	Peak	40.17	8.29	48.46	74.00	-25.54

Below 1G Test Data

Test Mode:	BLE-1Mbps Mode	Temp/Hum	24.5(°C)/ 62%RH
Test Item	30MHz-1GHz	Test Date	October 28, 2022
Polarize	Vertical	Test Engineer	Tony Chao
Detector	Peak		

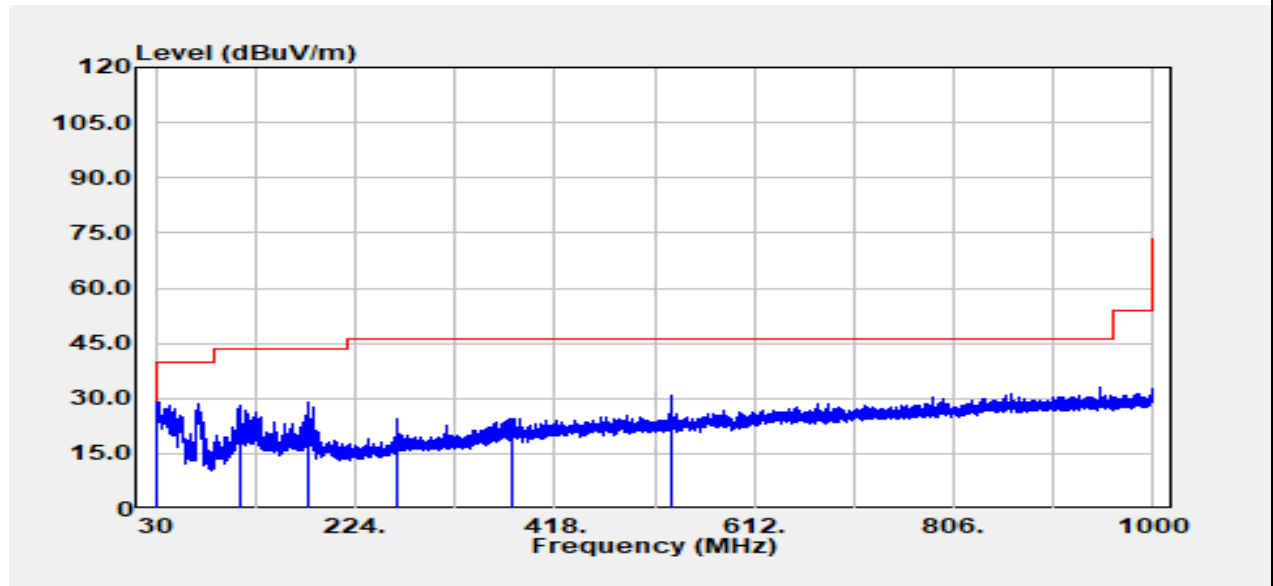

Freq. MHz	Detector Mode PK/QP/AV	Spectrum Reading Level dBμV	Factor dB	Actual FS dBμV/m	Limit @3m dBμV/m	Margin dB
32.06	Peak	32.57	-3.78	28.79	40.00	-11.21
112.69	Peak	38.06	-10.15	27.92	43.50	-15.58
178.05	Peak	40.83	-11.73	29.10	43.50	-14.40
264.01	Peak	33.99	-9.44	24.55	46.00	-21.45
375.68	Peak	31.58	-6.97	24.61	46.00	-21.39
531.73	Peak	34.13	-3.34	30.79	46.00	-15.21

Note: No emission found between lowest internal used/generated frequency to 30MHz (9kHz~30MHz).

Test Mode:	BLE-1Mbps Mode	Temp/Hum	24.5(°C)/ 62%RH
Test Item	30MHz-1GHz	Test Date	October 28, 2022
Polarize	Horizontal	Test Engineer	Tony Chao
Detector	Peak		

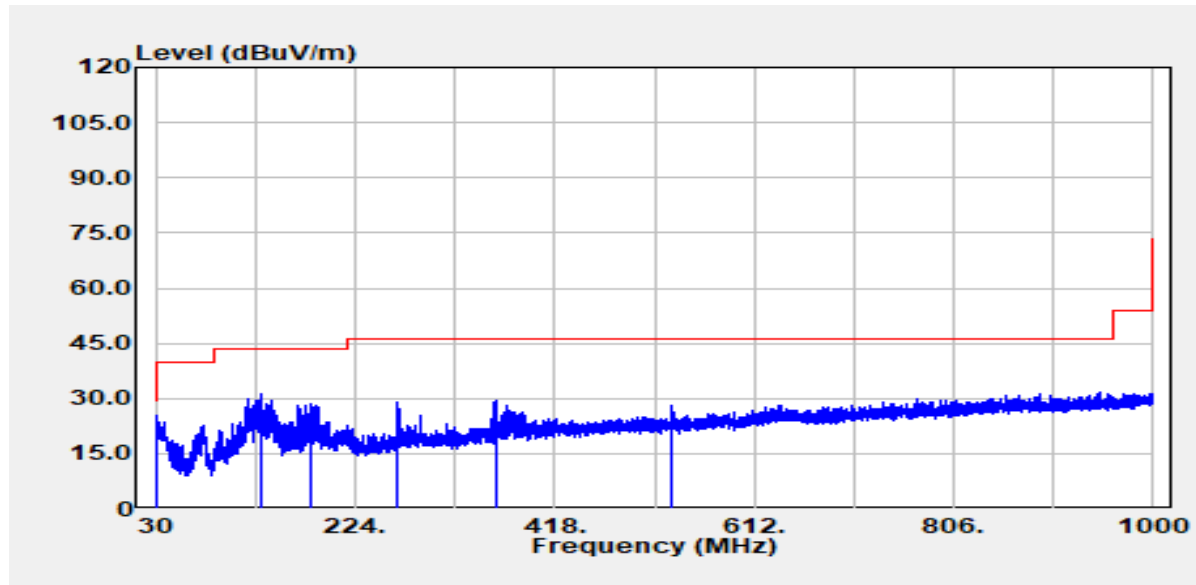

Freq. MHz	Detector Mode PK/QP/AV	Spectrum Reading Level dB μ V	Factor dB	Actual FS dB μ V/m	Limit @3m dB μ V/m	Margin dB
32.06	Peak	28.98	-3.78	25.20	40.00	-14.80
132.70	Peak	40.74	-9.67	31.07	43.50	-12.43
182.05	Peak	40.46	-11.71	28.75	43.50	-14.75
264.01	Peak	38.50	-9.44	29.06	46.00	-16.94
360.04	Peak	36.80	-7.44	29.37	46.00	-16.63
531.01	Peak	31.38	-3.34	28.03	46.00	-17.97

Note: No emission found between lowest internal used/generated frequency to 30MHz (9kHz~30MHz).

Above 1G Test Data

Test Mode:	BLE-1Mbps Low CH	Temp/Hum	25.2(°C)/ 61%RH
Test Item	Harmonic	Test Date	October 26, 2022
Polarize	Vertical	Test Engineer	Tony Chao
Detector	Peak & Average		

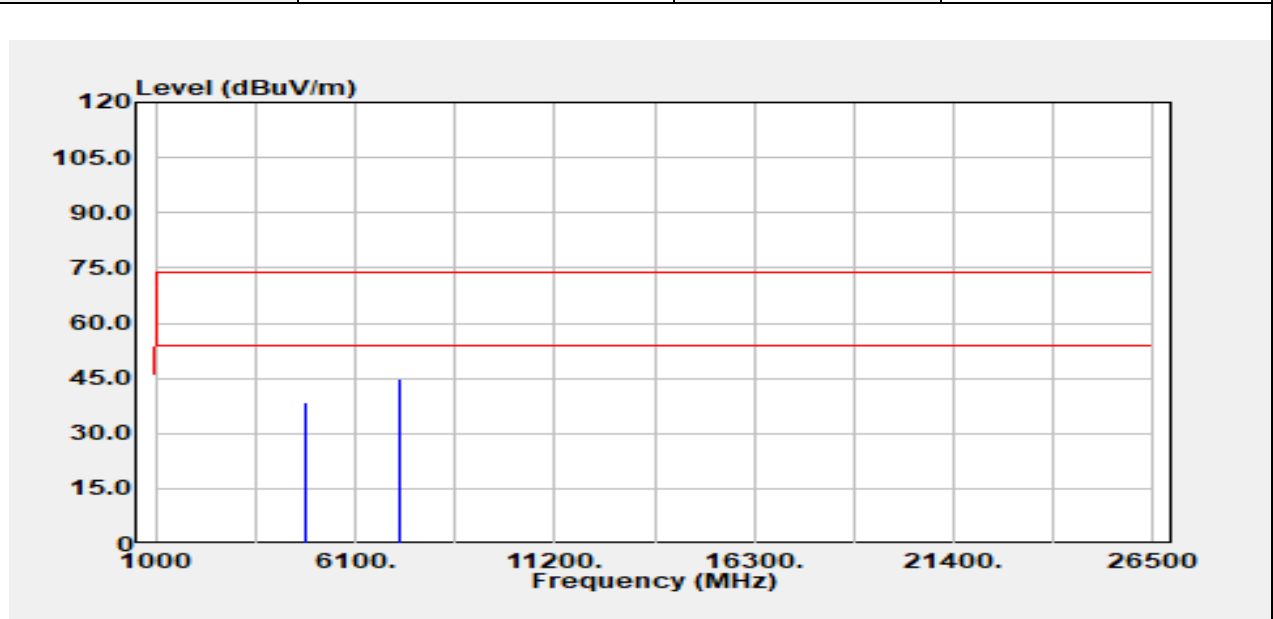

Freq. MHz	Detector Mode PK/QP/AV	Spectrum Reading Level dBμV	Factor dB	Actual FS dBμV/m	Limit @3m dBμV/m	Margin dB
4804.00	Peak	32.76	5.87	38.62	74.00	-35.38
4804.00	Average	25.64	5.87	31.51	54.00	-22.49
7206.00	Peak	31.71	13.25	44.96	74.00	-29.04
7206.00	Average	24.21	13.25	37.46	54.00	-16.54

Remark:

1. Measuring frequencies from 1 GHz to the 10th harmonic of highest fundamental frequency.

Test Mode:	BLE-1Mbps Low CH	Temp/Hum	25.2(°C)/ 61%RH
Test Item	Harmonic	Test Date	October 26, 2022
Polarize	Horizontal	Test Engineer	Tony Chao
Detector	Peak & Average		

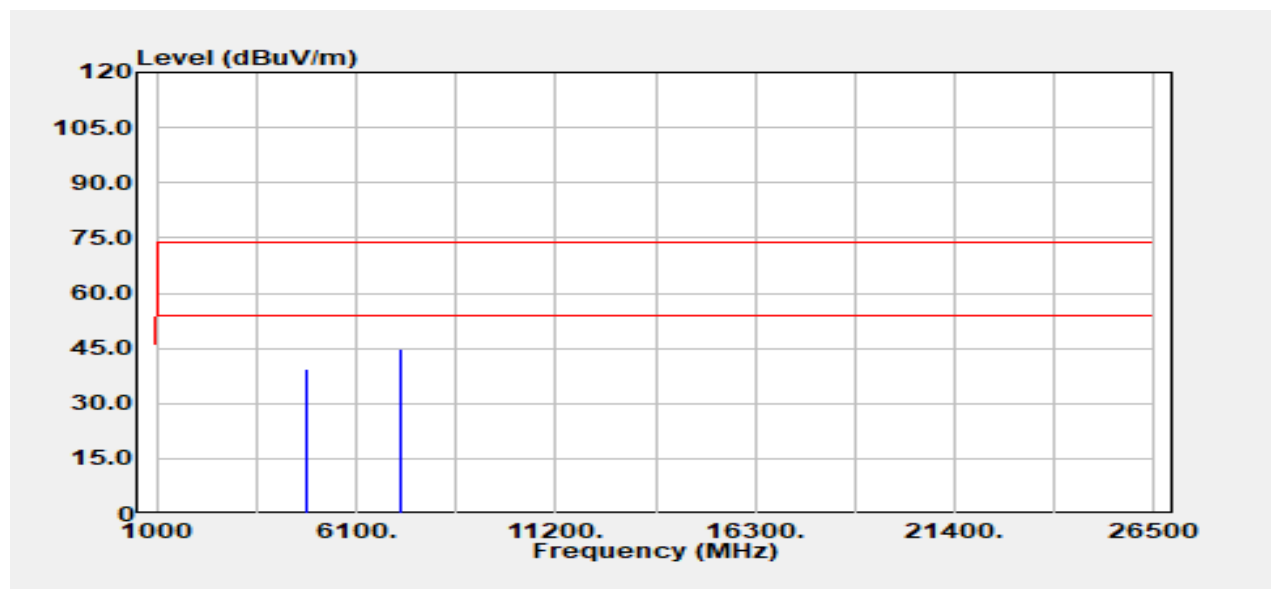

Freq. MHz	Detector Mode PK/QP/AV	Spectrum Reading Level dBμV	Factor dB	Actual FS dBμV/m	Limit @3m dBμV/m	Margin dB
4804.00	Peak	33.45	5.87	39.32	74.00	-34.68
4804.00	Average	23.93	5.87	29.80	54.00	-24.20
7206.00	Peak	31.77	13.25	45.02	74.00	-28.98
7206.00	Average	24.14	13.25	37.39	54.00	-16.61

Remark:

1. Measuring frequencies from 1 GHz to the 10th harmonic of highest fundamental frequency.

Test Mode:	BLE-1Mbps Mid CH	Temp/Hum	25.2(°C)/ 61%RH
Test Item	Harmonic	Test Date	October 26, 2022
Polarize	Vertical	Test Engineer	Tony Chao
Detector	Peak & Average		

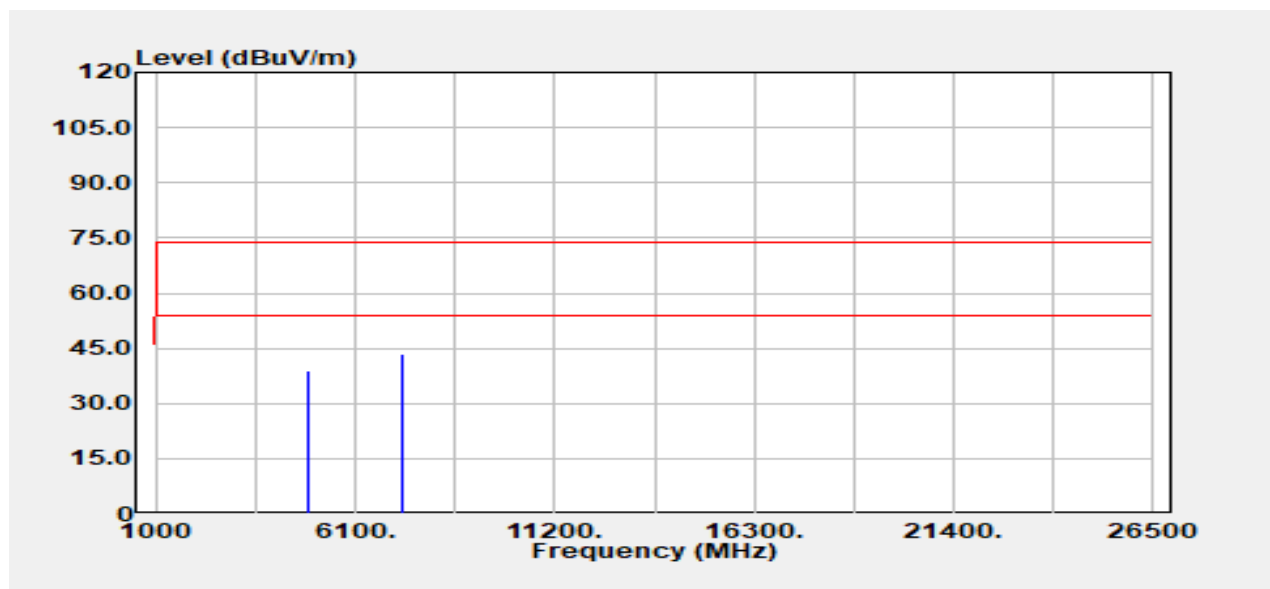

Freq. MHz	Detector Mode PK/QP/AV	Spectrum Reading Level dBUV	Factor dB	Actual FS dBUV/m	Limit @3m dBUV/m	Margin dB
4884.00	Peak	32.74	6.15	38.89	74.00	-35.11
4884.00	Average	23.50	6.15	29.65	54.00	-24.35
7326.00	Peak	30.12	13.36	43.48	74.00	-30.52
7326.00	Average	23.49	13.36	36.85	54.00	-17.15

Remark:

1. Measuring frequencies from 1 GHz to the 10th harmonic of highest fundamental frequency.

Test Mode:	BLE-1Mbps Mid CH	Temp/Hum	25.2(°C)/ 61%RH
Test Item	Harmonic	Test Date	October 26, 2022
Polarize	Horizontal	Test Engineer	Tony Chao
Detector	Peak & Average		

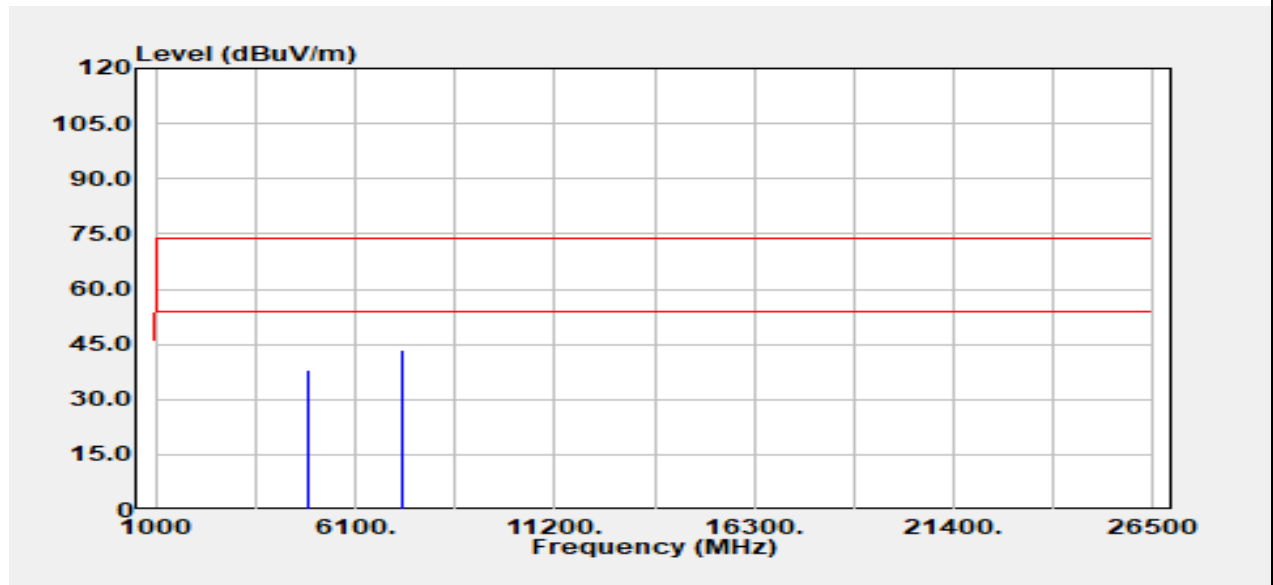

Freq. MHz	Detector Mode PK/QP/AV	Spectrum Reading Level dBμV	Factor dB	Actual FS dBμV/m	Limit @3m dBμV/m	Margin dB
4884.00	Peak	32.04	6.15	38.19	74.00	-35.81
4884.00	Average	25.07	6.15	31.22	54.00	-22.78
7326.00	Peak	30.28	13.36	43.64	74.00	-30.36
7326.00	Average	23.54	13.36	36.90	54.00	-17.10

Remark:

1. Measuring frequencies from 1 GHz to the 10th harmonic of highest fundamental frequency.

Test Mode:	BLE-1Mbps High CH	Temp/Hum	25.2(°C)/ 61%RH
Test Item	Harmonic	Test Date	October 26, 2022
Polarize	Vertical	Test Engineer	Tony Chao
Detector	Peak & Average		

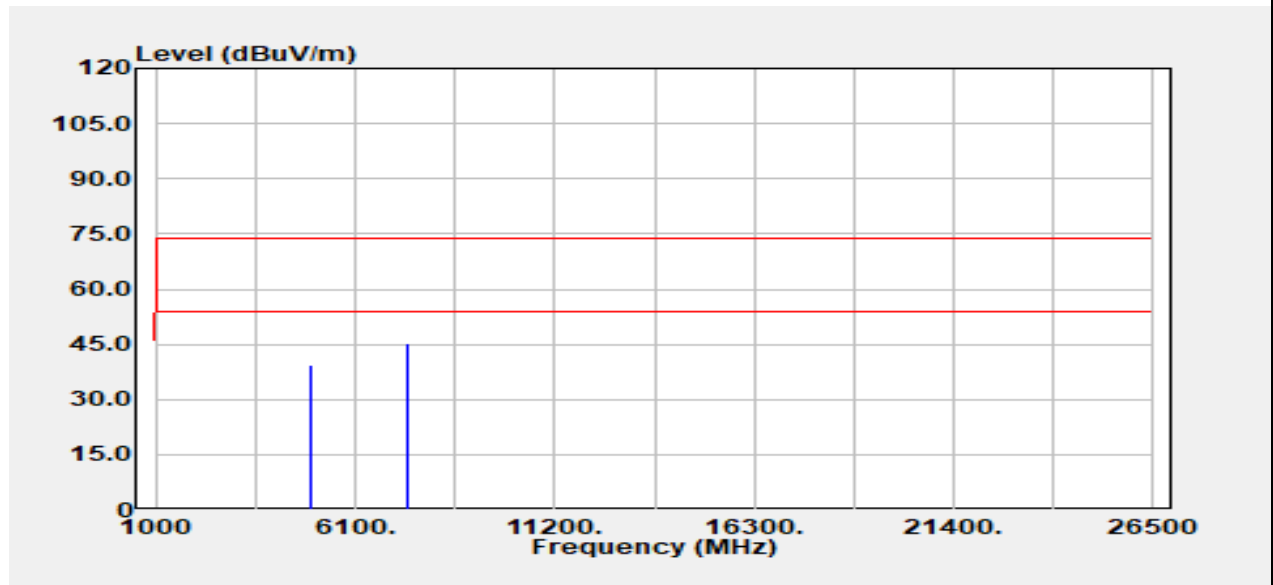

Freq. MHz	Detector Mode PK/QP/AV	Spectrum Reading Level dBμV	Factor dB	Actual FS dBμV/m	Limit @3m dBμV/m	Margin dB
4960.00	Peak	32.28	6.91	39.19	74.00	-34.81
4960.00	Average	23.45	6.91	30.36	54.00	-23.64
7440.00	Peak	32.26	13.22	45.48	74.00	-28.52
7440.00	Average	24.65	13.22	37.87	54.00	-16.13

Remark:

1. Measuring frequencies from 1 GHz to the 10th harmonic of highest fundamental frequency.

Test Mode:	BLE-1Mbps High CH	Temp/Hum	25.2(°C)/ 61%RH
Test Item	Harmonic	Test Date	October 26, 2022
Polarize	Horizontal	Test Engineer	Tony Chao
Detector	Peak & Average		

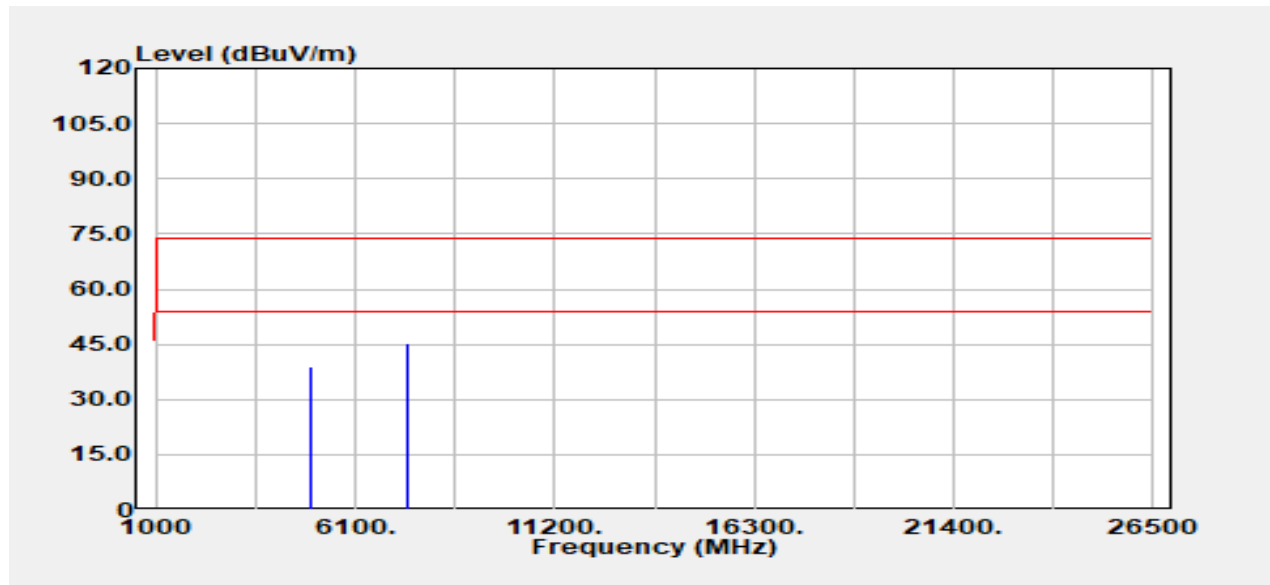

Freq. MHz	Detector Mode PK/QP/AV	Spectrum Reading Level dB μ V	Factor dB	Actual FS dB μ V/m	Limit @3m dB μ V/m	Margin dB
4960.00	Peak	31.96	6.91	38.87	74.00	-35.13
4960.00	Average	24.85	6.91	31.76	54.00	-22.24
7440.00	Peak	31.84	13.22	45.06	74.00	-28.94
7440.00	Average	24.52	13.22	37.74	54.00	-16.26

Remark:

1. Measuring frequencies from 1 GHz to the 10th harmonic of highest fundamental frequency.

Test Mode:	BLE-2Mbps Low CH	Temp/Hum	25.2(°C)/ 61%RH
Test Item	Harmonic	Test Date	October 26, 2022
Polarize	Vertical	Test Engineer	Tony Chao
Detector	Peak & Average		

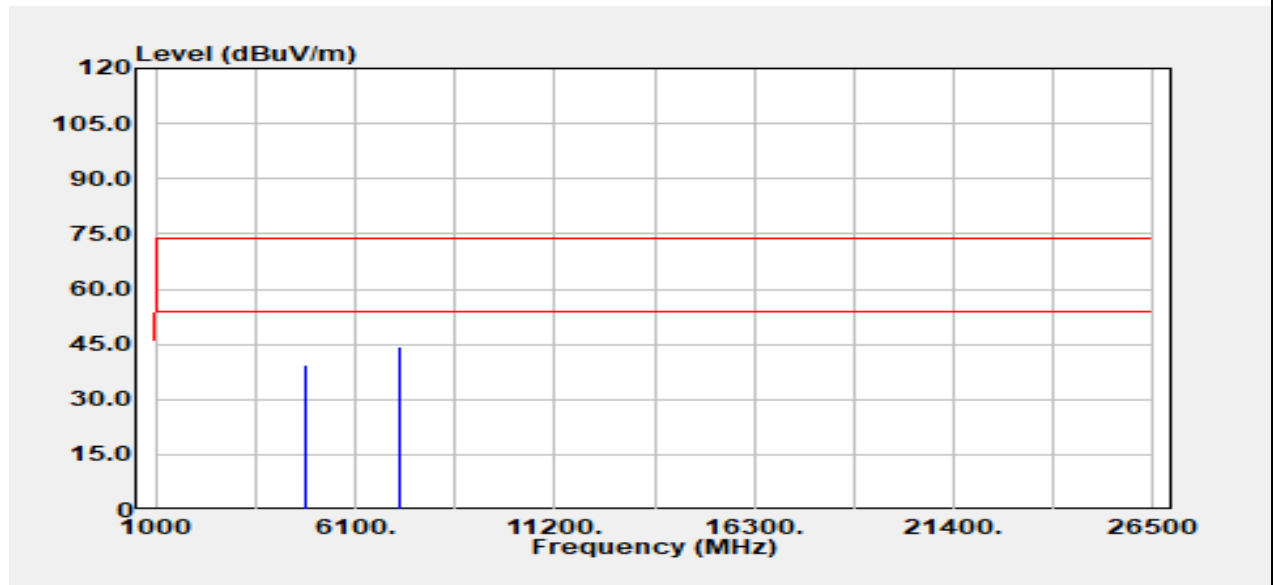

Freq. MHz	Detector Mode PK/QP/AV	Spectrum Reading Level dBUV	Factor dB	Actual FS dBUV/m	Limit @3m dBUV/m	Margin dB
4804.00	Peak	33.55	5.87	39.42	74.00	-34.58
4804.00	Average	24.16	5.87	30.03	54.00	-23.97
7206.00	Peak	30.91	13.25	44.16	74.00	-29.84
7206.00	Average	24.27	13.25	37.52	54.00	-16.48

Remark:

1. Measuring frequencies from 1 GHz to the 10th harmonic of highest fundamental frequency.

Test Mode:	BLE-2Mbps Low CH	Temp/Hum	25.2(°C)/ 61%RH
Test Item	Harmonic	Test Date	October 26, 2022
Polarize	Horizontal	Test Engineer	Tony Chao
Detector	Peak & Average		

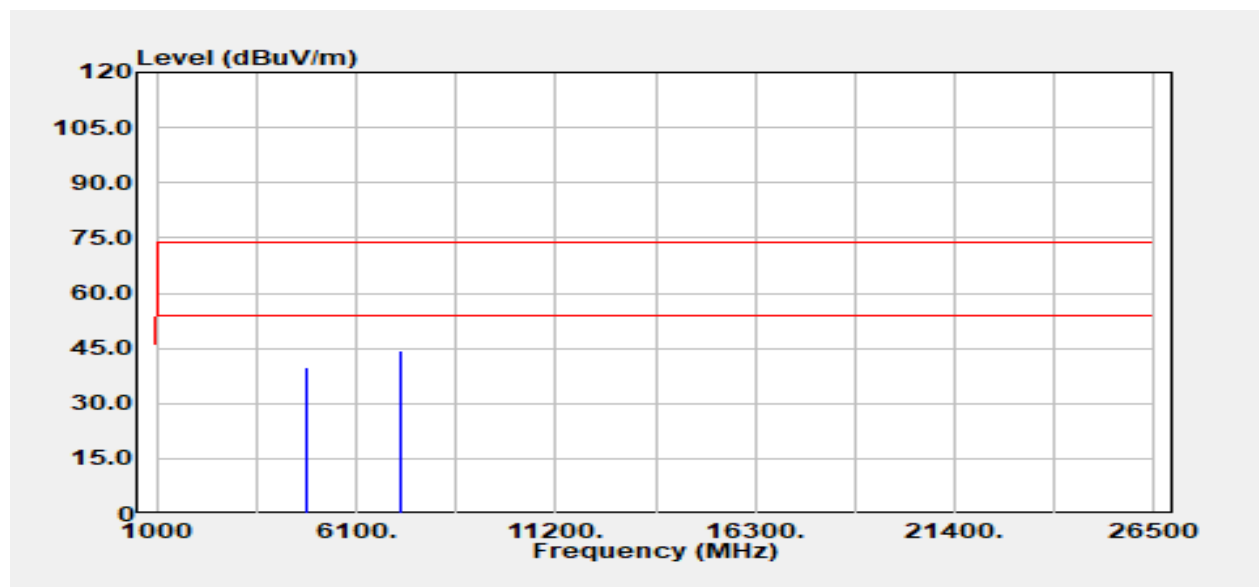

Freq. MHz	Detector Mode PK/QP/AV	Spectrum Reading Level dBμV	Factor dB	Actual FS dBμV/m	Limit @3m dBμV/m	Margin dB
4804.00	Peak	34.02	5.87	39.89	74.00	-34.11
4804.00	Average	25.46	5.87	31.33	54.00	-22.67
7206.00	Peak	31.26	13.25	44.51	74.00	-29.49
7206.00	Average	24.10	13.25	37.35	54.00	-16.65

Remark:

1. Measuring frequencies from 1 GHz to the 10th harmonic of highest fundamental frequency.

Test Mode:	BLE-2Mbps Mid CH	Temp/Hum	25.2(°C)/ 61%RH
Test Item	Harmonic	Test Date	October 26, 2022
Polarize	Vertical	Test Engineer	Ray Li
Detector	Peak & Average		

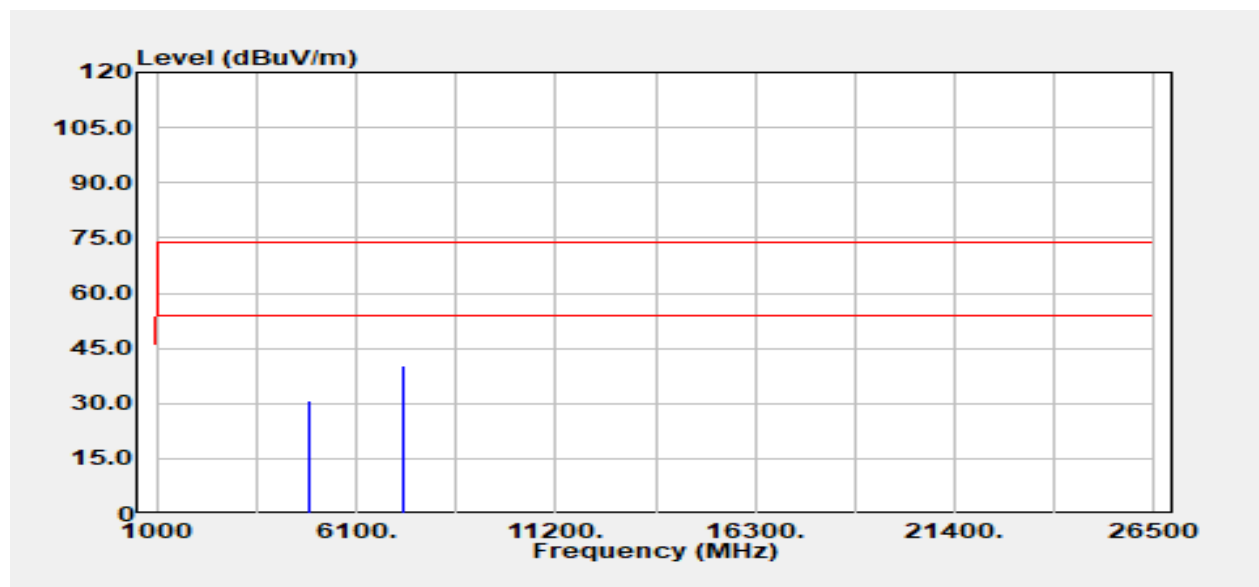

Freq. MHz	Detector Mode PK/QP/AV	Spectrum Reading Level dB μ V	Factor dB	Actual FS dB μ V/m	Limit @3m dB μ V/m	Margin dB
4884.00	Peak	24.70	6.15	30.85	74.00	-43.15
4884.00	Average	23.69	6.15	29.84	54.00	-24.16
7326.00	Peak	27.12	13.36	40.48	74.00	-33.52
7326.00	Average	22.44	13.36	35.80	54.00	-18.20

Remark:

1. Measuring frequencies from 1 GHz to the 10th harmonic of highest fundamental frequency.

Test Mode:	BLE-2Mbps Mid CH	Temp/Hum	25.2(°C)/ 61%RH
Test Item	Harmonic	Test Date	October 26, 2022
Polarize	Horizontal	Test Engineer	Ray Li
Detector	Peak & Average		

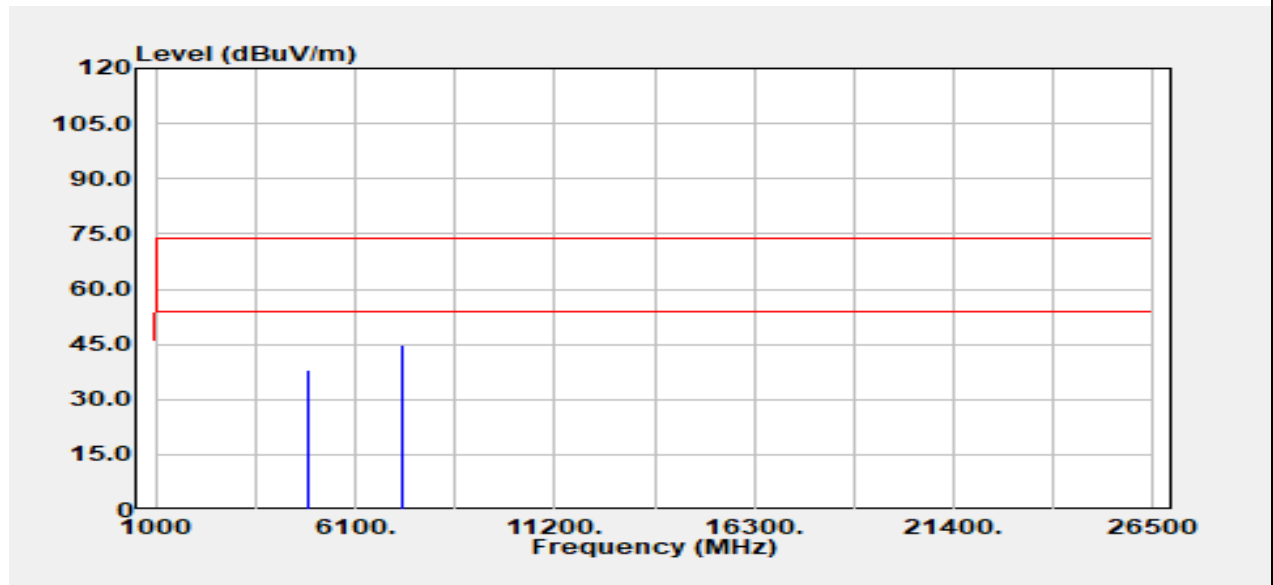

Freq. MHz	Detector Mode PK/QP/AV	Spectrum Reading Level dBμV	Factor dB	Actual FS dBμV/m	Limit @3m dBμV/m	Margin dB
4884.00	Peak	32.06	6.15	38.21	74.00	-35.79
4884.00	Average	23.54	6.15	29.69	54.00	-24.31
7326.00	Peak	31.63	13.36	44.99	74.00	-29.01
7326.00	Average	22.30	13.36	35.66	54.00	-18.34

Remark:

1. Measuring frequencies from 1 GHz to the 10th harmonic of highest fundamental frequency.

Test Mode:	BLE-2Mbps High CH	Temp/Hum	25.2(°C)/ 61%RH
Test Item	Harmonic	Test Date	October 26, 2022
Polarize	Vertical	Test Engineer	Tony Chao
Detector	Peak & Average		

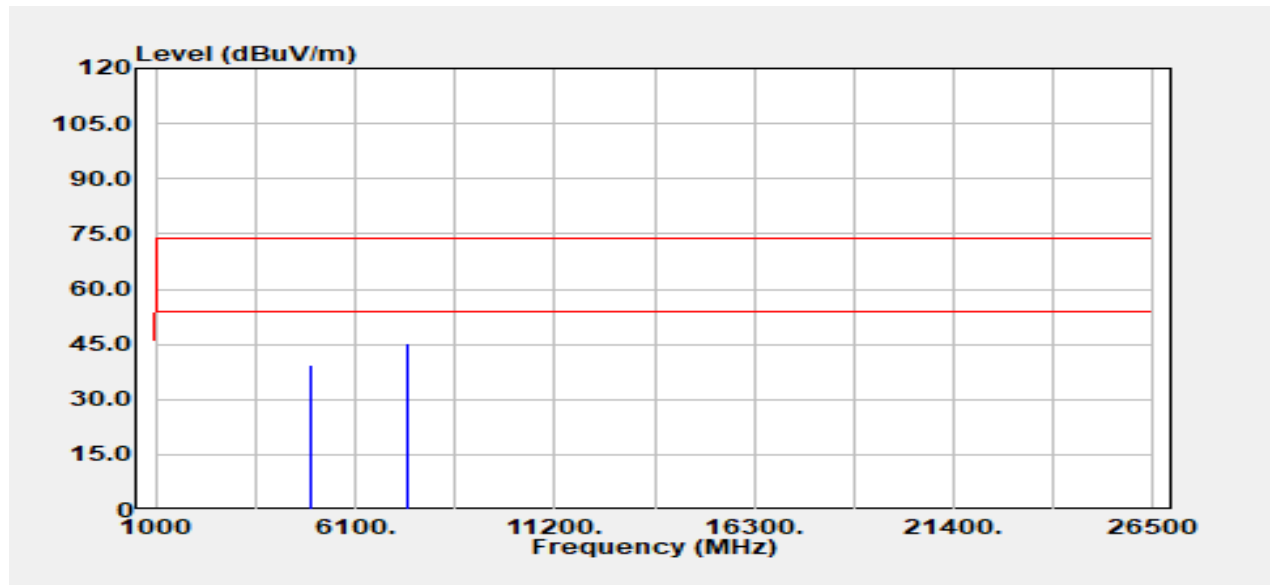

Freq. MHz	Detector Mode PK/QP/AV	Spectrum Reading Level d μ V	Factor dB	Actual FS d μ V/m	Limit @3m d μ V/m	Margin dB
4960.00	Peak	32.61	6.91	39.52	74.00	-34.48
4960.00	Average	23.35	6.91	30.26	54.00	-23.74
7440.00	Peak	32.03	13.22	45.25	74.00	-28.75
7440.00	Average	24.23	13.22	37.45	54.00	-16.55

Remark:

1. Measuring frequencies from 1 GHz to the 10th harmonic of highest fundamental frequency.

Test Mode:	BLE-2Mbps High CH	Temp/Hum	25.2(°C)/ 61%RH
Test Item	Harmonic	Test Date	October 26, 2022
Polarize	Horizontal	Test Engineer	Tony Chao
Detector	Peak & Average		

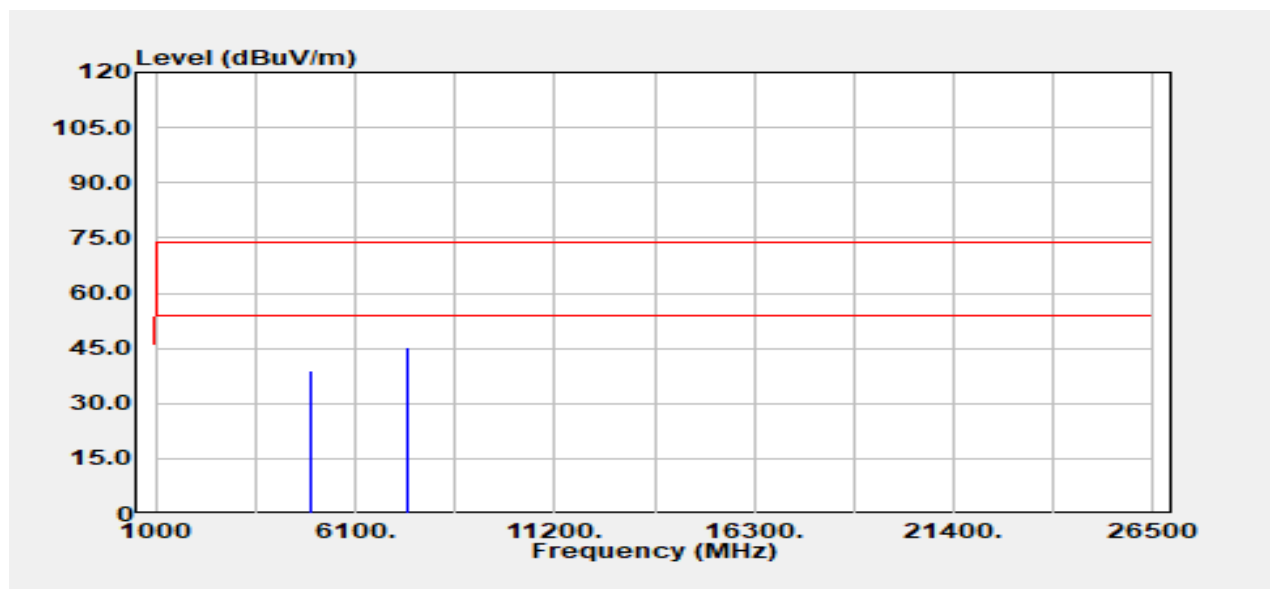

Freq. MHz	Detector Mode PK/QP/AV	Spectrum Reading Level dB μ V	Factor dB	Actual FS dB μ V/m	Limit @3m dB μ V/m	Margin dB
4960.00	Peak	32.23	6.91	39.14	74.00	-34.86
4960.00	Average	24.84	6.91	31.75	54.00	-22.25
7440.00	Peak	32.16	13.22	45.38	74.00	-28.62
7440.00	Average	24.27	13.22	37.49	54.00	-16.51

Remark:

1. Measuring frequencies from 1 GHz to the 10th harmonic of highest fundamental frequency.

--End of Test Report--