



RADIO TEST REPORT

Test Report No. : 13004393S-C-R1

Applicant : Murata Manufacturing Co., Ltd.
Type of Equipment : Communication Module
Model No. : Type1VY
FCC ID : VPYLB1VY
Test regulation : FCC Part 15 Subpart C: 2019
* Bluetooth BDR/EDR part
Test Result : Complied (Refer to SECTION 3.2)

1. This test report shall not be reproduced in full or partial, without the written approval of UL Japan, Inc.
2. The results in this report apply only to the sample tested.
3. This sample tested is in compliance with the limits of the above regulation.
4. The test results in this test report are traceable to the national or international standards.
5. This test report must not be used by the customer to claim product certification, approval, or endorsement by the A2LA accreditation body.
6. This test report covers Radio technical requirements.
It does not cover administrative issues such as Manual or non-Radio test related Requirements. (if applicable)
7. The all test items in this test report are conducted by UL Japan, Inc. Shonan EMC Lab.
8. The opinions and the interpretations to the result of the description in this report are outside scopes where UL Japan has been accredited.
9. The information provided from the customer for this report is identified in SECTION 1.
10. This report is a revised version of 13004393S-C. 13004393S-C is replaced with this report.

Date of test: September 16 to 20, 2019

Representative test engineer: K. Noda
Kazuya Noda
Engineer
Consumer Technology Division

Approved by: S. Takano
Shinichi Takano
Engineer
Consumer Technology Division



CERTIFICATE 1266.03

- The testing in which "Non-accreditation" is displayed is outside the accreditation scopes in UL Japan.
 There is no testing item of "Non-accreditation".

UL Japan, Inc.
Shonan EMC Lab.

1-22-3 Megumigaoka, Hiratsuka-shi, Kanagawa-ken, 259-1220 JAPAN
Telephone : +81 463 50 6400
Facsimile : +81 463 50 6401

REVISION HISTORY

Original Test Report No.: 13004393S-C

Revision	Test report No.	Date	Page revised	Contents
- (Original)	13004393S-C	December 2, 2019	-	-
1	13004393S-C-R1	December 23, 2019	7	Addition: "Additional information of specification: ... except the mode of Config.5."

Reference: Abbreviations (Including words undescribed in this report)

A2LA	The American Association for Laboratory Accreditation	NS	No signal detect.
AC	Alternating Current	NSA	Normalized Site Attenuation
AFH	Adaptive Frequency Hopping	NVLAP	National Voluntary Laboratory Accreditation Program
AM	Amplitude Modulation	OBW	Occupied Band Width
Amp, AMP	Amplifier	OFDM	Orthogonal Frequency Division Multiplexing
ANSI	American National Standards Institute	P/M	Power meter
Ant, ANT	Antenna	PCB	Printed Circuit Board
AP	Access Point	PER	Packet Error Rate
Atten., ATT	Attenuator	PHY	Physical Layer
AV	Average	PK	Peak
BPSK	Binary Phase-Shift Keying	PN	Pseudo random Noise
BR	Bluetooth Basic Rate	PRBS	Pseudo-Random Bit Sequence
BT	Bluetooth	PSD	Power Spectral Density
BT LE	Bluetooth Low Energy	QAM	Quadrature Amplitude Modulation
BW	BandWidth	QP	Quasi-Peak
Cal Int	Calibration Interval	QPSK	Quadri-Phase Shift Keying
CCK	Complementary Code Keying	RBW	Resolution Band Width
Ch., CH	Channel	RDS	Radio Data System
CISPR	Comite International Special des Perturbations Radioelectriques	RE	Radio Equipment
CW	Continuous Wave	RF	Radio Frequency
DBPSK	Differential BPSK	RMS	Root Mean Square
DC	Direct Current	RSS	Radio Standards Specifications
DFS	Dynamic Frequency Selection	Rx	Receiving
DQPSK	Differential QPSK	SA, S/A	Spectrum Analyzer
DSSS	Direct Sequence Spread Spectrum	SG	Signal Generator
EDR	Enhanced Data Rate	SVSWR	Site-Voltage Standing Wave Ratio
EIRP, e.i.r.p.	Equivalent Isotropically Radiated Power	TR	Test Receiver
EMC	ElectroMagnetic Compatibility	Tx	Transmitting
EMI	ElectroMagnetic Interference	VBW	Video BandWidth
EN	European Norm	Vert.	Vertical
ERP, e.r.p.	Effective Radiated Power	WLAN	Wireless LAN
EU	European Union		
EUT	Equipment Under Test		
Fac.	Factor		
FCC	Federal Communications Commission		
FHSS	Frequency Hopping Spread Spectrum		
FM	Frequency Modulation		
Freq.	Frequency		
GFSK	Gaussian Frequency-Shift Keying		
GNSS	Global Navigation Satellite System		
GPS	Global Positioning System		
Hori.	Horizontal		
ICES	Interference-Causing Equipment Standard		
IEC	International Electrotechnical Commission		
IEEE	Institute of Electrical and Electronics Engineers		
IF	Intermediate Frequency		
ILAC	International Laboratory Accreditation Conference		
ISED	Innovation, Science and Economic Development Canada		
ISO	International Organization for Standardization		
JAB	Japan Accreditation Board		
LAN	Local Area Network		
LIMS	Laboratory Information Management System		
MCS	Modulation and Coding Scheme		
MRA	Mutual Recognition Arrangement		
NIST	National Institute of Standards and Technology		

CONTENTS	PAGE
SECTION 1: Customer information.....	5
SECTION 2: Equipment under test (E.U.T.).....	5
SECTION 3: Test specification, procedures & results.....	8
SECTION 4: Operation of E.U.T. during testing.....	11
SECTION 5: Conducted Emission.....	13
SECTION 6: Radiated Spurious Emission	14
SECTION 7: Antenna Terminal Conducted Tests.....	16
APPENDIX 1: Test data	17
Conducted Emission	17
20dB Bandwidth, 99%Occupied Bandwidth and Carrier Frequency Separation.....	20
Number of Hopping Frequency	24
Dwell time.....	26
Maximum Peak Output Power.....	29
Average Output Power.....	30
Radiated Spurious Emission	32
Conducted Spurious Emission	52
Conducted Emission Band Edge compliance	58
APPENDIX 2: Test instruments	60
APPENDIX 3: Photographs of test setup	62
Conducted Emission	62
Radiated Spurious Emission	63
Pre-check of Worst Case Position.....	64

SECTION 1: Customer information

Company Name : Murata Manufacturing Co., Ltd.
Address : 1-10-1 Higashikotari, Nagaokakyo-shi, Kyoto 617-8555 Japan
Telephone Number : +81-75-955-6736
Facsimile Number : +81-75-955-6634
Contact Person : Motoo Hayashi

The information provided from the customer is as follows;

- Applicant, Type of Equipment, Model No., FCC ID on the cover and other relevant pages
- Operating/Test Mode(s) (Mode(s)) on all the relevant pages
- SECTION 1: Customer information
- SECTION 2: Equipment under test (E.U.T.)
- SECTION 4: Operation of E.U.T. during testing

* The laboratory is exempted from liability of any test results affected from the above information in SECTION 2 and 4.

SECTION 2: Equipment under test (E.U.T.)

2.1 Identification of E.U.T.

Type of Equipment : Communication Module
Model No. : Type1VY
Serial No. : Refer to SECTION 4.2
Rating : VDD_3P3, SWREG_IN, VDD_FEM:
Typ.: DC 3.3 V, Min.: DC 3.135 V, Max: DC 3.465 V
VDDIO_GPIO, VDDIO_AO:
Typ.: DC 3.3 V, Min.: DC 3.14 V, Max: DC 3.46 V
Receipt Date of Sample : September 14, 2019
(Information from test lab.)
Country of Mass-production : China, Japan
Condition of EUT : Production prototype
(Not for Sale: This sample is equivalent to mass-produced items.)
Modification of EUT : No Modification by the test lab.

2.2 Product Description

Model: Type1VY (referred to as the EUT in this report) is a Communication Module.

Clock frequency(ies) in the system : 48 MHz

Radio Specification

Equipment type	:	Transceiver
Frequency of operation	:	2.4 GHz: 2402 MHz – 2480 MHz (Bluetooth BDR/EDR/Low Energy (LE)) 2412 MHz – 2462 MHz (IEEE 802.11b, 11g, 11n-20) U-NII-1: 5180 MHz – 5240 MHz (IEEE 802.11a, 11n-20, 11ac-20) 5190 MHz – 5230 MHz (IEEE 802.11n-40, 11ac-40) 5210 MHz (IEEE 802.11ac-80) U-NII-2A: 5260 MHz – 5320 MHz (IEEE 802.11a, 11n-20, 11ac-20) 5270 MHz – 5310 MHz (IEEE 802.11n-40, 11ac-40) 5290 MHz (IEEE 802.11ac-80) U-NII-2B: 5500 MHz – 5720 MHz (IEEE 802.11a, 11n-20, 11ac-20) 5510 MHz – 5710 MHz (IEEE 802.11n-40, 11ac-40) 5530 MHz – 5690 MHz (IEEE 802.11ac-80) U-NII-3: 5745 MHz – 5825 MHz (IEEE 802.11a, 11n-20, 11ac-20) 5755 MHz – 5795 MHz (IEEE 802.11n-40, 11ac-40) 5775 MHz (IEEE 802.11ac-80)
Bandwidth	:	20 MHz (IEEE 802.11a/b/g/n/ac), 40 MHz (IEEE 802.11n/ac), 80 MHz (IEEE 802.11ac), 79 MHz (Bluetooth BDR/EDR), 1 MHz (Bluetooth LE)
Channel spacing	:	5 MHz (Wi-Fi 2.4 GHz), 20 MHz/40 MHz/80 MHz (Wi-Fi 5 GHz), 1 MHz (Bluetooth BDR/EDR), 2 MHz (Bluetooth LE)
Type of modulation	:	DSSS (IEEE 802.11b), OFDM (IEEE 802.11a/g/n/ac), FHSS (Bluetooth BDR/EDR), GFSK (Bluetooth LE)
Antenna type	:	2.4 GHz: Monopole antenna/Slot antenna/Dual monopole antenna 5 GHz: Slot antenna/ Dual monopole antenna
Antenna connector type	:	Spring
Antenna gain	:	Chain-0: [2.4 GHz] Dual Monopole antenna: +0.93 dBi [5 GHz] Dual Monopole antenna: +1.04 dBi Chain-1: [2.4 GHz] Dual Monopole antenna: +0.93 dBi [2.4 GHz] Slot antenna: +1.97 dBi [2.4 GHz] Monopole antenna: +1.98 dBi [5 GHz] Dual Monopole antenna: +1.04 dBi [5 GHz] Slot antenna: +1.98 dBi
ITU code	:	F1D, G1D (Bluetooth BDR/EDR), F1D (Bluetooth LE) D1D, G1D (IEEE802.11b/g/n/a/ac)
Operation temperature range	:	-30 deg. C to +85 deg.C

* The EUT has 2-type of jig for the measurement; PCB_A and PCB_B and the corresponding antenna is different. Refer to section 4.2 for details of the combination.

Additional information of specification:

serial no. A-**

The radio output port 0 of the radio circuit is configured with a path such as a chip resistor so that it can be connected only to the connector P2 on the jig board.

The wireless circuit port 1 of the wireless circuit is configured with a chip resistor and so on so that it can be connected only to connector P7 on the jig board.

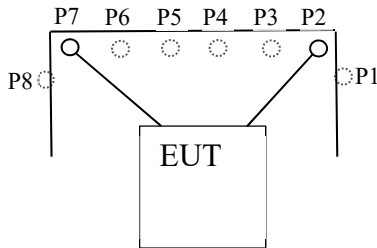

serial no. B-**

The radio output port 0 of the radio circuit is configured with a path such as a chip resistor so that it can be connected only to the connector P2 on the jig board.

The radio output port 1 of the radio circuit is configured with a path such as a chip resistor so that it can be connected to the jig board connector P5 and connector P6 via duplexer in the jig board.

(* P5 is for 2.4 GHz band signal only. P6 is for 5 GHz band signal only.)

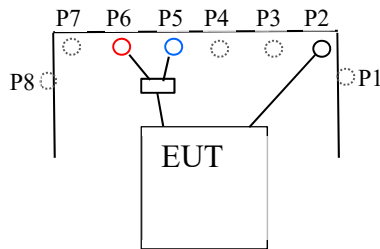

Transmission pattern

		Config. 1	Config. 2	Config. 3	Config. 4	Config. 5
chain 0	Bluetooth	-	-	transmit	transmit	transmit
	WLAN 2.4 GHz	-	transmit	-	-	-
	WLAN 5 GHz	transmit	-	-	transmit	-
chain 1	WLAN 2.4 GHz	-	transmit	-	-	transmit
	WLAN 5 GHz	transmit	-	-	transmit	-

Bluetooth mode is only chain 0 output.

WLAN all mode is simultaneous transmission at chain 0 and chain 1 output except the mode of Config.5.

SECTION 3: Test specification, procedures & results

3.1 Test Specification

Test Specification : FCC Part 15 Subpart C
FCC Part 15 final revised on July 19, 2019 and effective August 19, 2019 except 15.258

Title : FCC 47 CFR Part 15 Radio Frequency Device Subpart C Intentional Radiators
Section 15.207 Conducted limits
Section 15.247 Operation within the bands 902-928 MHz, 2400-2483.5 MHz,
and 5725-5850 MHz

3.2 Procedures and results

Item	Test Procedure	Specification	Worst Margin	Results	Remarks	
Conducted Emission	FCC: ANSI C63.10-2013 6. Standard test methods ----- ISED: RSS-Gen 8.8	FCC: Section 15.207 ----- ISED: RSS-Gen 8.8	16.5 dB, 9.35414 MHz, N, AV Mode: Tx DH5 2402 MHz	Complied a)	-	
Carrier Frequency Separation	FCC: KDB 558074 D01 15.247 Meas Guidance v05r02 ISED: -	FCC: Section15.247(a)(1) ----- ISED: RSS-247 5.1 (b)	See data.	Complied b)	Conducted	
20dB Bandwidth	FCC: KDB 558074 D01 15.247 Meas Guidance v05r02 ISED: -	FCC: Section15.247(a)(1) ----- ISED: RSS-247 5.1 (a)		Complied b)	Conducted	
Number of Hopping Frequency	FCC: KDB 558074 D01 15.247 Meas Guidance v05r02 ISED: -	FCC: Section15.247(a)(1)(iii) ----- ISED: RSS-247 5.1 (d)		Complied c)	Conducted	
Dwell time	FCC: KDB 558074 D01 15.247 Meas Guidance v05r02 ISED: -	FCC: Section15.247(a)(1)(iii) ----- ISED: RSS-247 5.1 (d)		Complied d)	Conducted	
Maximum Peak Output Power	FCC: KDB 558074 D01 15.247 Meas Guidance v05r02 ISED: RSS-Gen 6.12	FCC: Section15.247(a)(b)(1) ----- ISED: RSS-247 5.4 (b)		Complied e)	Conducted	
Spurious Emission & Band Edge Compliance	FCC: KDB 558074 D01 15.247 Meas Guidance v05r02 ISED: RSS-Gen 6.13	FCC: Section15.247(d) ----- ISED: RSS-247 5.5 RSS-Gen 8.9 RSS-Gen 8.10		8.1 dB 9608.00 MHz, AV, Horizontal Mode: Tx DH5 2402 MHz	Complied f) / g)	Conducted/ Radiated (above 30 MHz) *1)

Note: UL Japan, Inc.'s EMI Work Procedures No. 13-EM-W0420 and 13-EM-W0422.

*1) Radiated test was selected over 30 MHz based on section 15.247(d).

a) Refer to APPENDIX 1 (data of Conducted Emission)

b) Refer to APPENDIX 1 (data of 20dB Bandwidth, 99%Occupied Bandwidth and Carrier Frequency Separation)

c) Refer to APPENDIX 1 (data of Number of Hopping Frequency)

d) Refer to APPENDIX 1 (data of Dwell time)

e) Refer to APPENDIX 1 (data of Maximum Peak Output Power)

f) Refer to APPENDIX 1 (data of Conducted Spurious Emission)

g) Refer to APPENDIX 1 (data of Radiated Spurious Emission)

Symbols:

Complied The data of this test item has enough margin, more than the measurement uncertainty.

Complied# The data of this test item meets the limits unless the measurement uncertainty is taken into consideration.

* In case any questions arise about test procedure, ANSI C63.10: 2013 is also referred.

FCC Part 15.31 (e)

The EUT has the power supply regulator. However one of the input voltages to RF part doesn't go through the regulator. The stable voltage will be supplied by the end product, which will be required to have a power supply regulator. Therefore, the EUT complies with the requirement.

FCC Part 15.203/212

The EUT has a unique coupling/antenna connector (U.FL). Therefore the equipment complies with the requirement.

3.3 Addition to standard

Item	Test Procedure	Specification	Worst margin	Results	Remarks
99% Occupied Bandwidth	RSS-Gen 6.7	ISED: -	N/A	- b)	Conducted
b) Refer to APPENDIX 1 (data of 20dB Bandwidth, 99%Occupied Bandwidth and Carrier Frequency Separation)					

Other than above, no addition, exclusion nor deviation has been made from the standard.

3.4 Uncertainty

There is no applicable rule of uncertainty in this applied standard. Therefore, the results are derived depending on whether or not laboratory uncertainty is applied.

The following uncertainties have been calculated to provide a confidence level of 95 % using a coverage factor $k=2$.

Shonan EMC Lab.

Item	Frequency range	Uncertainty (+/-)			
		No. 1 SAC / SR	No. 2 SAC / SR	No. 3 SAC / SR	No. 4,5,6,8 SR
Conducted emission (AC Mains) LISN	150 kHz-30 MHz	2.6 dB	2.6 dB	2.5 dB	2.6 dB
Radiated emission (Measurement distance: 3 m)	9 kHz-30 MHz	3.0 dB	3.0 dB	3.0 dB	-
	30 MHz-200 MHz	4.6 dB	4.6 dB	4.6 dB	-
	200 MHz-1 GHz	6.0 dB	6.0 dB	6.0 dB	-
	1 GHz-6 GHz	4.9 dB	4.9 dB	4.9 dB	-
	6 GHz-18 GHz	5.5 dB	5.5 dB	5.5 dB	-
Radiated emission (Measurement distance: 1 m)	18 GHz-40 GHz	5.4 dB	5.4 dB	5.4 dB	-
	1 GHz-18 GHz	5.8 dB	5.8 dB	5.8 dB	-
	18 GHz-40 GHz	5.7 dB	5.7 dB	5.7 dB	-

SAC=Semi-Anechoic Chamber

SR= Shielded Room is applied besides radiated emission

Antenna terminal test	Uncertainty (+/-)
Power Measurement above 1 GHz (Average Detector)_SPM-06	0.98 dB
Power Measurement above 1 GHz (Peak Detector)_SPM-06	1.75 dB
Power Measurement above 1 GHz (Average Detector)_SPM-07	0.89 dB
Power Measurement above 1 GHz (Peak Detector)_SPM-07	1.12 dB
Power Measurement above 1 GHz (Average Detector)_SPM-13	1.06 dB
Power Measurement above 1 GHz (Peak Detector)_SPM-13	1.24 dB
Spurious emission (Conducted) below 1GHz	0.9 dB
Spurious emission (Conducted) 1 GHz-3 GHz	0.9 dB
Spurious emission (Conducted) 3 GHz-18 GHz	2.9 dB
Spurious emission (Conducted) 18 GHz-26.5 GHz	2.6 dB
Spurious emission (Conducted) 26.5 GHz-40 GHz	2.0 dB
Bandwidth Measurement	0.07 %
Duty cycle and Time Measurement	0.262 %
Temperature	0.95 deg.C.
Voltage	0.83 %

UL Japan, Inc.

Shonan EMC Lab.

1-22-3 Megumigaoka, Hiratsuka-shi, Kanagawa-ken, 259-1220 JAPAN

Telephone : +81 463 50 6400

Facsimile : +81 463 50 6401

3.5 Test Location

UL Japan, Inc. Shonan EMC Lab.

1-22-3, Megumigaoka, Hiratsuka-shi, Kanagawa-ken 259-1220 JAPAN

Telephone: +81 463 50 6400, Facsimile: +81 463 50 6401

A2LA Certificate Number: 1266.03 (FCC Test Firm Registration Number: 626366, ISED Lab Company Number: 2973D)

Test site	Width x Depth x Height (m)	Size of reference ground plane (m) / horizontal conducting plane	Maximum measurement distance
No.1 Semi-anechoic chamber	20.6 x 11.3 x 7.65	20.6 x 11.3	10 m
No.2 Semi-anechoic chamber	20.6 x 11.3 x 7.65	20.6 x 11.3	10 m
No.3 Semi-anechoic chamber	12.7 x 7.7 x 5.35	12.7 x 7.7	5 m
No.4 Semi-anechoic chamber	8.1 x 5.1 x 3.55	8.1 x 5.1	-
No.1 Shielded room	6.8 x 4.1 x 2.7	6.8 x 4.1	-
No.2 Shielded room	6.8 x 4.1 x 2.7	6.8 x 4.1	-
No.3 Shielded room	6.3 x 4.7 x 2.7	6.3 x 4.7	-
No.4 Shielded room	4.4 x 4.7 x 2.7	4.4 x 4.7	-
No.5 Shielded room	7.8 x 6.4 x 2.7	7.8 x 6.4	-
No.6 Shielded room	7.8 x 6.4 x 2.7	7.8 x 6.4	-
No.8 shielded room	3.45 x 5.5 x 2.4	3.45 x 5.5	-
No.1 Measurement room	2.55 x 4.1 x 2.5	-	-

3.6 Test data, Test instruments, and Test set up

Refer to APPENDIX.

SECTION 4: Operation of E.U.T. during testing

4.1 Operating Mode(s)

Bluetooth (BT): Transmitting (Tx), Payload: PRBS9

Details of Operating Mode(s)

Test Item	Mode	Tested frequency
Conducted Emission	Tx (Hopping Off) DH5, 3DH5,	2402 MHz 2441 MHz 2480 MHz
Spurious Emission (Conducted/Radiated)	Tx (Hopping Off) DH5, 3DH5, Tx (Hopping Off) DH5, 3DH5 with 11ac-40 Tx 5190 MHz	2402 MHz 2441 MHz 2480 MHz
Carrier Frequency Separation	Tx (Hopping On) DH5, 3DH5	2402 MHz 2441 MHz 2480 MHz
20dB Bandwidth	Tx (Hopping Off) DH5, 3DH5	2402 MHz 2441 MHz 2480 MHz
Number of Hopping Frequency	Tx (Hopping On) DH5, 3DH5	-
Dwell time	Tx (Hopping On), -DH1, DH3, DH5 -3DH1, 3DH3, 3DH5	-
Maximum Peak Output Power	Tx (Hopping Off) DH5, 2DH5, 3DH5	2402 MHz 2441 MHz 2480 MHz
Band Edge Compliance (Conducted)	Tx DH5, 3DH5 -Hopping On -Hopping Off	2402 MHz 2480 MHz
99% Occupied Bandwidth	Tx DH5, 3DH5 -Hopping On -Hopping Off	2402 MHz 2441 MHz 2480 MHz
<p>*As a result of preliminary test, the formal test was performed with the above modes, which had the maximum payload length (except Dwell time test) *2DH mode (2Mb/s EDR: pi/4DQPSK) was excluded for other tests than power measurement by using 3DH mode (3 Mb/s EDR: 8DPSK) as a representative. * It is considered that the non-tested packet type (e.g. inquiry) can be omitted as it is complied with above all the test items based on Bluetooth Core specification.</p> <p>*EUT has the power settings by the software as follows; Power settings: Fixed Software: Tera Term, Version 4.87 QRCT Version 3.0.276.0</p> <p>*This setting of software is the worst case. Any conditions under the normal use do not exceed the condition of setting. In addition, end users cannot change the settings of the output power of the product.</p>		

UL Japan, Inc.

Shonan EMC Lab.

1-22-3 Megumigaoka, Hiratsuka-shi, Kanagawa-ken, 259-1220 JAPAN

Telephone : +81 463 50 6400

Facsimile : +81 463 50 6401

4.2 Configuration and peripherals

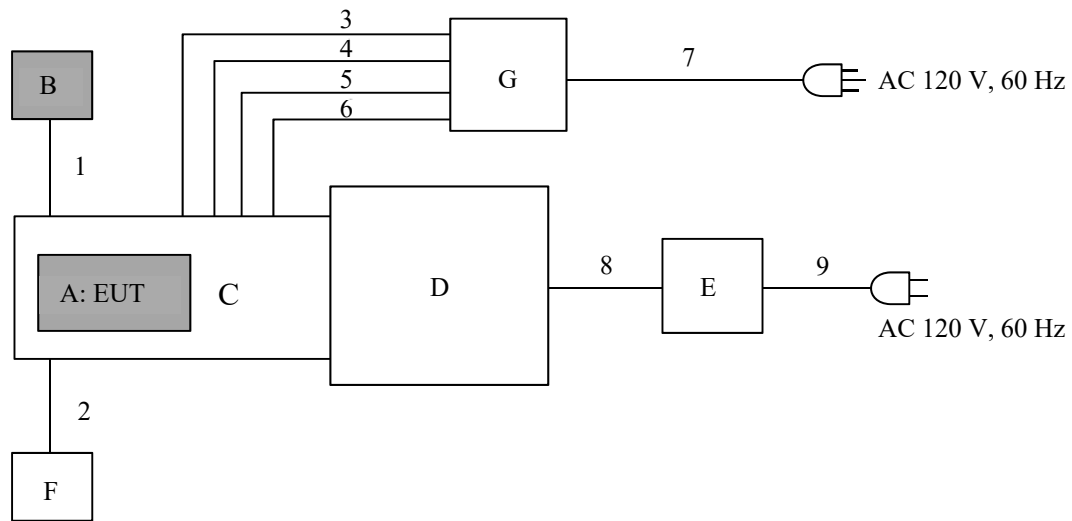

* Cabling and setup(s) were taken into consideration and test data was taken under worse case conditions.

Description of EUT and Support equipment

No.	Item	Model number	Serial number	Manufacturer	Remarks
A	Communication Module	Type1VY	A-9	Murata Manufacturing Co., Ltd.	EUT
B	Dual Monopole Antenna	M-d	No.1	SONY	EUT
C	PCBA	P2ML7925	A-9	Murata Manufacturing Co., Ltd.	-
D	Platform	iMX8	-	NXP Semiconductors	-
E	AC Adapter	EA10682N-120	-	EDACPOWER ELEC.	-
F	Terminator	M1459A	89025	Weinschel	-
G	Power Supply(DC)	PAN35-10A	DE001677	KIKUSUI	-

List of cables used

No.	Name	Length (m)	Shield		Remarks
			Cable	Connector	
1	Coaxial Cable	0.1	Shielded	Shielded	-
2	Coaxial Cable	0.1	Shielded	Shielded	-
3	DC Cable	0.7 + 2.0	Unshielded	Unshielded	-
4	DC Cable	0.7 + 2.0	Unshielded	Unshielded	-
5	DC Cable	0.7 + 2.0	Unshielded	Unshielded	-
6	DC Cable	0.7 + 2.0	Unshielded	Unshielded	-
7	AC Cable	2.4	Unshielded	Unshielded	-
8	DC Cable	1.2	Unshielded	Unshielded	-
9	AC Cable	1.5	Unshielded	Unshielded	-

UL Japan, Inc.

Shonan EMC Lab.

1-22-3 Megumigaoka, Hiratsuka-shi, Kanagawa-ken, 259-1220 JAPAN

Telephone : +81 463 50 6400

Facsimile : +81 463 50 6401

SECTION 5: Conducted Emission

Test Procedure and conditions

EUT was placed on a platform of nominal size, 1.0 m by 2.0 m, raised 0.8 m above the conducting ground plane. The table is made of Styrofoam and covered with polyvinyl chloride. That has very low permittivity. The rear of tabletop was located 40 cm to the vertical conducting plane. The rear of EUT, including peripherals aligned and flushed with rear of tabletop. All other surfaces of tabletop were at least 80 cm from any other grounded conducting surface. EUT was located 80 cm from a Line Impedance Stabilization Network (LISN) / Artificial mains Network (AMN) and excess AC cable was bundled in center.

I/O cables that were connected to the peripherals were bundled in center. They were folded back and forth forming a bundle 30 cm to 40 cm long and were hanged at a 40 cm height to the ground plane.

The AC Mains Terminal Continuous disturbance Voltage has been measured with the EUT via DC power supply in a Shielded room.

The EUT via DC power supply was connected to a LISN (AMN).

An overview sweep with peak detection has been performed.

The test results and limit are rounded off to one decimal place, so some differences might be observed.

Detector : QP and CISPR AV
Measurement range : 0.15 MHz - 30 MHz
Test data : APPENDIX
Test result : Pass

Figure 1: Test Setup

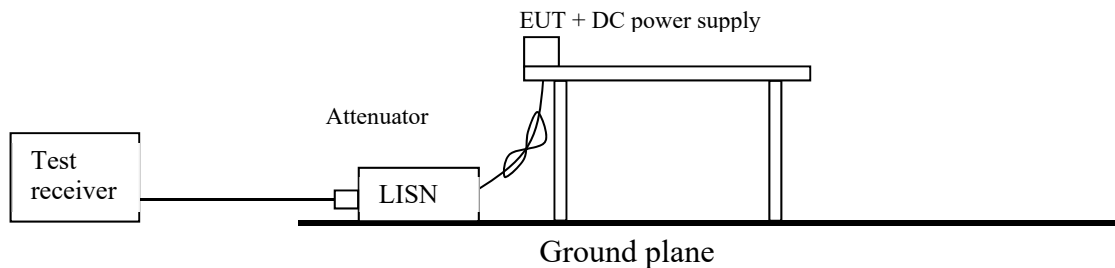

SECTION 6: Radiated Spurious Emission

Test Procedure

[For below 1 GHz]

EUT was placed on a urethane platform of nominal size, 0.5 m by 0.5 m, raised 0.8 m above the conducting ground plane. The Radiated Electric Field Strength has been measured in a Semi Anechoic Chamber with a ground plane.

[For above 1 GHz]

EUT was placed on a urethane platform of nominal size, 0.5 m by 0.5 m, raised 1.5 m above the conducting ground plane. The Radiated Electric Field Strength has been measured in a Semi Anechoic Chamber with absorbent materials lined on a ground plane.

The height of the measuring antenna varied between 1 m and 4 m and EUT was rotated a full revolution in order to obtain the maximum value of the electric field strength.

Test antenna was aimed at the EUT for receiving the maximum signal and always kept within the illumination area of the 3 dB beamwidth of the antenna.

The measurements were performed for both vertical and horizontal antenna polarization with the Test Receiver, or the Spectrum Analyzer.

The measurements were made with the following detector function of the test receiver and the Spectrum analyzer (in linear mode).

The test was made with the detector (RBW/VBW) in the following table.

When using Spectrum analyzer, the test was made with adjusting span to zero by using peak hold.

Test Antennas are used as below;

Frequency	30 MHz to 200 MHz	200 MHz to 1 GHz	Above 1 GHz
Antenna Type	Biconical	Logperiodic	Horn

In any 100 kHz bandwidth outside the restricted band in which the spread spectrum intentional radiator is operating, the radio frequency power that is produced by the intentional radiator confirmed 20 dB below that in the 100 kHz bandwidth within the band that contains the highest level of the desired power, based on a radiated measurement.

20 dBc was applied to the frequency over the limit of FCC 15.209 / Table 4 of RSS-Gen 8.9 (ISED) and outside the restricted band of FCC15.205 / Table 6 of RSS-Gen 8.10 (ISED).

Frequency	Below 1 GHz	Above 1 GHz		20 dBc
Instrument used	Test Receiver	Spectrum Analyzer		Spectrum Analyzer
Detector	QP	PK	AV *1)	PK
IF Bandwidth	BW 120 kHz	RBW: 1 MHz VBW: 3 MHz	RBW: 1 MHz VBW: 1/T (T: burst length, refer to Burst rate confirmation sheet) Detector: Peak	RBW: 100 kHz VBW: 300 kHz

*1) Average Power Measurement was performed based on KDB 558074 D01 15.247 Meas Guidance v05r02.

UL Japan, Inc.

Shonan EMC Lab.

1-22-3 Megumigaoka, Hiratsuka-shi, Kanagawa-ken, 259-1220 JAPAN

Telephone : +81 463 50 6400

Facsimile : +81 463 50 6401

Figure 2: Test Setup

Below 1 GHz

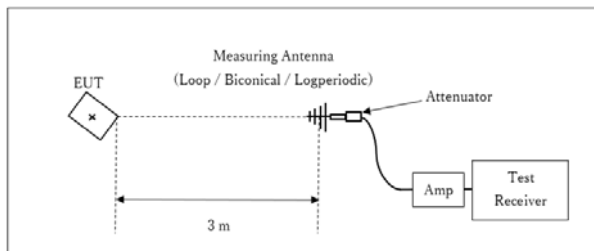

× : Center of turn table

Test Distance: 3 m

1 GHz - 13 GHz

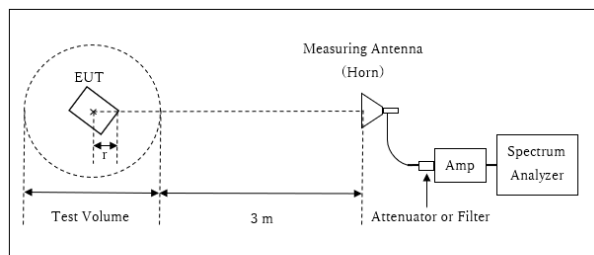

r : Radius of an outer periphery of EUT

× : Center of turn table

Distance Factor: $20 \times \log(3.84 \text{ m} / 3.0 \text{ m}) = 2.15 \text{ dB}$

* Test Distance: $(3 + \text{Test Volume} / 2) - r = 3.84 \text{ m}$

Test Volume : 2.0 m

(Test Volume has been calibrated based on CISPR 16-1-4.)

r = 0.16 m

13 GHz – 26.5 GHz

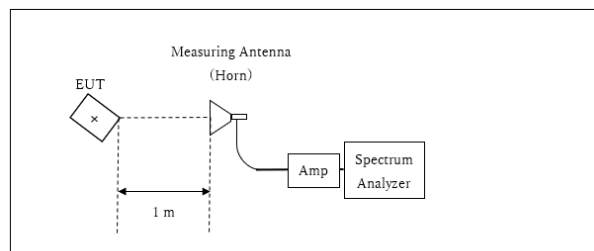

× : Center of turn table

Distance Factor: $20 \times \log(1.0 \text{ m} / 3.0 \text{ m}) = -9.54 \text{ dB}$

*Test Distance: 1 m

The carrier level and noise levels were confirmed at each position of X, Y and Z axes of EUT to see the position of maximum noise, and the test was made at the position that has the maximum noise.

Worst position:

Module

	Carrier	Spurious				
		Below 1 GHz	1 GHz - 2.8 GHz	2.8 GHz - 13 GHz	13 GHz - 18 GHz	18 GHz - 26.5 GHz
Horizontal	X	X	X	X	X	X
Vertical	X	X	X	X	X	X

Antenna

	Carrier	Spurious				
		Below 1 GHz	1 GHz - 2.8 GHz	2.8 GHz - 13 GHz	13 GHz - 18 GHz	18 GHz - 26.5 GHz
Horizontal	X	X	X	X	X	X
Vertical	Z	X	Z	Z	X	X

The test results and limit are rounded off to one decimal place, so some differences might be observed.

Measurement range : 30 MHz - 26.5 GHz
Test data : APPENDIX
Test result : Pass

UL Japan, Inc.

Shonan EMC Lab.

1-22-3 Megumigaoka, Hiratsuka-shi, Kanagawa-ken, 259-1220 JAPAN

Telephone : +81 463 50 6400

Facsimile : +81 463 50 6401

SECTION 7: Antenna Terminal Conducted Tests

Test Procedure

The tests were made with below setting connected to the antenna port.

Test	Span	RBW	VBW	Sweep time	Detector	Trace	Instrument used
20dB Bandwidth	3 MHz	30 kHz	100 kHz	Auto	Peak	Max Hold	Spectrum Analyzer
99% Occupied Bandwidth *1)	Enough width to display emission skirts	1 to 5 % of OBW	Three times of RBW	Auto	Peak	Max Hold	Spectrum Analyzer
Maximum Peak Output Power	-	-	-	Auto	Peak Average *2)	-	Power Meter (Sensor: 160MHz BW)
Carrier Frequency Separation	3 MHz	100 kHz	300 kHz	Auto	Peak	Max Hold	Spectrum Analyzer
Number of Hopping Frequency	30 MHz	300 kHz	1 MHz	Auto	Peak	Max Hold	Spectrum Analyzer
Dwell Time	Zero Span	100 kHz, 1 MHz	300 kHz, 3 MHz	As necessary capture the entire dwell time per hopping channel	Peak	Clear Write	Spectrum Analyzer
Conducted Spurious Emission *3)	9 kHz to 150 kHz	200 Hz	620 Hz	Auto	Peak	Max Hold	Spectrum Analyzer
	150 kHz to 30 MHz	10 kHz	30 kHz				
	30 MHz to 25 GHz	100 kHz	300 kHz				
Conducted Spurious Emission Band Edge compliance	10 MHz	100 kHz	300 kHz	Auto	Peak	Max Hold	Spectrum Analyzer

*1) Peak hold was applied as Worst-case measurement.

*2) Reference data

*3) In the frequency range below 30MHz, RBW was narrowed to separate the noise contents.

Then, wide-band noise near the limit was checked separately, however the noise was not detected as shown in the chart.

(9 kHz -150 kHz: RBW = 200 Hz, 150 kHz - 30 MHz: RBW = 10 kHz)

The test results and limit are rounded off to two decimals place, so some differences might be observed.
The equipment and cables were not used for factor 0 dB of the data sheets.

Test data : APPENDIX

Test result : Pass

APPENDIX 1: Test data

Conducted Emission

DATA OF CONDUCTED EMISSION TEST

UL Japan, Inc. Shonan EMC Lab. No.3 Shielded Room
Date : 2019/09/20

Mode : Tx_DH5_2402 MHz

Power : AC 120 V/60 Hz
Temp./Humi. : 24 deg.C / 58 %RH

Remarks : -

Limit : FCC_Part 15 Subpart B(15.107)_Class B

Engineer : Takahiro Suzuki

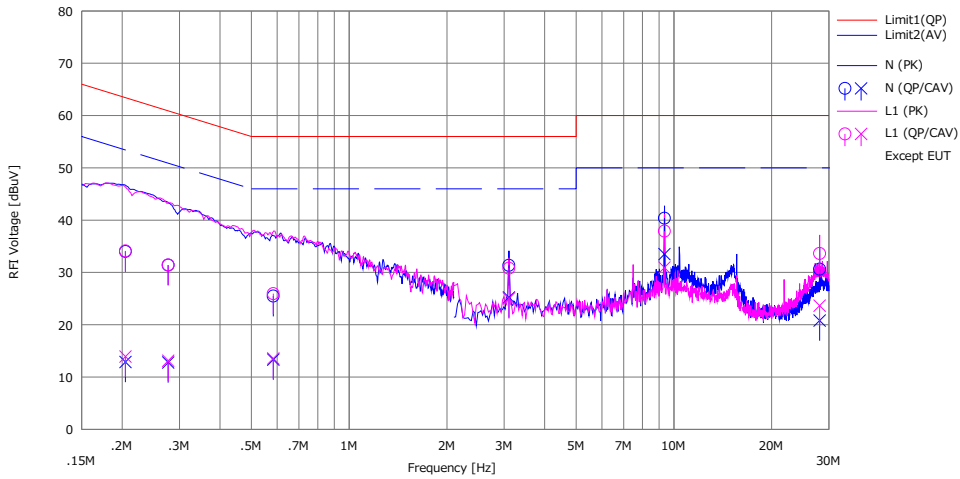

No.	Freq. [MHz]	Reading		C.Fac [dB]	Results		Limit		Margin		Phase	Comment
		<QP> [dBuV]	<CAV> [dBuV]		<QP> [dBuV]	<CAV> [dBuV]	<QP> [dBuV]	<AV> [dBuV]	<QP> [dB]	<AV> [dB]		
1	0.20461	21.56	0.43	12.44	34.00	12.87	63.42	53.42	29.4	40.5	N	
2	0.27702	18.95	0.34	12.44	31.39	12.78	60.90	50.90	29.5	38.1	N	
3	0.58380	13.00	0.87	12.47	25.47	13.34	56.00	46.00	30.5	32.6	N	
4	3.10435	18.75	12.62	12.60	31.35	25.22	56.00	46.00	24.6	20.7	N	
5	9.35414	27.47	20.61	12.89	40.36	33.50	60.00	50.00	19.6	16.5	N	
6	28.09936	17.00	7.19	13.62	30.62	20.81	60.00	50.00	29.3	29.1	N	
7	0.20461	21.65	1.46	12.44	34.09	13.90	63.42	53.42	29.3	39.5	L1	
8	0.27702	18.99	0.67	12.44	31.43	13.11	60.90	50.90	29.4	37.7	L1	
9	0.58380	13.47	1.07	12.47	25.94	13.54	56.00	46.00	30.0	32.4	L1	
10	3.10435	18.19	12.43	12.60	30.79	25.03	56.00	46.00	25.2	20.9	L1	
11	9.35414	25.00	18.03	12.89	37.89	30.92	60.00	50.00	22.1	19.0	L1	
12	28.09936	19.99	10.02	13.62	33.61	23.64	60.00	50.00	26.3	26.3	L1	

Calculation: Result[dBuV]=Reading[dBuV]+C.Fac(LISN(AMN)+Cable+ATT)[dB]
LISN(AMN): SLS-05

Conducted Emission

Report No.	13004393S-C-R1
Test place	Shonan EMC Lab. No.3 Shielded Room
Date	September 20, 2019
Temperature / Humidity	24 deg. C / 58 % RH
Engineer	Takahiro Suzuki
Mode	Tx, Hopping Off, DH5

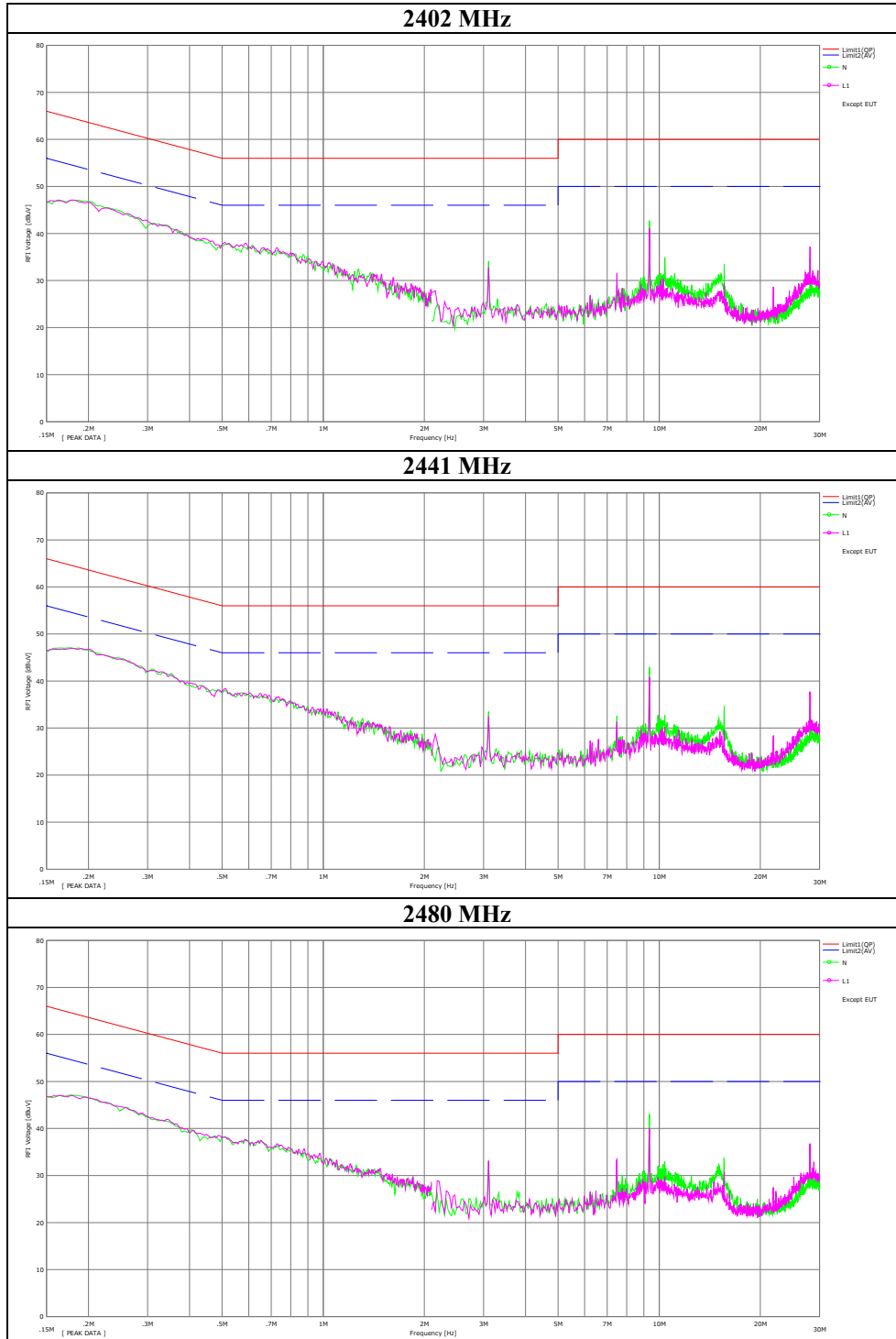

Y scale [dBuV]

Chart — N — L

UL Japan, Inc.

Shonan EMC Lab.

1-22-3 Megumigaoka, Hiratsuka-shi, Kanagawa-ken, 259-1220 JAPAN

Telephone : +81 463 50 6400

Facsimile : +81 463 50 6401

Conducted Emission

Report No.	13004393S-C-R1
Test place	Shonan EMC Lab. No.3 Shielded Room
Date	September 20, 2019
Temperature / Humidity	24 deg. C / 58 % RH
Engineer	Takahiro Suzuki
Mode	Tx, Hopping Off, 3DH5

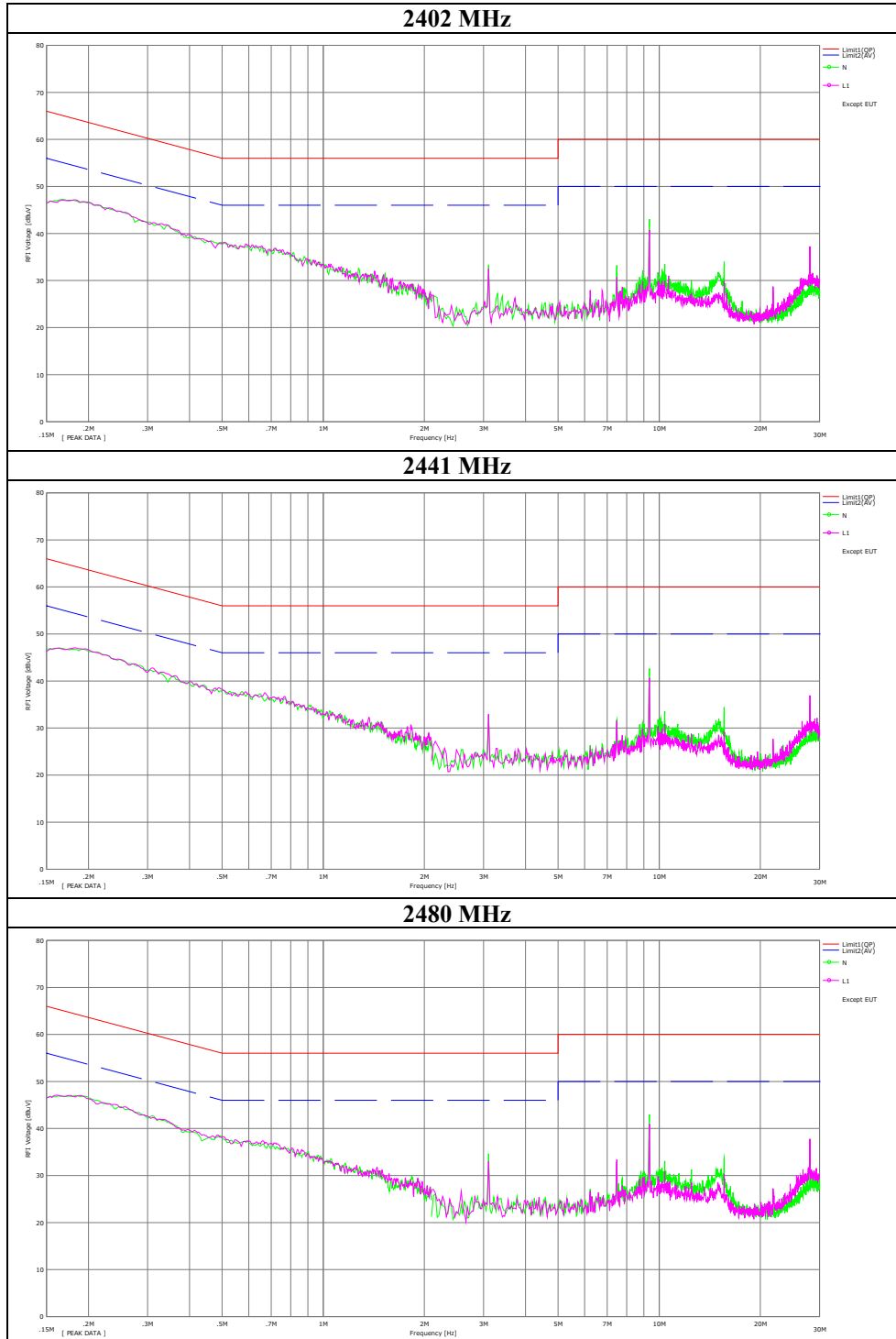

Y scale [dBuV]

Chart — N — L

UL Japan, Inc.

Shonan EMC Lab.

1-22-3 Megumigaoka, Hiratsuka-shi, Kanagawa-ken, 259-1220 JAPAN

Telephone : +81 463 50 6400

Facsimile : +81 463 50 6401

20dB Bandwidth, 99% Occupied Bandwidth and Carrier Frequency Separation

Report No. 13004393S-C-R1
 Test place Shonan EMC Lab. No.3 Shielded Room
 Date September 16, 2019
 Temperature / Humidity 24 deg. C / 57 % RH
 Engineer Kazuya Noda
 Mode Tx, Hopping Off, Tx, Hopping On

Mode	Freq. [MHz]	20dB Bandwidth [MHz]	99% Occupied Bandwidth [kHz]	Carrier Frequency Separation [MHz]	Limit for Carrier Frequency separation [MHz]
DH5	2402.0	0.961890	902.1019	1.000	>= 0.641
DH5	2441.0	0.960314	904.5124	1.000	>= 0.640
DH5	2480.0	0.963153	904.2160	1.000	>= 0.642
DH5	Hopping On	-	78637.4	-	-
3DH5	2402.0	1.303	1191.8	1.000	>= 0.868
3DH5	2441.0	1.302	1191.2	1.000	>= 0.868
3DH5	2480.0	1.302	1190.6	1.000	>= 0.868
3DH5	Hopping On	-	78789.2	-	-

Limit: Two-thirds of 20dB Bandwidth or 25kHz (whichever is greater).
 No limit applies to 20dB Bandwidth.

UL Japan, Inc.

Shonan EMC Lab.

1-22-3 Megumigaoka, Hiratsuka-shi, Kanagawa-ken, 259-1220 JAPAN

Telephone : +81 463 50 6400

Facsimile : +81 463 50 6401

20dB Bandwidth and 99% Occupied Bandwidth

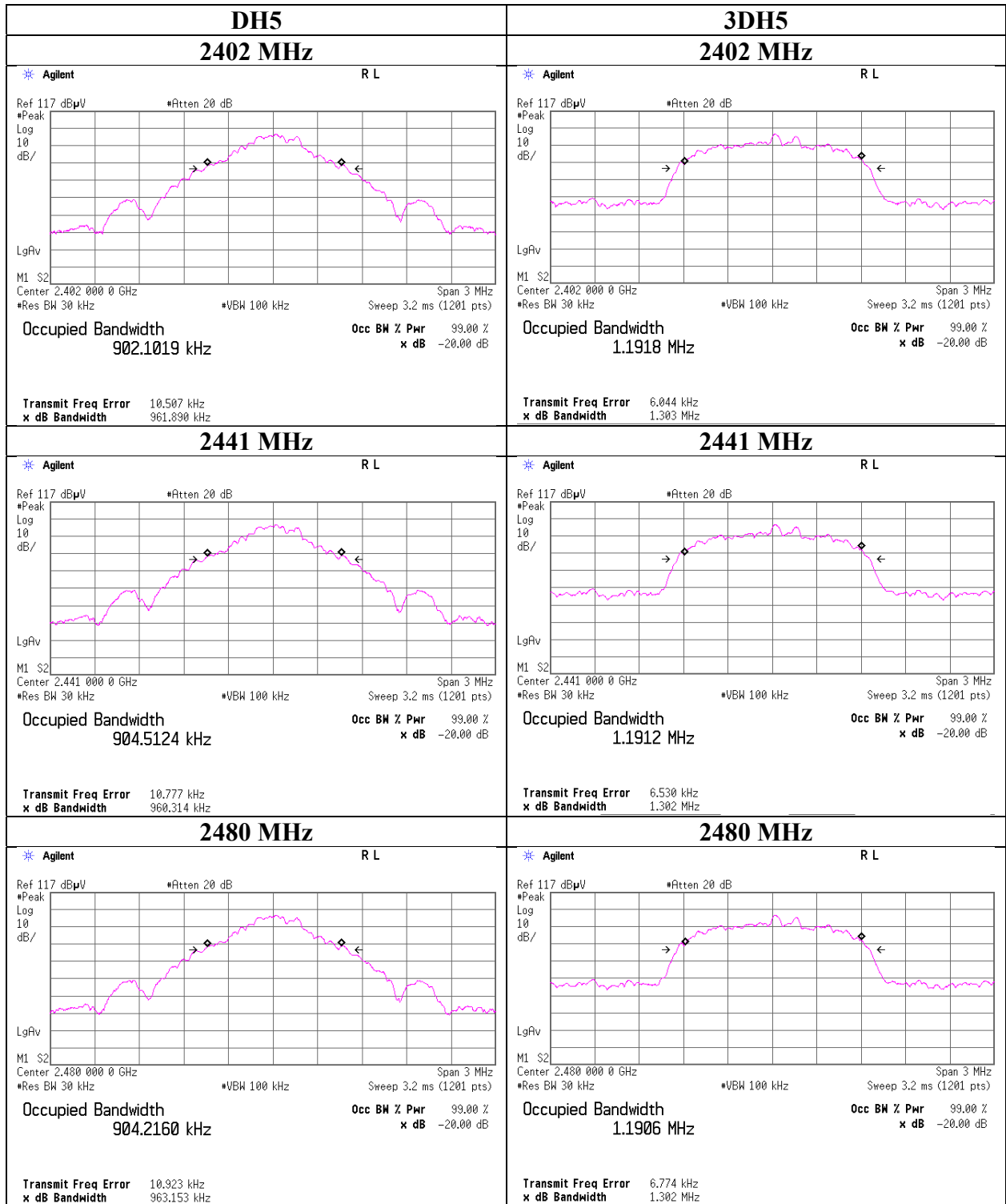

UL Japan, Inc.

Shonan EMC Lab.

1-22-3 Megumigaoka, Hiratsuka-shi, Kanagawa-ken, 259-1220 JAPAN

Telephone : +81 463 50 6400

Facsimile : +81 463 50 6401

20dB Bandwidth and 99% Occupied Bandwidth

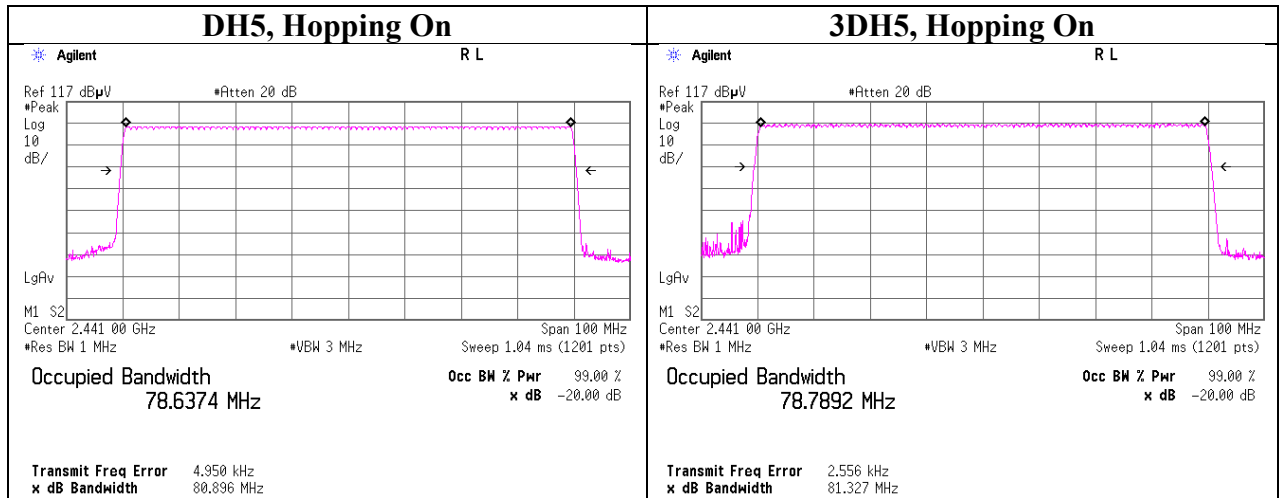

UL Japan, Inc.

Shonan EMC Lab.

1-22-3 Megumigaoka, Hiratsuka-shi, Kanagawa-ken, 259-1220 JAPAN

Telephone : +81 463 50 6400

Facsimile : +81 463 50 6401

Carrier Frequency Separation

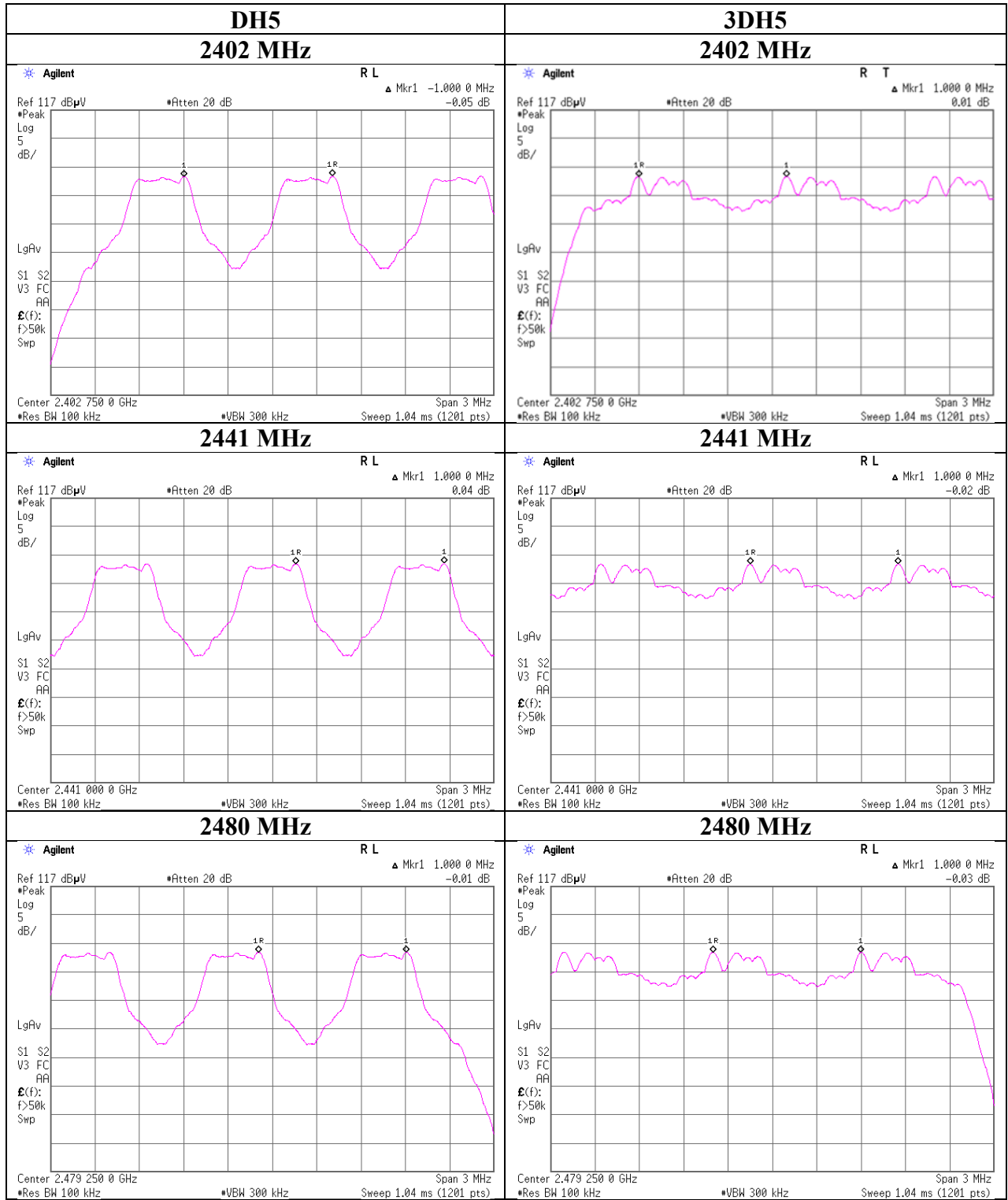

UL Japan, Inc.

Shonan EMC Lab.

1-22-3 Megumigaoka, Hiratsuka-shi, Kanagawa-ken, 259-1220 JAPAN

Telephone : +81 463 50 6400

Facsimile : +81 463 50 6401

Number of Hopping Frequency

Report No. 13004393S-C-R1
Test place Shonan EMC Lab. No.3 Shielded Room
Date September 16, 2019
Temperature / Humidity 24 deg. C / 57 % RH
Engineer Kazuya Noda
Mode Tx, Hopping On

Mode	Number of channel [channels]	Limit [channels]
DH5	79	≥ 15
3DH5	79	≥ 15

Test was not performed at AFH mode whose number of hopping channel is 20 channels because this Bluetooth radio is in compliance of Bluetooth Specification.

Number of Hopping Frequency

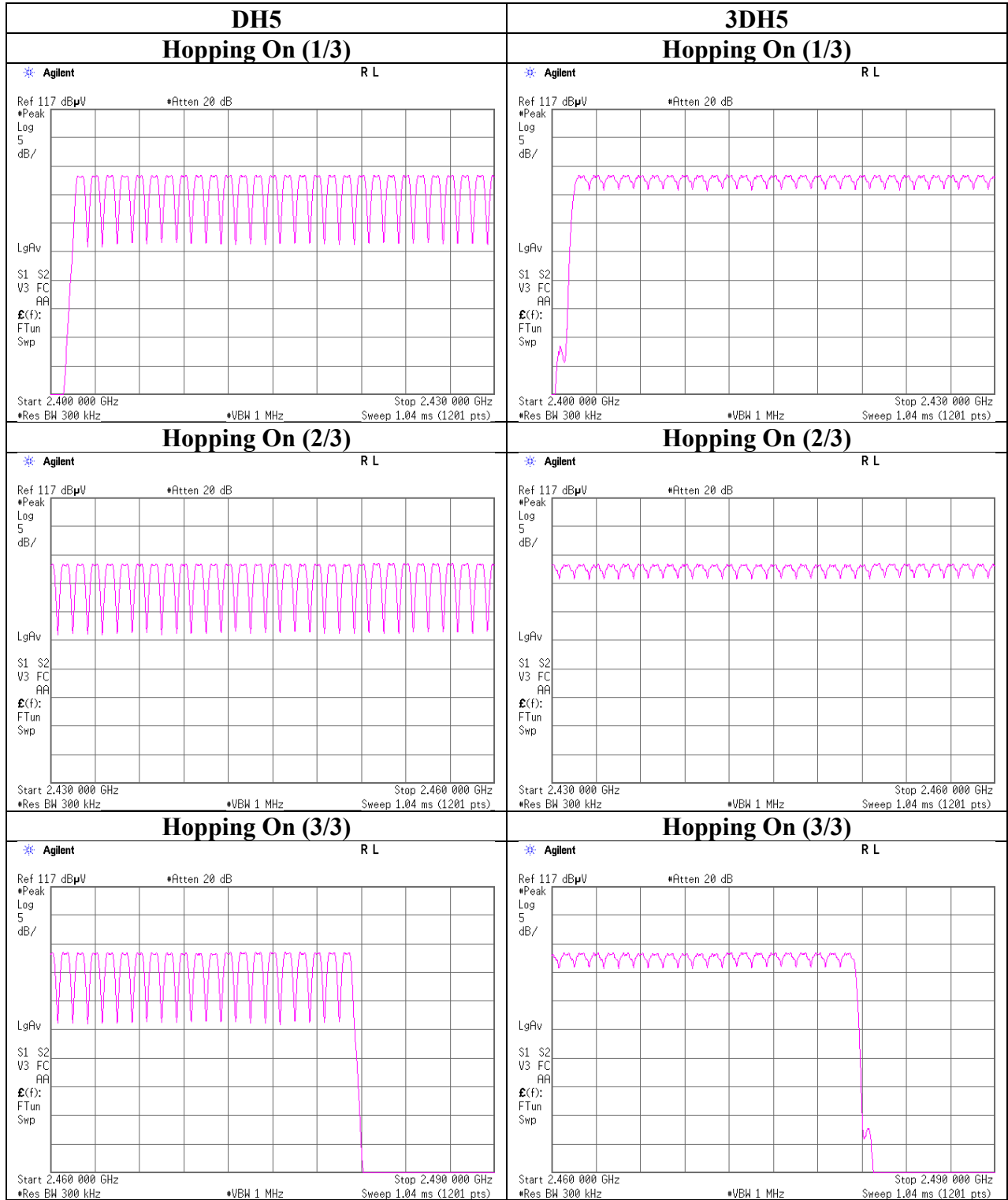

Dwell time

Report No. 13004393S-C-R1
Test place Shonan EMC Lab. No.3 Shielded Room
Date September 16, 2019
Temperature / Humidity 24 deg. C / 57 % RH
Engineer Kazuya Noda
Mode Tx, Hopping On

Mode	Number of transmission in a 31.6(79 Hopping x 0.4) / 12.8 (32 Hopping x 0.4) second period			Length of transmission [msec]	Result [msec]	Limit [msec]	
DH1	49.2 times /	5 sec. x	31.6 sec. =	311 times	0.400	124	400
DH3	27.0 times /	5 sec. x	31.6 sec. =	171 times	1.656	283	400
DH5	19.0 times /	5 sec. x	31.6 sec. =	121 times	2.905	351	400
3DH1	49.6 times /	5 sec. x	31.6 sec. =	314 times	0.406	128	400
3DH3	27.2 times /	5 sec. x	31.6 sec. =	172 times	1.656	285	400
3DH5	20.6 times /	5 sec. x	31.6 sec. =	131 times	2.909	381	400

Sample Calculation

Result = Number of transmission x Length of transmission

*Average data of 5 tests.(except Inquiry)

Mode	Sampling [times]					Average [times]
	1	2	3	4	5	
DH1	48	50	49	50	49	49.2
DH3	25	29	29	24	28	27.0
DH5	19	18	21	17	20	19.0
3DH1	51	49	48	50	50	49.6
3DH3	28	29	26	25	28	27.2
3DH5	20	19	19	23	22	20.6

Sample Calculation

Average = Summation (Sampling 1 to 5) / 5

This device complies with the Bluetooth protocol for FHSS operation, employing a pseudo random channel selection and hopping rate to ensure that the occupancy time in $N \times 0.4s$, where N is the number of channels being used in the hopping sequence ($20 \leq N \leq 79$), is always less than $0.4s$ regardless of packet size. This is confirmed in the test report for $N = 79$.

Dwell time

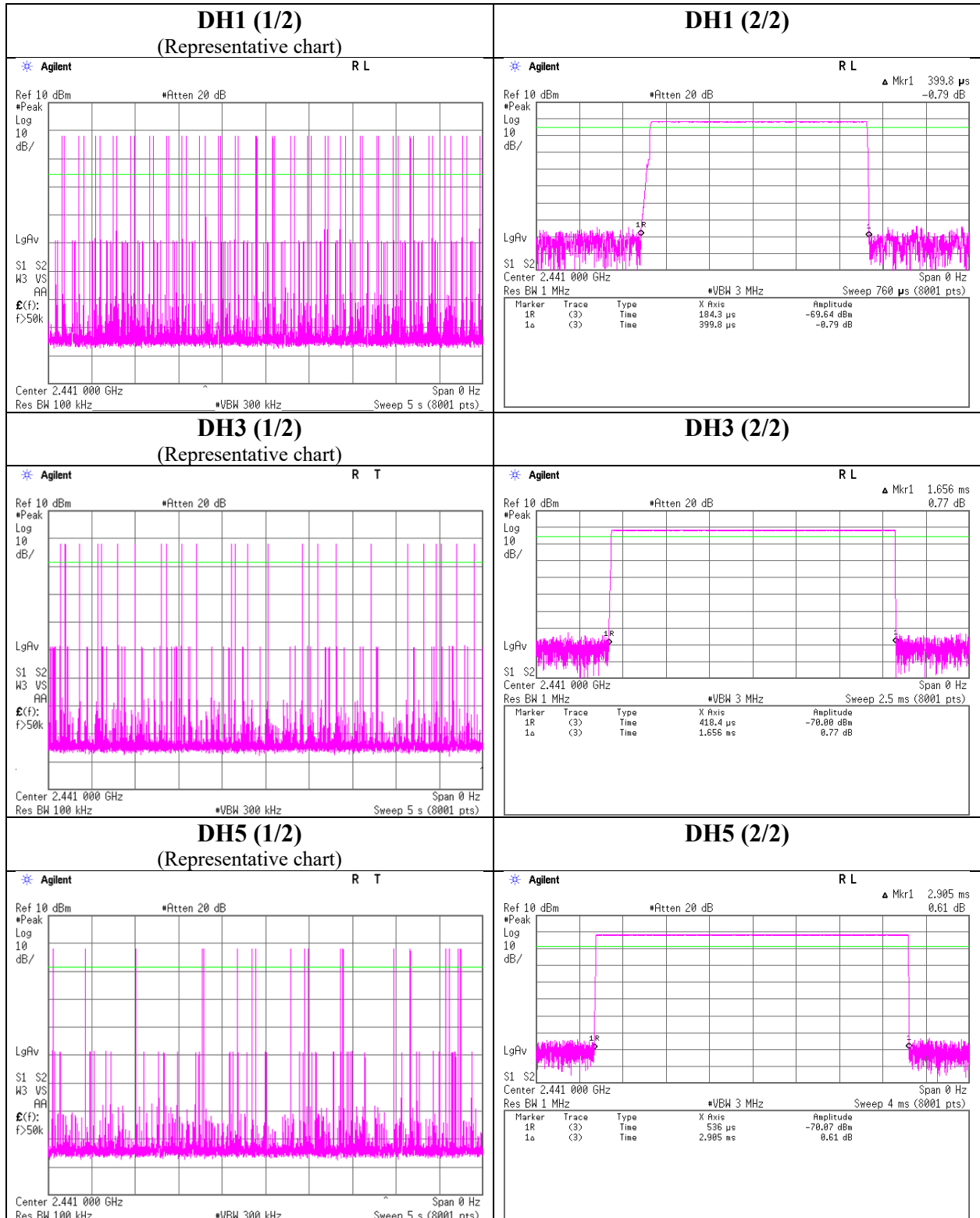

UL Japan, Inc.

Shonan EMC Lab.

1-22-3 Megumigaoka, Hiratsuka-shi, Kanagawa-ken, 259-1220 JAPAN

Telephone : +81 463 50 6400

Facsimile : +81 463 50 6401

Dwell time

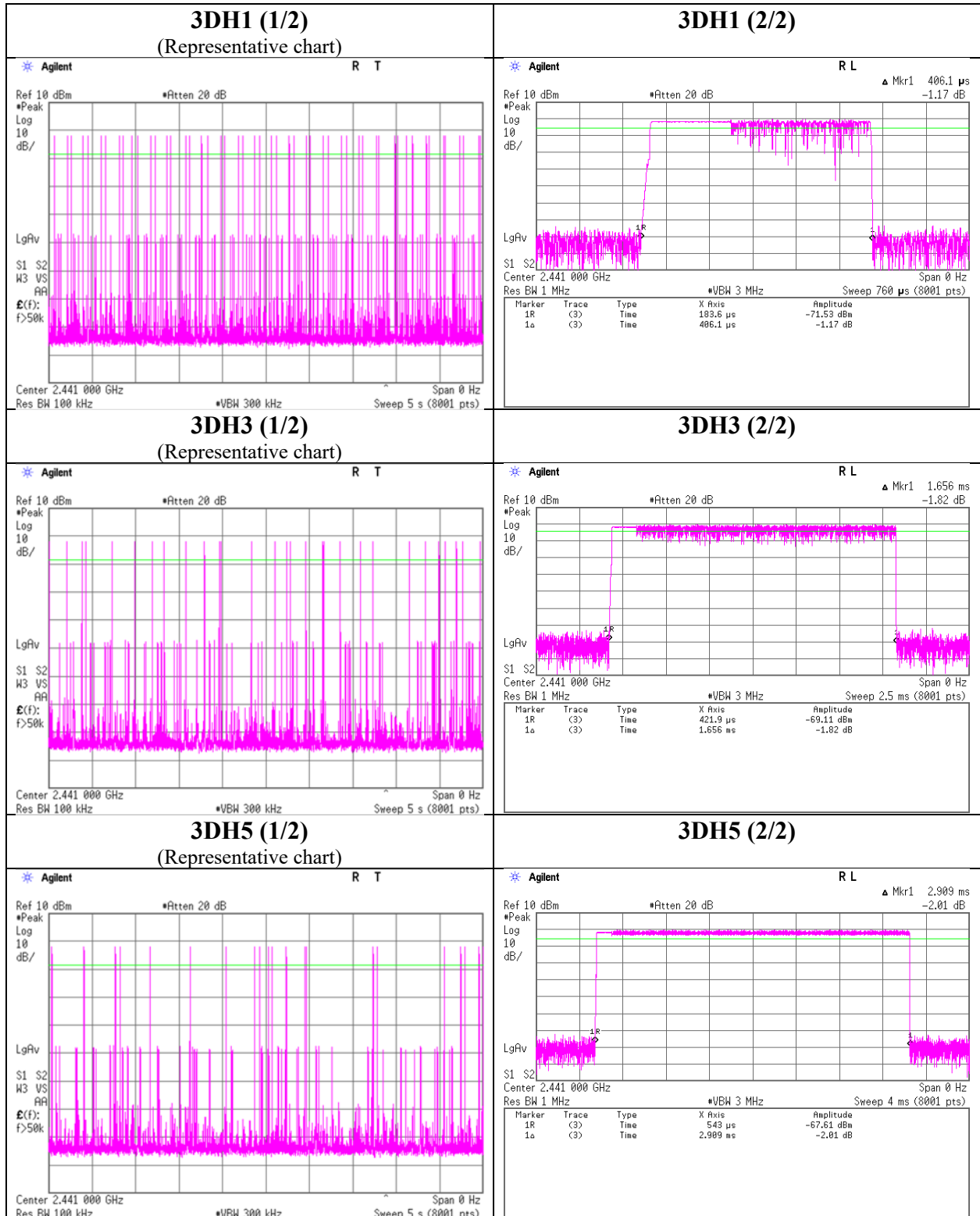

UL Japan, Inc.

Shonan EMC Lab.

1-22-3 Megumigaoka, Hiratsuka-shi, Kanagawa-ken, 259-1220 JAPAN

Telephone : +81 463 50 6400

Facsimile : +81 463 50 6401

Maximum Peak Output Power

Report No. 13004393S-C-R1
Test place Shonan EMC Lab. No.3 Shielded Room
Date September 16, 2019
Temperature / Humidity 24 deg. C / 57 % RH
Engineer Kazuya Noda
Mode Tx, Hopping Off

Mode	Freq. [MHz]	Reading [dBm]	Cable Loss [dB]	Atten. Loss [dB]	Conducted Power					e.i.r.p. for RSS-247					
					Result		Limit		Margin	Antenna Gain [dBi]	Result		Limit		Margin
					[dBm]	[mW]	[dBm]	[mW]			[dB]	[dBm]	[mW]	[dBm]	
DH5	2402.0	-1.27	1.32	9.92	9.97	9.93	20.96	125	10.99	0.93	10.90	12.30	36.02	4000	25.12
DH5	2441.0	-1.29	1.33	9.92	9.96	9.91	20.96	125	11.00	0.93	10.89	12.27	36.02	4000	25.13
DH5	2480.0	-1.28	1.33	9.92	9.97	9.93	20.96	125	10.99	0.93	10.90	12.30	36.02	4000	25.12
2DH5	2402.0	0.08	1.32	9.92	11.32	13.55	20.96	125	9.64	0.93	12.25	16.79	36.02	4000	23.77
2DH5	2441.0	0.13	1.33	9.92	11.38	13.74	20.96	125	9.58	0.93	12.31	17.02	36.02	4000	23.71
2DH5	2480.0	0.16	1.33	9.92	11.41	13.84	20.96	125	9.55	0.93	12.34	17.14	36.02	4000	23.68
3DH5	2402.0	0.38	1.32	9.92	11.62	14.52	20.96	125	9.34	0.93	12.55	17.99	36.02	4000	23.47
3DH5	2441.0	0.42	1.33	9.92	11.67	14.69	20.96	125	9.29	0.93	12.60	18.20	36.02	4000	23.42
3DH5	2480.0	0.47	1.33	9.92	11.72	14.86	20.96	125	9.24	0.93	12.65	18.41	36.02	4000	23.37

Sample Calculation:

Result = Reading + Cable Loss (including the cable(s) customer supplied) + Attenuator Loss

e.i.r.p. Result = Conducted Power Result + Antenna Gain

Test was not performed at AFH mode, because the decrease of number of channel (min: 20ch) at AFH mode does not influence on the output power and bandwidth of the EUT.

As this device had AFH mode and frequency separation could not meet the requirement of over 20dB BW without 2/3 relaxation, 125mW power limit was applied to it.

UL Japan, Inc.

Shonan EMC Lab.

1-22-3 Megumigaoka, Hiratsuka-shi, Kanagawa-ken, 259-1220 JAPAN

Telephone : +81 463 50 6400

Facsimile : +81 463 50 6401

Average Output Power
(Reference data for RF Exposure)

Report No. 13004393S-C-R1
Test place Shonan EMC Lab. No.3 Shielded Room
Date September 16, 2019
Temperature / Humidity 24 deg. C / 57 % RH
Engineer Kazuya Noda
Mode Tx, Hopping Off

Mode	Freq. [MHz]	Reading [dBm]	Cable Loss [dB]	Atten. Loss [dB]	Result (Time average)		Duty factor [dB]	Result (Burst power average)	
					[dBm]	[mW]		[dBm]	[mW]
DH5	2402.0	-2.67	1.32	9.92	8.57	7.19	1.11	9.68	9.29
DH5	2441.0	-2.66	1.33	9.92	8.59	7.23	1.11	9.70	9.33
DH5	2480.0	-2.67	1.33	9.92	8.58	7.21	1.11	9.69	9.31
2DH5	2402.0	-3.21	1.32	9.92	8.03	6.35	1.11	9.14	8.20
2DH5	2441.0	-3.20	1.33	9.92	8.05	6.38	1.11	9.16	8.24
2DH5	2480.0	-3.16	1.33	9.92	8.09	6.44	1.11	9.20	8.32
3DH5	2402.0	-3.22	1.32	9.92	8.02	6.34	1.11	9.13	8.18
3DH5	2441.0	-3.18	1.33	9.92	8.07	6.41	1.11	9.18	8.28
3DH5	2480.0	-3.15	1.33	9.92	8.10	6.46	1.11	9.21	8.34

Sample Calculation:

Result (Time average) = Reading + Cable Loss (including the cable(s) customer supplied) + Attenuator Loss

Result (Burst power average) = Time average + Duty factor

*The equipment and cables were not used for factor 0 dB of the data sheets.

Burst Rate Confirmation

Report No. 13004393S-C-R1
Test place Shonan EMC Lab. No.3 Shielded Room
Date September 16, 2019
Temperature / Humidity 24 deg. C / 57 % RH
Engineer Kazuya Noda
Mode Tx, Hopping Off

DH5

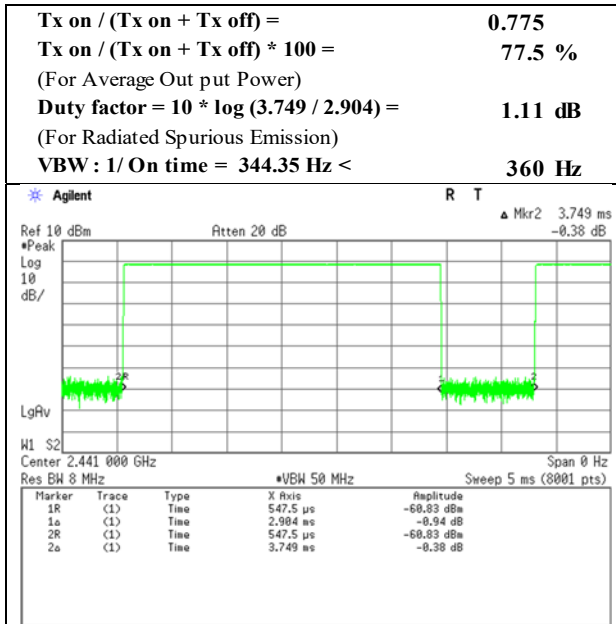

2DH5

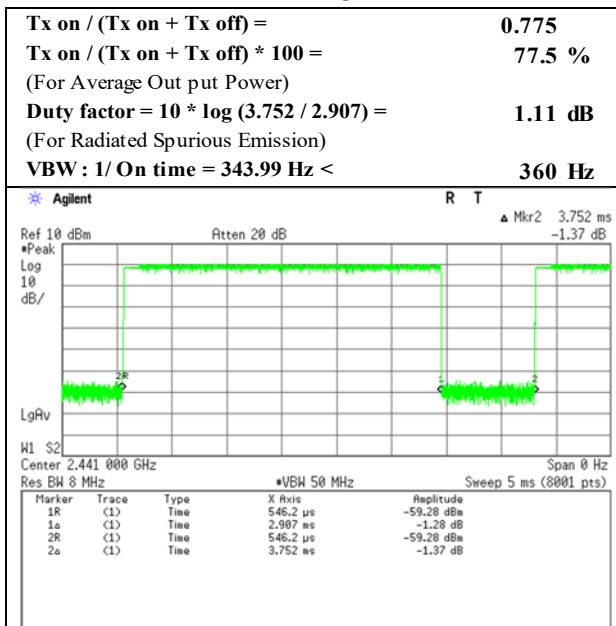

3DH5

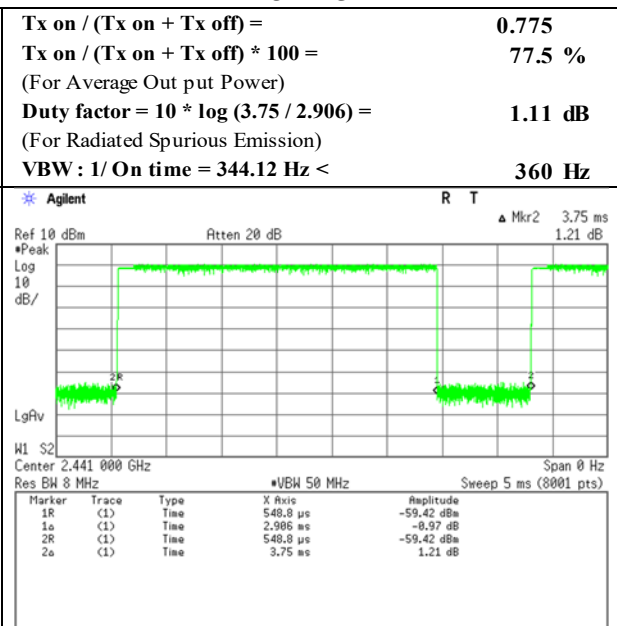

Radiated Spurious Emission

Report No.	13004393S-C-R1		
Test place	Shonan EMC Lab.		
Semi Anechoic Chamber	No.3	No.3	No.3
Date	September 17, 2019	September 18, 2019	September 19, 2019
Temperature / Humidity	23 deg. C / 64 % RH	24 deg. C / 58 % RH	24 deg. C / 58 % RH
Engineer	Takahiro Suzuki	Hiromasa Sato	Kenichi Adachi
	(30 MHz - 1000 MHz)	(1 GHz - 13 GHz)	(13 GHz - 26.5 GHz)
Mode	Tx, Hopping Off, DH5 2402 MHz		

(* PK: Peak, AV: Average, QP: Quasi-Peak)

Polarity	Frequency [MHz]	Detector	Reading [dBuV]	Ant.Fac. [dB/m]	Loss [dB]	Gain [dB]	Distance Factor [dB]	Result [dBuV/m]	Limit [dBuV/m]	Margin [dB]	Height [cm]	Angle [deg]	Remark
Hori.	145.431	QP	36.29	14.50	7.74	32.12	0.00	26.41	43.5	17.0	244	187	-
Hori.	249.551	QP	37.34	11.59	8.42	32.01	0.00	25.34	46.0	20.6	119	112	-
Hori.	713.995	QP	31.57	19.62	10.42	31.84	0.00	29.77	46.0	16.2	120	229	-
Hori.	945.580	QP	28.42	21.57	11.16	30.68	0.00	30.47	46.0	15.5	100	253	-
Hori.	2390.000	PK	47.25	28.33	14.16	41.59	2.15	50.30	73.9	23.6	159	65	-
Hori.	4804.000	PK	49.12	31.62	6.44	42.88	2.15	46.45	73.9	27.4	150	50	-
Hori.	7206.000	PK	47.79	37.23	7.87	42.92	2.15	52.12	73.9	21.7	100	0	-
Hori.	9608.000	PK	49.18	38.84	9.17	43.17	2.15	56.17	73.9	17.7	124	45	-
Hori.	2390.000	AV	35.68	28.33	14.16	41.59	2.15	38.73	53.9	15.1	159	65	VBW: 360 Hz
Hori.	4804.000	AV	39.93	31.62	6.44	42.88	2.15	37.26	53.9	16.6	150	50	VBW: 360 Hz
Hori.	7206.000	AV	37.42	37.23	7.87	42.92	2.15	41.75	53.9	12.1	100	0	VBW: 360 Hz
Hori.	9608.000	AV	38.80	38.84	9.17	43.17	2.15	45.79	53.9	8.1	124	45	VBW: 360 Hz
Vert.	67.866	QP	44.13	6.67	6.67	32.18	0.00	25.29	40.0	14.7	100	200	-
Vert.	107.540	QP	43.21	11.38	7.30	32.15	0.00	29.74	43.5	13.7	100	10	-
Vert.	163.633	QP	35.27	15.20	7.92	32.11	0.00	26.28	43.5	17.2	100	298	-
Vert.	719.967	QP	32.76	19.75	10.44	31.83	0.00	31.12	46.0	14.8	100	179	-
Vert.	2390.000	PK	47.97	28.33	14.16	41.59	2.15	51.02	73.9	22.8	119	97	-
Vert.	4804.000	PK	49.62	31.62	6.44	42.88	2.15	46.95	73.9	26.9	182	208	-
Vert.	7206.000	PK	48.43	37.23	7.87	42.92	2.15	52.76	73.9	21.1	100	0	-
Vert.	9608.000	PK	49.26	38.84	9.17	43.17	2.15	56.25	73.9	17.6	122	81	-
Vert.	2390.000	AV	35.83	28.33	14.16	41.59	2.15	38.88	53.9	15.0	119	97	VBW: 360 Hz
Vert.	4804.000	AV	41.19	31.62	6.44	42.88	2.15	38.52	53.9	15.3	182	208	VBW: 360 Hz
Vert.	7206.000	AV	37.50	37.23	7.87	42.92	2.15	41.83	53.9	12.0	100	0	VBW: 360 Hz
Vert.	9608.000	AV	38.49	38.84	9.17	43.17	2.15	45.48	53.9	8.4	122	81	VBW: 360 Hz

Result = Reading + Ant.Fac. + Loss (Cable+(Attenuator or Filter)(below 18 GHz)) - Gain(Amplifier) + Distance factor

Distance factor : 1 GHz - 13 GHz : 20log(3.84 m / 3.0 m) = 2.15 dB

13 GHz - 40 GHz : 20log(1.0 m / 3.0 m) = -9.54 dB

* These results have sufficient margin without taking account Dwell time factor.

20 dBc Data Sheet (RBW 100 kHz, VBW 300 kHz)

Polarity	Frequency [MHz]	Detector	Reading [dBuV]	Ant.Fac. [dB/m]	Loss [dB]	Gain [dB]	Distance Factor [dB]	Result [dBuV/m]	Limit [dBuV/m]	Margin [dB]	Remark
Hori.	2402.000	PK	102.94	28.31	14.17	41.60	2.15	105.97	-	-	Carrier
Hori.	2400.000	PK	44.64	28.31	14.16	41.60	2.15	47.66	85.97	38.3	-
Vert.	2402.000	PK	103.67	28.31	14.17	41.60	2.15	106.70	-	-	Carrier
Vert.	2400.000	PK	45.44	28.31	14.16	41.60	2.15	48.46	86.70	38.2	-

Result = Reading + Ant.Fac. + Loss (Cable+(Attenuator or Filter)(below 18 GHz)) - Gain(Amplifier) + Distance factor

Distance factor : 1 GHz - 13 GHz : 20log(3.84 m / 3.0 m) = 2.15 dB

13 GHz - 40 GHz : 20log(1.0 m / 3.0 m) = -9.54 dB

UL Japan, Inc.

Shonan EMC Lab.

1-22-3 Megumigaoka, Hiratsuka-shi, Kanagawa-ken, 259-1220 JAPAN

Telephone : +81 463 50 6400

Facsimile : +81 463 50 6401

Radiated Spurious Emission
(Reference Plot for band-edge)

Report No. 13004393S-C-R1
Test place Shonan EMC Lab.
Semi Anechoic Chamber No.3
Date September 18, 2019
Temperature / Humidity 24 deg. C / 58 % RH
Engineer Hiromasa Sato
(1 GHz - 13 GHz)
Mode Tx, Hopping Off, DH5 2402 MHz

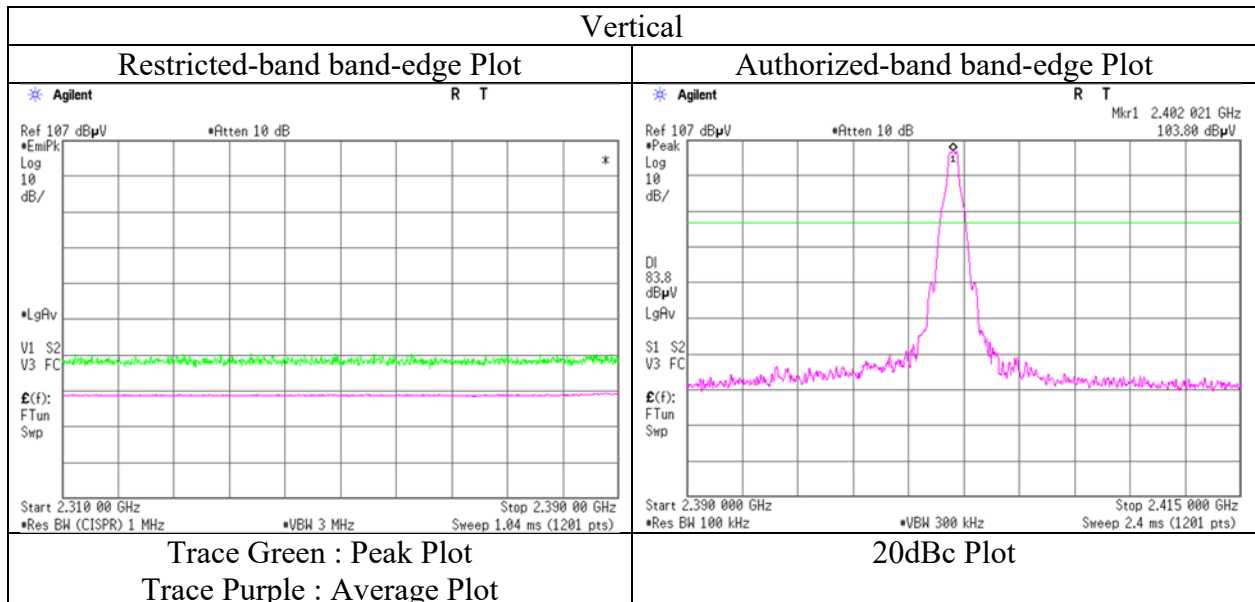
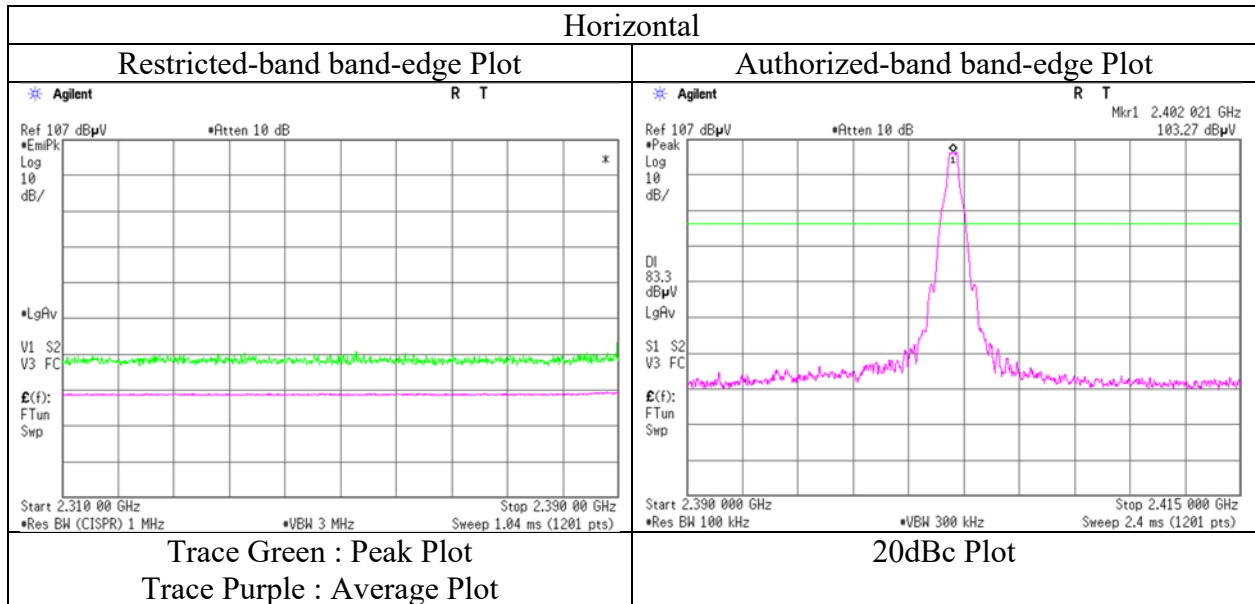

* The measurement was conducted for a sufficiently long enough time to detect any possible spurious emissions.
Final result of restricted band edge was shown in tabular data.

Radiated Spurious Emission

Report No.	13004393S-C-R1		
Test place	Shonan EMC Lab.		
Semi Anechoic Chamber	No.3	No.3	No.3
Date	September 17, 2019	September 18, 2019	September 19, 2019
Temperature / Humidity	23 deg. C / 64 % RH	23 deg. C / 56 % RH	24 deg. C / 58 % RH
Engineer	Takahiro Suzuki	Takahiro Suzuki	Kenichi Adachi
	(30 MHz - 1000 MHz)	(1 GHz - 13 GHz)	(13 GHz - 26.5 GHz)
Mode	Tx, Hopping Off, DH5 2441 MHz		

(* PK: Peak, AV: Average, QP: Quasi-Peak)

Polarity	Frequency [MHz]	Detector	Reading [dBuV]	Ant.Fac. [dB/m]	Loss [dB]	Gain [dB]	Distance Factor [dB]	Result [dBuV/m]	Limit [dBuV/m]	Margin [dB]	Height [cm]	Angle [deg]	Remark
Hori.	145.704	QP	36.08	14.51	7.76	32.12	0.00	26.23	43.5	17.2	245	195	-
Hori.	249.158	QP	37.25	11.59	8.41	32.01	0.00	25.24	46.0	20.7	117	118	-
Hori.	713.914	QP	31.66	19.62	10.42	31.84	0.00	29.86	46.0	16.1	123	221	-
Hori.	949.753	QP	28.32	21.59	11.17	30.64	0.00	30.44	46.0	15.5	100	314	-
Hori.	4882.000	PK	48.97	31.71	6.49	42.89	2.15	46.43	73.9	27.4	100	73	-
Hori.	7323.000	PK	47.37	37.39	7.96	43.15	2.15	51.72	73.9	22.1	150	0	-
Hori.	9764.000	PK	46.17	39.34	9.22	43.01	2.15	53.87	73.9	20.0	150	0	-
Hori.	4882.000	AV	38.67	31.71	6.49	42.89	2.15	36.13	53.9	17.7	100	73	VBW: 360 Hz
Hori.	7323.000	AV	35.32	37.39	7.96	43.15	2.15	39.67	53.9	14.2	150	0	VBW: 360 Hz
Hori.	9764.000	AV	35.22	39.34	9.22	43.01	2.15	42.92	53.9	10.9	150	0	VBW: 360 Hz
Vert.	67.440	QP	44.09	6.72	6.65	32.18	0.00	25.28	40.0	14.7	100	186	-
Vert.	108.180	QP	43.16	11.49	7.29	32.15	0.00	29.79	43.5	13.7	100	1	-
Vert.	176.219	QP	36.04	15.78	7.89	32.09	0.00	27.62	43.5	15.8	100	311	-
Vert.	719.963	QP	32.69	19.75	10.44	31.83	0.00	31.05	46.0	14.9	100	142	-
Vert.	4882.000	PK	48.65	31.71	6.49	42.89	2.15	46.11	73.9	27.7	119	203	-
Vert.	7323.000	PK	47.08	37.39	7.96	43.15	2.15	51.43	73.9	22.4	150	0	-
Vert.	9764.000	PK	46.91	39.34	9.22	43.01	2.15	54.61	73.9	19.2	150	0	-
Vert.	4882.000	AV	37.26	31.71	6.49	42.89	2.15	34.72	53.9	19.1	119	203	VBW: 360 Hz
Vert.	7323.000	AV	35.52	37.39	7.96	43.15	2.15	39.87	53.9	14.0	150	0	VBW: 360 Hz
Vert.	9764.000	AV	35.60	39.34	9.22	43.01	2.15	43.30	53.9	10.6	150	0	VBW: 360 Hz

Result = Reading + Ant.Fac. + Loss (Cable+(Attenuator or Filter)(below 18 GHz)) - Gain(Amplifier) + Distance factor

Distance factor : 1 GHz - 13 GHz : $20\log(3.84\text{ m} / 3.0\text{ m}) = 2.15\text{ dB}$

13 GHz - 40 GHz : $20\log(1.0\text{ m} / 3.0\text{ m}) = -9.54\text{ dB}$

* These results have sufficient margin without taking account Dwell time factor.

Radiated Spurious Emission

Report No.	13004393S-C-R1		
Test place	Shonan EMC Lab.		
Semi Anechoic Chamber	No.3	No.3	No.3
Date	September 17, 2019	September 18, 2019	September 19, 2019
Temperature / Humidity	23 deg. C / 64 % RH	23 deg. C / 56 % RH	24 deg. C / 58 % RH
Engineer	Takahiro Suzuki	Takahiro Suzuki	Kenichi Adachi
	(30 MHz - 1000 MHz)	(1 GHz - 13 GHz)	(13 GHz - 26.5 GHz)
Mode	Tx, Hopping Off, DH5 2480 MHz		

(* PK: Peak, AV: Average, QP: Quasi-Peak)

Polarity	Frequency [MHz]	Detector	Reading [dBuV]	Ant.Fac. [dB/m]	Loss [dB]	Gain [dB]	Distance Factor [dB]	Result [dBuV/m]	Limit [dBuV/m]	Margin [dB]	Height [cm]	Angle [deg]	Remark
Hori.	145.924	QP	36.31	14.51	7.76	32.12	0.00	26.46	43.5	17.0	246	197	-
Hori.	248.244	QP	37.25	11.57	8.41	32.01	0.00	25.22	46.0	20.7	121	139	-
Hori.	713.996	QP	31.47	19.62	10.42	31.84	0.00	29.67	46.0	16.3	123	116	-
Hori.	945.602	QP	28.36	21.57	11.16	30.68	0.00	30.41	46.0	15.5	100	343	-
Hori.	2483.500	PK	59.04	28.24	14.24	41.62	2.15	62.05	73.9	11.8	143	65	-
Hori.	4960.000	PK	48.76	31.96	6.54	42.91	2.15	46.50	73.9	27.4	137	72	-
Hori.	7440.000	PK	47.98	37.56	8.03	43.38	2.15	52.34	73.9	21.5	150	0	-
Hori.	9920.000	PK	45.83	39.18	9.26	42.84	2.15	53.58	73.9	20.3	150	0	-
Hori.	2483.500	AV	39.14	28.24	14.24	41.62	2.15	42.15	53.9	11.7	143	65	VBW: 360 Hz
Hori.	4960.000	AV	39.15	31.96	6.54	42.91	2.15	36.89	53.9	17.0	137	72	VBW: 360 Hz
Hori.	7440.000	AV	35.51	37.56	8.03	43.38	2.15	39.87	53.9	14.0	150	0	VBW: 360 Hz
Hori.	9920.000	AV	34.29	39.18	9.26	42.84	2.15	42.04	53.9	11.8	150	0	VBW: 360 Hz
Vert.	67.726	QP	44.32	6.69	6.66	32.18	0.00	25.49	40.0	14.5	100	201	-
Vert.	107.850	QP	43.05	11.44	7.29	32.15	0.00	29.63	43.5	13.8	100	355	-
Vert.	176.245	QP	36.01	15.78	7.89	32.09	0.00	27.59	43.5	15.9	100	303	-
Vert.	726.007	QP	32.58	19.86	10.46	31.82	0.00	31.08	46.0	14.9	100	178	-
Vert.	2483.500	PK	55.26	28.24	14.24	41.62	2.15	58.27	73.9	15.6	116	111	-
Vert.	4960.000	PK	48.97	31.96	6.54	42.91	2.15	46.71	73.9	27.1	135	16	-
Vert.	7440.000	PK	47.81	37.56	8.03	43.38	2.15	52.17	73.9	21.7	150	0	-
Vert.	9920.000	PK	46.42	39.18	9.26	42.84	2.15	54.17	73.9	19.7	150	0	-
Vert.	2483.500	AV	36.76	28.24	14.24	41.62	2.15	39.77	53.9	14.1	116	111	VBW: 360 Hz
Vert.	4960.000	AV	37.69	31.96	6.54	42.91	2.15	35.43	53.9	18.4	135	16	VBW: 360 Hz
Vert.	7440.000	AV	35.51	37.56	8.03	43.38	2.15	39.87	53.9	14.0	150	0	VBW: 360 Hz
Vert.	9920.000	AV	34.33	39.18	9.26	42.84	2.15	42.08	53.9	11.8	150	0	VBW: 360 Hz

Result = Reading + Ant.Fac. + Loss (Cable+(Attenuator or Filter)(below 18 GHz)) - Gain(Amplifier) + Distance factor

Distance factor : 1 GHz - 13 GHz : $20\log(3.84\text{ m} / 3.0\text{ m}) = 2.15\text{ dB}$

13 GHz - 40 GHz : $20\log(1.0\text{ m} / 3.0\text{ m}) = -9.54\text{ dB}$

* These results have sufficient margin without taking account Dwell time factor.

UL Japan, Inc.

Shonan EMC Lab.

1-22-3 Megumigaoka, Hiratsuka-shi, Kanagawa-ken, 259-1220 JAPAN

Telephone : +81 463 50 6400

Facsimile : +81 463 50 6401

Radiated Spurious Emission
(Reference Plot for band-edge)

Report No. 13004393S-C-R1
Test place Shonan EMC Lab.
Semi Anechoic Chamber No.3
Date September 18, 2019
Temperature / Humidity 23 deg. C / 56 % RH
Engineer Takahiro Suzuki
(1 GHz - 13 GHz)
Mode Tx, Hopping Off, DH5 2480 MHz

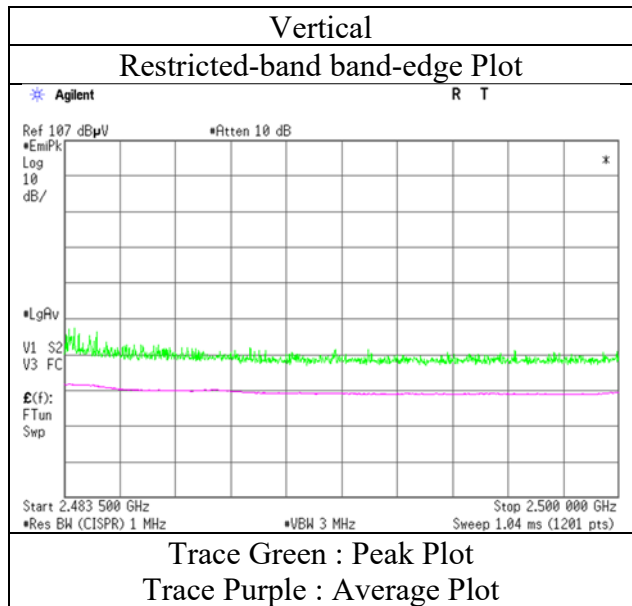
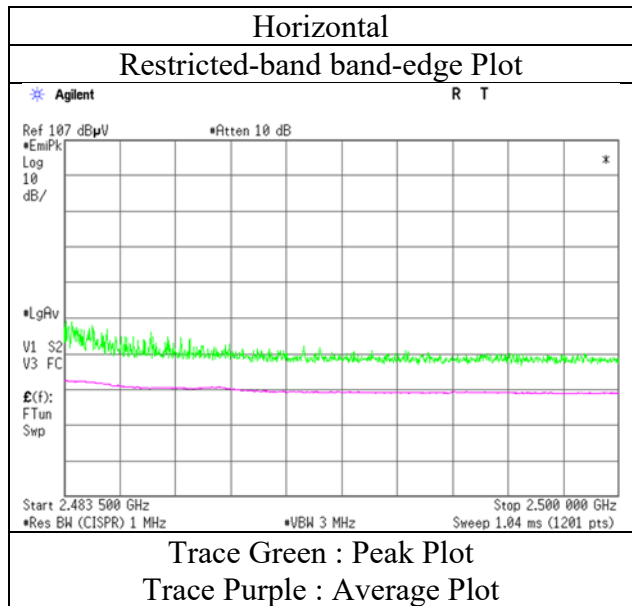

* The measurement was conducted for a sufficiently long enough time to detect any possible spurious emissions.

Final result of restricted band edge was shown in tabular data.

UL Japan, Inc.

Shonan EMC Lab.

1-22-3 Megumigaoka, Hiratsuka-shi, Kanagawa-ken, 259-1220 JAPAN

Telephone : +81 463 50 6400

Facsimile : +81 463 50 6401

Radiated Spurious Emission

Report No.	13004393S-C-R1		
Test place	Shonan EMC Lab.		
Semi Anechoic Chamber	No.3	No.3	No.3
Date	September 17, 2019	September 18, 2019	September 19, 2019
Temperature / Humidity	23 deg. C / 64 % RH	23 deg. C / 56 % RH	24 deg. C / 58 % RH
Engineer	Takahiro Suzuki	Takahiro Suzuki	Kenichi Adachi
	(30 MHz - 1000 MHz)	(1 GHz - 13 GHz)	(13 GHz - 26.5 GHz)
Mode	Tx, Hopping Off, 3DH5 2402 MHz		

(* PK: Peak, AV: Average, QP: Quasi-Peak)

Polarity	Frequency [MHz]	Detector	Reading [dBuV]	Ant.Fac. [dB/m]	Loss [dB]	Gain [dB]	Distance Factor [dB]	Result [dBuV/m]	Limit [dBuV/m]	Margin [dB]	Height [cm]	Angle [deg]	Remark
Hori.	146.096	QP	36.11	14.51	7.76	32.12	0.00	26.26	43.5	17.2	246	186	-
Hori.	250.201	QP	37.29	11.60	8.42	32.01	0.00	25.30	46.0	20.7	120	108	-
Hori.	713.973	QP	31.59	19.62	10.42	31.84	0.00	29.79	46.0	16.2	123	311	-
Hori.	949.841	QP	28.61	21.59	11.17	30.64	0.00	30.73	46.0	15.2	100	273	-
Hori.	2390.000	PK	51.62	28.33	14.16	41.59	2.15	54.67	73.9	19.2	187	65	-
Hori.	4804.000	PK	50.77	31.62	6.44	42.88	2.15	48.10	73.9	25.8	138	66	-
Hori.	7206.000	PK	47.88	37.23	7.87	42.92	2.15	52.21	73.9	21.6	150	0	-
Hori.	9608.000	PK	48.24	38.84	9.17	43.17	2.15	55.23	73.9	18.6	131	51	-
Hori.	2390.000	AV	34.81	28.33	14.16	41.59	2.15	37.86	53.9	16.0	187	65	VBW: 360 Hz
Hori.	4804.000	AV	40.33	31.62	6.44	42.88	2.15	37.66	53.9	16.2	138	66	VBW: 360 Hz
Hori.	7206.000	AV	35.89	37.23	7.87	42.92	2.15	40.22	53.9	13.6	150	0	VBW: 360 Hz
Hori.	9608.000	AV	36.97	38.84	9.17	43.17	2.15	43.96	53.9	9.9	131	51	VBW: 360 Hz
Vert.	67.708	QP	44.23	6.69	6.66	32.18	0.00	25.40	40.0	14.6	100	205	-
Vert.	108.060	QP	43.04	11.48	7.29	32.15	0.00	29.66	43.5	13.8	100	3	-
Vert.	164.222	QP	35.19	15.24	7.92	32.11	0.00	26.24	43.5	17.2	100	251	-
Vert.	720.025	QP	32.58	19.75	10.44	31.83	0.00	30.94	46.0	15.0	100	349	-
Vert.	2390.000	PK	52.68	28.33	14.16	41.59	2.15	55.73	73.9	18.1	119	99	-
Vert.	4804.000	PK	48.89	31.62	6.44	42.88	2.15	46.22	73.9	27.6	124	7	-
Vert.	7206.000	PK	48.39	37.23	7.87	42.92	2.15	52.72	73.9	21.1	150	0	-
Vert.	9608.000	PK	49.88	38.84	9.17	43.17	2.15	56.87	73.9	17.0	119	84	-
Vert.	2390.000	AV	34.55	28.33	14.16	41.59	2.15	37.60	53.9	16.3	119	99	VBW: 360 Hz
Vert.	4804.000	AV	38.17	31.62	6.44	42.88	2.15	35.50	53.9	18.4	124	7	VBW: 360 Hz
Vert.	7206.000	AV	35.59	37.23	7.87	42.92	2.15	39.92	53.9	13.9	150	0	VBW: 360 Hz
Vert.	9608.000	AV	37.22	38.84	9.17	43.17	2.15	44.21	53.9	9.6	119	84	VBW: 360 Hz

Result = Reading + Ant.Fac. + Loss (Cable+(Attenuator or Filter)(below 18 GHz)) - Gain(Amplifier) + Distance factor

Distance factor : 1 GHz - 13 GHz : 20log(3.84 m / 3.0 m) = 2.15 dB

13 GHz - 40 GHz : 20log(1.0 m / 3.0 m) = -9.54 dB

* These results have sufficient margin without taking account Dwell time factor.

20 dBc Data Sheet (RBW 100 kHz, VBW 300 kHz)

Polarity	Frequency [MHz]	Detector	Reading [dBuV]	Ant.Fac. [dB/m]	Loss [dB]	Gain [dB]	Distance Factor [dB]	Result [dBuV/m]	Limit [dBuV/m]	Margin [dB]	Remark
Hori.	2402.000	PK	104.01	28.31	14.17	41.60	2.15	107.04	-	-	Carrier
Hori.	2400.000	PK	45.67	28.31	14.16	41.60	2.15	48.69	87.04	38.3	-
Vert.	2402.000	PK	102.75	28.31	14.17	41.60	2.15	105.78	-	-	Carrier
Vert.	2400.000	PK	46.67	28.31	14.16	41.60	2.15	49.69	85.78	36.0	-

Result = Reading + Ant.Fac. + Loss (Cable+(Attenuator or Filter)(below 18 GHz)) - Gain(Amplifier) + Distance factor

Distance factor : 1 GHz - 13 GHz : 20log(3.84 m / 3.0 m) = 2.15 dB

13 GHz - 40 GHz : 20log(1.0 m / 3.0 m) = -9.54 dB

UL Japan, Inc.

Shonan EMC Lab.

1-22-3 Megumigaoka, Hiratsuka-shi, Kanagawa-ken, 259-1220 JAPAN

Telephone : +81 463 50 6400

Facsimile : +81 463 50 6401

Radiated Spurious Emission
(Reference Plot for band-edge)

Report No. 13004393S-C-R1
Test place Shonan EMC Lab.
Semi Anechoic Chamber No.3
Date September 18, 2019
Temperature / Humidity 23 deg. C / 56 % RH
Engineer Takahiro Suzuki
(1 GHz - 13 GHz)
Mode Tx, Hopping Off, 3DH5 2402 MHz

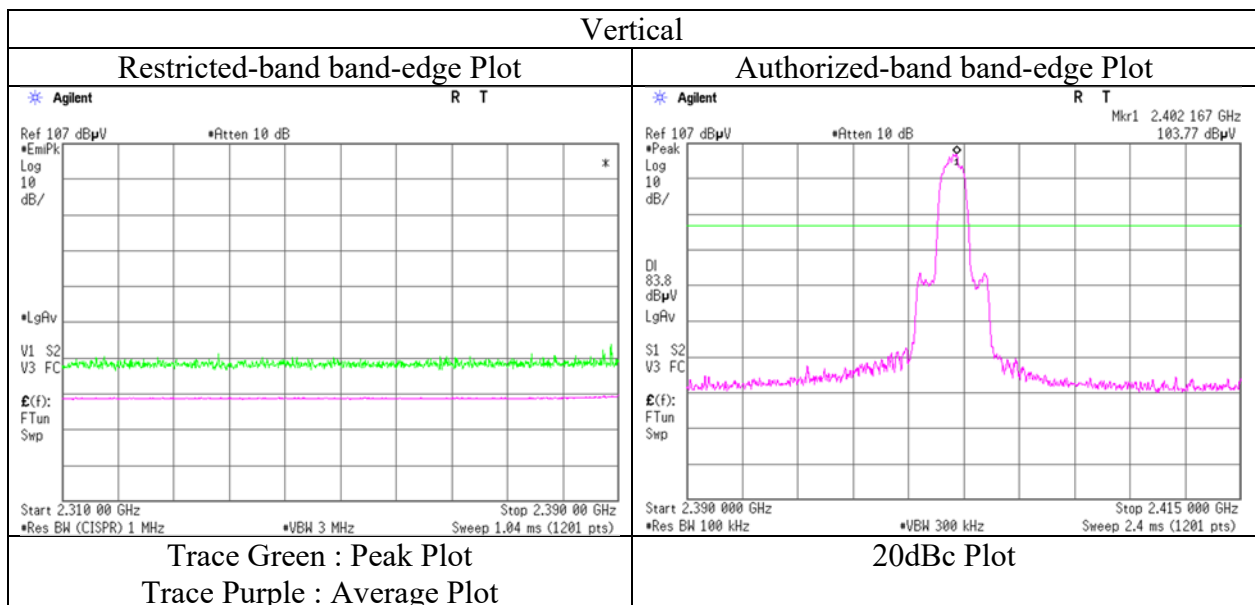
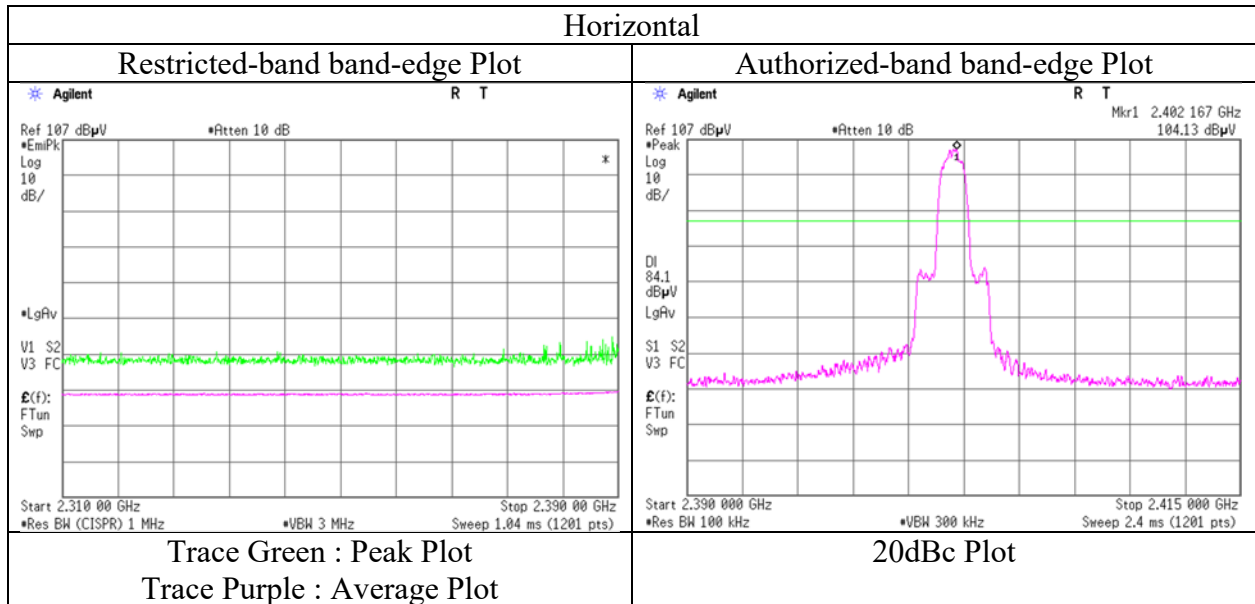

* The measurement was conducted for a sufficiently long enough time to detect any possible spurious emissions.
Final result of restricted band edge was shown in tabular data.

Radiated Spurious Emission

Report No.	13004393S-C-R1		
Test place	Shonan EMC Lab.		
Semi Anechoic Chamber	No.3	No.3	No.3
Date	September 17, 2019	September 18, 2019	September 19, 2019
Temperature / Humidity	23 deg. C / 64 % RH	23 deg. C / 56 % RH	24 deg. C / 58 % RH
Engineer	Takahiro Suzuki	Takahiro Suzuki	Kenichi Adachi
	(30 MHz - 1000 MHz)	(1 GHz - 13 GHz)	(13 GHz - 26.5 GHz)
Mode	Tx, Hopping Off, 3DH5 2441 MHz		

(* PK: Peak, AV: Average, QP: Quasi-Peak)

Polarity	Frequency [MHz]	Detector	Reading [dBuV]	Ant.Fac. [dB/m]	Loss [dB]	Gain [dB]	Distance Factor [dB]	Result [dBuV/m]	Limit [dBuV/m]	Margin [dB]	Height [cm]	Angle [deg]	Remark
Hori.	146.011	QP	36.08	14.51	7.76	32.12	0.00	26.23	43.5	17.2	238	212	-
Hori.	250.598	QP	37.19	11.61	8.42	32.01	0.00	25.21	46.0	20.7	109	108	-
Hori.	713.966	QP	31.39	19.62	10.42	31.84	0.00	29.59	46.0	16.4	118	311	-
Hori.	933.915	QP	28.49	21.62	11.12	30.78	0.00	30.45	46.0	15.5	100	343	-
Hori.	4882.000	PK	49.52	31.71	6.49	42.89	2.15	46.98	73.9	26.9	137	76	-
Hori.	7323.000	PK	47.30	37.39	7.96	43.15	2.15	51.65	73.9	22.2	150	0	-
Hori.	9764.000	PK	46.21	39.34	9.22	43.01	2.15	53.91	73.9	19.9	150	0	-
Hori.	4882.000	AV	39.67	31.71	6.49	42.89	2.15	37.13	53.9	16.7	137	76	VBW: 360 Hz
Hori.	7323.000	AV	35.29	37.39	7.96	43.15	2.15	39.64	53.9	14.2	150	0	VBW: 360 Hz
Hori.	9764.000	AV	35.26	39.34	9.22	43.01	2.15	42.96	53.9	10.9	150	0	VBW: 360 Hz
Vert.	67.481	QP	44.31	6.72	6.65	32.18	0.00	25.50	40.0	14.5	100	194	-
Vert.	107.991	QP	43.09	11.47	7.29	32.15	0.00	29.70	43.5	13.8	100	359	-
Vert.	164.191	QP	36.78	15.24	7.92	32.11	0.00	27.83	43.5	15.6	100	319	-
Vert.	725.997	QP	32.91	19.86	10.46	31.82	0.00	31.41	46.0	14.5	100	189	-
Vert.	4882.000	PK	50.56	31.71	6.49	42.89	2.15	48.02	73.9	25.8	145	14	-
Vert.	7323.000	PK	47.06	37.39	7.96	43.15	2.15	51.41	73.9	22.4	150	0	-
Vert.	9764.000	PK	46.86	39.34	9.22	43.01	2.15	54.56	73.9	19.3	150	0	-
Vert.	4882.000	AV	39.65	31.71	6.49	42.89	2.15	37.11	53.9	16.7	145	14	VBW: 360 Hz
Vert.	7323.000	AV	35.51	37.39	7.96	43.15	2.15	39.86	53.9	14.0	150	0	VBW: 360 Hz
Vert.	9764.000	AV	35.54	39.34	9.22	43.01	2.15	43.24	53.9	10.6	150	0	VBW: 360 Hz

Result = Reading + Ant.Fac. + Loss (Cable+(Attenuator or Filter)(below 18 GHz)) - Gain(Amplifier) + Distance factor

Distance factor : 1 GHz - 13 GHz : 20log(3.84 m / 3.0 m) = 2.15 dB

13 GHz - 40 GHz : 20log(1.0 m / 3.0 m) = -9.54 dB

* These results have sufficient margin without taking account Dwell time factor.

Radiated Spurious Emission

Report No.	13004393S-C-R1		
Test place	Shonan EMC Lab.		
Semi Anechoic Chamber	No.3	No.3	No.3
Date	September 17, 2019	September 18, 2019	September 19, 2019
Temperature / Humidity	23 deg. C / 64 % RH	23 deg. C / 56 % RH	24 deg. C / 58 % RH
Engineer	Takahiro Suzuki	Takahiro Suzuki	Kenichi Adachi
	(30 MHz - 1000 MHz)	(1 GHz - 13 GHz)	(13 GHz - 26.5 GHz)
Mode	Tx, Hopping Off, 3DH5 2480 MHz		

(* PK: Peak, AV: Average, QP: Quasi-Peak)

Polarity	Frequency [MHz]	Detector	Reading [dBuV]	Ant.Fac. [dB/m]	Loss [dB]	Gain [dB]	Distance Factor [dB]	Result [dBuV/m]	Limit [dBuV/m]	Margin [dB]	Height [cm]	Angle [deg]	Remark
Hori.	146.337	QP	37.01	14.52	7.76	32.12	0.00	27.17	43.5	16.3	239	188	-
Hori.	250.372	QP	37.52	11.61	8.42	32.01	0.00	25.54	46.0	20.4	100	116	-
Hori.	713.993	QP	31.44	19.62	10.42	31.84	0.00	29.64	46.0	16.3	123	298	-
Hori.	942.012	QP	28.26	21.56	11.14	30.71	0.00	30.25	46.0	15.7	100	288	-
Hori.	2483.500	PK	54.58	28.24	14.24	41.62	2.15	57.59	73.9	16.3	150	67	-
Hori.	4960.000	PK	48.29	31.96	6.54	42.91	2.15	46.03	73.9	27.8	139	72	-
Hori.	7440.000	PK	47.89	37.56	8.03	43.38	2.15	52.25	73.9	21.6	150	0	-
Hori.	9920.000	PK	45.80	39.18	9.26	42.84	2.15	53.55	73.9	20.3	150	0	-
Hori.	2483.500	AV	35.34	28.24	14.24	41.62	2.15	38.35	53.9	15.5	150	67	VBW: 360 Hz
Hori.	4960.000	AV	37.43	31.96	6.54	42.91	2.15	35.17	53.9	18.7	139	72	VBW: 360 Hz
Hori.	7440.000	AV	35.50	37.56	8.03	43.38	2.15	39.86	53.9	14.0	150	0	VBW: 360 Hz
Hori.	9920.000	AV	34.31	39.18	9.26	42.84	2.15	42.06	53.9	11.8	150	0	VBW: 360 Hz
Vert.	67.173	QP	44.25	6.76	6.62	32.18	0.00	25.45	40.0	14.5	100	166	-
Vert.	107.963	QP	43.05	11.46	7.29	32.15	0.00	29.65	43.5	13.8	100	7	-
Vert.	164.397	QP	35.19	15.26	7.92	32.11	0.00	26.26	43.5	17.2	100	299	-
Vert.	719.942	QP	32.87	19.75	10.44	31.83	0.00	31.23	46.0	14.7	100	108	-
Vert.	2483.500	PK	58.29	28.24	14.24	41.62	2.15	61.30	73.9	12.6	110	106	-
Vert.	4960.000	PK	49.22	31.96	6.54	42.91	2.15	46.96	73.9	26.9	120	13	-
Vert.	7440.000	PK	47.76	37.56	8.03	43.38	2.15	52.12	73.9	21.7	150	0	-
Vert.	9920.000	PK	46.38	39.18	9.26	42.84	2.15	54.13	73.9	19.7	150	0	-
Vert.	2483.500	AV	36.37	28.24	14.24	41.62	2.15	39.38	53.9	14.5	110	106	VBW: 360 Hz
Vert.	4960.000	AV	36.87	31.96	6.54	42.91	2.15	34.61	53.9	19.2	120	13	VBW: 360 Hz
Vert.	7440.000	AV	35.46	37.56	8.03	43.38	2.15	39.82	53.9	14.0	150	0	VBW: 360 Hz
Vert.	9920.000	AV	34.41	39.18	9.26	42.84	2.15	42.16	53.9	11.7	150	0	VBW: 360 Hz

Result = Reading + Ant.Fac. + Loss (Cable+(Attenuator or Filter)(below 18 GHz)) - Gain(Amplifier) + Distance factor

Distance factor : 1 GHz - 13 GHz : $20\log(3.84\text{ m} / 3.0\text{ m}) = 2.15\text{ dB}$

13 GHz - 40 GHz : $20\log(1.0\text{ m} / 3.0\text{ m}) = -9.54\text{ dB}$

* These results have sufficient margin without taking account Dwell time factor.

Radiated Spurious Emission
(Reference Plot for band-edge)

Report No. 13004393S-C-R1
Test place Shonan EMC Lab.
Semi Anechoic Chamber No.3
Date September 18, 2019
Temperature / Humidity 23 deg. C / 56 % RH
Engineer Takahiro Suzuki
(1 GHz - 13 GHz)
Mode Tx, Hopping Off, 3DH5 2480 MHz

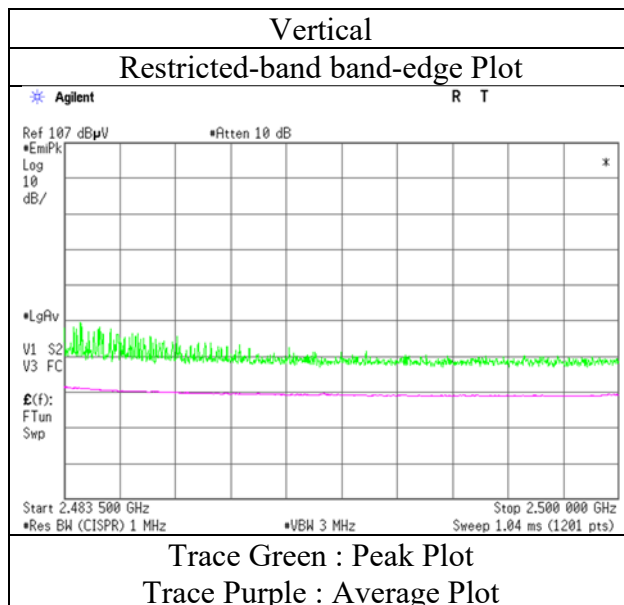
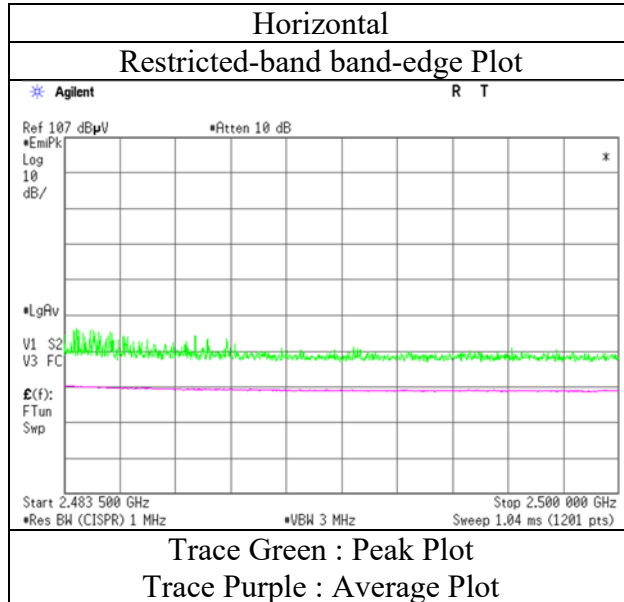

* The measurement was conducted for a sufficiently long enough time to detect any possible spurious emissions.
Final result of restricted band edge was shown in tabular data.

Radiated Spurious Emission
(Plot data, Worst case)

Report No.	13004393S-C-R1		
Test place	Shonan EMC Lab.		
Semi Anechoic Chamber	No.3	No.3	No.3
Date	September 17, 2019	September 18, 2019	September 19, 2019
Temperature / Humidity	23 deg. C / 64 % RH	23 deg. C / 56 % RH	24 deg. C / 58 % RH
Engineer	Takahiro Suzuki (30 MHz - 1000 MHz)	Takahiro Suzuki (1 GHz - 13 GHz)	Kenichi Adachi (13 GHz - 26.5 GHz)
Mode	Tx, Hopping Off, 3DH5 2480 MHz		

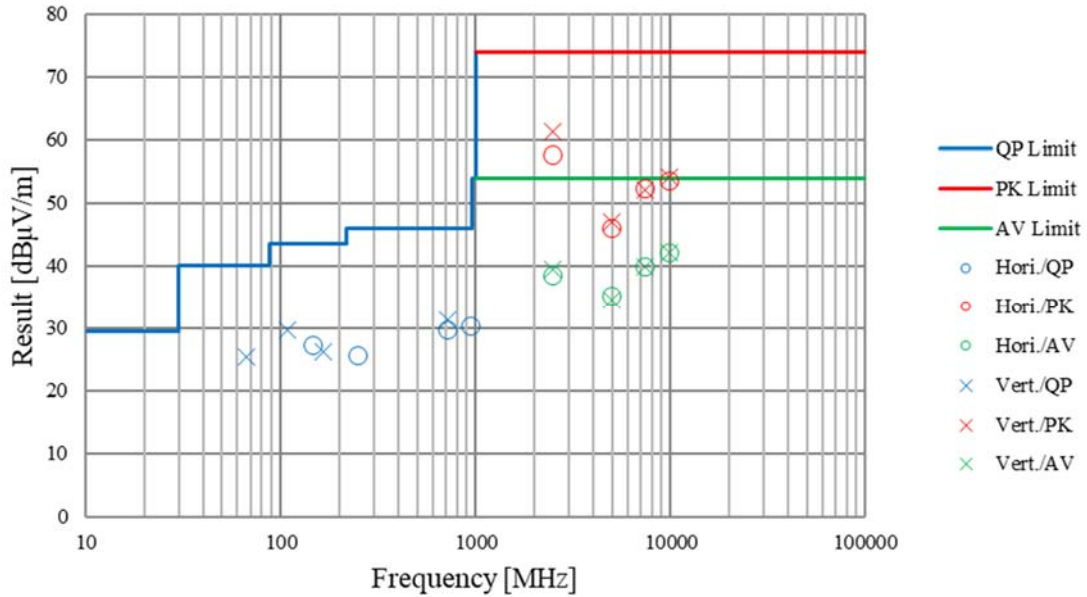

*These plots data contains sufficient number to show the trend of characteristic features for EUT.

Radiated Spurious Emission

Report No. 13004393S-C-R1
Test place Shonan EMC Lab.
Semi Anechoic Chamber No.3
Date September 20, 2019
Temperature / Humidity 24 deg. C / 58 % RH
Engineer Takahiro Suzuki
(1 GHz – 2.8 GHz)
Mode Tx, Hopping Off, DH5 2402 MHz with 11ac-40 Tx 5190 MHz

(* PK: Peak, AV: Average, QP: Quasi-Peak)

Polarity	Frequency [MHz]	Detector	Reading [dBuV]	Ant.Fac. [dB/m]	Loss [dB]	Gain [dB]	Distance Factor [dB]	Result [dBuV/m]	Limit [dBuV/m]	Margin [dB]	Height [cm]	Angle [deg]	Remark
Hori.	2390.000	PK	48.84	28.33	14.16	41.59	2.15	51.89	73.9	22.0	142	85	-
Hori.	2390.000	AV	34.41	28.33	14.16	41.59	2.15	37.46	53.9	16.4	142	85	VBW: 360 Hz
Vert.	2390.000	PK	50.07	28.33	14.16	41.59	2.15	53.12	73.9	20.7	137	100	-
Vert.	2390.000	AV	36.11	28.33	14.16	41.59	2.15	39.16	53.9	14.7	137	100	VBW: 360 Hz

Result = Reading + Ant.Fac. + Loss (Cable+(Attenuator or Filter)(below 18 GHz)) - Gain(Amplifier) + Distance factor

Distance factor : 1 GHz - 13 GHz : 20log(3.84 m / 3.0 m) = 2.15 dB

13 GHz - 40 GHz : 20log(1.0 m / 3.0 m) = -9.54 dB

* These results have sufficient margin without taking account Dwell time factor.

20 dBc Data Sheet (RBW 100 kHz, VBW 300 kHz)

Polarity	Frequency [MHz]	Detector	Reading [dBuV]	Ant.Fac. [dB/m]	Loss [dB]	Gain [dB]	Distance Factor [dB]	Result [dBuV/m]	Limit [dBuV/m]	Margin [dB]	Remark
Hori.	2402.000	PK	102.99	28.31	14.17	41.60	2.15	106.02	-	-	Carrier
Hori.	2400.000	PK	45.26	28.31	14.16	41.60	2.15	48.28	86.02	37.7	-
Vert.	2402.000	PK	102.78	28.31	14.17	41.60	2.15	105.81	-	-	Carrier
Vert.	2400.000	PK	44.58	28.31	14.16	41.60	2.15	47.60	85.81	38.2	-

Result = Reading + Ant.Fac. + Loss (Cable+(Attenuator or Filter)(below 18 GHz)) - Gain(Amplifier) + Distance factor

Distance factor : 1 GHz - 13 GHz : 20log(3.84 m / 3.0 m) = 2.15 dB

13 GHz - 40 GHz : 20log(1.0 m / 3.0 m) = -9.54 dB

Radiated Spurious Emission
(Reference Plot for band-edge)

Report No.	13004393S-C-R1
Test place	Shonan EMC Lab.
Semi Anechoic Chamber	No.3
Date	September 20, 2019
Temperature / Humidity	24 deg. C / 58 % RH
Engineer	Takahiro Suzuki
	(1 GHz – 2.8 GHz)
Mode	Tx, Hopping Off, DH5 2402 MHz with 11ac-40 Tx 5190 MHz

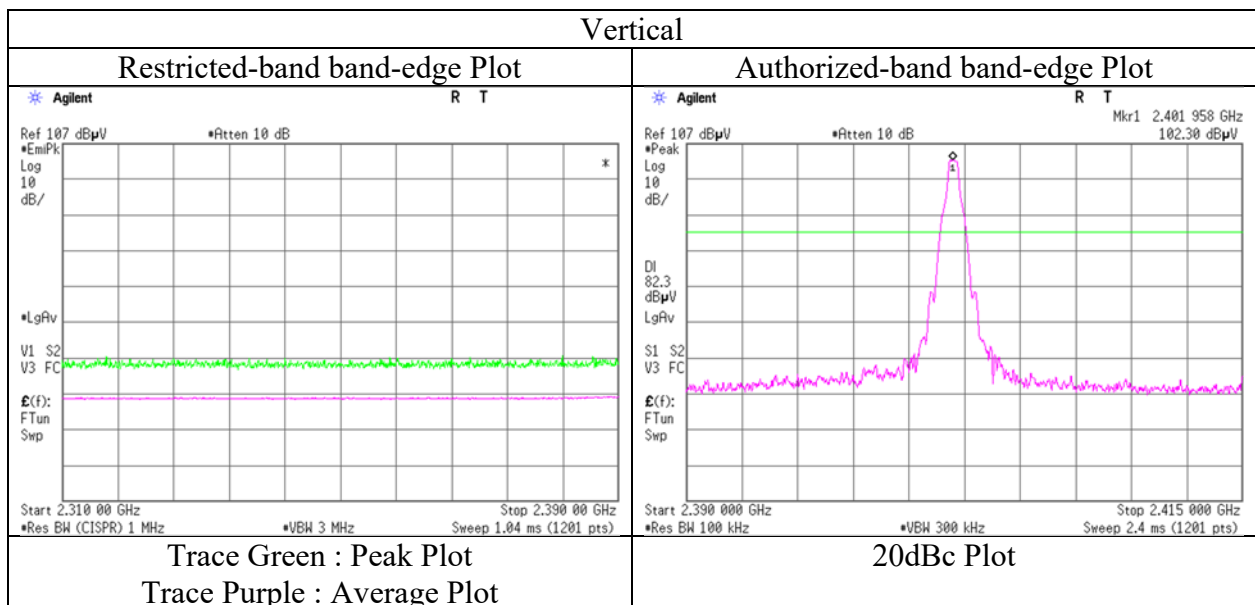
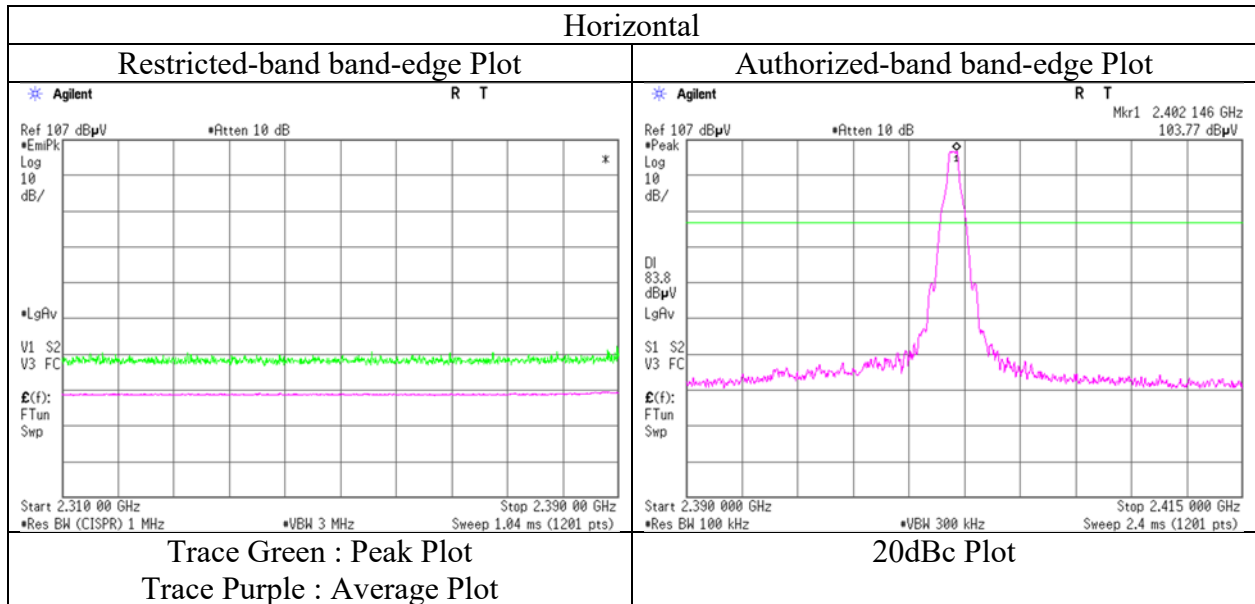

* The measurement was conducted for a sufficiently long enough time to detect any possible spurious emissions.
Final result of restricted band edge was shown in tabular data.

Radiated Spurious Emission

Report No. 13004393S-C-R1
Test place Shonan EMC Lab.
Semi Anechoic Chamber No.3
Date September 20, 2019
Temperature / Humidity 24 deg. C / 58 % RH
Engineer Takahiro Suzuki
(1 GHz – 2.8 GHz)
Mode Tx, Hopping Off, DH5 2480 MHz with 11ac-40 Tx 5190 MHz

(* PK: Peak, AV: Average, QP: Quasi-Peak)

Polarity	Frequency [MHz]	Detector	Reading [dBuV]	Ant.Fac. [dB/m]	Loss [dB]	Gain [dB]	Distance Factor [dB]	Result [dBuV/m]	Limit [dBuV/m]	Margin [dB]	Height [cm]	Angle [deg]	Remark
Hori.	2483.500	PK	59.81	28.24	14.24	41.62	2.15	62.82	73.9	11.0	165	57	-
Hori.	2483.500	AV	39.03	28.24	14.24	41.62	2.15	42.04	53.9	11.8	165	57	VBW: 360 Hz
Vert.	2483.500	PK	58.39	28.24	14.24	41.62	2.15	61.40	73.9	12.5	112	104	-
Vert.	2483.500	AV	38.26	28.24	14.24	41.62	2.15	41.27	53.9	12.6	112	104	VBW: 360 Hz

Result = Reading + Ant.Fac. + Loss (Cable+(Attenuator or Filter)(below 18 GHz)) - Gain(Amplifier) + Distance factor

Distance factor : 1 GHz - 13 GHz : $20\log(3.84\text{ m} / 3.0\text{ m}) = 2.15\text{ dB}$

13 GHz - 40 GHz : $20\log(1.0\text{ m} / 3.0\text{ m}) = -9.54\text{ dB}$

* These results have sufficient margin without taking account Dwell time factor.

Radiated Spurious Emission
(Reference Plot for band-edge)

Report No. 13004393S-C-R1
Test place Shonan EMC Lab.
Semi Anechoic Chamber No.3
Date September 20, 2019
Temperature / Humidity 24 deg. C / 58 % RH
Engineer Takahiro Suzuki
(1 GHz – 2.8 GHz)
Mode Tx, Hopping Off, DH5 2480 MHz with 11ac-40 Tx 5190 MHz

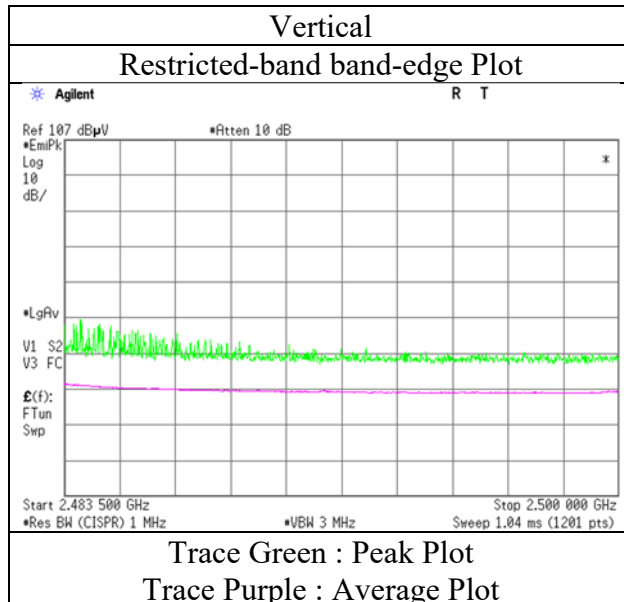
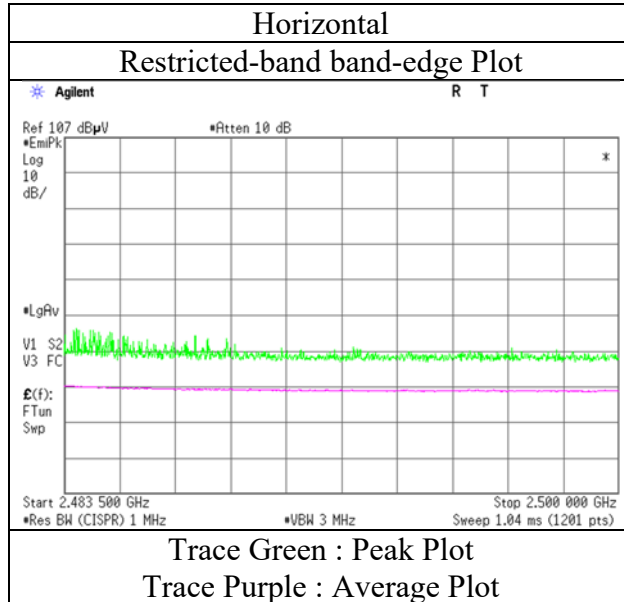

* The measurement was conducted for a sufficiently long enough time to detect any possible spurious emissions.
Final result of restricted band edge was shown in tabular data.

Radiated Spurious Emission

Report No. 13004393S-C-R1
Test place Shonan EMC Lab.
Semi Anechoic Chamber No.3
Date September 20, 2019
Temperature / Humidity 24 deg. C / 58 % RH
Engineer Takahiro Suzuki
(1 GHz – 2.8 GHz)
Mode Tx, Hopping Off, 3DH5 2402 MHz with 11ac-40 Tx 5190 MHz

(* PK: Peak, AV: Average, QP: Quasi-Peak)

Polarity	Frequency [MHz]	Detector	Reading [dBuV]	Ant.Fac. [dB/m]	Loss [dB]	Gain [dB]	Distance Factor [dB]	Result [dBuV/m]	Limit [dBuV/m]	Margin [dB]	Height [cm]	Angle [deg]	Remark
Hori.	2390.000	PK	54.96	28.33	14.16	41.59	2.15	58.01	73.9	15.8	129	66	-
Hori.	2390.000	AV	36.15	28.33	14.16	41.59	2.15	39.20	53.9	14.7	129	66	VBW: 360 Hz
Vert.	2390.000	PK	55.16	28.33	14.16	41.59	2.15	58.21	73.9	15.6	100	102	-
Vert.	2390.000	AV	36.03	28.33	14.16	41.59	2.15	39.08	53.9	14.8	100	102	VBW: 360 Hz

Result = Reading + Ant.Fac. + Loss (Cable+(Attenuator or Filter)(below 18 GHz)) - Gain(Amplifier) + Distance factor

Distance factor : 1 GHz - 13 GHz : 20log(3.84 m / 3.0 m) = 2.15 dB

13 GHz - 40 GHz : 20log(1.0 m / 3.0 m) = -9.54 dB

* These results have sufficient margin without taking account Dwell time factor.

20 dBc Data Sheet (RBW 100 kHz, VBW 300 kHz)

Polarity	Frequency [MHz]	Detector	Reading [dBuV]	Ant.Fac. [dB/m]	Loss [dB]	Gain [dB]	Distance Factor [dB]	Result [dBuV/m]	Limit [dBuV/m]	Margin [dB]	Remark
Hori.	2402.000	PK	102.85	28.31	14.17	41.60	2.15	105.88	-	-	Carrier
Hori.	2400.000	PK	45.83	28.31	14.16	41.60	2.15	48.85	85.88	37.0	-
Vert.	2402.000	PK	102.98	28.31	14.17	41.60	2.15	106.01	-	-	Carrier
Vert.	2400.000	PK	45.53	28.31	14.16	41.60	2.15	48.55	86.01	37.4	-

Result = Reading + Ant.Fac. + Loss (Cable+(Attenuator or Filter)(below 18 GHz)) - Gain(Amplifier) + Distance factor

Distance factor : 1 GHz - 13 GHz : 20log(3.84 m / 3.0 m) = 2.15 dB

13 GHz - 40 GHz : 20log(1.0 m / 3.0 m) = -9.54 dB

Radiated Spurious Emission
(Reference Plot for band-edge)

Report No.	13004393S-C-R1
Test place	Shonan EMC Lab.
Semi Anechoic Chamber	No.3
Date	September 20, 2019
Temperature / Humidity	24 deg. C / 58 % RH
Engineer	Takahiro Suzuki
	(1 GHz – 2.8 GHz)
Mode	Tx, Hopping Off, 3DH5 2402 MHz with 11ac-40 Tx 5190 MHz

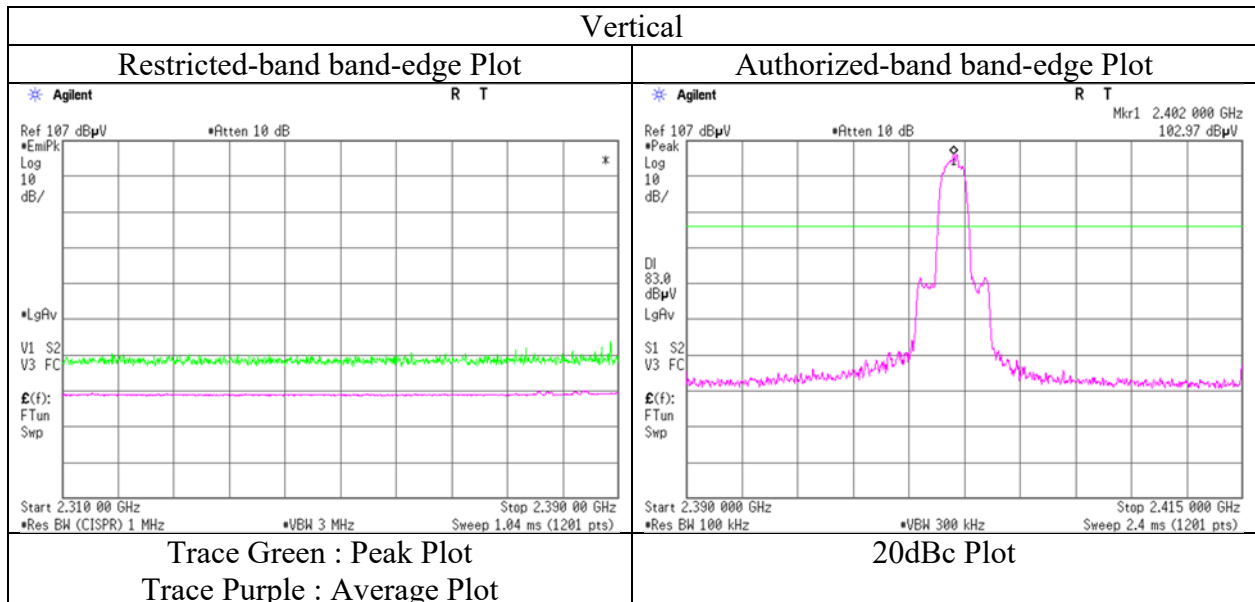
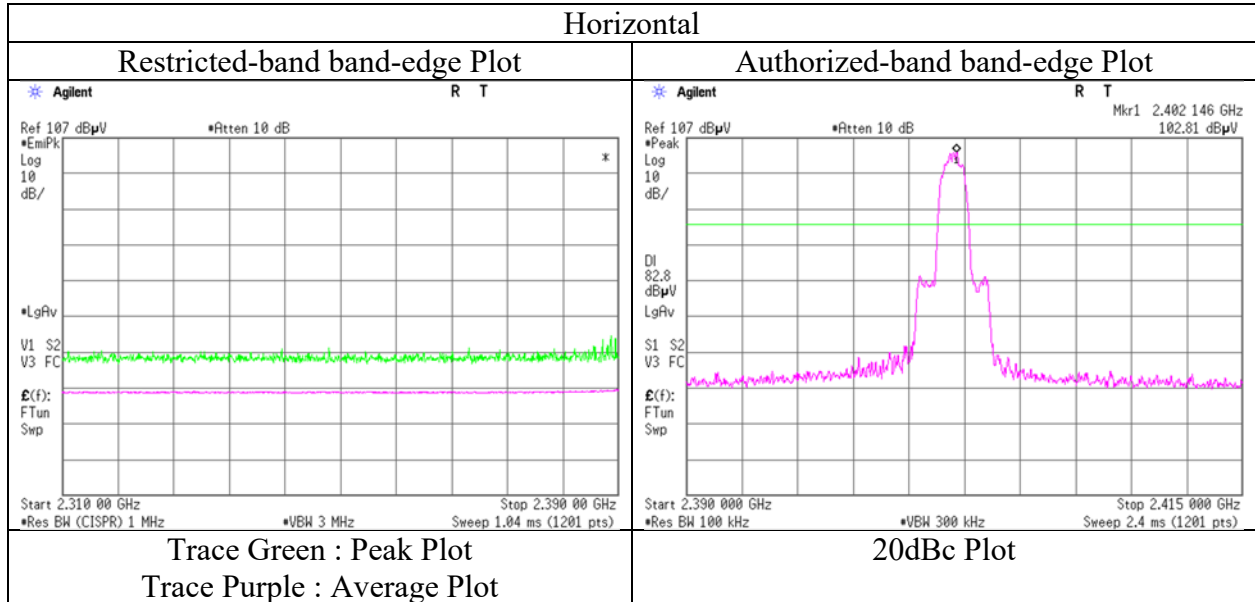

* The measurement was conducted for a sufficiently long enough time to detect any possible spurious emissions.
Final result of restricted band edge was shown in tabular data.

Radiated Spurious Emission

Report No.	13004393S-C-R1		
Test place	Shonan EMC Lab.		
Semi Anechoic Chamber	No.3	No.3	No.3
Date	September 19, 2019	September 20, 2019	September 19, 2019
Temperature / Humidity	23 deg. C / 62 % RH	24 deg. C / 58 % RH	24 deg. C / 58 % RH
Engineer	Takahiro Suzuki	Takahiro Suzuki	Kenichi Adachi
	(30 MHz – 1000 MHz)	(1 GHz – 13 GHz)	(13 GHz - 26.5 GHz)
Mode	Tx, Hopping Off, 3DH5 2480 MHz with 11ac-40 Tx 5190 MHz		

(* PK: Peak, AV: Average, QP: Quasi-Peak)

Polarity	Frequency [MHz]	Detector	Reading [dBuV]	Ant.Fac. [dB/m]	Loss [dB]	Gain [dB]	Distance Factor [dB]	Result [dBuV/m]	Limit [dBuV/m]	Margin [dB]	Height [cm]	Angle [deg]	Remark
Hori.	154.126	QP	36.00	14.82	7.88	32.12	0.00	26.58	43.5	16.9	219	249	-
Hori.	226.970	QP	42.57	11.04	8.26	32.04	0.00	29.83	46.0	16.1	159	178	-
Hori.	239.897	QP	44.52	11.31	8.35	32.02	0.00	32.16	46.0	13.8	100	101	-
Hori.	677.968	QP	37.32	19.29	10.29	31.90	0.00	35.00	46.0	11.0	151	29	-
Hori.	708.006	QP	33.99	19.51	10.40	31.85	0.00	32.05	46.0	13.9	129	19	-
Hori.	929.343	QP	30.18	21.66	11.10	30.83	0.00	32.11	46.0	13.8	100	280	-
Hori.	2483.500	PK	60.89	28.24	14.24	41.62	2.15	63.90	73.9	10.0	164	59	-
Hori.	4960.000	PK	49.03	31.96	6.54	42.91	2.15	46.77	73.9	27.1	135	68	-
Hori.	7440.000	PK	48.13	37.56	8.03	43.38	2.15	52.49	73.9	21.4	150	0	-
Hori.	9920.000	PK	45.91	39.18	9.26	42.84	2.15	53.66	73.9	20.2	150	0	-
Hori.	2483.500	AV	37.86	28.24	14.24	41.62	2.15	40.87	53.9	13.0	164	59	VBW: 360 Hz
Hori.	4960.000	AV	37.98	31.96	6.54	42.91	2.15	35.72	53.9	18.1	135	68	VBW: 360 Hz
Hori.	7440.000	AV	36.02	37.56	8.03	43.38	2.15	40.38	53.9	13.5	150	0	VBW: 360 Hz
Hori.	9920.000	AV	34.97	39.18	9.26	42.84	2.15	42.72	53.9	11.1	150	0	VBW: 360 Hz
Vert.	107.196	QP	44.41	11.32	7.30	32.15	0.00	30.88	43.5	12.6	100	142	-
Vert.	165.461	QP	40.12	15.30	7.93	32.10	0.00	31.25	43.5	12.2	100	352	-
Vert.	713.936	QP	36.28	19.62	10.42	31.84	0.00	34.48	46.0	11.5	100	359	-
Vert.	725.992	QP	36.09	19.86	10.46	31.82	0.00	34.59	46.0	11.4	100	349	-
Vert.	2483.500	PK	58.78	28.24	14.24	41.62	2.15	61.79	73.9	12.1	100	70	-
Vert.	4960.000	PK	48.99	31.96	6.54	42.91	2.15	46.73	73.9	27.1	118	15	-
Vert.	7440.000	PK	48.04	37.56	8.03	43.38	2.15	52.40	73.9	21.5	150	0	-
Vert.	9920.000	PK	46.51	39.18	9.26	42.84	2.15	54.26	73.9	19.6	150	0	-
Vert.	2483.500	AV	37.41	28.24	14.24	41.62	2.15	40.42	53.9	13.4	100	70	VBW: 360 Hz
Vert.	4960.000	AV	38.00	31.96	6.54	42.91	2.15	35.74	53.9	18.1	118	15	VBW: 360 Hz
Vert.	7440.000	AV	35.63	37.56	8.03	43.38	2.15	39.99	53.9	13.9	150	0	VBW: 360 Hz
Vert.	9920.000	AV	34.32	39.18	9.26	42.84	2.15	42.07	53.9	11.8	150	0	VBW: 360 Hz

Result = Reading + Ant.Fac. + Loss (Cable+(Attenuator or Filter)(below 18 GHz)) - Gain(Amplifier) + Distance factor

Distance factor : 1 GHz - 13 GHz : $20\log(3.84\text{ m} / 3.0\text{ m}) = 2.15\text{ dB}$

13 GHz - 40 GHz : $20\log(1.0\text{ m} / 3.0\text{ m}) = -9.54\text{ dB}$

* These results have sufficient margin without taking account Dwell time factor.

Radiated Spurious Emission
(Reference Plot for band-edge)

Report No. 13004393S-C-R1
Test place Shonan EMC Lab.
Semi Anechoic Chamber No.3
Date September 20, 2019
Temperature / Humidity 24 deg. C / 58 % RH
Engineer Takahiro Suzuki
(1 GHz – 13 GHz)
Mode Tx, Hopping Off, 3DH5 2480 MHz with 11ac-40 Tx 5190 MHz

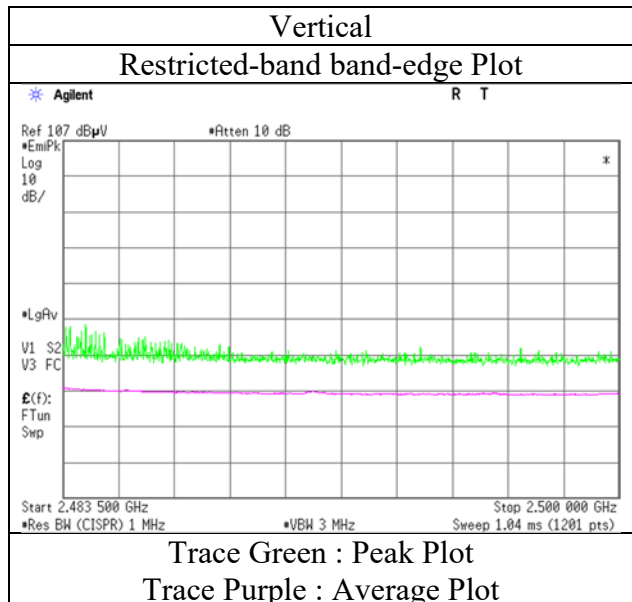
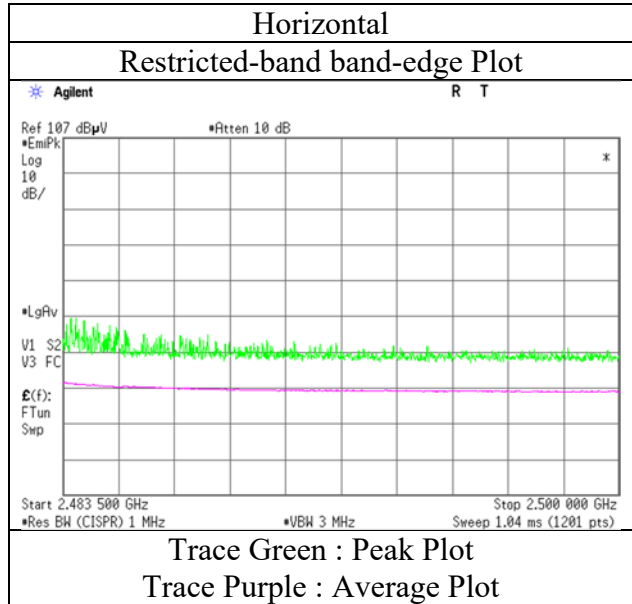

* The measurement was conducted for a sufficiently long enough time to detect any possible spurious emissions.
Final result of restricted band edge was shown in tabular data.

Radiated Spurious Emission
(Plot data, Worst case)

Report No.	13004393S-C-R1		
Test place	Shonan EMC Lab.		
Semi Anechoic Chamber	No.3	No.3	No.3
Date	September 19, 2019	September 20, 2019	September 19, 2019
Temperature / Humidity	23 deg. C / 62 % RH	24 deg. C / 58 % RH	24 deg. C / 58 % RH
Engineer	Takahiro Suzuki	Takahiro Suzuki	Kenichi Adachi
	(30 MHz – 1000 MHz)	(1 GHz – 13 GHz)	(13 GHz - 26.5 GHz)
Mode	Tx, Hopping Off, 3DH5 2480 MHz with 11ac-40 Tx 5190 MHz		

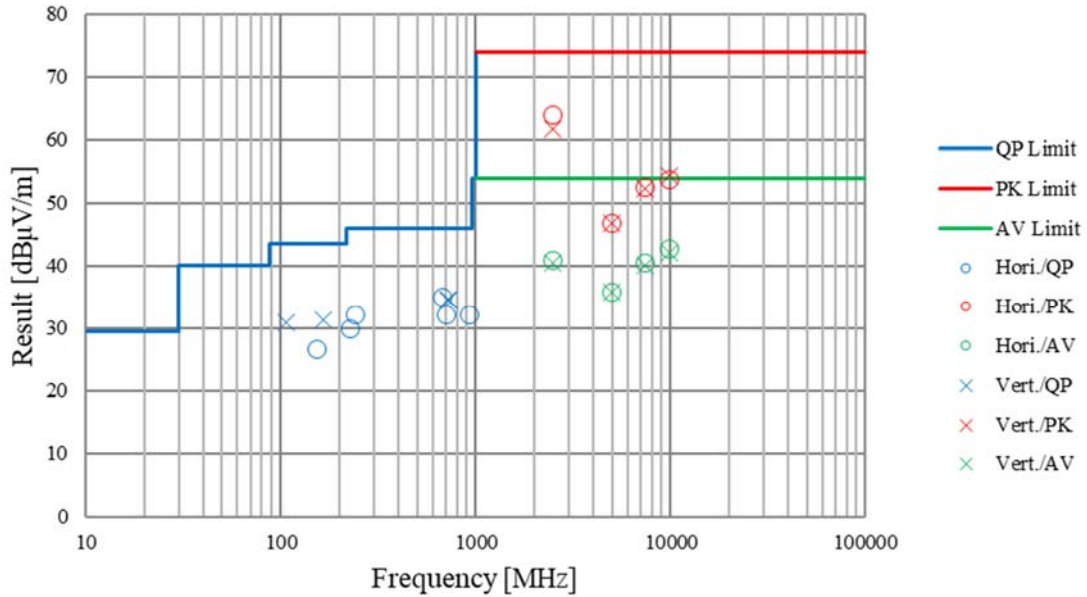

*These plots data contains sufficient number to show the trend of characteristic features for EUT.

Conducted Spurious Emission

Report No.	13004393S-C-R1
Test place	Shonan EMC Lab. No.3 Shielded Room
Date	September 16, 2019
Temperature / Humidity	24 deg. C / 57 % RH
Engineer	Kazuya Noda
Mode	Tx, Hopping Off, DH5

2402 MHz

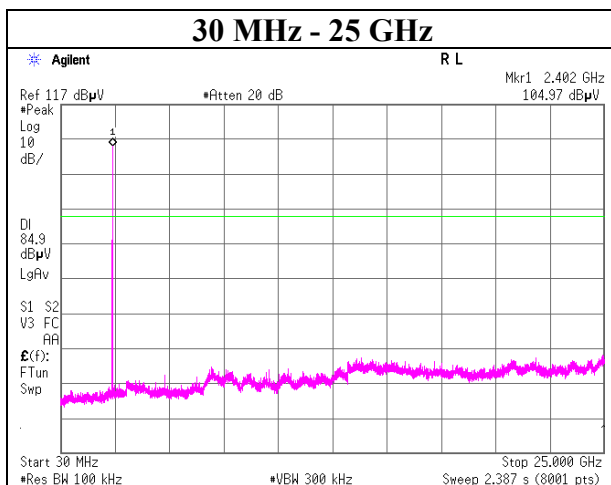
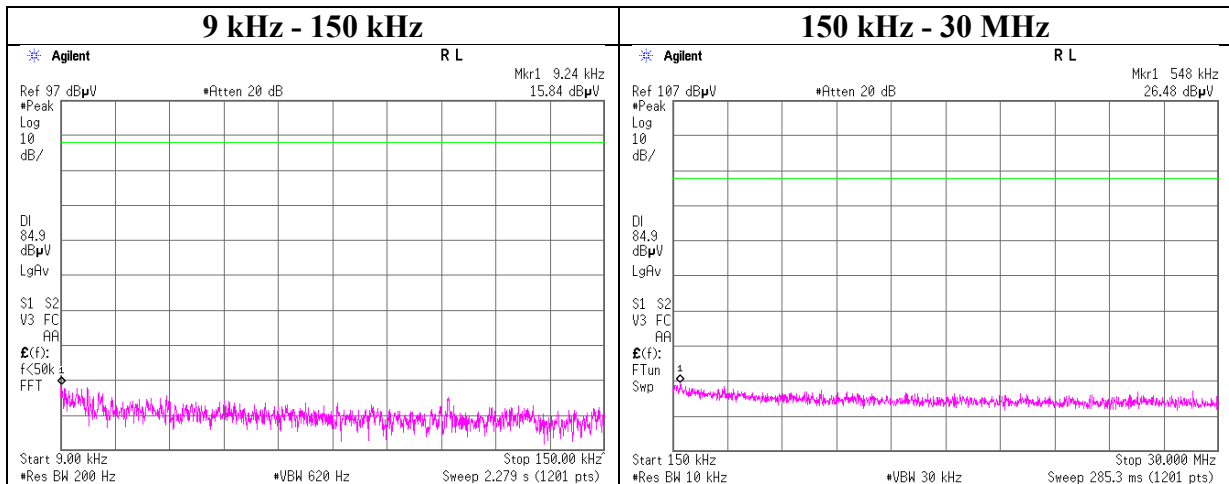

UL Japan, Inc.

Shonan EMC Lab.

1-22-3 Megumigaoka, Hiratsuka-shi, Kanagawa-ken, 259-1220 JAPAN

Telephone : +81 463 50 6400

Facsimile : +81 463 50 6401

Conducted Spurious Emission

Report No.	13004393S-C-R1
Test place	Shonan EMC Lab. No.3 Shielded Room
Date	September 16, 2019
Temperature / Humidity	24 deg. C / 57 % RH
Engineer	Kazuya Noda
Mode	Tx, Hopping Off, DH5

2441 MHz

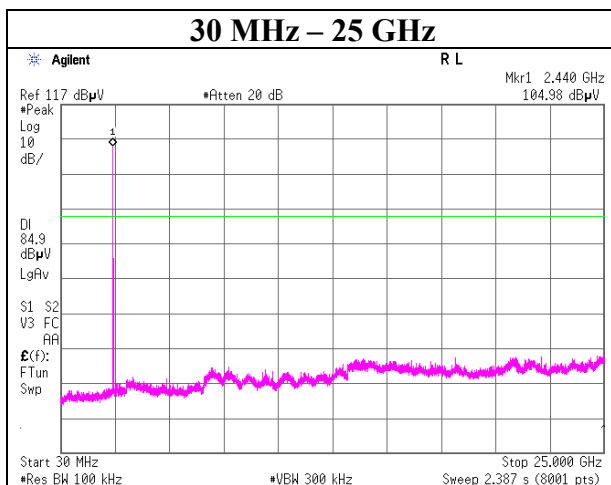
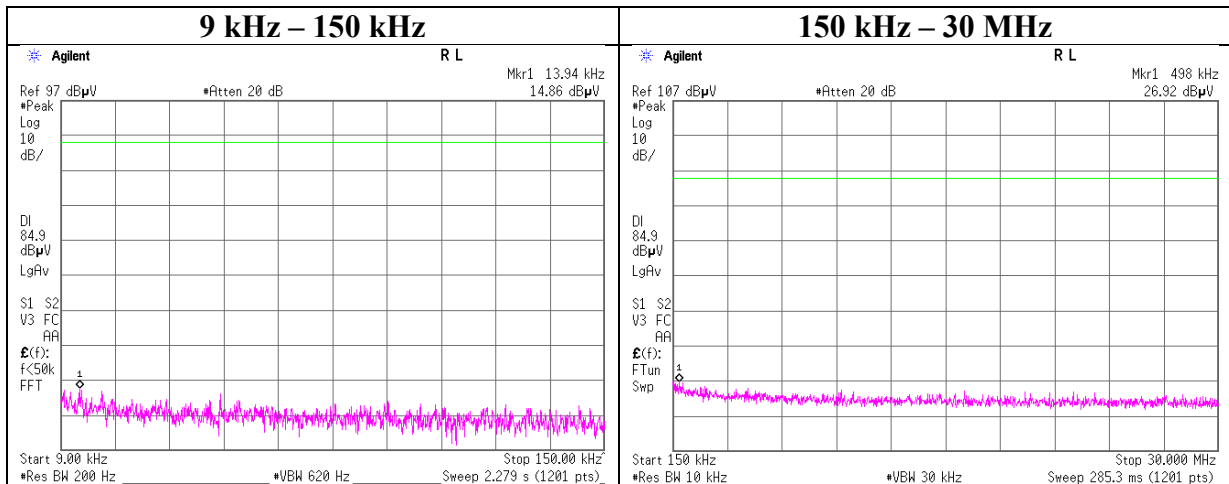

UL Japan, Inc.

Shonan EMC Lab.

1-22-3 Megumigaoka, Hiratsuka-shi, Kanagawa-ken, 259-1220 JAPAN

Telephone : +81 463 50 6400

Facsimile : +81 463 50 6401

Conducted Spurious Emission

Report No.	13004393S-C-R1
Test place	Shonan EMC Lab. No.3 Shielded Room
Date	September 16, 2019
Temperature / Humidity	24 deg. C / 57 % RH
Engineer	Kazuya Noda
Mode	Tx, Hopping Off, DH5

2480 MHz

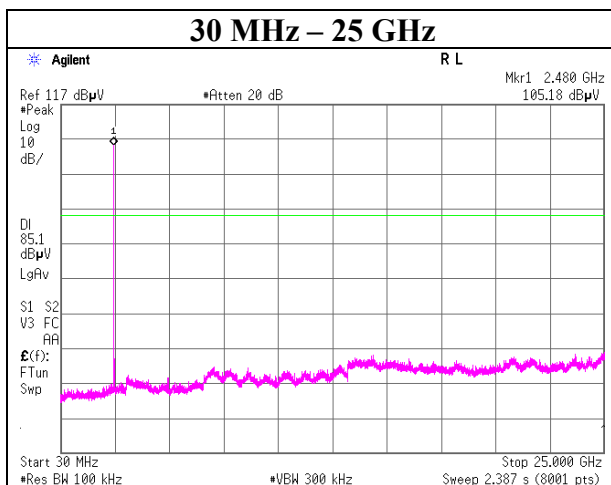
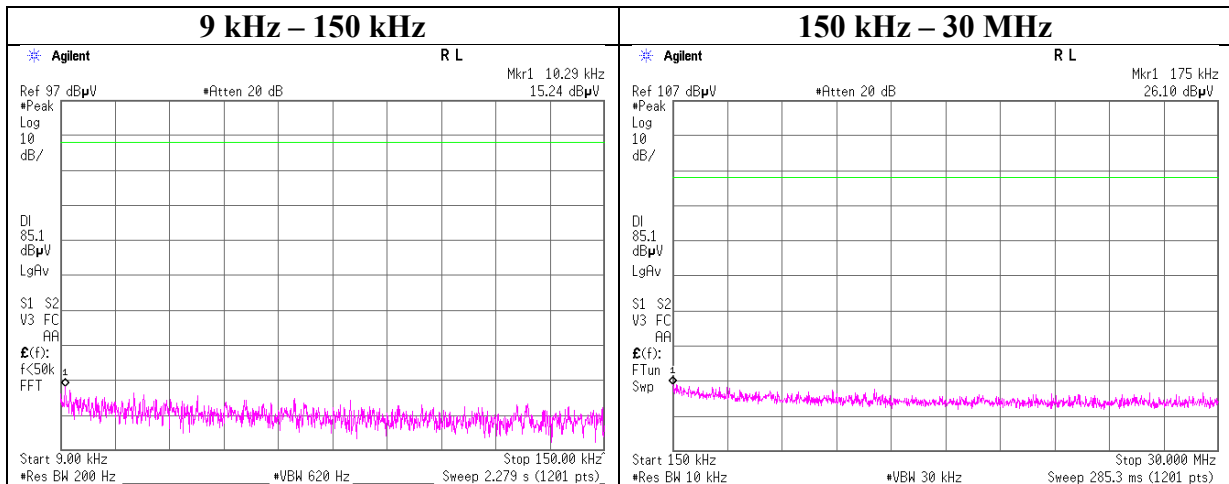

UL Japan, Inc.

Shonan EMC Lab.

1-22-3 Megumigaoka, Hiratsuka-shi, Kanagawa-ken, 259-1220 JAPAN

Telephone : +81 463 50 6400

Facsimile : +81 463 50 6401

Conducted Spurious Emission

Report No.	13004393S-C-R1
Test place	Shonan EMC Lab. No.3 Shielded Room
Date	September 16, 2019
Temperature / Humidity	24 deg. C / 57 % RH
Engineer	Kazuya Noda
Mode	Tx, Hopping Off, 3DH5

2402 MHz

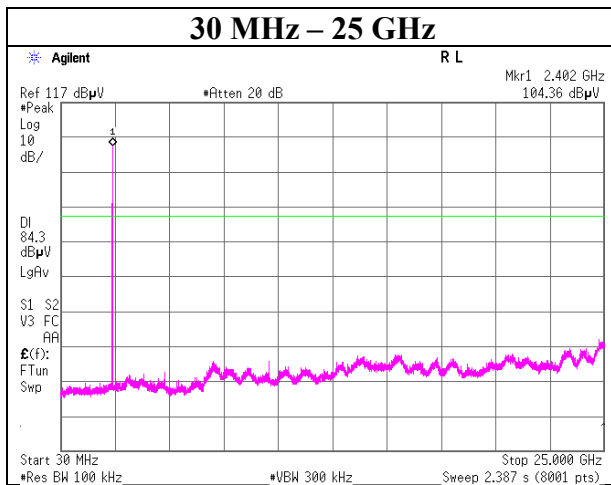
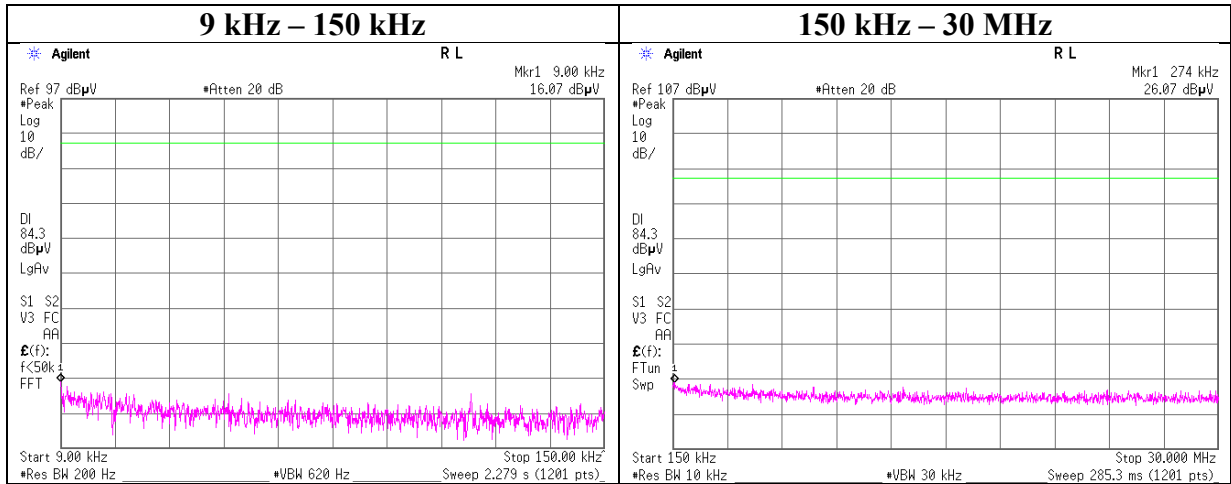

UL Japan, Inc.

Shonan EMC Lab.

1-22-3 Megumigaoka, Hiratsuka-shi, Kanagawa-ken, 259-1220 JAPAN

Telephone : +81 463 50 6400

Facsimile : +81 463 50 6401

Conducted Spurious Emission

Report No.	13004393S-C-R1
Test place	Shonan EMC Lab. No.3 Shielded Room
Date	September 16, 2019
Temperature / Humidity	24 deg. C / 57 % RH
Engineer	Kazuya Noda
Mode	Tx, Hopping Off, 3DH5

2441 MHz

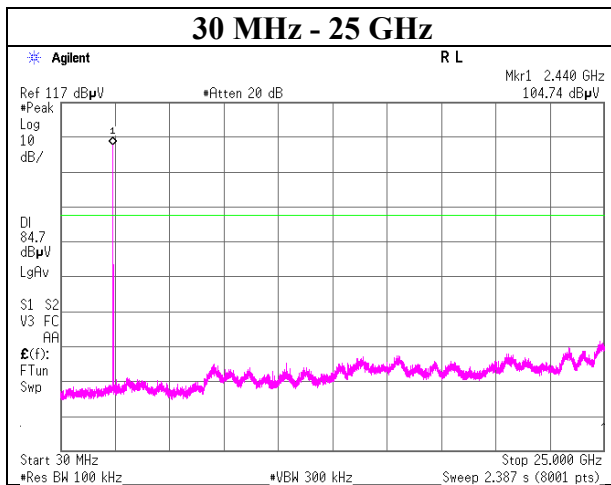
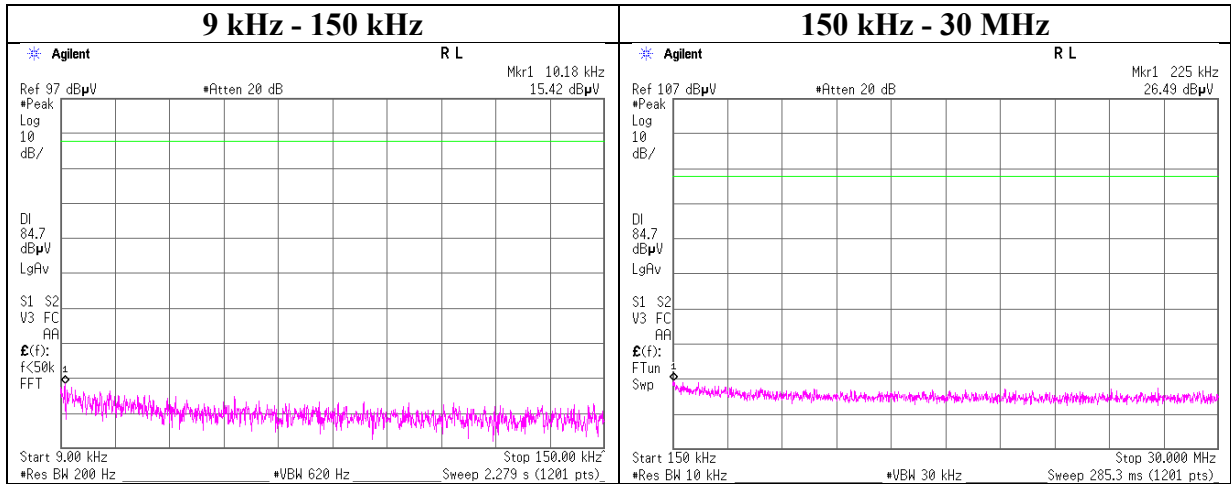

UL Japan, Inc.

Shonan EMC Lab.

1-22-3 Megumigaoka, Hiratsuka-shi, Kanagawa-ken, 259-1220 JAPAN

Telephone : +81 463 50 6400

Facsimile : +81 463 50 6401

Conducted Spurious Emission

Report No.	13004393S-C-R1
Test place	Shonan EMC Lab. No.3 Shielded Room
Date	September 16, 2019
Temperature / Humidity	24 deg. C / 57 % RH
Engineer	Kazuya Noda
Mode	Tx, Hopping Off, 3DH5

2480 MHz

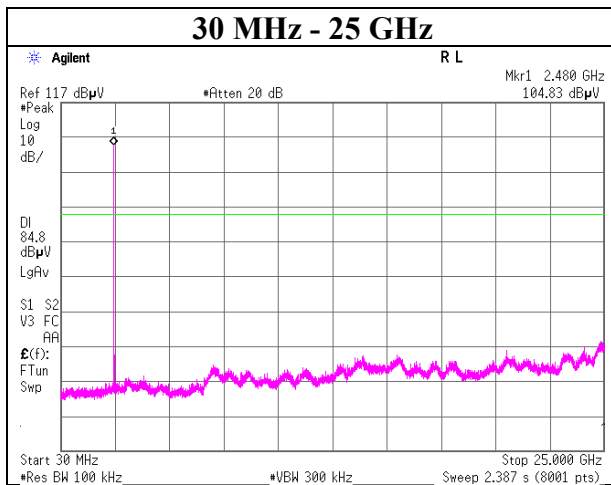
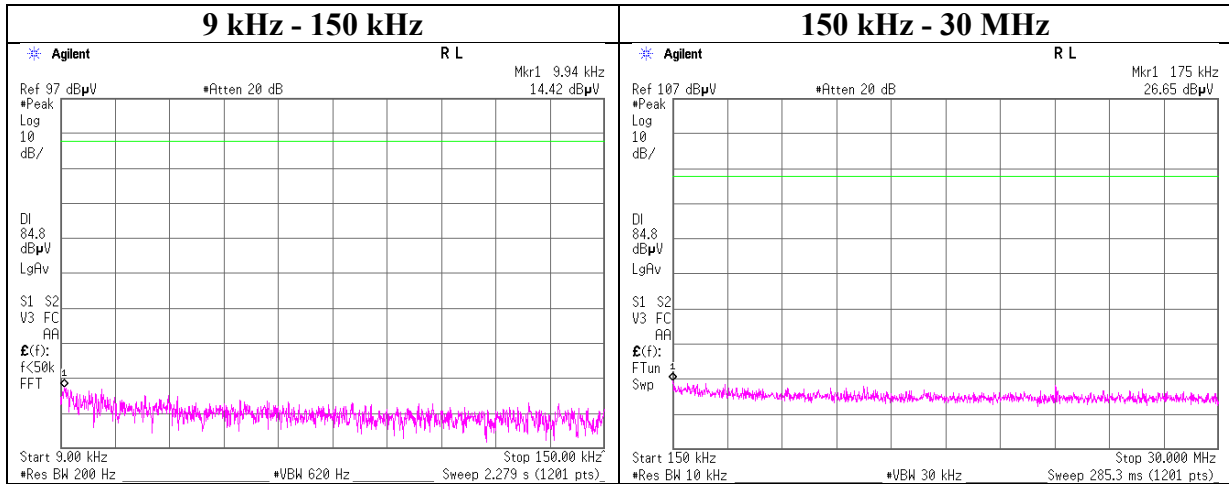

UL Japan, Inc.

Shonan EMC Lab.

1-22-3 Megumigaoka, Hiratsuka-shi, Kanagawa-ken, 259-1220 JAPAN

Telephone : +81 463 50 6400

Facsimile : +81 463 50 6401

Conducted Emission Band Edge compliance

Report No. 13004393S-C-R1
 Test place Shonan EMC Lab. No.3 Shielded Room
 Date September 16, 2019
 Temperature / Humidity 24 deg. C / 57 % RH
 Engineer Kazuya Noda
 Mode Tx DH5

Hopping On

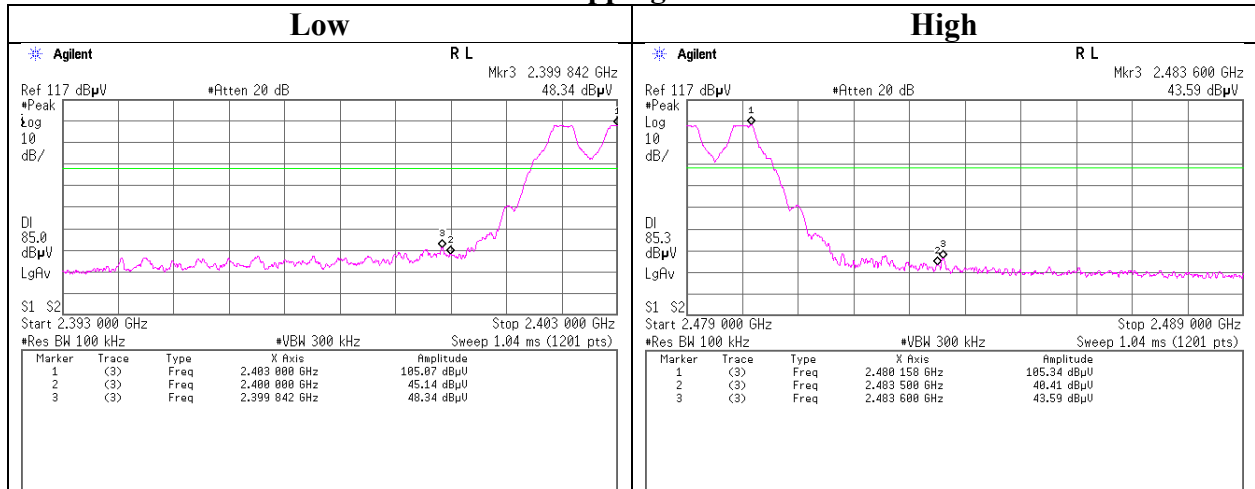

Hopping Off

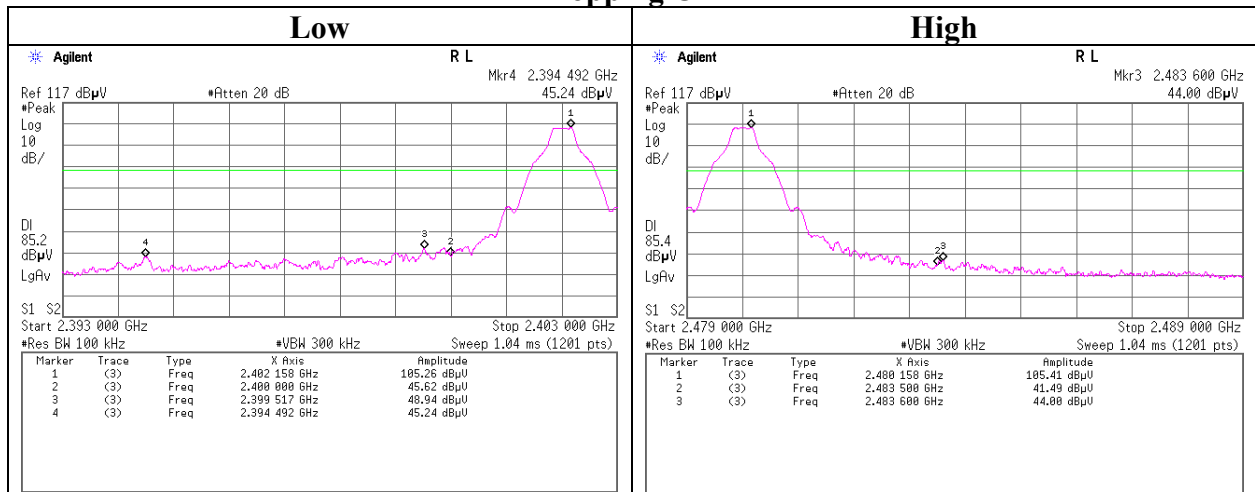

UL Japan, Inc.

Shonan EMC Lab.

1-22-3 Megumigaoka, Hiratsuka-shi, Kanagawa-ken, 259-1220 JAPAN

Telephone : +81 463 50 6400

Facsimile : +81 463 50 6401

Conducted Emission Band Edge compliance

Report No. 13004393S-C-R1
 Test place Shonan EMC Lab. No.3 Shielded Room
 Date September 16, 2019
 Temperature / Humidity 24 deg. C / 57 % RH
 Engineer Kazuya Noda
 Mode Tx 3DH5

Hopping On

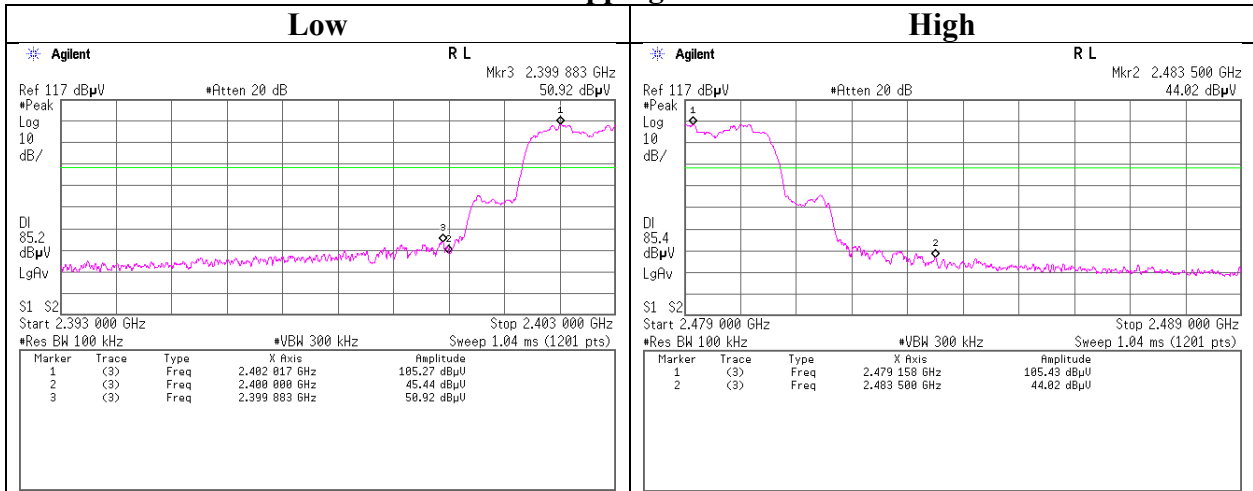

Hopping Off

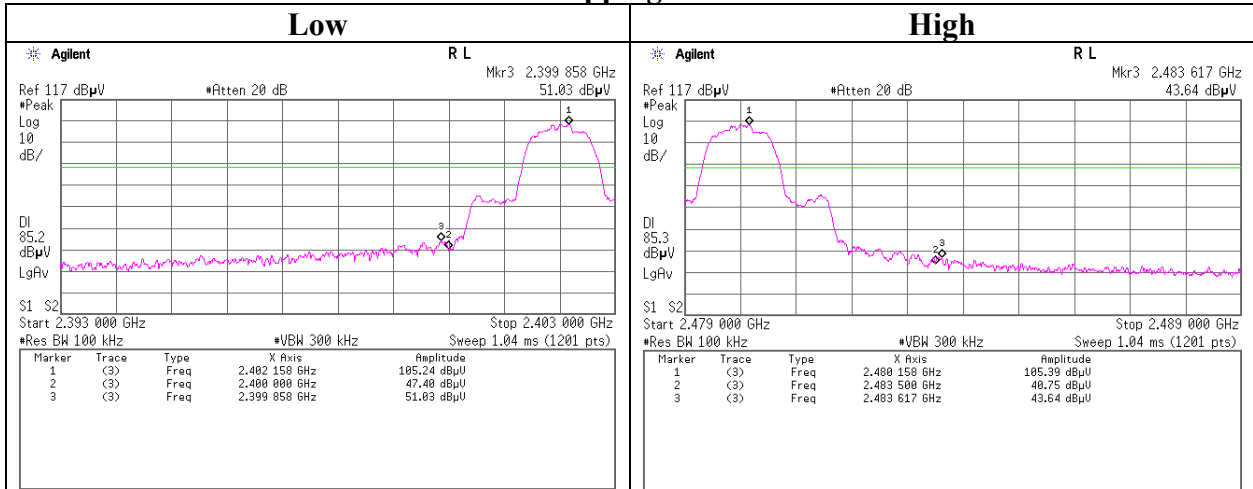

UL Japan, Inc.

Shonan EMC Lab.

1-22-3 Megumigaoka, Hiratsuka-shi, Kanagawa-ken, 259-1220 JAPAN

Telephone : +81 463 50 6400

Facsimile : +81 463 50 6401

APPENDIX 2: Test instruments

Test Instruments [1/2]

Local ID	Test Name	LIMS ID	Description	Manufacturer	Model	Serial	Last Calibration Date	Calibration Due Date	Calibration Interval (Month)
SAT10-12	AT	151609	Attenuator	Weinschel Corp.	54A-10	81601	2019/3/27	2020/3/31	12
SCC-G11	AT	145174	Coaxial Cable	Suhner	SUCOFLEX 102	31595/2	2019/3/27	2020/3/31	12
SCC-H20	AT	159940	Microwave cable	RS Pro	R-132G7210 100CO		2018/11/16	2019/11/30	12
SPM-13	AT	169910	Power Meter	EMC Instruments Corporation	8990B	MY510004 48	2019/3/6	2020/3/31	12
SPSS-06	AT	169911	Power sensor	EMC Instruments Corporation	N1923A	MY572700 04	2019/3/6	2020/3/31	12
STM-G10	AT	171617	Terminator	Weinschel - API Technologies Corp	M1459A	92420	2019/7/4	2020/7/31	12
SOS-06	AT,CE	146294	Humidity Indicator	A&D	AD-5681	4062118	2018/12/5	2019/12/31	12
SSA-02	AT,RE	145800	Spectrum Analyzer	AGILENT	E4448A	MY482501 06	2019/4/4	2020/4/30	12
STS-03	AT,RE, CE	146210	Digital Hitester	HIOKI	3805-50	80997823	2019/10/1	2020/10/31	12
SAT3-10	CE	144960	Attenuator	JFW	50HF-003N	-	2019/8/6	2020/8/31	12
SCC-C6/C7/C8/C10/SRSE-03	CE	145034	Coaxial Cable&RF Selector	Suhner/Fujikura /Suhner/Suhner/ TOYO	141PE/12DSF A/141PE/141 PE/NS4906	-/0901-271(RF Selector)	2019/4/19	2020/4/30	12
SLS-01	CE	145538	LISN	Rohde & Schwarz	ENV216	100511	2019/2/19	2020/2/29	12
SLS-05	CE	145542	LISN	Rohde & Schwarz	ENV216	100516	2019/2/19	2020/2/29	12
STM-05	CE	145762	Terminator	TME	CT-01 BP	-	2018/12/25	2019/12/31	12
COTS-SEMI-5	CE,RE	170932	EMI Software	TSJ	TEPTO-DV3(RE,CE, ME,PE)	-	-	-	-
KJM-02	CE,RE	146432	Measure	TAJIMA	GL19-55	-	-	-	-
STR-08	CE,RE	150463	Test Receiver	Rohde & Schwarz	ESW44	101581	2018/11/28	2019/11/30	12
SAEC-03(NSA)	RE	145565	Semi-Anechoic Chamber	TDK	SAEC-03(NSA)	3	2019/4/8	2020/4/30	12
SAEC-03(SVSWR)	RE	145566	Semi-Anechoic Chamber	TDK	SAEC-03(SVSWR)	3	2019/5/3	2020/5/31	12
SAF-03	RE	145126	Pre Amplifier	SONOMA	310N	290213	2019/2/5	2020/2/29	12
SAF-06	RE	145005	Pre Amplifier	Toyo Corporation	TPA0118-36	1440491	2019/2/8	2020/2/29	12
SAF-08	RE	145007	Pre Amplifier	Toyo Corporation	HAP18-26W	19	2019/3/5	2020/3/31	12
SAJ-03	RE	146105	Antenna Tilt Jig	Intelligent System Engineering Co., Ltd	Antenna Tilt Jig	T-S003	-	-	-
SAT10-05	RE	145136	Attenuator(above1GHz)	AGILENT	8493C-010	74864	2018/11/25	2019/11/30	12
SAT6-13	RE	167094	Attenuator	JFW	50HF-006N	-	2019/2/5	2020/2/29	12
SBA-03	RE	145023	Biconical Antenna	Schwarzbeck	BBA9106	91032666	2019/5/7	2020/5/31	12

UL Japan, Inc.

Shonan EMC Lab.

1-22-3 Megumigaoka, Hiratsuka-shi, Kanagawa-ken, 259-1220 JAPAN

Telephone : +81 463 50 6400

Facsimile : +81 463 50 6401

Test Instruments [2/2]

Local ID	Test Name	LIMS ID	Description	Manufacturer	Model	Serial	Last Calibration Date	Calibration Due Date	Calibration Interval (Month)
SCC-C1/C2/C3/C4/C5/C10/SRSE-03	RE	145171	Coaxial Cable&RF Selector	Fujikura/Fujikura/Suhner/Suhner/TOYO	8D2W/12DSFA/141PE/141PE/141PE/141P	-/0901-271(RF Selector)	2019/4/19	2020/4/30	12
SCC-G40	RE	166491	Coaxial Cable	Junkosha	MWX221-01000NFSN MS/B	1612S005	2019/1/25	2020/1/31	12
SCC-G43	RE	156380	Coaxial Cable	HUBER+SUNER	SUCOFLEX_104 E	SN MY 13406/4E	2019/7/3	2020/7/31	12
SCC-G45	RE	168301	Coaxial Cable	HUBER+SUNER	SUCOFLEX 102 E	800137/2EA	2019/3/26	2020/3/31	12
SCC-G57	RE	179540	Coaxial Cable	Huber+Suhner	SUCOFLEX 102	802815/2	2019/5/16	2020/5/31	12
SCC-G58	RE	183047	Coaxial Cable	HUBER+SUNER	SUCOFLEX 104	800287/4A	2019/7/23	2020/7/31	12
SFL-18	RE	145305	Highpass Filter	MICRO-TRONICS	HPM50111	119	2019/4/16	2020/4/30	12
SHA-03	RE	145501	Horn Antenna	Schwarzbeck	BBHA9120D	9120D-739	2019/6/26	2020/6/30	12
SHA-04	RE	145512	Horn Antenna	ETS LINDGREN	3160-09	00094868	2019/6/26	2020/6/30	12
SLA-07	RE	145529	Logperiodic Antenna	Schwarzbeck	VUSLP9111B	196	2019/5/7	2020/5/31	12
SOS-05	RE	146293	Humidity Indicator	A&D	AD-5681	4062518	2018/10/25	2019/10/31	12
STR-08	RE	150463	Test Receiver	Rohde & Schwarz	ESW44	101581	2018/11/28	2019/11/30	12

*Hyphens for Last Calibration Date, Calibration Due Date and Cal Int (month) are instruments that Calibration is not required (e.g. software), or instruments checked in advance before use.

The expiration date of the calibration is the end of the expired month.

All equipment is calibrated with valid calibrations. Each measurement data is traceable to the national or international standards.

As for some calibrations performed after the tested dates, those test equipment have been controlled by means of an unbroken chains of calibrations.

Test item: CE: Conducted Emission test
RE: Radiated Emission test
AT: Antenna Terminal Conducted test

UL Japan, Inc.

Shonan EMC Lab.

1-22-3 Megumigaoka, Hiratsuka-shi, Kanagawa-ken, 259-1220 JAPAN

Telephone : +81 463 50 6400

Facsimile : +81 463 50 6401