



RADIO TEST REPORT

Test Report No. : 12862749H-A-R1

Applicant : Murata Manufacturing Co., Ltd.
Type of Equipment : Gateway
Model No. : LBAC0ZZ1SU
FCC ID : VPYLB1SU
Test regulation : FCC Part 15 Subpart C: 2019
Test Result : Complied (Refer to SECTION 3.2)

1. This test report shall not be reproduced in full or partial, without the written approval of UL Japan, Inc.
2. The results in this report apply only to the sample tested.
3. This sample tested is in compliance with the above regulation.
4. The test results in this report are traceable to the national or international standards.
5. This test report covers Radio technical requirements. It does not cover administrative issues such as Manual or non-Radio test related Requirements. (if applicable)
6. The all test items in this test report are conducted by UL Japan, Inc. Ise EMC Lab.
7. This test report must not be used by the customer to claim product certification, approval, or endorsement by NVLAP, NIST, or any agency of the Federal Government.
8. The information provided from the customer for this report is identified in SECTION 1.
9. This report is a revised version of 12862749H-A. 12862749H-A is replaced with this report.

Date of test: December 13 , 2017 to January 15 , 2018

Representative test engineer:

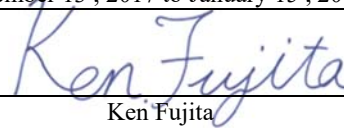
 Ken Fujita
 Engineer
 Consumer Technology Division

Approved by:

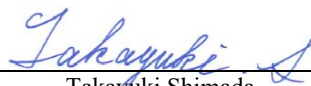
 Takayuki Shimada
 Leader
 Consumer Technology Division



This laboratory is accredited by the NVLAP LAB CODE 200572-0, U.S.A. The tests reported herein have been performed in accordance with its terms of accreditation. *As for the range of Accreditation in NVLAP, you may refer to the WEB address, http://japan.ul.com/resources/emc_accredited/

- The testing in which "Non-accreditation" is displayed is outside the accreditation scopes in UL Japan.
 There is no testing item of "Non-accreditation".

CONTENTS	PAGE
SECTION 1: Customer information.....	4
SECTION 2: Equipment under test (E.U.T.).....	4
SECTION 3: Test specification, procedures & results.....	6
SECTION 4: Operation of E.U.T. during testing.....	9
SECTION 5: Conducted Emission.....	13
SECTION 6: Radiated Spurious Emission	14
SECTION 7: Antenna Terminal Conducted Tests.....	17
APPENDIX 1: Test data	18
Conducted Emission	18
6dB Bandwidth and 99 % Occupied Bandwidth.....	19
Maximum Peak Output Power.....	24
Average Output Power.....	27
Radiated Spurious Emission	30
Conducted Spurious Emission	41
Power Density	42
APPENDIX 2: Test instruments	45
APPENDIX 3: Photographs of test setup	46
Conducted Emission	46
Radiated Spurious Emission	47
Worst Case Position	48

SECTION 1: Customer information

Company Name : Murata Manufacturing Co., Ltd.
Address : 1-10-1 Higashikotari, Nagaokakyo-shi, Kyoto 617-8555 Japan
Telephone Number : +81-75-955-6736
Facsimile Number : +81-75-955-6634
Contact Person : Motoo Hayashi

The information provided from the customer is as follows;

- Applicant, Type of Equipment, Model No., FCC ID on the cover and other relevant pages
 - Operating/Test Mode(s) (Mode(s)) on all the relevant pages
 - SECTION 1: Customer information
 - SECTION 2: Equipment under test (E.U.T.)
 - SECTION 4: Operation of E.U.T. during testing
- * The laboratory is exempted from liability of any test results affected from the above information in SECTION 2 and 4.

SECTION 2: Equipment under test (E.U.T.)

2.1 Identification of E.U.T.

Type of Equipment : Gateway
Model No. : LBAC0ZZ1SU
Serial No. : Refer to Section 4, Clause 4.2
Rating : VBAT: Min 4.75 V / Typ. 5.0 V / Max. 5.25 V
AC Adapter: 100 V - 240 V
Receipt Date of Sample : December 13, 2017
(Information from test lab.)
Country of Mass-production : China, Japan
Condition of EUT : Production prototype
(Not for Sale: This sample is equivalent to mass-produced items.)
Modification of EUT : No Modification by the test lab

2.2 Product Description

Model: LBAC0ZZ1SU (referred to as the EUT in this report) is a Gateway.

Radio Specification

Sub GHz

Radio Type : Transceiver
Frequency of Operation : 902.5 MHz to 927.5 MHz
Modulation : GFSK
Antenna type : Whip Antenna
Antenna Gain : ANT1: 1.8 dBi (Antenna gain: 2.0 dBi , RF cable loss(100 mm): 0.2 dB)
ANT2: 1.7 dBi (Antenna gain: 2.0 dBi , RF cable loss(150 mm): 0.3 dB)
Clock frequency (Maximum) : 24 MHz

WLAN *1)

Radio Type : Transceiver
Frequency of Operation : 2412 MHz - 2462 MHz
Modulation : DSSS, OFDM
Bandwidth & Channel spacing : 20 MHz & 5 MHz
Antenna type : Inverse F Antenna
Antenna Gain : 0 dBi
Clock frequency (Maximum) : 26 MHz

*1) This test report applies to WLAN (2.4 GHz).

SECTION 3: Test specification, procedures & results

Test Specification : FCC Part 15 Subpart C
FCC Part 15 final revised on July 19, 2019 and effective August 19, 2019 except 15.258

Title : FCC 47CFR Part15 Radio Frequency Device Subpart C Intentional Radiators
Section 15.207 Conducted limits
Section 15.247 Operation within the bands 902-928MHz,
2400-2483.5MHz, and 5725-5850MHz

* The revisions made after testing date do not affect the test specification applied to the EUT.
* Also the EUT complies with FCC Part 15 Subpart B.

3.2 Procedures and results

Item	Test Procedure	Specification	Worst margin	Results	Remarks
Conducted Emission	FCC: ANSI C63.10-2013 6. Standard test methods IC: RSS-Gen 8.8	FCC: Section 15.207 IC: RSS-Gen 8.8	QP 13.4 dB, 0.30400 MHz, N AV 17.1 dB, 0.30227 MHz, L	Complied a)	-
6dB Bandwidth	FCC: KDB 558074 D01 DTS Meas Guidance v04 IC: -	FCC: Section 15.247(a)(2) IC: RSS-247 5.2(a)	See data.	Complied b)	Conducted
Maximum Peak Output Power	FCC: KDB 558074 D01 DTS Meas Guidance v04 IC: RSS-Gen 6.12	FCC: Section 15.247(b)(3) IC: RSS-247 5.4(d)		Complied c)	Conducted
Power Density	FCC: KDB 558074 D01 DTS Meas Guidance v04 IC: -	FCC: Section 15.247(e) IC: RSS-247 5.2(b)		Complied d)	Conducted
Spurious Emission Restricted Band Edges	FCC: KDB 558074 D01 DTS Meas Guidance v04 IC: RSS-Gen 6.13	FCC: Section15.247(d) IC: RSS-247 5.5 RSS-Gen 8.9 RSS-Gen 8.10		0.6 dB 4874.000 MHz, AV, Hori/ 4924.000 MHz, AV, Vert .	Complied# e), f)

Note: UL Japan, Inc.'s EMI Work Procedures No. 13-EM-W0420 and 13-EM-W0422.
*1) Radiated test was selected over 30 MHz based on section 15.247(d) and KDB 558074 D01 DTS Meas Guidance v04 12.2.7.
The EUT was evaluated by KDB 558074 D01 DTS Meas Guidance v04 12.2.7.
There is no difference with the latest version (KDB 558074 D01 15.247 Meas Guidance v05r02 8.5 and 8.6.) regarding to test procedure.
Therefore this device complies with KDB 558074 D01 15.247 Meas Guidance v05r02 8.5 and 8.6

- a) Refer to APPENDIX 1 (data of Conducted Emission)
- b) Refer to APPENDIX 1 (data of 6 dB Bandwidth and 99 % Occupied Bandwidth)
- c) Refer to APPENDIX 1 (data of Maximum Peak Output Power)
- d) Refer to APPENDIX 1 (data of Power Density)
- e) Refer to APPENDIX 1 (data of Conducted Spurious Emission)
- f) Refer to APPENDIX 1 (data of Radiated Spurious Emission)

Symbols:
Complied The data of this test item has enough margin, more than the measurement uncertainty.
Complied# The data of this test item meets the limits unless the measurement uncertainty is taken into consideration.

* In case any questions arise about test procedure, ANSI C63.10: 2013 is also referred.

FCC Part 15.31 (e)

This EUT provides stable voltage constantly to RF Module regardless of input voltage. Therefore, this EUT complies with the requirement.

FCC Part 15.203 Antenna requirement

The antenna is not removable from the EUT. Therefore, the equipment complies with the antenna requirement of Section 15.203.

UL Japan, Inc.

Ise EMC Lab.

4383-326 Asama-cho, Ise-shi, Mie-ken 516-0021 JAPAN
Telephone : +81 596 24 8999
Facsimile : +81 596 24 8124

3.3 Addition to standard

Item	Test Procedure	Specification	Worst margin	Results	Remarks
99% Occupied Bandwidth	IC: RSS-Gen 6.6	IC: -	N/A	- a)	Conducted
a) Refer to APPENDIX 1 (data of 6 dB Bandwidth and 99 % Occupied Bandwidth)					

Other than above, no addition, exclusion nor deviation has been made from the standard.

3.4 Uncertainty

EMI

The following uncertainties have been calculated to provide a confidence level of 95 % using a coverage factor $k=2$.

Ise EMC Lab.

Antenna Terminal test

Test Item	Uncertainty (+/-)
RF output power	1.3 dB
Antenna terminal conducted emission / Power density / Adjacent channel power / Channel power	2.7 dB
Below 3GHz	1.9 dB
3 GHz ot 6 GHz	2.1 dB

Conducted emission

using Item	Frequency range	Uncertainty (+/-)
AMN (LISN)	0.009 MHz to 0.15 MHz	3.8 dB
	0.15 MHz to 30 MHz	3.4 dB

Radiated emission

Measurement distance	Frequency range	Uncertainty (+/-)
3 m	9 kHz to 30 MHz	3.3 dB
10 m		3.2 dB
3 m	30 MHz to 200 MHz (Horizontal) (Vertical)	4.8 dB
		5.0 dB
	200 MHz to 1000 MHz (Horizontal) (Vertical)	5.2 dB
		6.3 dB
10 m	30 MHz to 200 MHz (Horizontal) (Vertical)	4.8 dB
		4.9 dB
	200 MHz to 1000 MHz (Horizontal) (Vertical)	5.0 dB
		5.0 dB
3 m	1 GHz to 6 GHz	5.0 dB
	6 GHz to 18 GHz	5.3 dB
1 m	10 GHz to 26.5 GHz	5.8 dB
	26.5 GHz to 40 GHz	5.8 dB
10 m	1 GHz to 18 GHz	5.2 dB

UL Japan, Inc.

Ise EMC Lab.

4383-326 Asama-cho, Ise-shi, Mie-ken 516-0021 JAPAN

Telephone : +81 596 24 8999

Facsimile : +81 596 24 8124

3.5 Test Location

UL Japan, Inc. Ise EMC Lab.

*NVLAP Lab. code: 200572-0 / FCC Test Firm Registration Number: 199967 / ISED Lab Company Number: 2973C

4383-326 Asama-cho, Ise-shi, Mie-ken 516-0021 JAPAN

Telephone: +81 596 24 8999, Facsimile: +81 596 24 8124

Test site	Width x Depth x Height (m)	Size of reference ground plane (m) / horizontal conducting plane	Other rooms	Maximum measurement distance
No.1 semi-anechoic chamber	19.2 x 11.2 x 7.7	7.0 x 6.0	No.1 Power source room	10 m
No.2 semi-anechoic chamber	7.5 x 5.8 x 5.2	4.0 x 4.0	-	3 m
No.3 semi-anechoic chamber	12.0 x 8.5 x 5.9	6.8 x 5.75	No.3 Preparation room	3 m
No.3 shielded room	4.0 x 6.0 x 2.7	N/A	-	-
No.4 semi-anechoic chamber	12.0 x 8.5 x 5.9	6.8 x 5.75	No.4 Preparation room	3 m
No.4 shielded room	4.0 x 6.0 x 2.7	N/A	-	-
No.5 semi-anechoic chamber	6.0 x 6.0 x 3.9	6.0 x 6.0	-	-
No.5 measurement room	6.4 x 6.4 x 3.0	6.4 x 6.4	-	-
No.6 shielded room	4.0 x 4.5 x 2.7	4.0 x 4.5	-	-
No.6 measurement room	4.75 x 5.4 x 3.0	4.75 x 4.15	-	-
No.7 shielded room	4.7 x 7.5 x 2.7	4.7 x 7.5	-	-
No.8 measurement room	3.1 x 5.0 x 2.7	3.1 x 5.0	-	-
No.9 measurement room	8.8 x 4.6 x 2.8	2.4 x 2.4	-	-
No.11 measurement room	6.2 x 4.7 x 3.0	4.8 x 4.6	-	-

* Size of vertical conducting plane (for Conducted Emission test) : 2.0 x 2.0 m for No.1, No.2, No.3, and No.4 semi-anechoic chambers and No.3 and No.4 shielded rooms.

3.6 Test data, Test instruments, and Test set up

Refer to APPENDIX.

SECTION 4: Operation of E.U.T. during testing

4.1 Operating Mode(s)

Test operating mode was determined as follows according to “Section 1 of 6 802.11 a/b/g/n testing - Managing Complex Regulatory Approvals - ” of TCB Council Workshop October 2009.

Mode	Remarks*
IEEE 802.11b (11b)	5.5 Mbps, PN9
IEEE 802.11g (11g)	54 Mbps, PN9
IEEE 802.11n 20 MHz BW (11n-20)	MCS 6, PN9
*The worst condition was determined based on the test result of Maximum Peak Output Power (Mid Channel)	
*Power of the EUT was set by the software as follows; Power settings: 11b: 8 dBm 11g: 9 dBm 11n: 9 dBm Software: Real Time Tuning Tool Version 2.0.0.55 *This setting of software is the worst case. Any conditions under the normal use do not exceed the condition of setting. In addition, end users cannot change the settings of the output power of the product.	

*The details of Operating mode(s) for WLAN

Test Item	Operating Mode	Tested frequency
Conducted Emission, Radiated Spurious Emission (Below 1GHz) Conducted Spurious Emission	Tx 11n-20 *1)	2462 MHz
Radiated Spurious Emission (Above 1GHz)	Tx 11b Tx 11n-20 *2)	2412 MHz 2437 MHz 2462 MHz
6dB Bandwidth, Maximum Peak Output Power, Power Density, 99% Occupied Bandwidth	Tx 11b Tx 11g Tx 11n-20	2412 MHz 2437 MHz 2462 MHz
*1) The mode was tested as a representative, because it had the highest power at antenna terminal test. *2) Since 11g and 11n-20 have the same modulation method and no differences in transmitting specification, test was performed on the representative mode that had the highest peak output power.		

4.2 Configuration and peripherals

[Other than Antenna Terminal Conducted test]

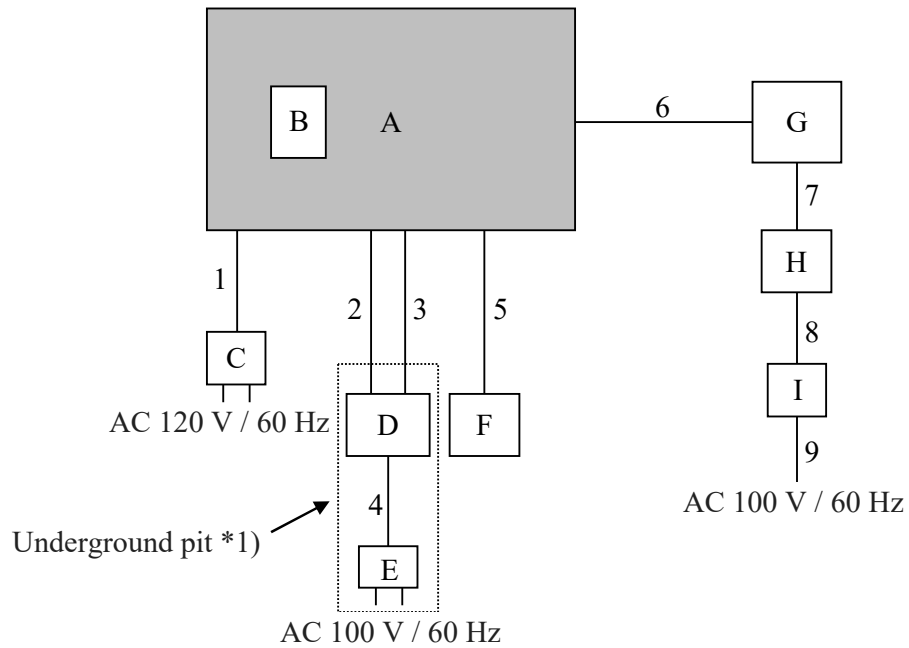

* Cabling and setup(s) were taken into consideration and test data was taken under worse case conditions.

*1) Radiated Emission test only

Description of EUT and Support equipment

No.	Item	Model number	Serial number	Manufacturer	Remarks
A	Gateway	LBAC0ZZ1SU	R1	Murata Manufacturing Co., Ltd.	EUT
B	Micro SD Card	MF-DMRO64GUL	-	ELECOM	-
C	AC Adapter	MU05-J053100-A1	1I1728500837	LEADER ELECTRONICS INC	-
D	Access point	LAN-WH450NGPE	37L354400243	Logitech	-
E	AC Adapter	LA-15W12S	-	Logitech	-
F	USB Memory	PD-07WH4GB	-	KINGMAX	-
G	Jig Board	-	-	Murata Manufacturing Co., Ltd.	-
H	Laptop PC	CF-N8HWCPPS	OBKSA08729	Panasonic	-
I	AC Adapter	CF-AA6372B	6372BM610909023E	Panasonic	-

List of cables used

No.	Name	Length (m)	Shield		Remarks
			Cable	Connector	
1	DC Cable	1.5	Unshielded	Unshielded	-
2	LAN Cable	3.0	Unshielded	Unshielded	-
3	LAN Cable	3.0	Unshielded	Unshielded	-
4	DC Cable	1.5	Unshielded	Unshielded	-
5	USB Cable	3.0	Shielded	Shielded	-
6	Signal Cable	0.2	Unshielded	Unshielded	-
7	USB Cable	1.0	Shielded	Shielded	-
8	DC Cable	1.1	Unshielded	Unshielded	-
9	AC Cable	0.9	Unshielded	Unshielded	-

[For Antenna Terminal Conducted test]

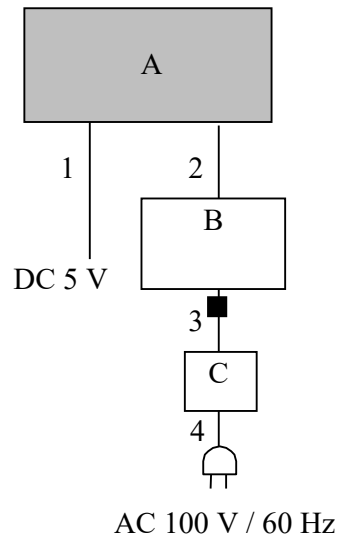

■ : Standard Ferrite Core

* Cabling and setup(s) were taken into consideration and test data was taken under worse case conditions.

Description of EUT and Support equipment

No.	Item	Model number	Serial number	Manufacturer	Remarks
A	Gateway	LBAC0ZZ1SU	C1	Murata Manufacturing Co., Ltd.	
B	Laptop PC	CF-N8HWC DPS	OBKSA08725	Panasonic	-
C	AC Adapter	CF-AA6372B	6372BM610701051E	Panasonic	-

List of cables used

No.	Name	Length (m)	Shield		Remarks
			Cable	Connector	
1	DC Cable	1.2	Unshielded	Unshielded	-
2	USB Cable	5.0	Shielded	Shielded	-
3	DC Cable	1.0	Unshielded	Unshielded	-
4	AC Cable	0.9	Unshielded	Unshielded	-

SECTION 5: Conducted Emission

Test Procedure and conditions

EUT was placed on a urethane platform of nominal size, 1.0 m by 1.5 m, raised 0.8 m above the conducting ground plane.

The rear of tabletop was located 40 cm to the vertical conducting plane. The rear of EUT, including peripherals aligned and flushed with rear of tabletop. All other surfaces of tabletop were at least 80cm from any other grounded conducting surface. EUT was located 80 cm from a Line Impedance Stabilization Network (LISN) / Artificial mains Network (AMN) and excess AC cable was bundled in center.

For the tests on EUT with other peripherals (as a whole system)

I/O cables that were connected to the peripherals were bundled in center. They were folded back and forth forming a bundle 30 cm to 40 cm long and were hanged at a 40 cm height to the ground plane. All unused 50ohm connectors of the LISN (AMN) were resistivity terminated in 50 ohm when not connected to the measuring equipment.

The AC Mains Terminal Continuous disturbance Voltage has been measured with the EUT in a Semi Anechoic Chamber.

The EUT was connected to a LISN (AMN).

An overview sweep with peak detection has been performed.

The test results and limit are rounded off to one decimal place, so some differences might be observed.

Detector : QP and CISPR AV
Measurement range : 0.15 MHz - 30 MHz
Test data : APPENDIX
Test result : Pass

Figure 1: Test Setup

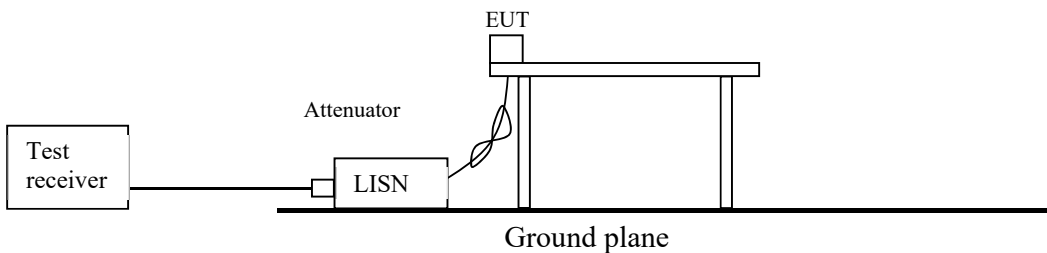

SECTION 6: Radiated Spurious Emission

Test Procedure

It was measured based on "11.0 Emissions in non-restricted frequency bands" of "KDB 558074 D01 DTS Meas Guidance v04".

[For below 1 GHz]

EUT was placed on a urethane platform of nominal size, 1.0 m by 1.5 m, raised 0.8 m above the conducting ground plane. The Radiated Electric Field Strength has been measured in a Semi Anechoic Chamber with a ground plane.

[For above 1 GHz]

EUT was placed on a urethane platform of nominal size, 0.5 m by 0.5 m, raised 1.5 m above the conducting ground plane.

The Radiated Electric Field Strength has been measured in a Semi Anechoic Chamber with absorbent materials lined on a ground plane.

The height of the measuring antenna varied between 1 and 4 m and EUT was rotated a full revolution in order to obtain the maximum value of the electric field strength.

The measurements were performed for both vertical and horizontal antenna polarization with the Test Receiver, or the Spectrum Analyzer.

The measurements were made with the following detector function of the test receiver and the Spectrum analyzer (in linear mode).

The test was made with the detector (RBW/VBW) in the following table.

When using Spectrum analyzer, the test was made with adjusting span to zero by using peak hold.

Test Antennas are used as below;

Frequency	30 MHz to 200 MHz	200 MHz to 1 GHz	Above 1 GHz
Antenna Type	Biconical	Logperiodic	Horn

In any 100 kHz bandwidth outside the restricted band in which the spread spectrum intentional radiator is operating, the radio frequency power that is produced by the intentional radiator confirmed 20 dB below that in the 100 kHz bandwidth within the band that contains the highest level of the desired power, based on a radiated measurement.

20 dBc was applied to the frequency over the limit of FCC 15.209 / Table 4 of RSS-Gen 8.9(IC) and outside the restricted band of FCC15.205 / Table 6 of RSS-Gen 8.10 (IC).

Frequency	Below 1 GHz	Above 1 GHz		20 dBc
Instrument used	Test Receiver	Spectrum Analyzer		Spectrum Analyzer
Detector	QP	PK	AV *1)	PK
IF Bandwidth	BW 120 kHz	RBW: 1 MHz VBW: 3 MHz	Average Power Method: RBW: 1 MHz VBW: 3 MHz Detector: Power Averaging (RMS) Trace: 100 traces If duty cycle was less than 98%, a duty factor was added to the results.	RBW: 100 kHz VBW: 300kHz

*1) Average Power Measurement was performed based on 6.0 & 12.2.5 of "KDB 558074 D01 DTS Meas Guidance v04".

Figure 2: Test Setup

Below 1 GHz

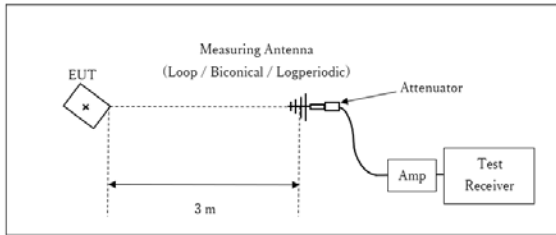

× : Center of turn table

Test Distance: 3 m

1 GHz - 10 GHz

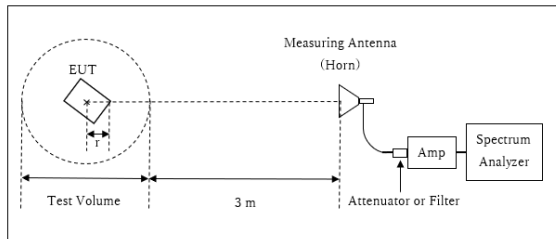

r : Radius of an outer periphery of EUT
 × : Center of turn table

Distance Factor: $20 \times \log(3.75 \text{ m} / 3.0 \text{ m}) = 1.94 \text{ dB}$
 * Test Distance: $(3 + \text{Test Volume} / 2) - r = 3.75 \text{ m}$

Test Volume : 1.5 m
 (Test Volume has been calibrated based on CISPR 16-1-4.)
 r = 0.0m

* The test was performed with r = 0.0 m since EUT is small and it was the rather conservative condition.

10 GHz - 26.5 GHz

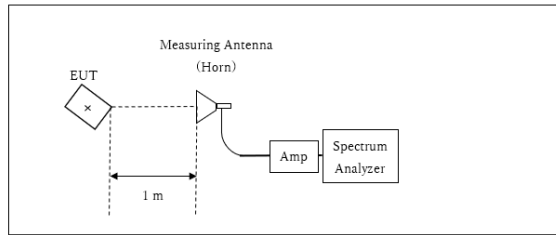

× : Center of turn table

Distance Factor: $20 \times \log(1.0 \text{ m} / 3.0 \text{ m}) = -9.5 \text{ dB}$
 *Test Distance: 1 m

- The carrier level and noise levels were confirmed at each position of X, Y and Z axes of EUT to see the position of maximum noise, and the test was made at the position that has the maximum noise.

The test results and limit are rounded off to one decimal place, so some differences might be observed.

Measurement range : 30 MHz - 26.5 GHz
Test data : APPENDIX
Test result : Pass

SECTION 7: Antenna Terminal Conducted Tests

Test Procedure

The tests were made with below setting connected to the antenna port.

Test	Span	RBW	VBW	Sweep time	Detector	Trace	Instrument used
6dB Bandwidth	20 MHz	100 kHz	300 kHz	Auto	Peak	Max Hold	Spectrum Analyzer
99% Occupied Bandwidth *1)	Enough width to display emission skirts	1 to 5 % of OBW	Three times of RBW	Auto	Peak	Max Hold	Spectrum Analyzer
Maximum Peak Output Power	-	-	-	Auto	Peak/Average *2)	-	Power Meter (Sensor: 50 MHz BW)
Peak Power Density	1.5 times the 6dB Bandwidth	3 kHz	10 kHz	Auto	Peak	Max Hold	Spectrum Analyzer *3)
Conducted Spurious Emission *4)	9kHz to 150kHz	200 Hz	620 Hz	Auto	Peak	Max Hold	Spectrum Analyzer
	150kHz to 30MHz	9.1 kHz	27 kHz				
*1) Peak hold was applied as Worst-case measurement. *2) Reference data *3) Section 10.2 Method PKPSD (peak PSD) of "KDB 558074 D01 DTS Meas Guidance v04". *4) In the frequency range below 30MHz, RBW was narrowed to separate the noise contents. Then, wide-band noise near the limit was checked separately, however the noise was low enough as shown in the chart.							

The test results and limit are rounded off to two decimals place, so some differences might be observed.

Test data : APPENDIX
Test result : Pass

APPENDIX 1: Test data

Conducted Emission

Test place : Ise EMC Lab. No.2 Semi Anechoic Chamber
Report No. : 12862749H
Date : January 12, 2018
Temperature / Humidity : 21 deg. C / 33 % RH
Engineer : Masafumi Niwa
Mode : Tx 11n-20 2462 MHz

LIMIT : FCC15. 207 QP
FCC15. 207 AV

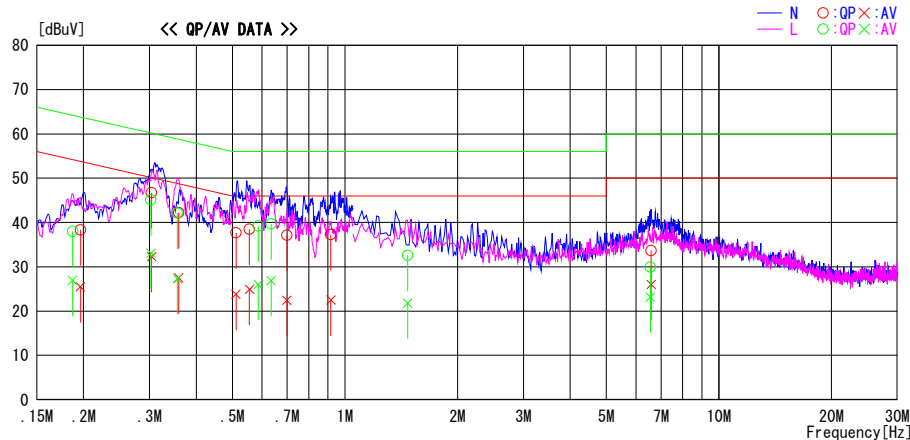

Frequency [MHz]	Reading Level		Corr. Factor	Results		Limit		Margin		Phase	Comment
	QP [dBuV]	AV [dBuV]		QP [dBuV]	AV [dBuV]	QP [dBuV]	AV [dBuV]	QP [dB]	AV [dB]		
0.19625	25.0	12.2	13.3	38.3	25.5	63.8	53.8	25.5	28.3	N	
0.30400	33.4	19.0	13.3	46.7	32.3	60.1	50.1	13.4	17.8	N	
0.35917	28.9	14.2	13.3	42.2	27.5	58.7	48.7	16.5	21.2	N	
0.51130	24.3	10.4	13.4	37.7	23.8	56.0	46.0	18.3	22.2	N	
0.55500	25.1	11.5	13.4	38.5	24.9	56.0	46.0	17.5	21.1	N	
0.69957	23.7	9.0	13.4	37.1	22.4	56.0	46.0	18.9	23.6	N	
0.91612	23.9	9.1	13.4	37.3	22.5	56.0	46.0	18.7	23.5	N	
6.58896	19.1	11.5	14.5	33.6	26.0	60.0	50.0	26.4	24.0	N	
0.18686	24.7	13.7	13.3	38.0	27.0	64.2	54.2	26.2	27.2	L	
0.30277	31.8	19.8	13.3	45.1	33.1	60.2	50.2	15.1	17.1	L	
0.35648	28.8	14.0	13.3	42.1	27.3	58.8	48.8	16.7	21.5	L	
0.58597	25.8	12.6	13.4	39.2	26.0	56.0	46.0	16.8	20.0	L	
0.63488	26.3	13.5	13.4	39.7	26.9	56.0	46.0	16.3	19.1	L	
1.47120	19.0	8.2	13.6	32.6	21.8	56.0	46.0	23.4	24.2	L	
6.55572	15.4	8.7	14.5	29.9	23.2	60.0	50.0	30.1	26.8	L	

CHART: WITH FACTOR Peak hold data. CALCULATION : RESULT = READING + C.F (LISN + CABLE + ATT)
Except for the above table: adequate margin data below the limits.

6dB Bandwidth and 99 % Occupied Bandwidth

Test place Ise EMC Lab. No.11 Measurement Room
Report No. 12862749H
Date December 13, 2017
Temperature / Humidity 22 deg. C / 30 % RH
Engineer Ken Fujita
Mode Tx

Mode	Frequency [MHz]	99% Occupied Bandwidth [kHz]	6dB Bandwidth [MHz]	Limit for 6dB Bandwidth [MHz]
11b	2412	14702.90	10.043	> 0.5000
	2437	14703.00	10.272	> 0.5000
	2462	14747.90	10.195	> 0.5000
11g	2412	17128.00	15.447	> 0.5000
	2437	17016.30	15.111	> 0.5000
	2462	17023.80	15.315	> 0.5000
11n-20	2412	18212.50	15.129	> 0.5000
	2437	18067.00	15.066	> 0.5000
	2462	18056.70	15.411	> 0.5000

6dB Bandwidth

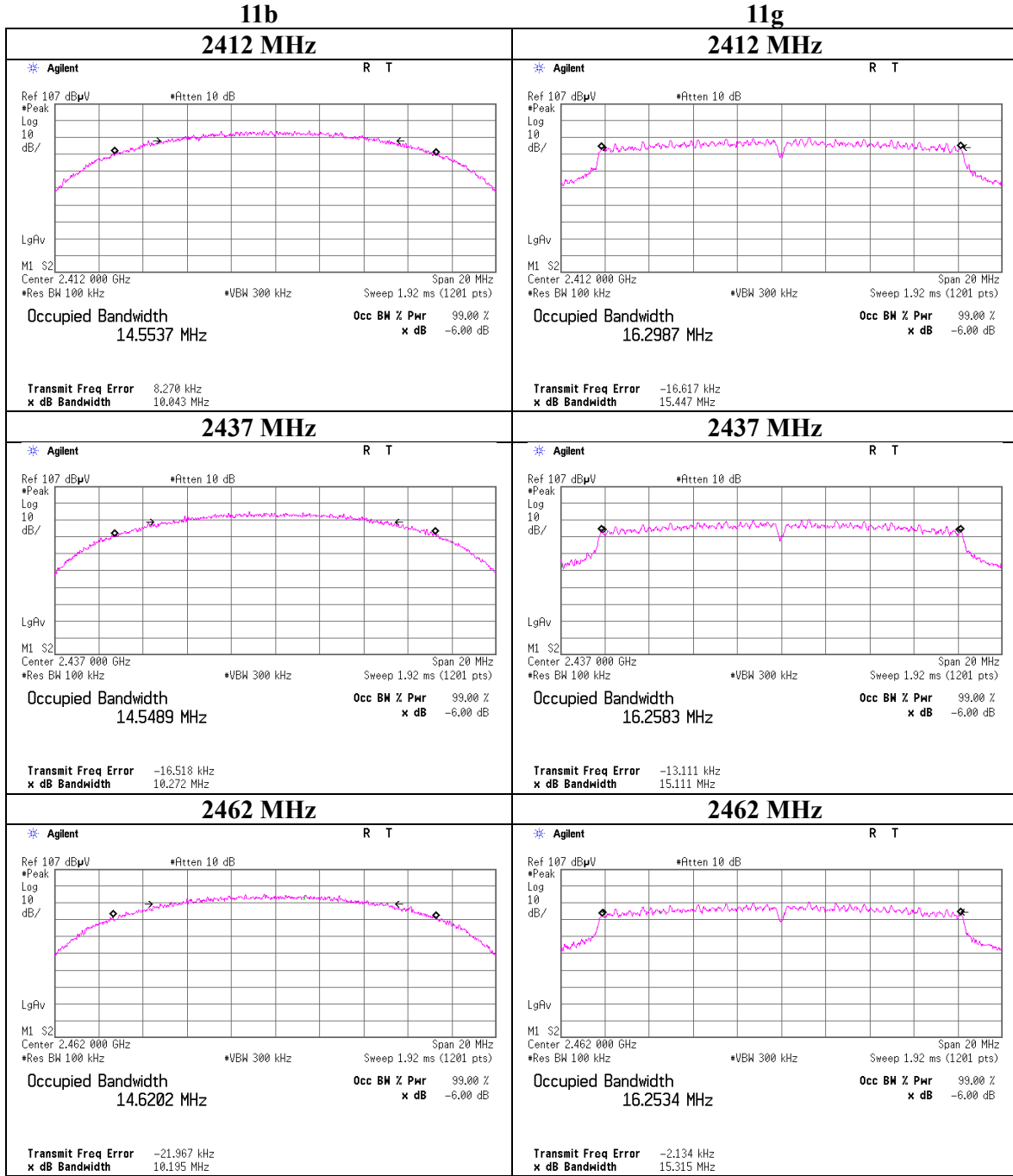

6dB Bandwidth

11n-20

2412 MHz

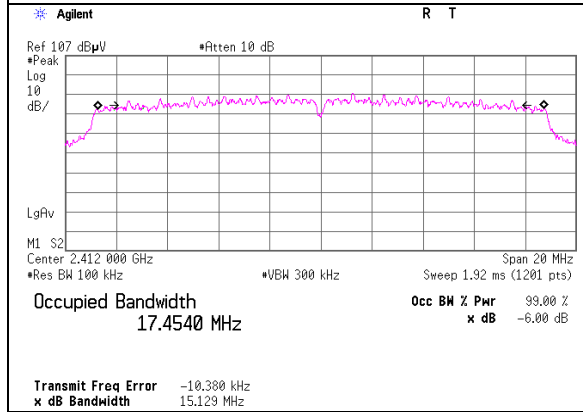

2437 MHz

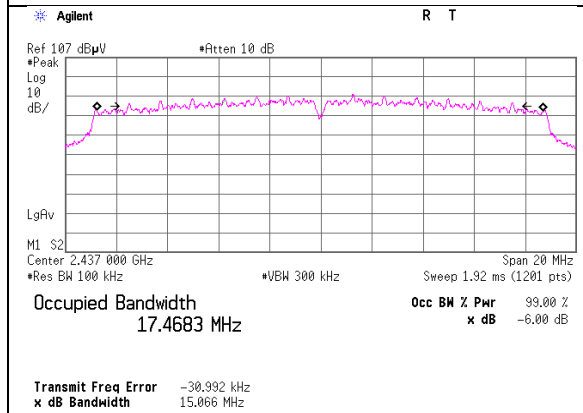

2462 MHz

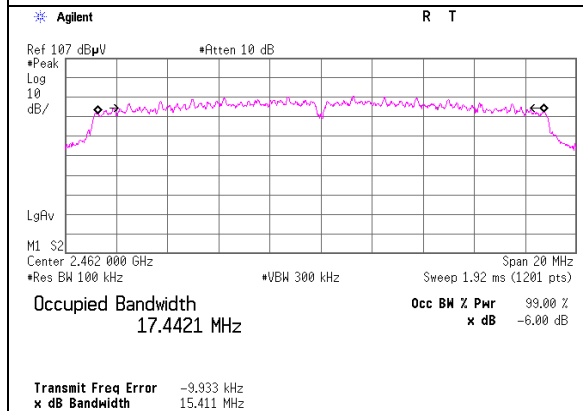

99% Occupied Bandwidth

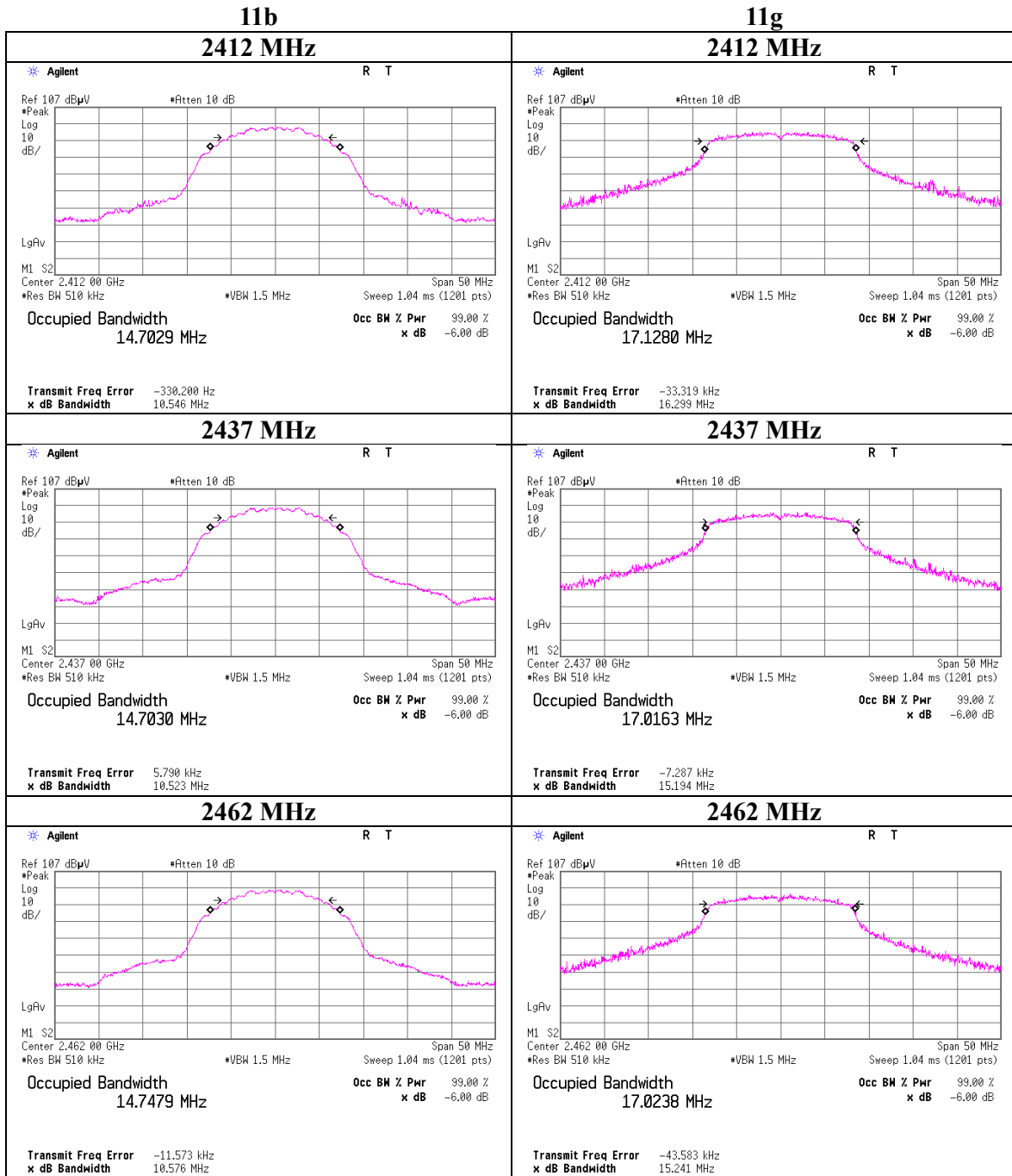

99% Occupied Bandwidth

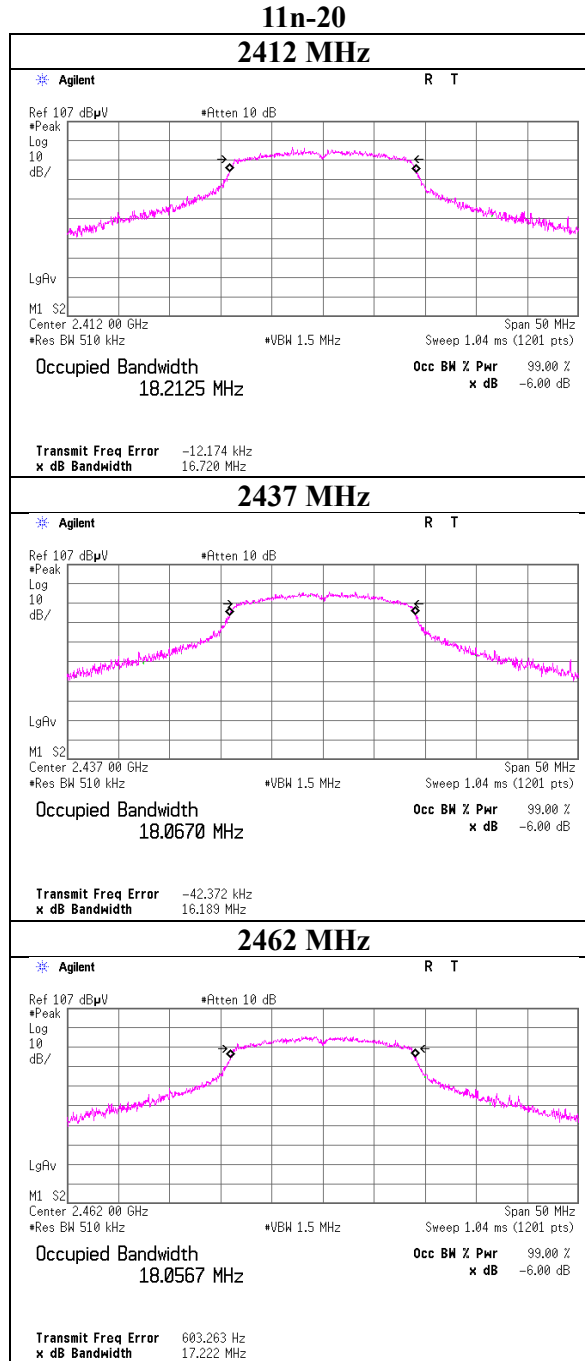

Maximum Peak Output Power

Test place	Ise EMC Lab. No.6 Measurement Room
Report No.	12862749H
Date	January 15, 2018
Temperature / Humidity	24 deg. C / 30 % RH
Engineer	Ken Fujita
Mode	Tx 11b

Freq. [MHz]	Reading [dBm]	Cable Loss [dB]	Atten. Loss [dB]	Result		Limit		Margin [dB]
				[dBm]	[mW]	[dBm]	[mW]	
2412	0.77	0.46	10.03	11.26	13.37	30.00	1000	18.74
2437	0.87	0.46	10.03	11.36	13.68	30.00	1000	18.64
2462	0.95	0.46	10.03	11.44	13.93	30.00	1000	18.56

Sample Calculation:

Result = Reading + Cable Loss (including the cable(s) customer supplied) + Attenuator Loss

2437MHz

Rate	Reading	Remark
[Mbps]	[dBm]	
1	0.75	
2	0.86	
5.5	0.87	*
11	0.85	

*: Worst Rate

All comparison were carried out on same frequency and measurement factors.

Maximum Peak Output Power

Test place	Ise EMC Lab. No.6 Measurement Room
Report No.	12862749H
Date	January 15, 2018
Temperature / Humidity	24 deg. C / 30 % RH
Engineer	Ken Fujita
Mode	Tx 11g

Freq. [MHz]	Reading [dBm]	Cable Loss [dB]	Atten. Loss [dB]	Result		Limit		Margin [dB]
				[dBm]	[mW]	[dBm]	[mW]	
2412	9.38	0.46	10.03	19.87	97.05	30.00	1000	10.13
2437	9.57	0.46	10.03	20.06	101.39	30.00	1000	9.94
2462	9.65	0.46	10.03	20.14	103.28	30.00	1000	9.86

Sample Calculation:

Result = Reading + Cable Loss (including the cable(s) customer supplied) + Attenuator Loss

2437 MHz

Rate	Reading	Remark
[Mbps]	[dBm]	
6	9.28	
9	9.30	
12	9.36	
18	9.38	
24	9.44	
36	9.42	
48	9.49	
54	9.57	*

*: Worst Rate

All comparison were carried out on same frequency and measurement factors.

Maximum Peak Output Power

Test place	Ise EMC Lab. No.6 Measurement Room
Report No.	12862749H
Date	January 15, 2018
Temperature / Humidity	24 deg. C / 30 % RH
Engineer	Ken Fujita
Mode	Tx 11n-20

Freq. [MHz]	Reading [dBm]	Cable Loss [dB]	Atten. Loss [dB]	Result		Limit		Margin [dB]
				[dBm]	[mW]	[dBm]	[mW]	
2412	9.34	0.46	10.03	19.83	96.16	30.00	1000	10.17
2437	9.52	0.46	10.03	20.01	100.23	30.00	1000	9.99
2462	9.66	0.46	10.03	20.15	103.51	30.00	1000	9.85

Sample Calculation:

Result = Reading + Cable Loss (including the cable(s) customer supplied) + Attenuator Loss

2437 MHz

MCS Number	Reading [dBm]	Remark
0	9.29	
1	9.35	
2	9.37	
3	9.41	
4	9.44	
5	9.45	
6	9.52*	
7	9.48	

*: Worst MCS

All comparison were carried out on same frequency and measurement factors.

Average Output Power
(Reference data for RF Exposure / SAR testing)

Test place : Ise EMC Lab. No.6 Measurement Room
Report No. : 12862749H
Date : January 15, 2018
Temperature / Humidity : 24 deg. C / 30 % RH
Engineer : Ken Fujita
Mode : Tx

11b 1Mbps

Freq. [MHz]	Reading [dBm]	Cable Loss [dB]	Atten. Loss [dB]	Result (Time average)		Duty factor [dB]	Result (Burst power average)	
				[dBm]	[mW]		[dBm]	[mW]
2412	-1.77	0.46	10.03	8.72	7.45	0.07	8.79	7.57
2437	-1.66	0.46	10.03	8.83	7.64	0.07	8.90	7.76
2462	-1.46	0.46	10.03	9.03	8.00	0.07	9.10	8.13

11g 6 Mbps

Freq. [MHz]	Reading [dBm]	Cable Loss [dB]	Atten. Loss [dB]	Result (Time average)		Duty factor [dB]	Result (Burst power average)	
				[dBm]	[mW]		[dBm]	[mW]
2412	-1.16	0.46	10.03	9.33	8.57	0.45	9.78	9.51
2437	-1.11	0.46	10.03	9.38	8.67	0.45	9.83	9.62
2462	-1.04	0.46	10.03	9.45	8.81	0.45	9.90	9.77

11n-20 MCS 0

Freq. [MHz]	Reading [dBm]	Cable Loss [dB]	Atten. Loss [dB]	Result (Time average)		Duty factor [dB]	Result (Burst power average)	
				[dBm]	[mW]		[dBm]	[mW]
2412	-1.16	0.46	10.03	9.33	8.57	0.43	9.76	9.46
2437	-0.92	0.46	10.03	9.57	9.06	0.43	10.00	10.00
2462	-0.77	0.46	10.03	9.72	9.38	0.43	10.15	10.35

Sample Calculation:

Result (Time average) = Reading + Cable Loss (including the cable(s) customer supplied) + Attenuator Loss

Result (Burst power average) = Time average + Duty factor

The average output power was measured with the lowest order modulation and lowest data rate configuration in each IEEE 802.11 mode based on KDB 248227 D01.

Burst rate confirmation

Test place : Ise EMC Lab. No.11 Measurement Room
Report No. : 12862749H
Date : December 13, 2017
Temperature / Humidity : 22 deg. C / 30 % RH
Engineer : Ken Fujita
Mode : Tx

11b 5.5 Mbps

11g 54 Mbps

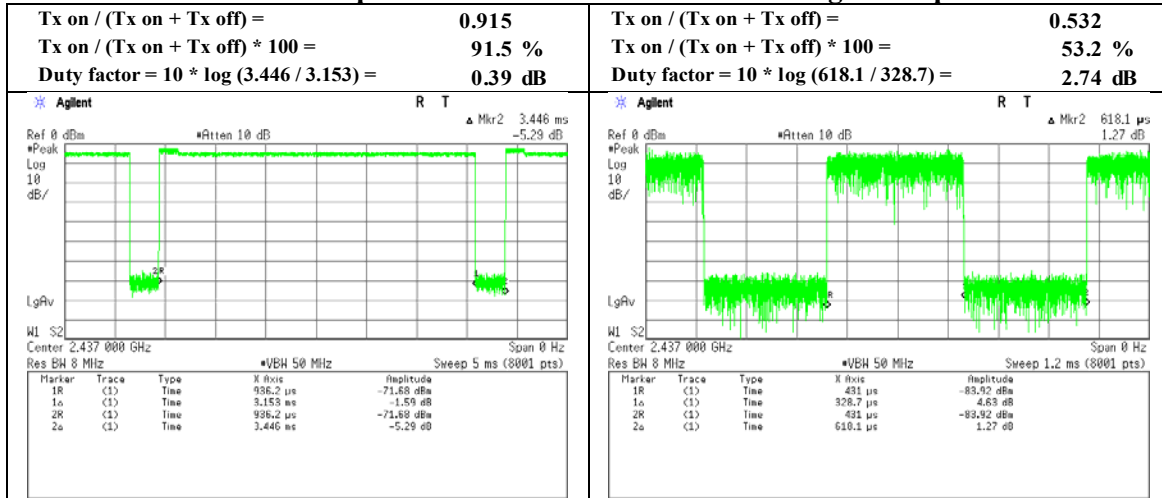

11n-20 MCS 6

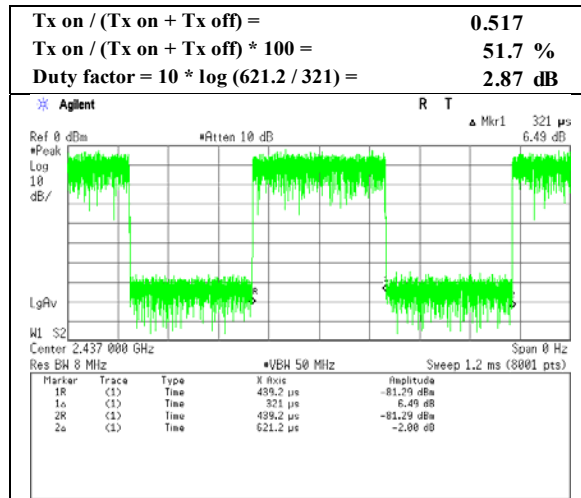

* Since the burst rate is not different between the channels, the data has been obtained on the representative channel.

Burst rate confirmation

Test place : Ise EMC Lab. No.11 Measurement Room
 Report No. : 12862749H
 Date : December 13, 2017
 Temperature / Humidity : 22 deg. C / 30 % RH
 Engineer : Ken Fujita
 Mode : Tx

11b 1 Mbps

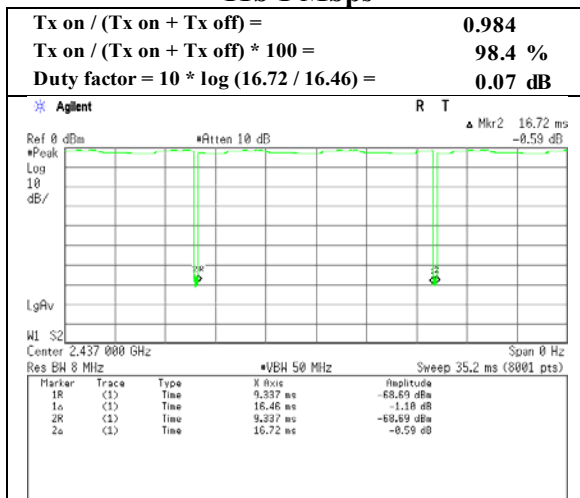

11g 6 Mbps

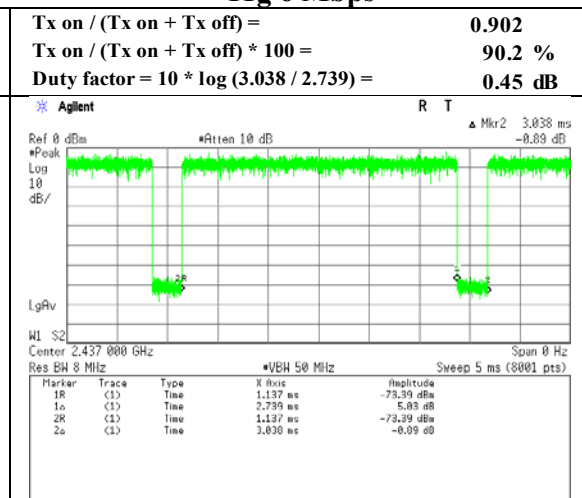

11n-20 MCS 0

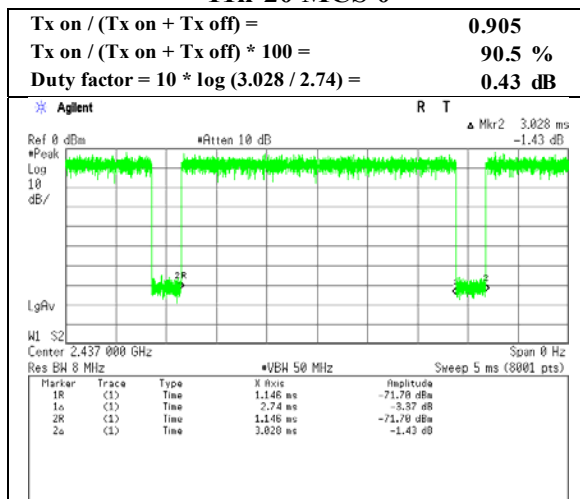

* Since the burst rate is not different between the channels, the data has been obtained on the representative channel.

Radiated Spurious Emission

Report No. 12862749H
Test place Ise EMC Lab.
Semi Anechoic Chamber No.2 No.2
Date January 10, 2018 January 11, 2018
Temperature / Humidity 23 deg. C / 32 % RH 23 deg. C / 35 % RH
Engineer Masafumi Niwa Masafumi Niwa
(1 GHz - 10 GHz) (10 GHz - 26.5 GHz)
Mode Tx 11b 2412 MHz

Polarity	Frequency [MHz]	Detector	Reading [dBuV]	Ant.Fac. [dB/m]	Loss [dB]	Gain [dB]	Duty Factor [dB]	Result [dBuV/m]	Limit [dBuV/m]	Margin [dB]	Remark
Hori	2390.000	PK	49.6	27.0	5.1	34.6	-	47.1	73.9	26.8	Floor noise
Hori	4824.000	PK	52.9	31.3	7.4	33.8	-	57.8	73.9	16.1	
Hori	7236.000	PK	42.1	35.7	8.8	33.9	-	52.7	73.9	21.2	
Hori	14472.000	PK	44.8	41.6	-0.5	32.6	-	53.3	73.9	20.6	
Hori	19296.000	PK	45.9	36.5	-1.8	31.9	-	48.7	73.9	25.2	
Hori	24120.000	PK	45.5	38.4	-0.8	31.8	-	51.3	73.9	22.6	
Hori	2390.000	AV	41.9	27.0	5.1	34.6	0.4	39.8	53.9	14.1	*1)
Hori	4824.000	AV	46.1	31.3	7.4	33.8	0.4	51.4	53.9	2.5	Floor noise
Hori	7236.000	AV	32.6	35.7	8.8	33.9	-	43.2	53.9	10.7	
Hori	14472.000	AV	39.2	41.6	-0.5	32.6	0.4	48.1	53.9	5.8	
Hori	19296.000	AV	42.1	36.5	-1.8	31.9	0.4	45.3	53.9	8.6	
Hori	24120.000	AV	39.8	38.4	-0.8	31.8	0.4	46.0	53.9	7.9	
Vert	2390.000	PK	47.4	27.0	5.1	34.6	-	44.9	73.9	29.0	
Vert	4824.000	PK	55.2	31.3	7.4	33.8	-	60.1	73.9	13.8	
Vert	7236.000	PK	42.4	35.7	8.8	33.9	-	53.0	73.9	20.9	
Vert	14472.000	PK	46.2	41.6	-0.5	32.6	-	54.7	73.9	19.2	
Vert	19296.000	PK	45.5	36.5	-1.8	31.9	-	48.3	73.9	25.6	
Vert	24120.000	PK	45.7	38.4	-0.8	31.8	-	51.5	73.9	22.4	
Vert	2390.000	AV	39.7	27.0	5.1	34.6	0.4	37.6	53.9	16.3	*1)
Vert	4824.000	AV	47.9	31.3	7.4	33.8	0.4	53.2	53.9	0.7	Floor noise
Vert	7236.000	AV	32.4	35.7	8.8	33.9	-	43.0	53.9	10.9	
Vert	14472.000	AV	41.5	41.6	-0.5	32.6	0.4	50.4	53.9	3.5	
Vert	19296.000	AV	39.9	36.5	-1.8	31.9	0.4	43.1	53.9	10.8	
Vert	24120.000	AV	39.9	38.4	-0.8	31.8	0.4	46.1	53.9	7.8	

Result = Reading + Ant Factor + Loss (Cable+Attenuator+Filter+Distance factor(above 1 GHz)) - Gain(Amplifier) + Duty factor

*Other frequency noises omitted in this report were not seen or had enough margin (more than 20 dB).

Distance factor: 1 GHz - 10 GHz 20log (3.75 m / 3.0 m) = 1.94 dB
10 GHz - 26.5 GHz 20log (1.0 m / 3.0 m) = -9.5 dB

*1) Not Out of Band emission(Leakage Power)

20dBc Data Sheet

Polarity	Frequency [MHz]	Detector	Reading [dBuV]	Ant Factor [dB/m]	Loss [dB]	Gain [dB]	Result [dBuV/m]	Limit [dBuV/m]	Margin [dB]	Remark
Hori	2412.000	PK	101.2	27.0	5.1	34.6	98.7	-	-	Carrier
Hori	2400.000	PK	53.1	27.0	5.1	34.6	50.6	78.7	28.1	
Hori	9648.000	PK	48.4	38.2	9.5	34.5	61.6	78.7	17.1	
Vert	2412.000	PK	99.1	27.0	5.1	34.6	96.6	-	-	Carrier
Vert	2400.000	PK	51.6	27.0	5.1	34.6	49.1	76.6	27.5	
Vert	9648.000	PK	47.2	38.2	9.5	34.5	60.4	76.6	16.2	

Result = Reading + Ant Factor + Loss (Cable+Attenuator+Filter+Distance factor(above 1 GHz)) - Gain(Amplifier)

**Radiated Spurious Emission
(Reference Plot for band-edge)**

Report No. 12862749H
Test place Ise EMC Lab.
Semi Anechoic Chamber No.2
Date January 10, 2018
Temperature / Humidity 23 deg. C / 32 % RH
Engineer Masafumi Niwa
(1 GHz - 10 GHz)
Mode Tx 11b 2412 MHz

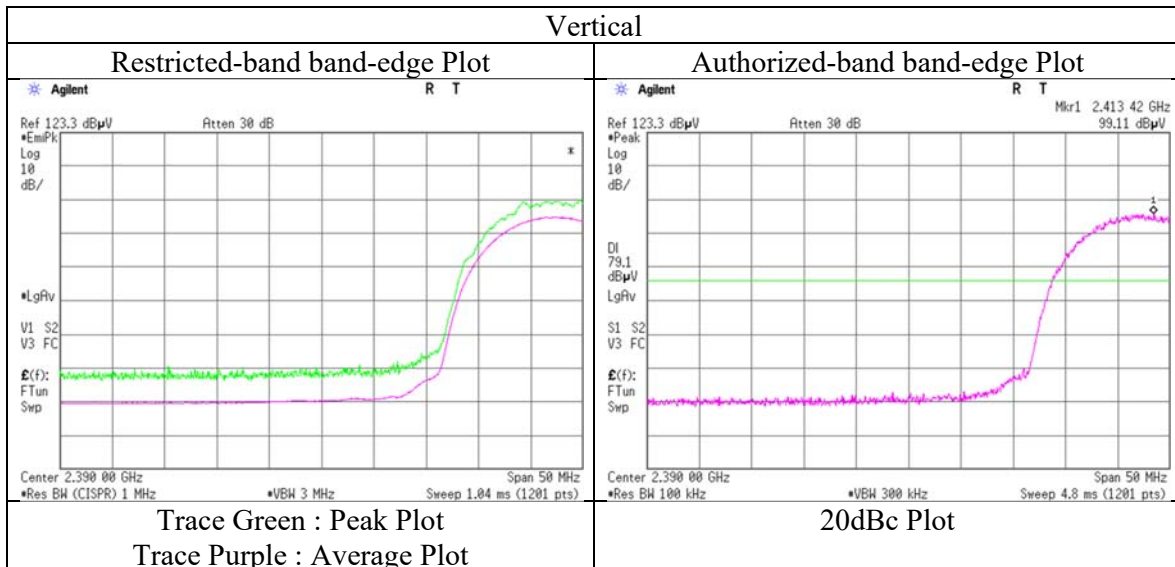
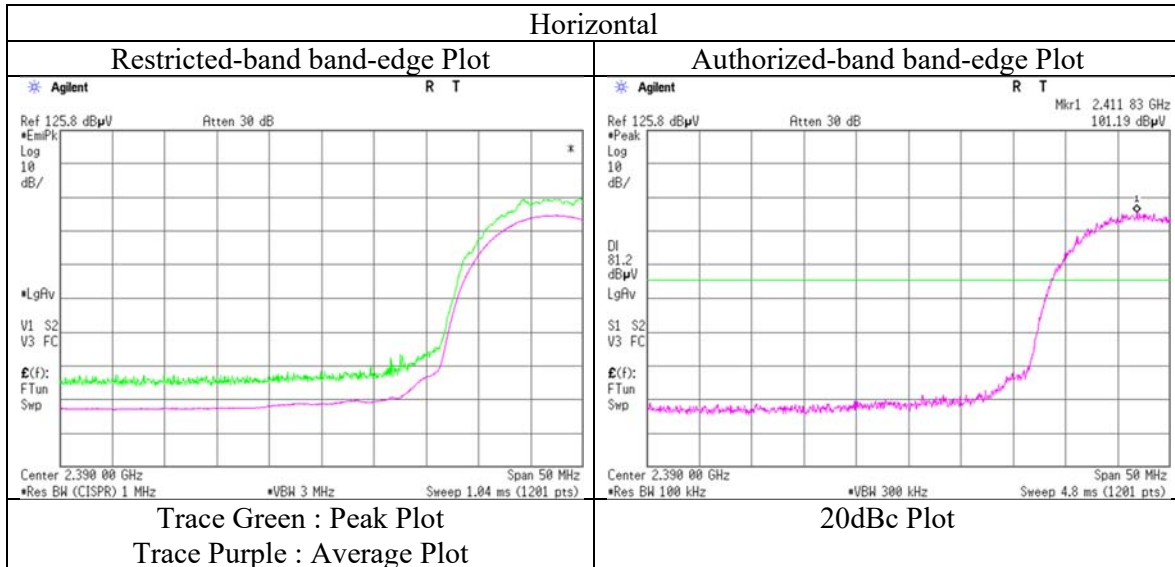

* Final result of restricted band edge was shown in tabular data.

Radiated Spurious Emission

Report No.	12862749H	
Test place	Ise EMC Lab.	
Semi Anechoic Chamber	No.2	No.2
Date	January 10, 2018	January 11, 2018
Temperature / Humidity	23 deg. C / 32 % RH	23 deg. C / 35 % RH
Engineer	Masafumi Niwa	Masafumi Niwa
	(1 GHz - 10 GHz)	(10 GHz - 26.5 GHz)
Mode	Tx 11b 2437 MHz	

Polarity	Frequency [MHz]	Detector	Reading [dBuV]	Ant.Fac. [dB/m]	Loss [dB]	Gain [dB]	Duty Factor [dB]	Result [dBuV/m]	Limit [dBuV/m]	Margin [dB]	Remark
Hori	4874.000	PK	52.4	31.4	7.4	33.8	-	57.4	73.9	16.5	Floor noise
Hori	7311.000	PK	43.0	35.7	8.8	33.9	-	53.6	73.9	20.3	
Hori	14622.000	PK	44.1	41.7	-0.5	32.6	-	52.7	73.9	21.2	
Hori	19496.000	PK	47.9	36.2	-1.8	32.1	-	50.2	73.9	23.7	
Hori	24370.000	PK	46.6	38.4	-0.8	32.2	-	52.0	73.9	21.9	
Hori	4874.000	AV	47.9	31.4	7.4	33.8	0.4	53.3	53.9	0.6	Floor noise
Hori	7311.000	AV	34.1	35.7	8.8	33.9	-	44.7	53.9	9.2	
Hori	14622.000	AV	39.0	41.7	-0.5	32.6	0.4	48.0	53.9	5.9	
Hori	19496.000	AV	43.8	36.2	-1.8	32.1	0.4	46.5	53.9	7.4	
Hori	24370.000	AV	41.0	38.4	-0.8	32.2	0.4	46.8	53.9	7.1	
Vert	4874.000	PK	52.1	31.4	7.4	33.8	-	57.1	73.9	16.8	Floor noise
Vert	7311.000	PK	43.2	35.7	8.8	33.9	-	53.8	73.9	20.1	
Vert	14622.000	PK	46.2	41.7	-0.5	32.6	-	54.8	73.9	19.1	
Vert	19496.000	PK	44.8	36.2	-1.8	32.1	-	47.1	73.9	26.8	
Vert	24370.000	PK	46.6	38.4	-0.8	32.2	-	52.0	73.9	21.9	
Vert	4874.000	AV	47.4	31.4	7.4	33.8	0.4	52.8	53.9	1.1	Floor noise
Vert	7311.000	AV	34.0	35.7	8.8	33.9	-	44.6	53.9	9.3	
Vert	14622.000	AV	41.2	41.7	-0.5	32.6	0.4	50.2	53.9	3.7	
Vert	19496.000	AV	38.7	36.2	-1.8	32.1	0.4	41.4	53.9	12.5	
Vert	24370.000	AV	40.7	38.4	-0.8	32.2	0.4	46.5	53.9	7.4	

Result = Reading + Ant Factor + Loss (Cable+Attenuator+Filter+Distance factor(above 1 GHz)) - Gain(Amplifier) + Duty factor

*Other frequency noises omitted in this report were not seen or had enough margin (more than 20 dB).

Distance factor: 1 GHz - 10 GHz 20log (3.75 m / 3.0 m) = 1.94 dB
 10 GHz - 26.5 GHz 20log (1.0 m / 3.0 m) = -9.5 dB

20dBc Data Sheet

Polarity	Frequency [MHz]	Detector	Reading [dBuV]	Ant Factor [dB/m]	Loss [dB]	Gain [dB]	Result [dBuV/m]	Limit [dBuV/m]	Margin [dB]	Remark
Hori	2437.000	PK	100.0	27.0	5.2	34.6	97.6	-	-	Carrier
Hori	9748.000	PK	45.2	38.2	9.4	34.5	58.3	77.6	19.3	
Vert	2437.000	PK	98.9	27.0	5.2	34.6	96.5	-	-	Carrier
Vert	9748.000	PK	44.6	38.2	9.4	34.5	57.7	76.5	18.8	

Result = Reading + Ant Factor + Loss (Cable+Attenuator+Filter+Distance factor(above 1 GHz)) - Gain(Amplifier)

Radiated Spurious Emission

Report No. 12862749H
Test place Ise EMC Lab.
Semi Anechoic Chamber No.2 No.2
Date January 10, 2018 January 11, 2018
Temperature / Humidity 23 deg. C / 32 % RH 23 deg. C / 35 % RH
Engineer Masafumi Niwa Masafumi Niwa
(1 GHz - 10 GHz) (10 GHz - 26.5 GHz)
Mode Tx 11b 2462 MHz

Polarity	Frequency [MHz]	Detector	Reading [dBuV]	Ant.Fac. [dB/m]	Loss [dB]	Gain [dB]	Duty Factor [dB]	Result [dBuV/m]	Limit [dBuV/m]	Margin [dB]	Remark
Hori	2483.500	PK	52.4	27.0	5.2	34.6	-	50.0	73.9	23.9	Floor noise
Hori	4924.000	PK	52.5	31.5	7.5	33.8	-	57.7	73.9	16.2	
Hori	7386.000	PK	42.6	35.8	8.7	34.0	-	53.1	73.9	20.8	
Hori	14772.000	PK	44.1	41.8	-0.4	32.6	-	52.9	73.9	21.0	
Hori	19696.000	PK	49.2	36.0	-1.7	32.4	-	51.1	73.9	22.8	
Hori	24620.000	PK	47.3	38.5	-0.7	32.7	-	52.4	73.9	21.5	
Hori	2483.500	AV	45.3	27.0	5.2	34.6	0.4	43.3	53.9	10.6	*1)
Hori	4924.000	AV	46.2	31.5	7.5	33.8	0.4	51.8	53.9	2.1	Floor noise
Hori	7386.000	AV	34.3	35.8	8.7	34.0	-	44.8	53.9	9.1	
Hori	14772.000	AV	37.0	41.8	-0.4	32.6	0.4	46.2	53.9	7.7	
Hori	19696.000	AV	45.3	36.0	-1.7	32.4	0.4	47.6	53.9	6.3	
Hori	24620.000	AV	42.3	38.5	-0.7	32.7	0.4	47.8	53.9	6.1	
Vert	2483.500	PK	51.7	27.0	5.2	34.6	-	49.3	73.9	24.6	
Vert	4924.000	PK	52.1	31.5	7.5	33.8	-	57.3	73.9	16.6	
Vert	7386.000	PK	42.5	35.8	8.7	34.0	-	53.0	73.9	20.9	
Vert	14772.000	PK	44.8	41.8	-0.4	32.6	-	53.6	73.9	20.3	
Vert	19696.000	PK	47.8	36.0	-1.7	32.4	-	49.7	73.9	24.2	
Vert	24620.000	PK	47.7	38.5	-0.7	32.7	-	52.8	73.9	21.1	
Vert	2483.500	AV	44.0	27.0	5.2	34.6	0.4	42.0	53.9	11.9	*1)
Vert	4924.000	AV	44.7	31.5	7.5	33.8	0.4	50.3	53.9	3.6	Floor noise
Vert	7386.000	AV	34.2	35.8	8.7	34.0	-	44.7	53.9	9.2	
Vert	14772.000	AV	38.9	41.8	-0.4	32.6	0.4	48.1	53.9	5.8	
Vert	19696.000	AV	43.8	36.0	-1.7	32.4	0.4	46.1	53.9	7.8	
Vert	24620.000	AV	40.9	38.5	-0.7	32.7	0.4	46.4	53.9	7.5	

Result = Reading + Ant Factor + Loss (Cable+Attenuator+Filter+Distance factor(above 1 GHz)) - Gain(Amplifier) + Duty factor
*Other frequency noises omitted in this report were not seen or had enough margin (more than 20 dB).

Distance factor: 1 GHz - 10 GHz 20log (3.75 m / 3.0 m) = 1.94 dB
10 GHz - 26.5 GHz 20log (1.0 m / 3.0 m) = -9.5 dB

*1) Not Out of Band emission(Leakage Power)

20dBc Data Sheet

Polarity	Frequency [MHz]	Detector	Reading [dBuV]	Ant Factor [dB/m]	Loss [dB]	Gain [dB]	Result [dBuV/m]	Limit [dBuV/m]	Margin [dB]	Remark
Hori	2462.000	PK	101.6	27.0	5.2	34.6	99.2	-	-	Carrier
Hori	9848.000	PK	44.0	38.2	9.4	34.5	57.1	79.2	22.1	
Vert	2462.000	PK	99.3	27.0	5.2	34.6	96.9	-	-	Carrier
Vert	9848.000	PK	43.7	38.2	9.4	34.5	56.8	76.9	20.1	

Result = Reading + Ant Factor + Loss (Cable+Attenuator+Filter+Distance factor(above 1 GHz)) - Gain(Amplifier)

Radiated Spurious Emission
(Reference Plot for band-edge)

Report No.	12862749H
Test place	Ise EMC Lab.
Semi Anechoic Chamber	No.2
Date	January 10, 2018
Temperature / Humidity	23 deg. C / 32 % RH
Engineer	Masafumi Niwa
	(1 GHz - 10 GHz)
Mode	Tx 11b 2462 MHz

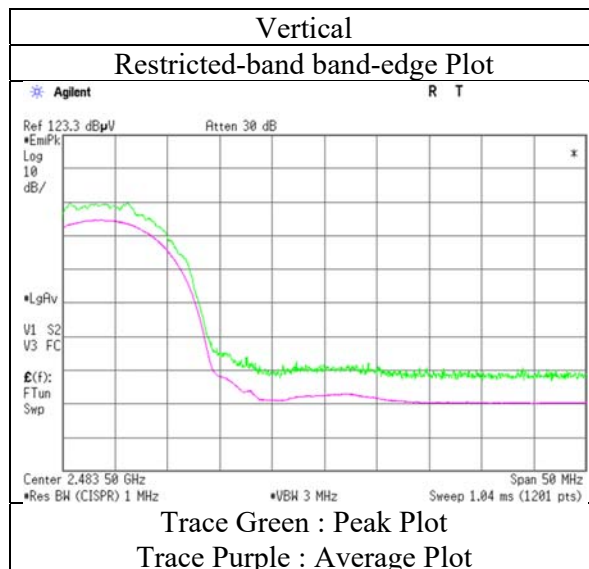
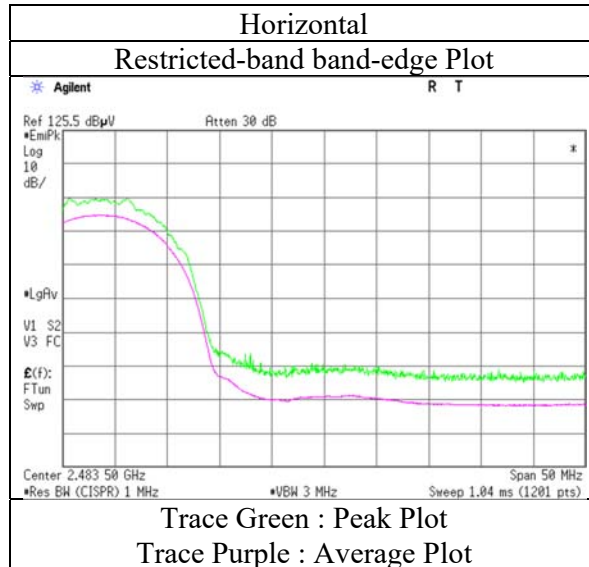

* Final result of restricted band edge was shown in tabular data.

Radiated Spurious Emission

Report No. 12862749H
Test place Ise EMC Lab.
Semi Anechoic Chamber No.2 No.2
Date January 10, 2018 January 11, 2018
Temperature / Humidity 23 deg. C / 32 % RH 23 deg. C / 35 % RH
Engineer Masafumi Niwa Masafumi Niwa
(1 GHz - 10 GHz) (10 GHz - 26.5 GHz)
Mode Tx 11n-20 2412 MHz

Polarity	Frequency [MHz]	Detector	Reading [dBuV]	Ant.Fac. [dB/m]	Loss [dB]	Gain [dB]	Duty Factor [dB]	Result [dBuV/m]	Limit [dBuV/m]	Margin [dB]	Remark
Hori	2390.000	PK	68.5	27.0	5.1	34.6	-	66.0	73.9	7.9	
Hori	4824.000	PK	53.7	31.3	7.4	33.8	-	58.6	73.9	15.3	
Hori	7236.000	PK	42.2	35.7	8.8	33.9	-	52.8	73.9	21.1	Floor noise
Hori	14472.000	PK	44.9	41.6	-0.5	32.6	-	53.4	73.9	20.5	
Hori	19296.000	PK	46.2	36.5	-1.8	31.9	-	49.0	73.9	24.9	
Hori	24120.000	PK	46.6	38.4	-0.8	31.8	-	52.4	73.9	21.5	
Hori	2390.000	AV	49.4	27.0	5.1	34.6	2.9	49.8	53.9	4.1	*1)
Hori	4824.000	AV	43.6	31.3	7.4	33.8	2.9	51.4	53.9	2.5	
Hori	7236.000	AV	32.5	35.7	8.8	33.9	-	43.1	53.9	10.8	Floor noise
Hori	14472.000	AV	38.3	41.6	-0.5	32.6	2.9	49.7	53.9	4.2	
Hori	19296.000	AV	40.5	36.5	-1.8	31.9	2.9	46.2	53.9	7.7	
Hori	24120.000	AV	38.6	38.4	-0.8	31.8	2.9	47.3	53.9	6.6	
Vert	2390.000	PK	65.8	27.0	5.1	34.6	-	63.3	73.9	10.6	
Vert	4824.000	PK	55.3	31.3	7.4	33.8	-	60.2	73.9	13.7	
Vert	7236.000	PK	42.3	35.7	8.8	33.9	-	52.9	73.9	21.0	Floor noise
Vert	14472.000	PK	46.0	41.6	-0.5	32.6	-	54.5	73.9	19.4	
Vert	19296.000	PK	45.0	36.5	-1.8	31.9	-	47.8	73.9	26.1	
Vert	24120.000	PK	45.8	38.4	-0.8	31.8	-	51.6	73.9	22.3	
Vert	2390.000	AV	46.4	27.0	5.1	34.6	2.9	46.8	53.9	7.1	*1)
Vert	4824.000	AV	44.8	31.3	7.4	33.8	2.9	52.6	53.9	1.3	
Vert	7236.000	AV	32.4	35.7	8.8	33.9	-	43.0	53.9	10.9	Floor noise
Vert	14472.000	AV	40.6	41.6	-0.5	32.6	2.9	52.0	53.9	1.9	
Vert	19296.000	AV	39.0	36.5	-1.8	31.9	2.9	44.7	53.9	9.2	
Vert	24120.000	AV	39.2	38.4	-0.8	31.8	2.9	47.9	53.9	6.0	

Result = Reading + Ant Factor + Loss (Cable+Attenuator+Filter+Distance factor(above 1 GHz)) - Gain(Amplifier) + Duty factor
*Other frequency noises omitted in this report were not seen or had enough margin (more than 20 dB).

Distance factor: 1 GHz - 10 GHz 20log (3.75 m / 3.0 m) = 1.94 dB
10 GHz - 26.5 GHz 20log (1.0 m / 3.0 m) = -9.5 dB

*1) Not Out of Band emission(Leakage Power)

20dBc Data Sheet

Polarity	Frequency [MHz]	Detector	Reading [dBuV]	Ant Factor [dB/m]	Loss [dB]	Gain [dB]	Result [dBuV/m]	Limit [dBuV/m]	Margin [dB]	Remark
Hori	2412.000	PK	101.0	27.0	5.1	34.6	98.5	-	-	Carrier
Hori	2400.000	PK	70.7	27.0	5.1	34.6	68.2	78.5	10.3	
Hori	9648.000	PK	47.1	38.2	9.5	34.5	60.3	78.5	18.2	
Vert	2412.000	PK	97.8	27.0	5.1	34.6	95.3	-	-	Carrier
Vert	2400.000	PK	67.7	27.0	5.1	34.6	65.2	75.3	10.1	
Vert	9648.000	PK	44.5	38.2	9.5	34.5	57.7	75.3	17.6	

Result = Reading + Ant Factor + Loss (Cable+Attenuator+Filter+Distance factor(above 1 GHz)) - Gain(Amplifier)

**Radiated Spurious Emission
(Reference Plot for band-edge)**

Report No. 12862749H
Test place Ise EMC Lab.
Semi Anechoic Chamber No.2
Date January 10, 2018
Temperature / Humidity 23 deg. C / 32 % RH
Engineer Masafumi Niwa
(1 GHz - 10 GHz)
Mode Tx 11n-20 2412 MHz

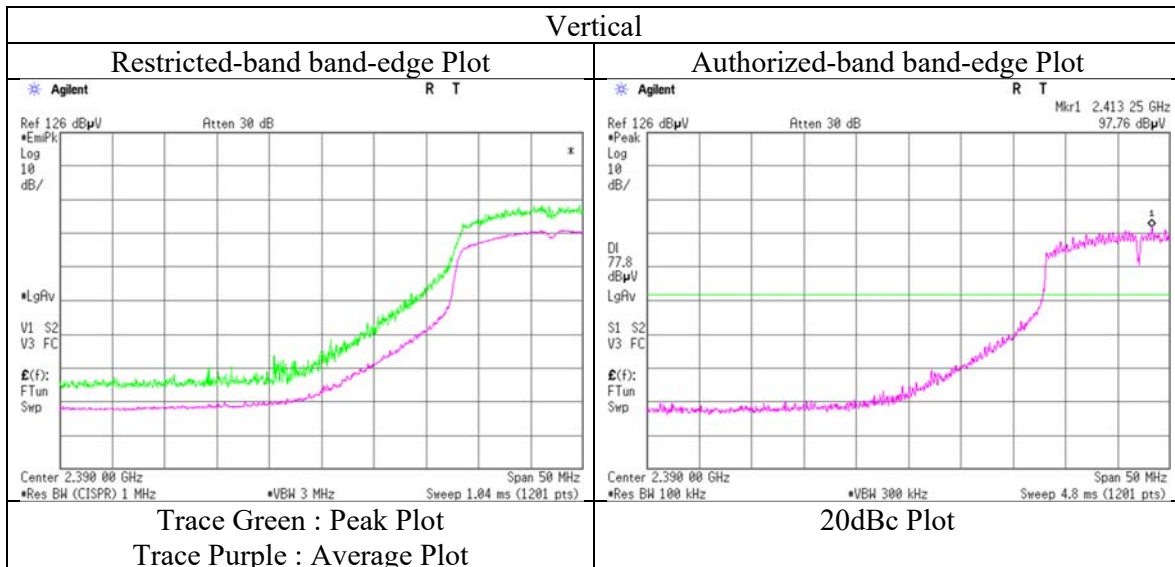
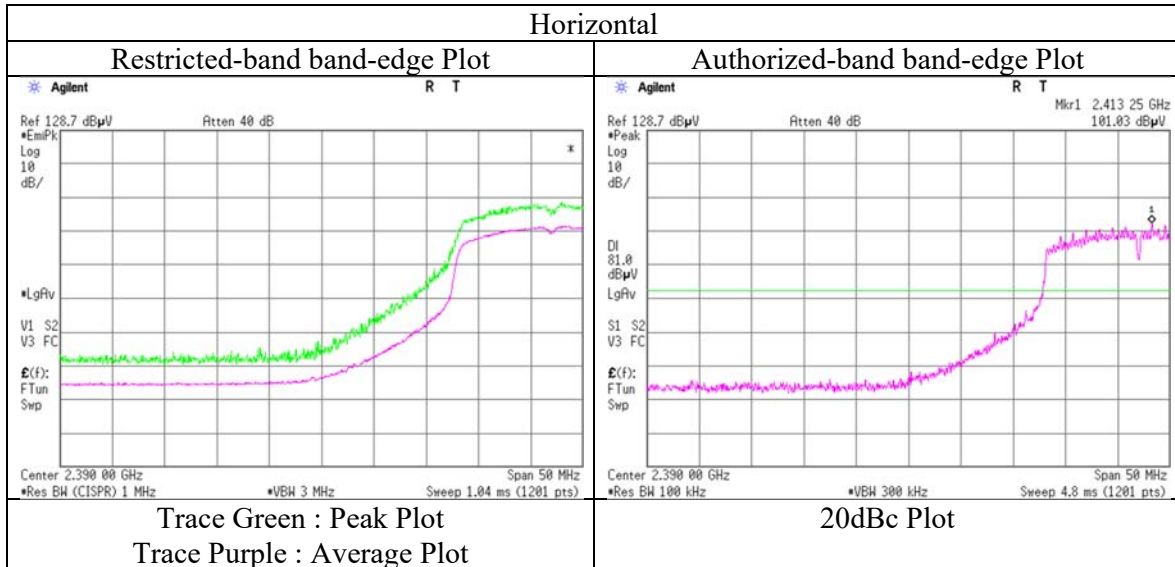

* Final result of restricted band edge was shown in tabular data.

Radiated Spurious Emission

Report No. 12862749H
Test place Ise EMC Lab.
Semi Anechoic Chamber No.2 No.2
Date January 10, 2018 January 11, 2018
Temperature / Humidity 23 deg. C / 32 % RH 23 deg. C / 35 % RH
Engineer Masafumi Niwa Masafumi Niwa
(1 GHz - 10 GHz) (10 GHz - 26.5 GHz)
Mode Tx 11n-20 2437 MHz

Polarity	Frequency [MHz]	Detector	Reading [dBuV]	Ant.Fac. [dB/m]	Loss [dB]	Gain [dB]	Duty Factor [dB]	Result [dBuV/m]	Limit [dBuV/m]	Margin [dB]	Remark
Hori	4874.000	PK	52.1	31.4	7.4	33.8	-	57.1	73.9	16.8	Floor noise
Hori	7311.000	PK	43.2	35.7	8.8	33.9	-	53.8	73.9	20.1	
Hori	14622.000	PK	44.6	41.7	-0.5	32.6	-	53.2	73.9	20.7	
Hori	19496.000	PK	48.0	36.2	-1.8	32.1	-	50.3	73.9	23.6	
Hori	24370.000	PK	46.4	38.4	-0.8	32.2	-	51.8	73.9	22.1	
Hori	4874.000	AV	43.0	31.4	7.4	33.8	2.9	50.9	53.9	3.0	Floor noise
Hori	7311.000	AV	34.2	35.7	8.8	33.9	-	44.8	53.9	9.1	
Hori	14622.000	AV	37.9	41.7	-0.5	32.6	2.9	49.4	53.9	4.5	
Hori	19496.000	AV	42.2	36.2	-1.8	32.1	2.9	47.4	53.9	6.5	
Hori	24370.000	AV	39.6	38.4	-0.8	32.2	2.9	47.9	53.9	6.0	
Vert	4874.000	PK	53.6	31.4	7.4	33.8	-	58.6	73.9	15.3	Floor noise
Vert	7311.000	PK	43.1	35.7	8.8	33.9	-	53.7	73.9	20.2	
Vert	14622.000	PK	45.7	41.7	-0.5	32.6	-	54.3	73.9	19.6	
Vert	19496.000	PK	47.0	36.2	-1.8	32.1	-	49.3	73.9	24.6	
Vert	24370.000	PK	46.6	38.4	-0.8	32.2	-	52.0	73.9	21.9	
Vert	4874.000	AV	43.8	31.4	7.4	33.8	2.9	51.7	53.9	2.2	Floor noise
Vert	7311.000	AV	34.0	35.7	8.8	33.9	-	44.6	53.9	9.3	
Vert	14622.000	AV	40.3	41.7	-0.5	32.6	2.9	51.8	53.9	2.1	
Vert	19496.000	AV	40.3	36.2	-1.8	32.1	2.9	45.5	53.9	8.4	
Vert	24370.000	AV	40.1	38.4	-0.8	32.2	2.9	48.4	53.9	5.5	

Result = Reading + Ant Factor + Loss (Cable+Attenuator+Filter+Distance factor(above 1 GHz)) - Gain(Amplifier) + Duty factor

*Other frequency noises omitted in this report were not seen or had enough margin (more than 20 dB).

Distance factor: 1 GHz - 10 GHz 20log (3.75 m / 3.0 m) = 1.94 dB
10 GHz - 26.5 GHz 20log (1.0 m / 3.0 m) = -9.5 dB

20dBc Data Sheet

Polarity	Frequency [MHz]	Detector	Reading [dBuV]	Ant Factor [dB/m]	Loss [dB]	Gain [dB]	Result [dBuV/m]	Limit [dBuV/m]	Margin [dB]	Remark
Hori	2437.000	PK	100.2	27.0	5.2	34.6	97.8	-	-	Carrier
Hori	9748.000	PK	46.2	38.2	9.4	34.5	59.3	77.8	18.5	
Vert	2437.000	PK	98.5	27.0	5.2	34.6	96.1	-	-	Carrier
Vert	9748.000	PK	43.6	38.2	9.4	34.5	56.7	76.1	19.4	

Result = Reading + Ant Factor + Loss (Cable+Attenuator+Filter+Distance factor(above 1 GHz)) - Gain(Amplifier)

Radiated Spurious Emission

Report No. 12862749H
Test place Ise EMC Lab.
Semi Anechoic Chamber No.2 No.2 No.2
Date January 10, 2018 January 11, 2018 January 12, 2018
Temperature / Humidity 23 deg. C / 32 % RH 23 deg. C / 35 % RH 21 deg. C / 31 % RH
Engineer Masafumi Niwa Masafumi Niwa Masafumi Niwa
(1 GHz - 10 GHz) (10 GHz - 26.5 GHz) (Below 1 GHz)
Mode Tx 11n-20 2462 MHz

Polarity	Frequency [MHz]	Detector	Reading [dBuV]	Ant.Fac. [dB/m]	Loss [dB]	Gain [dB]	Duty Factor [dB]	Result [dBuV/m]	Limit [dBuV/m]	Margin [dB]	Remark
Hori	101.939	QP	40.0	10.4	7.4	30.2	-	27.6	43.5	15.9	
Hori	108.772	QP	40.2	11.4	7.5	30.2	-	28.9	43.5	14.6	
Hori	125.001	QP	41.9	13.3	7.6	30.1	-	32.7	43.5	10.8	
Hori	250.001	QP	42.6	11.7	8.5	29.3	-	33.5	46.0	12.5	
Hori	360.139	QP	39.0	14.8	9.3	29.5	-	33.6	46.0	12.4	
Hori	375.025	QP	43.3	15.1	9.3	29.6	-	38.1	46.0	7.9	
Hori	500.034	QP	33.9	17.7	9.8	30.0	-	31.4	46.0	14.6	
Hori	2483.500	PK	72.6	27.0	5.2	34.6	-	70.2	73.9	3.7	
Hori	4924.000	PK	52.9	31.5	7.5	33.8	-	58.1	73.9	15.8	
Hori	7386.000	PK	42.6	35.8	8.7	34.0	-	53.1	73.9	20.8	Floor noise
Hori	14772.000	PK	44.4	41.8	-0.4	32.6	-	53.2	73.9	20.7	
Hori	19696.000	PK	48.3	36.0	-1.7	32.4	-	50.2	73.9	23.7	
Hori	24620.000	PK	49.2	38.5	-0.7	32.7	-	54.3	73.9	19.6	
Hori	2483.500	AV	52.1	27.0	5.2	34.6	2.9	52.6	53.9	1.3	*1)
Hori	4924.000	AV	43.1	31.5	7.5	33.8	2.9	51.2	53.9	2.7	
Hori	7386.000	AV	34.2	35.8	8.7	34.0	-	44.7	53.9	9.2	Floor noise
Hori	14772.000	AV	37.1	41.8	-0.4	32.6	2.9	48.8	53.9	5.1	
Hori	19696.000	AV	43.0	36.0	-1.7	32.4	2.9	47.8	53.9	6.1	
Hori	24620.000	AV	41.0	38.5	-0.7	32.7	2.9	49.0	53.9	4.9	
Vert	39.005	QP	35.3	14.9	6.8	30.5	-	26.5	40.0	13.5	
Vert	69.115	QP	48.0	6.5	7.2	30.4	-	31.3	40.0	8.7	
Vert	108.779	QP	48.8	11.4	7.5	30.2	-	37.5	43.5	6.0	
Vert	125.001	QP	50.2	13.3	7.6	30.1	-	41.0	43.5	2.5	
Vert	250.017	QP	47.3	11.7	8.5	29.3	-	38.2	46.0	7.8	
Vert	375.025	QP	41.6	15.1	9.3	29.6	-	36.4	46.0	9.6	
Vert	500.003	QP	41.2	17.7	9.8	30.0	-	38.7	46.0	7.3	
Vert	2483.500	PK	69.2	27.0	5.2	34.6	-	66.8	73.9	7.1	
Vert	4924.000	PK	55.0	31.5	7.5	33.8	-	60.2	73.9	13.7	
Vert	7386.000	PK	42.2	35.8	8.7	34.0	-	52.7	73.9	21.2	Floor noise
Vert	14772.000	PK	44.9	41.8	-0.4	32.6	-	53.7	73.9	20.2	
Vert	19696.000	PK	48.5	36.0	-1.7	32.4	-	50.4	73.9	23.5	
Vert	24620.000	PK	46.2	38.5	-0.7	32.7	-	51.3	73.9	22.6	
Vert	2483.500	AV	51.2	27.0	5.2	34.6	2.9	51.7	53.9	2.2	*1)
Vert	4924.000	AV	45.2	31.5	7.5	33.8	2.9	53.3	53.9	0.6	
Vert	7386.000	AV	34.0	35.8	8.7	34.0	-	44.5	53.9	9.4	Floor noise
Vert	14772.000	AV	39.0	41.8	-0.4	32.6	2.9	50.7	53.9	3.2	
Vert	19696.000	AV	42.1	36.0	-1.7	32.4	2.9	46.9	53.9	7.0	
Vert	24620.000	AV	38.6	38.5	-0.7	32.7	2.9	46.6	53.9	7.3	

Result = Reading + Ant Factor + Loss (Cable+Attenuator+Filter+Distance factor(above 1 GHz)) - Gain(Amplifier) + Duty factor

*Other frequency noises omitted in this report were not seen or had enough margin (more than 20 dB).

Distance factor: 1 GHz - 10 GHz 20log (3.75 m / 3.0 m) = 1.94 dB
10 GHz - 26.5 GHz 20log (1.0 m / 3.0 m) = -9.5 dB

*1) Not Out of Band emission(Leakage Power)

20dBc Data Sheet

Polarity	Frequency [MHz]	Detector	Reading [dBuV]	Ant Factor [dB/m]	Loss [dB]	Gain [dB]	Result [dBuV/m]	Limit [dBuV/m]	Margin [dB]	Remark
Hori	2462.000	PK	100.6	27.0	5.2	34.6	98.2	-	-	Carrier
Hori	9848.000	PK	45.0	38.2	9.4	34.5	58.1	78.2	20.1	
Vert	2462.000	PK	99.1	27.0	5.2	34.6	96.7	-	-	Carrier
Vert	9848.000	PK	42.2	38.2	9.4	34.5	55.3	76.7	21.4	

Result = Reading + Ant Factor + Loss (Cable+Attenuator+Filter+Distance factor(above 1 GHz)) - Gain(Amplifier)

Radiated Spurious Emission
(Reference Plot for band-edge)

Report No.	12862749H
Test place	Ise EMC Lab.
Semi Anechoic Chamber	No.2
Date	January 10, 2018
Temperature / Humidity	23 deg. C / 32 % RH
Engineer	Masafumi Niwa (1 GHz - 10 GHz)
Mode	Tx 11n-20 2462 MHz

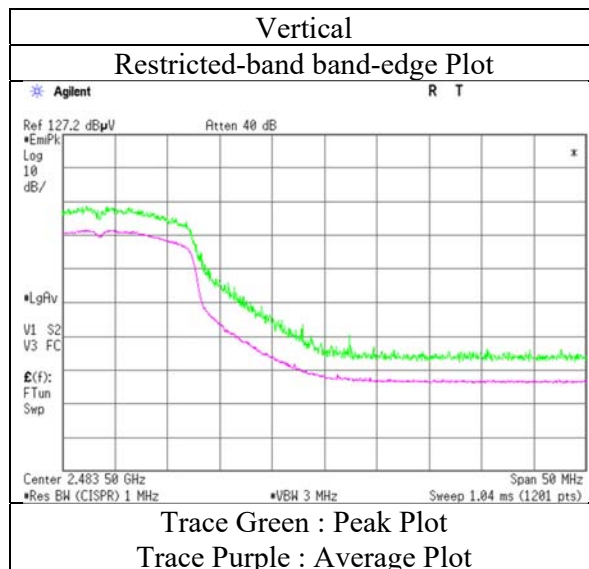
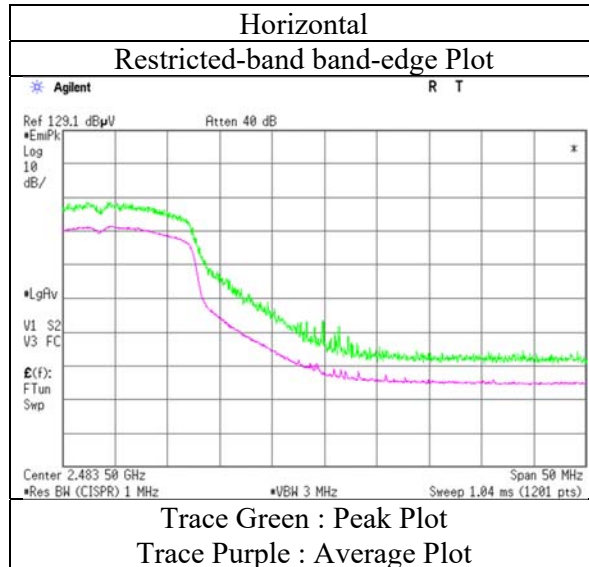

* Final result of restricted band edge was shown in tabular data.

Radiated Spurious Emission (Plot data, Worst case)

Report No.	12862749H		
Test place	Ise EMC Lab.		
Semi Anechoic Chamber	No.2	No.2	No.2
Date	January 10, 2018	January 11, 2018	January 12, 2018
Temperature / Humidity	23 deg. C / 32 % RH	23 deg. C / 35 % RH	21 deg. C / 31 % RH
Engineer	Masafumi Niwa (1 GHz - 10 GHz)	Masafumi Niwa (10 GHz - 26.5 GHz)	Masafumi Niwa (Below 1 GHz)
Mode	Tx 11n-20 2462 MHz		

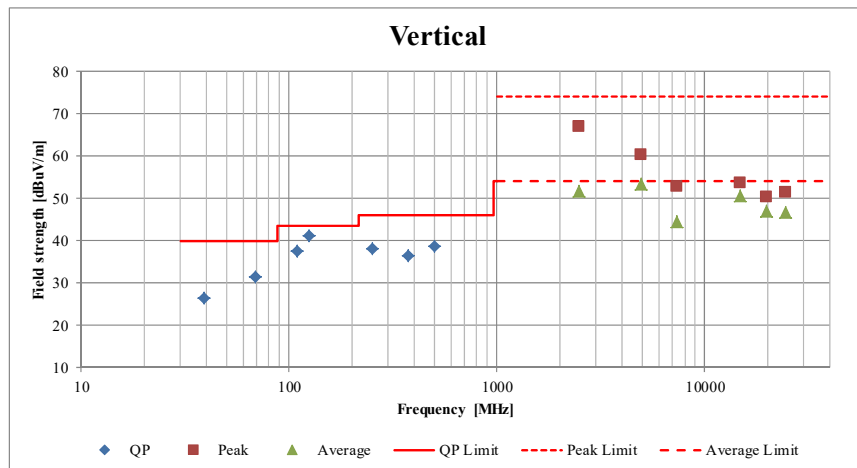
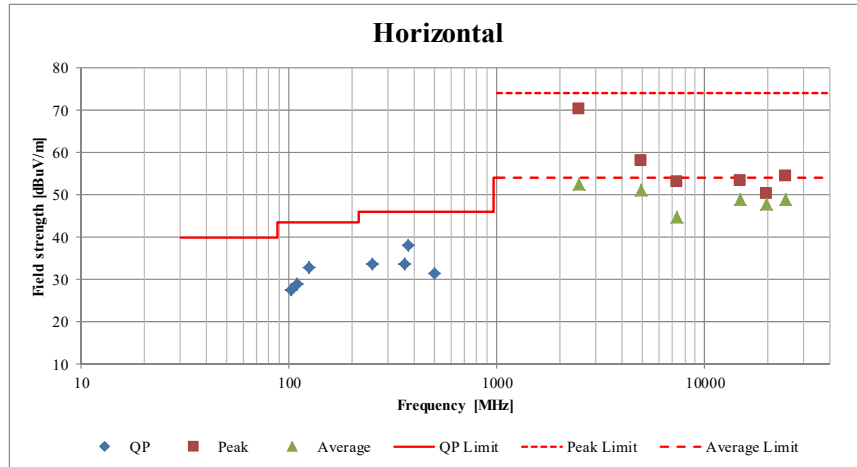

*These plots data contains sufficient number to show the trend of characteristic features for EUT.

Conducted Spurious Emission

Test place	Ise EMC Lab. No.11 Measurement Room
Report No.	12862749H
Date	December 13, 2017
Temperature / Humidity	22 deg. C / 30 % RH
Engineer	Ken Fujita
Mode	Tx 11n-20 2462 MHz

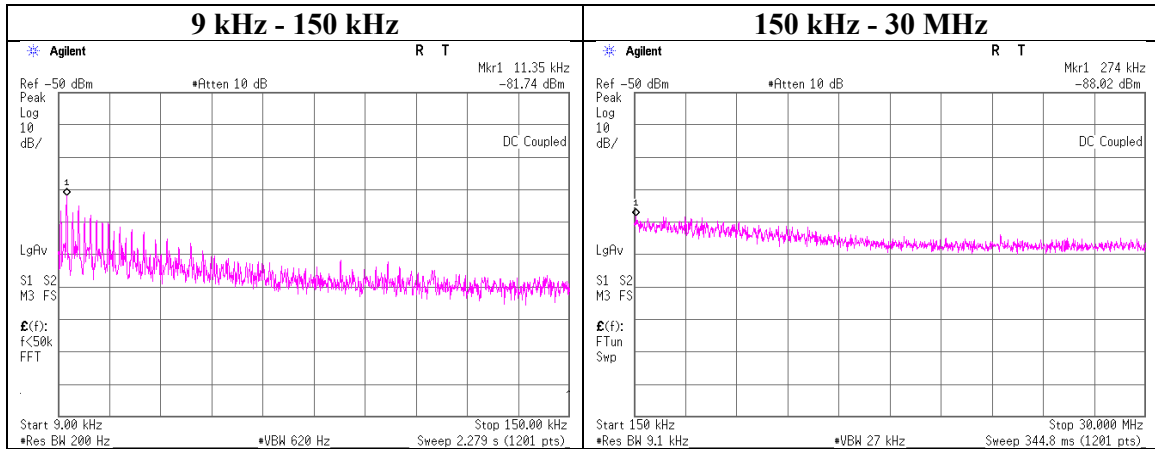

Frequency [kHz]	Reading [dBm]	Cable Loss [dB]	Attenuator Loss [dB]	Antenna Gain* [dBi]	N (Number of Output)	EIRP [dBm]	Distance [m]	Ground bounce [dB]	E (field strength) [dBuV/m]	Limit [dBuV/m]	Margin [dB]	Remark
11.35	-81.7	0.46	9.8	2.0	1	-69.5	300	6.0	-8.2	46.5	54.7	
274.00	-88.0	0.46	9.8	2.0	1	-75.7	300	6.0	-14.5	18.8	33.3	

$E \text{ [dBuV/m]} = \text{EIRP [dBm]} - 20 \log(\text{Distance [m]}) + \text{Ground bounce [dB]} + 104.8 \text{ [dBuV/m]}$

$\text{EIRP [dBm]} = \text{Reading [dBm]} + \text{Cable loss [dB]} + \text{Attenuator Loss [dB]} + \text{Antenna gain [dBi]} + 10 * \log(N)$

N: Number of output

*2.0 dBi was applied to the test result based on KDB 558074 since antenna gain was less than 2.0 dBi.

Power Density

Test place Ise EMC Lab. No.6 Measurement Room
Report No. 12862749H
Date January 15, 2018
Temperature / Humidity 24 deg. C / 30 % RH
Engineer Ken Fujita
Mode Tx

11b

Freq. [MHz]	Reading [dBm]	Cable Loss [dB]	Atten. Loss [dB]	Result [dBm]	Limit [dBm]	Margin [dB]
2412.00	-36.13	1.75	19.99	-14.39	8.00	22.39
2437.00	-34.75	1.76	19.99	-13.00	8.00	21.00
2462.00	-36.03	1.77	19.99	-14.27	8.00	22.27

11g

Freq. [MHz]	Reading [dBm]	Cable Loss [dB]	Atten. Loss [dB]	Result [dBm]	Limit [dBm]	Margin [dB]
2412.00	-35.79	1.75	19.99	-14.05	8.00	22.05
2437.00	-36.16	1.76	19.99	-14.41	8.00	22.41
2462.00	-35.96	1.77	19.99	-14.20	8.00	22.20

11n-20

Freq. [MHz]	Reading [dBm]	Cable Loss [dB]	Atten. Loss [dB]	Result [dBm]	Limit [dBm]	Margin [dB]
2412.00	-37.16	1.75	19.99	-15.42	8.00	23.42
2437.00	-36.51	1.76	19.99	-14.76	8.00	22.76
2462.00	-36.14	1.77	19.99	-14.38	8.00	22.38

Sample Calculation:

Result = Reading + Cable Loss (including the cable(s) customer supplied) + Attenuator Loss

*The equipment and cables were not used for factor 0 dB of the data sheets.

Power Density

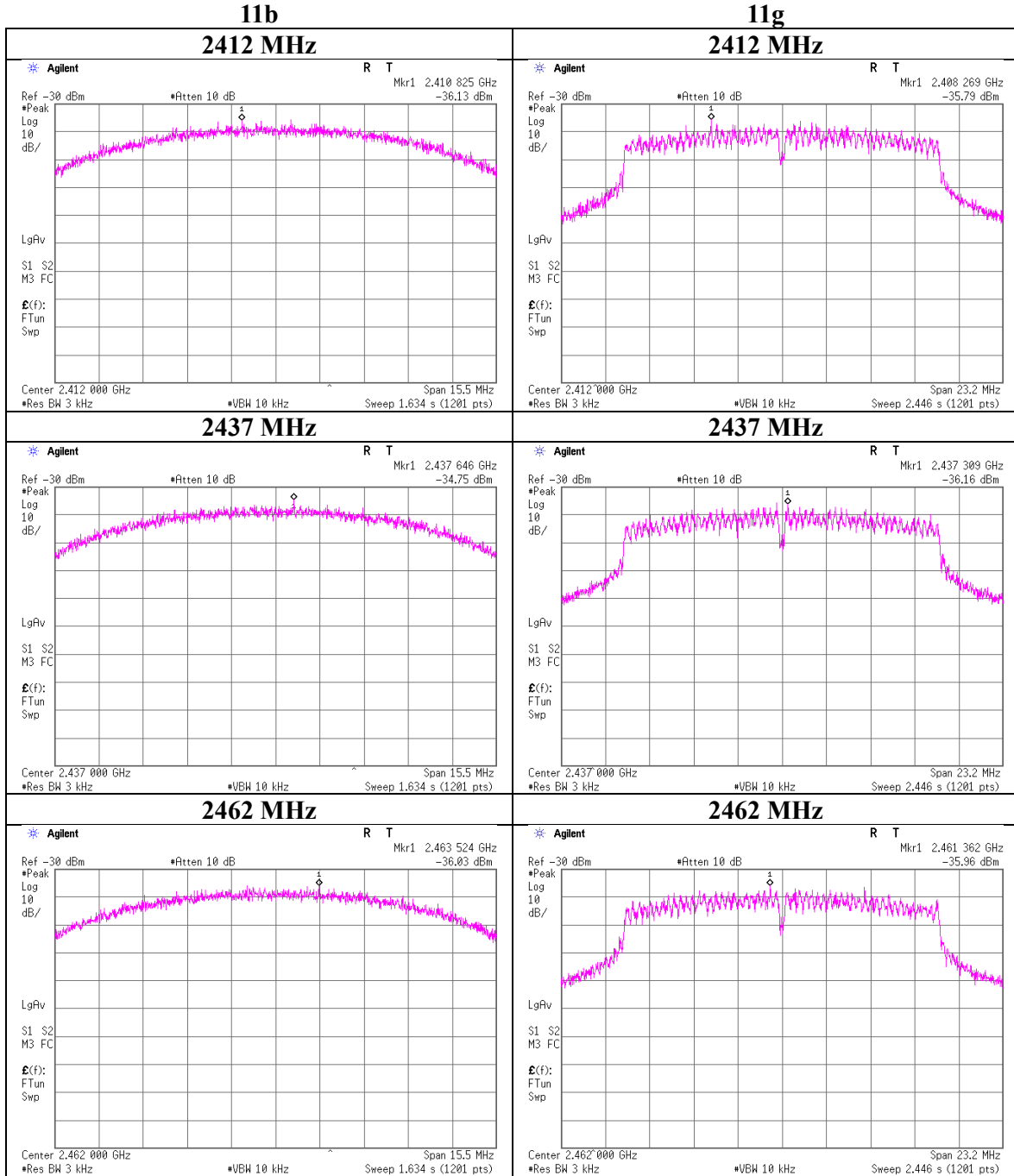

Power Density

11n-20

2412 MHz

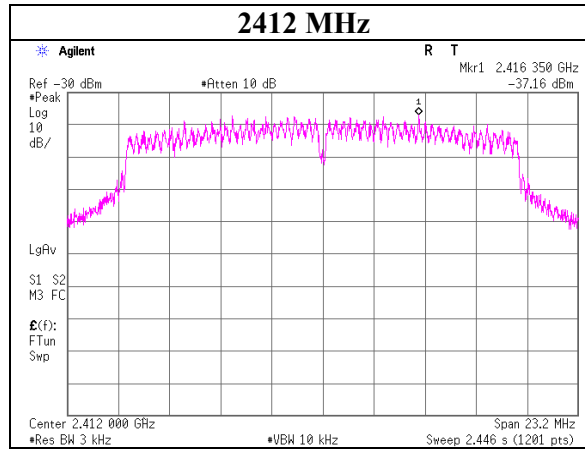

2437 MHz

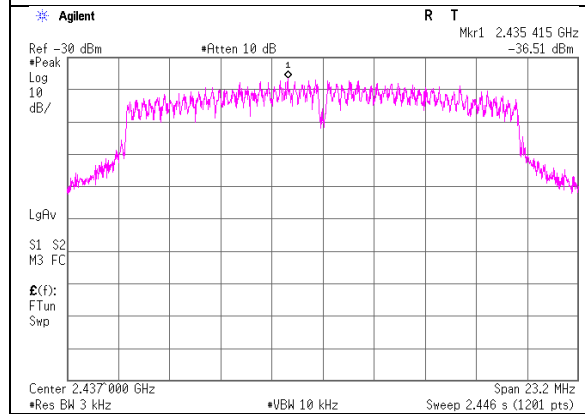

2462 MHz

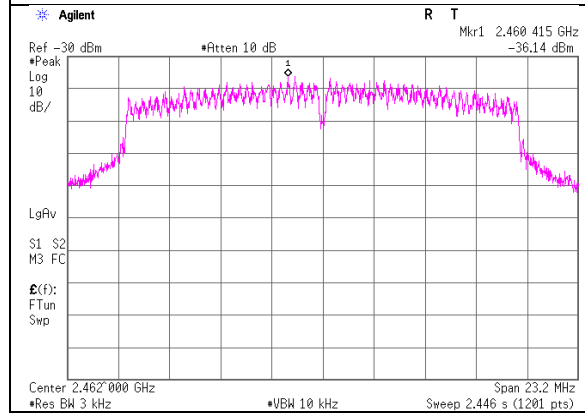

UL Japan, Inc.

Ise EMC Lab.

4383-326 Asama-cho, Ise-shi, Mie-ken 516-0021 JAPAN

Telephone : +81 596 24 8999

Facsimile : +81 596 24 8124

APPENDIX 2: Test instruments

Test Instruments

Control No.	Instrument	Manufacturer	Model No	Serial No	Test Item	Calibration Date * Interval(month)
MAEC-02	Semi Anechoic Chamber(NSA)	TDK	Semi Anechoic Chamber 3m	DA-06902	RE,CE	2017/08/31 * 12
MOS-22	Thermo-Hygrometer	Custom	CTH-201	0003	RE,CE	2017/12/21 * 12
MJM-14	Measure	KOMELON	KMC-36	-	RE,CE	-
COTS-MEMI	EMI measurement program	TSJ	TEPTO-DV	-	RE,CE	
MSA-03	Spectrum Analyzer	Agilent	E4448A	MY44020357	RE,CE	2017/11/07 * 12
MHA-06	Horn Antenna 1-18GHz	Schwarzbeck	BBHA9120D	254	RE	2017/02/24 * 12
MCC-216	Microwave Cable	Junkosha	MWX221	1604S253(1 m) / 1608S087(5 m)	RE	2017/08/04 * 12
MPA-10	Pre Amplifier	Agilent	8449B	3008A02142	RE	2017/01/16 * 12
MMM-01	Digital Tester	Fluke	FLUKE 26-3	78030611	RE,CE	2017/08/07 * 12
MHF-26	High Pass Filter 3.5-18.0GHz	UL Japan	HPF SELECTOR	002	RE	2017/09/11 * 12
MHA-16	Horn Antenna 15-40GHz	Schwarzbeck	BBHA9170	BBHA9170306	RE	2017/05/14 * 12
MTR-03	Test Receiver	Rohde & Schwarz	ESCI	100300	RE,CE	2017/08/21 * 12
MBA-08	Biconical Antenna	Schwarzbeck	VHA9103B	08031	RE	2017/09/13 * 12
MLA-21	Logperiodic Antenna(200-1000MHz)	Schwarzbeck	VUSLP9111B	911B-190	RE	2017/12/10 * 12
MCC-12	Coaxial Cable	Fujikura/Agilent	-	-	RE	2017/02/24 * 12
MAT-07	Attenuator(6dB)	Weinschel Corp	2	BK7970	RE	2017/11/14 * 12
MPA-09	Pre Amplifier	Agilent	8447D	2944A10845	RE	2017/09/27 * 12
MLS-23	LISN(AMN)	Schwarzbeck	NSLK8127	8127-729	CE(AE)	2017/07/24 * 12
MLS-24	LISN(AMN)	Schwarzbeck	NSLK8127	8127-730	CE(EUT)	2017/07/20 * 12
MTA-31	Terminator	TME	CT-01	-	CE	2017/12/11 * 12
MCC-13	Coaxial Cable	Fujikura	3D-2W(12m)/5D-2W(5m)/5D-2W(0.8m)/5D-2W(1m)	-	CE	2017/02/24 * 12
MAT-65	Attenuator(13dB)	JFW Industries, Inc.	50FP-013H2 N	-	CE	2017/12/19 * 12
MCC-138	Microwave cable	HUBER+SUHNER	SUCOFLEX 102	37953/2	AT	2017/10/06 * 12
MSA-16	Spectrum Analyzer	Agilent	E4440A	MY46186390	AT	2017/09/20 * 12
MPM-16	Power Meter	Agilent	8990B	MY51000271	AT	2017/04/28 * 12
MPSE-22	Power sensor	Agilent	N1923A	MY54070003	AT	2017/04/28 * 12
MAT-57	Attenuator(10dB)	Suhner	6810.19.A	-	AT	2017/12/04 * 12
MAT-10	Attenuator(10dB)	Weinschel Corp	2	BL1173	AT	2017/11/14 * 12
MAT-21	Attenuator(20dB)(above1G Hz)	HIROSE ELECTRIC CO.,LTD.	AT-120	901247	AT	2017/12/04 * 12
MCC-144	Microwave Cable	Junkosha	MWX221	1207S407	AT	2017/08/02 * 12
MOS-19	Thermo-Hygrometer	Custom	CTH-201	0001	AT	2017/12/21 * 12
MMM-17	DIGITAL HiTESTER	Hioki	3805	070900530	AT	2018/01/15 * 12

The expiration date of the calibration is the end of the expired month.

All equipment is calibrated with valid calibrations. Each measurement data is traceable to the national or international standards.

As for some calibrations performed after the tested dates, those test equipment have been controlled by means of an unbroken chains of calibrations.

Test item: CE: Conducted Emission test
RE: Radiated Emission test
AT: Antenna Terminal Conducted test

UL Japan, Inc.
Ise EMC Lab.

4383-326 Asama-cho, Ise-shi, Mie-ken 516-0021 JAPAN
Telephone : +81 596 24 8999
Facsimile : +81 596 24 8124