



# SAR TEST REPORT

**Test Report No. : 12171581H-A-R1**

**Applicant : Murata Manufacturing Co., Ltd.**

**Type of Equipment : Communication Module**

**Model No. : 1MW**

**FCC ID : VPYLB1MW**

**Test regulation : FCC47CFR 2.1093  
For Permissive Change**

**Test Result : Complied**

**Reported SAR(1g) Value : The highest reported SAR(1g)  
Body : 1.06 W/kg**

1. This test report shall not be reproduced in full or partial, without the written approval of UL Japan, Inc.
2. The results in this report apply only to the sample tested.
3. This sample tested is in compliance with the limits of the above regulation.
4. The test results in this report are traceable to the national or international standards.
5. This test report covers SAR technical requirements. It does not cover administrative issues such as Manual or non-SAR test related Requirements. (if applicable)
6. The all test items in this test report are conducted by UL Japan, Inc. Ise EMC Lab.
7. This test report must not be used by the customer to claim product certification, approval, or endorsement by NVLAP, NIST, or any agency of the Federal Government.
8. This report is a revised version of 12171581H-A. 12171581H-A is replaced with this report.

**Date of test:** March 5 to 21, 2018

**Representative test engineer:** T. Nakagawa

Tomohisa Nakagawa  
Engineer

Consumer Technology Division

**Approved by :** Takayuki Shimada

Takayuki Shimada  
Leader

Consumer Technology Division



This laboratory is accredited by the NVLAP LAB CODE 200572-0, U.S.A. The tests reported herein have been performed in accordance with its terms of accreditation. \*As for the range of Accreditation in NVLAP, you may refer to the WEB address, [http://japan.ul.com/resources/emc\\_accredited/](http://japan.ul.com/resources/emc_accredited/)

- The testing in which "Non-accreditation" is displayed is outside the accreditation scopes in UL Japan.  
 There is no testing item of "Non-accreditation".



<b>CONTENTS</b>	<b>PAGE</b>
<b>SECTION1: Customer information.....</b>	<b>4</b>
<b>SECTION2: Equipment under test (E.U.T.).....</b>	<b>4</b>
2.1 Identification of E.U.T.....	4
2.2 Product description .....	4
<b>SECTION3: Test standard information.....</b>	<b>6</b>
3.1 Test Specification .....	6
3.2 Procedure .....	6
3.3 Exposure limit.....	7
3.4 SAR .....	7
3.5 Test Location .....	7
<b>SECTION4: Test result.....</b>	<b>8</b>
4.1 Stand-alone SAR result.....	8
4.2 Simultaneous transmission SAR result.....	8
<b>SECTION5: Tune-up tolerance information and software information.....</b>	<b>9</b>
<b>SECTION6: RF Exposure Conditions (Test Configurations).....</b>	<b>11</b>
6.1 Summary of the distance between antenna and surface of EUT .....	11
6.2 SAR test exclusion considerations according to KDB447498 D01 .....	11
6.3 SAR test exclusion considerations according to KDB UMPC .....	15
<b>SECTION7: Description of the Body setup .....</b>	<b>16</b>
7.1 Procedure for SAR test position determination .....	16
7.2 Test position for Body setup.....	16
<b>SECTION8: Description of the operating mode.....</b>	<b>17</b>
8.1 Output Power and SAR test required.....	17
8.2 Correlation of Output Power.....	21
<b>SECTION9: Test surrounding .....</b>	<b>22</b>
9.1 Measurement uncertainty.....	22
<b>SECTION10: Parameter Check.....</b>	<b>24</b>
10.1 For SAR system Check.....	24
10.2 For SAR measurement.....	26
<b>SECTION11: System Check confirmation.....</b>	<b>27</b>
<b>SECTION12: Measured and Reported (Scaled) SAR Results .....</b>	<b>28</b>
12.1 WLAN 2.4GHz Band .....	30
12.2 Bluetooth .....	31
12.3 WLAN 5.3GHz Band .....	31
12.4 WLAN 5.5GHz Band .....	32
12.5 WLAN 5.8GHz Band .....	32
12.6 Repeated measurement .....	33
<b>SECTION13: Test instruments .....</b>	<b>34</b>
<b>APPENDIX 1 : System Check.....</b>	<b>35</b>
<b>APPENDIX 2 : SAR Measurement data .....</b>	<b>47</b>
<b>APPENDIX 3 : System specifications.....</b>	<b>56</b>
<b>APPENDIX 4 : Photographs of test setup.....</b>	<b>163</b>

## **SECTION1: Customer information**

Company Name : Murata Manufacturing Co., Ltd.  
Address : 1-10-1 Higashikotari, Nagaokakyo-shi, Kyoto 617-8555 Japan  
Contact Person : Motoo Hayashi  
Telephone Number : +81-75-955-6736  
Facsimile Number : +81-75-955-6634

## **SECTION2: Equipment under test (E.U.T.)**

### **2.1 Identification of E.U.T.**

#### **<Information of the EUT>**

Type of Equipment : Communication Module  
Model No. : 1MW  
Serial No. : 62  
Rating : VBAT: Min. 3.35 V / Typ. 3.6 V / Max. 4.2 V  
VIO: 1.8 V / 3.3 V  
\*VIO doesn't influence the RF characteristic.  
Receipt Date of Sample : February 26, 2018  
Country of Mass-production : China, Japan  
Condition of EUT : Engineering prototype  
(Not for Sale: This sample is equivalent to mass-produced items.)  
Modification of EUT : No Modification by the test lab

### **2.2 Product description**

Model: 1MW (referred to as the EUT in this report) is a Communication Module.

## Radio Specification

Radio Type : Transceiver  
Power Supply (radio part input) : DC 3.3 V  
Operating Temperature : -20 deg. C to +75 deg. C

### Specification of Wireless LAN (IEEE802.11b/g/a/n-20/n-40/11ac-20/11ac-40/11ac-80)

Type of radio	IEEE802.11b	IEEE802.11g/n (20 M band)	IEEE802.11a/n/ac (20 M band)	IEEE802.11n/ac (40 M band)	IEEE802.11ac (80 M band)
Frequency of operation	2412 MHz - 2462 MHz	2412 MHz - 2462 MHz	5180 MHz - 5240 MHz 5260 MHz - 5320 MHz 5500 MHz - 5720 MHz 5745 MHz - 5825 MHz	5190 MHz - 5230 MHz 5270 MHz - 5310 MHz 5510 MHz - 5710 MHz 5755 MHz - 5795 MHz	5210 MHz 5290 MHz 5530 MHz - 5690 MHz 5775 MHz
Type of modulation	DSSS (CCK, DQPSK, DBPSK)	OFDM-CCK (64QAM, 16QAM, QPSK, BPSK)	OFDM (64QAM, 16QAM, QPSK, BPSK, 256QAM(IEEE802.11ac only))		
Channel spacing	5 MHz		20 MHz	40 MHz	80 MHz
Antenna type	Monopole pattern antenna				
Antenna Gain	[RF Cable 30 mm] 2.4 GHz: 0 dBi 5 GHz: 1.5dBi [RF Cable 300 mm] 2.4 GHz: -1.3 dBi 5 GHz: -1.8 dBi				
Receiver category	Category 1				

### Specification of Bluetooth (Ver. 4.2 with EDR function)

	Bluetooth Ver.4.2 with EDR function
Frequency of operation	2402 MHz - 2480 MHz
Type of modulation	BT: FHSS (GFSK, $\pi/4$ DQPSK, 8DPSK) LE: GFSK
Channel spacing	BT: 1 MHz LE: 2 MHz
Antenna type	Monopole pattern antenna
Antenna Gain	[RF Cable 30 mm] 2.4 GHz: 0 dBi [RF Cable 300 mm] 2.4 GHz: -1.3 dBi

\* WLAN and Bluetooth do not transmit simultaneously.

The following frequencies are not used in this Digital Camera (Host).

- 5600 MHz – 5650 MHz
- 5720 MHz (11a, 11-n20, 11ac-20)
- 5710MHz (11n-40, 11ac-40)
- 5690MHz (11ac-80)

**SECTION3: Test standard information**

**3.1 Test Specification**

Title : **FCC47CFR 2.1093**  
Radiofrequency radiation exposure evaluation: portable devices.  
: **IEEE Std 1528-2013:**  
IEEE Recommended Practice for Determining the Peak Spatial-Average Specific Absorption Rate (SAR) in the Human Head from Wireless Communications Devices: Measurement Techniques.

: **Published RF exposure KDB procedures**

- KDB447498D01(v06)** RF Exposure Procedures and Equipment Authorization Policies for Mobile and Portable Devices
- KDB447498D02(v02r01)** SAR Measurement Procedures for USB Dongle Transmitters
- KDB648474D04(v01r03)** SAR Evaluation Considerations for Wireless Handsets
- KDB941225D01(v03r01)** 3G SAR Measurement Procedures
- KDB941225D05(v02r05)** SAR Evaluation Considerations for LTE Devices
- KDB941225D06(v02r01)** SAR Evaluation Procedures for Portable Devices with Wireless Router Capabilities (Hot Spot SAR)
- KDB941225D07(v01r02)** SAR Evaluation Procedures for UMPC Mini-Tablet Devices
- KDB616217D04(v01r02)** SAR Evaluation Considerations for Laptop, Notebook, Netbook and Tablet Computers
- KDB865664D01(v01r04)** SAR Measurement Requirements for 100MHz to 6 GHz
- KDB248227D01(v02r02)** SAR Guidance for 802.11(Wi-Fi) Transmitters

**Reference**

[1]SPEAG uncertainty document (AN 15-7/AN19-17) for DASY 5 System from SPEAG (Schmid & Partner Engineering AG).

**3.2 Procedure**

Transmitter	WLAN and Bluetooth
Test Procedure	Published RF exposure KDB procedures
Category	FCC47CFR 2.1093
Note: UL Japan, Inc. 's SAR Work Procedures 13-EM-W0429 and 13-EM-W0430	

This EUT operates only with the specified Digital Camera.  
Therefore the test was performed with the Digital Camera (Host) in which the distance to the exterior surface is shortest.

### 3.3 Exposure limit

(A) Limits for Occupational/Controlled Exposure (W/kg)

Spatial Average (averaged over the whole body)	Spatial Peak (averaged over any 1g of tissue)	Spatial Peak (hands/wrists/feet/ankles averaged over 10g)
0.4	8.0	20.0

(B) Limits for General population/Uncontrolled Exposure (W/kg)

Spatial Average (averaged over the whole body)	Spatial Peak (averaged over any 1g of tissue)	Spatial Peak (hands/wrists/feet/ankles averaged over 10g)
0.08	1.6	4.0

**Occupational/Controlled Environments:** are defined as locations where there is exposure that may be incurred by people who are aware of the potential for exposure, (i.e. as a result of employment or occupation).

**General Population/Uncontrolled Environments:** are defined as locations where there is the exposure of individuals who have no knowledge or control of their exposure.

**NOTE:GENERAL POPULATION/UNCONTROLLED EXPOSURE  
SPATIAL PEAK(averaged over any 1g of tissue) LIMIT  
1.6 W/kg**

### 3.4 SAR

Specific Absorption Rate (SAR): The time derivative (rate) of the incremental energy (dW) absorbed by (dissipated in) an incremental mass (dm) contained in a volume element (dV) of a given density ( $\rho$ ), as shown in the following equation:

$$SAR = \frac{d}{dt} \left( \frac{dW}{dm} \right) = \frac{d}{dt} \left( \frac{dW}{\rho dV} \right)$$

SAR is expressed in units of watts per kilogram (W/kg) or equivalently milliwatts per gram (mW/g).

SAR is related to the E-field at a point by the following equation:

$$SAR = \frac{\sigma |E|^2}{\rho}$$

where

$\sigma$  = conductivity of the tissue (S/m)

$\rho$  = mass density of the tissue (kg/m<sup>3</sup>)

E = rms E-field strength (V/m)

### 3.5 Test Location

\*Shielded room for SAR testings

NVLAP Lab. code: 200572-0 / FCC Test Firm Registration Number: 199967 / ISED SAR Lab Company Number: 2973C

4383-326 Asama-cho, Ise-shi, Mie-ken 516-0021 JAPAN

Telephone : +81 596 24 8999

Facsimile : +81 596 24 8124

**UL Japan, Inc.**

**Ise EMC Lab.**

4383-326 Asama-cho, Ise-shi, Mie-ken 516-0021 JAPAN

Telephone: +81 596 24 8999

Facsimile: +81 596 24 8124

## **SECTION4: Test result**

### **4.1 Stand-alone SAR result**

#### **Reported SAR**

Measured SAR is scaled to the maximum tune-up tolerance limit by the following formulas.

Reported SAR= Measured SAR [W/kg] · Scaled factor

Maximum tune-up tolerance limit is by the specification from a customer.

\* Scaled factor = Maximum tune-up tolerance limit [mW] / Measured power [mW]

#### **Body SAR**

Mode	Frequency [MHz]	Tune-up upper Power [dBm]	Measured average Power [dBm]	Maximum tune-up tolerance limit [mW]	Measured power [mW]	Scaled factor	Measured SAR [W/kg]	Reported SAR [W/kg]
802.11b	2412	13.00	12.63	19.95	18.32	1.089	0.896	0.976
BT	2402	7.50	6.75	5.62	4.73	1.189	0.280	0.333
802.11n40	5310	12.00	10.77	15.85	11.94	1.327	0.800	1.062
802.11ac80	5530	9.00	8.45	7.94	7.00	1.135	0.598	0.679
802.11ac80	5775	9.00	8.34	7.94	6.82	1.164	0.866	1.008

#### **Note(s):**

The sample used by the SAR test is not more than 2 dB lower than the maximum tune-up tolerance limit. That is, measured power is included the tune-up tolerance range.

### **4.2 Simultaneous transmission SAR result**

Wireless LAN and Bluetooth do not transmit simultaneously.



**SECTION5: Tune-up tolerance information and software information**

Maximum tune-up tolerance limit

Mode	Maximum frequency in each band	Maximum tune-up tolerance limit	
		[dBm]	[mW]
WLAN 11b	2462	13.00	19.95
WLAN 11g	2462	13.00	19.95
WLAN 11n	2462	13.00	19.95
BT	2480	7.50	5.62
BT LE	2480	6.00	3.98
WLAN 11a	5320	12.00	15.85
WLAN 11a	5700	9.00	7.94
WLAN 11a	5825	9.00	7.94
WLAN 11n-20	5320	12.00	15.85
WLAN 11n-20	5700	9.00	7.94
WLAN 11n-20	5825	9.00	7.94
WLAN 11n-40	5310	12.00	15.85
WLAN 11n-40	5670	9.00	7.94
WLAN 11n-40	5795	9.00	7.94
WLAN 11ac-20	5320	12.00	15.85
WLAN 11ac-20	5700	9.00	7.94
WLAN 11ac-20	5825	9.00	7.94
WLAN 11ac-40	5310	12.00	15.85
WLAN 11ac-40	5670	9.00	7.94
WLAN 11ac-40	5795	9.00	7.94
WLAN 11ac-80	5290	11.00	12.59
WLAN 11ac-80	5530	9.00	7.94
WLAN 11ac-80	5775	9.00	7.94

Maximum tune-up tolerance limit is defined by a customer as duty100%.

**Software setting**

\*The power value of the EUT was set for testing as follows (setting value might be different from product specification value);  
[WLAN2.4GHz / 5GHz]  
Power settings: Refer to the following Power Setting table  
Software: WLAN: MFG Tool Version 7.45.0.0 (for WLAN 2.4 GHz)  
MFG Tool Version 7.45.0.0 (for WLAN 5 GHz)

[BT / BTLE]  
Power settings: Config:0218  
Software: Bluetool 1.8.9.3

\*This setting of software is the worst case.  
The test was performed with condition that obtained the maximum average power in pre-check.  
Any conditions under the normal use do not exceed the condition of setting.  
In addition, end users cannot change the settings of the output power of the product.

**[Power setting]**

Mode	Frequency	Power Setting
11b	2412 to 2462 MHz	13.0
11g	2412 to 2462 MHz	12.0
11n	2412 to 2462 MHz	12.0
11a	5180 to 5320MHz (20MHz),	12.0
	5500 to 5700MHz (20MHz)	9.0
	5745 to 5825MHz (20MHz)	9.0
11n-20	5180 to 5320MHz (20MHz),	12.0
	5500 to 5700MHz (20MHz)	9.0
	5745 to 5825MHz (20MHz)	9.0
11ac-20	5180 to 5320MHz (20MHz),	12.0
	5500 to 5700MHz (20MHz)	9.0
	5745 to 5825MHz (20MHz)	9.0
11n-40	5190 to 5310MHz (40MHz),	12.0
	5510 to 5670MHz (40MHz)	9.0
	5755 to 5795MHz (40MHz)	9.0
11ac-40	5190 to 5310MHz (40MHz),	12.0
	5510 to 5670MHz (40MHz)	9.0
	5755 to 5795MHz (40MHz)	9.0
11ac-80	5210 to 5290MHz (80MHz),	11.0
	5530MHz (80MHz)	9.0
	5775MHz (80MHz)	9.0

Duty Confirmation for Bluetooth

**DHS**

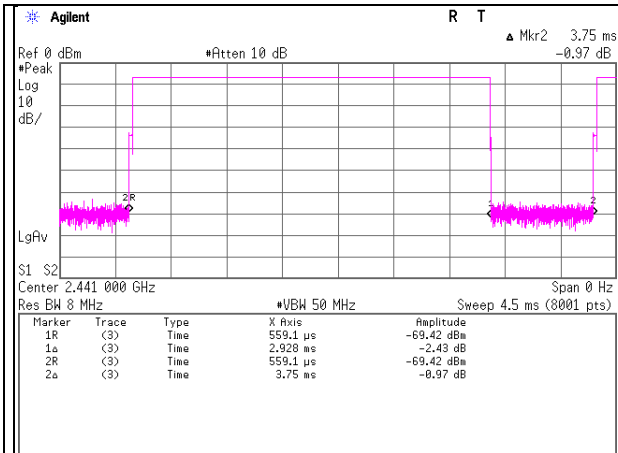

## **SECTION6: RF Exposure Conditions (Test Configurations)**

### **6.1 Summary of the distance between antenna and surface of EUT**

Position	D [mm]
Front	12.00
Rear	22.10
Right	125.70
Left	1.00
Top	73.90
Bottom	5.00

\*Details are shown in appendix 4

### **6.2 SAR test exclusion considerations according to KDB447498 D01**

The following is based on KDB447498D01.

1) The 1-g and 10-g SAR test exclusion thresholds for 100 MHz to 6 GHz at test separation distances  $\leq 50$  mm are determined by:

$[(\text{max. power of channel, including tune-up tolerance, mW})/(\text{min. test separation distance, mm})] \cdot [\sqrt{f}(\text{GHz})] \leq 3.0$   
for 1-g SAR and  $\leq 7.5$  for 10-g extremity SAR

1. The upper frequency of the frequency band was used in order to calculate standalone SAR test exclusion considerations.
2. Power and distance are rounded to the nearest mW and mm before calculation
3. The result is rounded to one decimal place for comparison
4. The test exclusions are applicable only when the minimum test separation distance is  $\leq 50$  mm and for transmission frequencies between 100 MHz and 6 GHz. When the minimum test separation distance is  $< 5$  mm, a distance of 5 mm is applied to determine SAR test exclusion. When the separation of antenna to EUT's surfaces and edges are  $\leq 50$  mm, the separation distance used for the SAR exclusion calculations is 5 mm.
5. "N/A" displayed on below exclusion calculation means not applicable this formula since distance between antenna and surface is  $> 50$  mm.

When the calculated threshold value by a numerical formula above-mentioned in the following table is 3.0 or less, SAR test is excluded.

2.4GHz

SAR exclusion calculations for antenna >50mm from the user

Antenna	Tx Interface	Frequency (MHz)	Output Power		Calculated Threshold Value					
			dBm	mW	Front	Rear	Right	Left	Top	Bottom
Main	WLAN 11b	2462	13.00	20	N/A	N/A	852.6 mW -EXEMPT-	N/A	334.6 mW -EXEMPT-	N/A
Main	WLAN 11g	2462	13.00	20	N/A	N/A	852.6 mW -EXEMPT-	N/A	334.6 mW -EXEMPT-	N/A
Main	WLAN 11n	2462	13.00	20	N/A	N/A	852.6 mW -EXEMPT-	N/A	334.6 mW -EXEMPT-	N/A
Main	BT DH5	2480	7.50	6	N/A	N/A	852.3 mW -EXEMPT-	N/A	334.3 mW -EXEMPT-	N/A
Main	BT LE	2480	6.00	4	N/A	N/A	852.3 mW -EXEMPT-	N/A	334.3 mW -EXEMPT-	N/A

WLAN 11a 11n 5GHz

SAR exclusion calculations for antenna >50mm from the user

Antenna	Tx Interface	Frequency (MHz)	Output Power		Calculated Threshold Value					
			dBm	mW	Front	Rear	Right	Left	Top	Bottom
Main	WLAN 11a	5320	12.00	16	N/A	N/A	822 mW -EXEMPT-	N/A	304 mW -EXEMPT-	N/A
Main	WLAN 11a	5700	9.00	8	N/A	N/A	819.8 mW -EXEMPT-	N/A	301.8 mW -EXEMPT-	N/A
Main	WLAN 11a	5825	9.00	8	N/A	N/A	819.2 mW -EXEMPT-	N/A	301.2 mW -EXEMPT-	N/A
Main	WLAN 11n20	5320	12.00	16	N/A	N/A	822 mW -EXEMPT-	N/A	304 mW -EXEMPT-	N/A
Main	WLAN 11n20	5700	9.00	8	N/A	N/A	819.8 mW -EXEMPT-	N/A	301.8 mW -EXEMPT-	N/A
Main	WLAN 11n20	5825	9.00	8	N/A	N/A	819.2 mW -EXEMPT-	N/A	301.2 mW -EXEMPT-	N/A
Main	WLAN 11n40	5310	12.00	16	N/A	N/A	822.1 mW -EXEMPT-	N/A	304.1 mW -EXEMPT-	N/A
Main	WLAN 11n40	5670	9.00	8	N/A	N/A	820 mW -EXEMPT-	N/A	302 mW -EXEMPT-	N/A
Main	WLAN 11n40	5795	9.00	8	N/A	N/A	819.3 mW -EXEMPT-	N/A	301.3 mW -EXEMPT-	N/A

11ac 5GHz

SAR exclusion calculations for antenna >50mm from the user

Antenna	Tx Interface	Frequency (MHz)	Output Power		Calculated Threshold Value					
			dBm	mW	Front	Rear	Right	Left	Top	Bottom
Main	WLAN 11ac20	5320	12.00	16	N/A	N/A	822 mW -EXEMPT-	N/A	304 mW -EXEMPT-	N/A
Main	WLAN 11ac20	5700	9.00	8	N/A	N/A	819.8 mW -EXEMPT-	N/A	301.8 mW -EXEMPT-	N/A
Main	WLAN 11ac20	5825	9.00	8	N/A	N/A	819.2 mW -EXEMPT-	N/A	301.2 mW -EXEMPT-	N/A
Main	WLAN 11ac40	5310	12.00	16	N/A	N/A	822.1 mW -EXEMPT-	N/A	304.1 mW -EXEMPT-	N/A
Main	WLAN 11ac40	5670	9.00	8	N/A	N/A	820 mW -EXEMPT-	N/A	302 mW -EXEMPT-	N/A
Main	WLAN 11ac40	5795	9.00	8	N/A	N/A	819.3 mW -EXEMPT-	N/A	301.3 mW -EXEMPT-	N/A
Main	WLAN 11ac80	5290	11.00	13	N/A	N/A	822.2 mW -EXEMPT-	N/A	304.2 mW -EXEMPT-	N/A
Main	WLAN 11ac80	5530	9.00	8	N/A	N/A	820.8 mW -EXEMPT-	N/A	302.8 mW -EXEMPT-	N/A
Main	WLAN 11ac80	5775	9.00	8	N/A	N/A	819.4 mW -EXEMPT-	N/A	301.4 mW -EXEMPT-	N/A

2) At 100 MHz to 6 GHz and for test separation distances > 50 mm, the SAR test exclusion threshold is determined according to the following.

- a)  $[(3 \cdot 50) / (\sqrt{f(\text{GHz})})] + (\text{test separation distance} - 50 \text{ mm}) \cdot (f(\text{MHz}) / 150) \text{ mW}$  at > 100 MHz and ≤ 1500 MHz  
b)  $[(3 \cdot 50) / (\sqrt{f(\text{GHz})})] + (\text{test separation distance} - 50 \text{ mm}) \cdot 10 \text{ mW}$  at > 1500 MHz and ≤ 6 GHz

1. The upper frequency of the frequency band was used in order to calculate standalone SAR test exclusion considerations.
2. Power and distance are rounded to the nearest mW and mm before calculation
3. “N/A” displayed on below exclusion calculation means not applicable this formula since distance between antenna and surface is < 50 mm.

When output power is less than the calculated threshold value by a numerical formula above-mentioned in the following table, SAR test is excluded.

#### 2.4GHz

##### SAR exclusion calculations for antenna <50mm from the user

Antenna	Tx Interface	Frequency (MHz)	Output Power		Calculated Threshold Value					
			dBm	mW	Front	Rear	Right	Left	Top	Bottom
Main	WLAN 11b	2462	13.00	20	2.6 -EXEMPT-	1.4 -EXEMPT-	N/A	6.3 -MEASURE-	N/A	6.3 -MEASURE-
Main	WLAN 11g	2462	13.00	20	2.6 -EXEMPT-	1.4 -EXEMPT-	N/A	6.3 -MEASURE-	N/A	6.3 -MEASURE-
Main	WLAN 11n	2462	13.00	20	2.6 -EXEMPT-	1.4 -EXEMPT-	N/A	6.3 -MEASURE-	N/A	6.3 -MEASURE-
Main	BT	2480	7.50	6	0.7 -EXEMPT-	0.4 -EXEMPT-	N/A	1.8 -EXEMPT-	N/A	1.8 -EXEMPT-
Main	BT LE	2480	6.00	4	0.5 -EXEMPT-	0.3 -EXEMPT-	N/A	1.3 -EXEMPT-	N/A	1.3 -EXEMPT-

#### WLAN 11a 11n 5GHz

##### SAR exclusion calculations for antenna <50mm from the user

Antenna	Tx Interface	Frequency (MHz)	Output Power		Calculated Threshold Value					
			dBm	mW	Front	Rear	Right	Left	Top	Bottom
Main	WLAN 11a	5320	12.00	16	3 -MEASURE-	1.7 -EXEMPT-	N/A	7.3 -MEASURE-	N/A	7.3 -MEASURE-
Main	WLAN 11a	5700	9.00	8	1.6 -EXEMPT-	0.9 -EXEMPT-	N/A	3.8 -MEASURE-	N/A	3.8 -MEASURE-
Main	WLAN 11a	5825	9.00	8	1.6 -EXEMPT-	0.9 -EXEMPT-	N/A	3.8 -MEASURE-	N/A	3.8 -MEASURE-
Main	WLAN 11n20	5320	12.00	16	3 -MEASURE-	1.7 -EXEMPT-	N/A	7.3 -MEASURE-	N/A	7.3 -MEASURE-
Main	WLAN 11n20	5700	9.00	8	1.6 -EXEMPT-	0.9 -EXEMPT-	N/A	3.8 -MEASURE-	N/A	3.8 -MEASURE-
Main	WLAN 11n20	5825	9.00	8	1.6 -EXEMPT-	0.9 -EXEMPT-	N/A	3.8 -MEASURE-	N/A	3.8 -MEASURE-
Main	WLAN 11n40	5310	12.00	16	3 -MEASURE-	1.7 -EXEMPT-	N/A	7.3 -MEASURE-	N/A	7.3 -MEASURE-
Main	WLAN 11n40	5670	9.00	8	1.6 -EXEMPT-	0.9 -EXEMPT-	N/A	3.8 -MEASURE-	N/A	3.8 -MEASURE-
Main	WLAN 11n40	5795	9.00	8	1.6 -EXEMPT-	0.9 -EXEMPT-	N/A	3.8 -MEASURE-	N/A	3.8 -MEASURE-

11ac 5GHz

SAR exclusion calculations for antenna <50mm from the user

Antenna	Tx Interface	Frequency (MHz)	Output Power		Calculated Threshold Value					
			dBm	mW	Front	Rear	Right	Left	Top	Bottom
Main	WLAN 11ac20	5320	12.00	16	3 -MEASURE-	1.7 -EXEMPT-	N/A	7.3 -MEASURE-	N/A	7.3 -MEASURE-
Main	WLAN 11ac20	5700	9.00	8	1.6 -EXEMPT-	0.9 -EXEMPT-	N/A	3.8 -MEASURE-	N/A	3.8 -MEASURE-
Main	WLAN 11ac20	5825	9.00	8	1.6 -EXEMPT-	0.9 -EXEMPT-	N/A	3.8 -MEASURE-	N/A	3.8 -MEASURE-
Main	WLAN 11ac40	5310	12.00	16	3 -MEASURE-	1.7 -EXEMPT-	N/A	7.3 -MEASURE-	N/A	7.3 -MEASURE-
Main	WLAN 11ac40	5670	9.00	8	1.6 -EXEMPT-	0.9 -EXEMPT-	N/A	3.8 -MEASURE-	N/A	3.8 -MEASURE-
Main	WLAN 11ac40	5795	9.00	8	1.6 -EXEMPT-	0.9 -EXEMPT-	N/A	3.8 -MEASURE-	N/A	3.8 -MEASURE-
Main	WLAN 11ac80	5290	11.00	13	2.4 -EXEMPT-	1.3 -EXEMPT-	N/A	5.8 -MEASURE-	N/A	5.8 -MEASURE-
Main	WLAN 11ac80	5530	9.00	8	1.6 -EXEMPT-	0.8 -EXEMPT-	N/A	3.7 -MEASURE-	N/A	3.7 -MEASURE-
Main	WLAN 11ac80	5775	9.00	8	1.6 -EXEMPT-	0.9 -EXEMPT-	N/A	3.8 -MEASURE-	N/A	3.8 -MEASURE-

### 6.3 SAR test exclusion considerations according to KDB UMPC

Based on KDB941225D07, UMPC mini-tablet devices must be tested for 1-g SAR on all surfaces and side edges with a transmitting antenna location at  $\leq 25$  mm from that surface or edges, at 5 mm separation from a flat phantom, for the data modes, wireless technologies and frequency bands by the devices to determine SAR compliance.

#### 2.4GHz

Antenna	Tx Interface	Frequency (MHz)	Output Power		SAR test required					
			dBm	mW	Front	Rear	Right	Left	Top	Bottom
Main	WLAN 11b	2462	13.00	19.95	MEASURE	MEASURE	EXEMPT	MEASURE	EXEMPT	MEASURE
Main	WLAN 11g	2462	13.00	19.95	MEASURE	MEASURE	EXEMPT	MEASURE	EXEMPT	MEASURE
Main	WLAN 11n	2462	13.00	19.95	MEASURE	MEASURE	EXEMPT	MEASURE	EXEMPT	MEASURE
Main	BT DH5	2480	7.50	5.62	MEASURE	MEASURE	EXEMPT	MEASURE	EXEMPT	MEASURE
Main	BT LE	2480	6.00	3.98	MEASURE	MEASURE	EXEMPT	MEASURE	EXEMPT	MEASURE

#### WLAN 11a 11n 5GHz

Antenna	Tx Interface	Frequency (MHz)	Output Power		SAR test required					
			dBm	mW	Front	Rear	Right	Left	Top	Bottom
Main	WLAN 11a	5320	12.00	15.85	MEASURE	MEASURE	EXEMPT	MEASURE	EXEMPT	MEASURE
Main	WLAN 11a	5700	9.00	7.94	MEASURE	MEASURE	EXEMPT	MEASURE	EXEMPT	MEASURE
Main	WLAN 11a	5825	9.00	7.94	MEASURE	MEASURE	EXEMPT	MEASURE	EXEMPT	MEASURE
Main	WLAN 11n20	5320	12.00	15.85	MEASURE	MEASURE	EXEMPT	MEASURE	EXEMPT	MEASURE
Main	WLAN 11n20	5700	9.00	7.94	MEASURE	MEASURE	EXEMPT	MEASURE	EXEMPT	MEASURE
Main	WLAN 11n20	5825	9.00	7.94	MEASURE	MEASURE	EXEMPT	MEASURE	EXEMPT	MEASURE
Main	WLAN 11n40	5310	12.00	15.85	MEASURE	MEASURE	EXEMPT	MEASURE	EXEMPT	MEASURE
Main	WLAN 11n40	5670	9.00	7.94	MEASURE	MEASURE	EXEMPT	MEASURE	EXEMPT	MEASURE
Main	WLAN 11n40	5795	9.00	7.94	MEASURE	MEASURE	EXEMPT	MEASURE	EXEMPT	MEASURE

#### 11ac 5GHz

Antenna	Tx Interface	Frequency (MHz)	Output Power		SAR test required					
			dBm	mW	Front	Rear	Right	Left	Top	Bottom
Main	WLAN 11ac20	5320	12.00	15.85	MEASURE	MEASURE	EXEMPT	MEASURE	EXEMPT	MEASURE
Main	WLAN 11ac20	5700	9.00	7.94	MEASURE	MEASURE	EXEMPT	MEASURE	EXEMPT	MEASURE
Main	WLAN 11ac20	5825	9.00	7.94	MEASURE	MEASURE	EXEMPT	MEASURE	EXEMPT	MEASURE
Main	WLAN 11ac40	5310	12.00	15.85	MEASURE	MEASURE	EXEMPT	MEASURE	EXEMPT	MEASURE
Main	WLAN 11ac40	5670	9.00	7.94	MEASURE	MEASURE	EXEMPT	MEASURE	EXEMPT	MEASURE
Main	WLAN 11ac40	5795	9.00	7.94	MEASURE	MEASURE	EXEMPT	MEASURE	EXEMPT	MEASURE
Main	WLAN 11ac80	5290	11.00	12.59	MEASURE	MEASURE	EXEMPT	MEASURE	EXEMPT	MEASURE
Main	WLAN 11ac80	5530	9.00	7.94	MEASURE	MEASURE	EXEMPT	MEASURE	EXEMPT	MEASURE
Main	WLAN 11ac80	5775	9.00	7.94	MEASURE	MEASURE	EXEMPT	MEASURE	EXEMPT	MEASURE

## **SECTION7: Description of the Body setup**

### **7.1 Procedure for SAR test position determination**

-The tested procedure was performed according to the KDB 941225 D07 (SAR Evaluation Procedures for UMPC Mini-Tablet Devices) and the KDB 616217 D04.

### **7.2 Test position for Body setup**

No.	Position	Test distance	SAR
			Tested
1	Front	0mm	<input checked="" type="checkbox"/>
2	Rear	0mm	<input checked="" type="checkbox"/>
3	Right	0mm	<input type="checkbox"/>
4	Left	0mm	<input checked="" type="checkbox"/>
5	Top	0mm	<input type="checkbox"/>
6	Bottom	0mm	<input checked="" type="checkbox"/>

\*The test was conservatively performed with test distance 0mm and with applicable surface based UMPC exclusion.



**SECTION8: Description of the operating mode**

**8.1 Output Power and SAR test required**

According to KDB248227D01, The initial test configuration for 2.4 GHz and 5 GHz OFDM transmission modes is determined by the 802.11 configuration with the highest maximum output power specified for production units, including tune-up tolerance, in each standalone and aggregated frequency band. SAR for the initial test configuration is measured using the highest maximum output power channel determined by the default power measurement procedures. When multiple configurations in a frequency band have the same specified maximum output power, the initial test configuration is determined according to the following steps applied sequentially.

1. The largest channel bandwidth configuration is selected among the multiple configurations with the same specified maximum output power.
2. If multiple configurations have the same specified maximum output power and largest channel bandwidth, the lowest order modulation among the largest channel bandwidth configurations is selected.
3. If multiple configurations have the same specified maximum output power, largest channel bandwidth and lowest order modulation, the lowest data rate configuration among these configurations is selected.
4. When multiple transmission modes (802.11a/g/n/ac) have the same specified maximum output power, largest channel bandwidth, lowest order modulation and lowest data rate, the lowest order 802.11 mode is selected; i.e., 802.11a is chosen over 802.11n then 802.11ac or 802.11g is chosen over 802.11n.

**Wi-Fi 2.4GHz (DTS Band)**

Band (GHz)	Mode	Data Rate	Ch #	Freq. (MHz)	Tune-up upper Power (dBm) (Burst)	Measured average Power (dBm) (Burst)	Initial test configuration	Note(s)
2.4	11b	1 Mbps	1	2412	13.00	12.63	Yes	
			6	2437	13.00	12.56		
			11	2462	13.00	12.61		
	11g	6 Mbps	1	2412	13.00	12.45		
			6	2437	13.00	12.55		
			11	2462	13.00	12.53		
	11n20	6.5 Mbps	1	2412	13.00	12.25		
			6	2437	13.00	12.21		
			11	2462	13.00	12.14		

**Note(s):**

1. Provided higher maximum output power is not specified for the other channels, channels 1, 6 and 11 are used to configure DSSS and OFDM channels for SAR measurements; otherwise, the closest adjacent channel with the highest maximum output power specified for production units should be tested instead of channels 1, 6 or 11.
2. When the highest reported SAR for the initial test configuration is adjusted by the ratio of the subsequent test configuration to initial test configuration specified maximum output power and the adjusted SAR is  $\leq 1.2$  W/kg, SAR is not required for that subsequent test configuration.
3. Initial SAR test channel was chosen. (shaded blue frame)

## Bluetooth

Band (GHz)	Mode	Data Rate	Ch #	Freq. (MHz)	Tune-up upper Power (dBm) (Burst)	Measured average Power (dBm) (Burst)	Initial test configuration	Note(s)
2.4	Bluetooth	DH5	1	2402	7.50	6.75	Yes	
			39	2441	7.50	6.43		
			79	2480	7.50	5.84		
	Bluetooth	LE	37	2402	6.00	5.36		
			17	2440	6.00	3.00		
			39	2480	6.00	3.23		

### Note(s):

1. According to KDB865664, SAR measurement is not required for EDR and LE when the specified tune-up tolerances for EDR and LE are lower than BDR.
2. The power value of Bluetooth LE was quoted from the original RF test report 11774441H-A-R2.
3. Initial SAR test channel was chosen. (shaded blue frame)

**WLAN 5GHz (U-NII-1 and U-NII-2A Bands)**

Band	Mode	Data Rate	Ch #	Freq. (MHz)	Tune-up upper Power (dBm) (Burst)	Measured average Power (dBm) (Burst)	Initial test configuration	Note(s)
U-NII-1	11a	6 Mbps	36	5180	12.00	10.97		
			44	5220	12.00	10.98		
			48	5240	12.00	11.13		
U-NII-2A	11a	6 Mbps	52	5260	12.00	11.02		
			60	5300	12.00	10.87		
			64	5320	12.00	10.99		
U-NII-1	11n20	MCS0	36	5180	12.00	10.59		
			44	5220	12.00	10.66		
			48	5240	12.00	10.84		
U-NII-2A	11n20	MCS0	52	5260	12.00	10.45		
			60	5300	12.00	10.50		
			64	5320	12.00	10.52		
U-NII-1	11ac20	MCS0	36	5180	12.00	10.65		
			44	5220	12.00	10.67		
			48	5240	12.00	10.88		
U-NII-2A	11ac20	MCS0	52	5260	12.00	10.47		
			60	5300	12.00	10.48		
			64	5320	12.00	10.53		
U-NII-1	11n40	MCS0	38	5190	12.00	10.76		
			46	5230	12.00	10.72		
U-NII-2A	11n40	MCS0	54	5270	12.00	10.56		
			62	5310	12.00	10.77	Yes	
U-NII-1	11ac40	MCS0	38	5190	12.00	10.63		
			46	5230	12.00	10.71		
U-NII-2A	11ac40	MCS0	54	5270	12.00	10.85		
			62	5310	12.00	10.77		
U-NII-1	11ac80	MCS0	42	5210	11.00	9.97		
U-NII-2A	11ac80	MCS0	68	5290	11.00	9.75		

**Note(s):**

- Output Power and SAR measurement is not required for 802.11a/n/ac VHT20/VHT40 channels when the specified tune-up tolerances for 802.11a/n/ac VHT20/VHT40 are lower than 802.11ac VHT80 and the measured SAR is  $\leq 1.2$  W/Kg.
- When the same transmission mode configurations have the same maximum output power on the same channel for the 802.11 a/g/n/ac modes, the channel with the largest bandwidth and lowest data rate is selected (i.e. 802.11ac VHT80).
- When the specified maximum output power is the same for both UNII band I and UNII band 2A, begin SAR measurement in UNII band 2A; and if the highest *reported* SAR for UNII band 2A is
  - o  $\leq 1.2$  W/kg, SAR is not required for UNII band I
  - o  $> 1.2$  W/kg, both bands should be tested independently for SAR.
- The standalone (SISO) SAR results were considered acceptable for the MIMO simultaneous transmission analysis as the MIMO power does not exceed the SISO power. The antenna separation distance will not be less than 50mm.
- According to KDB248227D01, Initial SAR test channel was chosen. (shaded blue frame)

**WLAN 5GHz (U-NII-2C Band and U-NII-3 Band)**

Band	Mode	Data Rate	Ch #	Freq. (MHz)	Tune-up upper Power (dBm) (Burst)	Measured average Power (dBm) (Burst)	Initial test configuration	Note(s)
U-NII-2C	11a	6 Mbps	100	5500	9.00	8.14		
			116	5580	9.00	8.47		
			140	5700	9.00	8.44		
U-NII-2C	11n20	MCS0	100	5500	9.00	7.81		
			116	5580	9.00	7.86		
			140	5700	9.00	8.06		
U-NII-2C	11ac20	MCS0	100	5500	9.00	7.78		
			116	5580	9.00	8.31		
			140	5700	9.00	8.05		
U-NII-2C	11n40	MCS0	102	5510	9.00	8.23		
			110	5550	9.00	8.62		
			134	5670	9.00	8.90		
U-NII-2C	11ac40	MCS0	102	5510	9.00	8.47		
			110	5550	9.00	8.60		
			134	5670	9.00	8.73		
U-NII-2C	11ac80	MCS0	106	5530	9.00	8.45	Yes	
U-NII-3	11a	6 Mbps	149	5745	9.00	8.35		
			157	5785	9.00	8.46		
			165	5825	9.00	8.25		
U-NII-3	11n20	MCS0	149	5745	9.00	8.01		
			157	5785	9.00	7.90		
			165	5825	9.00	7.93		
U-NII-3	11ac20	MCS0	149	5745	9.00	7.97		
			157	5785	9.00	8.04		
			165	5825	9.00	7.76		
U-NII-3	11n40	MCS0	151	5755	9.00	8.54		
			159	5795	9.00	8.39		
U-NII-3	11ac40	MCS0	151	5755	9.00	8.64		
			159	5795	9.00	8.38		
U-NII-3	11ac80	MCS0	155	5775	9.00	8.34	Yes	

**Note(s):**

- Output Power and SAR measurement is not required for 802.11a/n/ac VHT20/VHT40 channels when the specified tune-up tolerances for 802.11a/n/ac VHT20/VHT40 are lower than 802.11ac VHT80 and the measured SAR is  $\leq 1.2$  W/Kg.
- When the same transmission mode configurations have the same maximum output power on the same channel for the 802.11 a/g/n/ac modes, the channel with the largest bandwidth and lowest data rate is selected (i.e. 802.11ac VHT80).
- The standalone (SISO) SAR results were considered acceptable for the MIMO simultaneous transmission analysis as the MIMO power does not exceed the SISO power. The antenna separation distance will not be less than 50mm.
- Initial SAR test channel was chosen according to KDB248227D01. (shaded blue frame)

## 8.2 Correlation of Output Power

### **Correlation of Output Power between original test report and this SAR tests**

Refer to the following original report of Communication Module(M/N: 1MW, FCC ID : VPYLB1MW)

Report No:

11774441H-B-R2 (Bluetooth)

11774441H-A-R2 (2.4GHz WLAN)

11774441H-C-R2 (5GHz WLAN)

Band (GHz)	Mode	Data Rate	Ch #	Freq. (MHz)	Maximum measured average Power of Original test report (dBm)	Measured average Power in this SAR test report (dBm)	Deviation (dB)
2.4	Bluetooth	DH5	1	2402	6.86	6.75	-0.11
	WLAN 11n-20	MCS0	11	2462	12.62	12.25	-0.37
5	WLAN 11ac-80	MCS0	58	5290	10.08	9.97	-0.11

**SECTION9: Test surrounding**

**9.1 Measurement uncertainty**

This measurement uncertainty budget is suggested by IEEE Std 1528(2013) and IEC62209-2:2010, and determined by Schmid & Partner Engineering AG (DASY5 Uncertainty Budget). Per KDB 865664 D01 SAR Measurement 100 MHz to 6 GHz Section 2.8.1., when the highest measured SAR(1g) within a frequency band is < 1.5W/kg, the extensive SAR measurement uncertainty analysis described in IEEE Std.1528 (2013) is not required in SAR reports submitted for equipment approval.

<0.3 – 3GHz range Body>

Error Description	Uncertai value ±	Probability distribution	divisor	(ci) 1g	Standard (1g)
<b>Measurement System</b>					
Probe calibration	± 6.00	Normal	1	1	± 6.00
Axial isotropy of the probe	± 4.7	Rectangular	√3	0.7	± 1.9
Spherical isotropy of the probe	± 9.6	Rectangular	√3	0.7	± 3.9
Boundary effects	± 1.0	Rectangular	√3	1	± 0.6
Probe linearity	± 4.7	Rectangular	√3	1	± 2.7
Detection limit	± 1.0	Rectangular	√3	1	± 0.6
Modulation response	± 2.4	Rectangular	√3	1	± 1.4
Readout electronics	± 0.3	Normal	1	1	± 0.3
Response time	± 0.8	Rectangular	√3	1	± 0.5
Integration time	± 2.6	Rectangular	√3	1	± 1.5
RF ambient Noise	± 3.0	Rectangular	√3	1	± 1.7
RF ambient Reflections	± 3.0	Rectangular	√3	1	± 1.7
Probe Positioner	± 0.4	Rectangular	√3	1	± 0.2
Probe positioning	± 2.9	Rectangular	√3	1	± 1.7
Max.SAR Eval.	± 2.0	Rectangular	√3	1	± 1.2
<b>Test Sample Related</b>					
Device positioning	± 2.9	Normal	1	1	± 2.9
Device holder uncertainty	± 3.6	Normal	1	1	± 3.6
Power drift	± 5.0	Rectangular	√3	1	± 2.9
Power Scaling	+ 0.0	Rectangular	√3	1	± 0.0
<b>Phantom and Setup</b>					
Phantom uncertainty	± 6.1	Rectangular	√3	1	± 3.5
Algorithm for correcting SAR for deviations in permittivity and conductivity	± 1.9	Rectangular	√3	1	± 1.1
Liquid conductivity (meas.)	- 1.4	Rectangular	√3	0.78	+ 0.6
Liquid permittivity (meas.)	+ 0.7	Rectangular	√3	0.26	- 0.1
Liquid conductivity - temp.unc (below 2deg.C.)	± 5.2	Rectangular	√3	0.78	± 2.3
Liquid permittivity - temp.unc (below 2deg.C.)	± 0.8	Rectangular	√3	0.23	± 0.1
<b>Combined Standard Uncertainty</b>					± <b>11.172</b>
<b>Expanded Uncertainty (k=2)</b>					± <b>22.3</b>

\*. Table of uncertainties are listed for ISO/IEC 17025.

<3 – 6GHz range Body>

Error Description	Uncertain value ±	Probability distribution	divisor	(ci) 1g	Standard (1g)
<b>Measurement System</b>					
Probe calibration	± 6.55	Normal	1	1	± 6.55
Axial isotropy of the probe	± 4.7	Rectangular	√3	0.7	± 1.9
Spherical isotropy of the probe	± 9.6	Rectangular	√3	0.7	± 3.9
Boundary effects	± 1.0	Rectangular	√3	1	± 0.6
Probe linearity	± 4.7	Rectangular	√3	1	± 2.7
Detection limit	± 1.0	Rectangular	√3	1	± 0.6
Modulation response	± 2.4	Rectangular	√3	1	± 1.4
Readout electronics	± 0.3	Normal	1	1	± 0.3
Response time	± 0.8	Rectangular	√3	1	± 0.5
Integration time	± 2.6	Rectangular	√3	1	± 1.5
RF ambient Noise	± 3.0	Rectangular	√3	1	± 1.7
RF ambient Reflections	± 3.0	Rectangular	√3	1	± 1.7
Probe Positioner	± 0.4	Rectangular	√3	1	± 0.2
Probe positioning	± 2.9	Rectangular	√3	1	± 1.7
Max.SAR Eval.	± 2.0	Rectangular	√3	1	± 1.2
<b>Test Sample Related</b>					
Device positioning	± 2.9	Normal	1	1	± 2.9
Device holder uncertainty	± 3.6	Normal	1	1	± 3.6
Power drift	± 5.0	Rectangular	√3	1	± 2.9
Power Scaling	+ 0.0	Rectangular	√3	1	± 0.0
<b>Phantom and Setup</b>					
Phantom uncertainty	± 6.1	Rectangular	√3	1	± 3.5
Algorithm for correcting SAR for deviations in permittivity and conductivity	± 1.9	Rectangular	√3	1	± 1.1
Liquid conductivity (meas.)	+ 1.2	Rectangular	√3	0.78	+ 0.5
Liquid permittivity (meas.)	- 0.7	Rectangular	√3	0.26	- 0.1
Liquid conductivity - temp.unc (below 2deg.C.)	± 5.2	Rectangular	√3	0.78	± 2.3
Liquid permittivity - temp.unc (below 2deg.C.)	± 0.8	Rectangular	√3	0.23	± 0.1
<b>Combined Standard Uncertainty</b>					± 11.472
<b>Expanded Uncertainty (k=2)</b>					± 22.9

\*. Table of uncertainties are listed for ISO/IEC 17025.

## SECTION10: Parameter Check

The dielectric parameters were checked prior to assessment using the DAK dielectric probe kit.  
The dielectric parameters measurement is reported in each correspondent section.

According to KDB865664 D01, +/- 5% tolerances are required for  $\epsilon_r$  and  $\sigma$  and then below table which is the target value of the simulated tissue liquid is quoted from KDB865664 D01.

Target Frequency (MHz)	Head		Body	
	$\epsilon_r$	$\sigma$ (S/m)	$\epsilon_r$	$\sigma$ (S/m)
150	52.3	0.76	61.9	0.80
300	45.3	0.87	58.2	0.92
450	43.5	0.87	56.7	0.94
835	41.5	0.90	55.2	0.97
900	41.5	0.97	55.0	1.05
915	41.5	0.98	55.0	1.06
1450	40.5	1.20	54.0	1.30
1610	40.3	1.29	53.8	1.40
1800 – 2000	40.0	1.40	53.3	1.52
2450	39.2	1.80	52.7	1.95
3000	38.5	2.40	52.0	2.73
5800	35.3	5.27	48.2	6.00

( $\epsilon_r$  = relative permittivity,  $\sigma$  = conductivity and  $\rho = 1000 \text{ kg/m}^3$ )

### 10.1 For SAR system Check

DIELECTRIC PARAMETERS MEASUREMENT RESULTS											
Date	Ambient Temp. [deg.c]	Relative Humidity [%]	Liquid type	Liquid Temp. [deg.c]	Measured Frequency [MHz]	Parameters	Target Value	Measured	Deviation [%]	Limit [%]	Remark
2018/3/5	24.0	45	MSL 2450	23.5	2450	$\sigma$ [mho/m]	1.95	1.94	-0.4	+/-5	*1
						$\epsilon_r$	52.7	52.9	0.3	+/-5	
2018/3/7	24.0	45	MBBL 3.5-5.8	23.5	5250	$\sigma$ [mho/m]	5.36	5.36	0.0	+/-5	*2
						$\epsilon_r$	48.9	48.7	-0.6	+/-5	
2018/3/8	24.0	45	MBBL 3.5-5.8	23.5	5250	$\sigma$ [mho/m]	5.36	5.37	0.2	+/-5	*2
						$\epsilon_r$	48.9	48.6	-0.6	+/-5	
2018/3/15	24.0	45	MSL 2450	23.5	2450	$\sigma$ [mho/m]	1.95	1.95	0.1	+/-5	*2
						$\epsilon_r$	52.7	53.0	0.5	+/-5	
2018/3/19	24.0	45	MBBL 3.5-5.8	23.5	5600	$\sigma$ [mho/m]	5.77	5.76	0.0	+/-5	*2
						$\epsilon_r$	48.5	48.3	-0.3	+/-5	
2018/3/20	24.0	45	MBBL 3.5-5.8	23.5	5750	$\sigma$ [mho/m]	5.94	6.03	1.4	+/-5	*2
						$\epsilon_r$	48.3	48.4	0.3	+/-5	

$\sigma$  : Conductivity /  $\epsilon_r$ : Relative Permittivity

\*1 The Target value is a parameter defined in KDB 865664D01.

\*2 The dielectric parameters should be linearly interpolated between the closest pair of target frequencies to determine the applicable dielectric parameters corresponding to the device test frequency.



**Correlation confirmation with measured TSL parameters of the calibration certificate of system check dipoles (Refer to Appendix 3)**

+/- 6% limit for deviation provided by manufacture tolerances are required for  $\epsilon_r$  and  $\sigma$  and then below table which is the target value of the simulated tissue liquid is quoted from data measured TSL parameters of dipole calibration.

DIELECTRIC PARAMETERS MEASUREMENT RESULTS											
Date	Ambient Temp. [deg.c]	Relative Humidity [%]	Liquid type	Liquid Temp. [deg.c]	Measured Frequency [MHz]	Parameters	Target Value	Measured	Deviation [%]	Limit [%]	Remark
2018/3/5	24.0	45	MSL 2450	23.5	2450	$\sigma$ [mho/m]	2.04	1.94	-4.8	+/-6	
						$\epsilon_r$	51.6	52.9	2.5	+/-6	
2018/3/7	24.0	45	MBBL 3.5-5.8	23.5	5250	$\sigma$ [mho/m]	5.48	5.36	-2.2	+/-6	
						$\epsilon_r$	47.2	48.7	3.1	+/-6	
2018/3/8	24.0	45	MBBL 3.5-5.8	23.5	5250	$\sigma$ [mho/m]	5.48	5.37	-2.0	+/-6	
						$\epsilon_r$	47.2	48.6	3.1	+/-6	
2018/3/15	24.0	45	MSL 2450	23.5	2450	$\sigma$ [mho/m]	2.04	1.95	-4.3	+/-6	
						$\epsilon_r$	51.6	53.0	2.7	+/-6	
2018/3/19	24.0	45	MBBL 3.5-5.8	23.5	5600	$\sigma$ [mho/m]	5.94	5.76	-3.0	+/-6	
						$\epsilon_r$	46.6	48.3	3.7	+/-6	
2018/3/20	24.0	45	MBBL 3.5-5.8	23.5	5750	$\sigma$ [mho/m]	6.15	6.03	-2.0	+/-6	
						$\epsilon_r$	46.3	48.4	4.6	+/-6	

$\epsilon_r$ : Relative Permittivity /  $\sigma$  : Conductivity

The Target value is a parameter defined in each Dipole.

## 10.2 For SAR measurement

For 2.4GHz band

DIELECTRIC PARAMETERS MEASUREMENT RESULTS											
Date	Ambient Temp. [deg.c]	Relative Humidity [%]	Liquid type	Liquid Temp. [deg.c]	Measured Frequency [MHz]	Parameters	Target Value	Measured	Deviation [%]	Limit [%]	Remark
2018/3/5	24.0	45	MSL 2450	23.5	2412	$\sigma$ [mho/m]	1.91	1.89	-1.4	+/-5	
						$\epsilon_r$	52.8	53.0	0.4	+/-5	
2018/3/5	24.0	45	MSL 2450	23.5	2437	$\sigma$ [mho/m]	1.94	1.92	-0.7	+/-5	
						$\epsilon_r$	52.7	52.9	0.4	+/-5	
2018/3/5	24.0	45	MSL 2450	23.5	2462	$\sigma$ [mho/m]	1.97	1.96	-0.4	+/-5	
						$\epsilon_r$	52.7	52.8	0.3	+/-5	
2018/3/15	24.0	45	MSL 2450	23.5	2402	$\sigma$ [mho/m]	1.90	1.89	-1.0	+/-5	
						$\epsilon_r$	52.8	53.2	0.7	+/-5	

For 5GHz band

DIELECTRIC PARAMETERS MEASUREMENT RESULTS											
Date	Ambient Temp. [deg.c]	Relative Humidity [%]	Liquid type	Liquid Temp. [deg.c]	Measured Frequency [MHz]	Parameters	Target Value	Measured	Deviation [%]	Limit [%]	Remark
2018/3/7	24.0	45	MBBL 3.5-5.8	23.5	5270	$\sigma$ [mho/m]	5.38	5.41	0.5	+/-5	
						$\epsilon_r$	48.9	48.6	-0.7	+/-5	
2018/3/7	24.0	45	MBBL 3.5-5.8	23.5	5310	$\sigma$ [mho/m]	5.43	5.45	0.5	+/-5	
						$\epsilon_r$	48.9	48.7	-0.3	+/-5	
2018/3/8	24.0	45	MBBL 3.5-5.8	23.5	5310	$\sigma$ [mho/m]	5.43	5.50	1.2	+/-5	
						$\epsilon_r$	48.9	48.7	-0.4	+/-5	
2018/3/19	24.0	45	MBBL 3.5-5.8	23.5	5530	$\sigma$ [mho/m]	5.68	5.71	0.4	+/-5	
						$\epsilon_r$	48.6	48.6	0.0	+/-5	
2018/3/20	24.0	45	MBBL 3.5-5.8	23.5	5775	$\sigma$ [mho/m]	5.97	6.04	1.2	+/-5	
						$\epsilon_r$	48.2	48.4	0.4	+/-5	

$\sigma$  : Conductivity /  $\epsilon_r$ : Relative Permittivity

The dielectric parameters are linearly interpolated between the closest pair of target frequencies to determine the applicable dielectric parameters corresponding to the device test frequency.

**SECTION11: System Check confirmation**

The measurements were performed in the flat section of the TWIN SAM or ELI phantom, shell thickness: 2.0 ±0.2 mm (bottom plate) filled with Body or Head simulating liquid of the following parameters.

The depth of tissue-equivalent liquid in a phantom must be ≥ 15.0 cm ± 0.5 cm for SAR measurements ≤ 3 GHz and ≥ 10.0 cm ± 0.5 cm for measurements > 3 GHz.

The DASY system with an E-Field Probe was used for the measurements.

The dipole was mounted on the small tripod so that the dipole feed point was positioned below the center marking of the flat phantom section and the dipole was oriented parallel to the body axis (the long side of the phantom).

The standard measuring distance was 10 mm (above 1GHz to 6GHz) and 15 mm (below 1GHz) from dipole center to the simulating liquid surface.

The coarse grid with a grid spacing of 12 mm (1GHz to 3GHz) and 15 mm (below 1GHz) was aligned with the dipole.

For 5 GHz band - The coarse grid with a grid spacing of 10 mm was aligned with the dipole.

Special 7x7x7 (below 3 GHz) and/or 8x8x7 (above 3 GHz) fine cube was chosen for the cube.

Distance between probe sensors and phantom surface was set to 3 mm.

For 5 GHz band - Distance between probe sensors and phantom surface was set to 2.5 mm

The dipole input power (forward power) was 100 mW(For 5GHz band) or 250 mW(For other band).

The results are normalized to 1 W input power.

**Target Value**

Freq [MHz]	Model,S/N	Body	
		(SPEAG) 1g [W/kg]	(SPEAG) 10g[W/kg]
2450	D2450,713	52.00	24.44
5250	D5GHV2,1020	76.50	21.40
5600	D5GHV2,1020	80.30	22.40
5750	D5GHV2,1020	76.80	21.30

Date Tested	Test Freq	Model,S/N	T.S. Liquid	Measured Results		Target (Ref. Value)	Delta ±10 %	
				Zoom Scan	Normalize to 1 W			
2018/3/5	2450	D2450,713	Body	1g	12.10	48.40	52.00	-6.9
				10g	5.61	22.44	24.44	-8.2
2018/3/7	5250	D5GHV2,1020	Body	1g	7.61	76.10	76.50	-0.5
				10g	2.09	20.90	21.40	-2.3
2018/3/8	5250	D5GHV2,1020	Body	1g	7.15	71.50	76.50	-6.5
				10g	2.00	20.00	21.40	-6.5
2018/3/15	2450	D2450,713	Body	1g	12.10	48.40	52.00	-6.9
				10g	5.61	22.44	24.44	-8.2
2018/3/19	5600	D5GHV2,1020	Body	1g	7.82	78.20	80.30	-2.6
				10g	2.17	21.70	22.40	-3.1
2018/3/20	5750	D5GHV2,1020	Body	1g	7.07	70.70	76.80	-7.9
				10g	1.97	19.70	21.30	-7.5

\*The target(reference) SAR values can be obtained from the calibration certificate of system validation dipoles(Refer to Appendix 2). The target SAR values are SAR measured value in the calibration certificate scaled to 1W.

## **SECTION12: Measured and Reported (Scaled) SAR Results**

WLAN SAR Test Reduction criteria are as follows

### ● **KDB 248227 D01 (SAR Guidance for 802.11(Wi-Fi) Transmitters):**

SAR test reduction for 802.11 WLAN transmission mode configurations are considered separately for DSSS and OFDM. An initial test position is determined to reduce the number of tests required for certain exposure configurations with multiple test positions. An initial test configuration is determined for each frequency band and aggregated band according to maximum output power, channel bandwidth, wireless mode configurations and other operating parameters to streamline the measurement requirements. For 2.4 GHz DSSS, either the initial test position or DSSS procedure is applied to reduce the number of SAR tests; these are mutually exclusive. For OFDM, an initial test position is only applicable to next to the ear, UMPC mini-tablet and hotspot mode configurations, which is tested using the initial test configuration to facilitate test reduction. For other exposure conditions with a fixed test position, SAR test reduction is determined using only the initial test configuration.

The multiple test positions require SAR measurements in head, hotspot mode or UMPC mini-tablet configurations may be reduced according to the highest reported SAR determined using the *initial test position(s)* by applying the DSSS or OFDM SAR measurement procedures in the required wireless mode test configuration(s). The *initial test position(s)* is measured using the highest measured maximum output power channel in the required wireless mode test configuration(s). When the *reported* SAR for the *initial test position* is:

- ◇  $\leq 0.4$  W/kg, further SAR measurement is not required for the other test positions in that exposure configuration and wireless mode combination within the frequency band or aggregated band. DSSS and OFDM configurations are considered separately according to the required SAR procedures.
- ◇  $> 0.4$  W/kg, SAR is repeated using the same wireless mode test configuration tested in the *initial test position* to measure the subsequent next closet/smallest test separation distance and maximum coupling test position, on the highest maximum output power channel, until the *reported* SAR is  $\leq 0.8$  W/kg or all required test positions are tested.
  - For subsequent test positions with equivalent test separation distance or when exposure is dominated by coupling conditions, the position for maximum coupling condition should be tested.
  - When it is unclear, all equivalent conditions must be tested.
- ◇ For all positions/configurations tested using the *initial test position* and subsequent test positions, when the *reported* SAR is  $> 0.8$  W/kg, measure the SAR for these positions/configurations on the subsequent next highest measured output power channel(s) until the *reported* SAR is  $\leq 1.2$  W/kg or all required test channels are considered.
  - The additional power measurements required for this step should be limited to those necessary for identifying subsequent highest output power channels to apply the test reduction.
- ◇ When the specified maximum output power is the same for both UNII 1 and UNII 2A, begin SAR measurements in UNII 2A with the channel with the highest measured output power. If the reported SAR for UNII 2A is  $\leq 1.2$  W/kg, SAR is not required for UNII 1; otherwise treat the remaining bands separately and test them independently for SAR.
- ◇ When the specified maximum output power is different between UNII 1 and UNII 2A, begin SAR with the band that has the higher specified maximum output. If the highest reported SAR for the band with the highest specified power is  $\leq 1.2$  W/kg, testing for the band with the lower specified output power is not required; otherwise test the remaining bands independently for SAR.

To determine the *initial test position*, Area Scans were performed to determine the position with the *Maximum Value of SAR (measured)*. The position that produced the highest *Maximum Value of SAR* is considered the worst case position; thus used as the *initial test position*.

Bluetooth SAR Test Reduction criteria are as follows

**KDB 447498 D01 (General RF Exposure Guidance):**

Testing of other required channels within the operating mode of a frequency band is not required when the reported 1-g or 10-g SAR for the mid-band or highest output power channel is:

- ◇  $\leq 0.8$  W/kg or 2.0 W/kg, for 1-g or 10-g respectively, when the transmission band is  $\leq 100$  MHz
- ◇  $\leq 0.6$  W/kg or 1.5 W/kg, for 1-g or 10-g respectively, when the transmission band is between 100 MHz and 200 MHz
- ◇  $\leq 0.4$  W/kg or 1.0 W/kg, for 1-g or 10-g respectively, when the transmission band is  $\geq 200$  MHz
  
- When reported SAR value is exceed 1.2W/kg (if any), device holder perturbation verification is required; however, since distance between device holder and antenna of EUT is enough, it was not conducted.
- Reported SAR= Measured SAR [W/kg] · Scaled factor  
\* Scaled factor = Maximum tune-up tolerance limit [mW] / Measured power [mW]
- Maximum tune-up tolerance limit is by the specification from a customer.

## 12.1 WLAN 2.4GHz Band

Test Position	Mode	Dist. (mm)	Ch #.	Freq. (MHz)	Power (dBm)		Scaled factor	1-g SAR (W/kg)	
					Tune-up upper Power	Measured average Power		Meas.	Reported
Front	802.11b	0	1	2412	13.00	12.63	1.089	0.033	0.036
			6	2437	13.00	12.56	1.107		
			11	2462	13.00	12.61	1.094		
Rear	802.11b	0	1	2412	13.00	12.63	1.089	0.033	0.036
			6	2437	13.00	12.56	1.107		
			11	2462	13.00	12.61	1.094		
Left	802.11b	0	1	2412	13.00	12.63	1.089	0.896	0.976
			6	2437	13.00	12.56	1.107	0.773	0.855
			11	2462	13.00	12.61	1.094	0.848	0.928
Bottom	802.11b	0	1	2412	13.00	12.63	1.089	0.131	0.143
			6	2437	13.00	12.56	1.107		
			11	2462	13.00	12.61	1.094		

**OFDM was excluded from the following table according to KDB248227D01.**

SAR is not required for the following 2.4 GHz OFDM conditions according to KDB248227D01.

- 1) When KDB447498D01 SAR test exclusion applies to the OFDM configuration.
- 2) When the highest reported SAR for DSSS is adjusted by the ratio of OFDM to DSSS specified maximum output power and the adjusted SAR is  $\leq 1.2$  W/kg.

Maximum tune-up tolerance limit		Maximum tune-up tolerance limit		OFDM scaled factor	Position	DSSS Reported SAR value [W/kg]	OFDM Estimated SAR value [W/kg]	Exclusion limit [W/kg]	Standalone SAR request
DSSS		OFDM							
[dBm]	[mW]	[dBm]	[mW]						
13.00	19.95	13.00	19.95	1.000	Left	0.976	0.976	< 1.2	No

### Note(s):

- OFDM scaled factor = Maximum tune-up tolerance limit of OFDM [mW] / Maximum tune-up tolerance limit of DSSS [mW]
- Estimated SAR of OFDM = Reported SAR of DSSS [W/kg] · OFDM scaled factor

## 12.2 Bluetooth

Test Position	Mode	Dist. (mm)	Ch #.	Freq. (MHz)	Power (dBm)		Scaled factor	1-g SAR (W/kg)	
					Tune-up upper Power	Measured average Power		Meas.	Reported
Front	BT DH5	0	1	2402	7.50	6.75	1.189	0.013	0.015
			39	2441	7.50	6.43	1.279		
			79	2480	7.50	5.84	1.466		
Rear	BT DH5	0	1	2402	7.50	6.75	1.189	0.00664	0.00789
			39	2441	7.50	6.43	1.279		
			79	2480	7.50	5.84	1.466		
Left	BT DH5	0	1	2402	7.50	6.75	1.189	0.280	0.333
			39	2441	7.50	6.43	1.279		
			79	2480	7.50	5.84	1.466		
Bottom	BT DH5	0	1	2402	7.50	6.75	1.189	0.020	0.024
			39	2441	7.50	6.43	1.279		
			79	2480	7.50	5.84	1.466		

## 12.3 WLAN 5.3GHz Band

Test Position	Mode	Dist. (mm)	Ch #.	Freq. (MHz)	Power (dBm)		Scaled factor	1-g SAR (W/kg)	
					Tune-up upper Power	Measured average Power		Meas.	Reported
Front	802.11n40	0	54	5270	12.00	10.56	1.393		
			62	5310	12.00	10.77	1.327	0.128	0.170
Rear	802.11n40	0	54	5270	12.00	10.56	1.393		
			62	5310	12.00	10.77	1.327	0.046	0.061
Left	802.11n40	0	54	5270	12.00	10.56	1.393	0.694	0.967
			62	5310	12.00	10.77	1.327	0.800	1.062
Bottom	802.11n40	0	54	5270	12.00	10.56	1.393		
			62	5310	12.00	10.77	1.327	0.270	0.358

U-NII-1 test configuration was **excluded** from the following according to KDB248227D01.

When the same maximum output power is specified for both bands, begin SAR measurement in U-NII-2A band by applying the OFDM SAR requirements. If the highest reported SAR for a test configuration is  $\leq 1.2$  W/kg, SAR is not required for U-NII-1 band for that configuration (802.11 mode and exposure condition); otherwise, each band is tested independently for SAR.

## 12.4 WLAN 5.5GHz Band

Test Position	Mode	Dist. (mm)	Ch #.	Freq. (MHz)	Power (dBm)		Scaled factor	1-g SAR (W/kg)	
					Tune-up upper Power	Measured average Power		Meas.	Reported
Front	11ac80	0	106	5530	9.00	8.45	1.135	0.067	0.076
Rear	11ac80	0	106	5530	9.00	8.45	1.135	0.017	0.019
Left	11ac80	0	106	5530	9.00	8.45	1.135	0.598	0.679
Bottom	11ac80	0	106	5530	9.00	8.45	1.135	0.133	0.151

### Notes:

1. Scaled factor = Maximum tune-up tolerance limit of subsequent test configuration [mW] / Maximum tune-up tolerance limit of initial test configuration [mW]
2. Estimated SAR of subsequent test configuration = Reported SAR of initial test configuration [W/kg] · scaled factor
3. Maximum tune-up tolerance limit of subsequent test configuration is next highest tune-up tolerance limit.

## 12.5 WLAN 5.8GHz Band

Test Position	Mode	Dist. (mm)	Ch #.	Freq. (MHz)	Power (dBm)		Scaled factor	1-g SAR (W/kg)	
					Tune-up upper Power	Measured average Power		Meas.	Reported
Front	11ac80	0	155	5775	9.00	8.34	1.164	0.077	0.090
Rear	11ac80	0	155	5775	9.00	8.34	1.164	0.033	0.038
Left	11ac80	0	155	5775	9.00	8.34	1.164	0.866	1.008
Bottom	11ac80	0	155	5775	9.00	8.34	1.164	0.135	0.157

### Notes:

1. Scaled factor = Maximum tune-up tolerance limit of subsequent test configuration [mW] / Maximum tune-up tolerance limit of initial test configuration [mW]
2. Estimated SAR of subsequent test configuration = Reported SAR of initial test configuration [W/kg] · scaled factor
3. Maximum tune-up tolerance limit of subsequent test configuration is next highest tune-up tolerance limit.



## 12.6 Repeated measurement

According to KDB865664 D1.

- 1) Repeated measurement is not required when the original highest measured SAR is  $< 0.80$  W/kg; steps 2) through 4) do not apply.
- 2) When the original highest measured SAR is  $\geq 0.80$  W/kg, repeat that measurement once.
- 3) Perform a second repeated measurement only if the ratio of largest to smallest SAR for the original and first repeated measurements is  $> 1.20$  or when the original or repeated measurement is  $\geq 1.45$  W/kg (~ 10% from the 1-g SAR limit).
- 4) Perform a third repeated measurement only if the original, first or second repeated measurement is  $\geq 1.5$  W/kg and the ratio of largest to smallest SAR for the original, first and second repeated measurements is  $> 1.20$ .

Wireless Technologies	Test Configuration		Mode	Dist. (mm)	Ch #.	Freq. (MHz)	Meas. SAR (W/kg)		Largest to Smallest SAR Ratio
	Position						Original	Repeated	
WLAN 2.4GHz	Left		802.11b	0	1	2412	0.896	0.849	1.055
Bluetooth	Left		DH5	0	1	2402	0.280	NA	NA
WLAN 5GHz	Left		802.11n40	0	62	5310	0.800	0.797	1.004
WLAN 5GHz	Left		802.11ac80 VHT0	0	106	5530	0.598	NA	NA
WLAN 5GHz	Left		802.11ac80 VHT0	0	155	5775	0.866	0.853	1.015

**SECTION13: Test instruments**

Control No.	Instrument	Manufacturer	Model No	Serial No	Test Item	Calibration Date * Interval(month)
MNA-03	Vector Reflectometer	Copper Mountain Technologies	PLANAR R140	0030913	SAR	2017/04/22 * 12
MDPK-03	Dielectric assessment kit	Schmid&Partner Engineering AG	DAK-3.5	0008	SAR	2017/04/18 * 12
MOS-37	Digital thermometer	LKM electronic	DTM3000	-	SAR	2017/07/26 * 12
COTS-MSAR-04	Dielectric assessment software	Schmid&Partner Engineering AG	DAK		SAR	-
MPM-11	Dual Power Meter	Agilent	E4419B	MY45102060	SAR	2017/08/25 * 12
MPSE-15	Power sensor	Agilent	E9301A	MY41498311	SAR	2017/08/25 * 12
MPSE-16	Power sensor	Agilent	E9301A	MY41498313	SAR	2017/08/25 * 12
MRFA-24	Pre Amplifier	R&K	R&K CGA020M602-2633R	B30550	SAR	2017/06/12 * 12
MSG-10	Signal Generator	Agilent	N5181A	MY47421098	SAR	2017/11/29 * 12
MAT-78	Attenuator	Telegraftrner	J01156A0011	0042294119	SAR	Pre Check
MPM-15	Power Meter	Agilent	N1914A	MY53060017	SAR	2017/06/21 * 12
MPSE-21	Power sensor	Agilent	N8482H	MY52460010	SAR	2017/06/21 * 12
MHDC-12	Dual Directional Coupler	Hewlett Packard	772D	2839A0016	SAR(2-18GHz)	Pre Check
MDA-07	Dipole Antenna	Schmid&Partner Engineering AG	D2450V2	713	SAR(D2450)	2016/09/13 * 24
MMSL2450	Tissue simulation liquid (Body)	Schmid&Partner Engineering AG	MSL2450V2	SL AA 245 BA	SAR*Daily Check Target Value $\pm 5\%$	Pre Check
MDA-08	Dipole Antenna	Schmid&Partner Engineering AG	D5GHzV2	1020	SAR(D5G)	2018/01/11 * 12
MMBBL3.5-5.8	Tissue simulation liquid (Body)	Schmid&Partner Engineering AG	MBBL3500-5800V5	SL AAM 501 DA	SAR*Daily Check Target Value $\pm 5\%$	Pre Check
MDAE-03	Data Acquisition Electronics	Schmid&Partner Engineering AG	DAE4	1372	SAR	2017/06/13 * 12
MPB-09	Dosimetric E-Field Probe	Schmid&Partner Engineering AG	EX3DV4	3922	SAR	2017/11/15 * 12
MPP-04	2mm Oval Flat Phantom	Schmid&Partner Engineering AG	QDOVA001BB	1207	SAR	2017/05/17 * 12
MDH-03	Device holder	Schmid&Partner Engineering AG	Mounting device for transmitter	-	SAR	Pre Check
MOS-35	Digital thermometer	HANNA	Checktemp 4	-	SAR	2017/07/26 * 12
COTS-MSAR-03	Dasy5	Schmid&Partner Engineering AG	DASY5	-	SAR	-
MRBT-04	SAR robot	Schmid&Partner Engineering AG	TX60 Lspeag	F13/5PPLA1/A/01	SAR	2017/06/30 * 12
MDAE-01	Data Acquisition Electronics	Schmid&Partner Engineering AG	DAE4	509	SAR	2017/07/11 * 12
MPB-07	Dosimetric E-Field Probe	Schmid&Partner Engineering AG	EX3DV4	3825	SAR	2017/12/11 * 12
MPP-02	2mm Oval Flat Phantom	Schmid&Partner Engineering AG	QDOVA001BB	1045	SAR	2017/05/17 * 12
MDH-01	Device holder	Schmid&Partner Engineering AG	Mounting device for transmitter	-	SAR	Pre Check
MOS-26	Thermo-Hygrometer	CUSTOM	CTH-201	A08Q29	SAR	2017/04/21 * 12
MRBT-02	SAR robot	Schmid&Partner Engineering AG	TX60 Lspeag	F10/5E3LA1/A/01	SAR	2017/09/19 * 12

\*1) This test equipment was used for the tests before the expiration date of the calibration.  
The expiration date of the calibration is the end of the expired month.  
All equipment is calibrated with valid calibrations. Each measurement data is traceable to the national or international standards.  
As for some calibrations performed after the tested dates, those test equipment have been controlled by means of an unbroken chains of calibrations.

SAR room is checked before every testing and ambient noise is <0.012W/kg

## APPENDIX 1 : System Check

### 20180305 Body 2450MHz System Check Power 250mW

Communication System: UID 0, CW (0); Communication System Band: D2450 (2450.0 MHz); Frequency: 2450 MHz;  
Duty Cycle: 1:1

Medium parameters used:  $f = 2450$  MHz;  $\sigma = 1.942$  S/m;  $\epsilon_r = 52.871$ ;  $\rho = 1000$  kg/m<sup>3</sup>

Phantom section: Flat Section

Measurement Standard: DASYS (IEEE/IEC/ANSI C63.19-2007)

DASY5 Configuration

Probe: EX3DV4 - SN3825; ConvF(7.77, 7.77, 7.77); Calibrated: 2017/12/11;

Sensor-Surface: 2mm (Mechanical Surface Detection), Sensor-Surface: 0mm (Fix Surface)

Electronics: DAE4 Sn509; Calibrated: 2017/07/11

Phantom: ELI v4.0 (20deg probe tilt); Type: QDOVA001BB; Serial: TP:1045

Measurement SW: DASYS2, Version 52.8 (8); SEMCAD X Version 14.6.10 (7331)

**Area Scan (81x71x1):** Interpolated grid: dx=1.200 mm, dy=1.200 mm

Maximum value of SAR (interpolated) = 19.1 W/kg

**Zoom Scan (7x7x7) (7x7x7)/Cube 0:** Measurement grid: dx=5mm, dy=5mm, dz=5mm

Reference Value = 98.45 V/m; Power Drift = -0.02 dB

Peak SAR (extrapolated) = 24.9 W/kg

**SAR(1 g) = 12.1 W/kg; SAR(10 g) = 5.61 W/kg**

Maximum value of SAR (measured) = 18.4 W/kg

**Z Scan (1x1x31):** Measurement grid: dx=20mm, dy=20mm, dz=5mm

Maximum value of SAR (measured) = 19.1 W/kg

Date: 2018/03/05

Ambient Temp. : 24.0 degree.C. Liquid Temp.; 23.5 degree.C.

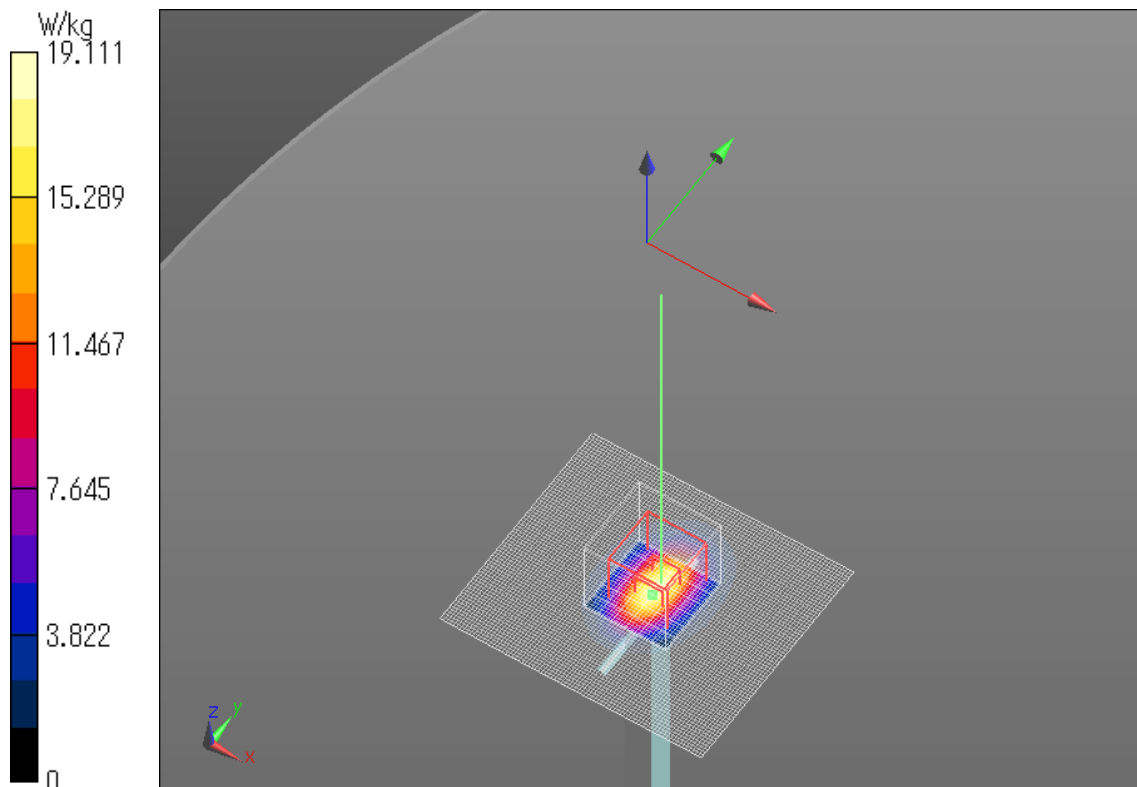

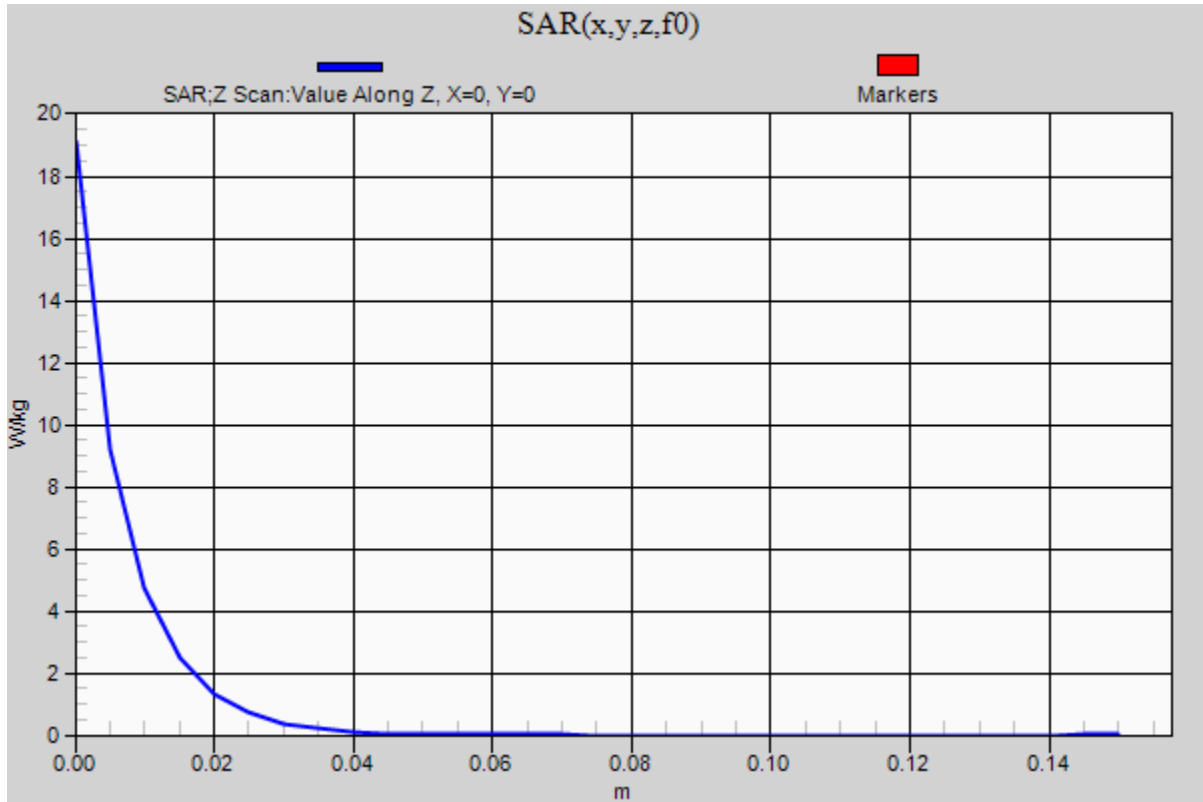

**20180307 Body 5250MHz System Check Power 100mW**

Communication System: UID 0, CW; Communication System Band: D5GHz (5000.0 - 6000.0 MHz); Frequency: 5250 MHz; Duty Cycle: 1:1

Medium parameters used:  $f = 5250$  MHz;  $\sigma = 5.357$  S/m;  $\epsilon_r = 48.659$ ;  $\rho = 1000$  kg/m<sup>3</sup>

Phantom section: Flat Section

Measurement Standard: DASY5 (IEEE/IEC/ANSI C63.19-2011)

DASY5 Configuration

Probe: EX3DV4 - SN3825; ConvF(4.69, 4.69, 4.69); Calibrated: 2017/12/11;

Sensor-Surface: 1.4mm (Mechanical Surface Detection), Sensor-Surface: 0mm (Fix Surface)

Electronics: DAE4 Sn509; Calibrated: 2017/07/11

Phantom: ELI v4.0 (20deg probe tilt); Type: QDOVA001BB; Serial: TP:1045

Measurement SW: DASY52, Version 52.8 (8); SEMCAD X Version 14.6.10 (7331)

**Area Scan (91x91x1):** Interpolated grid: dx=1.000 mm, dy=1.000 mm

Maximum value of SAR (interpolated) = 18.8 W/kg

**Zoom Scan (4x4x1.4mm, graded), dist=1.4mm (8x8x7)/Cube 0:** Measurement grid: dx=4mm, dy=4mm, dz=1.4mm

Reference Value = 68.24 V/m; Power Drift = 0.03 dB

Peak SAR (extrapolated) = 33.2 W/kg

**SAR(1 g) = 7.61 W/kg; SAR(10 g) = 2.09 W/kg**

Maximum value of SAR (measured) = 18.8 W/kg

**Z Scan (1x1x31):** Measurement grid: dx=20mm, dy=20mm, dz=5mm

Maximum value of SAR (measured) = 23.6 W/kg

Date: 2018/03/07

Ambient Temp. : 24.0 degree.C. Liquid Temp.; 23.5 degree.C.

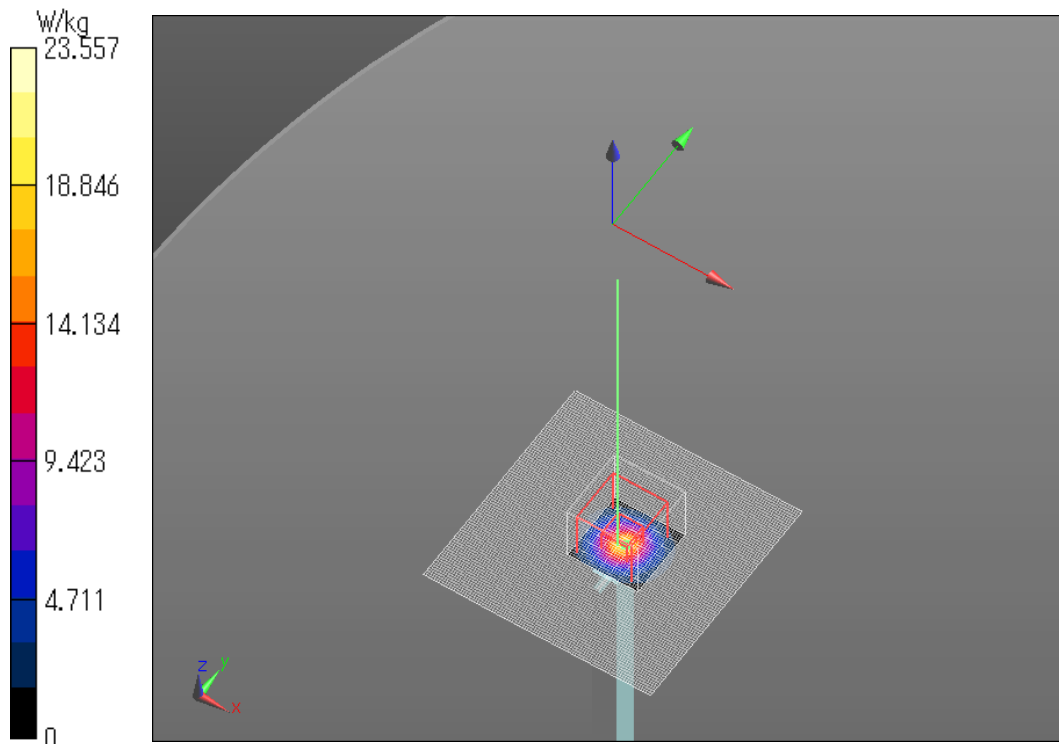

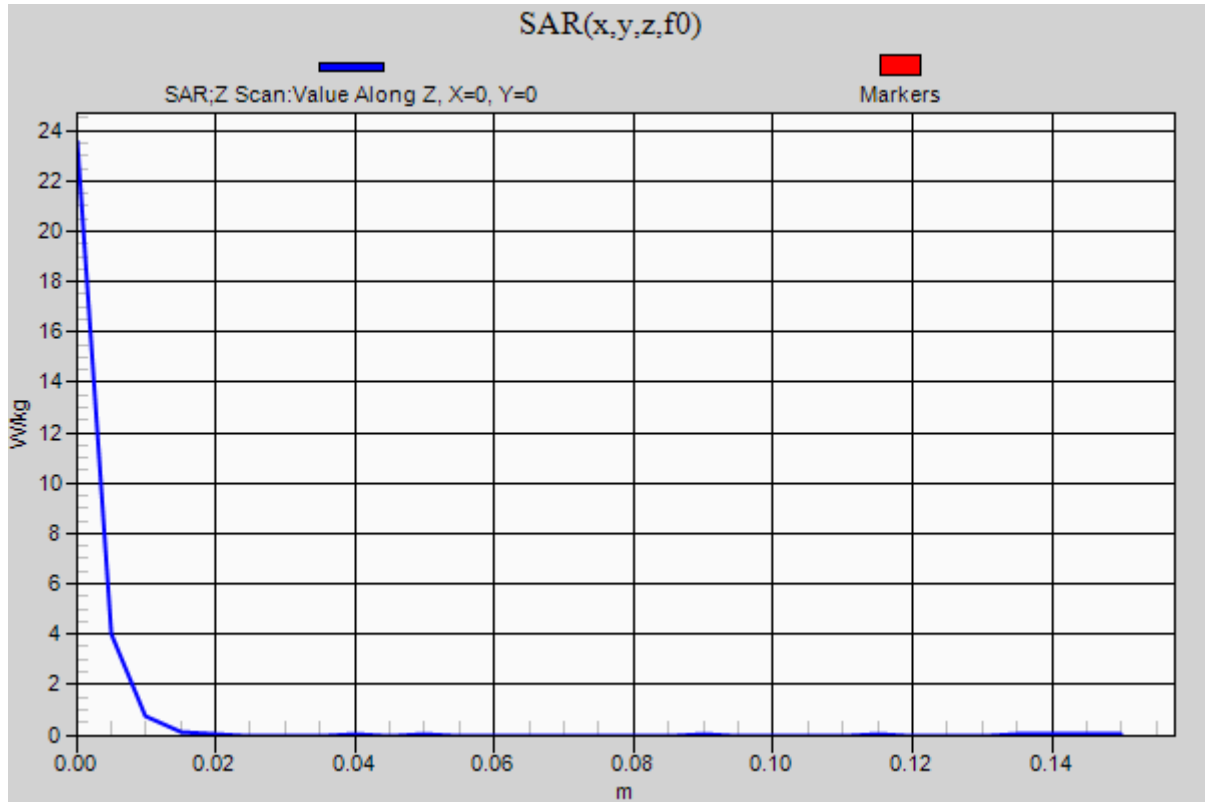

**20180308 Body 5250MHz System Check Power 100mW**

Communication System: UID 0, CW; Communication System Band: D5GHz (5000.0 - 6000.0 MHz); Frequency: 5250 MHz; Duty Cycle: 1:1

Medium parameters used:  $f = 5250$  MHz;  $\sigma = 5.368$  S/m;  $\epsilon_r = 48.649$ ;  $\rho = 1000$  kg/m<sup>3</sup>

Phantom section: Flat Section

Measurement Standard: DASY5 (IEEE/IEC/ANSI C63.19-2011)

DASY5 Configuration

Probe: EX3DV4 - SN3825; ConvF(4.69, 4.69, 4.69); Calibrated: 2017/12/11;

Sensor-Surface: 1.4mm (Mechanical Surface Detection), Sensor-Surface: 0mm (Fix Surface)

Electronics: DAE4 Sn509; Calibrated: 2017/07/11

Phantom: ELI v4.0 (20deg probe tilt); Type: QDOVA001BB; Serial: TP:1045

Measurement SW: DASY52, Version 52.8 (8); SEMCAD X Version 14.6.10 (7331)

**Area Scan (91x91x1):** Interpolated grid: dx=1.000 mm, dy=1.000 mm

Maximum value of SAR (interpolated) = 17.8 W/kg

**Zoom Scan (4x4x1.4mm, graded), dist=1.4mm (8x8x7)/Cube 0:** Measurement grid: dx=4mm, dy=4mm, dz=1.4mm

Reference Value = 64.97 V/m; Power Drift = 0.04 dB

Peak SAR (extrapolated) = 30.5 W/kg

**SAR(1 g) = 7.15 W/kg; SAR(10 g) = 2 W/kg**

Maximum value of SAR (measured) = 17.3 W/kg

**Z Scan (1x1x31):** Measurement grid: dx=20mm, dy=20mm, dz=5mm

Maximum value of SAR (measured) = 21.4 W/kg

Date: 2018/03/08

Ambient Temp. : 24.0 degree.C. Liquid Temp.; 23.5 degree.C.

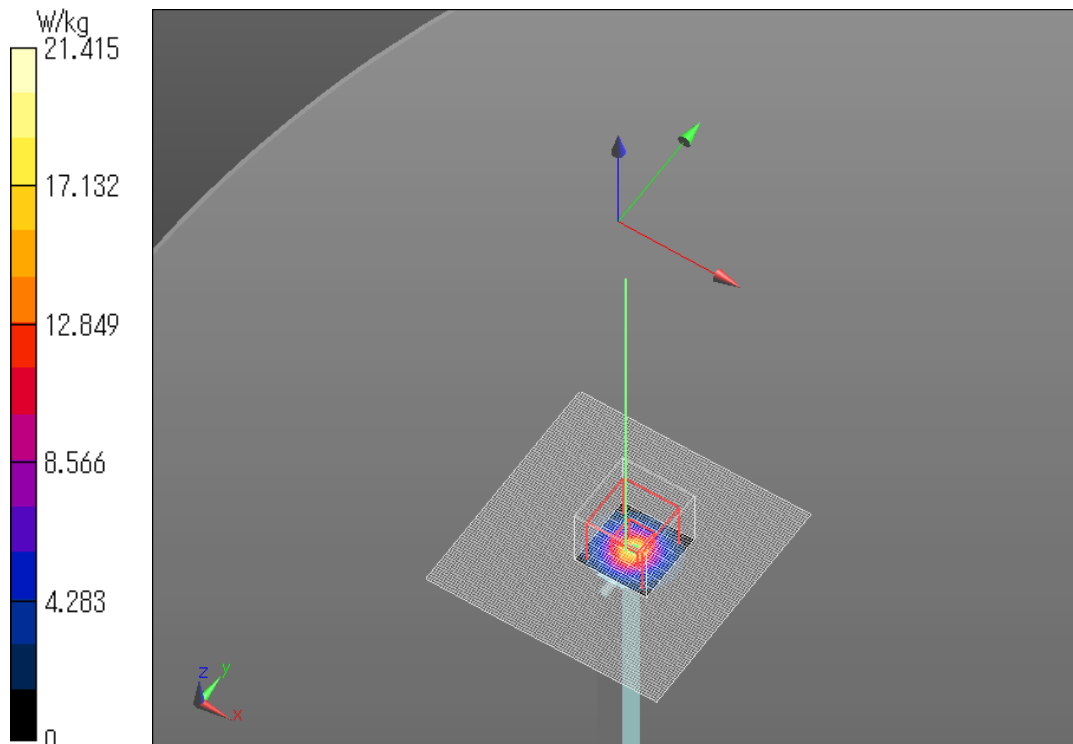

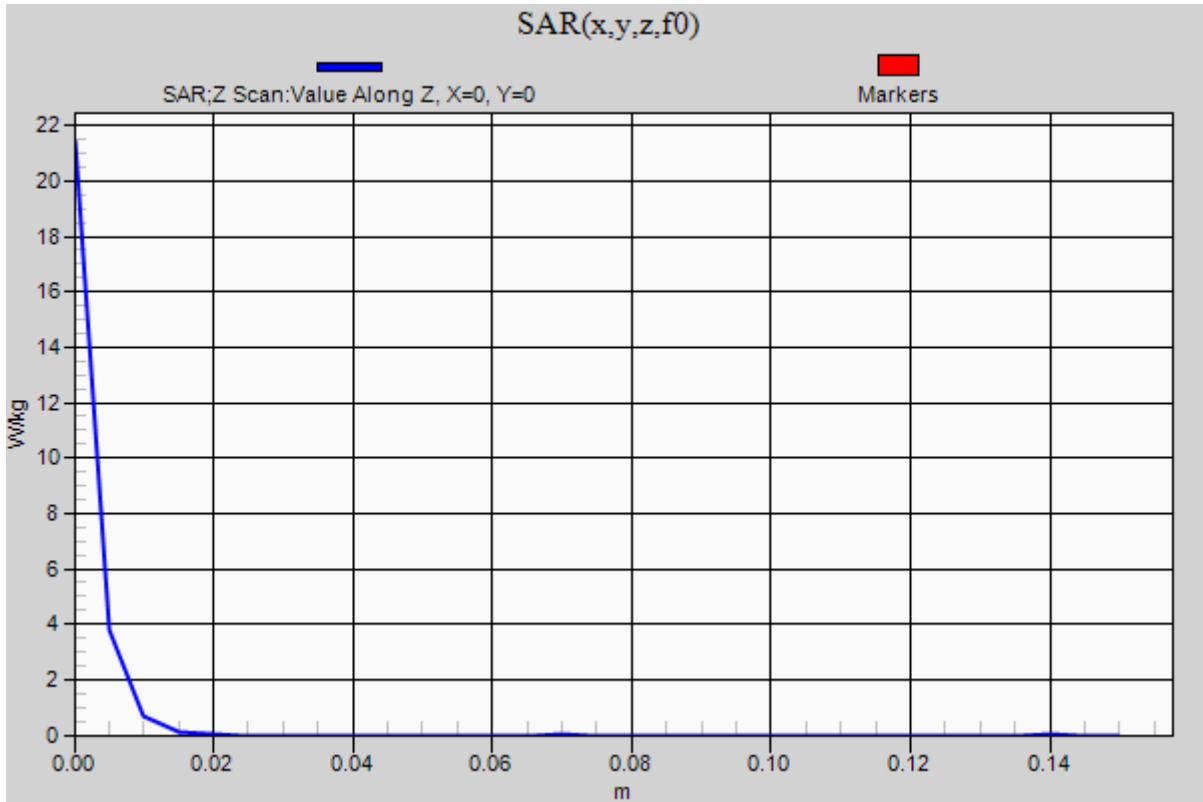



### 20180315 Body 2450MHz System Check Power 250mW

Communication System: UID 0, CW (0); Communication System Band: D2450 (2450.0 MHz); Frequency: 2450 MHz;  
Duty Cycle: 1:1

Medium parameters used:  $f = 2450$  MHz;  $\sigma = 1.952$  S/m;  $\epsilon_r = 52.98$ ;  $\rho = 1000$  kg/m<sup>3</sup>

Phantom section: Flat Section

Measurement Standard: DASY5 (IEEE/IEC/ANSI C63.19-2007)

DASY5 Configuration

Probe: EX3DV4 - SN3922; ConvF(7.68, 7.68, 7.68); Calibrated: 2017/11/15;

Sensor-Surface: 2mm (Mechanical Surface Detection), Sensor-Surface: 0mm (Fix Surface)

Electronics: DAE4 Sn1372; Calibrated: 2017/06/13

Phantom: ELI v5.0 (30deg probe tilt); Type: QDOVA001BB; Serial: TP:1207

Measurement SW: DASY52, Version 52.8 (8); SEMCAD X Version 14.6.10 (7331)

**Area Scan (81x71x1):** Interpolated grid: dx=1.200 mm, dy=1.200 mm

Maximum value of SAR (interpolated) = 18.8 W/kg

**Zoom Scan (7x7x7) (7x7x7)/Cube 0:** Measurement grid: dx=5mm, dy=5mm, dz=5mm

Reference Value = 98.55 V/m; Power Drift = -0.03 dB

Peak SAR (extrapolated) = 24.6 W/kg

**SAR(1 g) = 12.1 W/kg; SAR(10 g) = 5.61 W/kg**

Maximum value of SAR (measured) = 18.4 W/kg

**Z Scan (1x1x31):** Measurement grid: dx=20mm, dy=20mm, dz=5mm

Maximum value of SAR (measured) = 9.23 W/kg

Date: 2018/03/15

Ambient Temp. : 24.0 degree.C. Liquid Temp.; 23.5 degree.C.

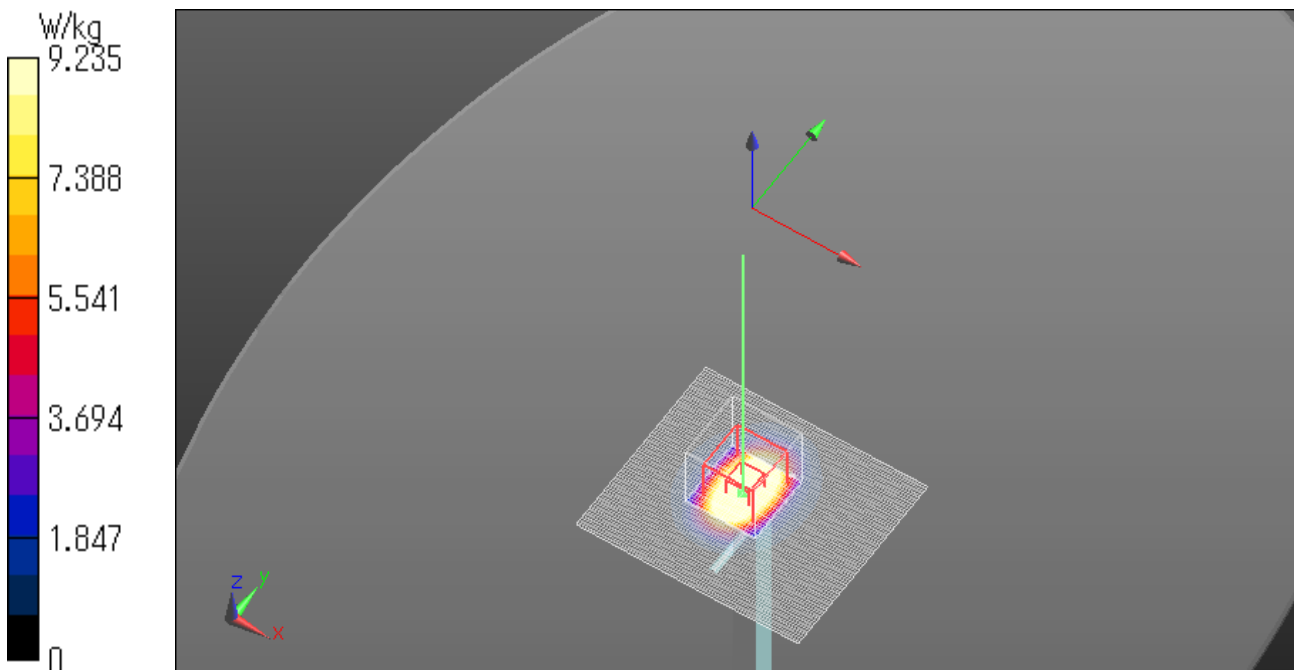

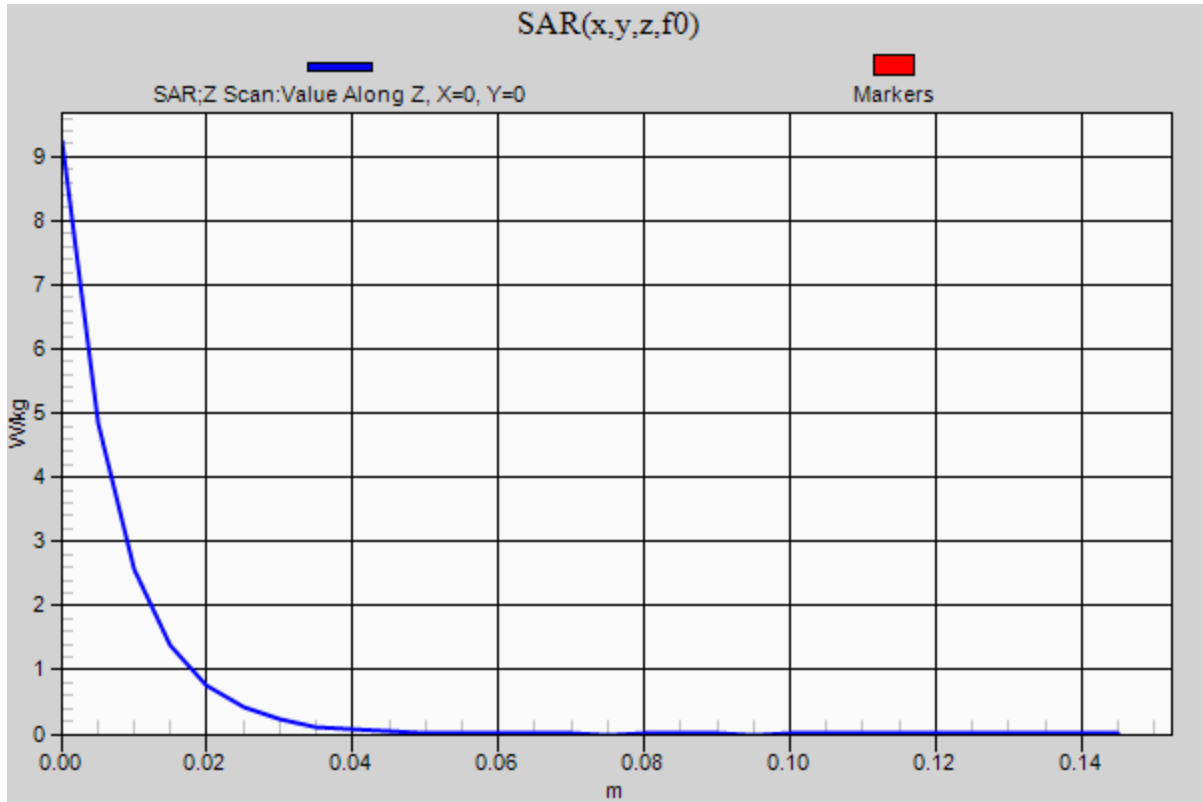

**20180319 Body 5600MHz System Check Power 100mW**

Communication System: UID 0, CW (0); Communication System Band: D5GHz (5000.0 - 6000.0 MHz); Frequency: 5600 MHz; Duty Cycle: 1:1

Medium parameters used:  $f = 5600$  MHz;  $\sigma = 5.764$  S/m;  $\epsilon_r = 48.321$ ;  $\rho = 1000$  kg/m<sup>3</sup>

Phantom section: Flat Section

Measurement Standard: DASY5 (IEEE/IEC/ANSI C63.19-2011)

DASY5 Configuration

Probe: EX3DV4 - SN3825; ConvF(3.96, 3.96, 3.96); Calibrated: 2017/12/11;

Sensor-Surface: 1.4mm (Mechanical Surface Detection), Sensor-Surface: 0mm (Fix Surface)

Electronics: DAE4 Sn509; Calibrated: 2017/07/11

Phantom: ELI v4.0 (20deg probe tilt); Type: QDOVA001BB; Serial: TP:1045

Measurement SW: DASY52, Version 52.8 (8); SEMCAD X Version 14.6.10 (7331)

**Area Scan (91x91x1):** Interpolated grid: dx=1.000 mm, dy=1.000 mm

Maximum value of SAR (interpolated) = 19.0 W/kg

**Zoom Scan (4x4x1.4mm, graded), dist=1.4mm (8x8x7)/Cube 0:** Measurement grid: dx=4mm, dy=4mm, dz=1.4mm

Reference Value = 67.26 V/m; Power Drift = -0.03 dB

Peak SAR (extrapolated) = 34.6 W/kg

**SAR(1 g) = 7.82 W/kg; SAR(10 g) = 2.17 W/kg**

Maximum value of SAR (measured) = 19.4 W/kg

**Z Scan (1x1x31):** Measurement grid: dx=20mm, dy=20mm, dz=5mm

Maximum value of SAR (measured) = 24.4 W/kg

Date: 2018/03/19

Ambient Temp. : 24.0 degree.C. Liquid Temp.; 23.5 degree.C.

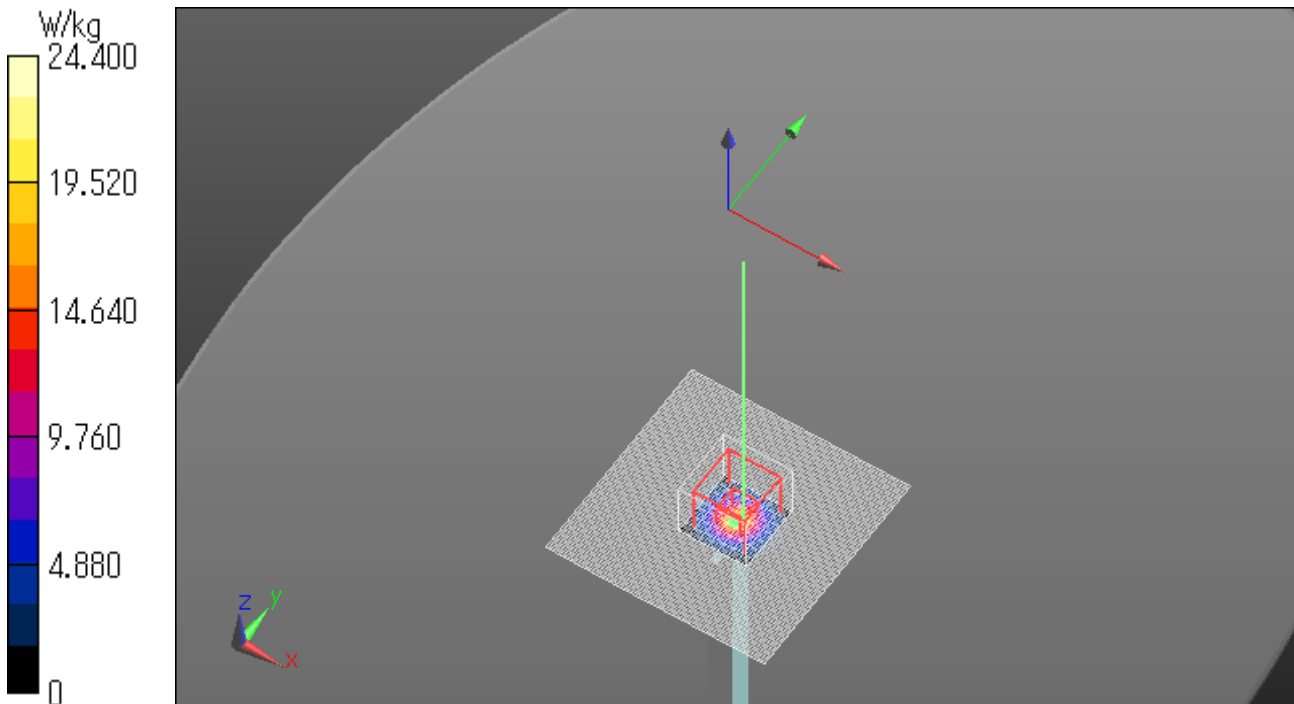

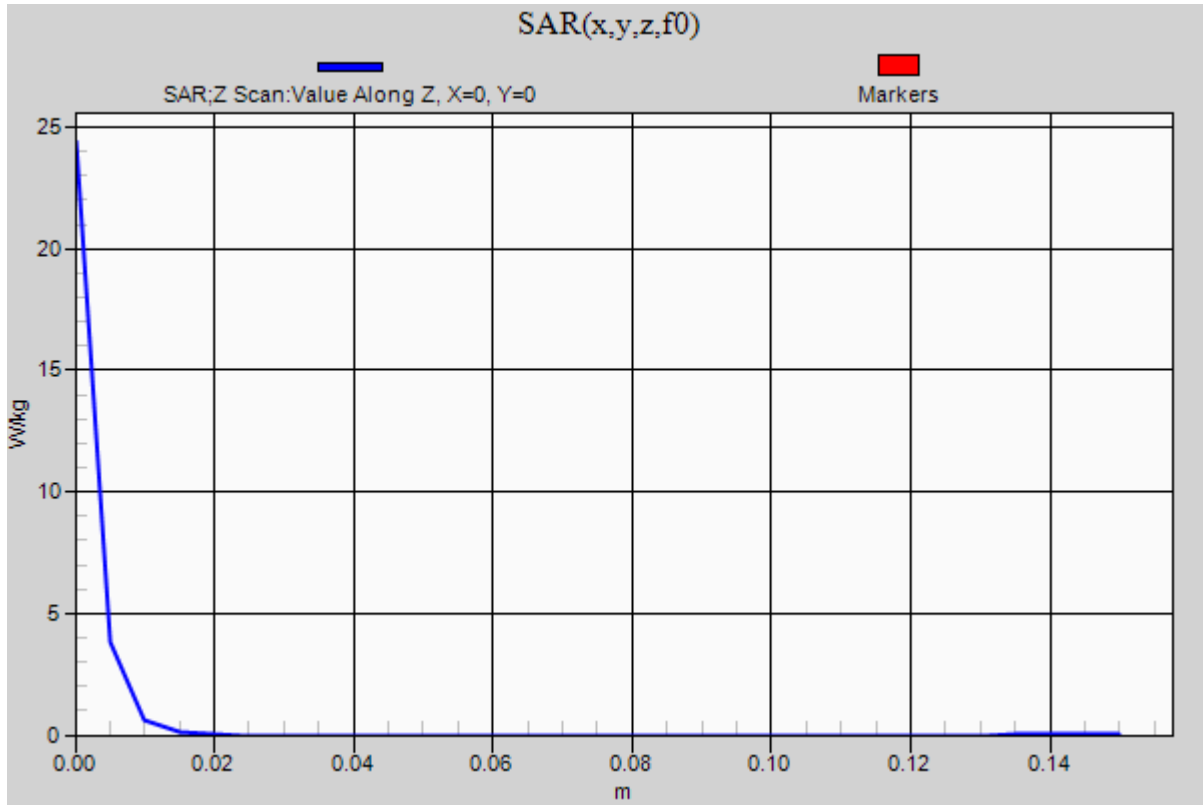

**20180320 Body 5750MHz System Check Power 100mW**

Communication System: UID 0, CW (0); Communication System Band: D5GHz (5000.0 - 6000.0 MHz); Frequency: 5750 MHz; Duty Cycle: 1:1

Medium parameters used:  $f = 5750$  MHz;  $\sigma = 6.025$  S/m;  $\epsilon_r = 48.411$ ;  $\rho = 1000$  kg/m<sup>3</sup>

Phantom section: Flat Section

Measurement Standard: DASY5 (IEEE/IEC/ANSI C63.19-2011)

DASY5 Configuration

Probe: EX3DV4 - SN3825; ConvF(4.28, 4.28, 4.28); Calibrated: 2017/12/11;

Sensor-Surface: 1.4mm (Mechanical Surface Detection), Sensor-Surface: 0mm (Fix Surface)

Electronics: DAE4 Sn509; Calibrated: 2017/07/11

Phantom: ELI v4.0 (20deg probe tilt); Type: QDOVA001BB; Serial: TP:1045

Measurement SW: DASY52, Version 52.8 (8); SEMCAD X Version 14.6.10 (7331)

**Area Scan (91x91x1):** Interpolated grid: dx=1.000 mm, dy=1.000 mm

Maximum value of SAR (interpolated) = 17.5 W/kg

**Zoom Scan (4x4x1.4mm, graded), dist=1.4mm (8x8x7)/Cube 0:** Measurement grid: dx=4mm, dy=4mm, dz=1.4mm

Reference Value = 62.84 V/m; Power Drift = -0.04 dB

Peak SAR (extrapolated) = 32.2 W/kg

**SAR(1 g) = 7.07 W/kg; SAR(10 g) = 1.97 W/kg**

Maximum value of SAR (measured) = 17.4 W/kg

**Z Scan (1x1x31):** Measurement grid: dx=20mm, dy=20mm, dz=5mm

Maximum value of SAR (measured) = 22.3 W/kg

Date: 2018/03/20

Ambient Temp. : 24.0 degree.C. Liquid Temp.; 23.5 degree.C.

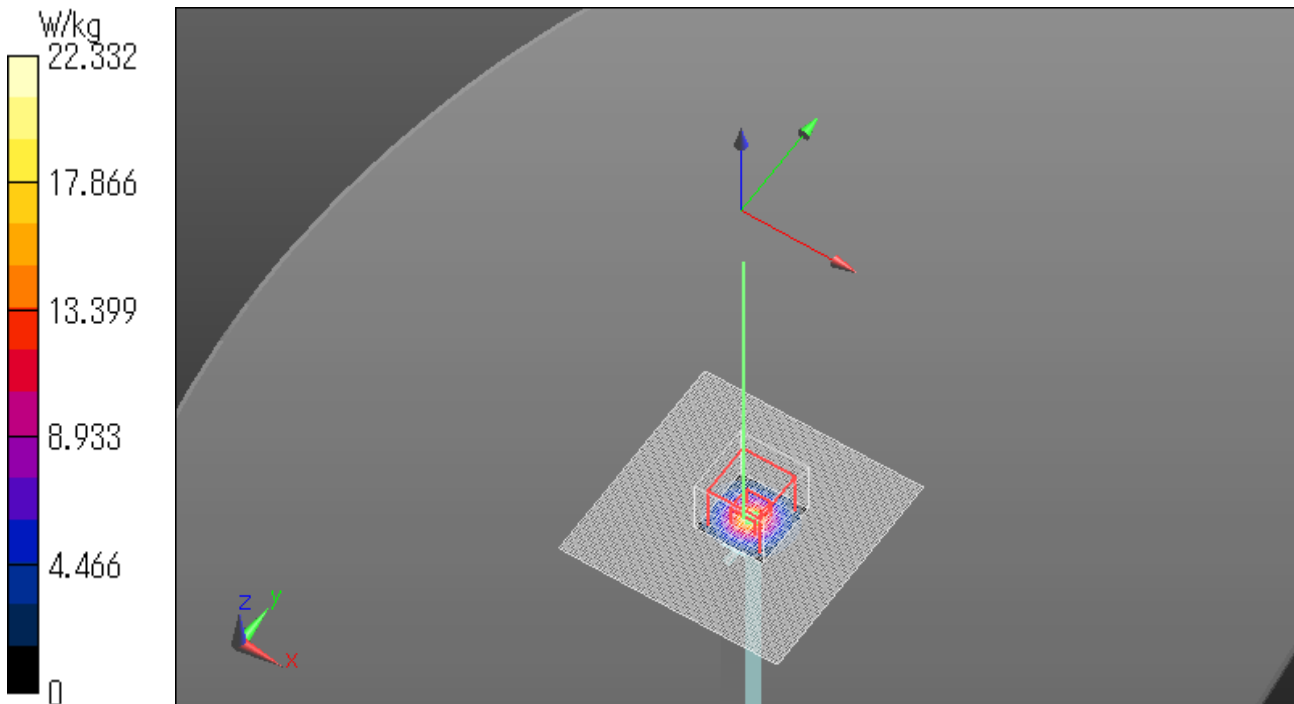

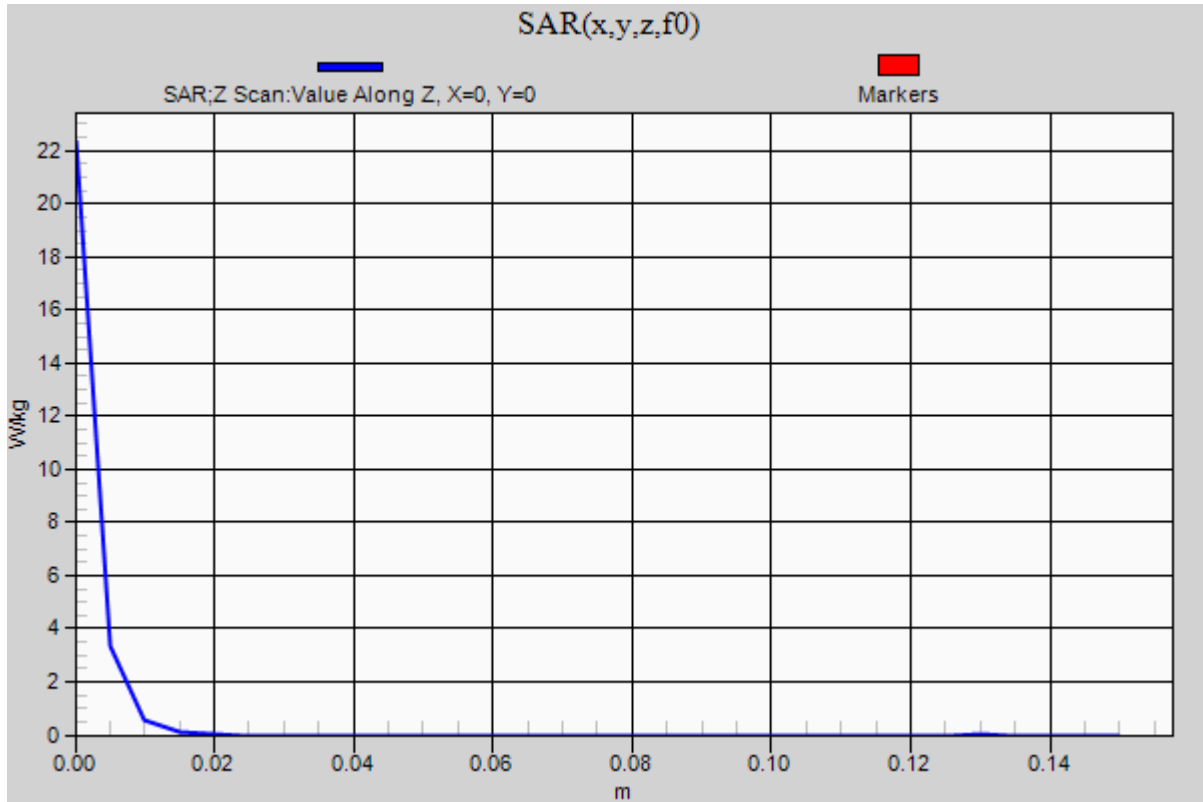

## **APPENDIX 2 : SAR Measurement data**

### **Evaluation procedure**

**The evaluation was performed with the following procedure:**

**Step 1:** Measurement of the E-field at a fixed location above the ear point or central position of flat phantom was used as a reference value for assessing the power drop.

**Step 2:** The SAR distribution at the exposed side of head or body position was measured at a distance of each device from the inner surface of the shell. The area covered the entire dimension of the antenna of EUT and the horizontal grid spacing was 15 mm x 15 mm, 12 mm x 12 mm or 10mm x 10mm. Based on these data, the area of the maximum absorption was determined by spline interpolation.

**Step 3:** Around this point found in the Step 2 (area scan), a volume of 30mm x 30mm x 30mm or more was assessed by measuring 7 x 7 x 7 points at least for below 3GHz and a volume of 28 mm x 28mm x 22.5mm or more was assessed by measuring 8 x 8 x 6(ratio step method (\*1)) points at least for 5GHz band.

And for any secondary peaks found in the Step2 which are within 2dB of maximum peak and not with this Step3 (Zoom scan) is repeated. On the basis of this data set, the spatial peak SAR value was evaluated under the following procedure:

(1). The data at the surface were extrapolated, since the center of the dipoles is 1mm(EX3DV4) away from the tip of the probe and the distance between the surface and the lowest measuring point is 1.3 mm. The extrapolation was based on a least square algorithm [4]. A polynomial of the fourth order was calculated through the points in z-axes. This polynomial was then used to evaluate the points between the surface and the probe tip.

(2). The maximum interpolated value was searched with a straightforward algorithm. Around this maximum the SAR values averaged over the spatial volumes (1 g or 10 g) were computed by the 3D-Spline interpolation algorithm. The 3D-Spline is composed of three one-dimensional splines with the "Not a knot"-condition (in x, y and z-directions) [4], [5]. The volume was integrated with the trapezoidal-algorithm. One thousand points (10 x 10 x 10) were interpolated to calculate the average.

(3). All neighboring volumes were evaluated until no neighboring volume with a higher average value was found.

**\*1. Ratio step method parameters used;**

**The first measurement point: 2mm from the phantom surface, the initial grid separation: 2mm, subsequent graded grid ratio: 1.5**

**These parameters comply with the requirement of the KDB 865664D01.**

**Step 4:** Re-measurement of the E-field at the same location as in Step 1.

Confirmation after SAR testing

It was checked that the power drift [W] is within +/-5%.The verification of power drift during the SAR test is that DASY5 system calculates the power drift by measuring the e-filed at the same location at beginning and the end of the scan measurement for each test position.

DASY5 system calculation Power drift value[dB] = $20\log(E_a)/(E_b)$

Before SAR testing :  $E_b[V/m]$

After SAR testing :  $E_a[V/m]$

Limit of power drift[W] = $\pm 5\%$

$X[dB]=10\log[P]=10\log(1.05/1)=10\log(1.05)-10\log(1)=0.212dB$

from E-filed relations with power.

$p=E^2/\eta=E^2/$

Therefore, The correlation of power and the E-filed

$XdB=10\log(P)=10\log(E)^2=20\log(E)$

Therefore,

The calculated power drift of DASY5 System must be the less than +/-0.212dB.

## Measurement data

Data was listed only worst plots in each bands according to KDB865664 D02 section 2.3h

### WLAN 2.4G 11b 2412MHz Left 0mm

Communication System: UID 0, WLAN (0); Communication System Band: 11b/g/n; Frequency: 2412 MHz; Duty Cycle: 1:1

Medium parameters used (interpolated):  $f = 2412$  MHz;  $\sigma = 1.887$  S/m;  $\epsilon_r = 52.979$ ;  $\rho = 1000$  kg/m<sup>3</sup>

Phantom section: Flat Section

Measurement Standard: DASY5 (IEEE/IEC/ANSI C63.19-2007)

DASY5 Configuration

Probe: EX3DV4 - SN3825; ConvF(7.77, 7.77, 7.77); Calibrated: 2017/12/11;

Sensor-Surface: 2mm (Mechanical Surface Detection)

Electronics: DAE4 Sn509; Calibrated: 2017/07/11

Phantom: ELI v4.0 (20deg probe tilt); Type: QDOVA001BB; Serial: TP:1045

Measurement SW: DASY52, Version 52.8 (8); SEMCAD X Version 14.6.10 (7331)

**Area Scan (71x91x1):** Interpolated grid: dx=1.200 mm, dy=1.200 mm

Maximum value of SAR (interpolated) = 1.61 W/kg

**Zoom Scan (7x7x7)/Cube 0:** Measurement grid: dx=5mm, dy=5mm, dz=5mm

Reference Value = 30.29 V/m; Power Drift = 0.11 dB

Peak SAR (extrapolated) = 2.82 W/kg

**SAR(1 g) = 0.896 W/kg; SAR(10 g) = 0.277 W/kg**

Maximum value of SAR (measured) = 1.66 W/kg

Date: 2018/03/05

Ambient Temp. : 24.0 degree.C. Liquid Temp.; 23.5 degree.C.

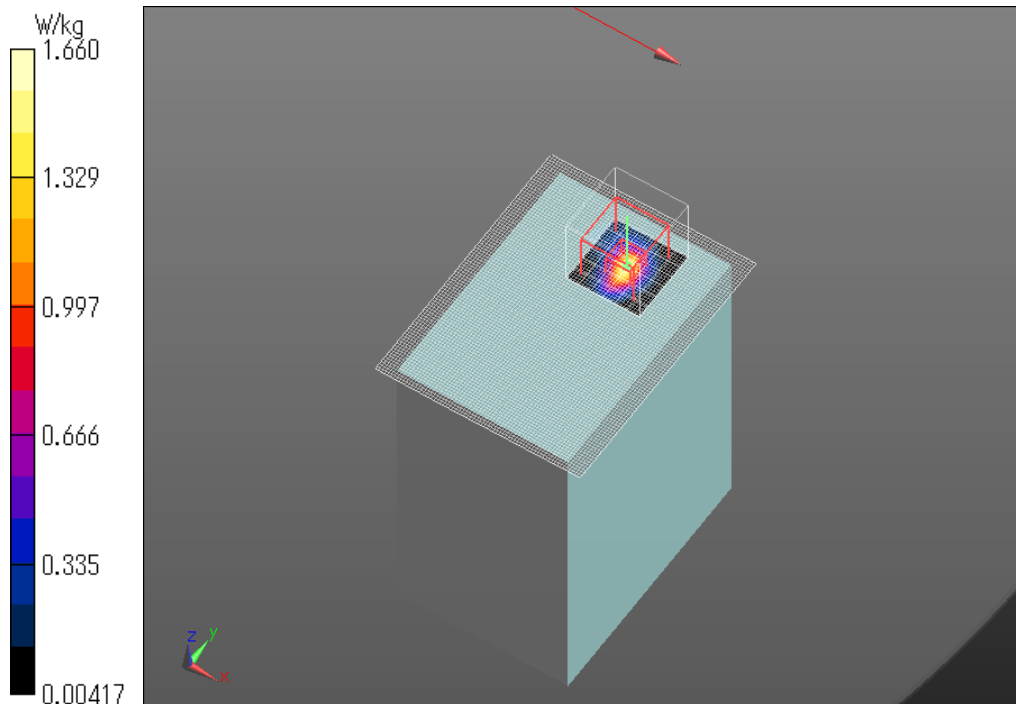



**WLAN 2.4G 11b 2412MHz Left 0mm\_Repeat**

Communication System: UID 0, WLAN (0); Communication System Band: 11b/g/n; Frequency: 2412 MHz; Duty Cycle: 1:1

Medium parameters used (interpolated):  $f = 2412$  MHz;  $\sigma = 1.887$  S/m;  $\epsilon_r = 52.979$ ;  $\rho = 1000$  kg/m<sup>3</sup>

Phantom section: Flat Section

Measurement Standard: DASY5 (IEEE/IEC/ANSI C63.19-2007)

DASY5 Configuration

Probe: EX3DV4 - SN3825; ConvF(7.77, 7.77, 7.77); Calibrated: 2017/12/11;

Sensor-Surface: 2mm (Mechanical Surface Detection)

Electronics: DAE4 Sn509; Calibrated: 2017/07/11

Phantom: ELI v4.0 (20deg probe tilt); Type: QDOVA001BB; Serial: TP:1045

Measurement SW: DASY52, Version 52.8 (8); SEMCAD X Version 14.6.10 (7331)

**Area Scan (71x91x1):** Interpolated grid: dx=1.200 mm, dy=1.200 mm

Maximum value of SAR (interpolated) = 1.61 W/kg

**Zoom Scan (7x7x7)/Cube 0:** Measurement grid: dx=5mm, dy=5mm, dz=5mm

Reference Value = 29.55 V/m; Power Drift = -0.14 dB

Peak SAR (extrapolated) = 2.40 W/kg

**SAR(1 g) = 0.849 W/kg; SAR(10 g) = 0.269 W/kg**

Maximum value of SAR (measured) = 1.59 W/kg

Date: 2018/03/05

Ambient Temp. : 24.0 degree.C. Liquid Temp.; 23.5 degree.C.

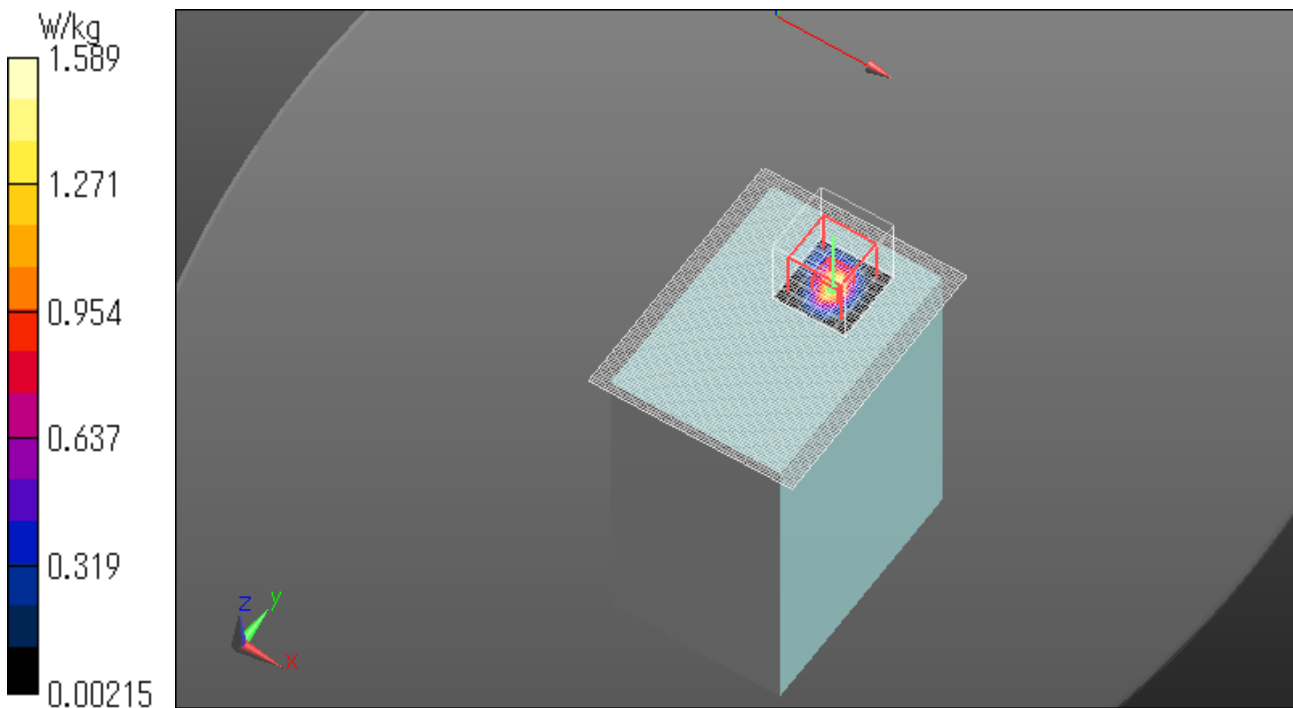

**Bluetooth 2.4G DH5 2402MHz Left 0mm**

Communication System: UID 0, Bluetooth (0); Communication System Band: DH5; Frequency: 2402 MHz; Duty Cycle: 1:1

Medium parameters used (interpolated):  $f = 2402$  MHz;  $\sigma = 1.885$  S/m;  $\epsilon_r = 53.152$ ;  $\rho = 1000$  kg/m<sup>3</sup>

Phantom section: Flat Section

Measurement Standard: DASYS5 (IEEE/IEC/ANSI C63.19-2007)

DASY5 Configuration

Probe: EX3DV4 - SN3922; ConvF(7.68, 7.68, 7.68); Calibrated: 2017/11/15;

Sensor-Surface: 2mm (Mechanical Surface Detection)

Electronics: DAE4 Sn1372; Calibrated: 2017/06/13

Phantom: ELI v5.0 (30deg probe tilt); Type: QDOVA001BB; Serial: TP:1207

Measurement SW: DASYS2, Version 52.8 (8); SEMCAD X Version 14.6.10 (7331)

**Area Scan (71x91x1):** Interpolated grid:  $dx=1.200$  mm,  $dy=1.200$  mm

Maximum value of SAR (interpolated) = 0.380 W/kg

**Zoom Scan (7x7x7)/Cube 0:** Measurement grid:  $dx=5$ mm,  $dy=5$ mm,  $dz=5$ mm

Reference Value = 17.00 V/m; Power Drift = -0.09 dB

Peak SAR (extrapolated) = 0.834 W/kg

**SAR(1 g) = 0.280 W/kg; SAR(10 g) = 0.090 W/kg**

Maximum value of SAR (measured) = 0.529 W/kg

Date: 2018/03/15

Ambient Temp. : 24.0 degree.C. Liquid Temp.; 23.5 degree.C.

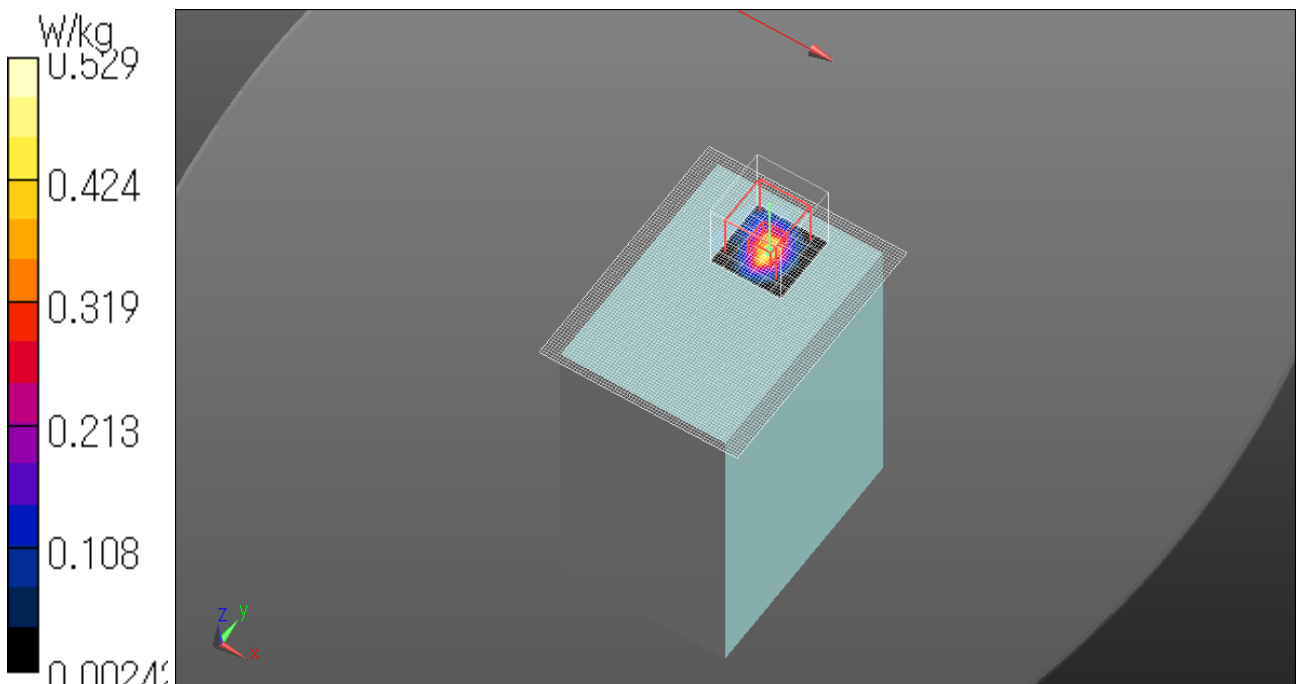

**WLAN 5.3G 11n40 5310MHz Left 0mm**

Communication System: UID 0, WLAN 11a/b/g/n (0); Communication System Band: 11a/n (W52 53); Frequency: 5310 MHz; Duty Cycle: 1:1

Medium parameters used:  $f = 5310$  MHz;  $\sigma = 5.454$  S/m;  $\epsilon_r = 48.704$ ;  $\rho = 1000$  kg/m<sup>3</sup>

Phantom section: Flat Section

Measurement Standard: DASY5 (IEEE/IEC/ANSI C63.19-2007)

DASY5 Configuration

Probe: EX3DV4 - SN3825; ConvF(4.69, 4.69, 4.69); Calibrated: 2017/12/11;

Sensor-Surface: 1.4mm (Mechanical Surface Detection)

Electronics: DAE4 Sn509; Calibrated: 2017/07/11

Phantom: ELI v4.0 (20deg probe tilt); Type: QDOVA001BB; Serial: TP:1045

Measurement SW: DASY52, Version 52.8 (8); SEMCAD X Version 14.6.10 (7331)

**Area Scan (81x111x1):** Interpolated grid: dx=1.000 mm, dy=1.000 mm

Maximum value of SAR (interpolated) = 1.56 W/kg

**Zoom Scan (9x9x7)/Cube 0:** Measurement grid: dx=4mm, dy=4mm, dz=1.4mm

Reference Value = 18.46 V/m; Power Drift = -0.17 dB

Peak SAR (extrapolated) = 4.70 W/kg

**SAR(1 g) = 0.800 W/kg; SAR(10 g) = 0.189 W/kg**

Maximum value of SAR (measured) = 2.41 W/kg

Date: 2018/03/07

Ambient Temp. : 24.0 degree.C. Liquid Temp.; 23.5 degree.C.

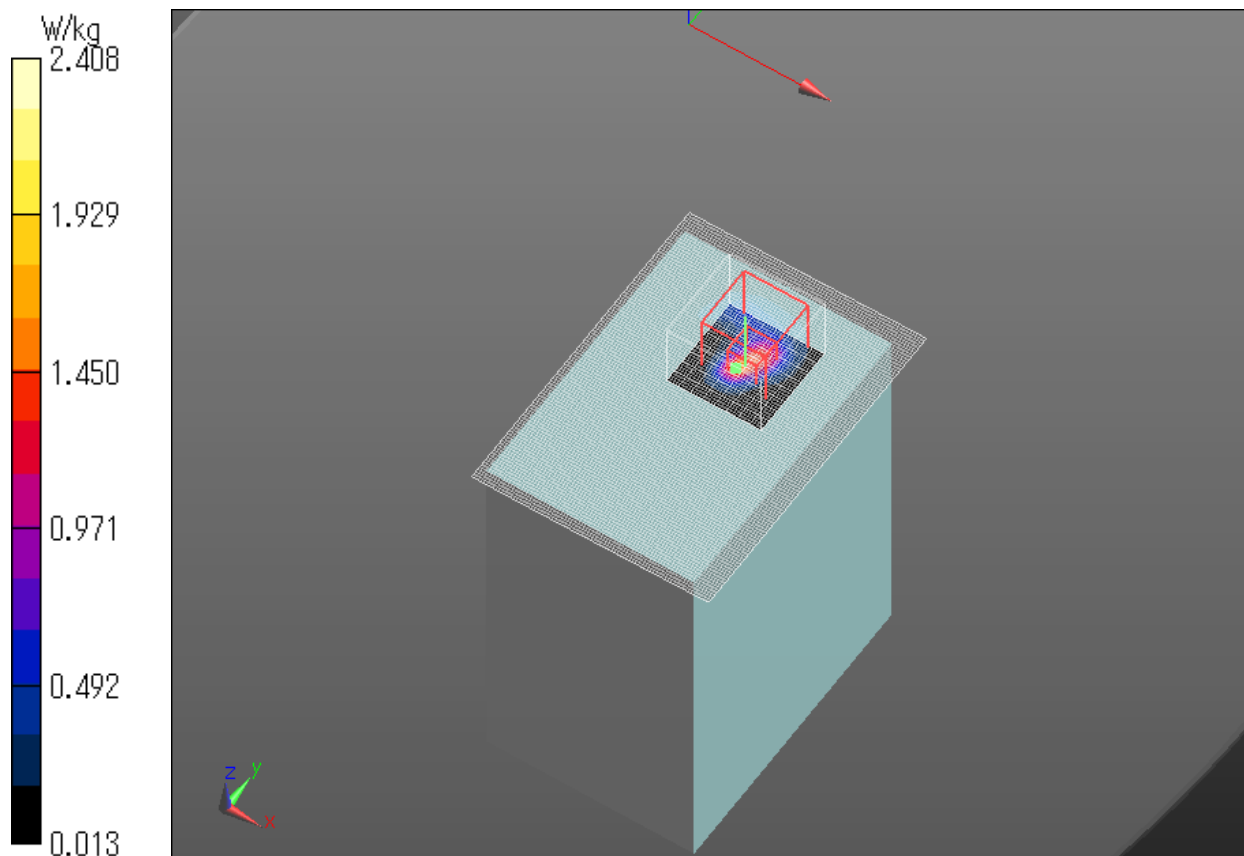

### WLAN 5.3G 11n40 5310MHz Left 0mm\_Repeat

Communication System: UID 0, WLAN 11a/b/g/n (0); Communication System Band: 11a/n (W52 53); Frequency: 5310 MHz; Duty Cycle: 1:1

Medium parameters used:  $f = 5310$  MHz;  $\sigma = 5.454$  S/m;  $\epsilon_r = 48.704$ ;  $\rho = 1000$  kg/m<sup>3</sup>

Phantom section: Flat Section

Measurement Standard: DASY5 (IEEE/IEC/ANSI C63.19-2007)

DASY5 Configuration

Probe: EX3DV4 - SN3825; ConvF(4.69, 4.69, 4.69); Calibrated: 2017/12/11;

Sensor-Surface: 1.4mm (Mechanical Surface Detection)

Electronics: DAE4 Sn509; Calibrated: 2017/07/11

Phantom: ELI v4.0 (20deg probe tilt); Type: QDOVA001BB; Serial: TP:1045

Measurement SW: DASY52, Version 52.8 (8); SEMCAD X Version 14.6.10 (7331)

**Area Scan (81x111x1):** Interpolated grid: dx=1.000 mm, dy=1.000 mm

Maximum value of SAR (interpolated) = 1.49 W/kg

**Zoom Scan (9x9x7)/Cube 0:** Measurement grid: dx=4mm, dy=4mm, dz=1.4mm

Reference Value = 18.19 V/m; Power Drift = -0.15 dB

Peak SAR (extrapolated) = 4.62 W/kg

**SAR(1 g) = 0.797 W/kg; SAR(10 g) = 0.188 W/kg**

Maximum value of SAR (measured) = 2.37 W/kg

Date: 2018/03/07

Ambient Temp. : 24.0 degree.C. Liquid Temp.; 23.5 degree.C.

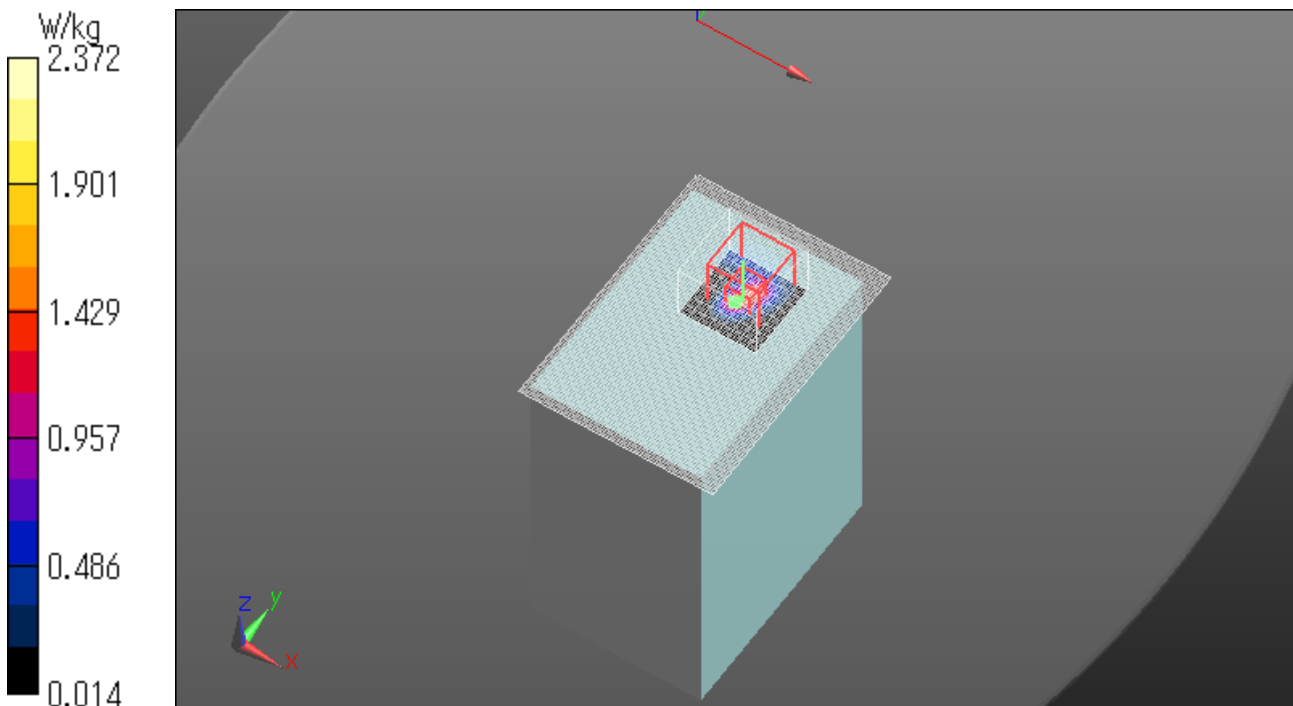

**WLAN 5.5G 11ac80 5530MHz Left 0mm**

Communication System: UID 0, WLAN 11a/b/g/n (0); Communication System Band: 11a/n (W56); Frequency: 5530 MHz; Duty Cycle: 1:1

Medium parameters used:  $f = 5530$  MHz;  $\sigma = 5.707$  S/m;  $\epsilon_r = 48.553$ ;  $\rho = 1000$  kg/m<sup>3</sup>

Phantom section: Flat Section

Measurement Standard: DASYS (IEEE/IEC/ANSI C63.19-2007)

DASY5 Configuration

Probe: EX3DV4 - SN3825; ConvF(3.96, 3.96, 3.96); Calibrated: 2017/12/11;

Sensor-Surface: 1.4mm (Mechanical Surface Detection)

Electronics: DAE4 Sn509; Calibrated: 2017/07/11

Phantom: ELI v4.0 (20deg probe tilt); Type: QDOVA001BB; Serial: TP:1045

Measurement SW: DASYS2, Version 52.8 (8); SEMCAD X Version 14.6.10 (7331)

**Area Scan (81x111x1):** Interpolated grid: dx=1.000 mm, dy=1.000 mm

Maximum value of SAR (interpolated) = 1.37 W/kg

**Zoom Scan (8x8x7)/Cube 0:** Measurement grid: dx=4mm, dy=4mm, dz=1.4mm

Reference Value = 19.36 V/m; Power Drift = -0.06 dB

Peak SAR (extrapolated) = 4.32 W/kg

**SAR(1 g) = 0.598 W/kg; SAR(10 g) = 0.104 W/kg**

Maximum value of SAR (measured) = 2.49 W/kg

Date: 2018/03/19

Ambient Temp. : 24.0 degree.C. Liquid Temp.; 23.5 degree.C.

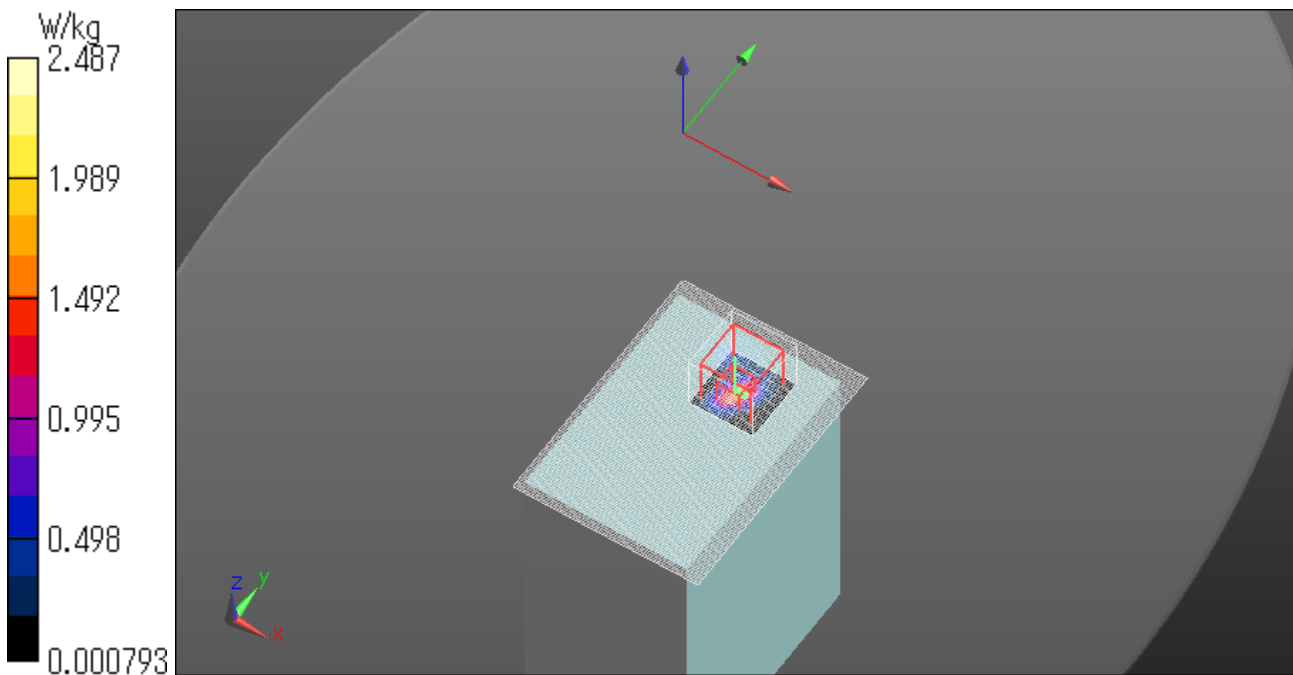

**WLAN 5.8G 11ac80 5775MHz Left 0mm**

Communication System: UID 0, WLAN 11a/b/g/n (0); Communication System Band: 11ac80(W58); Frequency: 5775 MHz; Duty Cycle: 1:1

Medium parameters used (interpolated):  $f = 5775$  MHz;  $\sigma = 6.044$  S/m;  $\epsilon_r = 48.432$ ;  $\rho = 1000$  kg/m<sup>3</sup>

Phantom section: Flat Section

Measurement Standard: DASYS (IEEE/IEC/ANSI C63.19-2007)

DASY5 Configuration

Probe: EX3DV4 - SN3825; ConvF(4.28, 4.28, 4.28); Calibrated: 2017/12/11;

Sensor-Surface: 1.4mm (Mechanical Surface Detection)

Electronics: DAE4 Sn509; Calibrated: 2017/07/11

Phantom: ELI v4.0 (20deg probe tilt); Type: QDOVA001BB; Serial: TP:1045

Measurement SW: DASYS2, Version 52.8 (8); SEMCAD X Version 14.6.10 (7331)

**Area Scan (81x111x1):** Interpolated grid: dx=1.000 mm, dy=1.000 mm

Maximum value of SAR (interpolated) = 1.68 W/kg

**Zoom Scan (8x8x7)/Cube 0:** Measurement grid: dx=4mm, dy=4mm, dz=1.4mm

Reference Value = 20.23 V/m; Power Drift = -0.03 dB

Peak SAR (extrapolated) = 5.57 W/kg

**SAR(1 g) = 0.866 W/kg; SAR(10 g) = 0.179 W/kg**

Maximum value of SAR (measured) = 2.42 W/kg

Date: 2018/03/20

Ambient Temp. : 24.0 degree.C. Liquid Temp.; 23.5 degree.C.

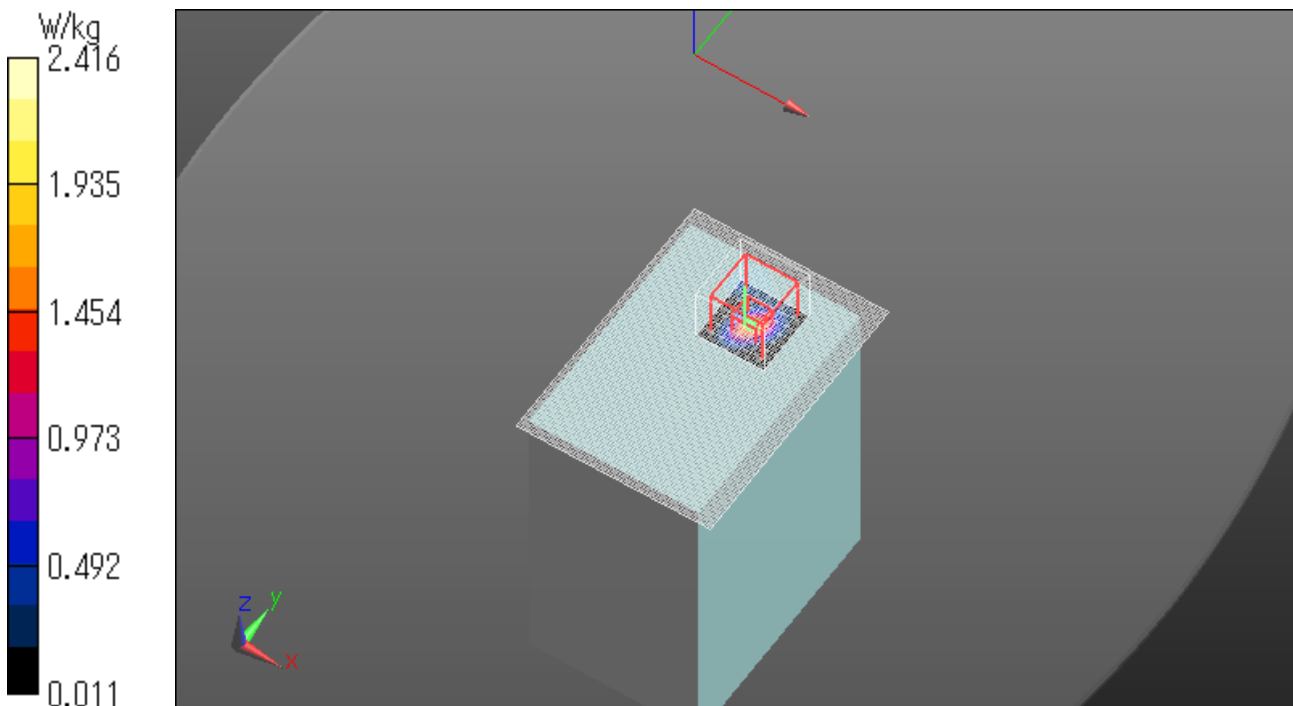

**WLAN 5.8G 11ac80 5775MHz Left 0mm\_Repeat**

Communication System: UID 0, WLAN 11a/b/g/n (0); Communication System Band: 11ac80(W58); Frequency: 5775 MHz; Duty Cycle: 1:1

Medium parameters used (interpolated):  $f = 5775$  MHz;  $\sigma = 6.044$  S/m;  $\epsilon_r = 48.432$ ;  $\rho = 1000$  kg/m<sup>3</sup>

Phantom section: Flat Section

Measurement Standard: DASY5 (IEEE/IEC/ANSI C63.19-2007)

DASY5 Configuration

Probe: EX3DV4 - SN3825; ConvF(4.28, 4.28, 4.28); Calibrated: 2017/12/11;

Sensor-Surface: 1.4mm (Mechanical Surface Detection)

Electronics: DAE4 Sn509; Calibrated: 2017/07/11

Phantom: ELI v4.0 (20deg probe tilt); Type: QDOVA001BB; Serial: TP:1045

Measurement SW: DASY52, Version 52.8 (8); SEMCAD X Version 14.6.10 (7331)

**Area Scan (81x111x1):** Interpolated grid: dx=1.000 mm, dy=1.000 mm

Maximum value of SAR (interpolated) = 1.58 W/kg

**Zoom Scan (8x8x7)/Cube 0:** Measurement grid: dx=4mm, dy=4mm, dz=1.4mm

Reference Value = 20.25 V/m; Power Drift = -0.16 dB

Peak SAR (extrapolated) = 5.50 W/kg

**SAR(1 g) = 0.853 W/kg; SAR(10 g) = 0.176 W/kg**

Maximum value of SAR (measured) = 2.39 W/kg

Date: 2018/03/20

Ambient Temp. : 24.0 degree.C. Liquid Temp.; 23.5 degree.C.

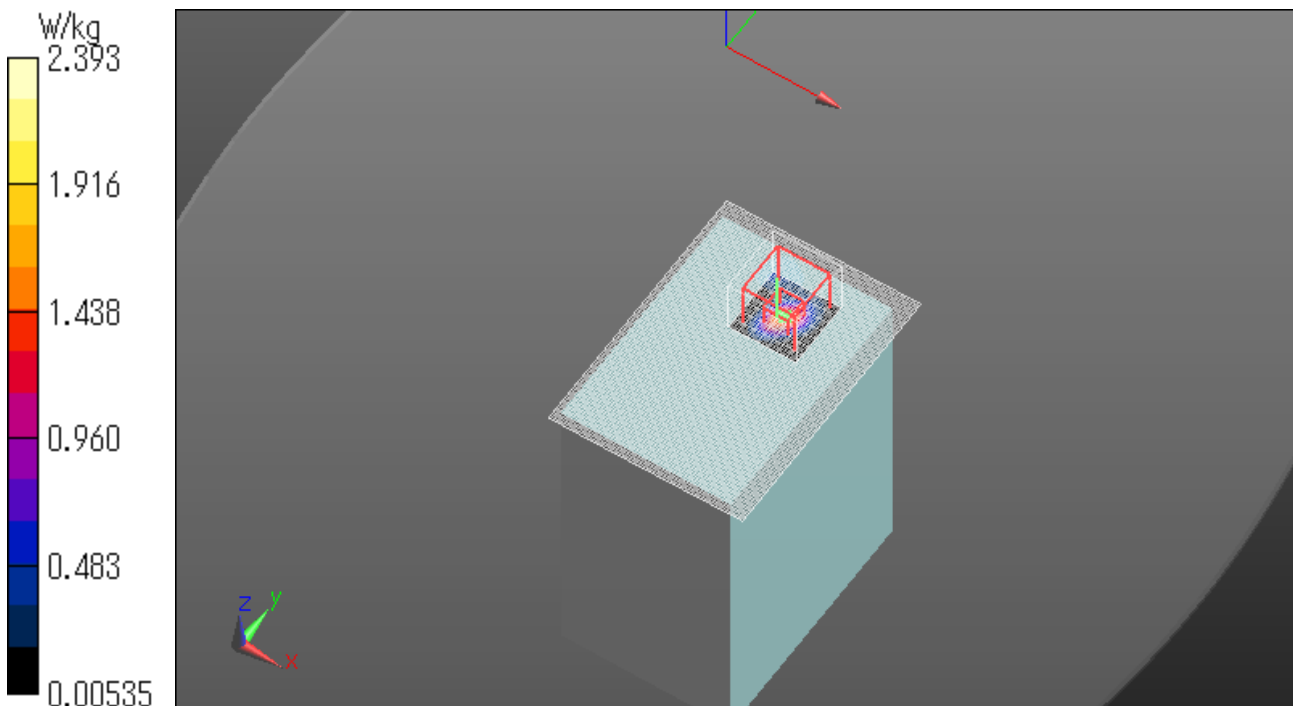

## APPENDIX 3 : System specifications

### Configuration and peripherals

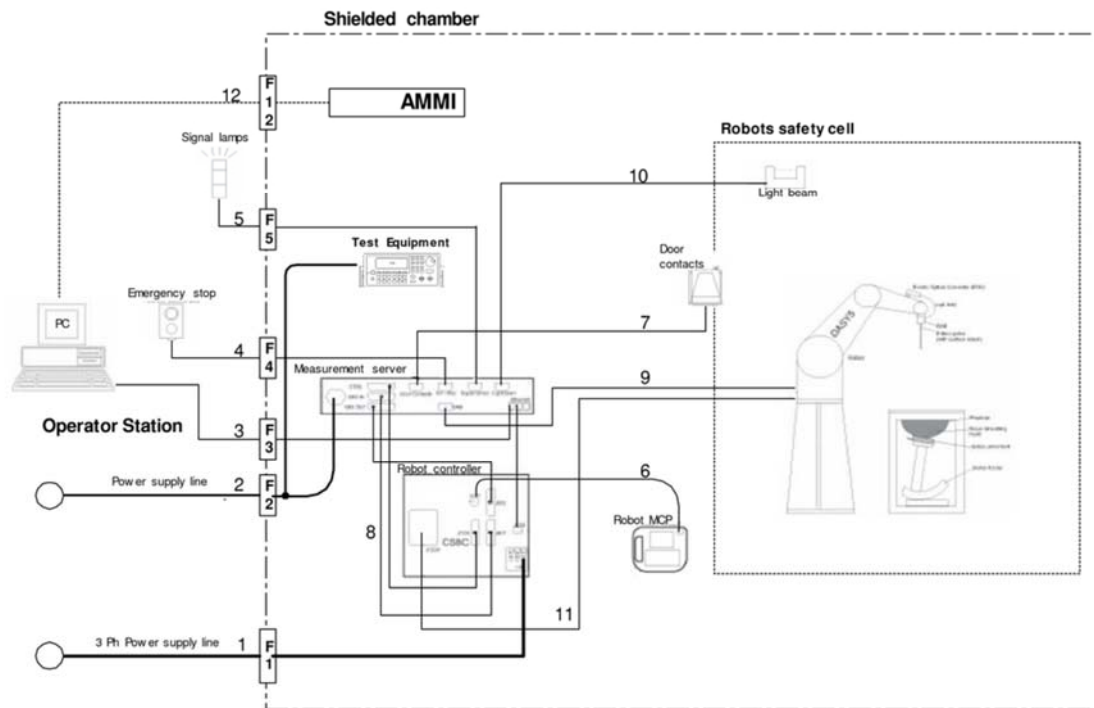

The DASYS system for performing compliance tests consist of the following items:

- a) A standard high precision 6-axis robot (Stäubli RX family) with controller and software.  
An arm extension for accommodating the data acquisition electronics (DAE).
- b) An isotropic field probe optimized and calibrated for the targeted measurement.
- c) A data acquisition electronic (DAE), which performs the signal amplification, signal multiplexing, AD-conversion, offset measurements, mechanical surface detection, collision detection, etc. The unit is battery powered with standard or rechargeable batteries. The signal is optically transmitted to the EOC.
- d) The Electro-optical converter (EOC) performs the conversion between optical and electrical of the signals for the digital communication to the DAE and for the analog signal from the optical surface detection.  
The EOC is connected to the measurement server.
- e) The function of the measurement server is to perform the time critical tasks such as signal filtering, control of the robot operation and fast movement interrupts.
- f) The Light Beam used is for probe alignment. This improves the (absolute) accuracy of the probe positioning.
- g) A computer running WinXP and the DASYS software.
- h) Remote control with teaches pendant and additional circuitry for robot safety such as warning lamps, etc.
- i) The phantom, the device holder and other accessories according to the targeted measurement.



## Specifications

### a)Robot TX60L

Number of Axes	:	6
Nominal Load	:	2 kg
Maximum Load	:	5kg
Reach	:	920mm
Repeatability	:	+/-0.03mm
Control Unit	:	CS8c
Programming Language	:	VAL3
Weight	:	52.2kg
Manufacture	:	Stäubli Robotics

### b)E-Field Probe

Model	:	EX3DV4
Construction	:	Symmetrical design with triangular core Built-in shielding against static charges PEEK enclosure material (resistant to organic solvents, e.g., glycol ether)
Frequency	:	10 MHz to > 6 GHz Linearity: $\pm 0.2$ dB (30 MHz to 6 GHz)
Directivity	:	+/-0.3 dB in HSL (rotation around probe axis) +/-0.5 dB in tissue material (rotation normal probe axis)
Dynamic Range	:	10uW/g to > 100 mW/g;Linearity +/-0.2 dB(noise: typically < 1uW/g)
Dimensions	:	Overall length: 337 mm (Tip: 20 mm) Tip diameter: 2.5mm (Body: 12 mm) Typical distance from probe tip to dipole centers: 1 mm
Application	:	Highprecision dosimetric measurement in any exposure scenario (e.g., very strong gradient fields).Only probe which enables compliance testing for frequencies up to 6GHz with precision of better 30%.
Manufacture	:	Schmid & Partner Engineering AG



**EX3DV4 E-field Probe**

#### **c)Data Acquisition Electronic (DAE4)**

<b>Features</b>	:	Signal amplifier, multiplexer, A/D converter and control logic Serial optical link for communication with DASY5 embedded system (fully remote controlled) Two step probe touch detector for mechanical surface detection and emergency robot stop
<b>Measurement Range</b>	:	-100 to +300 mV (16 bit resolution and two range settings: 4mV, 400mV)
<b>Input Offset voltage</b>	:	< 5 $\mu$ V (with auto zero)
<b>Input Resistance</b>	:	200 M $\Omega$
<b>Input Bias Current</b>	:	< 50 fA
<b>Battery Power</b>	:	> 10 h of operation (with two 9.6 V NiMH accus)
<b>Dimension</b>	:	60 x 60 x 68 mm
<b>Manufacture</b>	:	Schmid & Partner Engineering AG

#### **d)Electro-Optic Converter (EOC)**

<b>Version</b>	:	EOC 61
<b>Description</b>	:	for TX60 robot arm, including proximity sensor
<b>Manufacture</b>	:	Schmid & Partner Engineering AG

#### **e)DASY5 Measurement server**

<b>Features</b>	:	Intel ULV Celeron 400MHz 128MB chip disk and 128MB RAM 16 Bit A/D converter for surface detection system Vacuum Fluorescent Display Robot Interface Serial link to DAE (with watchdog supervision) Door contact port (Possibility to connect a light curtain) Emergency stop port (to connect the remote control) Signal lamps port Light beam port Three Ethernet connection ports Two USB 2.0 Ports Two serial links Expansion port for future applications
<b>Dimensions (L x W x H)</b>	:	440 x 241 x 89 mm
<b>Manufacture</b>	:	Schmid & Partner Engineering AG

#### **f) Light Beam Switches**

<b>Version</b>	:	LB5
<b>Dimensions (L x H)</b>	:	110 x 80 mm
<b>Thickness</b>	:	12 mm
<b>Beam-length</b>	:	80 mm
<b>Manufacture</b>	:	Schmid & Partner Engineering AG

#### **g)Software**

<b>Item</b>	:	Dosimetric Assessment System DASY5
<b>Type No.</b>	:	SD 000 401A, SD 000 402A
<b>Software version No.</b>	:	DASY52, Version 52.6 (1)
<b>Manufacture / Origin</b>	:	Schmid & Partner Engineering AG

#### **h)Robot Control Unit**

<b>Weight</b>	:	70 Kg
<b>AC Input Voltage</b>	:	selectable
<b>Manufacturer</b>	:	Stäubli Robotics

## i)Phantom and Device Holder

### Phantom

<b>Type</b>	:	SAM Twin Phantom V4.0
<b>Description</b>	:	The shell corresponds to the specifications of the Specific Anthropomorphic Mannequin (SAM) phantom defined in IEEE 1528 and IEC 62209-1. It enables the dosimetric evaluation of left and right hand phone usage as well as body mounted usage at the flat phantom region. A cover prevents evaporation of the liquid. Reference markings on the phantom allow the complete setup of all predefined phantom positions and measurement grids by teaching three points with the robot.
<b>Material</b>	:	Vinylester, glass fiber reinforced (VE-GF)
<b>Shell Material</b>	:	Fiberglass
<b>Thickness</b>	:	2.0 +/-0.2 mm
<b>Dimensions</b>	:	Length: 1000 mm Width: 500 mm Height: adjustable feet
<b>Volume</b>	:	Approx. 25 liters
<b>Manufacture</b>	:	Schmid & Partner Engineering AG

<b>Type</b>	:	2mm Flat phantom ERI4.0
<b>Description</b>	:	Phantom for compliance testing of handheld and body-mounted wireless devices in the frequency range of 30 MHz to 6 GHz. ELI4 is fully compatible with the latest draft of the standard IEC 62209 Part II and all known tissue simulating liquids. ELI4 has been optimized regarding its performance and can be integrated into our standard phantom tables. A cover prevents evaporation of the liquid. Reference markings on the phantom allow installation of the complete setup, including all predefined phantom positions and measurement grids, by teaching three points. The phantom is supported by software version DASY4.5 and higher and is compatible with all SPEAG dosimetric probes and dipoles.
<b>Material</b>	:	Vinylester, glass fiber reinforced (VE-GF)
<b>Shell Thickness</b>	:	2.0 ± 0.2 mm (sagging: <1%)
<b>Filling Volume</b>	:	approx. 30 liters
<b>Dimensions</b>	:	Major ellipse axis: 600 mm Minor axis: 400 mm
<b>Manufacture</b>	:	Schmid & Partner Engineering AG

### Device Holder

In combination with the Twin SAM Phantom V4.0/V4.0c or ELI4, the Mounting Device enables the rotation of the mounted transmitter device in spherical coordinates. Rotation point is the ear opening point. Transmitter devices can be easily and accurately positioned according to IEC, IEEE, FCC or other specifications. The device holder can be locked for positioning at different phantom sections (left head, right head, flat).

<b>Material</b>	:	POM
-----------------	---	-----

### Laptio Extensions kit

Simple but effective and easy-to-use extension for Mounting Device that facilitates the testing of larger devices according to IEC 62209-2 (e.g., laptops, cameras, etc.). It is lightweight and fits easily on the upper part of the Mounting Device in place of the phone positioner. The extension is fully compatible with the Twin-SAM, ELI4 Phantoms.

<b>Material</b>	:	POM, Acrylic glass, Foam
-----------------	---	--------------------------

### Urethane

For this measurement, the urethane foam was used as device holder.

**j) Simulated Tissues (Liquid)**

The following tissue formulations are provided for reference only as some of the parameters have not been thoroughly verified. The composition of ingredients may be modified accordingly to achieve the desired target tissue parameters required for routine SAR evaluation.

Mixture (%)	Frequency (MHz)									
	450		900		1800		1950		2450	
Tissue Type	Head	Body	Head	Body	Head	Body	Head	Body	Head	Body
Water	38.91	46.21	40.29	50.75	55.24	70.17	55.41	69.79	55.0	68.64
Sugar	56.93	51.17	57.90	48.21	-	-	-	-	-	-
Cellulose	0.25	0.18	0.24	0.00	-	-	-	-	-	-
Salt (NaCl)	3.79	2.34	1.38	0.94	0.31	0.39	0.08	0.2	-	-
Preventol	0.12	0.08	0.18	0.10	-	-	-	-	-	-
DGMBE	-	-	-	-	44.45	29.44	44.51	30.0	45.0	31.37
Dielectric Constant	43.42	58.0	42.54	56.1	42.0	56.8	39.9	54.0	39.8	52.5
Conductivity (S/m)	0.85	0.83	0.91	0.95	1.0	1.07	1.42	1.45	1.88	1.78

Note: DGMBE (Diethylenglycol-monobuthyl ether)

The simulated tissue (liquid) of 1800MHz was used for the test frequency of 1700MHz to 1800MHz.

Mixture (%)	Frequency (MHz)	
	650&750	1450
Tissue Type	Head and Body	Head and Body
Water	35-58%	52-75%
Sugar	40-60%	-
Cellulose	<0.3%	-
Salt (NaCl)	0-6%	<1%
Preventol	0.1-0.7%	-
DGMBE	-	25-48%

Mixture (%)	Frequency (MHz)	
	5800	
Tissue Type	Head	Body
Water	64.0	78.0
Mineral Oil	18.0	11.0
Emulsifiers	15.0	9.0
Additives and salt	3.0	2.0

**System Check Dipole SAR Calibration Certificate -Dipole 2450MHz(D2450V2,S/N:713)**

**Calibration Laboratory of  
Schmid & Partner  
Engineering AG**  
Zeughausstrasse 43, 8004 Zurich, Switzerland



**S** Schweizerischer Kalibrierdienst  
**C** Service suisse d'étalonnage  
**S** Servizio svizzero di taratura  
**S** Swiss Calibration Service

Accredited by the Swiss Accreditation Service (SAS)  
The Swiss Accreditation Service is one of the signatories to the EA  
Multilateral Agreement for the recognition of calibration certificates

Accreditation No.: **SCS 0108**

Client **UL Japan (Vitec)**

Certificate No: **D2450V2-713\_Sep16**

**CALIBRATION CERTIFICATE**

Object: **D2450V2 - SN:713**

Calibration procedure(s): **QA GAL-05.v9  
Calibration procedure for dipole validation kits above 700 MHz**

Calibration date: **September 13, 2016**

This calibration certificate documents the traceability to national standards, which realize the physical units of measurements (SI).  
The measurements and the uncertainties with confidence probability are given on the following pages and are part of the certificate.

All calibrations have been conducted in the closed laboratory facility: environment temperature (22 ± 3)°C and humidity < 70%.

Calibration Equipment used (M&TE critical for calibration)

Primary Standards	ID #	Cal Date (Certificate No.)	Scheduled Calibration
Power meter NRP	SN: 104778	06-Apr-16 (No. 217-02288/02289)	Apr-17
Power sensor NRP-Z91	SN: 103244	06-Apr-16 (No. 217-02288)	Apr-17
Power sensor NRP-Z91	SN: 103245	06-Apr-16 (No. 217-02289)	Apr-17
Reference 20 dB Attenuator	SN: 5058 (20k)	05-Apr-16 (No. 217-02292)	Apr-17
Type-N mismatch combination	SN: 5047.2 / 06327	05-Apr-16 (No. 217-02295)	Apr-17
Reference Probe EX3DV4	SN: 7349	15-Jun-16 (No. EX3-7349_Jun16)	Jun-17
DAE4	SN: 601	30-Dec-15 (No. DAE4-601_Dec15)	Dec-16
Secondary Standards	ID #	Check Date (in house)	Scheduled Check
Power meter EPM-442A	SN: GB37480704	07-Oct-15 (No. 217-02222)	in house check: Oct-16
Power sensor HP 8481A	SN: US37292783	07-Oct-15 (No. 217-02222)	in house check: Oct-16
Power sensor HP 8481A	SN: MY41092317	07-Oct-15 (No. 217-02223)	in house check: Oct-16
RF generator R&S SMT-06	SN: 100972	15-Jun-15 (in house check Jun-15)	in house check: Oct-16
Network Analyzer HP 8753E	SN: US37390585	18-Oct-01 (in house check Oct-15)	in house check: Oct-16

Calibrated by: **Jeton Kastrati** (Name), **Laboratory Technician** (Function), [Signature]

Approved by: **Katja Pokovic** (Name), **Technical Manager** (Function), [Signature]

Issued: September 13, 2016

This calibration certificate shall not be reproduced except in full without written approval of the laboratory.

**Calibration Laboratory of  
Schmid & Partner  
Engineering AG**  
Zeughausstrasse 43, 8004 Zurich, Switzerland



**S** Schweizerischer Kalibrierdienst  
**C** Service suisse d'étalonnage  
**S** Servizio svizzero di taratura  
**S** Swiss Calibration Service

Accredited by the Swiss Accreditation Service (SAS)  
The Swiss Accreditation Service is one of the signatories to the EA  
Multilateral Agreement for the recognition of calibration certificates

Accreditation No.: **SCS 0108**

**Glossary:**

TSL tissue simulating liquid  
ConvF sensitivity in TSL / NORM x,y,z  
N/A not applicable or not measured

**Calibration is Performed According to the Following Standards:**

- a) IEEE Std 1528-2013, "IEEE Recommended Practice for Determining the Peak Spatial-Averaged Specific Absorption Rate (SAR) in the Human Head from Wireless Communications Devices: Measurement Techniques", June 2013
- b) IEC 62209-1, "Procedure to measure the Specific Absorption Rate (SAR) for hand-held devices used in close proximity to the ear (frequency range of 300 MHz to 3 GHz)", February 2005
- c) IEC 62209-2, "Procedure to determine the Specific Absorption Rate (SAR) for wireless communication devices used in close proximity to the human body (frequency range of 30 MHz to 6 GHz)", March 2010
- d) KDB 865664, "SAR Measurement Requirements for 100 MHz to 6 GHz"

**Additional Documentation:**

- e) DASY4/5 System Handbook

**Methods Applied and Interpretation of Parameters:**

- *Measurement Conditions:* Further details are available from the Validation Report at the end of the certificate. All figures stated in the certificate are valid at the frequency indicated.
- *Antenna Parameters with TSL:* The dipole is mounted with the spacer to position its feed point exactly below the center marking of the flat phantom section, with the arms oriented parallel to the body axis.
- *Feed Point Impedance and Return Loss:* These parameters are measured with the dipole positioned under the liquid filled phantom. The impedance stated is transformed from the measurement at the SMA connector to the feed point. The Return Loss ensures low reflected power. No uncertainty required.
- *Electrical Delay:* One-way delay between the SMA connector and the antenna feed point. No uncertainty required.
- *SAR measured:* SAR measured at the stated antenna input power.
- *SAR normalized:* SAR as measured, normalized to an input power of 1 W at the antenna connector.
- *SAR for nominal TSL parameters:* The measured TSL parameters are used to calculate the nominal SAR result.

The reported uncertainty of measurement is stated as the standard uncertainty of measurement multiplied by the coverage factor  $k=2$ , which for a normal distribution corresponds to a coverage probability of approximately 95%.

### Measurement Conditions

DASY system configuration, as far as not given on page 1.

DASY Version	DASY5	V52.8.8
Extrapolation	Advanced Extrapolation	
Phantom	Modular Flat Phantom	
Distance Dipole Center - TSL	10 mm	with Spacer
Zoom Scan Resolution	dx, dy, dz = 5 mm	
Frequency	2450 MHz ± 1 MHz	

### Head TSL parameters

The following parameters and calculations were applied.

	Temperature	Permittivity	Conductivity
Nominal Head TSL parameters	22.0 °C	39.2	1.80 mho/m
Measured Head TSL parameters	(22.0 ± 0.2) °C	37.9 ± 6 %	1.88 mho/m ± 6 %
Head TSL temperature change during test	< 0.5 °C	----	----

### SAR result with Head TSL

SAR averaged over 1 cm <sup>3</sup> (1 g) of Head TSL	Condition	
SAR measured	250 mW input power	13.4 W/kg
SAR for nominal Head TSL parameters	normalized to 1W	<b>52.1 W/kg ± 17.0 % (k=2)</b>

SAR averaged over 10 cm <sup>3</sup> (10 g) of Head TSL	condition	
SAR measured	250 mW input power	6.23 W/kg
SAR for nominal Head TSL parameters	normalized to 1W	<b>24.5 W/kg ± 16.5 % (k=2)</b>

### Body TSL parameters

The following parameters and calculations were applied.

	Temperature	Permittivity	Conductivity
Nominal Body TSL parameters	22.0 °C	52.7	1.95 mho/m
Measured Body TSL parameters	(22.0 ± 0.2) °C	51.6 ± 6 %	2.04 mho/m ± 6 %
Body TSL temperature change during test	< 0.5 °C	----	----

### SAR result with Body TSL

SAR averaged over 1 cm <sup>3</sup> (1 g) of Body TSL	Condition	
SAR measured	250 mW input power	13.0 W/kg
SAR for nominal Body TSL parameters	normalized to 1W	<b>50.7 W/kg ± 17.0 % (k=2)</b>

SAR averaged over 10 cm <sup>3</sup> (10 g) of Body TSL	condition	
SAR measured	250 mW input power	6.11 W/kg
SAR for nominal Body TSL parameters	normalized to 1W	<b>24.1 W/kg ± 16.5 % (k=2)</b>

**Appendix (Additional assessments outside the scope of SCS 0108)**

**Antenna Parameters with Head TSL**

Impedance, transformed to feed point	53.0 $\Omega$ + 2.3 j $\Omega$
Return Loss	- 28.8 dB

**Antenna Parameters with Body TSL**

Impedance, transformed to feed point	49.6 $\Omega$ + 3.7 j $\Omega$
Return Loss	- 28.5 dB

**General Antenna Parameters and Design**

Electrical Delay (one direction)	1.158 ns
----------------------------------	----------

After long term use with 100W radiated power, only a slight warming of the dipole near the feedpoint can be measured.

The dipole is made of standard semirigid coaxial cable. The center conductor of the feeding line is directly connected to the second arm of the dipole. The antenna is therefore short-circuited for DC-signals. On some of the dipoles, small end caps are added to the dipole arms in order to improve matching when loaded according to the position as explained in the "Measurement Conditions" paragraph. The SAR data are not affected by this change. The overall dipole length is still according to the Standard.

No excessive force must be applied to the dipole arms, because they might bend or the soldered connections near the feedpoint may be damaged.

**Additional EUT Data**

Manufactured by	SPEAG
Manufactured on	July 05, 2002



**DASY5 Validation Report for Head TSL**

Date: 13.09.2016

Test Laboratory: SPEAG, Zurich, Switzerland

**DUT: Dipole 2450 MHz; Type: D2450V2; Serial: D2450V2 - SN:713**

Communication System: UID 0 - CW; Frequency: 2450 MHz

Medium parameters used:  $f = 2450$  MHz;  $\sigma = 1.88$  S/m;  $\epsilon_r = 37.9$ ;  $\rho = 1000$  kg/m<sup>3</sup>

Phantom section: Flat Section

Measurement Standard: DASY5 (IEEE/IEC/ANSI C63.19-2011)

DASY52 Configuration:

- Probe: EX3DV4 - SN7349; ConvF(7.72, 7.72, 7.72); Calibrated: 15.06.2016;
- Sensor-Surface: 1.4mm (Mechanical Surface Detection)
- Electronics: DAE4 Sn601; Calibrated: 30.12.2015
- Phantom: Flat Phantom 5.0 (front); Type: QD000P50AA; Serial: 1001
- DASY52 52.8.8(1258); SEMCAD X 14.6.10(7372)

**Dipole Calibration for Head Tissue/Pin=250 mW, d=10mm/Zoom Scan (7x7x7)/Cube 0:**

Measurement grid: dx=5mm, dy=5mm, dz=5mm

Reference Value = 113.5 V/m; Power Drift = -0.01 dB

Peak SAR (extrapolated) = 26.7 W/kg

**SAR(1 g) = 13.4 W/kg; SAR(10 g) = 6.23 W/kg**

Maximum value of SAR (measured) = 21.9 W/kg

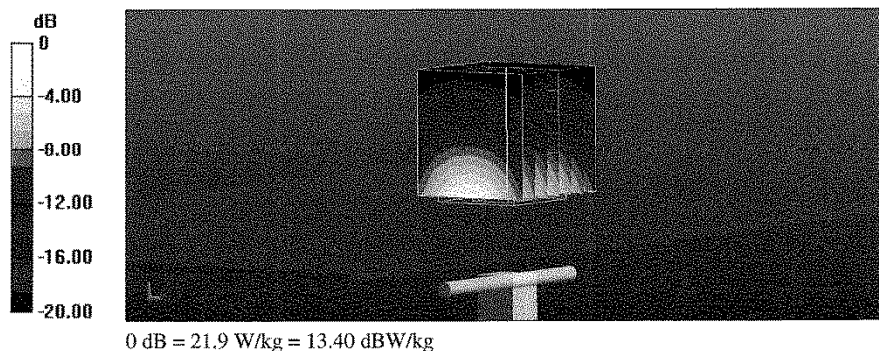

Impedance Measurement Plot for Head TSL

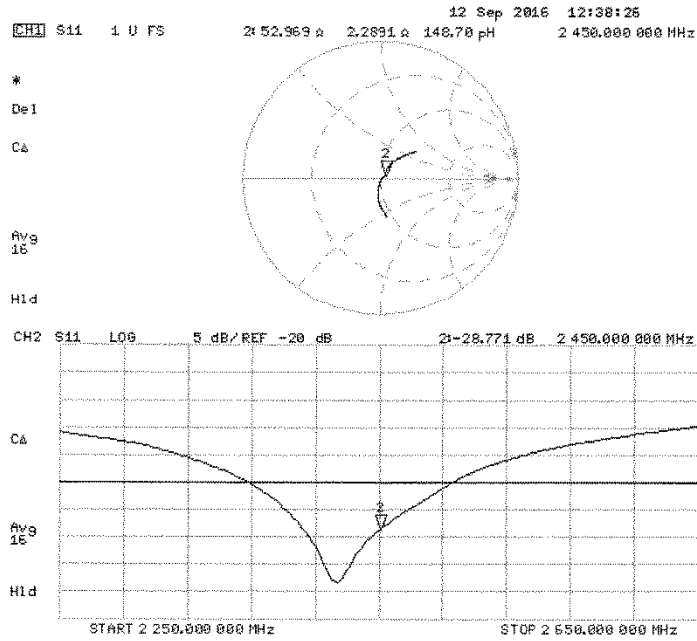

**DASY5 Validation Report for Body TSL**

Date: 13.09.2016

Test Laboratory: SPEAG, Zurich, Switzerland

**DUT: Dipole 2450 MHz; Type: D2450V2; Serial: D2450V2 - SN:713**

Communication System: UID 0 - CW; Frequency: 2450 MHz  
Medium parameters used:  $f = 2450$  MHz;  $\sigma = 2.04$  S/m;  $\epsilon_r = 51.6$ ;  $\rho = 1000$  kg/m<sup>3</sup>  
Phantom section: Flat Section  
Measurement Standard: DASY5 (IEEE/IEC/ANSI C63.19-2011)

DASY52 Configuration:

- Probe: EX3DV4 - SN7349; ConvF(7.79, 7.79, 7.79); Calibrated: 15.06.2016;
- Sensor-Surface: 1.4mm (Mechanical Surface Detection)
- Electronics: DAE4 Sn601; Calibrated: 30.12.2015
- Phantom: Flat Phantom 5.0 (back); Type: QD000P50AA; Serial: 1002
- DASY52 52.8.8(1258); SEMCAD X 14.6.10(7372)

**Dipole Calibration for Body Tissue/Pin=250 mW, d=10mm/Zoom Scan (7x7x7)/Cube 0:**

Measurement grid: dx=5mm, dy=5mm, dz=5mm  
Reference Value = 106.4 V/m; Power Drift = -0.03 dB  
Peak SAR (extrapolated) = 25.5 W/kg  
**SAR(1 g) = 13 W/kg; SAR(10 g) = 6.11 W/kg**  
Maximum value of SAR (measured) = 21.2 W/kg

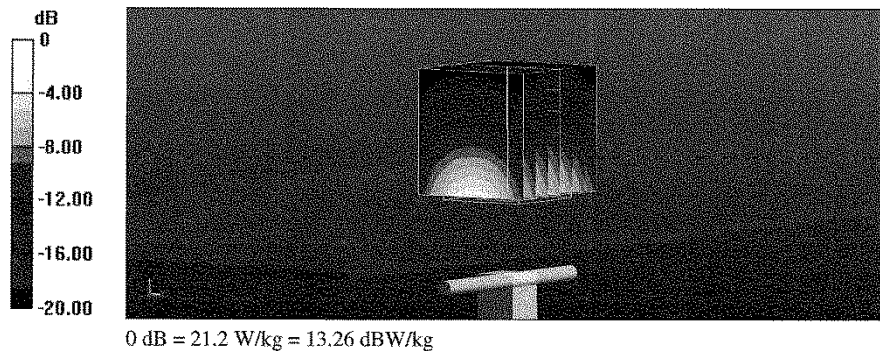

Impedance Measurement Plot for Body TSL

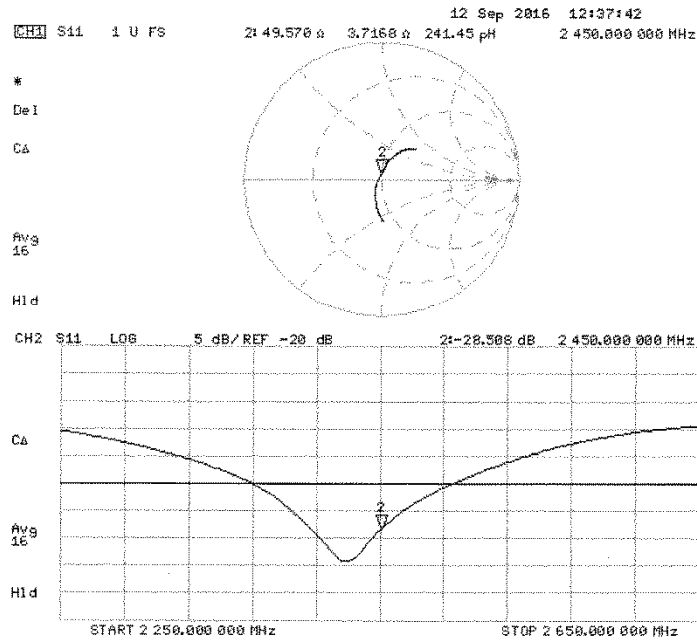

## D2450V2 Calibration for Impedance and Return-loss

Equipment	Dipole Antenna	Model	D2450V2
Manufacture	Schmid&Partner Engineering AG	Serial	713
Tested by	Tomohisa Nakagawa		

### 1. Test environment

Date	August 12, 2017		
Ambient Temperature	23.0 deg.C	Relative humidity	64%RH

### 2. Equipment used

Control No.	Instrument	Manufacturer	Model No	Serial No	Test Item	Calibration Date * Interval(month)
MOS-37	Digital thermometer	LKM electronic	DTM3000	-	SAR	2017/07/26 * 12
MPP-03	2mm Oval Flat Phantom	Schmid&Partner Engineering AG	QDOVA001BB	1203	SAR	2017/05/29 * 12
MMSL2450	Tissue simulation liquid (Body)	Schmid&Partner Engineering AG	MSL2450V2	SL AA 245 BA	SAR*Daily Check Target Value $\pm 5\%$	Pre Check
MHSL2450	Tissue simulation liquid (Head)	Schmid&Partner Engineering AG	HSL2450V2	SL AAH 245 BA	SAR*Daily Check Target Value $\pm 5\%$	Pre Check
EST-63	Network Analyzer	KEYSIGHT	E5071C	MY46523746	SAR	2017/02/03 * 12
EST-64	Calibration Kit	KEYSIGHT	85032F	MY53200995	SAR	2017/02/02 * 12
MDA-07	Dipole Antenna	Schmid&Partner Engineering AG	D2450V2	713	SAR	2016/09/13 * 12

### 3. Test Result

Impedance, Transformed to feed point	cal day	Head (real part) [ $\Omega$ ]	Head (img part) [ $j\Omega$ ]	Deviation (real part) [ $\Omega$ ]	Deviation (img part) [ $j\Omega$ ]	Tolerance	Result
Calibration (SPEAG)	2016/9/13	53.00	2.30	-	-	-	-
Calibration (ULJ)	2017/9/12	52.38	3.79	-0.62	1.49	$\pm 5\Omega$	Complied

Return loss	cal day	Head [dB]	Deviation [dB]	Tolerance [dB]	Result
Calibration (SPEAG)	2016/9/13	-28.80	-	-	-
Calibration (ULJ)	2017/9/12	-25.08	3.72	5.76	Complied

Impedance, Transformed to feed point	cal day	Body (real part) [ $\Omega$ ]	Body (img part) [ $j\Omega$ ]	Deviation (real part) [ $\Omega$ ]	Deviation (img part) [ $j\Omega$ ]	Tolerance	Result
Calibration (SPEAG)	2016/9/13	49.60	3.70	-	-	-	-
Calibration (ULJ)	2017/9/12	46.483	7.6901	-3.12	3.99	$\pm 5\Omega$	Complied

Return loss	cal day	Body [dB]	Deviation [dB]	Tolerance [dB]	Result
Calibration (SPEAG)	2016/9/13	-28.50	-	-	-
Calibration (ULJ)	2017/9/12	-23.306	5.19	5.7	Complied

\*Tolerance : According to the KDB865664D01

Measurement Plots

<Head Liquid>

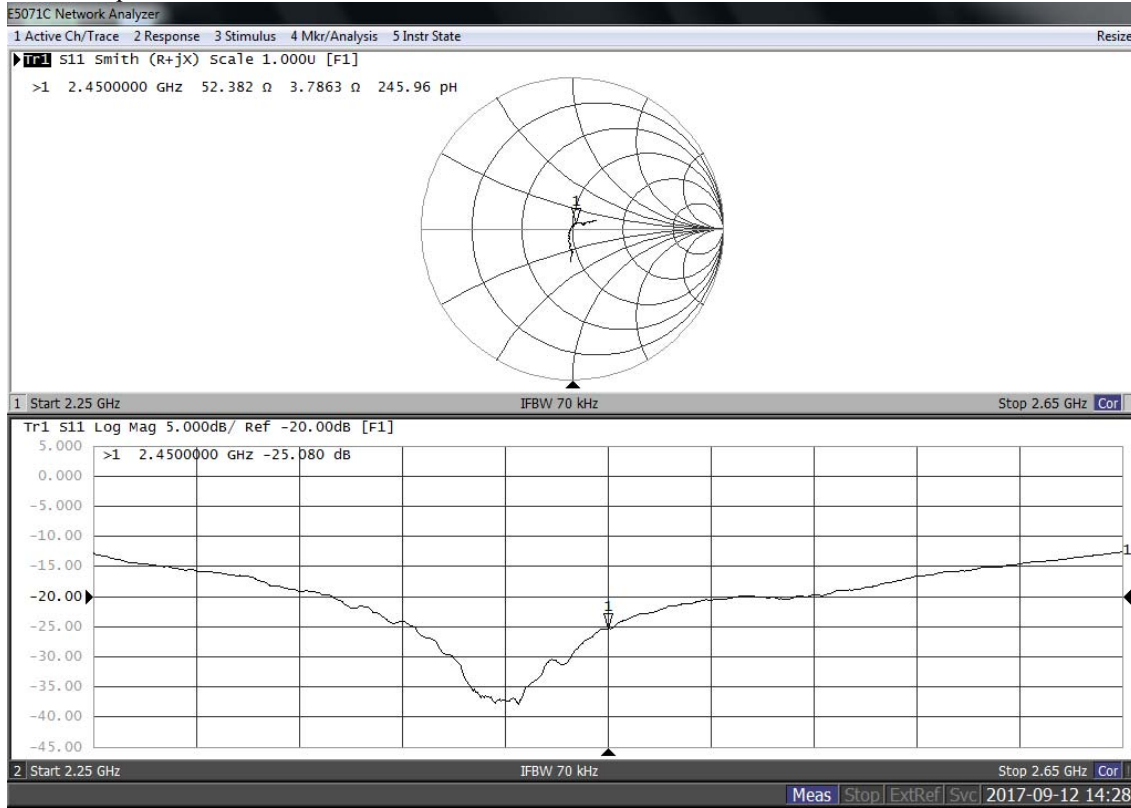

<Body Liquid>

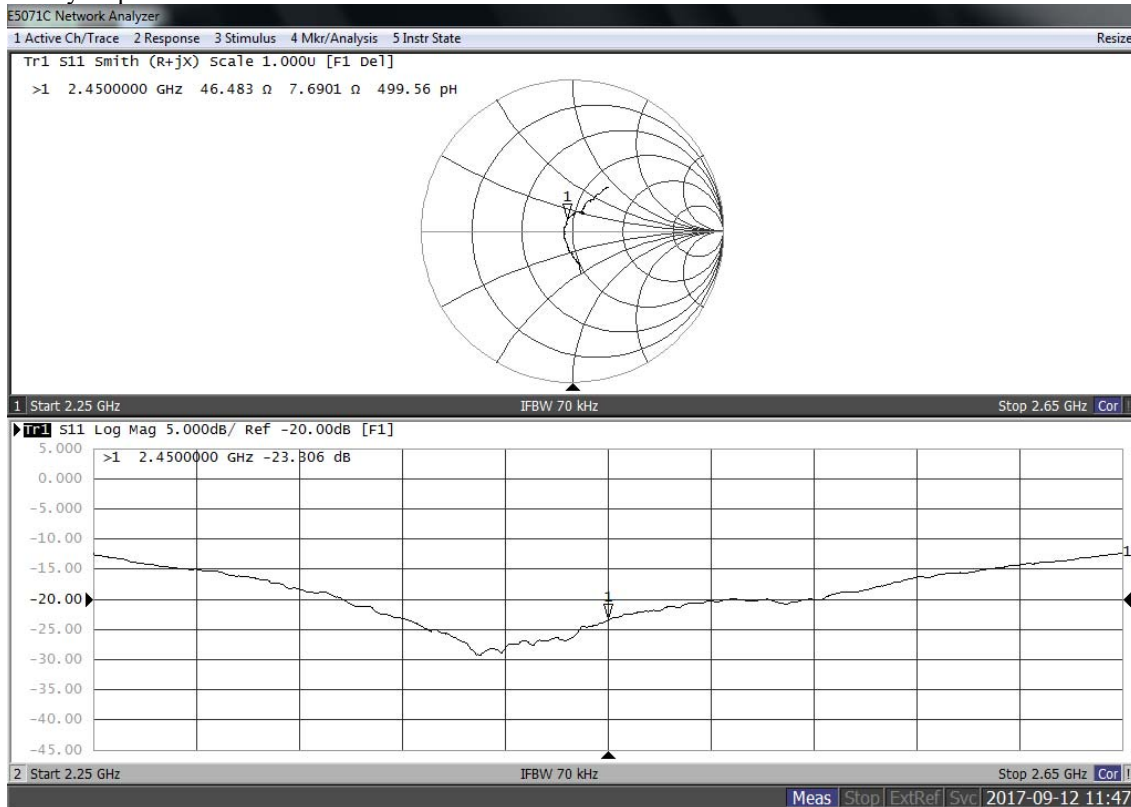

**System Check Dipole SAR Calibration Certificate -DipoleD5GHz (D5GHzV2 S/N: 1020)**

**Calibration Laboratory of  
Schmid & Partner  
Engineering AG**  
Zeughausstrasse 43, 8004 Zurich, Switzerland



**S** Schweizerischer Kalibrierdienst  
**S** Service suisse d'étalonnage  
**C** Servizio svizzero di taratura  
**S** Swiss Calibration Service

Accredited by the Swiss Accreditation Service (SAS)  
The Swiss Accreditation Service is one of the signatories to the EA  
Multilateral Agreement for the recognition of calibration certificates

Accreditation No.: **SCS 0108**

Client **UL Japan (Vitec)**

Certificate No: **D5GHzV2-1020\_Jan18**

CALIBRATION CERTIFICATE			
Object	D5GHzV2 - SN:1020		
Calibration procedure(s)	QA CAL-22.v2 Calibration procedure for dipole validation kits between 3-6 GHz		
Calibration date:	January 11, 2018		
This calibration certificate documents the traceability to national standards, which realize the physical units of measurements (SI). The measurements and the uncertainties with confidence probability are given on the following pages and are part of the certificate.			
All calibrations have been conducted in the closed laboratory facility: environment temperature (22 ± 3)°C and humidity < 70%.			
Calibration Equipment used (M&TE critical for calibration)			
<b>Primary Standards</b>	<b>ID #</b>	<b>Cal Date (Certificate No.)</b>	<b>Scheduled Calibration</b>
Power meter NRP	SN: 104778	04-Apr-17 (No. 217-02521/02522)	Apr-18
Power sensor NRP-Z91	SN: 103244	04-Apr-17 (No. 217-02521)	Apr-18
Power sensor NRP-Z91	SN: 103245	04-Apr-17 (No. 217-02522)	Apr-18
Reference 20 dB Attenuator	SN: 5058 (20k)	07-Apr-17 (No. 217-02528)	Apr-18
Type-N mismatch combination	SN: 5047.2 / 06327	07-Apr-17 (No. 217-02529)	Apr-18
Reference Probe EX3DV4	SN: 3503	30-Dec-17 (No. EX3-3503_Dec17)	Dec-18
DAE4	SN: 601	26-Oct-17 (No. DAE4-601_Oct17)	Oct-18
<b>Secondary Standards</b>	<b>ID #</b>	<b>Check Date (in house)</b>	<b>Scheduled Check</b>
Power meter EPM-442A	SN: GB37480704	07-Oct-15 (in house check Oct-16)	In house check: Oct-18
Power sensor HP 8481A	SN: US37292783	07-Oct-15 (in house check Oct-16)	In house check: Oct-18
Power sensor HP 8481A	SN: MY41092317	07-Oct-15 (in house check Oct-16)	In house check: Oct-18
RF generator R&S SMT-06	SN: 100972	15-Jun-15 (in house check Oct-16)	In house check: Oct-18
Network Analyzer HP 8753E	SN: US37390585	18-Oct-01 (in house check Oct-17)	In house check: Oct-18
Calibrated by:	Name Michael Weber	Function Laboratory Technician	Signature 
Approved by:	Name Katja Pokovic	Function Technical Manager	Signature 
This calibration certificate shall not be reproduced except in full without written approval of the laboratory.			Issued: January 12, 2018

Calibration Laboratory of  
Schmid & Partner  
Engineering AG  
Zeughausstrasse 43, 8004 Zurich, Switzerland



S Schweizerischer Kalibrierdienst  
C Service suisse d'étalonnage  
S Servizio svizzero di taratura  
S Swiss Calibration Service

Accredited by the Swiss Accreditation Service (SAS)  
The Swiss Accreditation Service is one of the signatories to the EA  
Multilateral Agreement for the recognition of calibration certificates

Accreditation No.: SCS 0108

**Glossary:**

TSL tissue simulating liquid  
ConvF sensitivity in TSL / NORM x,y,z  
N/A not applicable or not measured

**Calibration is Performed According to the Following Standards:**

- IEEE Std 1528-2013, "IEEE Recommended Practice for Determining the Peak Spatial-Averaged Specific Absorption Rate (SAR) in the Human Head from Wireless Communications Devices: Measurement Techniques", June 2013
- IEC 62209-1, "Measurement procedure for the assessment of Specific Absorption Rate (SAR) from hand-held and body-mounted devices used next to the ear (frequency range of 300 MHz to 6 GHz)", July 2016
- IEC 62209-2, "Procedure to determine the Specific Absorption Rate (SAR) for wireless communication devices used in close proximity to the human body (frequency range of 30 MHz to 6 GHz)", March 2010
- KDB 865664, "SAR Measurement Requirements for 100 MHz to 6 GHz"

**Additional Documentation:**

- DASY4/5 System Handbook

**Methods Applied and Interpretation of Parameters:**

- Measurement Conditions:* Further details are available from the Validation Report at the end of the certificate. All figures stated in the certificate are valid at the frequency indicated.
- Antenna Parameters with TSL:* The dipole is mounted with the spacer to position its feed point exactly below the center marking of the flat phantom section, with the arms oriented parallel to the body axis.
- Feed Point Impedance and Return Loss:* These parameters are measured with the dipole positioned under the liquid filled phantom. The impedance stated is transformed from the measurement at the SMA connector to the feed point. The Return Loss ensures low reflected power. No uncertainty required.
- Electrical Delay:* One-way delay between the SMA connector and the antenna feed point. No uncertainty required.
- SAR measured:* SAR measured at the stated antenna input power.
- SAR normalized:* SAR as measured, normalized to an input power of 1 W at the antenna connector.
- SAR for nominal TSL parameters:* The measured TSL parameters are used to calculate the nominal SAR result.

The reported uncertainty of measurement is stated as the standard uncertainty of measurement multiplied by the coverage factor  $k=2$ , which for a normal distribution corresponds to a coverage probability of approximately 95%.



**Measurement Conditions**

DASY system configuration, as far as not given on page 1.

DASY Version	DASY5	V52.10.0
Extrapolation	Advanced Extrapolation	
Phantom	Modular Flat Phantom V5.0	
Distance Dipole Center - TSL	10 mm	with Spacer
Zoom Scan Resolution	dx, dy = 4.0 mm, dz = 1.4 mm	Graded Ratio = 1.4 (Z direction)
Frequency	5250 MHz ± 1 MHz 5600 MHz ± 1 MHz 5750 MHz ± 1 MHz	

**Head TSL parameters at 5250 MHz**

The following parameters and calculations were applied.

	Temperature	Permittivity	Conductivity
Nominal Head TSL parameters	22.0 °C	35.9	4.71 mho/m
Measured Head TSL parameters	(22.0 ± 0.2) °C	36.2 ± 6 %	4.55 mho/m ± 6 %
Head TSL temperature change during test	< 0.5 °C	----	----

**SAR result with Head TSL at 5250 MHz**

SAR averaged over 1 cm <sup>3</sup> (1 g) of Head TSL	Condition	
SAR measured	100 mW input power	7.78 W/kg
SAR for nominal Head TSL parameters	normalized to 1W	<b>77.8 W/kg ± 19.9 % (k=2)</b>

SAR averaged over 10 cm <sup>3</sup> (10 g) of Head TSL	condition	
SAR measured	100 mW input power	2.25 W/kg
SAR for nominal Head TSL parameters	normalized to 1W	<b>22.5 W/kg ± 19.5 % (k=2)</b>

**Head TSL parameters at 5600 MHz**

The following parameters and calculations were applied.

	Temperature	Permittivity	Conductivity
Nominal Head TSL parameters	22.0 °C	35.5	5.07 mho/m
Measured Head TSL parameters	(22.0 ± 0.2) °C	35.8 ± 6 %	4.90 mho/m ± 6 %
Head TSL temperature change during test	< 0.5 °C	----	----

**SAR result with Head TSL at 5600 MHz**

SAR averaged over 1 cm <sup>3</sup> (1 g) of Head TSL	Condition	
SAR measured	100 mW input power	8.29 W/kg
SAR for nominal Head TSL parameters	normalized to 1W	<b>82.9 W / kg ± 19.9 % (k=2)</b>

SAR averaged over 10 cm <sup>3</sup> (10 g) of Head TSL	condition	
SAR measured	100 mW input power	2.37 W/kg
SAR for nominal Head TSL parameters	normalized to 1W	<b>23.7 W/kg ± 19.5 % (k=2)</b>

**Head TSL parameters at 5750 MHz**

The following parameters and calculations were applied.

	Temperature	Permittivity	Conductivity
Nominal Head TSL parameters	22.0 °C	35.4	5.22 mho/m
Measured Head TSL parameters	(22.0 ± 0.2) °C	35.5 ± 6 %	5.06 mho/m ± 6 %
Head TSL temperature change during test	< 0.5 °C	----	----

**SAR result with Head TSL at 5750 MHz**

SAR averaged over 1 cm <sup>3</sup> (1 g) of Head TSL	Condition	
SAR measured	100 mW input power	7.95 W/kg
SAR for nominal Head TSL parameters	normalized to 1W	<b>79.4 W/kg ± 19.9 % (k=2)</b>

SAR averaged over 10 cm <sup>3</sup> (10 g) of Head TSL	condition	
SAR measured	100 mW input power	2.27 W/kg
SAR for nominal Head TSL parameters	normalized to 1W	<b>22.7 W/kg ± 19.5 % (k=2)</b>

**Body TSL parameters at 5250 MHz**

The following parameters and calculations were applied.

	Temperature	Permittivity	Conductivity
Nominal Body TSL parameters	22.0 °C	48.9	5.36 mho/m
Measured Body TSL parameters	(22.0 ± 0.2) °C	47.2 ± 6 %	5.48 mho/m ± 6 %
Body TSL temperature change during test	< 0.5 °C	----	----

**SAR result with Body TSL at 5250 MHz**

SAR averaged over 1 cm <sup>3</sup> (1 g) of Body TSL	Condition	
SAR measured	100 mW input power	7.65 W/kg
SAR for nominal Body TSL parameters	normalized to 1W	<b>76.0 W/kg ± 19.9 % (k=2)</b>

SAR averaged over 10 cm <sup>3</sup> (10 g) of Body TSL	condition	
SAR measured	100 mW input power	2.14 W/kg
SAR for nominal Body TSL parameters	normalized to 1W	<b>21.2 W/kg ± 19.5 % (k=2)</b>

**Body TSL parameters at 5600 MHz**

The following parameters and calculations were applied.

	Temperature	Permittivity	Conductivity
Nominal Body TSL parameters	22.0 °C	48.5	5.77 mho/m
Measured Body TSL parameters	(22.0 ± 0.2) °C	46.6 ± 6 %	5.94 mho/m ± 6 %
Body TSL temperature change during test	< 0.5 °C	----	----

**SAR result with Body TSL at 5600 MHz**

SAR averaged over 1 cm <sup>3</sup> (1 g) of Body TSL	Condition	
SAR measured	100 mW input power	8.03 W/kg
SAR for nominal Body TSL parameters	normalized to 1W	<b>79.7 W/kg ± 19.9 % (k=2)</b>

SAR averaged over 10 cm <sup>3</sup> (10 g) of Body TSL	condition	
SAR measured	100 mW input power	2.24 W/kg
SAR for nominal Body TSL parameters	normalized to 1W	<b>22.2 W/kg ± 19.5 % (k=2)</b>

**Body TSL parameters at 5750 MHz**

The following parameters and calculations were applied.

	Temperature	Permittivity	Conductivity
Nominal Body TSL parameters	22.0 °C	48.3	5.94 mho/m
Measured Body TSL parameters	(22.0 ± 0.2) °C	46.3 ± 6 %	6.15 mho/m ± 6 %
Body TSL temperature change during test	< 0.5 °C	----	----

**SAR result with Body TSL at 5750 MHz**

SAR averaged over 1 cm <sup>3</sup> (1 g) of Body TSL	Condition	
SAR measured	100 mW input power	7.68 W/kg
SAR for nominal Body TSL parameters	normalized to 1W	<b>76.3 W/kg ± 19.9 % (k=2)</b>

SAR averaged over 10 cm <sup>3</sup> (10 g) of Body TSL	condition	
SAR measured	100 mW input power	2.13 W/kg
SAR for nominal Body TSL parameters	normalized to 1W	<b>21.1 W/kg ± 19.5 % (k=2)</b>

**Appendix (Additional assessments outside the scope of SCS 0108)**

**Antenna Parameters with Head TSL at 5250 MHz**

Impedance, transformed to feed point	51.4 $\Omega$ - 7.0 j $\Omega$
Return Loss	- 23.1 dB

**Antenna Parameters with Head TSL at 5600 MHz**

Impedance, transformed to feed point	53.6 $\Omega$ - 2.8 j $\Omega$
Return Loss	- 27.1 dB

**Antenna Parameters with Head TSL at 5750 MHz**

Impedance, transformed to feed point	58.5 $\Omega$ + 0.3 j $\Omega$
Return Loss	- 22.1 dB

**Antenna Parameters with Body TSL at 5250 MHz**

Impedance, transformed to feed point	50.4 $\Omega$ - 5.6 j $\Omega$
Return Loss	- 25.1 dB

**Antenna Parameters with Body TSL at 5600 MHz**

Impedance, transformed to feed point	55.2 $\Omega$ - 1.9 j $\Omega$
Return Loss	- 25.7 dB

**Antenna Parameters with Body TSL at 5750 MHz**

Impedance, transformed to feed point	57.3 $\Omega$ + 1.2 j $\Omega$
Return Loss	- 23.2 dB

**General Antenna Parameters and Design**

Electrical Delay (one direction)	1.199 ns
----------------------------------	----------

After long term use with 100W radiated power, only a slight warming of the dipole near the feedpoint can be measured.

The dipole is made of standard semirigid coaxial cable. The center conductor of the feeding line is directly connected to the second arm of the dipole. The antenna is therefore short-circuited for DC-signals. On some of the dipoles, small end caps are added to the dipole arms in order to improve matching when loaded according to the position as explained in the "Measurement Conditions" paragraph. The SAR data are not affected by this change. The overall dipole length is still according to the Standard.

No excessive force must be applied to the dipole arms, because they might bend or the soldered connections near the feedpoint may be damaged.

**Additional EUT Data**

Manufactured by	SPEAG
Manufactured on	February 05, 2004

## DASY5 Validation Report for Head TSL

Date: 11.01.2018

Test Laboratory: SPEAG, Zurich, Switzerland

**DUT: Dipole D5GHzV2; Type: D5GHzV2; Serial: D5GHzV2 - SN:1020**

Communication System: UID 0 - CW; Frequency: 5250 MHz, Frequency: 5600 MHz, Frequency: 5750 MHz  
Medium parameters used:  $f = 5250$  MHz;  $\sigma = 4.55$  S/m;  $\epsilon_r = 36.2$ ;  $\rho = 1000$  kg/m<sup>3</sup>, Medium parameters used:  $f = 5600$  MHz;  $\sigma = 4.9$  S/m;  $\epsilon_r = 35.8$ ;  $\rho = 1000$  kg/m<sup>3</sup>, Medium parameters used:  $f = 5750$  MHz;  $\sigma = 5.06$  S/m;  $\epsilon_r = 35.5$ ;  $\rho = 1000$  kg/m<sup>3</sup>  
Phantom section: Flat Section  
Measurement Standard: DASY5 (IEEE/IEC/ANSI C63.19-2011)

DASY52 Configuration:

- Probe: EX3DV4 - SN3503; ConvF(5.51, 5.51, 5.51); Calibrated: 30.12.2017, ConvF(5.05, 5.05, 5.05); Calibrated: 30.12.2017, ConvF(4.98, 4.98, 4.98); Calibrated: 30.12.2017;
- Sensor-Surface: 1.4mm (Mechanical Surface Detection)
- Electronics: DAE4 Sn601 - modified; Calibrated: 26.10.2017
- Phantom: Flat Phantom 5.0 (front); Type: QD 000 P50 AA; Serial: 1001
- DASY52 52.10.0(1446); SEMCAD X 14.6.10(7417)

**Dipole Calibration for Head Tissue/Pin=100mW, dist=10mm, f=5250 MHz/Zoom Scan, dist=1.4mm (8x8x7)/Cube 0:** Measurement grid: dx=4mm, dy=4mm, dz=1.4mm  
Reference Value = 75.00 V/m; Power Drift = 0.00 dB  
Peak SAR (extrapolated) = 27.0 W/kg  
**SAR(1 g) = 7.78 W/kg; SAR(10 g) = 2.25 W/kg**  
Maximum value of SAR (measured) = 17.5 W/kg

**Dipole Calibration for Head Tissue/Pin=100mW, dist=10mm, f=5600 MHz/Zoom Scan, dist=1.4mm (8x8x7)/Cube 0:** Measurement grid: dx=4mm, dy=4mm, dz=1.4mm  
Reference Value = 75.66 V/m; Power Drift = -0.02 dB  
Peak SAR (extrapolated) = 32.0 W/kg  
**SAR(1 g) = 8.29 W/kg; SAR(10 g) = 2.37 W/kg**  
Maximum value of SAR (measured) = 19.5 W/kg

**Dipole Calibration for Head Tissue/Pin=100mW, dist=10mm, f=5750 MHz/Zoom Scan, dist=1.4mm (8x8x7)/Cube 0:** Measurement grid: dx=4mm, dy=4mm, dz=1.4mm  
Reference Value = 73.07 V/m; Power Drift = -0.03 dB  
Peak SAR (extrapolated) = 31.3 W/kg  
**SAR(1 g) = 7.95 W/kg; SAR(10 g) = 2.27 W/kg**  
Maximum value of SAR (measured) = 19.0 W/kg

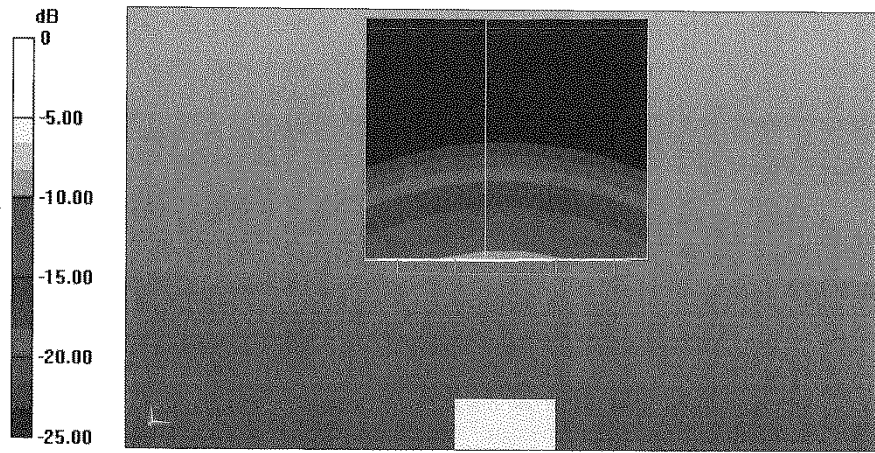

0 dB = 19.0 W/kg = 12.79 dBW/kg

Impedance Measurement Plot for Head TSL

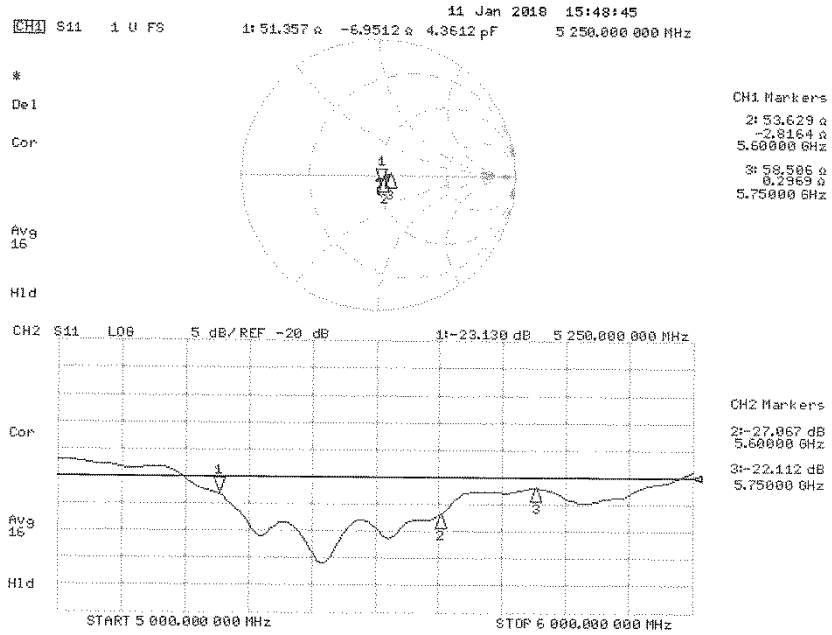



## DASY5 Validation Report for Body TSL

Date: 10.01.2018

Test Laboratory: SPEAG, Zurich, Switzerland

**DUT: Dipole D5GHzV2; Type: D5GHzV2; Serial: D5GHzV2 - SN:1020**

Communication System: UID 0 - CW; Frequency: 5250 MHz, Frequency: 5600 MHz, Frequency: 5750 MHz  
Medium parameters used:  $f = 5250$  MHz;  $\sigma = 5.48$  S/m;  $\epsilon_r = 47.2$ ;  $\rho = 1000$  kg/m<sup>3</sup>,  
Medium parameters used:  $f = 5600$  MHz;  $\sigma = 5.94$  S/m;  $\epsilon_r = 46.6$ ;  $\rho = 1000$  kg/m<sup>3</sup>,  
Medium parameters used:  $f = 5750$  MHz;  $\sigma = 6.15$  S/m;  $\epsilon_r = 46.3$ ;  $\rho = 1000$  kg/m<sup>3</sup>  
Phantom section: Flat Section  
Measurement Standard: DASY5 (IEEE/IEC/ANSI C63.19-2011)

DASY52 Configuration:

- Probe: EX3DV4 - SN3503; ConvF(5.26, 5.26, 5.26); Calibrated: 30.12.2017, ConvF(4.65, 4.65, 4.65); Calibrated: 30.12.2017, ConvF(4.57, 4.57, 4.57); Calibrated: 30.12.2017;
- Sensor-Surface: 1.4mm (Mechanical Surface Detection)
- Electronics: DAE4 Sn601; Calibrated: 26.10.2017
- Phantom: Flat Phantom 5.0 (back); Type: QD 000 P50 AA; Serial: 1002
- DASY52 52.10.0(1446); SEMCAD X 14.6.10(7417)

**Dipole Calibration for Body Tissue/Pin=100mW, dist=10mm, f=5250 MHz/Zoom Scan, dist=1.4mm (8x8x7)/Cube 0:** Measurement grid: dx=4mm, dy=4mm, dz=1.4mm  
Reference Value = 65.64 V/m; Power Drift = -0.07 dB  
Peak SAR (extrapolated) = 29.5 W/kg  
**SAR(1 g) = 7.65 W/kg; SAR(10 g) = 2.14 W/kg**  
Maximum value of SAR (measured) = 18.0 W/kg

**Dipole Calibration for Body Tissue/Pin=100mW, dist=10mm, f=5600 MHz/Zoom Scan, dist=1.4mm (8x8x7)/Cube 0:** Measurement grid: dx=4mm, dy=4mm, dz=1.4mm  
Reference Value = 65.95 V/m; Power Drift = -0.09 dB  
Peak SAR (extrapolated) = 33.9 W/kg  
**SAR(1 g) = 8.03 W/kg; SAR(10 g) = 2.24 W/kg**  
Maximum value of SAR (measured) = 19.7 W/kg

**Dipole Calibration for Body Tissue/Pin=100mW, dist=10mm, f=5750 MHz/Zoom Scan, dist=1.4mm (8x8x7)/Cube 0:** Measurement grid: dx=4mm, dy=4mm, dz=1.4mm  
Reference Value = 64.15 V/m; Power Drift = -0.09 dB  
Peak SAR (extrapolated) = 33.3 W/kg  
**SAR(1 g) = 7.68 W/kg; SAR(10 g) = 2.13 W/kg**  
Maximum value of SAR (measured) = 19.0 W/kg

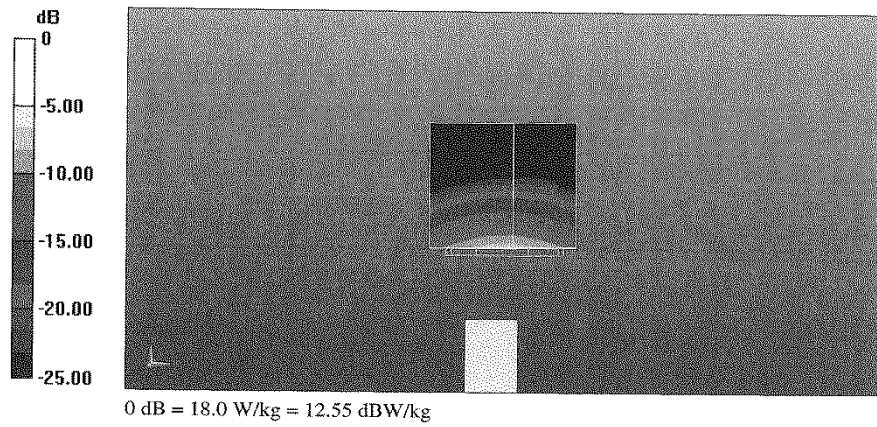

Impedance Measurement Plot for Body TSL

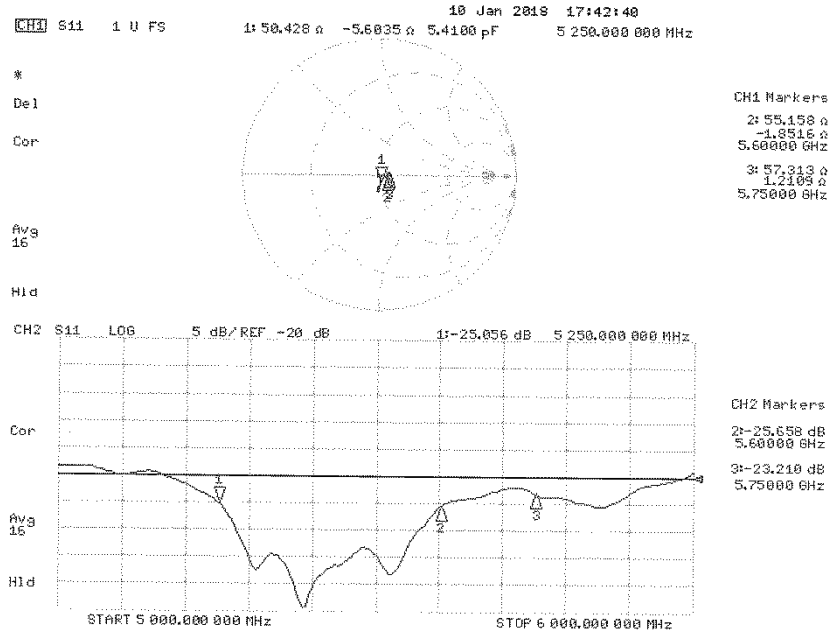

**Dosimetric E-Field Probe Calibration Certificate (EX3DV4, S/N: 3825)**

**Calibration Laboratory of  
Schmid & Partner  
Engineering AG**  
Zeughausstrasse 43, 8004 Zurich, Switzerland



**S** Schweizerischer Kalibrierdienst  
**S** Service suisse d'étalonnage  
**S** Servizio svizzero di taratura  
**S** Swiss Calibration Service

Accredited by the Swiss Accreditation Service (SAS)  
The Swiss Accreditation Service is one of the signatories to the EA  
Multilateral Agreement for the recognition of calibration certificates

Accreditation No.: **SCS 0108**

Client **UL Japan (Vitec)**

Certificate No: **EX3-3825 Dec17**

**CALIBRATION CERTIFICATE**

Object: **EX3DV4 - SN:3825**

Calibration procedure(s): **QA-CAL-01.v9, QA-CAL-14.v4, QA-CAL-23.v5, QA-CAL-25.v6  
Calibration procedure for dosimetric E-field probes**

Calibration date: **December 11, 2017**

This calibration certificate documents the traceability to national standards, which realize the physical units of measurements (SI).  
The measurements and the uncertainties with confidence probability are given on the following pages and are part of the certificate.

All calibrations have been conducted in the closed laboratory facility: environment temperature (22 ± 3)°C and humidity < 70%.

Calibration Equipment used (M&TE critical for calibration)

Primary Standards	ID	Cal Date (Certificate No.)	Scheduled Calibration
Power meter NRP	SN: 104778	04-Apr-17 (No. 217-02521/02522)	Apr-18
Power sensor NRP-Z91	SN: 103244	04-Apr-17 (No. 217-02521)	Apr-18
Power sensor NRP-Z91	SN: 103245	04-Apr-17 (No. 217-02525)	Apr-18
Reference 20 dB Attenuator	SN: S5277 (20x)	07-Apr-17 (No. 217-02528)	Apr-18
Reference Probe ES3DV2	SN: 3013	31-Dec-16 (No. ES3-3013_Dec16)	Dec-17
DAE4	SN: 654	24-Jul-17 (No. DAE4-654_Jul17)	Jul-18
Secondary Standards	ID	Check Date (in house)	Scheduled Check
Power meter E4419B	SN: GB41293874	06-Apr-16 (in house check Jun-16)	In house check: Jun-18
Power sensor E4412A	SN: MY41498087	06-Apr-16 (in house check Jun-16)	In house check: Jun-18
Power sensor E4412A	SN: 000110210	06-Apr-16 (in house check Jun-16)	In house check: Jun-18
RF generator HP 8648C	SN: US3642U01700	04-Aug-99 (in house check Jun-16)	In house check: Jun-18
Network Analyzer HP 8753E	SN: US37390585	18-Oct-01 (in house check Oct-17)	in house check: Oct-18

	Name	Function	Signature
Calibrated by:	Jeton Kastrati	Laboratory Technician	
Approved by:	Katja Pokovic	Technical Manager	

Issued: December 13, 2017

This calibration certificate shall not be reproduced except in full without written approval of the laboratory.

Calibration Laboratory of  
Schmid & Partner  
Engineering AG  
Zeughausstrasse 43, 8004 Zurich, Switzerland



S Schweizerischer Kalibrierdienst  
C Service suisse d'étalonnage  
S Servizio svizzero di taratura  
S Swiss Calibration Service

Accredited by the Swiss Accreditation Service (SAS)  
The Swiss Accreditation Service is one of the signatories to the EA  
Multilateral Agreement for the recognition of calibration certificates

Accreditation No.: SCS 0108

#### Glossary:

TSL	tissue simulating liquid
NORM <sub>x,y,z</sub>	sensitivity in free space
ConvF	sensitivity in TSL / NORM <sub>x,y,z</sub>
DCP	diode compression point
CF	crest factor (1/duty_cycle) of the RF signal
A, B, C, D	modulation dependent linearization parameters
Polarization $\phi$	$\phi$ rotation around probe axis
Polarization $\vartheta$	$\vartheta$ rotation around an axis that is in the plane normal to probe axis (at measurement center), i.e., $\vartheta = 0$ is normal to probe axis
Connector Angle	information used in DASY system to align probe sensor X to the robot coordinate system

#### Calibration is Performed According to the Following Standards:

- IEEE Std 1528-2013, "IEEE Recommended Practice for Determining the Peak Spatial-Averaged Specific Absorption Rate (SAR) in the Human Head from Wireless Communications Devices: Measurement Techniques", June 2013
- IEC 62209-1, "Measurement procedure for the assessment of Specific Absorption Rate (SAR) from hand-held and body-mounted devices used next to the ear (frequency range of 300 MHz to 6 GHz)", July 2016
- IEC 62209-2, "Procedure to determine the Specific Absorption Rate (SAR) for wireless communication devices used in close proximity to the human body (frequency range of 30 MHz to 6 GHz)", March 2010
- KDB 865664, "SAR Measurement Requirements for 100 MHz to 6 GHz"

#### Methods Applied and Interpretation of Parameters:

- NORM<sub>x,y,z</sub>**: Assessed for E-field polarization  $\vartheta = 0$  ( $f \leq 900$  MHz in TEM-cell;  $f > 1800$  MHz: R22 waveguide). NORM<sub>x,y,z</sub> are only intermediate values, i.e., the uncertainties of NORM<sub>x,y,z</sub> does not affect the E<sup>2</sup>-field uncertainty inside TSL (see below ConvF).
- NORM(f)<sub>x,y,z</sub> = NORM<sub>x,y,z</sub> \* frequency\_response** (see Frequency Response Chart). This linearization is implemented in DASY4 software versions later than 4.2. The uncertainty of the frequency response is included in the stated uncertainty of ConvF.
- DCP<sub>x,y,z</sub>**: DCP are numerical linearization parameters assessed based on the data of power sweep with CW signal (no uncertainty required). DCP does not depend on frequency nor media.
- PAR**: PAR is the Peak to Average Ratio that is not calibrated but determined based on the signal characteristics
- A<sub>x,y,z</sub>; B<sub>x,y,z</sub>; C<sub>x,y,z</sub>; D<sub>x,y,z</sub>; VR<sub>x,y,z</sub>**: A, B, C, D are numerical linearization parameters assessed based on the data of power sweep for specific modulation signal. The parameters do not depend on frequency nor media. VR is the maximum calibration range expressed in RMS voltage across the diode.
- ConvF and Boundary Effect Parameters**: Assessed in flat phantom using E-field (or Temperature Transfer Standard for  $f \leq 800$  MHz) and inside waveguide using analytical field distributions based on power measurements for  $f > 800$  MHz. The same setups are used for assessment of the parameters applied for boundary compensation (alpha, depth) of which typical uncertainty values are given. These parameters are used in DASY4 software to improve probe accuracy close to the boundary. The sensitivity in TSL corresponds to NORM<sub>x,y,z</sub> \* ConvF whereby the uncertainty corresponds to that given for ConvF. A frequency dependent ConvF is used in DASY version 4.4 and higher which allows extending the validity from  $\pm 50$  MHz to  $\pm 100$  MHz.
- Spherical isotropy (3D deviation from isotropy)**: In a field of low gradients realized using a flat phantom exposed by a patch antenna.
- Sensor Offset**: The sensor offset corresponds to the offset of virtual measurement center from the probe tip (on probe axis). No tolerance required.
- Connector Angle**: The angle is assessed using the information gained by determining the NORM<sub>x</sub> (no uncertainty required).

EX3DV4 – SN:3825

December 11, 2017

# Probe EX3DV4

## SN:3825

Manufactured: September 6, 2011  
Calibrated: December 11, 2017

Calibrated for DASY/EASY Systems  
(Note: non-compatible with DASY2 system!)

EX3DV4- SN:3825

December 11, 2017

## DASY/EASY - Parameters of Probe: EX3DV4 - SN:3825

### Basic Calibration Parameters

	Sensor X	Sensor Y	Sensor Z	Unc (k=2)
Norm ( $\mu\text{V}/(\text{V}/\text{m})^2$ ) <sup>A</sup>	0.42	0.38	0.42	$\pm 10.1\%$
DCP (mV) <sup>B</sup>	101.7	102.2	97.4	

### Modulation Calibration Parameters

UID	Communication System Name		A dB	B dB $\sqrt{\mu\text{V}}$	C	D dB	VR mV	Unc <sup>C</sup> (k=2)
0	CW	X	0.0	0.0	1.0	0.00	130.2	$\pm 3.8\%$
		Y	0.0	0.0	1.0		132.4	
		Z	0.0	0.0	1.0		133.4	

Note: For details on UID parameters see Appendix.

### Sensor Model Parameters

	C1 fF	C2 fF	$\alpha$ $\text{V}^{-1}$	T1 $\text{ms}\cdot\text{V}^{-2}$	T2 $\text{ms}\cdot\text{V}^{-1}$	T3 ms	T4 $\text{V}^{-2}$	T5 $\text{V}^{-1}$	T6
X	35.70	266.3	35.57	23.49	0.500	5.000	0.020	0.400	1.010
Y	36.38	264.3	34.10	10.73	0.535	5.029	1.762	0.131	1.006
Z	49.41	379.1	37.45	15.75	1.006	5.088	0.000	0.680	1.010

The reported uncertainty of measurement is stated as the standard uncertainty of measurement multiplied by the coverage factor k=2, which for a normal distribution corresponds to a coverage probability of approximately 95%.

<sup>A</sup> The uncertainties of Norm X,Y,Z do not affect the E<sup>2</sup>-field uncertainty inside TSL (see Pages 5 and 6).

<sup>B</sup> Numerical linearization parameter; uncertainty not required.

<sup>C</sup> Uncertainty is determined using the max. deviation from linear response applying rectangular distribution and is expressed for the square of the field value.

EX3DV4- SN:3825

December 11, 2017

## DASY/EASY - Parameters of Probe: EX3DV4 - SN:3825

### Calibration Parameter Determined in Head Tissue Simulating Media

f (MHz) <sup>C</sup>	Relative Permittivity <sup>F</sup>	Conductivity (S/m) <sup>F</sup>	ConvF X	ConvF Y	ConvF Z	Alpha <sup>G</sup>	Depth <sup>G</sup> (mm)	Unc (k=2)
750	41.9	0.89	10.11	10.11	10.11	0.33	1.05	± 12.0 %
835	41.5	0.90	9.77	9.77	9.77	0.41	0.83	± 12.0 %
900	41.5	0.97	9.54	9.54	9.54	0.46	0.80	± 12.0 %
1450	40.5	1.20	8.63	8.63	8.63	0.34	0.80	± 12.0 %
1750	40.1	1.37	8.55	8.55	8.55	0.33	0.85	± 12.0 %
1900	40.0	1.40	8.30	8.30	8.30	0.29	0.85	± 12.0 %
1950	40.0	1.40	7.98	7.98	7.98	0.28	0.80	± 12.0 %
2450	39.2	1.80	7.47	7.47	7.47	0.34	0.80	± 12.0 %
3500	37.9	2.91	7.14	7.14	7.14	0.28	1.20	± 13.1 %
5200	36.0	4.66	5.33	5.33	5.33	0.35	1.80	± 13.1 %
5250	35.9	4.71	5.20	5.20	5.20	0.35	1.80	± 13.1 %
5300	35.9	4.76	5.02	5.02	5.02	0.38	1.80	± 13.1 %
5500	35.6	4.96	4.84	4.84	4.84	0.40	1.80	± 13.1 %
5600	35.5	5.07	4.73	4.73	4.73	0.40	1.80	± 13.1 %
5750	35.4	5.22	4.90	4.90	4.90	0.40	1.80	± 13.1 %
5800	35.3	5.27	4.85	4.85	4.85	0.40	1.80	± 13.1 %

<sup>C</sup> Frequency validity above 300 MHz of ± 100 MHz only applies for DASY v4.4 and higher (see Page 2), else it is restricted to ± 50 MHz. The uncertainty is the RSS of the ConvF uncertainty at calibration frequency and the uncertainty for the indicated frequency band. Frequency validity below 300 MHz is ± 10, 25, 40, 50 and 70 MHz for ConvF assessments at 30, 64, 128, 150 and 220 MHz respectively. Above 5 GHz frequency validity can be extended to ± 110 MHz.

<sup>F</sup> At frequencies below 3 GHz, the validity of tissue parameters ( $\epsilon$  and  $\sigma$ ) can be relaxed to ± 10% if liquid compensation formula is applied to measured SAR values. At frequencies above 3 GHz, the validity of tissue parameters ( $\epsilon$  and  $\sigma$ ) is restricted to ± 5%. The uncertainty is the RSS of the ConvF uncertainty for indicated target tissue parameters.

<sup>G</sup> Alpha/Depth are determined during calibration. SPEAG warrants that the remaining deviation due to the boundary effect after compensation is always less than ± 1% for frequencies below 3 GHz and below ± 2% for frequencies between 3-6 GHz at any distance larger than half the probe tip diameter from the boundary.



EX3DV4-- SN:3825

December 11, 2017

## DASY/EASY - Parameters of Probe: EX3DV4 - SN:3825

### Calibration Parameter Determined in Body Tissue Simulating Media

f (MHz) <sup>C</sup>	Relative Permittivity <sup>F</sup>	Conductivity (S/m) <sup>F</sup>	ConvF X	ConvF Y	ConvF Z	Alpha <sup>G</sup>	Depth (mm) <sup>G</sup>	Unc (k=2)
750	55.5	0.96	9.91	9.91	9.91	0.57	0.85	± 12.0 %
835	55.2	0.97	9.68	9.68	9.68	0.37	1.00	± 12.0 %
1450	54.0	1.30	8.34	8.34	8.34	0.34	0.80	± 12.0 %
1750	53.4	1.49	8.29	8.29	8.29	0.32	0.89	± 12.0 %
1900	53.3	1.52	8.00	8.00	8.00	0.43	0.80	± 12.0 %
2450	52.7	1.95	7.77	7.77	7.77	0.34	0.90	± 12.0 %
3500	51.3	3.31	6.67	6.67	6.67	0.25	1.20	± 13.1 %
5250	48.9	5.36	4.69	4.69	4.69	0.40	1.90	± 13.1 %
5600	48.5	5.77	3.96	3.96	3.96	0.45	1.90	± 13.1 %
5750	48.3	5.94	4.28	4.28	4.28	0.45	1.90	± 13.1 %

<sup>C</sup> Frequency validity above 300 MHz of ± 100 MHz only applies for DASY v4.4 and higher (see Page 2), else it is restricted to ± 50 MHz. The uncertainty is the RSS of the ConvF uncertainty at calibration frequency and the uncertainty for the indicated frequency band. Frequency validity below 300 MHz is ± 10, 25, 40, 50 and 70 MHz for ConvF assessments at 30, 64, 128, 150 and 220 MHz respectively. Above 5 GHz frequency validity can be extended to ± 110 MHz.

<sup>F</sup> At frequencies below 3 GHz, the validity of tissue parameters ( $\epsilon$  and  $\sigma$ ) can be relaxed to ± 10% if liquid compensation formula is applied to measured SAR values. At frequencies above 3 GHz, the validity of tissue parameters ( $\epsilon$  and  $\sigma$ ) is restricted to ± 5%. The uncertainty is the RSS of the ConvF uncertainty for indicated target tissue parameters.

<sup>G</sup> Alpha/Depth are determined during calibration. SPEAG warrants that the remaining deviation due to the boundary effect after compensation is always less than ± 1% for frequencies below 3 GHz and below ± 2% for frequencies between 3-6 GHz at any distance larger than half the probe tip diameter from the boundary.

EX3DV4- SN:3825

December 11, 2017

### Frequency Response of E-Field (TEM-Cell:ifi110 EXX, Waveguide: R22)

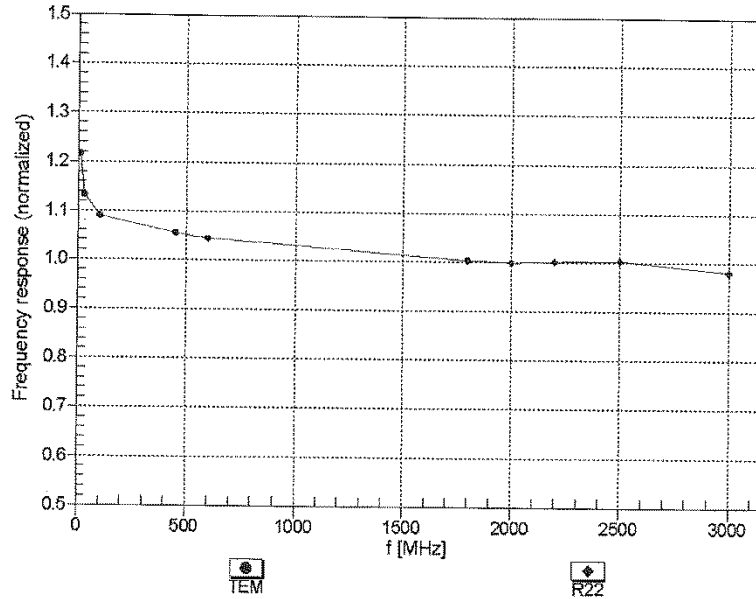

Uncertainty of Frequency Response of E-field:  $\pm 6.3\%$  ( $k=2$ )

EX3DV4- SN:3825

December 11, 2017

### Receiving Pattern ( $\phi$ ), $\theta = 0^\circ$

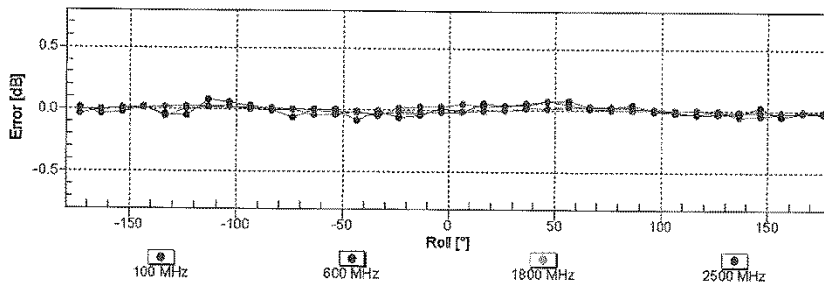
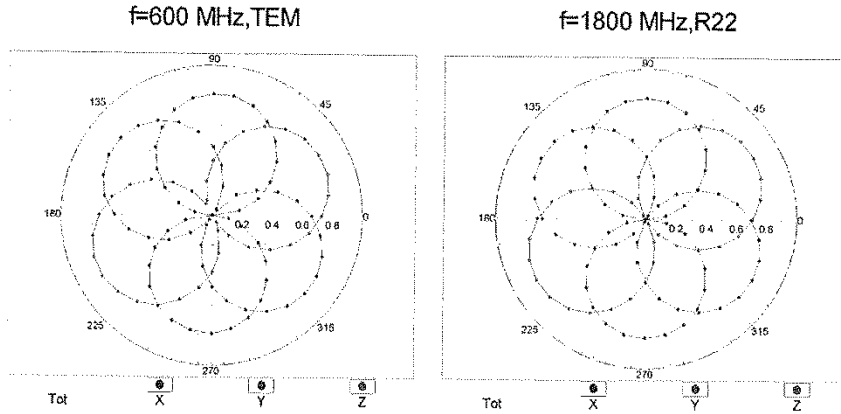

Uncertainty of Axial Isotropy Assessment:  $\pm 0.5\%$  ( $k=2$ )

EX3DV4- SN:3825

December 11, 2017

**Dynamic Range f(SAR<sub>head</sub>)**  
 (TEM cell , f<sub>eval</sub>= 1900 MHz)

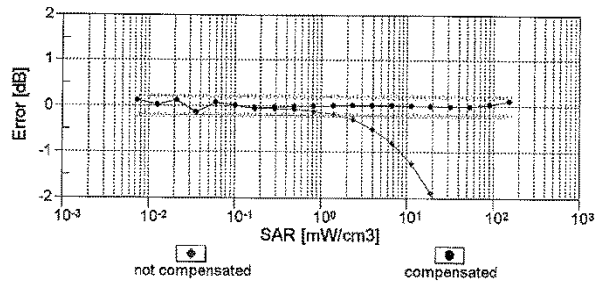
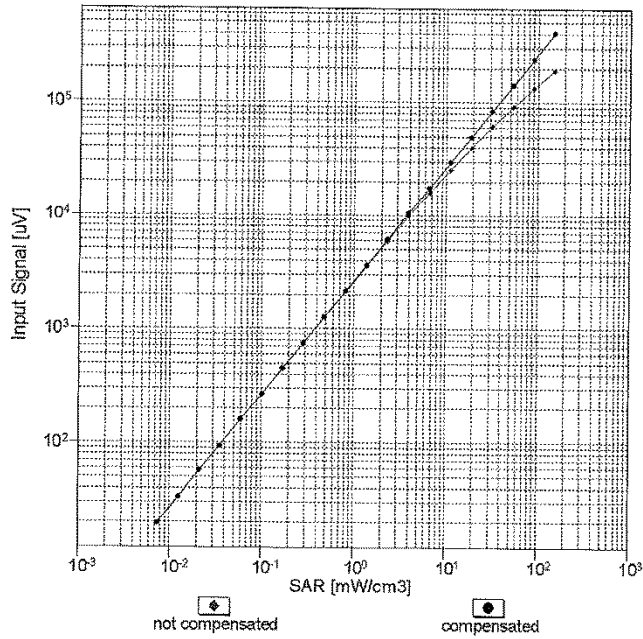

Uncertainty of Linearity Assessment: ± 0.6% (k=2)

EX3DV4-SN:3825

December 11, 2017

### Conversion Factor Assessment

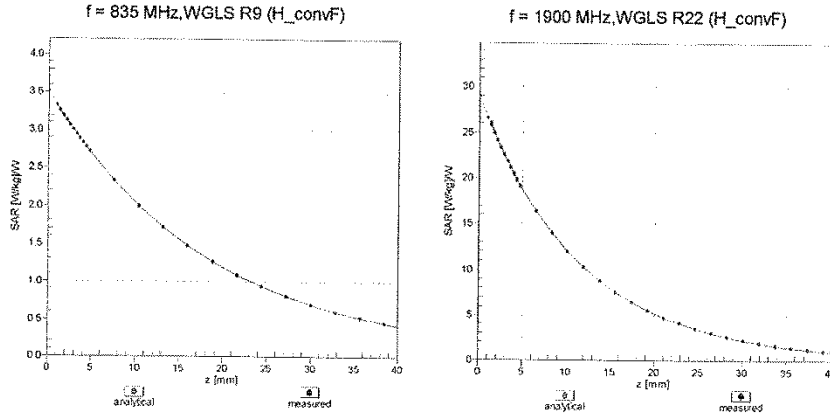

### Deviation from Isotropy in Liquid Error ( $\phi, \theta$ ), f = 900 MHz

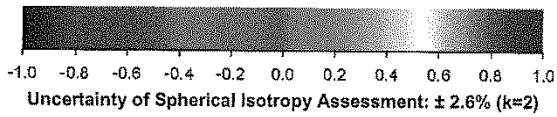
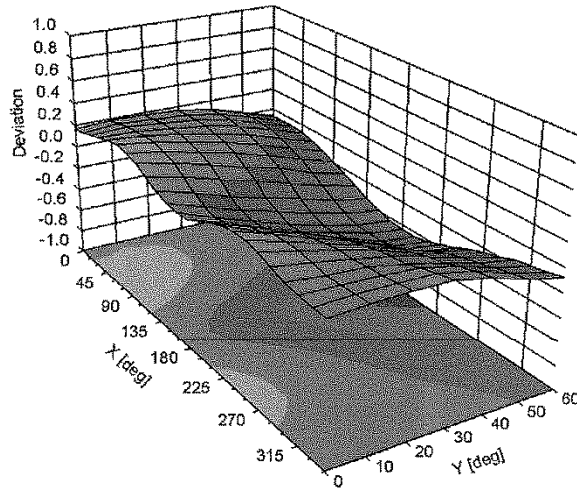

EX3DV4- SN:3825

December 11, 2017

## DASY/EASY - Parameters of Probe: EX3DV4 - SN:3825

### Other Probe Parameters

Sensor Arrangement	Triangular
Connector Angle (°)	-23.5
Mechanical Surface Detection Mode	enabled
Optical Surface Detection Mode	disabled
Probe Overall Length	337 mm
Probe Body Diameter	10 mm
Tip Length	9 mm
Tip Diameter	2.5 mm
Probe Tip to Sensor X Calibration Point	1 mm
Probe Tip to Sensor Y Calibration Point	1 mm
Probe Tip to Sensor Z Calibration Point	1 mm
Recommended Measurement Distance from Surface	1.4 mm

EX3DV4-- SN:3825

December 11, 2017

**Appendix: Modulation Calibration Parameters**

UID	Communication System Name		A dB	B dB $\mu$ V	C	D dB	VR mV	Max Unc <sup>E</sup> (k=2)
0	CW	X	0.00	0.00	1.00	0.00	130.2	$\pm 3.8\%$
		Y	0.00	0.00	1.00		132.4	
		Z	0.00	0.00	1.00		133.4	
10010-CAA	SAR Validation (Square, 100ms, 10ms)	X	2.32	65.32	9.89	10.00	20.0	$\pm 9.6\%$
		Y	2.17	65.00	9.60		20.0	
		Z	3.12	68.59	12.10		20.0	
10011-CAB	UMTS-FDD (WCDMA)	X	0.97	66.92	14.92	0.00	150.0	$\pm 9.6\%$
		Y	1.30	73.53	18.38		150.0	
		Z	1.05	69.12	16.00		150.0	
10012-CAB	IEEE 802.11b WiFi 2.4 GHz (DSSS, 1 Mbps)	X	1.20	64.16	15.17	0.41	150.0	$\pm 9.6\%$
		Y	1.17	65.46	16.39		150.0	
		Z	1.14	64.60	15.87		150.0	
10013-CAB	IEEE 802.11g WiFi 2.4 GHz (DSSS-OFDM, 6 Mbps)	X	4.73	66.78	16.95	1.46	150.0	$\pm 9.6\%$
		Y	4.70	67.08	17.20		150.0	
		Z	4.88	66.80	17.31		150.0	
10021-DAC	GSM-FDD (TDMA, GMSK)	X	96.50	108.13	24.70	9.39	50.0	$\pm 9.6\%$
		Y	100.00	109.99	25.30		50.0	
		Z	100.00	116.19	28.81		50.0	
10023-DAC	GPRS-FDD (TDMA, GMSK, TN 0)	X	29.01	94.16	21.22	9.57	50.0	$\pm 9.6\%$
		Y	100.00	109.56	25.15		50.0	
		Z	100.00	115.93	28.74		50.0	
10024-DAC	GPRS-FDD (TDMA, GMSK, TN 0-1)	X	100.00	105.46	22.67	6.56	60.0	$\pm 9.6\%$
		Y	100.00	108.94	23.75		60.0	
		Z	100.00	114.08	26.73		60.0	
10025-DAC	EDGE-FDD (TDMA, 8PSK, TN 0)	X	3.82	67.11	23.77	12.57	50.0	$\pm 9.6\%$
		Y	5.85	81.19	31.58		50.0	
		Z	4.25	69.19	25.25		50.0	
10026-DAC	EDGE-FDD (TDMA, 8PSK, TN 0-1)	X	11.57	95.78	33.17	9.56	60.0	$\pm 9.6\%$
		Y	9.48	94.32	33.64		60.0	
		Z	11.79	97.11	34.40		60.0	
10027-DAC	GPRS-FDD (TDMA, GMSK, TN 0-1-2)	X	100.00	104.69	21.78	4.80	80.0	$\pm 9.6\%$
		Y	100.00	109.96	23.44		80.0	
		Z	100.00	113.57	25.67		80.0	
10028-DAC	GPRS-FDD (TDMA, GMSK, TN 0-1-2-3)	X	100.00	105.08	21.44	3.55	100.0	$\pm 9.6\%$
		Y	100.00	112.62	23.90		100.0	
		Z	100.00	113.65	24.96		100.0	
10029-DAC	EDGE-FDD (TDMA, 8PSK, TN 0-1-2)	X	7.37	85.27	28.12	7.80	80.0	$\pm 9.6\%$
		Y	5.60	82.00	27.73		80.0	
		Z	7.35	86.32	29.31		80.0	
10030-CAA	IEEE 802.15.1 Bluetooth (GFSK, DH1)	X	79.75	101.33	20.96	5.30	70.0	$\pm 9.6\%$
		Y	100.00	107.18	22.50		70.0	
		Z	100.00	112.15	25.36		70.0	
10031-CAA	IEEE 802.15.1 Bluetooth (GFSK, DH3)	X	100.00	103.80	19.85	1.88	100.0	$\pm 9.6\%$
		Y	100.00	109.69	21.32		100.0	
		Z	100.00	105.97	20.28		100.0	

EX3DV4- SN:3825

December 11, 2017

10032-CAA	IEEE 802.15.1 Bluetooth (GFSK, DH5)	X	100.00	108.29	20.97	1.17	100.0	± 9.6 %
		Y	100.00	123.15	25.54		100.0	
		Z	100.00	97.48	15.96		100.0	
10033-CAA	IEEE 802.15.1 Bluetooth (PI/4-DQPSK, DH1)	X	8.77	84.47	20.14	5.30	70.0	± 9.6 %
		Y	39.36	109.92	28.29		70.0	
		Z	100.00	127.97	34.36		70.0	
10034-CAA	IEEE 802.15.1 Bluetooth (PI/4-DQPSK, DH3)	X	3.07	74.01	15.14	1.88	100.0	± 9.6 %
		Y	12.78	95.03	22.54		100.0	
		Z	12.48	97.00	24.60		100.0	
10035-CAA	IEEE 802.15.1 Bluetooth (PI/4-DQPSK, DH5)	X	2.15	71.43	14.02	1.17	100.0	± 9.6 %
		Y	6.07	86.85	19.94		100.0	
		Z	4.28	83.30	20.07		100.0	
10036-CAA	IEEE 802.15.1 Bluetooth (8-DPSK, DH1)	X	11.25	87.97	21.31	5.30	70.0	± 9.6 %
		Y	100.00	123.56	31.60		70.0	
		Z	100.00	128.40	34.56		70.0	
10037-CAA	IEEE 802.15.1 Bluetooth (8-DPSK, DH3)	X	2.80	73.04	14.76	1.88	100.0	± 9.6 %
		Y	8.69	90.39	21.23		100.0	
		Z	10.26	94.35	23.81		100.0	
10038-CAA	IEEE 802.15.1 Bluetooth (8-DPSK, DH5)	X	2.18	71.82	14.29	1.17	100.0	± 9.6 %
		Y	6.63	88.44	20.59		100.0	
		Z	4.59	84.63	20.65		100.0	
10039-CAB	CDMA2000 (1xRTT, RC1)	X	1.40	69.61	13.47	0.00	150.0	± 9.6 %
		Y	5.95	87.78	19.95		150.0	
		Z	2.16	74.59	16.41		150.0	
10042-CAB	IS-64 / IS-136 FDD (TDMA/FDM, PI/4-DQPSK, Halfrate)	X	19.18	87.76	18.24	7.78	50.0	± 9.6 %
		Y	100.00	105.97	22.70		50.0	
		Z	100.00	111.10	25.61		50.0	
10044-CAA	IS-91/EIA/TIA-553 FDD (FDMA, FM)	X	0.00	96.47	2.60	0.00	150.0	± 9.6 %
		Y	0.02	122.17	2.62		150.0	
		Z	0.14	129.11	5.34		150.0	
10048-CAA	DECT (TDD, TDMA/FDM, GFSK, Full Slot, 24)	X	9.62	81.25	18.67	13.80	25.0	± 9.6 %
		Y	12.83	82.53	19.07		25.0	
		Z	100.00	115.45	30.06		25.0	
10049-CAA	DECT (TDD, TDMA/FDM, GFSK, Double Slot, 12)	X	9.98	81.49	17.65	10.79	40.0	± 9.6 %
		Y	20.25	90.00	20.35		40.0	
		Z	100.00	115.58	28.94		40.0	
10056-CAA	UMTS-TDD (TD-SCDMA, 1.28 Mcps)	X	13.24	87.99	22.00	9.03	50.0	± 9.6 %
		Y	33.25	103.14	26.82		50.0	
		Z	43.32	110.45	30.46		50.0	
10058-DAC	EDGE-FDD (TDMA, 8PSK, TN 0-1-2-3)	X	5.61	79.85	25.26	6.55	100.0	± 9.6 %
		Y	4.30	76.74	24.76		100.0	
		Z	5.51	80.59	26.31		100.0	
10059-CAB	IEEE 802.11b WiFi 2.4 GHz (DSSS, 2 Mbps)	X	1.27	65.50	15.79	0.61	110.0	± 9.6 %
		Y	1.23	66.87	17.13		110.0	
		Z	1.22	66.36	16.83		110.0	
10060-CAB	IEEE 802.11b WiFi 2.4 GHz (DSSS, 5.5 Mbps)	X	17.91	106.04	26.83	1.30	110.0	± 9.6 %
		Y	100.00	143.03	37.48		110.0	
		Z	100.00	137.29	35.27		110.0	



EX3DV4-- SN:3825

December 11, 2017

10061-CAB	IEEE 802.11b WiFi 2.4 GHz (DSSS, 11 Mbps)	X	3.99	82.77	21.95	2.04	110.0	± 9.6 %
		Y	5.00	91.99	26.50		110.0	
		Z	9.27	100.97	29.19		110.0	
10062-CAC	IEEE 802.11a/h WiFi 5 GHz (OFDM, 6 Mbps)	X	4.51	66.73	16.40	0.49	100.0	± 9.6 %
		Y	4.51	67.12	16.68		100.0	
		Z	4.66	66.73	16.68		100.0	
10063-CAC	IEEE 802.11a/h WiFi 5 GHz (OFDM, 9 Mbps)	X	4.53	66.83	16.49	0.72	100.0	± 9.6 %
		Y	4.52	67.21	16.77		100.0	
		Z	4.69	66.85	16.80		100.0	
10064-CAC	IEEE 802.11a/h WiFi 5 GHz (OFDM, 12 Mbps)	X	4.77	67.01	16.67	0.86	100.0	± 9.6 %
		Y	4.76	67.38	16.94		100.0	
		Z	4.98	67.13	17.04		100.0	
10065-CAC	IEEE 802.11a/h WiFi 5 GHz (OFDM, 18 Mbps)	X	4.65	66.90	16.75	1.21	100.0	± 9.6 %
		Y	4.64	67.24	17.02		100.0	
		Z	4.86	67.08	17.17		100.0	
10066-CAC	IEEE 802.11a/h WiFi 5 GHz (OFDM, 24 Mbps)	X	4.67	66.91	16.90	1.46	100.0	± 9.6 %
		Y	4.65	67.24	17.17		100.0	
		Z	4.89	67.12	17.36		100.0	
10067-CAC	IEEE 802.11a/h WiFi 5 GHz (OFDM, 36 Mbps)	X	4.96	67.18	17.36	2.04	100.0	± 9.6 %
		Y	4.93	67.45	17.61		100.0	
		Z	5.18	67.28	17.80		100.0	
10068-CAC	IEEE 802.11a/h WiFi 5 GHz (OFDM, 48 Mbps)	X	5.00	67.12	17.52	2.55	100.0	± 9.6 %
		Y	4.96	67.38	17.76		100.0	
		Z	5.25	67.40	18.06		100.0	
10069-CAC	IEEE 802.11a/h WiFi 5 GHz (OFDM, 54 Mbps)	X	5.07	67.15	17.71	2.67	100.0	± 9.6 %
		Y	5.03	67.39	17.94		100.0	
		Z	5.33	67.38	18.24		100.0	
10071-CAB	IEEE 802.11g WiFi 2.4 GHz (DSSS/OFDM, 9 Mbps)	X	4.83	66.87	17.23	1.99	100.0	± 9.6 %
		Y	4.79	67.14	17.47		100.0	
		Z	4.98	66.93	17.64		100.0	
10072-CAB	IEEE 802.11g WiFi 2.4 GHz (DSSS/OFDM, 12 Mbps)	X	4.80	67.16	17.42	2.30	100.0	± 9.6 %
		Y	4.75	67.42	17.68		100.0	
		Z	4.99	67.33	17.90		100.0	
10073-CAB	IEEE 802.11g WiFi 2.4 GHz (DSSS/OFDM, 18 Mbps)	X	4.88	67.39	17.76	2.83	100.0	± 9.6 %
		Y	4.82	67.61	18.01		100.0	
		Z	5.08	67.54	18.25		100.0	
10074-CAB	IEEE 802.11g WiFi 2.4 GHz (DSSS/OFDM, 24 Mbps)	X	4.90	67.38	17.93	3.30	100.0	± 9.6 %
		Y	4.82	67.55	18.15		100.0	
		Z	5.05	67.46	18.42		100.0	
10075-CAB	IEEE 802.11g WiFi 2.4 GHz (DSSS/OFDM, 36 Mbps)	X	4.94	67.45	18.19	3.82	90.0	± 9.6 %
		Y	4.85	67.58	18.41		90.0	
		Z	5.11	67.65	18.78		90.0	
10076-CAB	IEEE 802.11g WiFi 2.4 GHz (DSSS/OFDM, 48 Mbps)	X	4.98	67.35	18.36	4.15	90.0	± 9.6 %
		Y	4.88	67.43	18.56		90.0	
		Z	5.12	67.41	18.88		90.0	
10077-CAB	IEEE 802.11g WiFi 2.4 GHz (DSSS/OFDM, 54 Mbps)	X	5.02	67.45	18.48	4.30	90.0	± 9.6 %
		Y	4.92	67.53	18.68		90.0	
		Z	5.14	67.47	18.97		90.0	

EX3DV4--SN:3825

December 11, 2017

10081-CAB	CDMA2000 (1xRTT, RC3)	X	0.68	64.56	10.70	0.00	150.0	± 9.6 %
		Y	1.07	70.92	13.61		150.0	
		Z	0.81	66.46	12.29		150.0	
10082-CAB	IS-54 / IS-136 FDD (TDMA/FDM, PI/4-DQPSK, Fullrate)	X	0.95	60.00	4.82	4.77	80.0	± 9.6 %
		Y	0.68	60.00	4.15		80.0	
		Z	0.84	60.00	4.83		80.0	
10090-DAC	GPRS-FDD (TDMA, GMSK, TN 0-4)	X	100.00	105.48	22.70	6.56	60.0	± 9.6 %
		Y	100.00	108.98	23.79		60.0	
		Z	100.00	114.18	26.80		60.0	
10097-CAB	UMTS-FDD (HSDPA)	X	1.80	68.14	15.55	0.00	150.0	± 9.6 %
		Y	2.10	71.71	17.46		150.0	
		Z	1.84	68.50	16.11		150.0	
10098-CAB	UMTS-FDD (HSUPA, Subtest 2)	X	1.76	68.07	15.52	0.00	150.0	± 9.6 %
		Y	2.06	71.70	17.46		150.0	
		Z	1.80	68.46	16.08		150.0	
10099-DAC	EDGE-FDD (TDMA, 8PSK, TN 0-4)	X	11.66	95.90	33.20	9.56	60.0	± 9.6 %
		Y	9.56	94.48	33.69		60.0	
		Z	11.87	97.23	34.44		60.0	
10100-CAD	LTE-FDD (SC-FDMA, 100% RB, 20 MHz, QPSK)	X	2.95	69.89	16.60	0.00	150.0	± 9.6 %
		Y	3.29	72.47	17.88		150.0	
		Z	3.20	71.00	17.02		150.0	
10101-CAD	LTE-FDD (SC-FDMA, 100% RB, 20 MHz, 16-QAM)	X	3.10	67.29	15.83	0.00	150.0	± 9.6 %
		Y	3.19	68.44	16.49		150.0	
		Z	3.22	67.72	16.11		150.0	
10102-CAD	LTE-FDD (SC-FDMA, 100% RB, 20 MHz, 64-QAM)	X	3.21	67.32	15.94	0.00	150.0	± 9.6 %
		Y	3.29	68.39	16.56		150.0	
		Z	3.33	67.68	16.21		150.0	
10103-CAD	LTE-TDD (SC-FDMA, 100% RB, 20 MHz, QPSK)	X	6.76	76.32	20.28	3.98	65.0	± 9.6 %
		Y	6.30	76.96	21.00		65.0	
		Z	7.06	77.65	21.42		65.0	
10104-CAD	LTE-TDD (SC-FDMA, 100% RB, 20 MHz, 16-QAM)	X	6.87	74.93	20.48	3.98	65.0	± 9.6 %
		Y	5.95	73.88	20.46		65.0	
		Z	6.72	74.94	21.12		65.0	
10105-CAD	LTE-TDD (SC-FDMA, 100% RB, 20 MHz, 64-QAM)	X	6.77	74.61	20.67	3.98	65.0	± 9.6 %
		Y	5.55	72.34	20.07		65.0	
		Z	6.54	74.33	21.17		65.0	
10108-CAE	LTE-FDD (SC-FDMA, 100% RB, 10 MHz, QPSK)	X	2.55	69.22	16.43	0.00	150.0	± 9.6 %
		Y	2.84	71.87	17.79		150.0	
		Z	2.79	70.30	16.89		150.0	
10109-CAE	LTE-FDD (SC-FDMA, 100% RB, 10 MHz, 16-QAM)	X	2.75	67.26	15.69	0.00	150.0	± 9.6 %
		Y	2.86	68.63	16.50		150.0	
		Z	2.89	67.66	16.06		150.0	
10110-CAE	LTE-FDD (SC-FDMA, 100% RB, 5 MHz, QPSK)	X	2.04	68.42	15.90	0.00	150.0	± 9.6 %
		Y	2.32	71.50	17.54		150.0	
		Z	2.25	69.48	16.54		150.0	
10111-CAE	LTE-FDD (SC-FDMA, 100% RB, 5 MHz, 16-QAM)	X	2.50	68.53	15.98	0.00	150.0	± 9.6 %
		Y	2.74	70.80	17.23		150.0	
		Z	2.63	68.79	16.49		150.0	

EX3DV4-- SN:3825

December 11, 2017

10112-CAE	LTE-FDD (SC-FDMA, 100% RB, 10 MHz, 64-QAM)	X	2.88	67.34	15.78	0.00	150.0	± 9.6 %
		Y	2.99	68.63	16.54		150.0	
		Z	3.01	67.63	16.11		150.0	
10113-CAE	LTE-FDD (SC-FDMA, 100% RB, 5 MHz, 64-QAM)	X	2.65	68.74	16.14	0.00	150.0	± 9.6 %
		Y	2.88	70.88	17.32		150.0	
		Z	2.79	68.91	16.62		150.0	
10114-CAC	IEEE 802.11n (HT Greenfield, 13.5 Mbps, BPSK)	X	4.96	67.12	16.40	0.00	150.0	± 9.6 %
		Y	4.95	67.47	16.60		150.0	
		Z	5.10	67.21	16.55		150.0	
10115-CAC	IEEE 802.11n (HT Greenfield, 81 Mbps, 16-QAM)	X	5.21	67.19	16.44	0.00	150.0	± 9.6 %
		Y	5.19	67.50	16.61		150.0	
		Z	5.40	67.36	16.63		150.0	
10116-CAC	IEEE 802.11n (HT Greenfield, 135 Mbps, 64-QAM)	X	5.05	67.31	16.43	0.00	150.0	± 9.6 %
		Y	5.04	67.66	16.63		150.0	
		Z	5.21	67.42	16.58		150.0	
10117-CAC	IEEE 802.11n (HT Mixed, 13.5 Mbps, BPSK)	X	4.96	67.07	16.40	0.00	150.0	± 9.6 %
		Y	4.95	67.42	16.60		150.0	
		Z	5.06	67.05	16.49		150.0	
10118-CAC	IEEE 802.11n (HT Mixed, 81 Mbps, 16-QAM)	X	5.28	67.38	16.54	0.00	150.0	± 9.6 %
		Y	5.26	67.66	16.70		150.0	
		Z	5.50	67.60	16.76		150.0	
10119-CAC	IEEE 802.11n (HT Mixed, 135 Mbps, 64-QAM)	X	5.04	67.30	16.43	0.00	150.0	± 9.6 %
		Y	5.03	67.65	16.63		150.0	
		Z	5.18	67.37	16.57		150.0	
10140-CAD	LTE-FDD (SC-FDMA, 100% RB, 15 MHz, 16-QAM)	X	3.23	67.34	15.85	0.00	150.0	± 9.6 %
		Y	3.32	68.40	16.47		150.0	
		Z	3.36	67.67	16.11		150.0	
10141-CAD	LTE-FDD (SC-FDMA, 100% RB, 15 MHz, 64-QAM)	X	3.36	67.52	16.06	0.00	150.0	± 9.6 %
		Y	3.45	69.54	16.65		150.0	
		Z	3.49	67.77	16.29		150.0	
10142-CAD	LTE-FDD (SC-FDMA, 100% RB, 3 MHz, QPSK)	X	1.80	68.41	15.28	0.00	150.0	± 9.6 %
		Y	2.20	72.51	17.38		150.0	
		Z	2.04	69.65	16.25		150.0	
10143-CAD	LTE-FDD (SC-FDMA, 100% RB, 3 MHz, 16-QAM)	X	2.31	69.08	15.24	0.00	150.0	± 9.6 %
		Y	2.79	72.70	17.06		150.0	
		Z	2.54	69.78	16.25		150.0	
10144-CAD	LTE-FDD (SC-FDMA, 100% RB, 3 MHz, 64-QAM)	X	1.97	65.98	13.16	0.00	150.0	± 9.6 %
		Y	2.17	67.97	14.30		150.0	
		Z	2.23	66.89	14.34		150.0	
10145-CAE	LTE-FDD (SC-FDMA, 100% RB, 1.4 MHz, QPSK)	X	0.83	61.98	8.65	0.00	150.0	± 9.6 %
		Y	0.89	63.32	9.43		150.0	
		Z	1.16	65.01	11.51		150.0	
10146-CAE	LTE-FDD (SC-FDMA, 100% RB, 1.4 MHz, 16-QAM)	X	1.21	62.48	8.56	0.00	150.0	± 9.6 %
		Y	1.20	62.18	7.86		150.0	
		Z	2.32	68.53	12.99		150.0	
10147-CAE	LTE-FDD (SC-FDMA, 100% RB, 1.4 MHz, 64-QAM)	X	1.34	63.44	9.18	0.00	150.0	± 9.6 %
		Y	1.31	62.97	8.38		150.0	
		Z	3.21	72.66	14.92		150.0	

EX3DV4- SN:3825

December 11, 2017

10149-CAD	LTE-FDD (SC-FDMA, 50% RB, 20 MHz, 16-QAM)	X	2.76	67.33	15.75	0.00	150.0	± 9.6 %
		Y	2.87	68.72	16.56		150.0	
		Z	2.90	67.73	16.11		150.0	
10150-CAD	LTE-FDD (SC-FDMA, 50% RB, 20 MHz, 64-QAM)	X	2.89	67.41	15.83	0.00	150.0	± 9.6 %
		Y	3.00	68.70	16.59		150.0	
		Z	3.02	67.69	16.15		150.0	
10151-CAD	LTE-TDD (SC-FDMA, 50% RB, 20 MHz, QPSK)	X	7.75	80.06	21.67	3.98	65.0	± 9.6 %
		Y	6.97	80.52	22.45		65.0	
		Z	7.85	81.17	22.89		65.0	
10152-CAD	LTE-TDD (SC-FDMA, 50% RB, 20 MHz, 16-QAM)	X	6.37	74.81	19.94	3.98	65.0	± 9.6 %
		Y	5.51	74.00	20.10		65.0	
		Z	6.30	75.12	20.91		65.0	
10153-CAD	LTE-TDD (SC-FDMA, 50% RB, 20 MHz, 64-QAM)	X	6.91	76.22	20.92	3.98	65.0	± 9.6 %
		Y	5.95	75.23	21.01		65.0	
		Z	6.73	76.21	21.76		65.0	
10154-CAE	LTE-FDD (SC-FDMA, 50% RB, 10 MHz, QPSK)	X	2.08	68.83	16.16	0.00	150.0	± 9.6 %
		Y	2.40	72.10	17.87		150.0	
		Z	2.32	70.06	16.88		150.0	
10155-CAE	LTE-FDD (SC-FDMA, 50% RB, 10 MHz, 16-QAM)	X	2.50	68.57	16.01	0.00	150.0	± 9.6 %
		Y	2.74	70.85	17.27		150.0	
		Z	2.64	68.81	16.50		150.0	
10156-CAE	LTE-FDD (SC-FDMA, 50% RB, 5 MHz, QPSK)	X	1.63	68.21	14.76	0.00	150.0	± 9.6 %
		Y	2.12	73.23	17.25		150.0	
		Z	1.91	69.94	16.10		150.0	
10157-CAE	LTE-FDD (SC-FDMA, 50% RB, 5 MHz, 16-QAM)	X	1.78	66.23	12.90	0.00	150.0	± 9.6 %
		Y	2.07	68.97	14.37		150.0	
		Z	2.08	67.61	14.41		150.0	
10158-CAE	LTE-FDD (SC-FDMA, 50% RB, 10 MHz, 64-QAM)	X	2.66	68.84	16.20	0.00	150.0	± 9.6 %
		Y	2.90	71.00	17.39		150.0	
		Z	2.80	68.99	16.67		150.0	
10159-CAE	LTE-FDD (SC-FDMA, 50% RB, 5 MHz, 64-QAM)	X	1.87	66.61	13.12	0.00	150.0	± 9.6 %
		Y	2.21	69.59	14.70		150.0	
		Z	2.21	68.17	14.75		150.0	
10160-CAD	LTE-FDD (SC-FDMA, 50% RB, 15 MHz, QPSK)	X	2.59	68.61	16.24	0.00	150.0	± 9.6 %
		Y	2.79	70.63	17.35		150.0	
		Z	2.78	69.29	16.66		150.0	
10161-CAD	LTE-FDD (SC-FDMA, 50% RB, 15 MHz, 16-QAM)	X	2.78	67.39	15.71	0.00	150.0	± 9.6 %
		Y	2.90	68.77	16.53		150.0	
		Z	2.92	67.66	16.10		150.0	
10162-CAD	LTE-FDD (SC-FDMA, 50% RB, 15 MHz, 64-QAM)	X	2.89	67.62	15.86	0.00	150.0	± 9.6 %
		Y	3.01	68.98	16.66		150.0	
		Z	3.03	67.79	16.20		150.0	
10166-CAE	LTE-FDD (SC-FDMA, 50% RB, 1.4 MHz, QPSK)	X	3.26	69.20	19.29	3.01	150.0	± 9.6 %
		Y	3.51	71.34	20.12		150.0	
		Z	3.73	70.49	19.78		150.0	
10167-CAE	LTE-FDD (SC-FDMA, 50% RB, 1.4 MHz, 16-QAM)	X	3.80	71.79	19.65	3.01	150.0	± 9.6 %
		Y	4.76	76.37	21.29		150.0	
		Z	4.70	73.49	20.20		150.0	

EX3DV4- SN:3825

December 11, 2017

10168-CAE	LTE-FDD (SC-FDMA, 50% RB, 1.4 MHz, 64-QAM)	X	4.33	74.78	21.41	3.01	150.0	± 9.6 %
		Y	5.81	80.65	23.43		150.0	
		Z	5.36	76.38	21.82		150.0	
10169-CAD	LTE-FDD (SC-FDMA, 1 RB, 20 MHz, QPSK)	X	2.63	67.43	18.51	3.01	150.0	± 9.6 %
		Y	2.99	71.01	20.02		150.0	
		Z	3.19	70.26	19.70		150.0	
10170-CAD	LTE-FDD (SC-FDMA, 1 RB, 20 MHz, 16-QAM)	X	3.32	72.63	20.82	3.01	150.0	± 9.6 %
		Y	5.38	82.61	24.45		150.0	
		Z	4.68	77.11	22.34		150.0	
10171-AAD	LTE-FDD (SC-FDMA, 1 RB, 20 MHz, 64-QAM)	X	2.75	68.63	17.92	3.01	150.0	± 9.6 %
		Y	3.75	74.95	20.27		150.0	
		Z	3.68	71.91	19.11		150.0	
10172-CAD	LTE-TDD (SC-FDMA, 1 RB, 20 MHz, QPSK)	X	8.47	91.36	28.31	6.02	65.0	± 9.6 %
		Y	7.59	92.71	29.34		65.0	
		Z	17.43	105.26	33.28		65.0	
10173-CAD	LTE-TDD (SC-FDMA, 1 RB, 20 MHz, 16-QAM)	X	13.13	95.77	27.80	6.02	65.0	± 9.6 %
		Y	58.71	124.46	35.70		65.0	
		Z	33.86	112.18	33.21		65.0	
10174-CAD	LTE-TDD (SC-FDMA, 1 RB, 20 MHz, 64-QAM)	X	8.10	86.73	24.39	6.02	65.0	± 9.6 %
		Y	21.19	105.08	29.96		65.0	
		Z	21.92	102.71	29.92		65.0	
10175-CAE	LTE-FDD (SC-FDMA, 1 RB, 10 MHz, QPSK)	X	2.61	67.13	18.26	3.01	150.0	± 9.6 %
		Y	2.94	70.80	19.72		150.0	
		Z	3.14	69.86	19.40		150.0	
10176-CAE	LTE-FDD (SC-FDMA, 1 RB, 10 MHz, 16-QAM)	X	3.32	72.66	20.84	3.01	150.0	± 9.6 %
		Y	5.39	82.65	24.47		150.0	
		Z	4.69	77.14	22.35		150.0	
10177-CAG	LTE-FDD (SC-FDMA, 1 RB, 5 MHz, QPSK)	X	2.62	67.26	18.34	3.01	150.0	± 9.6 %
		Y	2.97	70.78	19.82		150.0	
		Z	3.18	70.06	19.52		150.0	
10178-CAE	LTE-FDD (SC-FDMA, 1 RB, 5 MHz, 16-QAM)	X	3.30	72.49	20.74	3.01	150.0	± 9.6 %
		Y	5.31	82.33	24.32		150.0	
		Z	4.62	76.83	22.19		150.0	
10179-CAE	LTE-FDD (SC-FDMA, 1 RB, 10 MHz, 64-QAM)	X	3.01	70.53	19.26	3.01	150.0	± 9.6 %
		Y	4.45	78.50	22.18		150.0	
		Z	4.12	74.30	20.65		150.0	
10180-CAE	LTE-FDD (SC-FDMA, 1 RB, 5 MHz, 64-QAM)	X	2.75	68.58	17.89	3.01	150.0	± 9.6 %
		Y	3.74	74.86	20.22		150.0	
		Z	3.66	71.81	19.05		150.0	
10181-CAD	LTE-FDD (SC-FDMA, 1 RB, 15 MHz, QPSK)	X	2.62	67.25	18.34	3.01	150.0	± 9.6 %
		Y	2.96	70.75	19.81		150.0	
		Z	3.17	70.04	19.51		150.0	
10182-CAD	LTE-FDD (SC-FDMA, 1 RB, 15 MHz, 16-QAM)	X	3.30	72.46	20.72	3.01	150.0	± 9.6 %
		Y	5.30	82.29	24.31		150.0	
		Z	4.61	76.80	22.18		150.0	
10183-AAC	LTE-FDD (SC-FDMA, 1 RB, 15 MHz, 64-QAM)	X	2.75	68.56	17.88	3.01	150.0	± 9.6 %
		Y	3.73	74.82	20.20		150.0	
		Z	3.66	71.79	19.03		150.0	

EX3DV4- SN:3825

December 11, 2017

10184-CAD	LTE-FDD (SC-FDMA, 1 RB, 3 MHz, QPSK)	X	2.63	67.29	18.36	3.01	150.0	± 9.6 %
		Y	2.97	70.81	19.84		150.0	
		Z	3.18	70.09	19.53		150.0	
10185-CAD	LTE-FDD (SC-FDMA, 1 RB, 3 MHz, 16-QAM)	X	3.31	72.54	20.76	3.01	150.0	± 9.6 %
		Y	5.33	82.41	24.36		150.0	
		Z	4.64	76.89	22.22		150.0	
10186-AAD	LTE-FDD (SC-FDMA, 1 RB, 3 MHz, 64-QAM)	X	2.76	68.62	17.91	3.01	150.0	± 9.6 %
		Y	3.75	74.92	20.25		150.0	
		Z	3.68	71.86	19.07		150.0	
10187-CAE	LTE-FDD (SC-FDMA, 1 RB, 1.4 MHz, QPSK)	X	2.64	67.36	18.44	3.01	150.0	± 9.6 %
		Y	2.99	70.91	19.93		150.0	
		Z	3.19	70.14	19.60		150.0	
10188-CAE	LTE-FDD (SC-FDMA, 1 RB, 1.4 MHz, 16-QAM)	X	3.40	73.15	21.14	3.01	150.0	± 9.6 %
		Y	5.65	83.62	24.93		150.0	
		Z	4.83	77.77	22.69		150.0	
10189-AAE	LTE-FDD (SC-FDMA, 1 RB, 1.4 MHz, 64-QAM)	X	2.81	69.00	18.18	3.01	150.0	± 9.6 %
		Y	3.88	75.61	20.63		150.0	
		Z	3.77	72.37	19.39		150.0	
10193-CAC	IEEE 802.11n (HT Greenfield, 6.5 Mbps, BPSK)	X	4.37	66.77	16.11	0.00	150.0	± 9.6 %
		Y	4.38	67.20	16.38		150.0	
		Z	4.48	66.60	16.25		150.0	
10194-CAC	IEEE 802.11n (HT Greenfield, 39 Mbps, 16-QAM)	X	4.52	67.01	16.24	0.00	150.0	± 9.6 %
		Y	4.53	67.45	16.51		150.0	
		Z	4.66	66.92	16.37		150.0	
10195-CAC	IEEE 802.11n (HT Greenfield, 65 Mbps, 64-QAM)	X	4.55	67.03	16.25	0.00	150.0	± 9.6 %
		Y	4.56	67.46	16.52		150.0	
		Z	4.70	66.95	16.39		150.0	
10196-CAC	IEEE 802.11n (HT Mixed, 6.5 Mbps, BPSK)	X	4.36	66.77	16.10	0.00	150.0	± 9.6 %
		Y	4.37	67.21	16.38		150.0	
		Z	4.49	66.67	16.27		150.0	
10197-CAC	IEEE 802.11n (HT Mixed, 39 Mbps, 16-QAM)	X	4.52	67.01	16.25	0.00	150.0	± 9.6 %
		Y	4.53	67.45	16.51		150.0	
		Z	4.67	66.94	16.38		150.0	
10198-CAC	IEEE 802.11n (HT Mixed, 65 Mbps, 64-QAM)	X	4.54	67.03	16.26	0.00	150.0	± 9.6 %
		Y	4.56	67.46	16.52		150.0	
		Z	4.70	66.97	16.40		150.0	
10219-CAC	IEEE 802.11n (HT Mixed, 7.2 Mbps, BPSK)	X	4.31	66.81	16.07	0.00	150.0	± 9.6 %
		Y	4.32	67.26	16.36		150.0	
		Z	4.44	66.68	16.23		150.0	
10220-CAC	IEEE 802.11n (HT Mixed, 43.3 Mbps, 16-QAM)	X	4.52	66.97	16.23	0.00	150.0	± 9.6 %
		Y	4.53	67.41	16.50		150.0	
		Z	4.67	66.91	16.37		150.0	
10221-CAC	IEEE 802.11n (HT Mixed, 72.2 Mbps, 64-QAM)	X	4.56	66.97	16.25	0.00	150.0	± 9.6 %
		Y	4.57	67.39	16.50		150.0	
		Z	4.71	66.89	16.38		150.0	
10222-CAC	IEEE 802.11n (HT Mixed, 15 Mbps, BPSK)	X	4.93	67.05	16.38	0.00	150.0	± 9.6 %
		Y	4.92	67.40	16.58		150.0	
		Z	5.04	67.06	16.49		150.0	

EX3DV4- SN:3825

December 11, 2017

10223-CAC	IEEE 802.11n (HT Mixed, 90 Mbps, 16-QAM)	X	5.20	67.25	16.49	0.00	150.0	± 9.6 %
		Y	5.18	67.55	16.66		150.0	
		Z	5.35	67.28	16.61		150.0	
10224-CAC	IEEE 802.11n (HT Mixed, 150 Mbps, 64-QAM)	X	4.97	67.17	16.36	0.00	150.0	± 9.6 %
		Y	4.96	67.53	16.57		150.0	
		Z	5.09	67.17	16.47		150.0	
10225-CAB	UMTS-FDD (HSPA+)	X	2.65	66.22	14.93	0.00	150.0	± 9.6 %
		Y	2.73	67.33	15.66		150.0	
		Z	2.77	66.29	15.50		150.0	
10226-CAA	LTE-TDD (SC-FDMA, 1 RB, 1.4 MHz, 16-QAM)	X	14.40	97.55	28.44	6.02	65.0	± 9.6 %
		Y	75.49	129.22	36.97		65.0	
		Z	38.39	114.70	33.99		65.0	
10227-CAA	LTE-TDD (SC-FDMA, 1 RB, 1.4 MHz, 64-QAM)	X	13.73	95.33	27.12	6.02	65.0	± 9.6 %
		Y	61.87	122.70	34.48		65.0	
		Z	33.56	110.31	32.14		65.0	
10228-CAA	LTE-TDD (SC-FDMA, 1 RB, 1.4 MHz, QPSK)	X	9.39	93.61	29.12	6.02	65.0	± 9.6 %
		Y	11.54	101.29	32.16		65.0	
		Z	20.56	109.35	34.66		65.0	
10229-CAB	LTE-TDD (SC-FDMA, 1 RB, 3 MHz, 16-QAM)	X	13.24	95.90	27.85	6.02	65.0	± 9.6 %
		Y	59.54	124.70	35.77		65.0	
		Z	34.12	112.31	33.25		65.0	
10230-CAB	LTE-TDD (SC-FDMA, 1 RB, 3 MHz, 64-QAM)	X	12.56	93.73	26.55	6.02	65.0	± 9.6 %
		Y	49.06	118.60	33.38		65.0	
		Z	30.04	108.20	31.48		65.0	
10231-CAB	LTE-TDD (SC-FDMA, 1 RB, 3 MHz, QPSK)	X	8.85	92.35	28.61	6.02	65.0	± 9.6 %
		Y	10.68	99.59	31.54		65.0	
		Z	18.89	107.48	34.02		65.0	
10232-CAD	LTE-TDD (SC-FDMA, 1 RB, 5 MHz, 16-QAM)	X	13.22	95.88	27.84	6.02	65.0	± 9.6 %
		Y	59.46	124.69	35.77		65.0	
		Z	34.08	112.30	33.25		65.0	
10233-CAD	LTE-TDD (SC-FDMA, 1 RB, 5 MHz, 64-QAM)	X	12.52	93.69	26.54	6.02	65.0	± 9.6 %
		Y	48.78	118.52	33.36		65.0	
		Z	29.97	108.18	31.47		65.0	
10234-CAD	LTE-TDD (SC-FDMA, 1 RB, 5 MHz, QPSK)	X	8.44	91.27	28.13	6.02	65.0	± 9.6 %
		Y	10.06	98.20	30.96		65.0	
		Z	17.60	105.82	33.40		65.0	
10235-CAD	LTE-TDD (SC-FDMA, 1 RB, 10 MHz, 16-QAM)	X	13.24	95.92	27.86	6.02	65.0	± 9.6 %
		Y	59.90	124.84	35.81		65.0	
		Z	34.22	112.39	33.27		65.0	
10236-CAD	LTE-TDD (SC-FDMA, 1 RB, 10 MHz, 64-QAM)	X	12.66	93.84	26.58	6.02	65.0	± 9.6 %
		Y	50.19	118.94	33.46		65.0	
		Z	30.45	108.41	31.53		65.0	
10237-CAD	LTE-TDD (SC-FDMA, 1 RB, 10 MHz, QPSK)	X	8.85	92.40	28.64	6.02	65.0	± 9.6 %
		Y	10.71	99.69	31.58		65.0	
		Z	19.01	107.65	34.07		65.0	
10238-CAD	LTE-TDD (SC-FDMA, 1 RB, 15 MHz, 16-QAM)	X	13.19	95.86	27.84	6.02	65.0	± 9.6 %
		Y	59.37	124.68	35.76		65.0	
		Z	34.05	112.30	33.24		65.0	

EX3DV4- SN:3825

December 11, 2017

10239-CAD	LTE-TDD (SC-FDMA, 1 RB, 15 MHz, 64-QAM)	X	12.47	93.64	26.53	6.02	65.0	± 9.6 %
		Y	48.49	118.45	33.35		65.0	
		Z	29.91	108.16	31.47		65.0	
10240-CAD	LTE-TDD (SC-FDMA, 1 RB, 15 MHz, QPSK)	X	8.84	92.37	28.62	6.02	65.0	± 9.6 %
		Y	10.68	99.68	31.57		65.0	
		Z	18.93	107.57	34.05		65.0	
10241-CAA	LTE-TDD (SC-FDMA, 50% RB, 1.4 MHz, 16-QAM)	X	8.76	83.74	26.12	6.98	65.0	± 9.6 %
		Y	8.90	85.75	27.11		65.0	
		Z	9.20	83.30	26.44		65.0	
10242-CAA	LTE-TDD (SC-FDMA, 50% RB, 1.4 MHz, 64-QAM)	X	8.37	82.86	25.71	6.98	65.0	± 9.6 %
		Y	7.57	82.42	25.75		65.0	
		Z	8.80	82.31	25.94		65.0	
10243-CAA	LTE-TDD (SC-FDMA, 50% RB, 1.4 MHz, QPSK)	X	6.79	79.44	25.26	6.98	65.0	± 9.6 %
		Y	5.75	77.37	24.65		65.0	
		Z	6.95	78.77	25.43		65.0	
10244-CAB	LTE-TDD (SC-FDMA, 50% RB, 3 MHz, 16-QAM)	X	5.06	72.10	15.45	3.98	65.0	± 9.6 %
		Y	4.83	73.01	15.96		65.0	
		Z	8.25	81.05	20.96		65.0	
10245-CAB	LTE-TDD (SC-FDMA, 50% RB, 3 MHz, 64-QAM)	X	4.88	71.37	15.08	3.98	65.0	± 9.6 %
		Y	4.59	72.06	15.50		65.0	
		Z	7.84	79.95	20.48		65.0	
10246-CAB	LTE-TDD (SC-FDMA, 50% RB, 3 MHz, QPSK)	X	4.73	73.77	16.24	3.98	65.0	± 9.6 %
		Y	5.17	77.72	18.44		65.0	
		Z	8.53	85.08	22.38		65.0	
10247-CAD	LTE-TDD (SC-FDMA, 50% RB, 5 MHz, 16-QAM)	X	4.93	72.19	16.38	3.98	65.0	± 9.6 %
		Y	4.57	73.17	17.38		65.0	
		Z	5.91	76.50	19.88		65.0	
10248-CAD	LTE-TDD (SC-FDMA, 50% RB, 5 MHz, 64-QAM)	X	4.85	71.56	16.11	3.98	65.0	± 9.6 %
		Y	4.44	72.25	16.96		65.0	
		Z	5.77	75.56	19.46		65.0	
10249-CAD	LTE-TDD (SC-FDMA, 50% RB, 5 MHz, QPSK)	X	7.13	80.40	20.04	3.98	65.0	± 9.6 %
		Y	7.86	85.05	22.47		65.0	
		Z	10.26	88.75	24.63		65.0	
10250-CAD	LTE-TDD (SC-FDMA, 50% RB, 10 MHz, 16-QAM)	X	6.72	77.59	20.79	3.98	65.0	± 9.6 %
		Y	5.84	77.29	21.29		65.0	
		Z	6.76	78.73	22.44		65.0	
10251-CAD	LTE-TDD (SC-FDMA, 50% RB, 10 MHz, 64-QAM)	X	6.07	74.68	19.21	3.98	65.0	± 9.6 %
		Y	5.31	74.33	19.63		65.0	
		Z	6.21	75.78	20.83		65.0	
10252-CAD	LTE-TDD (SC-FDMA, 50% RB, 10 MHz, QPSK)	X	8.33	83.07	22.47	3.98	65.0	± 9.6 %
		Y	7.81	84.87	23.87		65.0	
		Z	9.03	86.02	24.68		65.0	
10253-CAD	LTE-TDD (SC-FDMA, 50% RB, 15 MHz, 16-QAM)	X	6.26	74.37	19.66	3.98	65.0	± 9.6 %
		Y	5.42	73.56	19.82		65.0	
		Z	6.13	74.47	20.63		65.0	
10254-CAD	LTE-TDD (SC-FDMA, 50% RB, 15 MHz, 64-QAM)	X	6.73	75.57	20.50	3.98	65.0	± 9.6 %
		Y	5.80	74.63	20.60		65.0	
		Z	6.53	75.50	21.39		65.0	



EX3DV4- SN:3825

December 11, 2017

10255-CAD	LTE-TDD (SC-FDMA, 50% RB, 15 MHz, QPSK)	X	7.44	79.56	21.62	3.98	65.0	± 9.6 %
		Y	6.56	79.67	22.28		65.0	
		Z	7.36	80.26	22.78		65.0	
10256-CAA	LTE-TDD (SC-FDMA, 100% RB, 1.4 MHz, 16-QAM)	X	3.47	66.81	11.87	3.98	65.0	± 9.6 %
		Y	3.04	66.62	11.79		65.0	
		Z	6.17	75.99	17.91		65.0	
10257-CAA	LTE-TDD (SC-FDMA, 100% RB, 1.4 MHz, 64-QAM)	X	3.37	66.19	11.46	3.98	65.0	± 9.6 %
		Y	2.93	65.89	11.33		65.0	
		Z	5.77	74.61	17.24		65.0	
10258-CAA	LTE-TDD (SC-FDMA, 100% RB, 1.4 MHz, QPSK)	X	3.12	67.75	12.57	3.98	65.0	± 9.6 %
		Y	2.96	69.29	13.75		65.0	
		Z	5.78	78.31	19.00		65.0	
10259-CAB	LTE-TDD (SC-FDMA, 100% RB, 3 MHz, 16-QAM)	X	5.62	74.26	18.01	3.98	65.0	± 9.6 %
		Y	5.11	74.93	18.90		65.0	
		Z	6.25	77.33	20.80		65.0	
10260-CAB	LTE-TDD (SC-FDMA, 100% RB, 3 MHz, 64-QAM)	X	5.61	73.92	17.87	3.98	65.0	± 9.6 %
		Y	5.08	74.47	18.69		65.0	
		Z	6.22	76.89	20.63		65.0	
10261-CAB	LTE-TDD (SC-FDMA, 100% RB, 3 MHz, QPSK)	X	7.28	80.77	20.74	3.98	65.0	± 9.6 %
		Y	7.30	83.82	22.63		65.0	
		Z	8.86	86.10	24.16		65.0	
10262-CAD	LTE-TDD (SC-FDMA, 100% RB, 5 MHz, 16-QAM)	X	6.69	77.48	20.72	3.98	65.0	± 9.6 %
		Y	5.81	77.19	21.23		65.0	
		Z	6.74	78.66	22.39		65.0	
10263-CAD	LTE-TDD (SC-FDMA, 100% RB, 5 MHz, 64-QAM)	X	6.06	74.66	19.20	3.98	65.0	± 9.6 %
		Y	5.30	74.31	19.62		65.0	
		Z	6.20	75.76	20.83		65.0	
10264-CAD	LTE-TDD (SC-FDMA, 100% RB, 5 MHz, QPSK)	X	8.21	82.79	22.34	3.98	65.0	± 9.6 %
		Y	7.69	84.56	23.74		65.0	
		Z	8.91	85.73	24.55		65.0	
10265-CAD	LTE-TDD (SC-FDMA, 100% RB, 10 MHz, 16-QAM)	X	6.37	74.81	19.95	3.98	65.0	± 9.6 %
		Y	5.51	74.00	20.10		65.0	
		Z	6.30	75.12	20.91		65.0	
10266-CAD	LTE-TDD (SC-FDMA, 100% RB, 10 MHz, 64-QAM)	X	6.91	76.20	20.91	3.98	65.0	± 9.6 %
		Y	5.95	75.22	21.00		65.0	
		Z	6.72	76.20	21.75		65.0	
10267-CAD	LTE-TDD (SC-FDMA, 100% RB, 10 MHz, QPSK)	X	7.73	80.01	21.65	3.98	65.0	± 9.6 %
		Y	6.95	80.46	22.42		65.0	
		Z	7.83	81.11	22.87		65.0	
10268-CAD	LTE-TDD (SC-FDMA, 100% RB, 15 MHz, 16-QAM)	X	7.04	74.93	20.57	3.98	65.0	± 9.6 %
		Y	6.11	73.80	20.50		65.0	
		Z	6.83	74.68	21.12		65.0	
10269-CAD	LTE-TDD (SC-FDMA, 100% RB, 15 MHz, 64-QAM)	X	7.02	74.54	20.46	3.98	65.0	± 9.6 %
		Y	6.09	73.37	20.35		65.0	
		Z	6.77	74.17	20.96		65.0	
10270-CAD	LTE-TDD (SC-FDMA, 100% RB, 15 MHz, QPSK)	X	7.32	77.11	20.80	3.98	65.0	± 9.6 %
		Y	6.46	76.73	21.11		65.0	
		Z	7.16	77.26	21.50		65.0	

EX3DV4- SN:3825

December 11, 2017

10274-CAB	UMTS-FDD (HSUPA, Subtest 5, 3GPP Rel8.10)	X	2.49	66.77	14.97	0.00	150.0	± 9.6 %
		Y	2.61	68.24	15.86		150.0	
		Z	2.55	66.70	15.41		150.0	
10275-CAB	UMTS-FDD (HSUPA, Subtest 5, 3GPP Rel8.4)	X	1.52	67.76	15.28	0.00	150.0	± 9.6 %
		Y	1.84	72.03	17.52		150.0	
		Z	1.63	68.94	16.02		150.0	
10277-CAA	PHS (QPSK)	X	2.06	60.64	6.08	9.03	50.0	± 9.6 %
		Y	1.86	60.49	5.93		50.0	
		Z	2.56	62.63	8.30		50.0	
10278-CAA	PHS (QPSK, BW 884MHz, Roll-off 0.5)	X	3.37	66.30	11.38	9.03	50.0	± 9.6 %
		Y	3.31	67.03	11.90		50.0	
		Z	6.41	76.53	17.71		50.0	
10279-CAA	PHS (QPSK, BW 884MHz, Roll-off 0.36)	X	3.44	66.51	11.54	9.03	50.0	± 9.6 %
		Y	3.40	67.29	12.08		50.0	
		Z	6.58	76.83	17.88		50.0	
10290-AAB	CDMA2000, RC1, SO55, Full Rate	X	1.05	66.09	11.55	0.00	150.0	± 9.6 %
		Y	1.74	72.77	14.50		150.0	
		Z	1.49	69.53	14.00		150.0	
10291-AAB	CDMA2000, RC3, SO55, Full Rate	X	0.67	64.36	10.58	0.00	150.0	± 9.6 %
		Y	1.01	70.24	13.30		150.0	
		Z	0.78	66.16	12.12		150.0	
10292-AAB	CDMA2000, RC3, SO32, Full Rate	X	0.95	69.38	13.38	0.00	150.0	± 9.6 %
		Y	65.32	120.46	27.90		150.0	
		Z	1.29	73.38	15.73		150.0	
10293-AAB	CDMA2000, RC3, SO3, Full Rate	X	2.48	81.52	18.51	0.00	150.0	± 9.6 %
		Y	100.00	131.45	31.63		150.0	
		Z	5.14	92.37	22.78		150.0	
10295-AAB	CDMA2000, RC1, SO3, 1/8th Rate 25 fr.	X	12.35	86.49	22.43	9.03	50.0	± 9.6 %
		Y	13.59	89.59	23.89		50.0	
		Z	11.93	89.18	25.45		50.0	
10297-AAC	LTE-FDD (SC-FDMA, 50% RB, 20 MHz, QPSK)	X	2.56	69.34	16.50	0.00	150.0	± 9.6 %
		Y	2.86	72.02	17.88		150.0	
		Z	2.80	70.42	16.97		150.0	
10298-AAC	LTE-FDD (SC-FDMA, 50% RB, 3 MHz, QPSK)	X	1.21	65.56	12.00	0.00	150.0	± 9.6 %
		Y	1.59	69.92	14.19		150.0	
		Z	1.58	68.45	14.30		150.0	
10299-AAC	LTE-FDD (SC-FDMA, 50% RB, 3 MHz, 16-QAM)	X	2.03	67.72	12.54	0.00	150.0	± 9.6 %
		Y	2.34	68.86	12.46		150.0	
		Z	3.41	73.38	16.16		150.0	
10300-AAC	LTE-FDD (SC-FDMA, 50% RB, 3 MHz, 64-QAM)	X	1.40	62.83	9.29	0.00	150.0	± 9.6 %
		Y	1.45	63.04	8.91		150.0	
		Z	2.12	66.15	12.13		150.0	
10301-AAA	IEEE 802.16e WiMAX (29:18, 5ms, 10MHz, QPSK, PUSC)	X	4.48	65.47	17.19	4.17	50.0	± 9.6 %
		Y	4.60	66.35	17.70		50.0	
		Z	4.95	66.29	17.90		50.0	
10302-AAA	IEEE 802.16e WiMAX (29:18, 5ms, 10MHz, QPSK, PUSC, 3 CTRL symbols)	X	4.96	66.05	17.89	4.96	50.0	± 9.6 %
		Y	4.99	66.55	18.19		50.0	
		Z	5.36	66.50	18.37		50.0	

EX3DV4-- SN:3825

December 11, 2017

10303-AAA	IEEE 802.16e WiMAX (31:15, 5ms, 10MHz, 64QAM, PUSC)	X	4.74	65.76	17.71	4.96	50.0	± 9.6 %	
		Y	4.76	66.23	18.01			50.0	
		Z	5.12	66.22	18.24			50.0	
10304-AAA	IEEE 802.16e WiMAX (29:18, 5ms, 10MHz, 64QAM, PUSC)	X	4.56	65.72	17.27	4.17	50.0	± 9.6 %	
		Y	4.58	66.19	17.57			50.0	
		Z	4.90	66.01	17.70			50.0	
10305-AAA	IEEE 802.16e WiMAX (31:15, 10ms, 10MHz, 64QAM, PUSC, 15 symbols)	X	4.28	67.86	19.00	6.02	35.0	± 9.6 %	
		Y	4.38	68.88	19.65			35.0	
		Z	5.00	70.17	20.83			35.0	
10306-AAA	IEEE 802.16e WiMAX (29:18, 10ms, 10MHz, 64QAM, PUSC, 18 symbols)	X	4.53	66.70	18.70	6.02	35.0	± 9.6 %	
		Y	4.59	67.45	19.20			35.0	
		Z	5.08	68.16	19.99			35.0	
10307-AAA	IEEE 802.16e WiMAX (29:18, 10ms, 10MHz, QPSK, PUSC, 18 symbols)	X	4.43	66.81	18.64	6.02	35.0	± 9.6 %	
		Y	4.49	67.59	19.14			35.0	
		Z	5.03	68.55	20.05			35.0	
10308-AAA	IEEE 802.16e WiMAX (29:18, 10ms, 10MHz, 16QAM, PUSC)	X	4.42	67.04	18.80	6.02	35.0	± 9.6 %	
		Y	4.48	67.87	19.33			35.0	
		Z	5.03	68.85	20.23			35.0	
10309-AAA	IEEE 802.16e WiMAX (29:18, 10ms, 10MHz, 16QAM, AMC 2x3, 18 symbols)	X	4.54	66.76	18.79	6.02	35.0	± 9.6 %	
		Y	4.61	67.55	19.29			35.0	
		Z	5.15	68.41	20.15			35.0	
10310-AAA	IEEE 802.16e WiMAX (29:18, 10ms, 10MHz, QPSK, AMC 2x3, 18 symbols)	X	4.49	66.79	18.71	6.02	35.0	± 9.6 %	
		Y	4.55	67.56	19.20			35.0	
		Z	5.05	68.32	20.00			35.0	
10311-AAC	LTE-FDD (SC-FDMA, 100% RB, 15 MHz, QPSK)	X	2.92	68.61	16.17	0.00	150.0	± 9.6 %	
		Y	3.24	70.99	17.38			150.0	
		Z	3.17	69.58	16.58			150.0	
10313-AAA	iDEN 1:3	X	4.59	73.82	15.80	6.99	70.0	± 9.6 %	
		Y	4.13	75.72	16.91			70.0	
		Z	5.23	77.37	17.72			70.0	
10314-AAA	iDEN 1:6	X	7.62	84.85	22.68	10.00	30.0	± 9.6 %	
		Y	9.61	90.91	24.97			30.0	
		Z	13.02	94.42	26.23			30.0	
10315-AAB	IEEE 802.11b WiFi 2.4 GHz (DSSS, 1 Mbps, 96pc duty cycle)	X	1.10	63.98	15.10	0.17	150.0	± 9.6 %	
		Y	1.09	65.61	16.49			150.0	
		Z	1.04	64.41	15.75			150.0	
10316-AAB	IEEE 802.11g WiFi 2.4 GHz (ERP-OFDM, 6 Mbps, 96pc duty cycle)	X	4.41	66.71	16.17	0.17	150.0	± 9.6 %	
		Y	4.41	67.13	16.46			150.0	
		Z	4.55	66.70	16.43			150.0	
10317-AAC	IEEE 802.11a WiFi 5 GHz (OFDM, 6 Mbps, 96pc duty cycle)	X	4.41	66.71	16.17	0.17	150.0	± 9.6 %	
		Y	4.41	67.13	16.46			150.0	
		Z	4.55	66.70	16.43			150.0	
10400-AAD	IEEE 802.11ac WiFi (20MHz, 64-QAM, 99pc duty cycle)	X	4.47	66.99	16.20	0.00	150.0	± 9.6 %	
		Y	4.49	67.45	16.48			150.0	
		Z	4.65	66.97	16.36			150.0	
10401-AAD	IEEE 802.11ac WiFi (40MHz, 64-QAM, 99pc duty cycle)	X	5.14	66.82	16.23	0.00	150.0	± 9.6 %	
		Y	5.12	67.13	16.41			150.0	
		Z	5.38	67.20	16.55			150.0	

EX3DV4- SN:3825

December 11, 2017

10402-AAD	IEEE 802.11ac WiFi (80MHz, 64-QAM, 99pc duty cycle)	X	5.48	67.39	16.41	0.00	150.0	± 9.6 %
		Y	5.47	67.71	16.58		150.0	
		Z	5.61	67.43	16.52		150.0	
10403-AAB	CDMA2000 (1xEV-DO, Rev. 0)	X	1.05	66.09	11.55	0.00	115.0	± 9.6 %
		Y	1.74	72.77	14.50		115.0	
		Z	1.49	69.53	14.00		115.0	
10404-AAB	CDMA2000 (1xEV-DO, Rev. A)	X	1.05	66.09	11.55	0.00	115.0	± 9.6 %
		Y	1.74	72.77	14.50		115.0	
		Z	1.49	69.53	14.00		115.0	
10406-AAB	CDMA2000, RC3, SO32, SCH0, Full Rate	X	100.00	127.33	32.34	0.00	100.0	± 9.6 %
		Y	100.00	114.16	26.24		100.0	
		Z	100.00	124.91	32.13		100.0	
10410-AAD	LTE-TDD (SC-FDMA, 1 RB, 10 MHz, QPSK, UL Subframe=2,3,4,7,8,9, Subframe Conf=4)	X	100.00	122.78	30.48	3.23	80.0	± 9.6 %
		Y	100.00	122.23	29.63		80.0	
		Z	100.00	125.19	32.04		80.0	
10415-AAA	IEEE 802.11b WiFi 2.4 GHz (DSSS, 1 Mbps, 99pc duty cycle)	X	1.01	63.02	14.54	0.00	150.0	± 9.6 %
		Y	1.02	64.74	15.95		150.0	
		Z	0.94	63.27	14.99		150.0	
10416-AAA	IEEE 802.11g WiFi 2.4 GHz (ERP-OFDM, 6 Mbps, 99pc duty cycle)	X	4.37	66.76	16.18	0.00	150.0	± 9.6 %
		Y	4.37	67.19	16.45		150.0	
		Z	4.49	66.64	16.31		150.0	
10417-AAB	IEEE 802.11a/n WiFi 5 GHz (OFDM, 6 Mbps, 99pc duty cycle)	X	4.37	66.76	16.18	0.00	150.0	± 9.6 %
		Y	4.37	67.19	16.45		150.0	
		Z	4.49	66.64	16.31		150.0	
10418-AAA	IEEE 802.11g WiFi 2.4 GHz (DSSS-OFDM, 6 Mbps, 99pc duty cycle, Long preamble)	X	4.36	66.96	16.23	0.00	150.0	± 9.6 %
		Y	4.38	67.42	16.52		150.0	
		Z	4.48	66.81	16.34		150.0	
10419-AAA	IEEE 802.11g WiFi 2.4 GHz (DSSS-OFDM, 6 Mbps, 99pc duty cycle, Short preamble)	X	4.38	66.89	16.22	0.00	150.0	± 9.6 %
		Y	4.39	67.34	16.50		150.0	
		Z	4.50	66.75	16.34		150.0	
10422-AAB	IEEE 802.11n (HT Greenfield, 7.2 Mbps, BPSK)	X	4.48	66.87	16.23	0.00	150.0	± 9.6 %
		Y	4.49	67.29	16.49		150.0	
		Z	4.62	66.74	16.35		150.0	
10423-AAB	IEEE 802.11n (HT Greenfield, 43.3 Mbps, 16-QAM)	X	4.61	67.13	16.31	0.00	150.0	± 9.6 %
		Y	4.62	67.56	16.58		150.0	
		Z	4.79	67.07	16.46		150.0	
10424-AAB	IEEE 802.11n (HT Greenfield, 72.2 Mbps, 64-QAM)	X	4.54	67.08	16.29	0.00	150.0	± 9.6 %
		Y	4.55	67.52	16.56		150.0	
		Z	4.71	67.02	16.44		150.0	
10425-AAB	IEEE 802.11n (HT Greenfield, 15 Mbps, BPSK)	X	5.17	67.27	16.48	0.00	150.0	± 9.6 %
		Y	5.15	67.58	16.65		150.0	
		Z	5.32	67.36	16.63		150.0	
10426-AAB	IEEE 802.11n (HT Greenfield, 90 Mbps, 16-QAM)	X	5.18	67.35	16.51	0.00	150.0	± 9.6 %
		Y	5.16	67.64	16.68		150.0	
		Z	5.34	67.40	16.65		150.0	

EX3DV4- SN:3825

December 11, 2017

10427-AAB	IEEE 802.11n (HT Greenfield, 150 Mbps, 64-QAM)	X	5.15	67.15	16.41	0.00	150.0	± 9.6 %
		Y	5.13	67.47	16.59		150.0	
		Z	5.34	67.35	16.62		150.0	
10430-AAB	LTE-FDD (OFDMA, 5 MHz, E-TM 3.1)	X	4.35	72.72	18.62	0.00	150.0	± 9.6 %
		Y	4.61	74.25	19.42		150.0	
		Z	4.38	71.78	18.76		150.0	
10431-AAB	LTE-FDD (OFDMA, 10 MHz, E-TM 3.1)	X	3.98	67.33	16.05	0.00	150.0	± 9.6 %
		Y	4.03	67.98	16.46		150.0	
		Z	4.18	67.26	16.33		150.0	
10432-AAB	LTE-FDD (OFDMA, 15 MHz, E-TM 3.1)	X	4.30	67.17	16.22	0.00	150.0	± 9.6 %
		Y	4.33	67.69	16.54		150.0	
		Z	4.47	67.09	16.39		150.0	
10433-AAB	LTE-FDD (OFDMA, 20 MHz, E-TM 3.1)	X	4.56	67.11	16.31	0.00	150.0	± 9.6 %
		Y	4.57	67.55	16.58		150.0	
		Z	4.72	67.05	16.46		150.0	
10434-AAA	W-CDMA (BS Test Model 1, 64 DPCH)	X	4.50	73.72	18.47	0.00	150.0	± 9.6 %
		Y	4.96	75.87	19.53		150.0	
		Z	4.56	72.86	18.80		150.0	
10435-AAC	LTE-TDD (SC-FDMA, 1 RB, 20 MHz, QPSK, UL Subframe=2,3,4,7,8,9)	X	100.00	122.46	30.33	3.23	80.0	± 9.6 %
		Y	100.00	121.90	29.47		80.0	
		Z	100.00	124.96	31.94		80.0	
10447-AAB	LTE-FDD (OFDMA, 5 MHz, E-TM 3.1, Clipping 44%)	X	3.22	67.14	14.94	0.00	150.0	± 9.6 %
		Y	3.34	68.22	15.61		150.0	
		Z	3.48	67.34	15.65		150.0	
10448-AAB	LTE-FDD (OFDMA, 10 MHz, E-TM 3.1, Clipping 44%)	X	3.85	67.13	15.93	0.00	150.0	± 9.6 %
		Y	3.90	67.79	16.36		150.0	
		Z	4.02	67.04	16.19		150.0	
10449-AAB	LTE-FDD (OFDMA, 15 MHz, E-TM 3.1, Clipping 44%)	X	4.14	67.01	16.12	0.00	150.0	± 9.6 %
		Y	4.17	67.54	16.46		150.0	
		Z	4.29	66.92	16.29		150.0	
10450-AAB	LTE-FDD (OFDMA, 20 MHz, E-TM 3.1, Clipping 44%)	X	4.36	66.89	16.17	0.00	150.0	± 9.6 %
		Y	4.37	67.36	16.46		150.0	
		Z	4.48	66.82	16.31		150.0	
10451-AAA	W-CDMA (BS Test Model 1, 64 DPCH, Clipping 44%)	X	3.02	66.91	14.21	0.00	150.0	± 9.6 %
		Y	3.18	68.16	14.96		150.0	
		Z	3.37	67.51	15.24		150.0	
10456-AAB	IEEE 802.11ac WiFi (160MHz, 64-QAM, 99pc duty cycle)	X	6.08	67.78	16.62	0.00	150.0	± 9.6 %
		Y	6.04	68.03	16.75		150.0	
		Z	6.19	67.86	16.75		150.0	
10457-AAA	UMTS-FDD (DC-HSDPA)	X	3.72	65.51	15.90	0.00	150.0	± 9.6 %
		Y	3.71	65.90	16.19		150.0	
		Z	3.73	65.26	16.03		150.0	
10458-AAA	CDMA2000 (1xEV-DO, Rev. B, 2 carriers)	X	3.82	71.59	16.94	0.00	150.0	± 9.6 %
		Y	4.32	74.08	18.22		150.0	
		Z	4.13	71.88	18.05		150.0	
10459-AAA	CDMA2000 (1xEV-DO, Rev. B, 3 carriers)	X	4.99	69.64	18.18	0.00	150.0	± 9.6 %
		Y	5.05	70.14	18.52		150.0	
		Z	5.18	69.05	18.62		150.0	

EX3DV4-SN:3825

December 11, 2017

10460-AAA	UMTS-FDD (WCDMA, AMR)	X	0.86	67.81	15.81	0.00	150.0	± 9.6 %
		Y	1.34	77.64	20.75		150.0	
		Z	0.95	71.02	17.37		150.0	
10461-AAA	LTE-TDD (SC-FDMA, 1 RB, 1.4 MHz, QPSK, UL Subframe=2,3,4,7,8,9)	X	100.00	126.82	32.41	3.29	80.0	± 9.6 %
		Y	100.00	130.32	33.28		80.0	
		Z	100.00	131.06	34.77		80.0	
10462-AAA	LTE-TDD (SC-FDMA, 1 RB, 1.4 MHz, 16-QAM, UL Subframe=2,3,4,7,8,9)	X	1.65	66.03	11.24	3.23	80.0	± 9.6 %
		Y	0.89	61.42	8.07		80.0	
		Z	100.00	109.95	25.01		80.0	
10463-AAA	LTE-TDD (SC-FDMA, 1 RB, 1.4 MHz, 64-QAM, UL Subframe=2,3,4,7,8,9)	X	1.00	61.04	8.41	3.23	80.0	± 9.6 %
		Y	0.77	60.00	6.74		80.0	
		Z	100.00	105.60	22.97		80.0	
10464-AAA	LTE-TDD (SC-FDMA, 1 RB, 3 MHz, QPSK, UL Subframe=2,3,4,7,8,9)	X	100.00	123.81	30.86	3.23	80.0	± 9.6 %
		Y	100.00	126.41	31.32		80.0	
		Z	100.00	128.52	33.41		80.0	
10465-AAA	LTE-TDD (SC-FDMA, 1 RB, 3 MHz, 16-QAM, UL Subframe=2,3,4,7,8,9)	X	1.43	64.63	10.58	3.23	80.0	± 9.6 %
		Y	0.81	60.63	7.62		80.0	
		Z	100.00	109.21	24.66		80.0	
10466-AAA	LTE-TDD (SC-FDMA, 1 RB, 3 MHz, 64-QAM, UL Subframe=2,3,4,7,8,9)	X	0.96	60.58	8.14	3.23	80.0	± 9.6 %
		Y	0.78	60.00	6.69		80.0	
		Z	50.04	98.24	21.20		80.0	
10467-AAC	LTE-TDD (SC-FDMA, 1 RB, 5 MHz, QPSK, UL Subframe=2,3,4,7,8,9)	X	100.00	124.19	31.03	3.23	80.0	± 9.6 %
		Y	100.00	126.89	31.53		80.0	
		Z	100.00	128.85	33.56		80.0	
10468-AAC	LTE-TDD (SC-FDMA, 1 RB, 5 MHz, 16-QAM, UL Subframe=2,3,4,7,8,9)	X	1.49	65.03	10.78	3.23	80.0	± 9.6 %
		Y	0.83	60.87	7.76		80.0	
		Z	100.00	109.44	24.76		80.0	
10469-AAC	LTE-TDD (SC-FDMA, 1 RB, 5 MHz, 64-QAM, UL Subframe=2,3,4,7,8,9)	X	0.96	60.61	8.16	3.23	80.0	± 9.6 %
		Y	0.77	60.00	6.69		80.0	
		Z	55.55	99.27	21.43		80.0	
10470-AAC	LTE-TDD (SC-FDMA, 1 RB, 10 MHz, QPSK, UL Subframe=2,3,4,7,8,9)	X	100.00	124.21	31.03	3.23	80.0	± 9.6 %
		Y	100.00	126.92	31.53		80.0	
		Z	100.00	128.89	33.57		80.0	
10471-AAC	LTE-TDD (SC-FDMA, 1 RB, 10 MHz, 16-QAM, UL Subframe=2,3,4,7,8,9)	X	1.48	64.96	10.74	3.23	80.0	± 9.6 %
		Y	0.82	60.79	7.71		80.0	
		Z	100.00	109.37	24.73		80.0	
10472-AAC	LTE-TDD (SC-FDMA, 1 RB, 10 MHz, 64-QAM, UL Subframe=2,3,4,7,8,9)	X	0.95	60.58	8.13	3.23	80.0	± 9.6 %
		Y	0.77	60.00	6.67		80.0	
		Z	52.27	98.61	21.26		80.0	
10473-AAC	LTE-TDD (SC-FDMA, 1 RB, 15 MHz, QPSK, UL Subframe=2,3,4,7,8,9)	X	100.00	124.17	31.01	3.23	80.0	± 9.6 %
		Y	100.00	126.88	31.51		80.0	
		Z	100.00	128.85	33.55		80.0	
10474-AAC	LTE-TDD (SC-FDMA, 1 RB, 15 MHz, 16-QAM, UL Subframe=2,3,4,7,8,9)	X	1.47	64.93	10.72	3.23	80.0	± 9.6 %
		Y	0.82	60.76	7.69		80.0	
		Z	100.00	109.38	24.73		80.0	
10475-AAC	LTE-TDD (SC-FDMA, 1 RB, 15 MHz, 64-QAM, UL Subframe=2,3,4,7,8,9)	X	0.95	60.56	8.12	3.23	80.0	± 9.6 %
		Y	0.77	60.00	6.67		80.0	
		Z	49.09	98.02	21.12		80.0	