



# RADIO TEST REPORT

**Test Report No. : 12717687H-A-R1**

**Applicant** : **Murata Manufacturing Co., Ltd.**  
**Type of Equipment** : **Communication Module**  
**Model No.** : **Type1KS**  
**FCC ID** : **VPYLB1KS**  
**Test regulation** : **FCC Part 15 Subpart C: 2018**  
**Test Result** : **Complied (Refer to SECTION 3.2)**

1. This test report shall not be reproduced in full or partial, without the written approval of UL Japan, Inc.
2. The results in this report apply only to the sample tested.
3. This sample tested is in compliance with the above regulation.
4. The test results in this report are traceable to the national or international standards.
5. This test report covers Radio technical requirements. It does not cover administrative issues such as Manual or non-Radio test related Requirements. (if applicable)
6. The all test items in this test report are conducted by UL Japan, Inc. Ise EMC Lab.
7. This test report must not be used by the customer to claim product certification, approval, or endorsement by NVLAP, NIST, or any agency of the Federal Government.
8. The information provided from the customer for this report is identified in SECTION 1.
9. This report is a revised version of 12717687H-A. 12717687H-A is replaced with this report.

**Date of test:** February 4 to April 8, 2019

**Representative test engineer:**   
 Yuta Moriya  
 Engineer  
 Consumer Technology Division

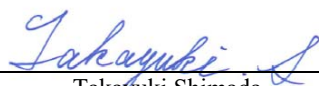
**Approved by:**   
 Takayuki Shimada  
 Leader  
 Consumer Technology Division



This laboratory is accredited by the NVLAP LAB CODE 200572-0, U.S.A. The tests reported herein have been performed in accordance with its terms of accreditation. \*As for the range of Accreditation in NVLAP, you may refer to the WEB address, [http://japan.ul.com/resources/emc\\_accredited/](http://japan.ul.com/resources/emc_accredited/)

- The testing in which "Non-accreditation" is displayed is outside the accreditation scopes in UL Japan.  
 There is no testing item of "Non-accreditation".

**UL Japan, Inc.**  
**Ise EMC Lab.**

4383-326 Asama-cho, Ise-shi, Mie-ken 516-0021 JAPAN  
 Telephone : +81 596 24 8999  
 Facsimile : +81 596 24 8124



---

<b>CONTENTS</b>	<b>PAGE</b>
<b>SECTION 1: Customer information.....</b>	<b>4</b>
<b>SECTION 2: Equipment under test (E.U.T.).....</b>	<b>4</b>
<b>SECTION 3: Test specification, procedures &amp; results.....</b>	<b>5</b>
<b>SECTION 4: Operation of E.U.T. during testing.....</b>	<b>9</b>
<b>SECTION 5: Conducted Emission.....</b>	<b>12</b>
<b>SECTION 6: Radiated Spurious Emission .....</b>	<b>13</b>
<b>SECTION 7: Antenna Terminal Conducted Tests.....</b>	<b>15</b>
<b>APPENDIX 1: Test data .....</b>	<b>16</b>
Conducted Emission .....	16
6 dB Bandwidth and 99 % Occupied Bandwidth.....	17
Maximum Peak Output Power .....	22
Average Output Power.....	25
Radiated Spurious Emission .....	28
Conducted Spurious Emission .....	50
Power Density .....	51
<b>APPENDIX 2: Test instruments .....</b>	<b>57</b>
<b>APPENDIX 3: Photographs of test setup .....</b>	<b>59</b>
Conducted Emission .....	59
Radiated Spurious Emission .....	60
Worst Case Position (Horizontal: Y-axis/ Vertical:Z-axis) .....	61

**SECTION 1: Customer information**

Company Name : Murata Manufacturing Co., Ltd.  
Address : 1-10-1 Higashikotari, Nagaokakyo-shi, Kyoto 617-8555 Japan  
Telephone Number : +81-75-955-6736  
Facsimile Number : +81-75-955-6634  
Contact Person : Motoo Hayashi

The information provided from the customer is as follows;

- Applicant, Type of Equipment, Model No., FCC ID on the cover and other relevant pages
- SECTION 1: Customer information
- SECTION 2: Equipment under test (E.U.T.)
- SECTION 4: Operation of E.U.T. during testing

\* The laboratory is exempted from liability of any test results affected from the above information in SECTION 2 and 4.

**SECTION 2: Equipment under test (E.U.T.)**

**2.1 Identification of E.U.T.**

Type of Equipment : Communication Module  
Model No. : Type1KS  
Serial No. : Refer to Section 4, Clause 4.2  
Rating : VBAT: Min 2.7 V / Typ. 3.3 V / Max. 3.6 V  
Receipt Date of Sample : February 4, 2019  
(Information from test lab.)  
Country of Mass-production : China  
Condition of EUT : Production prototype  
(Not for Sale: This sample is equivalent to mass-produced items.)  
Modification of EUT : No Modification by the test lab

**2.2 Product Description**

Model: Type1KS (referred to as the EUT in this report) is a Communication Module.

**Radio Specification**

**WLAN (IEEE802.11b/g/n-20)**

Type of radio	IEEE802.11b	IEEE802.11g/n (20 M band)
Radio Type	Transceiver	
Frequency of operation	2412 MHz - 2462 MHz	2412 MHz - 2462 MHz
Type of modulation	DSSS (CCK, DQPSK, DBPSK)	OFDM-CCK (64QAM, 16QAM, QPSK, BPSK)
Channel spacing	5 MHz	
Antenna type	Monopole Antenna	
Antenna Gain	0.5 dBi	

**Variant model**

This model has variant models: Type1KP, Type1KQ, Type1KR.

These models are identical in RF characteristics.

The tests were performed with Type1KS as a representative according to the customer's request.

**UL Japan, Inc.**

**Ise EMC Lab.**

4383-326 Asama-cho, Ise-shi, Mie-ken 516-0021 JAPAN

Telephone : +81 596 24 8999

Facsimile : +81 596 24 8124

### **SECTION 3: Test specification, procedures & results**

#### **3.1 Test Specification**

Test Specification : FCC Part 15 Subpart C  
FCC Part 15 final revised on March 12, 2018 and effective April 11, 2018

Title : FCC 47CFR Part15 Radio Frequency Device Subpart C Intentional Radiators  
Section 15.207 Conducted limits  
Section 15.247 Operation within the bands 902-928MHz,  
2400-2483.5MHz, and 5725-5850MHz

### 3.2 Procedures and results

Item	Test Procedure	Specification	Worst margin	Results	Remarks
Conducted Emission	FCC: ANSI C63.10-2013 6. Standard test methods	FCC: Section 15.207	QP 31.36 dB, 0.15000 MHz, L AV 26.56 dB, 19.38305 MHz, N	Complied a)	-
	IC: RSS-Gen 8.8	IC: RSS-Gen 8.8			
6dB Bandwidth	FCC: KDB 558074 D01 15.247 Meas Guidance v05r02	FCC: Section 15.247(a)(2)	See data.	Complied b)	Conducted
	IC: -	IC: RSS-247 5.2(a)			
Maximum Peak Output Power	FCC: KDB 558074 D01 15.247 Meas Guidance v05r02	FCC: Section 15.247(b)(3)		Complied c)	Conducted
	IC: RSS-Gen 6.12	IC: RSS-247 5.4(d)			
Power Density	FCC: KDB 558074 D01 15.247 Meas Guidance v05r02	FCC: Section 15.247(e)		Complied d)	Conducted
	IC: -	IC: RSS-247 5.2(b)			
Spurious Emission Restricted Band Edges	FCC: KDB 558074 D01 15.247 Meas Guidance v05r02	FCC: Section 15.247(d)	1.8 dB 2483.500 MHz, AV, Hori.	Complied# e), f)	Conducted (below 30 MHz)/ Radiated (above 30 MHz) *1)
	IC: RSS-Gen 6.13	IC: RSS-247 5.5 RSS-Gen 8.9 RSS-Gen 8.10			

Note: UL Japan, Inc.'s EMI Work Procedures No. 13-EM-W0420 and 13-EM-W0422.

\*1) Radiated test was selected over 30 MHz based on section 15.247(d) and KDB 558074 D01 15.247 Meas Guidance v05r02 8.5 and 8.6.

- a) Refer to APPENDIX 1 (data of Conducted Emission)
- b) Refer to APPENDIX 1 (data of 6 dB Bandwidth and 99 % Occupied Bandwidth)
- c) Refer to APPENDIX 1 (data of Maximum Peak Output Power)
- d) Refer to APPENDIX 1 (data of Power Density)
- e) Refer to APPENDIX 1 (data of Conducted Spurious Emission)
- f) Refer to APPENDIX 1 (data of Radiated Spurious Emission)

Symbols:

- Complied The data of this test item has enough margin, more than the measurement uncertainty.
- Complied# The data of this test item meets the limits unless the measurement uncertainty is taken into consideration.

\* In case any questions arise about test procedure, ANSI C63.10: 2013 is also referred.

#### **FCC Part 15.31 (e)**

This EUT provides stable voltage constantly to RF Module regardless of input voltage. Therefore, this EUT complies with the requirement.

#### **FCC Part 15.203 Antenna requirement**

The antenna is not removable from the EUT. Therefore, the equipment complies with the antenna requirement of Section 15.203.

### 3.3 Addition to standard

Item	Test Procedure	Specification	Worst margin	Results	Remarks
99% Occupied Bandwidth	RSS-Gen 6.7	IC: -	N/A	- a)	Conducted

a) Refer to APPENDIX 1 (data of 6 dB Bandwidth and 99 % Occupied Bandwidth)

Other than above, no addition, exclusion nor deviation has been made from the standard.

**UL Japan, Inc.**

**Ise EMC Lab.**

4383-326 Asama-cho, Ise-shi, Mie-ken 516-0021 JAPAN

Telephone : +81 596 24 8999

Facsimile : +81 596 24 8124

### 3.4 Uncertainty

#### EMI

There is no applicable rule of uncertainty in this applied standard. Therefore, the following results are derived depending on whether or not laboratory uncertainty is applied.

The following uncertainties have been calculated to provide a confidence level of 95 % using a coverage factor  $k=2$ .  
Ise EMC Lab.

#### Antenna Terminal test

Test Item	Uncertainty (+/-)
20 dB Bandwidth / 99 % Occupied Bandwidth	0.96 %
Maximum Peak Output Power / Average Output Power	1.3 dB
Carrier Frequency Separation	0.42 %
Dwell time / Burst rate	0.10 %
Conducted Spurious Emission	2.7 dB

#### Conducted emission

using Item	Frequency range	Uncertainty (+/-)
AMN (LISN)	0.009 MHz to 0.15 MHz	3.8 dB
	0.15 MHz to 30 MHz	3.4 dB

#### Radiated emission

Measurement distance	Frequency range	Uncertainty (+/-)
3 m	9 kHz to 30 MHz	3.3 dB
10 m		3.2 dB
3 m	30 MHz to 200 MHz (Horizontal) (Vertical)	4.8 dB
		5.0 dB
	200 MHz to 1000 MHz (Horizontal) (Vertical)	5.2 dB
		6.3 dB
10 m	30 MHz to 200 MHz (Horizontal) (Vertical)	4.8 dB
		4.9 dB
	200 MHz to 1000 MHz (Horizontal) (Vertical)	5.0 dB
		5.0 dB
3 m	1 GHz to 6 GHz	5.0 dB
	6 GHz to 18 GHz	5.3 dB
1 m	10 GHz to 26.5 GHz	5.8 dB
	26.5 GHz to 40 GHz	5.8 dB
10 m	1 GHz to 18 GHz	5.2 dB

### 3.5 Test Location

UL Japan, Inc. Ise EMC Lab.

\*NVLAP Lab. code: 200572-0 / FCC Test Firm Registration Number: 199967 / ISED Lab Company Number: 2973C

4383-326 Asama-cho, Ise-shi, Mie-ken 516-0021 JAPAN

Telephone: +81 596 24 8999, Facsimile: +81 596 24 8124

Test site	Width x Depth x Height (m)	Size of reference ground plane (m) / horizontal conducting plane	Other rooms	Maximum measurement distance
No.1 semi-anechoic chamber	19.2 x 11.2 x 7.7	7.0 x 6.0	No.1 Power source room	10 m
No.2 semi-anechoic chamber	7.5 x 5.8 x 5.2	4.0 x 4.0	-	3 m
No.3 semi-anechoic chamber	12.0 x 8.5 x 5.9	6.8 x 5.75	No.3 Preparation room	3 m
No.3 shielded room	4.0 x 6.0 x 2.7	N/A	-	-
No.4 semi-anechoic chamber	12.0 x 8.5 x 5.9	6.8 x 5.75	No.4 Preparation room	3 m
No.4 shielded room	4.0 x 6.0 x 2.7	N/A	-	-
No.5 semi-anechoic chamber	6.0 x 6.0 x 3.9	6.0 x 6.0	-	-
No.5 measurement room	6.4 x 6.4 x 3.0	6.4 x 6.4	-	-
No.6 shielded room	4.0 x 4.5 x 2.7	4.0 x 4.5	-	-
No.6 measurement room	4.75 x 5.4 x 3.0	4.75 x 4.15	-	-
No.7 shielded room	4.7 x 7.5 x 2.7	4.7 x 7.5	-	-
No.8 measurement room	3.1 x 5.0 x 2.7	3.1 x 5.0	-	-
No.9 measurement room	8.8 x 4.6 x 2.8	2.4 x 2.4	-	-
No.11 measurement room	6.2 x 4.7 x 3.0	4.8 x 4.6	-	-

\* Size of vertical conducting plane (for Conducted Emission test) : 2.0 x 2.0 m for No.1, No.2, No.3, and No.4 semi-anechoic chambers and No.3 and No.4 shielded rooms.

### 3.6 Test data, Test instruments, and Test set up

Refer to APPENDIX.



## **SECTION 4: Operation of E.U.T. during testing**

### **4.1 Operating Mode(s)**

Test operating mode was determined as follows according to “Section 1 of 6 802.11 a/b/g/n testing - Managing Complex Regulatory Approvals - ” of TCB Council Workshop October 2009.

<b>Mode</b>	<b>Remarks*</b>
IEEE 802.11b (11b)	2 Mbps, PN9
IEEE 802.11g (11g)	9 Mbps, PN9
IEEE 802.11n 20 MHz BW (11n-20)	MCS 1, PN9
*The worst condition was determined based on the test result of Maximum Peak Output Power (Mid Channel)	
*Power of the EUT was set by the software as follows; Power settings: 0 Software: CC3120_CC3220_RadioTool_1.0.2 *This setting of software is the worst case. Any conditions under the normal use do not exceed the condition of setting. In addition, end users cannot change the settings of the output power of the product.	

\*The details of Operating mode(s)

<b>Test Item</b>	<b>Operating Mode</b>	<b>Tested frequency</b>
Conducted Emission Radiated Spurious Emission (Below 1GHz) Spurious Emission (Conducted)	11g Tx *1)	2437 MHz
6dB Bandwidth, 99% Occupied Bandwidth	11b Tx 11g Tx 11n-20 Tx	2412 MHz 2437 MHz 2462 MHz
Maximum Peak Output Power, Power Density Radiated Spurious Emission (Above 1GHz)	11b Tx 11g Tx 11n-20 Tx	2412 MHz 2417 MHz 2437 MHz 2457 MHz 2462 MHz
*1) The test was performed on the mode as a representative, because it had the highest power at antenna terminal test.		

## 4.2 Configuration and peripherals

### All Test except for Antenna Terminal Conducted test

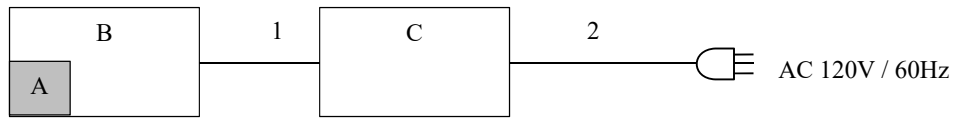

\* Cabling and setup(s) were taken into consideration and test data was taken under worse case conditions.

### Description of EUT and Support equipment

No.	Item	Model number	Serial number	Manufacturer	Remark
A	Communication Module	Type1KS	12	Murata Manufacturing Co., Ltd.	EUT
B	Jig board	-	-	Murata Manufacturing Co., Ltd.	*1)
C	Regulated DC Power Supply	PW16-2ATP	GJR810407	KIKUSUI	-

\*1) The test was performed with the module that as normal assumed implementation conditions.  
The use of a jig does not influence on the test result.

### List of cables used

No.	Name	Length (m)	Shield		Remark
			Cable	Connector	
1	DC Cable	1.5	Unshielded	Unshielded	
2	AC Cable	1.2	Unshielded	Unshielded	-

**For Antenna Terminal Conducted test**

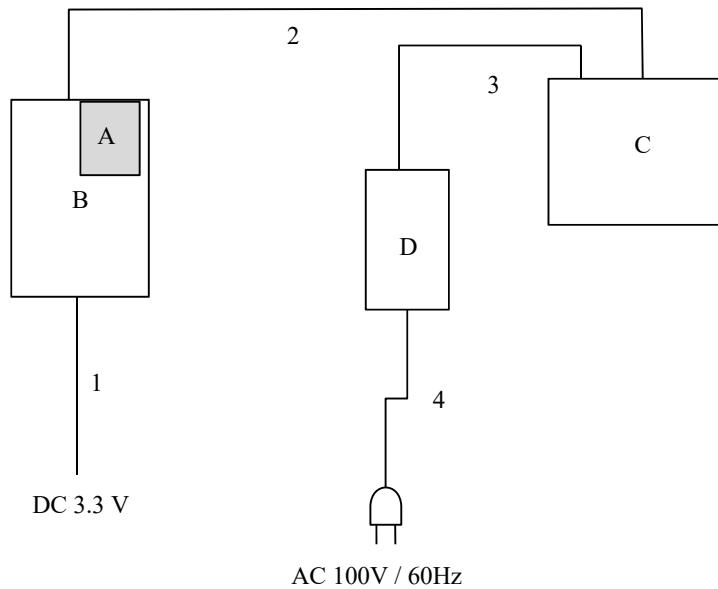

\* Cabling and setup(s) were taken into consideration and test data was taken under worse case conditions.

**Description of EUT and Support equipment**

No.	Item	Model number	Serial number	Manufacturer	Remark
A	Communication Module	Type1KS	5	Murata Manufacturing Co., Ltd.	EUT
B	Jig board	-	-	Murata Manufacturing Co., Ltd.	*1)
C	Laptop PC	CF-N8HWCDPS	0BKSA07449	Panasonic	-
D	AC Adapter	CF-AA6372B	6372BM409X17298B	Panasonic	-

\*1) The test was performed with the module that as normal assumed implementation conditions.  
The use of a jig does not influence on the test result.

**List of cables used**

No.	Name	Length (m)	Shield		Remark
			Cable	Connector	
1	DC Cable	0.9	Unshielded	Unshielded	
2	USB Cable	1.0	Shielded	Shielded	-
3	DC Cable	1.0	Unshielded	Unshielded	-
4	AC Cable	1.5	Unshielded	Unshielded	-

## **SECTION 5: Conducted Emission**

### **Test Procedure and conditions**

EUT was placed on a urethane platform of nominal size, 1.0 m by 1.5 m, raised 0.8 m above the conducting ground plane.

The rear of tabletop was located 40 cm to the vertical conducting plane. The rear of EUT, including peripherals aligned and flushed with rear of tabletop. All other surfaces of tabletop were at least 80cm from any other grounded conducting surface. EUT was located 80 cm from a Line Impedance Stabilization Network (LISN) / Artificial mains Network (AMN) and excess AC cable was bundled in center.

#### For the tests on EUT with other peripherals (as a whole system)

I/O cables that were connected to the peripherals were bundled in center. They were folded back and forth forming a bundle 30 cm to 40 cm long and were hanged at a 40 cm height to the ground plane. All unused 50ohm connectors of the LISN (AMN) were resistivity terminated in 50 ohm when not connected to the measuring equipment.

The AC Mains Terminal Continuous disturbance Voltage has been measured with the EUT in a Semi Anechoic Chamber. The EUT was connected to a LISN (AMN).

An overview sweep with peak detection has been performed.

The test results and limit are rounded off to one decimal place, so some differences might be observed.

**Detector** : QP and CISPR AV  
**Measurement range** : 0.15 MHz - 30 MHz  
**Test data** : APPENDIX  
**Test result** : Pass

**Figure 1: Test Setup**

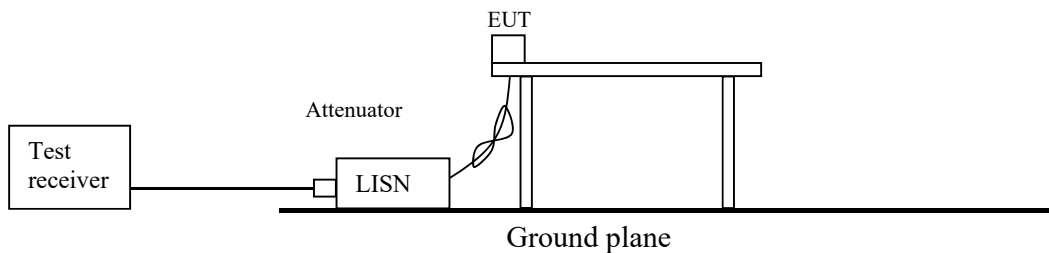

**SECTION 6: Radiated Spurious Emission**

**Test Procedure**

It was measured based on "8.5 and 8.6 of KDB 558074 D01 15.247 Meas Guidance v05r02".

[For below 1 GHz]

EUT was placed on a urethane platform of nominal size, 0.5 m by 1.0 m, raised 0.8 m above the conducting ground plane. The Radiated Electric Field Strength has been measured in a Semi Anechoic Chamber with a ground plane.

[For above 1 GHz]

EUT was placed on a urethane platform of nominal size, 0.5 m by 0.5 m, raised 1.5 m above the conducting ground plane.

The Radiated Electric Field Strength has been measured in a Semi Anechoic Chamber with absorbent materials lined on a ground plane.

The height of the measuring antenna varied between 1 and 4 m and EUT was rotated a full revolution in order to obtain the maximum value of the electric field strength.

The measurements were performed for both vertical and horizontal antenna polarization with the Test Receiver, or the Spectrum Analyzer.

The measurements were made with the following detector function of the test receiver and the Spectrum analyzer (in linear mode).

The test was made with the detector (RBW/VBW) in the following table.

When using Spectrum analyzer, the test was made with adjusting span to zero by using peak hold.

**Test Antennas are used as below;**

Frequency	30 MHz to 200 MHz	200 MHz to 1 GHz	Above 1 GHz
Antenna Type	Biconical	Logperiodic	Horn

In any 100 kHz bandwidth outside the restricted band in which the spread spectrum intentional radiator is operating, the radio frequency power that is produced by the intentional radiator confirmed 20 dB below that in the 100 kHz bandwidth within the band that contains the highest level of the desired power, based on a radiated measurement.

**20 dBc was applied to the frequency over the limit of FCC 15.209 / Table 4 of RSS-Gen 8.9(IC) and outside the restricted band of FCC15.205 / Table 6 of RSS-Gen 8.10 (IC).**

Frequency	Below 1 GHz	Above 1 GHz		20 dBc
Instrument used	Test Receiver	Spectrum Analyzer		Spectrum Analyzer
Detector	QP	PK	AV *1)	PK
IF Bandwidth	BW 120 kHz	RBW: 1 MHz VBW: 3 MHz	11.12.2.5.1 RBW: 1 MHz VBW: 3 MHz Detector: Power Averaging (RMS) Trace: 100 traces 11.12.2.5.2 The duty cycle was less than 98% for detected noise, a duty factor was added to the 11.12.2.5.1 results.	RBW: 100 kHz VBW: 300 kHz

\*1) Average Power Measurement was performed based on ANSI C63.10-2013.

**Figure 2: Test Setup**

Below 1 GHz

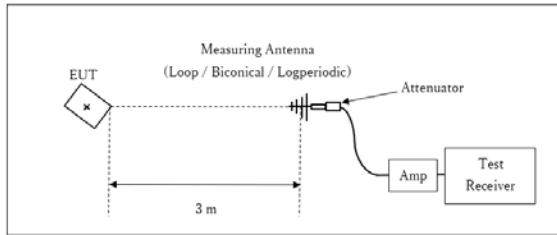

× : Center of turn table

Test Distance: 3 m

1 GHz - 10 GHz

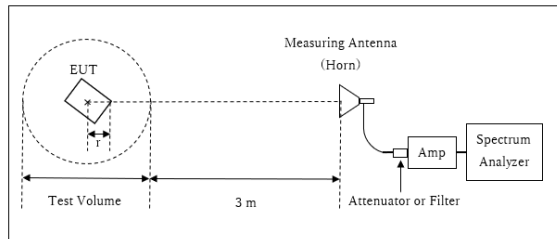

r : Radius of an outer periphery of EUT

× : Center of turn table

Distance Factor:  $20 \times \log(4.0 \text{ m} / 3.0 \text{ m}) = 2.5 \text{ dB}$

\* Test Distance:  $(3 + \text{Test Volume} / 2) - r = 4.0 \text{ m}$

Test Volume : 2.0 m

(Test Volume has been calibrated based on CISPR 16-1-4.)

r = 0.0 m

\* The test was performed with r = 0.0 m since EUT is small and it was the rather conservative condition.

10 GHz - 26.5 GHz

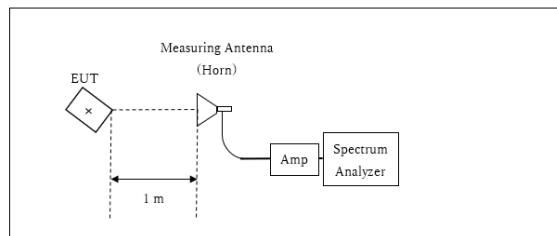

× : Center of turn table

Distance Factor:  $20 \times \log(1.0 \text{ m} / 3.0 \text{ m}) = -9.5 \text{ dB}$

\*Test Distance: 1 m

- The carrier level and noise levels were confirmed at each position of X, Y and Z axes of EUT to see the position of maximum noise, and the test was made at the position that has the maximum noise.

The test results and limit are rounded off to one decimal place, so some differences might be observed.

**Measurement range** : 30 MHz - 26.5 GHz  
**Test data** : APPENDIX  
**Test result** : Pass

## **SECTION 7: Antenna Terminal Conducted Tests**

### **Test Procedure**

The tests were made with below setting connected to the antenna port.

<b>Test</b>	<b>Span</b>	<b>RBW</b>	<b>VBW</b>	<b>Sweep time</b>	<b>Detector</b>	<b>Trace</b>	<b>Instrument used</b>
6dB Bandwidth	20 MHz	100 kHz	300 kHz	Auto	Peak	Max Hold	Spectrum Analyzer
99% Occupied Bandwidth *1)	Enough width to display emission skirts	1 to 5 % of OBW	Three times of RBW	Auto	Peak	Max Hold	Spectrum Analyzer
Maximum Peak Output Power	-	-	-	Auto	Peak/Average *2)	-	Power Meter (Sensor: 50 MHz BW)
Peak Power Density	1.5 times the 6dB Bandwidth	3 kHz	10 kHz	Auto	Peak	Max Hold	Spectrum Analyzer *3)
Conducted Spurious Emission *4)	9kHz to 150kHz	200 Hz	620 Hz	Auto	Peak	Max Hold	Spectrum Analyzer
	150kHz to 30MHz	9.1 kHz	27 kHz				

\*1) Peak hold was applied as Worst-case measurement.

\*2) Reference data

\*3) Section 11.10.2 Method PKPSD (peak PSD) of "ANSI C63.10-2013".

\*4) In the frequency range below 30MHz, RBW was narrowed to separate the noise contents.

Then, wide-band noise near the limit was checked separately, however the noise was low enough as shown in the chart.  
(9 kHz - 150 kHz: RBW = 200 Hz, 150 kHz - 30 MHz: RBW = 9.1 kHz).

The test results and limit are rounded off to two decimals place, so some differences might be observed.  
The equipment and cables were not used for factor 0 dB of the data sheets.

**Test data : APPENDIX**  
**Test result : Pass**

**APPENDIX 1: Test data**

**Conducted Emission**

Report No. 12717687H  
 Test place Ise EMC Lab. No.4 Semi Anechoic Chamber  
 Date April 8, 2019  
 Temperature / Humidity 20 deg. C / 40 % RH  
 Engineer Yuta Moriya  
 Mode Tx 11g 2437MHz

Limit : FCC\_Part 15 Subpart C(15.207)

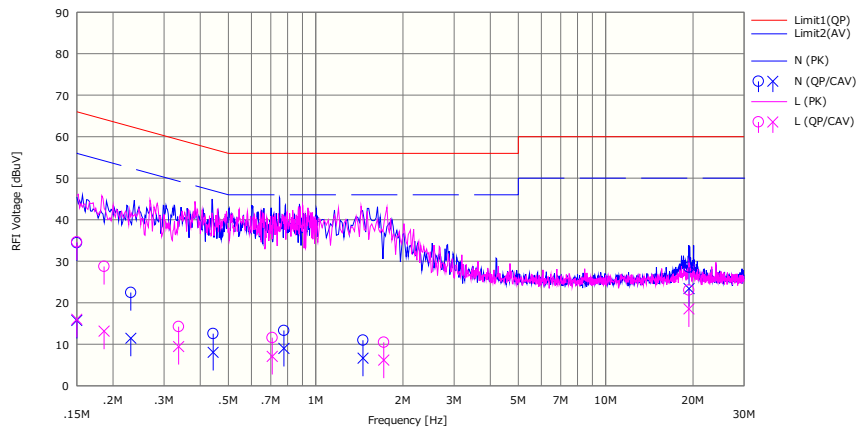

No.	Freq. [MHz]	Reading		LISN [dB]	LOSS [dB]	Results		Limit		Margin		Phase	Comment
		<GP> [dBuV]	<CAV> [dBuV]			<GP> [dBuV]	<CAV> [dBuV]	<GP> [dBuV]	<AV> [dBuV]	<GP> [dB]	<AV> [dB]		
1	0.15000	21.10	2.40	0.06	13.28	34.44	15.74	66.00	56.00	31.56	40.26	N	
2	0.23050	9.10	-1.90	0.06	13.29	22.45	11.45	62.40	52.40	39.95	40.95	N	
3	0.44280	-0.80	-5.30	0.06	13.31	12.57	8.07	57.00	47.00	44.43	38.93	N	
4	0.77704	-0.10	-4.40	0.07	13.34	13.31	9.01	56.00	46.00	42.69	36.99	N	
5	1.45607	-2.50	-6.80	0.08	13.39	10.97	6.67	56.00	46.00	45.03	39.33	N	
6	19.38305	14.20	9.10	0.35	13.99	28.54	23.44	60.00	50.00	31.46	26.56	N	
7	0.15000	21.30	2.70	0.06	13.28	34.64	16.04	66.00	56.00	31.36	39.96	L	
8	0.18640	15.40	-0.20	0.06	13.29	28.75	13.15	64.20	54.20	35.45	41.05	L	
9	0.33680	0.90	-3.90	0.05	13.30	14.25	9.45	59.30	49.30	45.05	39.85	L	
10	0.70820	-1.80	-6.30	0.06	13.33	11.59	7.09	56.00	46.00	44.41	38.91	L	
11	1.71752	-3.00	-7.30	0.08	13.41	10.49	6.19	56.00	46.00	45.51	39.81	L	
12	19.37240	8.70	4.20	0.35	13.99	23.04	18.54	60.00	50.00	36.96	31.46	L	

CHART: WITH FACTOR Peak hold data. CALCULATION : RESULT = READING + C.F (LISN + CABLE + ATT)  
 Except for the above table: adequate margin data below the limits.



### 6 dB Bandwidth and 99 % Occupied Bandwidth

Report No. 12717687H  
Test place Ise EMC Lab. No.6 Measurement Room  
Date February 5, 2019  
Temperature / Humidity 23 deg. C / 32 % RH  
Engineer Yuta Moriya  
Mode Tx

Mode	Frequency [MHz]	99% Occupied Bandwidth [kHz]	6dB Bandwidth [MHz]	Limit for 6dB Bandwidth [MHz]
11b	2412	14062.0	9.438	> 0.5000
	2437	14070.4	9.112	> 0.5000
	2462	14089.6	9.584	> 0.5000
11g	2412	17204.1	15.084	> 0.5000
	2437	18538.1	15.074	> 0.5000
	2462	17157.8	15.106	> 0.5000
11n-20	2412	18178.7	15.076	> 0.5000
	2437	18460.5	15.116	> 0.5000
	2462	18173.3	15.081	> 0.5000

**99 % Occupied Bandwidth**

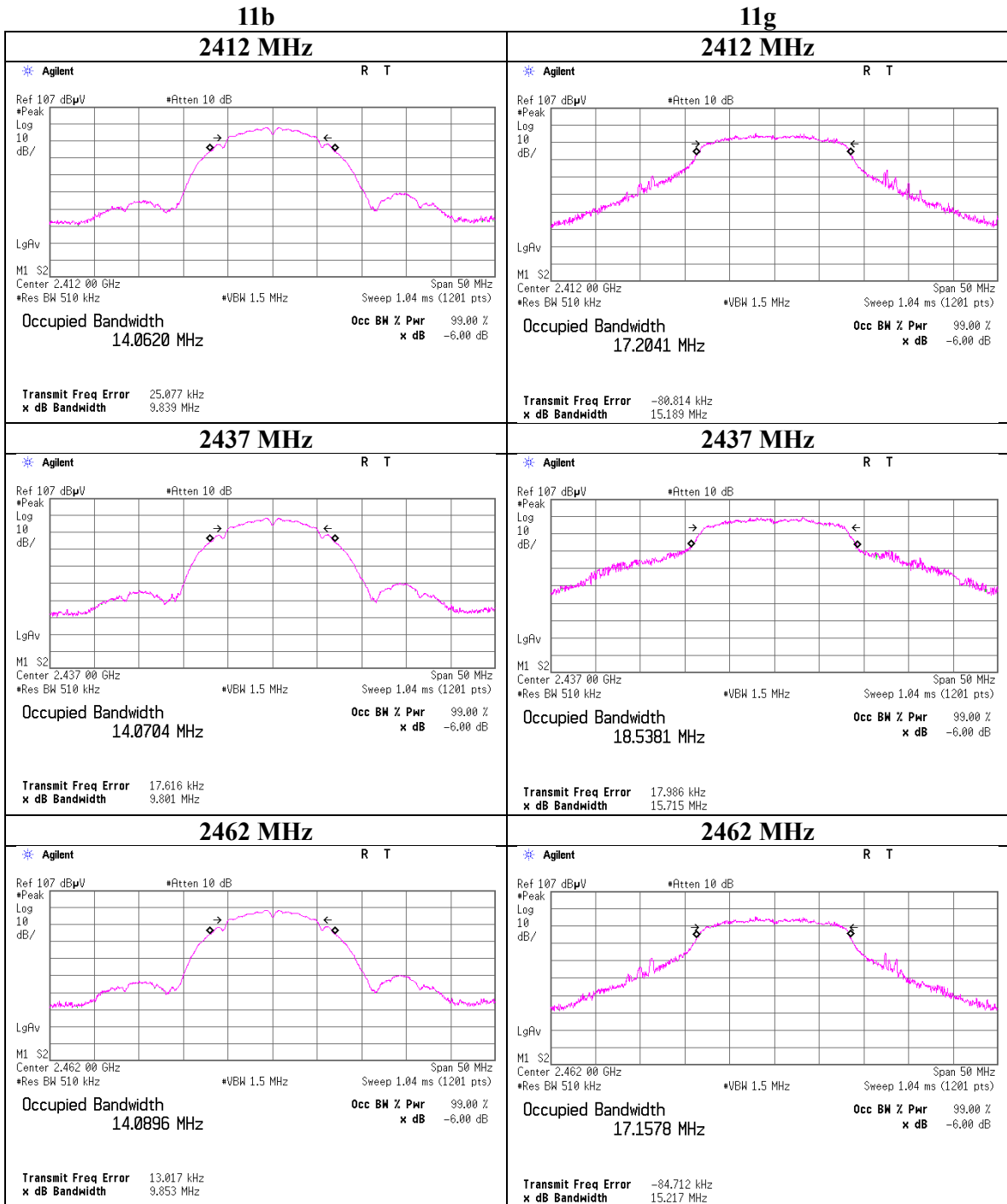

## 99 % Occupied Bandwidth

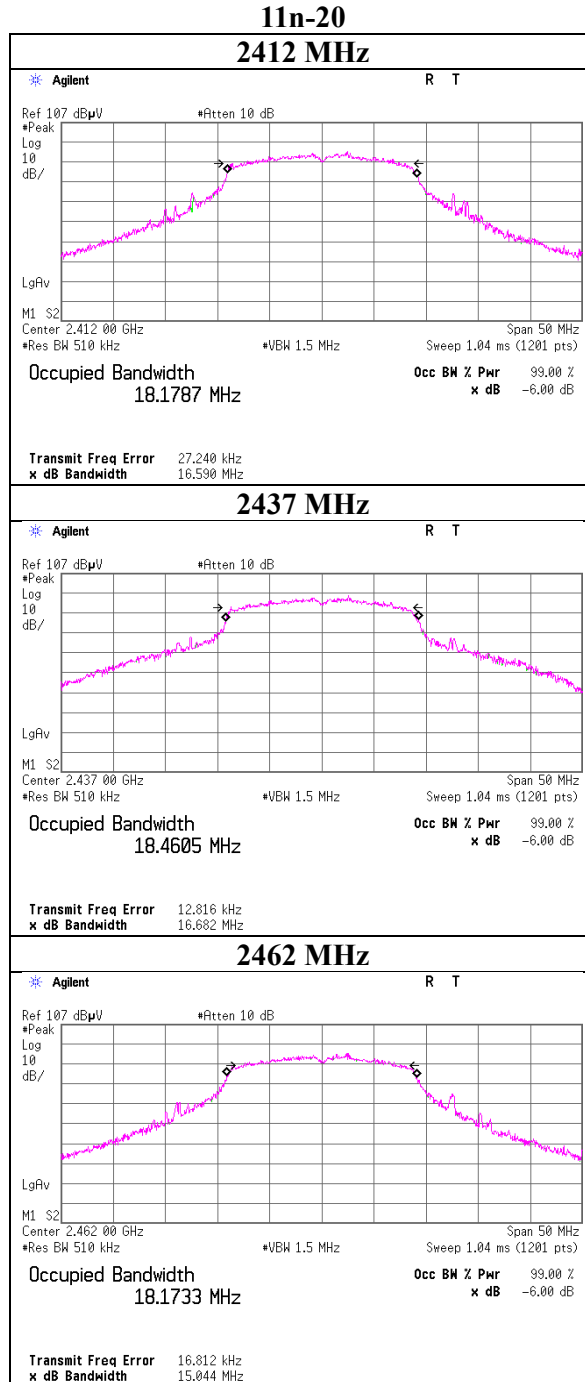

**6 dB Bandwidth**

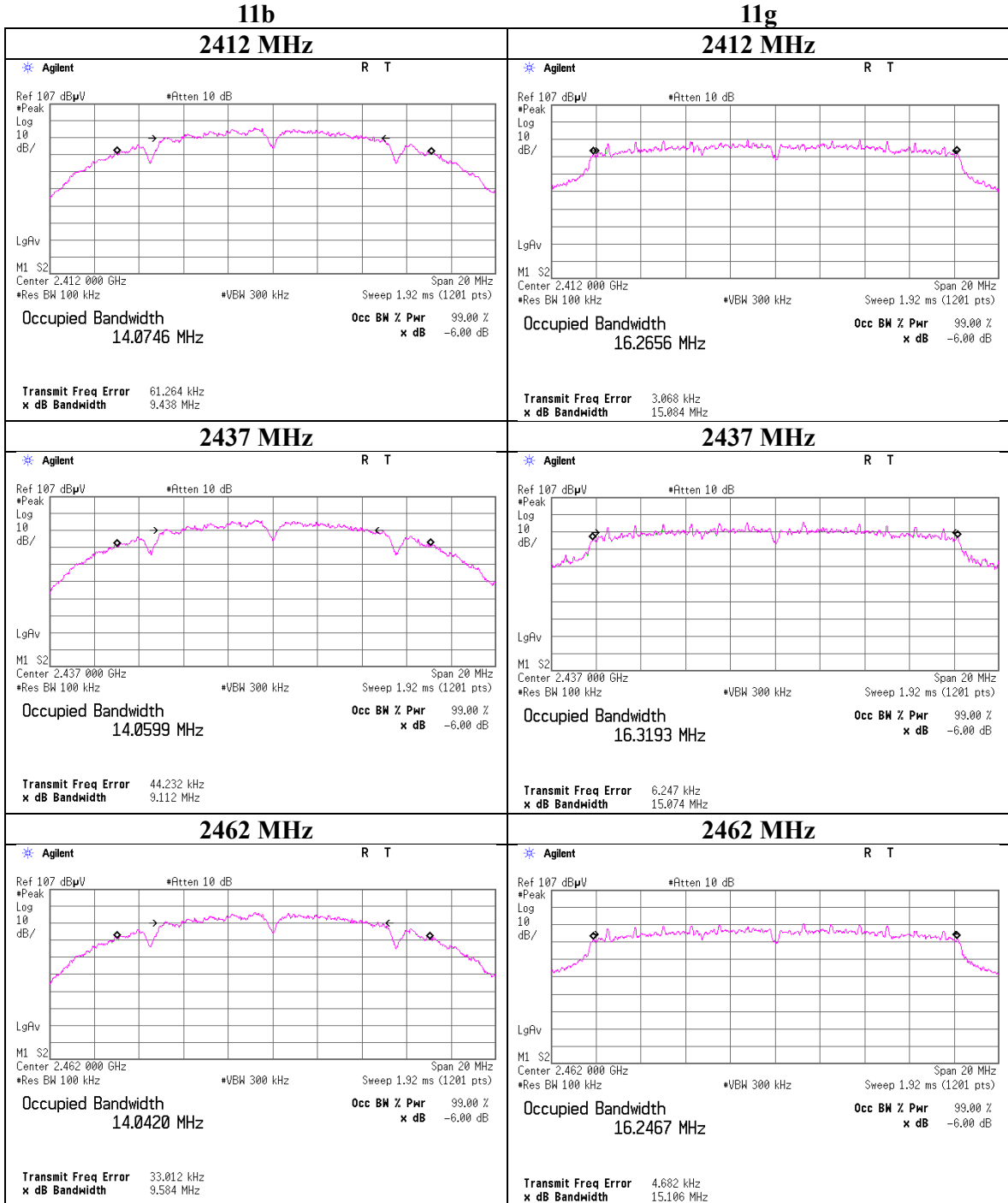

## 6 dB Bandwidth

**11n-20**

**2412 MHz**

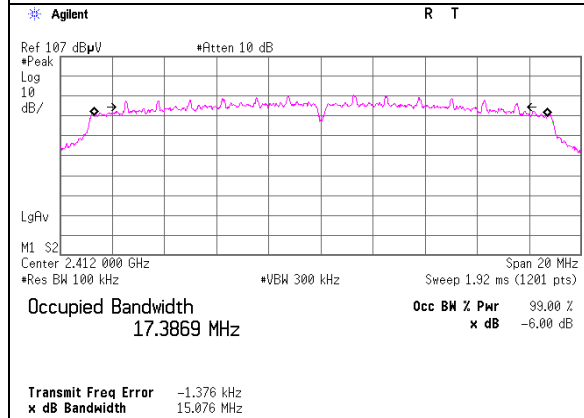

**2437 MHz**

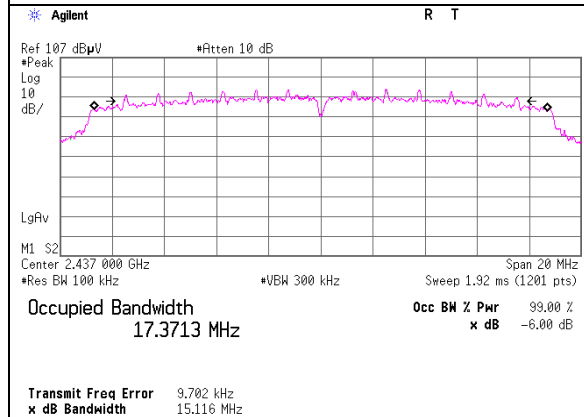

**2462 MHz**

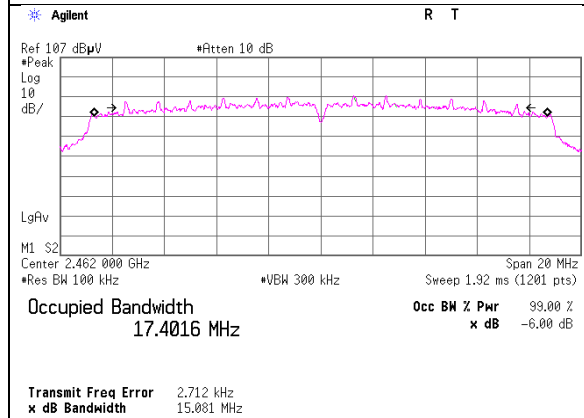

**UL Japan, Inc.**

**Ise EMC Lab.**

4383-326 Asama-cho, Ise-shi, Mie-ken 516-0021 JAPAN

Telephone : +81 596 24 8999

Facsimile : +81 596 24 8124

## Maximum Peak Output Power

Report No. 12717687H  
 Test place Ise EMC Lab. No.3 Measurement Room  
 Date February 4, 2019  
 Temperature / Humidity 23 deg. C / 34 % RH  
 Engineer Yuta Moriya  
 Mode Tx 11b

Freq. [MHz]	Reading [dBm]	Cable Loss [dB]	Atten. Loss [dB]	Conducted Power					e.i.r.p. for RSS-247					
				Result		Limit		Margin [dB]	Antenna Gain [dBi]	Result		Limit		Margin [dB]
				[dBm]	[mW]	[dBm]	[mW]			[dBm]	[mW]	[dBm]	[mW]	
2412	7.54	0.75	10.09	18.38	68.87	30.00	1000	11.62	0.50	18.88	77.27	36.02	4000	17.14
2417	8.00	0.75	10.09	18.84	76.56	30.00	1000	11.16	0.50	19.34	85.90	36.02	4000	16.68
2437	7.95	0.75	10.09	18.79	75.68	30.00	1000	11.21	0.50	19.29	84.92	36.02	4000	16.73
2457	7.94	0.75	10.09	18.78	75.51	30.00	1000	11.22	0.50	19.28	84.72	36.02	4000	16.74
2462	8.05	0.75	10.09	18.89	77.45	30.00	1000	11.11	0.50	19.39	86.90	36.02	4000	16.63

Sample Calculation:

Result = Reading + Cable Loss (including the cable(s) customer supplied) + Attenuator Loss

e.i.r.p. Result = Conducted Power Result + Antenna Gain

\*The equipment and cables were not used for factor 0 dB of the data sheets.

Long 2437MHz

Rate	Reading	Remark
[Mbps]	[dBm]	
1	7.87	
2	7.90	
5.5	7.90	
11	7.72	

Short 2437MHz

Rate	Reading	Remark
[Mbps]	[dBm]	
1	7.90	
2	7.95	*
5.5	7.91	
11	7.74	

\*: Worst Rate

**UL Japan, Inc.**

**Ise EMC Lab.**

4383-326 Asama-cho, Ise-shi, Mie-ken 516-0021 JAPAN

Telephone : +81 596 24 8999

Facsimile : +81 596 24 8124

## Maximum Peak Output Power

Report No. 12717687H  
Test place Ise EMC Lab. No.3 Measurement Room  
Date February 4, 2019  
Temperature / Humidity 23 deg. C / 34 % RH  
Engineer Yuta Moriya  
Mode Tx 11g

Freq. [MHz]	Reading [dBm]	Cable Loss [dB]	Atten. Loss [dB]	Conducted Power					e.i.r.p. for RSS-247					
				Result		Limit		Margin [dB]	Antenna Gain [dBi]	Result		Limit		Margin [dB]
				[dBm]	[mW]	[dBm]	[mW]			[dBm]	[mW]	[dBm]	[mW]	
2412	8.90	0.75	10.09	19.74	94.19	30.00	1000	10.26	0.50	20.24	105.68	36.02	4000	15.78
2417	9.80	0.75	10.09	20.64	115.88	30.00	1000	9.36	0.50	21.14	130.02	36.02	4000	14.88
2437	9.98	0.75	10.09	20.82	120.78	30.00	1000	9.18	0.50	21.32	135.52	36.02	4000	14.70
2457	9.93	0.75	10.09	20.77	119.40	30.00	1000	9.23	0.50	21.27	133.97	36.02	4000	14.75
2462	9.11	0.75	10.09	19.95	98.86	30.00	1000	10.05	0.50	20.45	110.92	36.02	4000	15.57

Sample Calculation:

Result = Reading + Cable Loss (including the cable(s) customer supplied) + Attenuator Loss

e.i.r.p. Result = Conducted Power Result + Antenna Gain

\*The equipment and cables were not used for factor 0 dB of the data sheets.

2437 MHz

Rate	Reading	Remark
[Mbps]	[dBm]	
6	9.73	
9	9.98	*
12	9.80	
18	9.67	
24	9.60	
36	9.59	
48	9.46	
54	9.57	

\*: Worst Rate

### Maximum Peak Output Power

Report No. 12717687H  
 Test place Ise EMC Lab. No.3 Measurement Room  
 Date February 4, 2019  
 Temperature / Humidity 23 deg. C / 34 % RH  
 Engineer Yuta Moriya  
 Mode Tx 11n-20

Freq. [MHz]	Reading [dBm]	Cable Loss [dB]	Atten. Loss [dB]	Conducted Power					e.i.r.p. for RSS-247					
				Result		Limit		Margin [dB]	Antenna Gain [dBi]	Result		Limit		Margin [dB]
				[dBm]	[mW]	[dBm]	[mW]			[dBm]	[mW]	[dBm]	[mW]	
2412	8.62	0.75	10.09	19.46	88.31	30.00	1000	10.54	0.50	19.96	99.08	36.02	4000	16.06
2417	9.63	0.75	10.09	20.47	111.43	30.00	1000	9.53	0.50	20.97	125.03	36.02	4000	15.05
2437	9.74	0.75	10.09	20.58	114.29	30.00	1000	9.42	0.50	21.08	128.23	36.02	4000	14.94
2457	9.74	0.75	10.09	20.58	114.29	30.00	1000	9.42	0.50	21.08	128.23	36.02	4000	14.94
2462	8.94	0.75	10.09	19.78	95.06	30.00	1000	10.22	0.50	20.28	106.66	36.02	4000	15.74

Sample Calculation:

Result = Reading + Cable Loss (including the cable(s) customer supplied) + Attenuator Loss

e.i.r.p. Result = Conducted Power Result + Antenna Gain

\*The equipment and cables were not used for factor 0 dB of the data sheets.

2437 MHz

MCS Number	Reading [dBm]	Remark
0	9.73	
1	9.74	*
2	9.70	
3	9.49	
4	9.45	
5	9.47	
6	9.55	
7	9.01	

\*: Worst Rate



**Average Output Power**  
**(Reference data for RF Exposure)**

Report No. 12717687H  
Test place Ise EMC Lab. No.6 Measurement Room  
Date February 5, 2019  
Temperature / Humidity 23 deg. C / 32 % RH  
Engineer Yuta Moriya  
Mode Tx

**11b 5.5 Mbps(short)**

Freq. [MHz]	Reading [dBm]	Cable Loss [dB]	Atten. Loss [dB]	Result (Time average)		Duty factor [dB]	Result (Burst power average)	
				[dBm]	[mW]		[dBm]	[mW]
2412	-0.33	0.75	10.09	10.51	11.25	5.83	16.34	43.05
2417	-0.03	0.75	10.09	10.81	12.05	5.83	16.64	46.13
2437	-0.21	0.75	10.09	10.63	11.56	5.83	16.46	44.26
2457	-0.17	0.75	10.09	10.67	11.67	5.83	16.50	44.67
2462	0.14	0.75	10.09	10.98	12.53	5.83	16.81	47.97

**11g 6 Mbps**

Freq. [MHz]	Reading [dBm]	Cable Loss [dB]	Atten. Loss [dB]	Result (Time average)		Duty factor [dB]	Result (Burst power average)	
				[dBm]	[mW]		[dBm]	[mW]
2412	-5.21	0.75	10.09	5.63	3.66	5.63	11.26	13.37
2417	-0.59	0.75	10.09	10.25	10.59	5.63	15.88	38.73
2437	-0.75	0.75	10.09	10.09	10.21	5.63	15.72	37.33
2457	-0.50	0.75	10.09	10.34	10.81	5.63	15.97	39.54
2462	-5.03	0.75	10.09	5.81	3.81	5.63	11.44	13.93

**11n-20 MCS 2**

Freq. [MHz]	Reading [dBm]	Cable Loss [dB]	Atten. Loss [dB]	Result (Time average)		Duty factor [dB]	Result (Burst power average)	
				[dBm]	[mW]		[dBm]	[mW]
2412	-5.01	0.75	10.09	5.83	3.83	5.11	10.94	12.42
2417	-1.22	0.75	10.09	9.62	9.16	5.11	14.73	29.72
2437	-1.43	0.75	10.09	9.41	8.73	5.11	14.52	28.31
2457	-1.13	0.75	10.09	9.71	9.35	5.11	14.82	30.34
2462	-4.76	0.75	10.09	6.08	4.06	5.11	11.19	13.15

The average output power was measured with the maximum burst power average data rate.

**Burst rate confirmation**

Report No. 12717687H  
Test place Ise EMC Lab. No.3 Semi Anechoic Chamber  
Date February 4, 2019  
Temperature / Humidity 20 deg. C / 30 % RH  
Engineer Yuta Moriya  
Mode Tx

**11b 2 Mbps**

Tx on / (Tx on + Tx off) =	<b>0.275</b>
Tx on / (Tx on + Tx off) * 100 =	<b>27.5 %</b>
Duty factor = $10 * \log (14.98 / 4.121) =$	<b>5.61 dB</b>

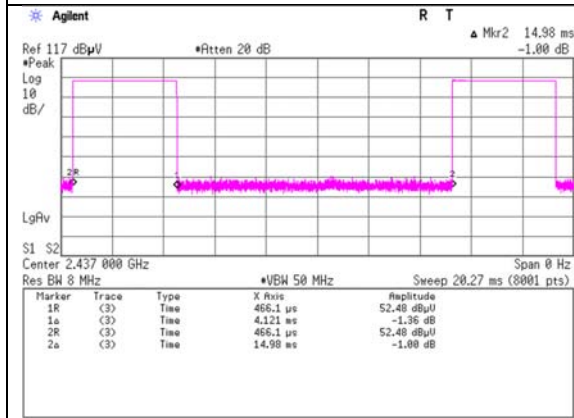

**11g 9 Mbps**

Tx on / (Tx on + Tx off) =	<b>0.298</b>
Tx on / (Tx on + Tx off) * 100 =	<b>29.8 %</b>
Duty factor = $10 * \log (6.012 / 1.7909) =$	<b>5.26 dB</b>

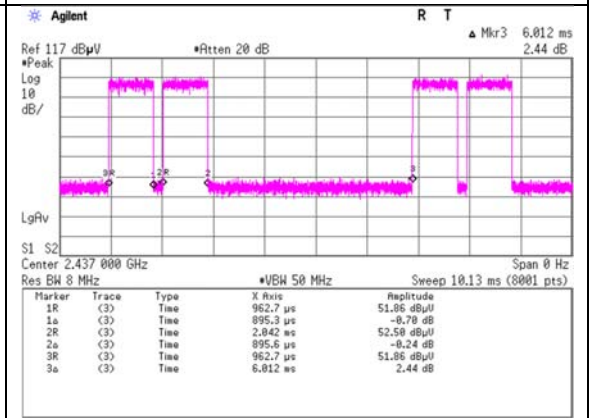

**11n-20 MCS 1**

Tx on / (Tx on + Tx off) =	<b>0.302</b>
Tx on / (Tx on + Tx off) * 100 =	<b>30.2 %</b>
Duty factor = $10 * \log (5.986 / 1.8093) =$	<b>5.20 dB</b>

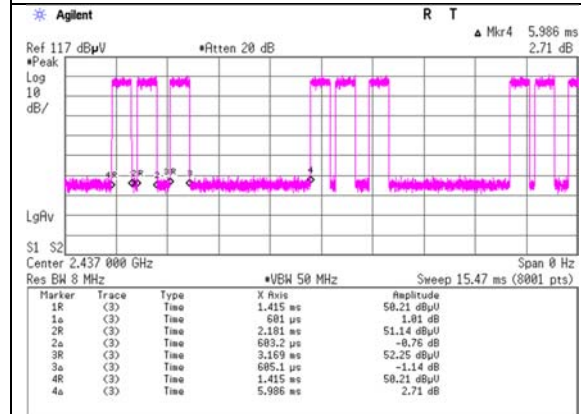

\* Since the burst rate is not different between the channels, the data has been obtained on the representative channel.

### Burst rate confirmation

Report No. 12717687H  
 Test place Ise EMC Lab. No.3 Semi Anechoic Chamber  
 Date February 4, 2019  
 Temperature / Humidity 20 deg. C / 30 % RH  
 Engineer Yuta Moriya  
 Mode Tx

#### 11b 5.5 Mbps

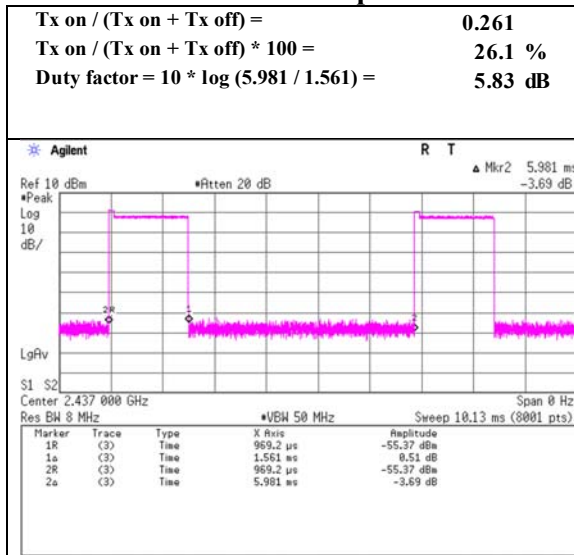

#### 11g 6 Mbps

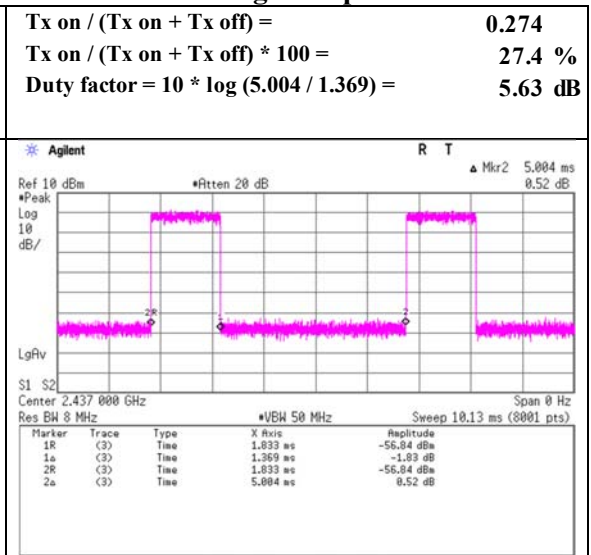

#### 11n-20 MCS 2

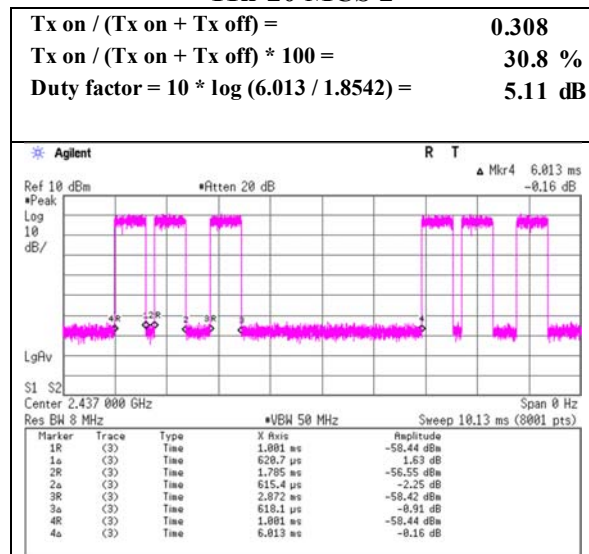

\* Since the burst rate is not different between the channels, the data has been obtained on the representative channel.

## Radiated Spurious Emission

Report No.	12717687H	
Test place	Ise EMC Lab.	
Semi Anechoic Chamber	No.3	No.3
Date	February 4, 2019	February 5, 2019
Temperature / Humidity	22 deg. C / 32 % RH	24 deg. C / 31 % RH
Engineer	Tomohisa Nakagawa	Tomohisa Nakagawa
	(1 GHz - 10 GHz)	(10 GHz - 26.5 GHz)
Mode	Tx 11b 2412 MHz	

Polarity	Frequency [MHz]	Detector	Reading [dBuV]	Ant.Fac. [dB/m]	Loss [dB]	Gain [dB]	Duty Factor [dB]	Result [dBuV/m]	Limit [dBuV/m]	Margin [dB]	Remark
Hori	2390.000	PK	52.4	27.8	5.7	32.7	-	53.2	73.9	20.7	
Hori	4020.000	PK	51.9	30.1	6.8	32.0	-	56.8	73.9	17.1	
Hori	4824.000	PK	50.3	31.7	7.0	31.8	-	57.2	73.9	16.7	
Hori	7236.000	PK	43.9	35.9	8.4	32.6	-	55.6	73.9	18.3	Floor noise
Hori	9648.000	PK	43.2	38.7	9.3	33.3	-	57.9	73.9	16.0	Floor noise
Hori	2390.000	AV	41.6	27.8	5.7	32.7	5.6	48.0	53.9	5.9	*1)
Hori	4020.000	AV	38.7	30.1	6.8	32.0	5.6	49.2	53.9	4.7	*2)
Hori	4824.000	AV	36.9	31.7	7.0	31.8	5.6	49.4	53.9	4.5	
Hori	7236.000	AV	32.9	35.9	8.4	32.6	-	44.6	53.9	9.3	Floor noise
Hori	9648.000	AV	31.3	38.7	9.3	33.3	-	46.0	53.9	7.9	Floor noise
Vert	2390.000	PK	53.0	27.8	5.7	32.7	-	53.8	73.9	20.1	
Vert	4020.000	PK	51.3	30.1	6.8	32.0	-	56.2	73.9	17.7	
Vert	4824.000	PK	49.4	31.7	7.0	31.8	-	56.3	73.9	17.6	
Vert	7236.000	PK	43.6	35.9	8.4	32.6	-	55.3	73.9	18.6	Floor noise
Vert	9648.000	PK	45.7	38.7	9.3	33.3	-	60.4	73.9	13.5	Floor noise
Vert	2390.000	AV	40.2	27.8	5.7	32.7	5.6	46.6	53.9	7.3	*1)
Vert	4020.000	AV	38.1	30.1	6.8	32.0	5.6	48.6	53.9	5.3	*2)
Vert	4824.000	AV	36.5	31.7	7.0	31.8	5.6	49.0	53.9	4.9	
Vert	7236.000	AV	31.2	35.9	8.4	32.6	-	42.9	53.9	11.0	Floor noise
Vert	9648.000	AV	32.0	38.7	9.3	33.3	-	46.7	53.9	7.2	Floor noise

Result = Reading + Ant Factor + Loss (Cable+Attenuator+Filter+Distance factor(above 1 GHz)) - Gain(Amplifier) + Duty factor

\*Other frequency noises omitted in this report were not seen or had enough margin (more than 20 dB).

Distance factor: 1 GHz - 10 GHz  $20\log(4\text{ m} / 3.0\text{ m}) = 2.5\text{ dB}$   
10 GHz - 26.5 GHz  $20\log(1.0\text{ m} / 3.0\text{ m}) = -9.5\text{ dB}$

\*1) Not Out of Band emission(Leakage Power)

\*2) Noise synchronized with duty of carrier frequency.

### 20dBc Data Sheet

Polarity	Frequency [MHz]	Detector	Reading [dBuV]	Ant Factor [dB/m]	Loss [dB]	Gain [dB]	Result [dBuV/m]	Limit [dBuV/m]	Margin [dB]	Remark
Hori	2412.000	PK	99.1	27.7	5.7	32.7	99.8	-	-	Carrier
Hori	2400.000	PK	49.6	27.8	5.7	32.7	50.4	79.8	29.4	
Hori	6432.000	PK	42.7	33.5	8.8	32.2	52.8	79.8	27.0	
Vert	2412.000	PK	100.5	27.7	5.7	32.7	101.2	-	-	Carrier
Vert	2400.000	PK	49.8	27.8	5.7	32.7	50.6	81.2	30.6	
Vert	6432.000	PK	41.3	33.5	8.0	32.2	50.6	81.2	30.6	

Result = Reading + Ant Factor + Loss (Cable+Attenuator+Filter+Distance factor(above 1 GHz)) - Gain(Amplifier)

Distance factor: 1 GHz - 10 GHz  $20\log(4.0\text{ m} / 3.0\text{ m}) = 2.5\text{ dB}$

**Radiated Spurious Emission  
(Reference Plot for band-edge)**

Report No. 12717687H  
Test place Ise EMC Lab.  
Semi Anechoic Chamber No.3  
Date February 4, 2019  
Temperature / Humidity 22 deg. C / 32 % RH  
Engineer Tomohisa Nakagawa  
(1 GHz - 10 GHz)  
Mode Tx 11b 2412 MHz

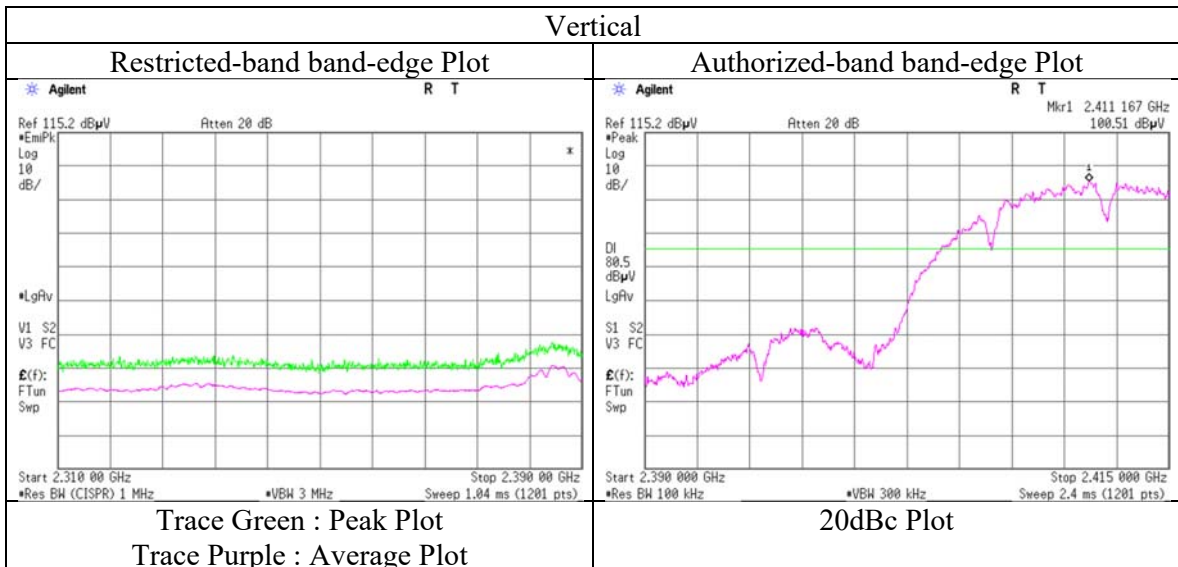
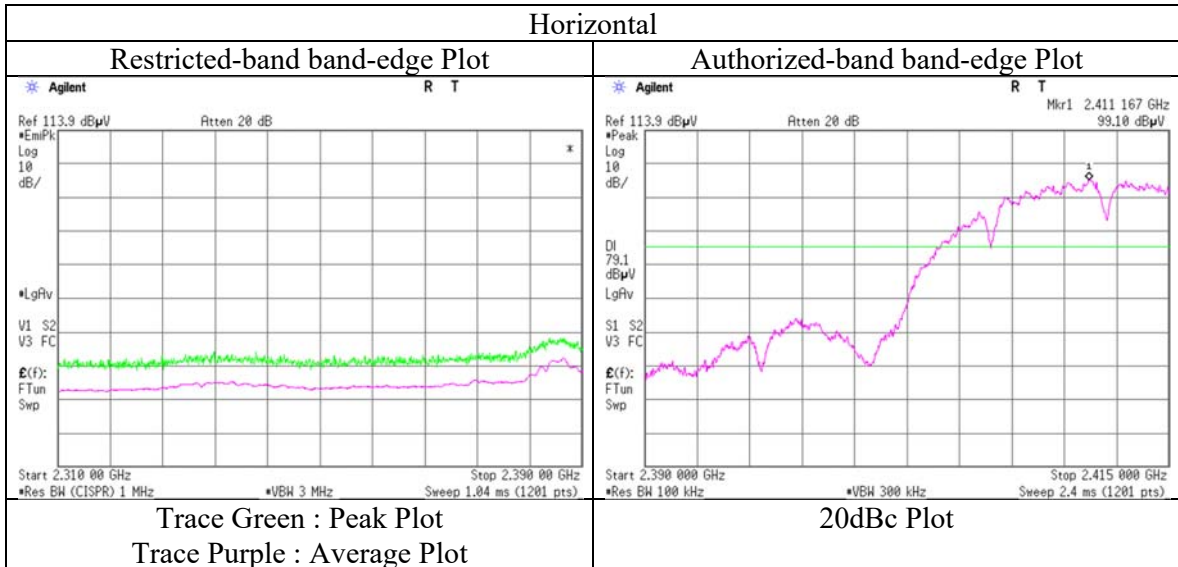

\* The measurement was conducted for a sufficiently long enough time to detect any possible spurious emissions.  
Final result of restricted band edge was shown in tabular data.

## Radiated Spurious Emission

Report No. 12717687H  
 Test place Ise EMC Lab.  
 Semi Anechoic Chamber No.3  
 Date February 4, 2019  
 Temperature / Humidity 22 deg. C / 32 % RH  
 Engineer Tomohisa Nakagawa  
 (1 GHz - 10 GHz)  
 Mode Tx 11b 2417 MHz

Polarity	Frequency [MHz]	Detector	Reading [dBuV]	Ant.Fac. [dB/m]	Loss [dB]	Gain [dB]	Duty Factor [dB]	Result [dBuV/m]	Limit [dBuV/m]	Margin [dB]	Remark
Hori	2390.000	PK	52.3	27.8	5.7	32.7	-	53.1	73.9	20.8	
Hori	2390.000	AV	40.9	27.8	5.7	32.7	5.6	47.3	53.9	6.6	*1)
Vert	2390.000	PK	53.3	27.8	5.7	32.7	-	54.1	73.9	19.8	
Vert	2390.000	AV	41.4	27.8	5.7	32.7	5.6	47.8	53.9	6.1	*1)

Result = Reading + Ant Factor + Loss (Cable+Attenuator+Filter+Distance factor(above 1 GHz)) - Gain(Amplifier) + Duty factor

\*Other frequency noises omitted in this report were not seen or had enough margin (more than 20 dB).

Distance factor: 1 GHz - 10 GHz  $20\log(4\text{ m} / 3.0\text{ m}) = 2.5\text{ dB}$

\*1) Not Out of Band emission(Leakage Power)

### 20dBc Data Sheet

Polarity	Frequency [MHz]	Detector	Reading [dBuV]	Ant Factor [dB/m]	Loss [dB]	Gain [dB]	Result [dBuV/m]	Limit [dBuV/m]	Margin [dB]	Remark
Hori	2417.000	PK	101.7	27.6	5.7	32.7	102.3	-	-	Carrier
Hori	2400.000	PK	51.6	27.8	5.7	32.7	52.4	82.3	29.9	
Vert	2417.000	PK	103.6	27.6	5.7	32.7	104.2	-	-	Carrier
Vert	2400.000	PK	56.5	27.8	5.7	32.7	57.3	84.2	26.9	

Result = Reading + Ant Factor + Loss (Cable+Attenuator+Filter+Distance factor(above 1 GHz)) - Gain(Amplifier)

Distance factor: 1 GHz - 10 GHz  $20\log(4\text{ m} / 3.0\text{ m}) = 2.5\text{ dB}$

**UL Japan, Inc.**

**Ise EMC Lab.**

4383-326 Asama-cho, Ise-shi, Mie-ken 516-0021 JAPAN

Telephone : +81 596 24 8999

Facsimile : +81 596 24 8124

## Radiated Spurious Emission

Report No.	12717687H	
Test place	Ise EMC Lab.	
Semi Anechoic Chamber	No.3	No.3
Date	February 4, 2019	February 5, 2019
Temperature / Humidity	22 deg. C / 32 % RH	24 deg. C / 31 % RH
Engineer	Tomohisa Nakagawa (1 GHz - 10 GHz)	Tomohisa Nakagawa (10 GHz - 26.5 GHz)
Mode	Tx 11b 2437 MHz	

Polarity	Frequency [MHz]	Detector	Reading [dBuV]	Ant.Fac. [dB/m]	Loss [dB]	Gain [dB]	Duty Factor [dB]	Result [dBuV/m]	Limit [dBuV/m]	Margin [dB]	Remark
Hori	4060.000	PK	46.4	30.1	6.8	32.0	-	51.3	73.9	22.6	
Hori	4874.000	PK	43.0	31.7	7.1	31.7	-	50.1	73.9	23.8	
Hori	7311.000	PK	42.9	36.3	8.4	32.7	-	54.9	73.9	19.0	Floor noise
Hori	9748.000	PK	44.2	39.0	9.3	33.4	-	59.1	73.9	14.8	Floor noise
Hori	4060.000	AV	34.6	30.1	6.8	32.0	5.6	45.1	53.9	8.8	*1)
Hori	4874.000	AV	32.3	31.7	7.1	31.7	5.6	45.0	53.9	8.9	
Hori	7311.000	AV	32.5	36.3	8.4	32.7	-	44.5	53.9	9.4	Floor noise
Hori	9748.000	AV	30.8	39.0	9.3	33.4	-	45.7	53.9	8.2	Floor noise
Vert	4060.000	PK	47.6	30.1	6.8	32.0	-	52.5	73.9	21.4	
Vert	4874.000	PK	45.0	31.7	7.1	31.7	-	52.1	73.9	21.8	
Vert	7311.000	PK	43.4	36.3	8.4	32.7	-	55.4	73.9	18.5	Floor noise
Vert	9748.000	PK	43.6	39.0	9.3	33.4	-	58.5	73.9	15.4	Floor noise
Vert	4060.000	AV	36.1	30.1	6.8	32.0	5.6	46.6	53.9	7.3	*1)
Vert	4874.000	AV	34.5	31.7	7.1	31.7	5.6	47.2	53.9	6.7	
Vert	7311.000	AV	32.7	36.3	8.4	32.7	-	44.7	53.9	9.2	Floor noise
Vert	9748.000	AV	31.8	39.0	9.3	33.4	-	46.7	53.9	7.2	Floor noise

Result = Reading + Ant Factor + Loss (Cable+Attenuator+Filter+Distance factor(above 1 GHz)) - Gain(Amplifier) + Duty factor

\*Other frequency noises omitted in this report were not seen or had enough margin (more than 20 dB).

Distance factor:    1 GHz - 10 GHz    20log (4 m / 3.0 m) = 2.5 dB  
                          10 GHz - 26.5 GHz 20log (1.0 m / 3.0 m) = -9.5 dB

\*1) Noise synchronized with duty of carrier frequency.

## Radiated Spurious Emission

Report No. 12717687H  
 Test place Ise EMC Lab.  
 Semi Anechoic Chamber No.3  
 Date February 4, 2019  
 Temperature / Humidity 22 deg. C / 32 % RH  
 Engineer Tomohisa Nakagawa  
 (1 GHz - 10 GHz)  
 Mode Tx 11b 2457 MHz

Polarity	Frequency [MHz]	Detector	Reading [dBuV]	Ant.Fac. [dB/m]	Loss [dB]	Gain [dB]	Duty Factor [dB]	Result [dBuV/m]	Limit [dBuV/m]	Margin [dB]	Remark
Hori	2483.500	PK	51.6	27.5	5.7	32.7	-	52.1	73.9	21.8	
Hori	2483.500	AV	37.1	27.5	5.7	32.7	5.6	43.2	53.9	10.7	*1)
Vert	2483.500	PK	53.8	27.5	5.7	32.7	-	54.3	73.9	19.6	
Vert	2483.500	AV	40.5	27.5	5.7	32.7	5.6	46.6	53.9	7.3	*1)

Result = Reading + Ant Factor + Loss (Cable+Attenuator+Filter+Distance factor(above 1 GHz)) - Gain(Amplifier) + Duty factor  
 \*Other frequency noises omitted in this report were not seen or had enough margin (more than 20 dB).

Distance factor: 1 GHz - 10 GHz  $20\log(4\text{ m} / 3.0\text{ m}) = 2.5\text{ dB}$   
 10 GHz - 26.5 GHz  $20\log(1.0\text{ m} / 3.0\text{ m}) = -9.5\text{ dB}$

\*1) Not Out of Band emission(Leakage Power)



## Radiated Spurious Emission

Report No.	12717687H	
Test place	Ise EMC Lab.	
Semi Anechoic Chamber	No.3	No.3
Date	February 4, 2019	February 5, 2019
Temperature / Humidity	22 deg. C / 32 % RH	24 deg. C / 31 % RH
Engineer	Tomohisa Nakagawa	Tomohisa Nakagawa
	(1 GHz - 10 GHz)	(10 GHz - 26.5 GHz)
Mode	Tx 11b 2462 MHz	

Polarity	Frequency [MHz]	Detector	Reading [dBuV]	Ant.Fac. [dB/m]	Loss [dB]	Gain [dB]	Duty Factor [dB]	Result [dBuV/m]	Limit [dBuV/m]	Margin [dB]	Remark
Hori	2483.500	PK	55.6	27.5	5.7	32.7	-	56.1	73.9	17.8	
Hori	4924.000	PK	46.5	31.8	7.1	31.7	-	53.7	73.9	20.2	
Hori	7386.000	PK	43.1	36.6	8.4	32.7	-	55.4	73.9	18.5	Floor noise
Hori	9848.000	PK	42.3	39.1	9.4	33.4	-	57.4	73.9	16.5	Floor noise
Hori	2483.500	AV	40.7	27.5	5.7	32.7	5.6	46.8	53.9	7.1	*1)
Hori	4924.000	AV	35.7	31.8	7.1	31.7	5.6	48.5	53.9	5.4	
Hori	7386.000	AV	32.4	36.6	8.4	32.7	-	44.7	53.9	9.2	Floor noise
Hori	9848.000	AV	31.3	39.1	9.4	33.4	-	46.4	53.9	7.5	Floor noise
Vert	2483.500	PK	56.0	27.5	5.7	32.7	-	56.5	73.9	17.4	
Vert	4924.000	PK	42.3	31.8	7.1	31.7	-	49.5	73.9	24.4	
Vert	7386.000	PK	43.4	36.6	8.4	32.7	-	55.7	73.9	18.2	Floor noise
Vert	9848.000	PK	43.4	39.1	9.4	33.4	-	58.5	73.9	15.4	Floor noise
Vert	2483.500	AV	40.9	27.5	5.7	32.7	5.6	47.0	53.9	6.9	*1)
Vert	4924.000	AV	31.8	31.8	7.1	31.7	5.6	44.6	53.9	9.3	
Vert	7386.000	AV	32.4	36.6	8.4	32.7	-	44.7	53.9	9.2	Floor noise
Vert	9848.000	AV	31.3	39.1	9.4	33.4	-	46.4	53.9	7.5	Floor noise

Result = Reading + Ant Factor + Loss (Cable+Attenuator+Filter+Distance factor(above 1 GHz)) - Gain(Amplifier) + Duty factor

\*Other frequency noises omitted in this report were not seen or had enough margin (more than 20 dB).

Distance factor: 1 GHz - 10 GHz  $20\log(4\text{ m} / 3.0\text{ m}) = 2.5\text{ dB}$   
10 GHz - 26.5 GHz  $20\log(1.0\text{ m} / 3.0\text{ m}) = -9.5\text{ dB}$

\*1) Not Out of Band emission(Leakage Power)

### 20dBc Data Sheet

Polarity	Frequency [MHz]	Detector	Reading [dBuV]	Ant Factor [dB/m]	Loss [dB]	Gain [dB]	Result [dBuV/m]	Limit [dBuV/m]	Margin [dB]	Remark
Hori	2462.000	PK	100.5	27.4	5.7	32.7	100.9	-	-	Carrier
Hori	6565.417	PK	40.6	34.1	8.0	32.3	50.4	80.9	30.5	
Vert	2462.000	QP	102.1	27.4	5.7	32.7	102.5	-	-	Carrier
Vert	6565.417	QP	40.0	34.1	8.0	32.3	49.8	82.5	32.7	

Result = Reading + Ant Factor + Loss (Cable+Attenuator+Filter+Distance factor(above 1 GHz)) - Gain(Amplifier)

Distance factor: 1 GHz - 10 GHz  $20\log(4\text{ m} / 3.0\text{ m}) = 2.5\text{ dB}$

**Radiated Spurious Emission**  
**(Reference Plot for band-edge)**

Report No. 12717687H  
Test place Ise EMC Lab.  
Semi Anechoic Chamber No.3  
Date February 4, 2019  
Temperature / Humidity 22 deg. C / 32 % RH  
Engineer Tomohisa Nakagawa  
(1 GHz - 10 GHz)  
Mode Tx 11b 2462 MHz

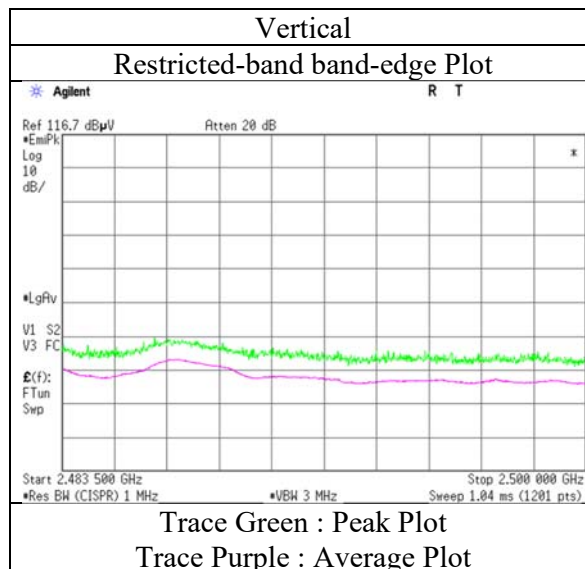
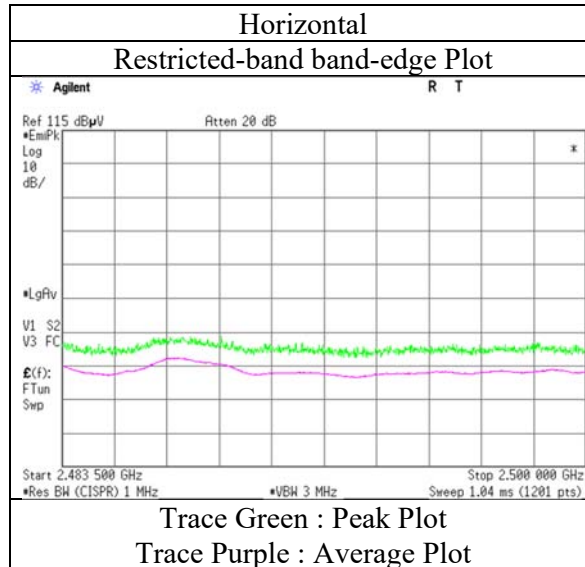

\* The measurement was conducted for a sufficiently long enough time to detect any possible spurious emissions.  
Final result of restricted band edge was shown in tabular data.

## Radiated Spurious Emission

Report No.	12717687H	
Test place	Ise EMC Lab.	
Semi Anechoic Chamber	No.3	No.3
Date	February 4, 2019	February 5, 2019
Temperature / Humidity	22 deg. C / 32 % RH	24 deg. C / 31 % RH
Engineer	Tomohisa Nakagawa (1 GHz - 10 GHz)	Tomohisa Nakagawa (10 GHz - 26.5 GHz)
Mode	Tx 11g 2412 MHz	

Polarity	Frequency [MHz]	Detector	Reading [dBuV]	Ant.Fac. [dB/m]	Loss [dB]	Gain [dB]	Duty Factor [dB]	Result [dBuV/m]	Limit [dBuV/m]	Margin [dB]	Remark
Hori	2390.000	PK	60.0	27.8	5.7	32.7	-	60.8	73.9	13.1	
Hori	4824.000	PK	46.3	31.7	7.0	31.8	-	53.2	73.9	20.7	
Hori	7236.000	PK	43.3	35.9	8.4	32.6	-	55.0	73.9	18.9	Floor noise
Hori	9648.000	PK	42.5	38.7	9.3	33.3	-	57.2	73.9	16.7	Floor noise
Hori	2390.000	AV	41.3	27.8	5.7	32.7	5.3	47.4	53.9	6.5	*1)
Hori	4824.000	AV	36.4	31.7	7.0	31.8	5.3	48.6	53.9	5.3	
Hori	7236.000	AV	32.1	35.9	8.4	32.6	-	43.8	53.9	10.1	Floor noise
Hori	9648.000	AV	31.1	38.7	9.3	33.3	-	45.8	53.9	8.1	Floor noise
Vert	2390.000	PK	60.2	27.8	5.7	32.7	-	61.0	73.9	12.9	
Vert	4824.000	PK	43.3	31.7	7.0	31.8	-	50.2	73.9	23.7	
Vert	7236.000	PK	44.1	35.9	8.4	32.6	-	55.8	73.9	18.1	Floor noise
Vert	9648.000	PK	43.6	38.7	9.3	33.3	-	58.3	73.9	15.6	Floor noise
Vert	2390.000	AV	41.7	27.8	5.7	32.7	5.3	47.8	53.9	6.1	*1)
Vert	4824.000	AV	33.6	31.7	7.0	31.8	5.3	45.8	53.9	8.1	
Vert	7236.000	AV	32.1	35.9	8.4	32.6	-	43.8	53.9	10.1	Floor noise
Vert	9648.000	AV	31.6	38.7	9.3	33.3	-	46.3	53.9	7.6	Floor noise

Result = Reading + Ant Factor + Loss (Cable+Attenuator+Filter+Distance factor(above 1 GHz)) - Gain(Amplifier) + Duty factor

\*Other frequency noises omitted in this report were not seen or had enough margin (more than 20 dB).

Distance factor: 1 GHz - 10 GHz 20log (4 m / 3.0 m) = 2.5 dB  
10 GHz - 26.5 GHz 20log (1.0 m / 3.0 m) = -9.5 dB

\*1) Not Out of Band emission(Leakage Power)

### 20dBc Data Sheet

Polarity	Frequency [MHz]	Detector	Reading [dBuV]	Ant Factor [dB/m]	Loss [dB]	Gain [dB]	Result [dBuV/m]	Limit [dBuV/m]	Margin [dB]	Remark
Hori	2412.000	PK	96.3	27.7	5.7	32.7	97.0	-	-	Carrier
Hori	2400.000	PK	60.4	27.8	5.7	32.7	61.2	77.0	15.8	
Hori	6432.000	PK	41.9	33.5	8.0	32.2	51.2	77.0	25.8	
Vert	2412.000	QP	96.0	27.7	5.7	32.7	96.7	-	-	Carrier
Vert	2400.000	QP	62.9	27.8	5.7	32.7	63.7	76.7	13.0	
Vert	6432.000	QP	40.4	33.5	8.0	32.2	49.7	76.7	27.0	

Result = Reading + Ant Factor + Loss (Cable+Attenuator+Filter+Distance factor(above 1 GHz)) - Gain(Amplifier)

Distance factor: 1 GHz - 10 GHz 20log (4 m / 3.0 m) = 2.5 dB

**Radiated Spurious Emission**  
**(Reference Plot for band-edge)**

Report No.	12717687H
Test place	Ise EMC Lab.
Semi Anechoic Chamber	No.3
Date	February 4, 2019
Temperature / Humidity	22 deg. C / 32 % RH
Engineer	Tomohisa Nakagawa
	(1 GHz - 10 GHz)
Mode	Tx 11g 2412 MHz

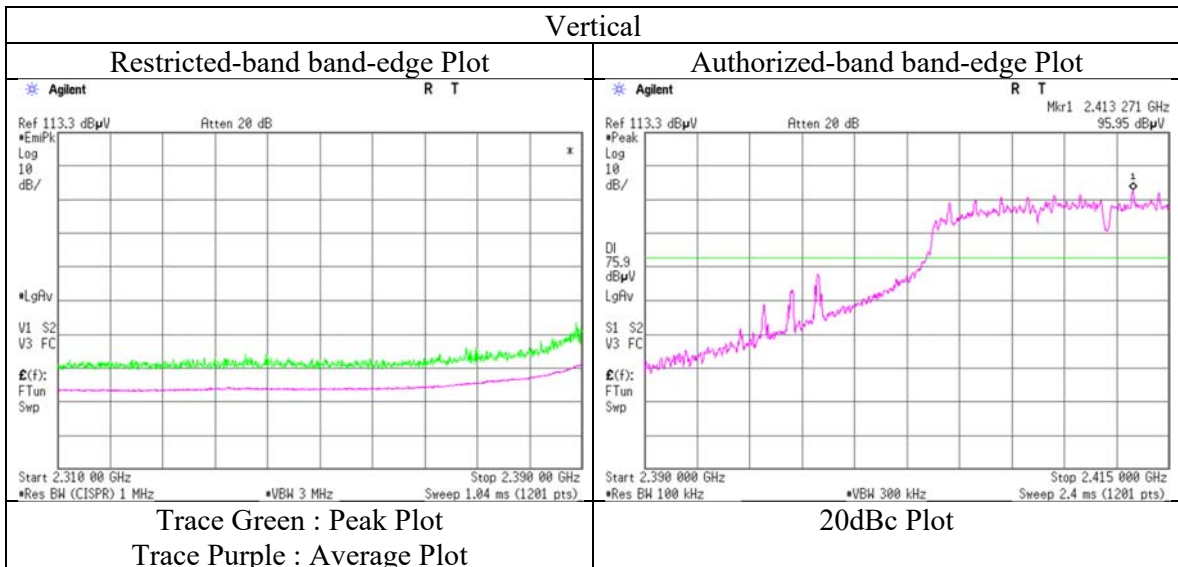
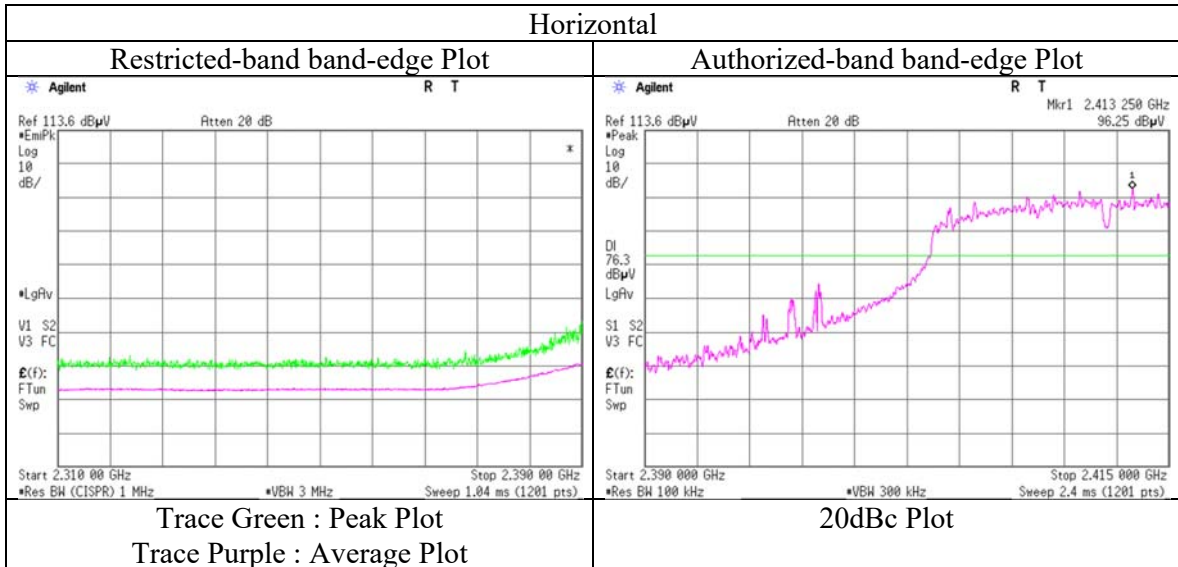

\* The measurement was conducted for a sufficiently long enough time to detect any possible spurious emissions.  
 Final result of restricted band edge was shown in tabular data.

## Radiated Spurious Emission

Report No. 12717687H  
Test place Ise EMC Lab.  
Semi Anechoic Chamber No.4  
Date April 8, 2019  
Temperature / Humidity 20 deg. C / 40 % RH  
Engineer Yuta Moriya  
(1 GHz - 10 GHz)  
Mode Tx 11g 2417 MHz

Polarity	Frequency [MHz]	Detector	Reading [dBuV]	Ant.Fac. [dB/m]	Loss [dB]	Gain [dB]	Duty Factor [dB]	Result [dBuV/m]	Limit [dBuV/m]	Margin [dB]	Remark
Hori	2390.000	PK	60.1	27.8	5.7	32.7	-	60.9	73.9	13.0	
Hori	2390.000	AV	41.7	27.8	5.7	32.7	5.3	47.8	53.9	6.1	*1)
Vert	2390.000	PK	62.0	27.8	5.7	32.7	-	62.8	73.9	11.1	
Vert	2390.000	AV	42.5	27.8	5.7	32.7	5.3	48.6	53.9	5.3	*1)

Result = Reading + Ant Factor + Loss (Cable+Attenuator+Filter+Distance factor(above 1 GHz)) - Gain(Amplifier) + Duty factor

\*Other frequency noises omitted in this report were not seen or had enough margin (more than 20 dB).

Distance factor: 1 GHz - 10 GHz 20log(4 m / 3.0 m) = 2.5 dB

\*1) Not Out of Band emission(Leakage Power)

### 20dBc Data Sheet

Polarity	Frequency [MHz]	Detector	Reading [dBuV]	Ant Factor [dB/m]	Loss [dB]	Gain [dB]	Result [dBuV/m]	Limit [dBuV/m]	Margin [dB]	Remark
Hori	2417.000	PK	97.7	27.6	5.7	32.7	98.3	-	-	Carrier
Hori	2400.000	PK	62.4	27.8	5.7	32.7	63.2	78.3	15.1	
Vert	2417.000	QP	97.9	27.6	5.7	32.7	98.5	-	-	Carrier
Vert	2400.000	QP	63.1	27.8	5.7	32.7	63.9	78.5	14.6	

Result = Reading + Ant Factor + Loss (Cable+Attenuator+Filter+Distance factor(above 1 GHz)) - Gain(Amplifier)

Distance factor: 1 GHz - 10 GHz 20log(4 m / 3.0 m) = 2.5 dB

**UL Japan, Inc.**

**Ise EMC Lab.**

4383-326 Asama-cho, Ise-shi, Mie-ken 516-0021 JAPAN

Telephone : +81 596 24 8999

Facsimile : +81 596 24 8124

## Radiated Spurious Emission

Report No.	12717687H		
Test place	Ise EMC Lab.		
Semi Anechoic Chamber	No.3	No.3	No.3
Date	February 4, 2019	February 5, 2019	February 5, 2019
Temperature / Humidity	22 deg. C / 32 % RH	24 deg. C / 31 % RH	24 deg. C / 31 % RH
Engineer	Tomohisa Nakagawa (1 GHz - 10 GHz)	Tomohisa Nakagawa (10 GHz - 26.5 GHz)	Tomohisa Nakagawa (Below 1GHz)
Mode	Tx 11g 2437 MHz		

Polarity	Frequency [MHz]	Detector	Reading [dBuV]	Ant.Fac. [dB/m]	Loss [dB]	Gain [dB]	Duty Factor [dB]	Result [dBuV/m]	Limit [dBuV/m]	Margin [dB]	Remark
Hori	110.000	QP	26.9	11.6	8.3	32.2	-	14.6	43.5	28.9	
Hori	167.962	QP	32.7	15.9	8.9	32.2	-	25.3	43.5	18.2	
Hori	301.420	QP	36.1	13.7	10.1	32.1	-	27.8	46.0	18.2	
Hori	335.946	QP	36.3	14.9	10.3	32.1	-	29.4	46.0	16.6	
Hori	359.920	QP	33.6	15.2	10.5	32.1	-	27.2	46.0	18.8	
Hori	878.266	QP	22.3	22.1	13.6	31.2	-	26.8	46.0	19.2	
Hori	4874.000	PK	42.0	31.7	7.1	31.7	-	49.1	73.9	24.8	
Hori	7311.000	PK	42.5	36.3	8.4	32.7	-	54.5	73.9	19.4	Floor noise
Hori	9748.000	PK	42.2	39.0	9.3	33.4	-	57.1	73.9	16.8	Floor noise
Hori	4874.000	AV	31.9	31.7	7.1	31.7	5.3	44.3	53.9	9.6	
Hori	7311.000	AV	31.9	36.3	8.4	32.7	-	43.9	53.9	10.0	Floor noise
Hori	9748.000	AV	30.8	39.0	9.3	33.4	-	45.7	53.9	8.2	Floor noise
Vert	78.026	QP	39.6	6.8	7.9	32.2	-	22.1	40.0	17.9	
Vert	110.260	QP	27.6	11.7	8.3	32.2	-	15.4	43.5	28.1	
Vert	304.487	QP	32.3	13.8	10.1	32.1	-	24.1	46.0	21.9	
Vert	383.880	QP	32.2	15.4	10.7	32.1	-	26.2	46.0	19.8	
Vert	455.892	QP	29.0	16.9	11.1	32.1	-	24.9	46.0	21.1	
Vert	909.915	QP	22.3	22.2	13.8	31.0	-	27.3	46.0	18.7	
Vert	4874.000	PK	42.3	31.7	7.1	31.7	-	49.4	73.9	24.5	
Vert	7311.000	PK	42.8	36.3	8.4	32.7	-	54.8	73.9	19.1	Floor noise
Vert	9748.000	PK	42.5	39.0	9.3	33.4	-	57.4	73.9	16.5	Floor noise
Vert	4874.000	AV	32.1	31.7	7.1	31.7	5.3	44.5	53.9	9.4	
Vert	7311.000	AV	32.0	36.3	8.4	32.7	-	44.0	53.9	9.9	Floor noise
Vert	9748.000	AV	31.3	39.0	9.3	33.4	-	46.2	53.9	7.7	Floor noise

Result = Reading + Ant Factor + Loss (Cable+Attenuator+Filter+Distance factor(above 1 GHz)) - Gain(Amplifier) + Duty factor

\*Other frequency noises omitted in this report were not seen or had enough margin (more than 20 dB).

Distance factor: 1 GHz - 10 GHz 20log (4 m / 3.0 m) = 2.5 dB  
10 GHz - 26.5 GHz 20log (1.0 m / 3.0 m) = -9.5 dB

## Radiated Spurious Emission

Report No. 12717687H  
 Test place Ise EMC Lab.  
 Semi Anechoic Chamber No.3  
 Date February 4, 2019  
 Temperature / Humidity 22 deg. C / 32 % RH  
 Engineer Tomohisa Nakagawa  
 (1 GHz - 10 GHz)  
 Mode Tx 11g 2457 MHz

Polarity	Frequency [MHz]	Detector	Reading [dBuV]	Ant.Fac. [dB/m]	Loss [dB]	Gain [dB]	Duty Factor [dB]	Result [dBuV/m]	Limit [dBuV/m]	Margin [dB]	Remark
Hori	2483.500	PK	64.4	27.5	5.7	32.7	-	64.9	73.9	9.0	
Hori	2483.500	AV	45.1	27.5	5.7	32.7	5.3	50.9	53.9	3.0	*1)
Vert	2483.500	PK	63.7	27.5	5.7	32.7	-	64.2	73.9	9.7	
Vert	2483.500	AV	44.9	27.5	5.7	32.7	5.3	50.7	53.9	3.2	*1)

Result = Reading + Ant Factor + Loss (Cable+Attenuator+Filter+Distance factor(above 1 GHz)) - Gain(Amplifier) + Duty factor

\*Other frequency noises omitted in this report were not seen or had enough margin (more than 20 dB).

Distance factor: 1 GHz - 10 GHz  $20\log(4\text{ m} / 3.0\text{ m}) = 2.5\text{ dB}$

\*1) Not Out of Band emission(Leakage Power)

## Radiated Spurious Emission

Report No.	12717687H	
Test place	Ise EMC Lab.	
Semi Anechoic Chamber	No.3	No.3
Date	February 4, 2019	February 5, 2019
Temperature / Humidity	22 deg. C / 32 % RH	24 deg. C / 31 % RH
Engineer	Tomohisa Nakagawa	Tomohisa Nakagawa
	(1 GHz - 10 GHz)	(10 GHz - 26.5 GHz)
Mode	Tx 11g 2462 MHz	

Polarity	Frequency [MHz]	Detector	Reading [dBuV]	Ant.Fac. [dB/m]	Loss [dB]	Gain [dB]	Duty Factor [dB]	Result [dBuV/m]	Limit [dBuV/m]	Margin [dB]	Remark
Hori	2483.500	PK	61.2	27.5	5.7	32.7	-	61.7	73.9	12.2	
Hori	4924.000	PK	43.5	31.8	7.1	31.7	-	50.7	73.9	23.2	
Hori	7386.000	PK	44.2	36.6	8.4	32.7	-	56.5	73.9	17.4	Floor noise
Hori	9848.000	PK	44.0	39.1	9.4	33.4	-	59.1	73.9	14.8	Floor noise
Hori	2483.500	AV	42.4	27.5	5.7	32.7	5.3	48.2	53.9	5.7	*1)
Hori	4924.000	AV	31.4	31.8	7.1	31.7	5.3	43.9	53.9	10.0	
Hori	7386.000	AV	32.8	36.6	8.4	32.7	-	45.1	53.9	8.8	Floor noise
Hori	9848.000	AV	30.9	39.1	9.4	33.4	-	46.0	53.9	7.9	Floor noise
Vert	2483.500	PK	61.8	27.5	5.7	32.7	-	62.3	73.9	11.6	
Vert	4924.000	PK	41.2	31.8	7.1	31.7	-	48.4	73.9	25.5	
Vert	7386.000	PK	40.5	36.6	8.4	32.7	-	52.8	73.9	21.1	Floor noise
Vert	9848.000	PK	40.8	39.1	9.4	33.4	-	55.9	73.9	18.0	Floor noise
Vert	2483.500	AV	42.9	27.5	5.7	32.7	5.3	48.7	53.9	5.2	*1)
Vert	4924.000	AV	31.8	31.8	7.1	31.7	5.3	44.3	53.9	9.6	
Vert	7386.000	AV	33.0	36.6	8.4	32.7	-	45.3	53.9	8.6	Floor noise
Vert	9848.000	AV	31.4	39.1	9.4	33.4	-	46.5	53.9	7.4	Floor noise

Result = Reading + Ant Factor + Loss (Cable+Attenuator+Filter+Distance factor(above 1 GHz)) - Gain(Amplifier) + Duty factor

\*Other frequency noises omitted in this report were not seen or had enough margin (more than 20 dB).

Distance factor: 1 GHz - 10 GHz 20log (4 m / 3.0 m) = 2.5 dB  
10 GHz - 26.5 GHz 20log (1.0 m / 3.0 m) = -9.5 dB

\*1) Not Out of Band emission(Leakage Power)



**Radiated Spurious Emission**  
**(Reference Plot for band-edge)**

Report No. 12717687H  
Test place Ise EMC Lab.  
Semi Anechoic Chamber No.3  
Date February 4, 2019  
Temperature / Humidity 22 deg. C / 32 % RH  
Engineer Tomohisa Nakagawa  
(1 GHz - 10 GHz)  
Mode Tx 11g 2462 MHz

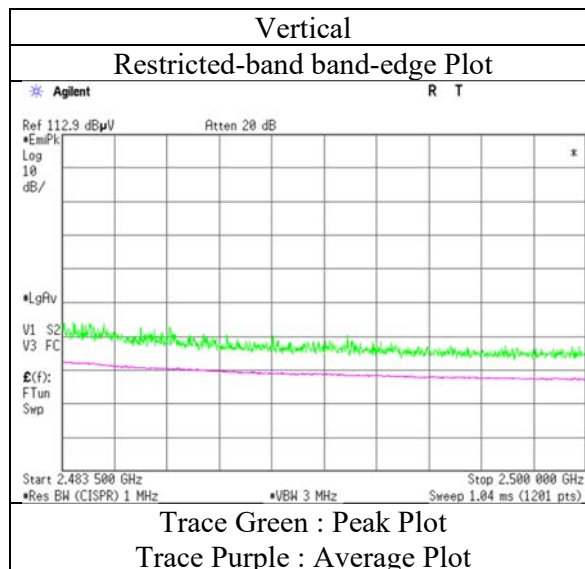
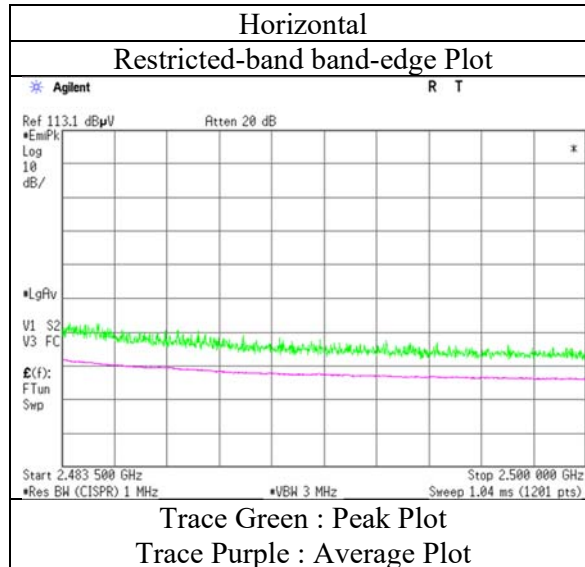

\* The measurement was conducted for a sufficiently long enough time to detect any possible spurious emissions.  
Final result of restricted band edge was shown in tabular data.

## Radiated Spurious Emission

Report No.	12717687H	
Test place	Ise EMC Lab.	
Semi Anechoic Chamber	No.3	No.4
Date	February 4, 2019	April 8, 2019
Temperature / Humidity	22 deg. C / 32 % RH	20 deg. C / 40 % RH
Engineer	Tomohisa Nakagawa	Yuta Moriya
	(1 GHz - 10 GHz)	(10 GHz - 26.5 GHz)
Mode	Tx 11n-20 2412 MHz	

Polarity	Frequency [MHz]	Detector	Reading [dBuV]	Ant.Fac. [dB/m]	Loss [dB]	Gain [dB]	Duty Factor [dB]	Result [dBuV/m]	Limit [dBuV/m]	Margin [dB]	Remark
Hori.	2390.000	PK	58.3	27.6	5.8	31.4	-	60.4	73.9	13.5	
Hori.	4824.000	PK	40.4	31.4	7.2	30.6	-	48.4	73.9	25.5	Floor noise
Hori.	7236.000	PK	42.0	36.2	8.6	31.9	-	54.9	73.9	19.0	Floor noise
Hori.	9648.000	PK	42.0	38.0	9.5	32.1	-	57.4	73.9	16.5	Floor noise
Hori.	2390.000	AV	43.5	27.6	5.8	31.4	5.2	50.8	53.9	3.1	*1)
Hori.	4824.000	AV	32.0	31.4	7.2	30.6	-	40.0	53.9	13.9	Floor noise
Hori.	7236.000	AV	31.9	36.2	8.6	31.9	-	44.8	53.9	9.1	Floor noise
Hori.	9648.000	AV	31.1	38.0	9.5	32.1	-	46.5	53.9	7.4	Floor noise
Vert.	2390.000	PK	56.8	27.6	5.8	31.4	-	58.9	73.9	15.0	
Vert.	4824.000	PK	40.7	31.4	7.2	30.6	-	48.7	73.9	25.2	Floor noise
Vert.	7236.000	PK	42.2	36.2	8.6	31.9	-	55.1	73.9	18.8	Floor noise
Vert.	9648.000	PK	42.6	38.0	9.5	32.1	-	58.0	73.9	15.9	Floor noise
Vert.	2390.000	AV	43.0	27.6	5.8	31.4	5.2	50.3	53.9	3.6	*1)
Vert.	4824.000	AV	32.0	31.4	7.2	30.6	-	40.0	53.9	13.9	Floor noise
Vert.	7236.000	AV	33.1	36.2	8.6	31.9	-	46.0	53.9	7.9	Floor noise
Vert.	9648.000	AV	31.2	38.0	9.5	32.1	-	46.6	53.9	7.3	Floor noise

Result = Reading + Ant Factor + Loss (Cable+Attenuator+Filter+Distance factor(above 1 GHz)) - Gain(Amplifier) + Duty factor

\*Other frequency noises omitted in this report were not seen or had enough margin (more than 20 dB).

Distance factor: 1 GHz - 10 GHz 20log (4 m / 3.0 m) = 2.5 dB  
10 GHz - 26.5 GHz 20log (1.0 m / 3.0 m) = -9.5 dB

### 20dBc Data Sheet

Polarity	Frequency [MHz]	Detector	Reading [dBuV]	Ant Factor [dB/m]	Loss [dB]	Gain [dB]	Result [dBuV/m]	Limit [dBuV/m]	Margin [dB]	Remark
Hori	2412.000	PK	97.0	27.7	5.7	32.7	97.7	-	-	Carrier
Hori	2400.000	PK	63.5	27.8	5.7	32.7	64.3	77.7	13.4	
Vert	2412.000	PK	96.2	27.7	5.7	32.7	96.9	-	-	Carrier
Vert	2400.000	PK	63.4	27.8	5.7	32.7	64.2	76.9	12.7	

Result = Reading + Ant Factor + Loss (Cable+Attenuator+Filter+Distance factor(above 1 GHz)) - Gain(Amplifier)

Distance factor: 1 GHz - 10 GHz 20log (4.0 m / 3.0 m) = 2.5 dB

**Radiated Spurious Emission  
(Reference Plot for band-edge)**

Report No. 12717687H  
Test place Ise EMC Lab.  
Semi Anechoic Chamber No.3  
Date February 4, 2019  
Temperature / Humidity 22 deg. C / 32 % RH  
Engineer Tomohisa Nakagawa  
(1 GHz - 10 GHz)  
Mode Tx 11n-20 2412 MHz

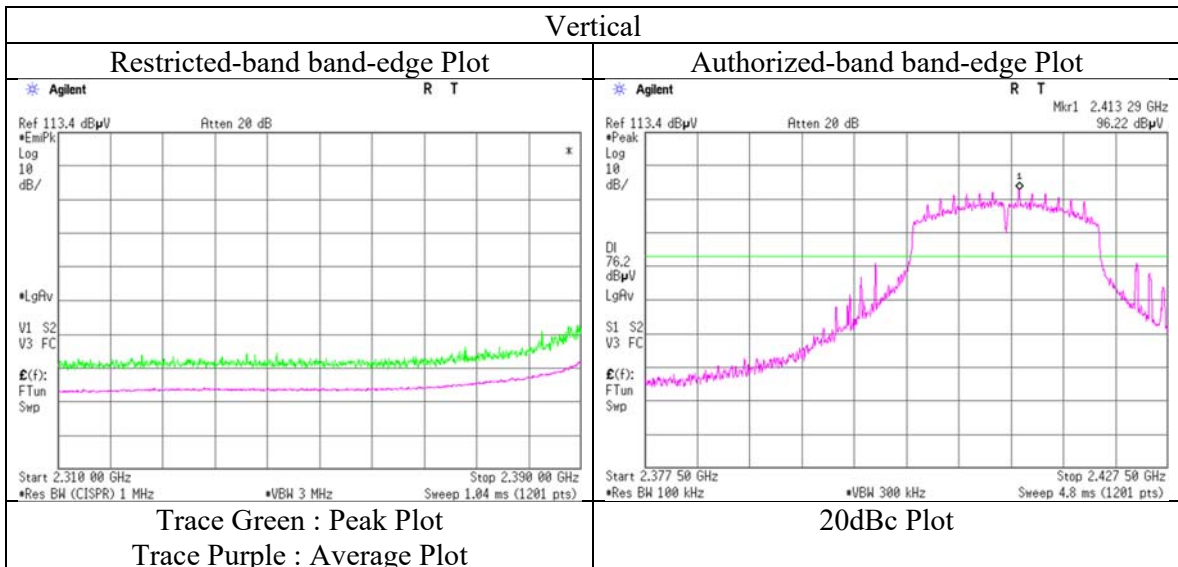
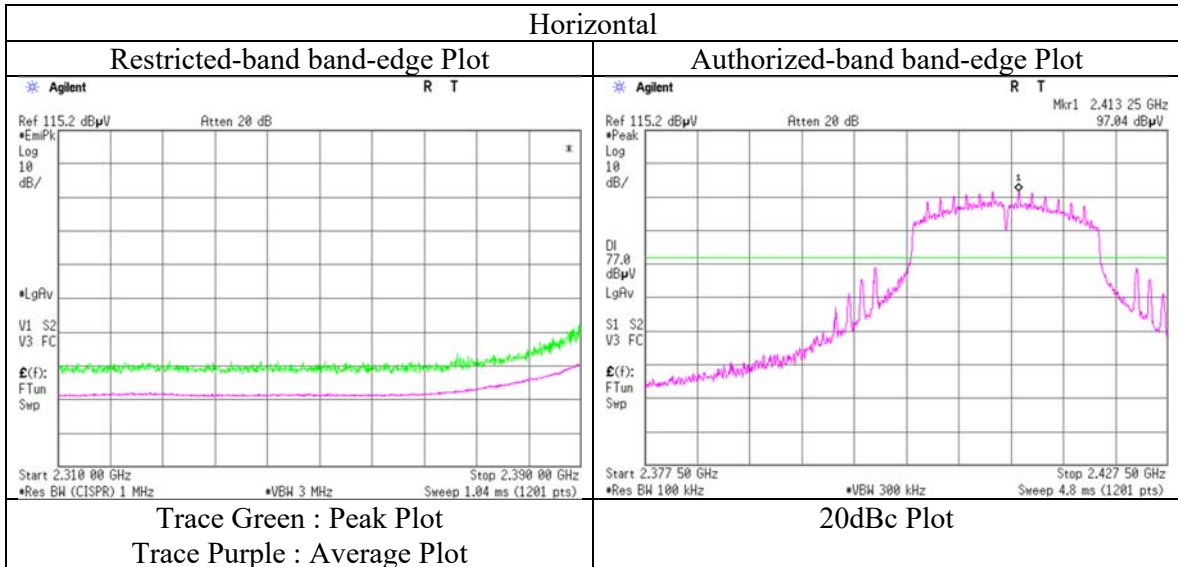

\* The measurement was conducted for a sufficiently long enough time to detect any possible spurious emissions.  
Final result of restricted band edge was shown in tabular data.

## Radiated Spurious Emission

Report No. 12717687H  
 Test place Ise EMC Lab.  
 Semi Anechoic Chamber No.4  
 Date April 8, 2019  
 Temperature / Humidity 20 deg. C / 40 % RH  
 Engineer Yuta Moriya  
 (1 GHz - 10 GHz)  
 Mode Tx 11n-20 2417 MHz

Polarity	Frequency [MHz]	Detector	Reading [dBuV]	Ant.Fac. [dB/m]	Loss [dB]	Gain [dB]	Duty Factor [dB]	Result [dBuV/m]	Limit [dBuV/m]	Margin [dB]	Remark
Hori.	2390.000	PK	58.9	27.6	5.8	31.4	-	60.9	73.9	13.0	
Hori.	2390.000	AV	41.3	27.6	5.8	31.4	5.2	48.6	53.9	5.3	*1)
Vert.	2390.000	PK	61.0	27.6	5.8	31.4	-	63.1	73.9	10.8	
Vert.	2390.000	AV	43.4	27.6	5.8	31.4	5.2	50.7	53.9	3.2	*1)

Result = Reading + Ant Factor + Loss (Cable+Attenuator+Filter+Distance factor(above 1 GHz)) - Gain(Amplifier) + Duty factor

### 20dBc Data Sheet

Polarity	Frequency [MHz]	Detector	Reading [dBuV]	Ant Factor [dB/m]	Loss [dB]	Gain [dB]	Result [dBuV/m]	Limit [dBuV/m]	Margin [dB]	Remark
Hori.	2412.000	PK	99.0	27.5	5.8	31.3	101.0	-	-	Carrier
Hori.	2400.000	PK	65.3	27.6	5.8	31.3	67.4	81.0	13.7	
Vert.	2417.000	PK	98.7	27.5	5.8	31.3	100.7	-	-	Carrier
Vert.	2400.000	PK	65.0	27.6	5.8	31.3	67.1	80.7	13.6	

Result = Reading + Ant Factor + Loss (Cable+Attenuator+Filter+Distance factor(above 1 GHz)) - Gain(Amplifier)

## Radiated Spurious Emission

Report No.	12717687H	
Test place	Ise EMC Lab.	
Semi Anechoic Chamber	No.3	No.4
Date	February 4, 2019	April 8, 2019
Temperature / Humidity	22 deg. C / 32 % RH	20 deg. C / 40 % RH
Engineer	Tomohisa Nakagawa	Yuta Moriya
	(1 GHz - 10 GHz)	(10 GHz - 26.5 GHz)
Mode	Tx 11n-20 2437 MHz	

Polarity	Frequency [MHz]	Detector	Reading [dBuV]	Ant.Fac. [dB/m]	Loss [dB]	Gain [dB]	Duty Factor [dB]	Result [dBuV/m]	Limit [dBuV/m]	Margin [dB]	Remark
Hori.	4874.000	PK	42.6	31.5	7.3	30.6	-	50.7	73.9	23.2	Floor noise
Hori.	7311.000	PK	41.8	36.3	8.6	31.9	-	54.8	73.9	19.1	Floor noise
Hori.	9748.000	PK	41.0	38.3	9.6	32.1	-	56.7	73.9	17.2	Floor noise
Hori.	4874.000	AV	31.9	31.5	7.3	30.6	-	40.0	53.9	13.9	Floor noise
Hori.	7311.000	AV	32.8	36.3	8.6	31.9	-	45.8	53.9	8.1	Floor noise
Hori.	9748.000	AV	30.9	38.3	9.6	32.1	-	46.6	53.9	7.3	Floor noise
Vert.	4874.000	PK	41.4	31.5	7.3	30.6	-	49.5	73.9	24.4	Floor noise
Vert.	7311.000	PK	42.5	36.3	8.6	31.9	-	55.5	73.9	18.4	Floor noise
Vert.	9748.000	PK	41.5	38.3	9.6	32.1	-	57.2	73.9	16.7	Floor noise
Vert.	4874.000	AV	32.2	31.5	7.3	30.6	-	40.3	53.9	13.6	Floor noise
Vert.	7311.000	AV	32.7	36.3	8.6	31.9	-	45.7	53.9	8.2	Floor noise
Vert.	9748.000	AV	31.6	38.3	9.6	32.1	-	47.3	53.9	6.6	Floor noise

Result = Reading + Ant Factor + Loss (Cable+Attenuator+Filter+Distance factor(above 1 GHz)) - Gain(Amplifier)

\*Other frequency noises omitted in this report were not seen or had enough margin (more than 20 dB).

Distance factor:    1 GHz - 10 GHz    20log (4 m / 3.0 m) = 2.5 dB  
                          10 GHz - 26.5 GHz 20log (1.0 m / 3.0 m) = -9.5 dB

## Radiated Spurious Emission

Report No. 12717687H  
 Test place Ise EMC Lab.  
 Semi Anechoic Chamber No.3  
 Date February 4, 2019  
 Temperature / Humidity 22 deg. C / 32 % RH  
 Engineer Tomohisa Nakagawa  
 (1 GHz - 10 GHz)  
 Mode Tx 11n-20 2457 MHz

Polarity	Frequency [MHz]	Detector	Reading [dBuV]	Ant.Fac. [dB/m]	Loss [dB]	Gain [dB]	Duty Factor [dB]	Result [dBuV/m]	Limit [dBuV/m]	Margin [dB]	Remark
Hori	2483.500	PK	61.0	27.5	5.7	32.7	-	61.5	73.9	12.4	
Hori	2483.500	AV	46.1	27.5	5.7	32.7	5.2	51.8	53.9	2.1	*1)
Vert	2483.500	PK	60.7	27.5	5.7	32.7	-	61.2	73.9	12.7	
Vert	2483.500	AV	45.7	27.5	5.7	32.7	5.2	51.4	53.9	2.5	*1)

Result = Reading + Ant Factor + Loss (Cable+Attenuator+Filter+Distance factor(above 1 GHz)) - Gain(Amplifier) + Duty factor

\*Other frequency noises omitted in this report were not seen or had enough margin (more than 20 dB).

Distance factor: 1 GHz - 10 GHz 20log (4 m / 3.0 m) = 2.5 dB

\*1) Not Out of Band emission(Leakage Power)

**UL Japan, Inc.**

**Ise EMC Lab.**

4383-326 Asama-cho, Ise-shi, Mie-ken 516-0021 JAPAN

Telephone : +81 596 24 8999

Facsimile : +81 596 24 8124

## Radiated Spurious Emission

Report No.	12717687H		
Test place	Ise EMC Lab.		
Semi Anechoic Chamber	No.3	No.4	
Date	February 4, 2019	April 8, 2019	
Temperature / Humidity	22 deg. C / 32 % RH	20 deg. C / 40 % RH	
Engineer	Tomohisa Nakagawa	Yuta Moriya	
	(1 GHz - 10 GHz)	(10 GHz - 26.5 GHz)	
Mode	Tx 11n-20 2462 MHz		

Polarity	Frequency [MHz]	Detector	Reading [dBuV]	Ant.Fac. [dB/m]	Loss [dB]	Gain [dB]	Duty Factor [dB]	Result [dBuV/m]	Limit [dBuV/m]	Margin [dB]	Remark
Hori.	2483.500	PK	60.0	27.5	5.9	31.3	-	62.1	73.9	11.8	
Hori.	4924.000	PK	41.3	31.6	7.3	30.6	-	49.5	73.9	24.4	Floor noise
Hori.	7386.000	PK	42.6	36.3	8.6	31.9	-	55.6	73.9	18.3	Floor noise
Hori.	9848.000	PK	42.2	38.4	9.6	32.2	-	58.0	73.9	15.9	Floor noise
Hori.	2483.500	AV	44.8	27.5	5.9	31.3	5.2	52.1	53.9	1.8	*1)
Hori.	4924.000	AV	31.7	31.6	7.3	30.6	-	39.9	53.9	14.0	Floor noise
Hori.	7386.000	AV	33.4	36.3	8.6	31.9	-	46.4	53.9	7.5	Floor noise
Hori.	9848.000	AV	30.8	38.4	9.6	32.2	-	46.6	53.9	7.3	Floor noise
Vert.	2483.500	PK	59.4	27.5	5.9	31.3	-	61.5	73.9	12.4	
Vert.	4924.000	PK	41.1	31.6	7.3	30.6	-	49.3	73.9	24.6	Floor noise
Vert.	7386.000	PK	42.4	36.3	8.6	31.9	-	55.4	73.9	18.5	Floor noise
Vert.	9848.000	PK	43.0	38.4	9.6	32.2	-	58.8	73.9	15.1	Floor noise
Vert.	2483.500	AV	43.5	27.5	5.9	31.3	5.2	50.8	53.9	3.1	*1)
Vert.	4924.000	AV	32.6	31.6	7.3	30.6	-	40.8	53.9	13.1	Floor noise
Vert.	7386.000	AV	33.6	36.3	8.6	31.9	-	46.6	53.9	7.3	Floor noise
Vert.	9848.000	AV	30.8	38.4	9.6	32.2	-	46.6	53.9	7.3	Floor noise

Result = Reading + Ant Factor + Loss (Cable+Attenuator+Filter+Distance factor(above 1 GHz)) - Gain(Amplifier) + Duty factor

\*Other frequency noises omitted in this report were not seen or had enough margin (more than 20 dB).

Distance factor:    1 GHz - 10 GHz    20log (4 m / 3.0 m) = 2.5 dB  
                          10 GHz - 26.5 GHz 20log (1.0 m / 3.0 m) = -9.5 dB

\*1) Not Out of Band emission(Leakage Power)

**Radiated Spurious Emission**  
**(Reference Plot for band-edge)**

Report No. 12717687H  
Test place Ise EMC Lab.  
Semi Anechoic Chamber No.3  
Date February 4, 2019  
Temperature / Humidity 22 deg. C / 32 % RH  
Engineer Tomohisa Nakagawa  
(1 GHz - 10 GHz)  
Mode Tx 11n-20 2462 MHz

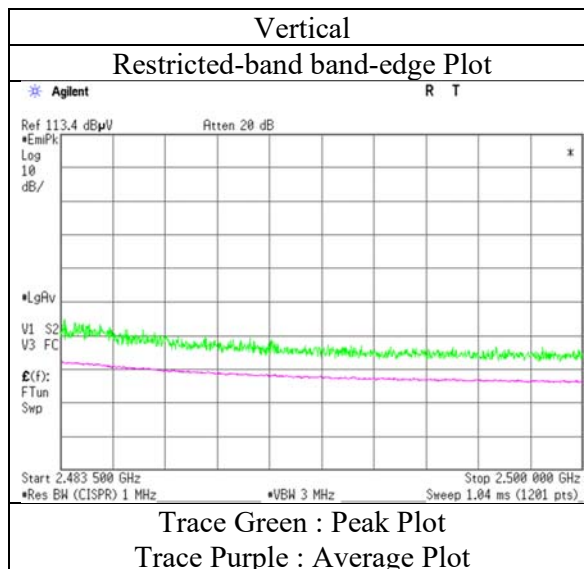
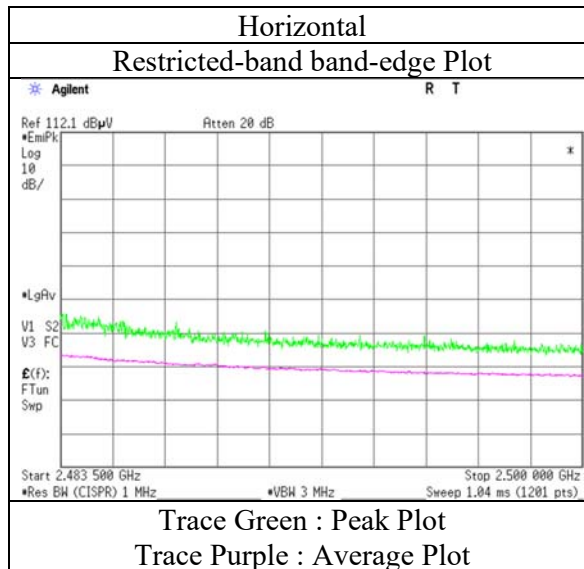

\* The measurement was conducted for a sufficiently long enough time to detect any possible spurious emissions.  
Final result of restricted band edge was shown in tabular data.



**Radiated Spurious Emission**  
**(Plot data, Worst case)**

Report No.	12717687H		
Test place	Ise EMC Lab.		
Semi Anechoic Chamber	No.3	No.3	No.3
Date	February 4, 2019	February 5, 2019	February 5, 2019
Temperature / Humidity	22 deg. C / 32 % RH	24 deg. C / 31 % RH	24 deg. C / 31 % RH
Engineer	Tomohisa Nakagawa (1 GHz - 10 GHz)	Tomohisa Nakagawa (10 GHz - 26.5 GHz)	Tomohisa Nakagawa (Below 1GHz)
Mode	Tx 11g 2437 MHz		

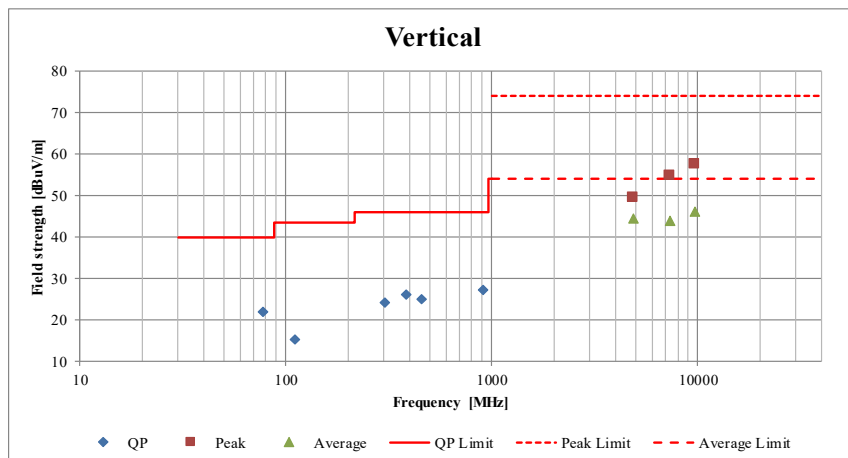
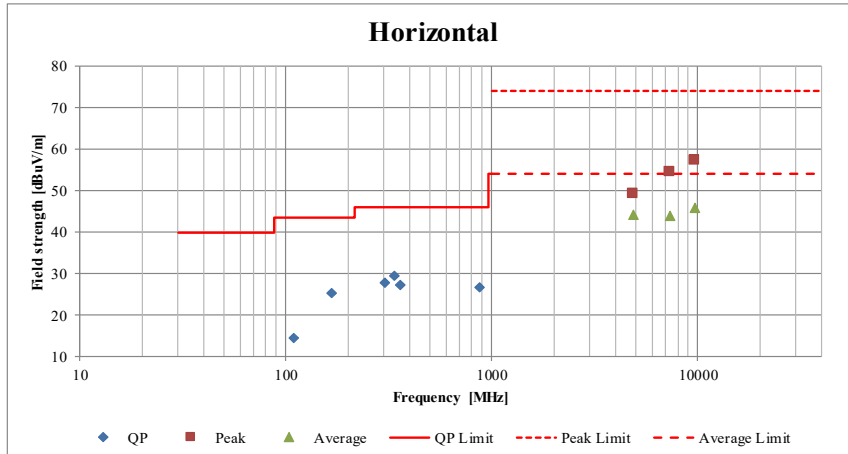

\*These plots data contains sufficient number to show the trend of characteristic features for EUT.

## Conducted Spurious Emission

Report No. 12717687H  
 Test place Ise EMC Lab. No.6 Measurement Room  
 Date February 5, 2019  
 Temperature / Humidity 23 deg. C / 32 % RH  
 Engineer Yuta Moriya  
 Mode Tx 11g 2437 MHz

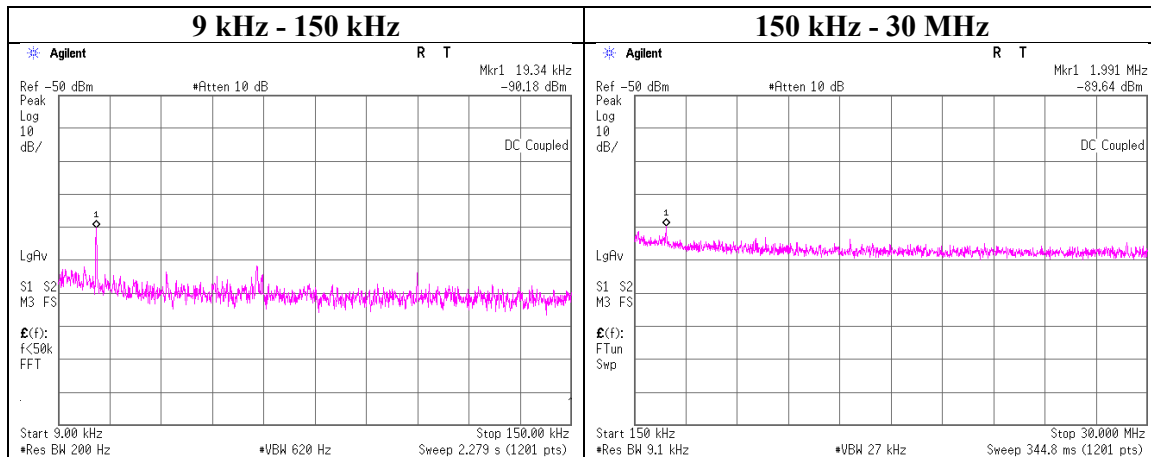

Frequency [kHz]	Reading [dBm]	Cable Loss [dB]	Attenuator Loss [dB]	Antenna Gain* [dBi]	N (Number of Output)	EIRP [dBm]	Distance [m]	Ground bounce [dB]	E (field strength) [dBuV/m]	Limit [dBuV/m]	Margin [dB]	Remark
19.34	-90.2	0.75	9.8	2.0	1	-77.6	300	6.0	-16.3	41.8	58.1	
1991.00	-89.6	0.75	9.8	2.0	1	-77.1	30	6.0	4.2	29.5	25.4	

$E \text{ [dBuV/m]} = \text{EIRP [dBm]} - 20 \log (\text{Distance [m]}) + \text{Ground bounce [dB]} + 104.8 \text{ [dBuV/m]}$

$\text{EIRP [dBm]} = \text{Reading [dBm]} + \text{Cable loss [dB]} + \text{Attenuator Loss [dB]} + \text{Antenna gain [dBi]} + 10 * \log (N)$

N: Number of output

\*2.0 dBi was applied to the test result based on KDB 558074 since antenna gain was less than 2.0 dBi.

**UL Japan, Inc.**

**Ise EMC Lab.**

4383-326 Asama-cho, Ise-shi, Mie-ken 516-0021 JAPAN

Telephone : +81 596 24 8999

Facsimile : +81 596 24 8124

### Power Density

Report No. 12717687H  
Test place Ise EMC Lab. No.6 Measurement Room  
Date February 5, 2019  
Temperature / Humidity 23 deg. C / 32 % RH  
Engineer Yuta Moriya  
Mode Tx 11b

11b

Freq. [MHz]	Reading [dBm]	Cable Loss [dB]	Atten. Loss [dB]	Result [dBm]	Limit [dBm]	Margin [dB]
2412.00	-26.60	0.75	19.98	-5.87	8.00	13.87
2417.00	-26.22	0.75	19.98	-5.49	8.00	13.49
2437.00	-26.04	0.75	19.98	-5.31	8.00	13.31
2457.00	-26.36	0.75	19.98	-5.63	8.00	13.63
2462.00	-26.08	0.75	19.98	-5.35	8.00	13.35

Sample Calculation:

Result = Reading + Cable Loss (including the cable(s) customer supplied) + Attenuator Loss

**Power Density**

11b

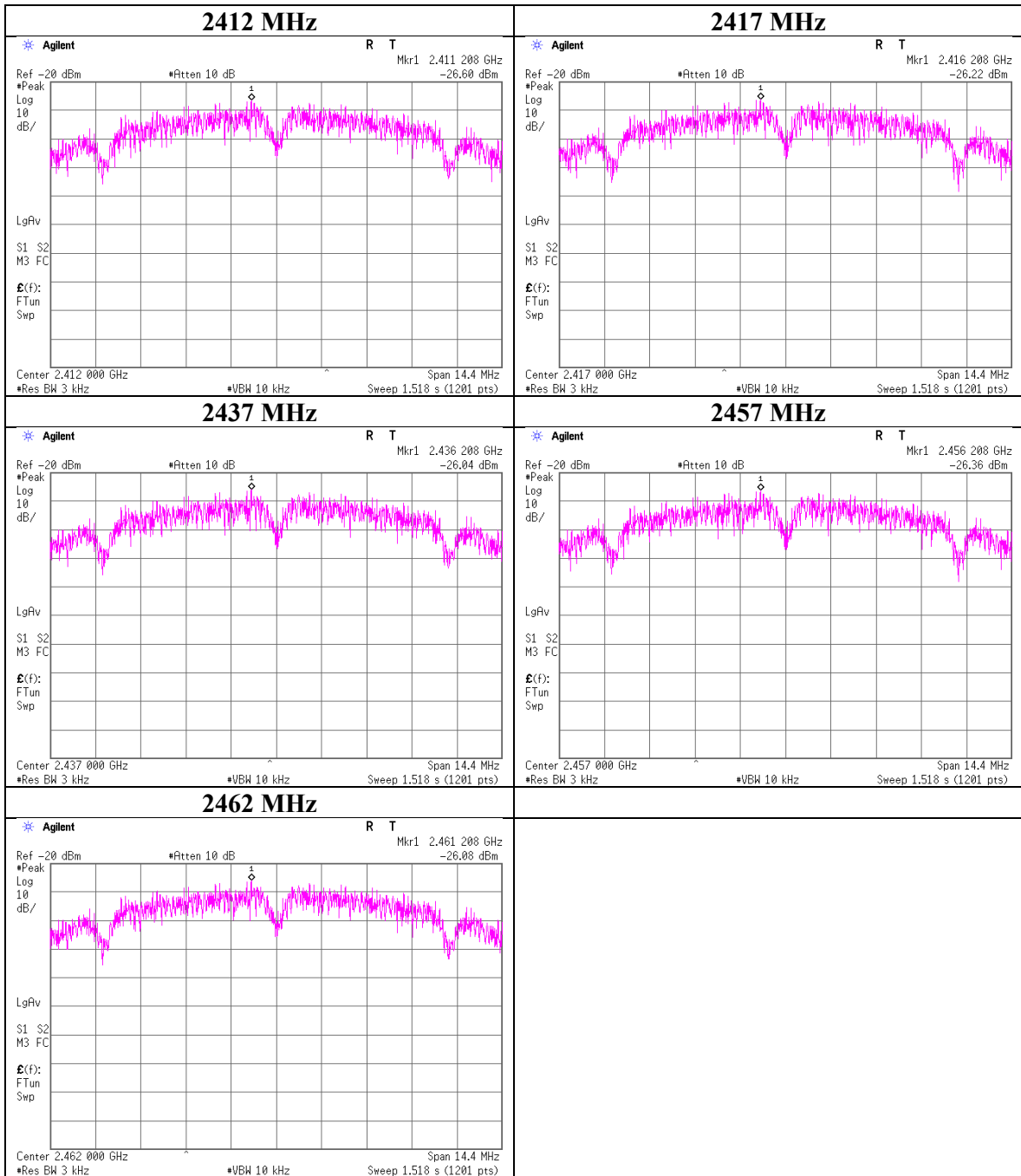

### Power Density

Report No. 12717687H  
Test place Ise EMC Lab. No.6 Measurement Room  
Date February 5, 2019  
Temperature / Humidity 23 deg. C / 32 % RH  
Engineer Yuta Moriya  
Mode Tx 11g

11g

Freq. [MHz]	Reading [dBm]	Cable Loss [dB]	Atten. Loss [dB]	Result [dBm]	Limit [dBm]	Margin [dB]
2412.00	-35.70	0.75	19.98	-14.97	8.00	22.97
2417.00	-31.26	0.75	19.98	-10.53	8.00	18.53
2437.00	-31.48	0.75	19.98	-10.75	8.00	18.75
2457.00	-31.14	0.75	19.98	-10.41	8.00	18.41
2462.00	-35.66	0.75	19.98	-14.93	8.00	22.93

Sample Calculation:

Result = Reading + Cable Loss (including the cable(s) customer supplied) + Attenuator Loss

**Power Density**

**11g**

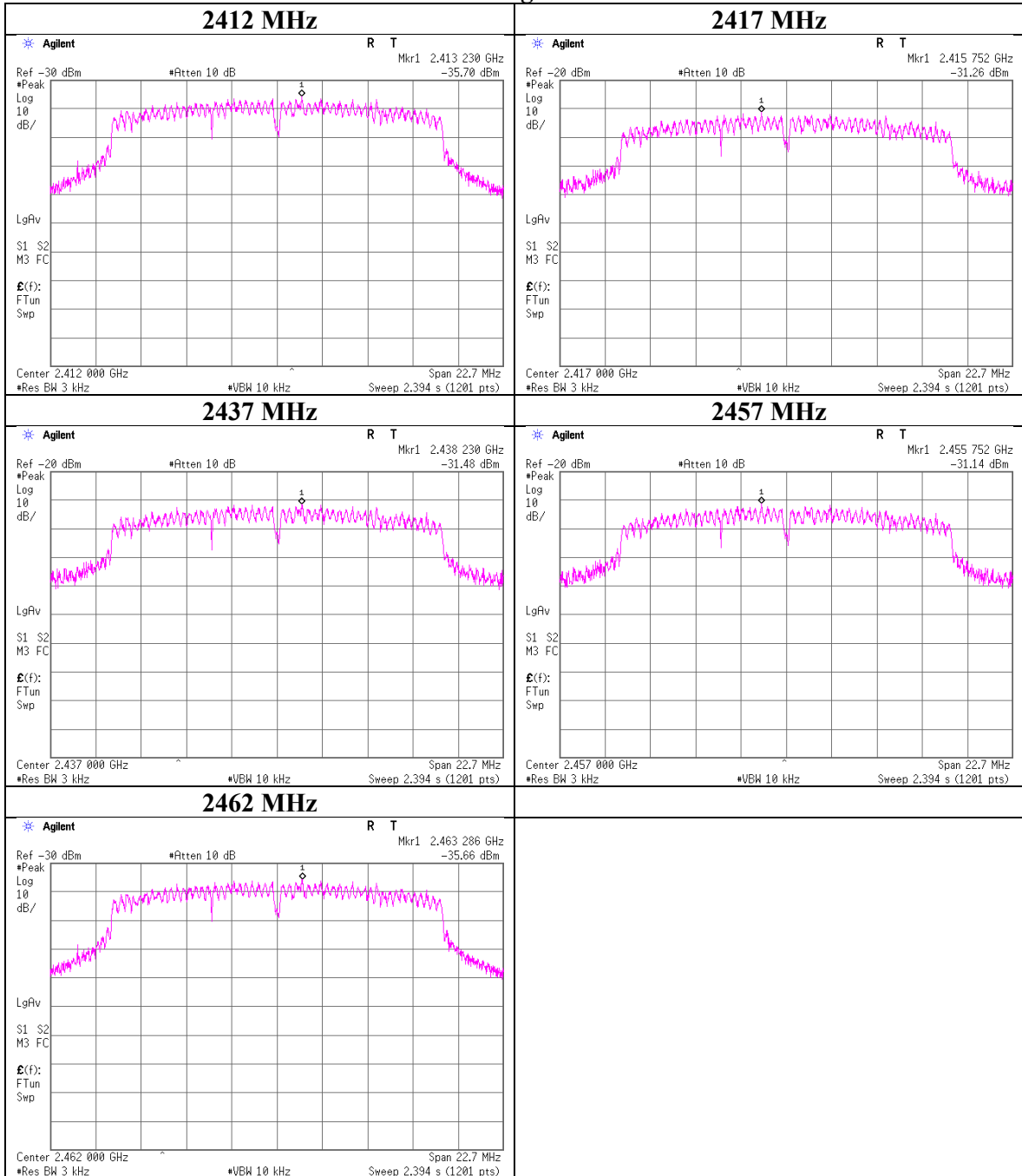

### Power Density

Report No. 12717687H  
Test place Ise EMC Lab. No.6 Measurement Room  
Date February 5, 2019  
Temperature / Humidity 23 deg. C / 32 % RH  
Engineer Yuta Moriya  
Mode Tx 11n-20

11n-20

Freq. [MHz]	Reading [dBm]	Cable Loss [dB]	Atten. Loss [dB]	Result [dBm]	Limit [dBm]	Margin [dB]
2412.00	-35.28	0.75	19.98	-14.55	8.00	22.55
2417.00	-31.94	0.75	19.98	-11.21	8.00	19.21
2437.00	-31.42	0.75	19.98	-10.69	8.00	18.69
2457.00	-31.62	0.75	19.98	-10.89	8.00	18.89
2462.00	-34.72	0.75	19.98	-13.99	8.00	21.99

Sample Calculation:

Result = Reading + Cable Loss (including the cable(s) customer supplied) + Attenuator Loss

**Power Density**

**11n-20**

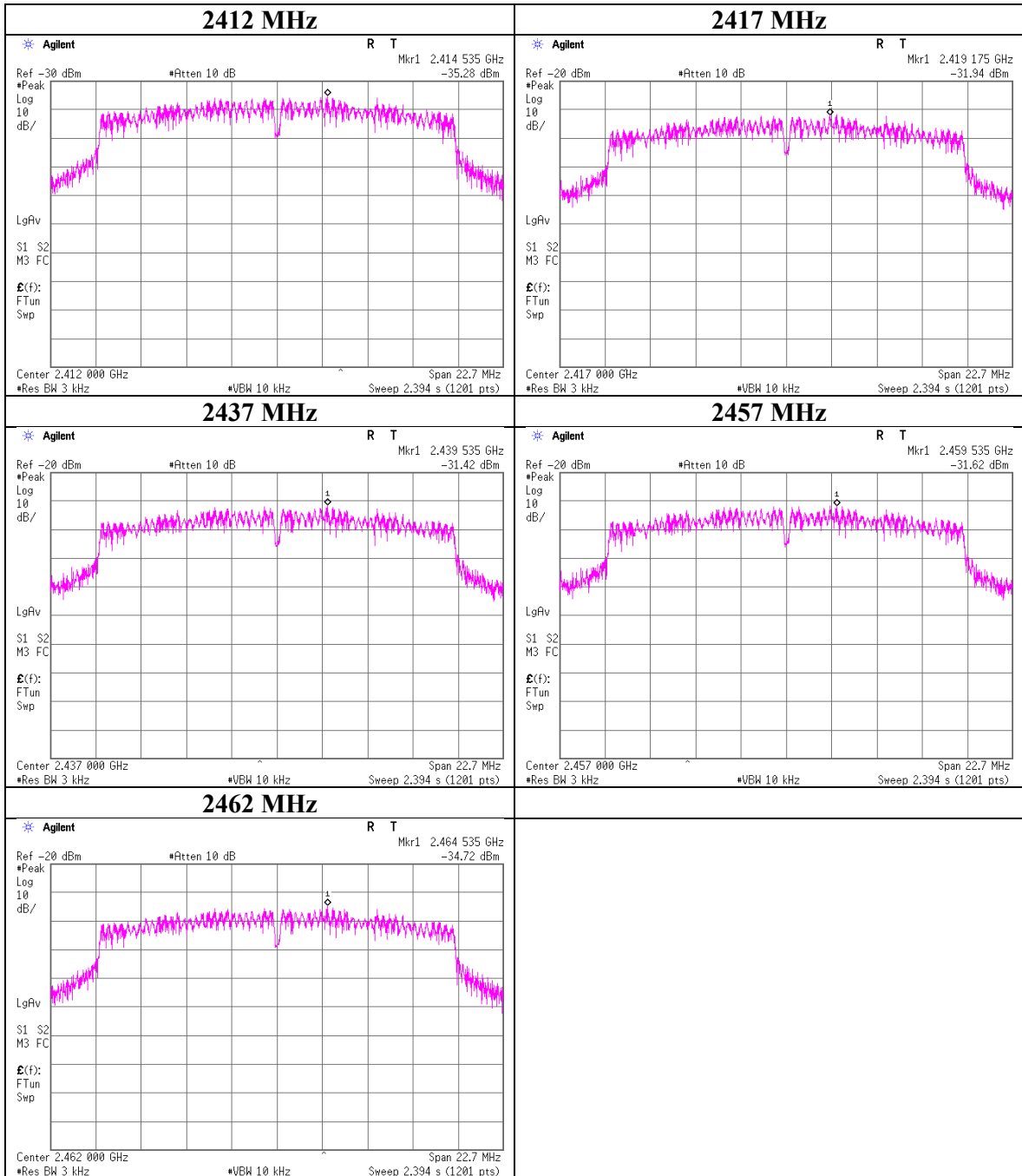



**APPENDIX 2: Test instruments**

**Test Instruments (1/2)**

Test Item	LIMS ID	Description	Manufacturer	Model	Serial	Last Calibration Date	Calibration Due Date	Cal Int
RE	141232	High Pass Filter 3.5-18.0GHz	UL Japan	HPF SELECTOR	001	09/19/2018	09/30/2019	12
RE	142008	AC3_Semi Anechoic Chamber(NSA)	TDK	Semi Anechoic Chamber 3m	DA-10005	06/26/2018	06/30/2020	24
RE	141392	Microwave Cable	Junkosha	MWX221	1604S253(1 m) 1608S087(5 m)	08/08/2018	08/31/2019	12
RE	141507	Horn Antenna 1-18GHz	Schwarzbeck	BBHA9120D	258	06/07/2018	06/30/2019	12
AT	141568	Thermo-Hygrometer	CUSTOM	CTH-201	2901	01/11/2019	01/31/2020	12
AT	141547	DIGITAL HiTESTER	HIOKI	3805	60500120	02/25/2019	02/29/2020	12
AT	141561	Thermo-Hygrometer	CUSTOM	CTH-201	1401	01/11/2019	01/31/2020	12
AT	141174	Attenuator(20dB) (above1GHz)	HIROSE ELECTRIC CO.,LTD.	AT-120	901247	01/10/2019	01/31/2020	12
AT	141173	Attenuator(10dB) (above1GHz)	HIROSE ELECTRIC CO.,LTD.	AT-110	-	12/17/2018	12/31/2019	12
AT	141842	Power sensor	AGILENT	N1923A	MY54070003	08/21/2018	08/31/2019	12
AT	141812	Power Meter	AGILENT	8990B	MY51000271	08/21/2018	08/31/2019	12
AT	141832	Power sensor	ANRITSU	MA2411B	738174	10/09/2018	10/31/2019	12
AT	141810	Power Meter	ANRITSU	ML2495A	824014	10/09/2018	10/31/2019	12
AT	141899	Spectrum Analyzer	AGILENT	E4448A	MY46180655	08/10/2018	08/31/2019	12
RE	141580	MicroWave System Amplifier	AGILENT	83017A	MY39500779	03/05/2019	03/31/2020	12
RE	141902	Spectrum Analyzer	AGILENT	E4440A	MY46187105	10/04/2018	10/31/2019	12
RE	141532	DIGITAL HiTESTER	HIOKI	3805	51201197	01/29/2019	01/31/2020	12
RE	141554	Thermo-Hygrometer	CUSTOM	CTH-180	1301	01/11/2019	01/31/2020	12
RE	142013	AC3_Semi Anechoic Chamber(SVSWR)	TDK	Semi Anechoic Chamber 3m	DA-10005	04/06/2018	04/30/2019	12
RE	142237	Antenna Tilt Jig	Intelligent System Engineering Co., Ltd	Antenna Tilt Jig	T-0002	-	-	-
RE,CE	141936	Terminator	TME	CT-01BP	-	12/05/2018	12/31/2019	12
RE,CE	141358	LISN(AMN)	Schwarzbeck	NSLK8127	8127-730	07/25/2018	07/31/2019	12
RE,CE	141248	Attenuator	JFW Industries, Inc.	50FP-013H2 N	-	12/06/2018	12/31/2019	12
RE,CE	141357	LISN(AMN)	Schwarzbeck	NSLK8127	8127-729	07/24/2018	07/31/2019	12
RE,CE	141216	Coaxial cable	Fujikura/Suhner/TSJ	5D-2W/SFM14/ sucoform141-PE/421-010	-/00640	07/03/2018	07/31/2019	12
RE,CE	141949	Test Receiver	Rohde & Schwarz	ESCI	100767	08/06/2018	08/31/2019	12
RE	141266	Logperiodic Antenna (200-1000MHz)	Schwarzbeck	VUSLP9111B	911B-191	03/25/2019	03/31/2020	12
RE	141424	Biconical Antenna	Schwarzbeck	BBA9106	1915	06/04/2018	06/30/2019	12
RE	141247	Attenuator(13dB)	JFW Industries, Inc.	50FP-013H2 N	-	12/06/2018	12/31/2019	12
RE	148897	Attenuator	KEYSIGHT	8491A	MY52462349	12/20/2018	12/31/2019	12
RE	141323	Coaxial cable	UL Japan	-	-	07/03/2018	07/31/2019	12
RE	141513	Horn Antenna 15-40GHz	Schwarzbeck	BBHA9170	BBHA9170306	06/07/2018	06/30/2019	12
RE	141945	Torque wrench	Huber+Suhner	74 Z-0-0-21	98142	01/23/2018	01/31/2021	36
RE	141582	Pre Amplifier	SONOMA INSTRUMENT	310	260834	02/08/2019	02/29/2020	12
RE	141508	Horn Antenna 1-18GHz	Schwarzbeck	BBHA9120D	9120D-557	06/08/2018	06/30/2019	12
RE	141412	Microwave Cable	Junkosha	MWX221	1305S002R(1m) / 1405S146(5m)	06/14/2018	06/30/2019	12
RE	141296	High Pass Filter 3.5-18.0GHz	UL Japan	HPF SELECTOR	002	09/19/2018	09/30/2019	12

**Test Instruments (2/2)**

Test Item	LIMS ID	Description	Manufacturer	Model	Serial	Last Calibration Date	Calibration Due Date	Cal Int
RE	141581	MicroWave System Amplifier	AGILENT	83017A	650	10/04/2018	10/31/2019	12
RE	141506	Horn Antenna 15-40GHz	Schwarzbeck	BBHA9170	BBHA9170307	06/08/2018	06/30/2019	12
RE	142285	Antenna Tilt Jig	Intelligent System Engineering Co., Ltd	Antenna Tilt Jig	T-0003	-	-	-
RE	141562	Thermo-Hygrometer	CUSTOM	CTH-201	0010	01/11/2019	01/31/2020	12
RE,CE	141217	Coaxial cable	Fujikura/Suhner/TSJ	5D-2W/SFM141/421-010/sucoform141-P	-/04178	06/13/2018	06/30/2019	12
RE,CE	142227	Measure	KOMELON	KMC-36	-	-	-	-
RE,CE	141545	DIGITAL HITESTER	HIOKI	3805	51201148	01/29/2019	01/31/2020	12
CE	141942	Test Receiver	Rohde & Schwarz	ESCI	100300	08/08/2018	08/31/2019	12
AT	141156	Attenuator(10dB)	Weinschel Corp	2	BL1173	11/2/2018	11/30/2019	12

\*Hyphens for Last Calibration Date, Calibration Due Date and Cal Int (month) are instruments that Calibration is not required (e.g. software), or instruments checked in advance before use.

The expiration date of the calibration is the end of the expired month.  
All equipment is calibrated with valid calibrations. Each measurement data is traceable to the national or international standards.

As for some calibrations performed after the tested dates, those test equipment have been controlled by means of an unbroken chains of calibrations.

Test item:           CE: Conducted Emission test  
                          RE: Radiated Emission test  
                          AT: Antenna Terminal Conducted test