



RADIO TEST REPORT

Test Report No. : 11469126H-C

Applicant : Murata Manufacturing Co., Ltd.
Type of Equipment : Communication Module
Model No. : Type1JS
FCC ID : VPYLB1JS955
Test regulation : FCC Part 15 Subpart E: 2016
(DFS test only)
Test Result : Complied

1. This test report shall not be reproduced in full or partial, without the written approval of UL Japan, Inc.
2. The results in this report apply only to the sample tested.
3. This sample tested is in compliance with the above regulation.
4. The test results in this report are traceable to the national or international standards.
5. This test report must not be used by the customer to claim product certification, approval, or endorsement by NVLAP, NIST, or any agency of the Federal Government.
6. This test report covers Radio technical requirements. It does not cover administrative issues such as Manual or non-Radio test related Requirements. (if applicable)

Date of test: October 21, 2016

Representative test engineer: T. Shimada
Takumi Shimada
Engineer
Consumer Technology Division

Approved by: Takayuki S.
Takayuki Shimada
Engineer
Consumer Technology Division

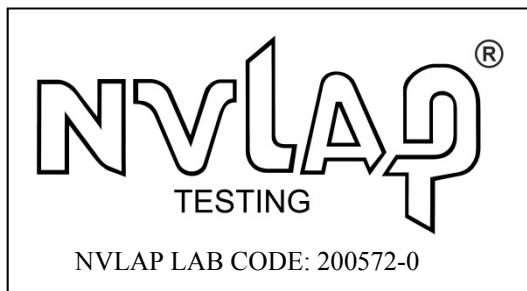

This laboratory is accredited by the NVLAP LAB CODE 200572-0, U.S.A. The tests reported herein have been performed in accordance with its terms of accreditation.
*As for the range of Accreditation in NVLAP, you may refer to the WEB address,
http://japan.ul.com/resources/emc_accredited/

UL Japan, Inc.

Ise EMC Lab.

4383-326 Asama-cho, Ise-shi, Mie-ken 516-0021 JAPAN

Telephone : +81 596 24 8999

Facsimile : +81 596 24 8124

13-EM-F0429

CONTENTS	PAGE
SECTION 1: Customer information.....	4
SECTION 2: Equipment under test (E.U.T.).....	4
SECTION 3: Scope of Report.....	6
SECTION 4: Test specification, procedures & results.....	6
SECTION 5: Operation of E.U.T. during testing.....	11
SECTION 6: Channel Move Time, Channel Closing Transmission Time.....	18
SECTION 7: Non-Occupancy Period.....	20
APPENDIX 1: Test instruments.....	22
APPENDIX 2: Photographs of test setup.....	23

UL Japan, Inc.

Ise EMC Lab.

4383-326 Asama-cho, Ise-shi, Mie-ken 516-0021 JAPAN

Telephone : +81 596 24 8999

Facsimile : +81 596 24 8124

Radio Specification

Radio Type : Transceiver
Power Supply (inner) : DC 3.0 V - 3.5 V

Specification of Wireless LAN (IEEE802.11b/g/a/n-20/n-40/11ac-20/11ac-40/11ac-80)

Type of radio	IEEE802.11b	IEEE802.11g/n (20 M band)	IEEE802.11a/n/ac (20 M band) *1)	IEEE802.11n/ac (40 M band) *1)	IEEE802.11ac (80 M band) *1)
Frequency of operation	2412 MHz - 2462 MHz	2412 MHz - 2462 MHz	5180 MHz - 5240 MHz 5260 MHz - 5320 MHz 5500 MHz - 5720 MHz 5745 MHz - 5825 MHz	5190 MHz - 5230 MHz 5270 MHz - 5310 MHz 5510 MHz - 5710 MHz 5755 MHz - 5795 MHz	5210 MHz 5290 MHz 5530 MHz - 5690 MHz 5775 MHz
Type of modulation	DSSS (CCK, DQPSK, DBPSK)	OFDM-CCK (64QAM, 16QAM, QPSK, BPSK)	OFDM (64QAM, 16QAM, QPSK, BPSK, 256QAM(IEEE802.11ac only))		
Channel spacing	5 MHz		20 MHz	40 MHz	80 MHz
Antenna type	Pattern Antenna				
Antenna Gain	2.4 GHz: 2.1 dBi 5 GHz: 2.0 dBi				

Specification of Bluetooth (Low Energy: LE)

	Bluetooth Ver.4.1 with EDR function
Frequency of operation	2402 MHz - 2480 MHz
Type of modulation	GFSK
Channel spacing	2 MHz
Antenna type	Pattern Antenna
Antenna Gain	2.1 dBi

*1) This test report applies to Wireless LAN (5GHz Band).

UL Japan, Inc.

Ise EMC Lab.

4383-326 Asama-cho, Ise-shi, Mie-ken 516-0021 JAPAN

Telephone : +81 596 24 8999

Facsimile : +81 596 24 8124

SECTION 3: Scope of Report

This report only covers DFS requirement, as specified by the following referenced procedures.

SECTION 4: Test specification, procedures & results

4.1 Test Specification

Test Specification	:	FCC Part 15 Subpart E FCC Part 15 final revised on November 14, 2016 and effective December 14, 2016
Title	:	FCC 47CFR Part15 Radio Frequency Device Subpart E Unlicensed National Information Infrastructure Devices Section 15.407 General technical requirements
Test Specification	:	KDB905462 D02 UNII DFS Compliance Procedures New Rules v02
Title	:	COMPLIANCE MEASUREMENT PROCEDURES FOR UNLICENSED- NATIONAL INFORMATION INFRASTRUCTURE DEVICES OPERATING IN THE 5250-5350MHz AND 5470-5725MHz BANDS INCORPORATING DYNAMIC FREQUENCY SELECTION
Test Specification	:	KDB905462 D03 Client Without DFS New Rules v01r02
Title	:	U-NII CLIENT DEVICES WITHOUT RADAR DETECTION CAPABILITY

* The revision on November 14, 2016, does not affect the test specification applied to the EUT.

FCC Part 15.31 (e)

The worst case stable voltage was provided to the EUT during the all tests.
And maximum and minimum voltage were provided to the EUT during the output power measurement test.
Therefore, the EUT complies with the requirement.

FCC Part 15.203/212 Antenna requirement

The antenna is not removable from the EUT.
Therefore, the equipment complies with the antenna requirement of Section 15.203.

UL Japan, Inc.

Ise EMC Lab.

4383-326 Asama-cho, Ise-shi, Mie-ken 516-0021 JAPAN

Telephone : +81 596 24 8999

Facsimile : +81 596 24 8124

4.2 Procedures and results

Table 1: Applicability of DFS Requirements

Requirement	Operating Mode	Test Procedures & Limits	Deviation	Results
	Client without Radar Detection			
U-NII Detection Bandwidth	Not required	KDB905462 D02 UNII DFS Compliance Procedures New Rules v02	N/A	N/A
Initial Channel Availability Check Time	Not required	FCC15.407 (h)	N/A	N/A
		KDB905462 D02 UNII DFS Compliance Procedures New Rules v02		
		RSS-247 6.3		
Radar Burst at the Beginning of the Channel Availability Check Time	Not required	FCC15.407 (h)	N/A	N/A
		KDB905462 D02 UNII DFS Compliance Procedures New Rules v02		
		RSS-247 6.3		
Radar Burst at the End of the Channel Availability Check Time	Not required	FCC15.407 (h)	N/A	N/A
		KDB905462 D02 UNII DFS Compliance Procedures New Rules v02		
		RSS-247 6.3		
In-Service Monitoring for Channel Move Time, Channel Closing Transmission Time	Yes	FCC15.407 (h)	N/A	Complied
		KDB905462 D02 UNII DFS Compliance Procedures New Rules v02		
		RSS-247 6.3		
In-Service Monitoring for Non-Occupancy period	Yes *	FCC15.407 (h)	N/A	Complied
		KDB905462 D02 UNII DFS Compliance Procedures New Rules v02		
		RSS-247 6.3		
Statistical Performance Check	Not required	FCC15.407 (h)	N/A	N/A
		KDB905462 D02 UNII DFS Compliance Procedures New Rules v02		

Note: UL Japan, Inc.'s EMI Work Procedures No. 13-EM-W0422.

*Although this test was not required in FCC, KDB 905462 D02, it was performed as additional test.

UL Japan, Inc.

Ise EMC Lab.

4383-326 Asama-cho, Ise-shi, Mie-ken 516-0021 JAPAN

Telephone : +81 596 24 8999

Facsimile : +81 596 24 8124

Table 2 DFS Detection Thresholds for Master Devices and Client Devices With Radar Detection

Maximum Transmit Power	Value (See Notes 1,2, and 3)
≥ 200 milliwatt	-64 dBm
< 200 milliwatt and power spectral density < 10dBm/MHz	-62 dBm
< 200 milliwatt that do not meet the power spectral density requirement	-64 dBm
<p>Note 1: This is the level at the input of the receiver assuming a 0 dBi receive antenna.</p> <p>Note 2: Throughout these test procedures an additional 1 dB has been added to the amplitude of the test transmission waveforms to account for variations in measurement equipment. This will ensure that the test signal is at or above the detection threshold level to trigger a DFS response.</p> <p>Note 3: EIRP is based on the highest antenna gain. For MIMO devices refer to KDB Publication 662911 D01.</p>	

Table 3 DFS Response Requirement Values

Parameter	Value
Non-occupancy period	Minimum 30 minutes
Channel Availability Check Time	60 seconds
Channel Move Time	10 seconds See Note 1
Channel Closing Transmission Time	200 milliseconds + an aggregate of 60 milliseconds over remaining 10 second period. See Notes 1 and 2
U-NII Detection Bandwidth	Minimum 100 % of the U-NII 99 % transmission power bandwidth See Note 3
<p>Note 1: Channel Move Time and the Channel Closing Transmission Time should be performed with Radar Type 0. The measurement timing begins at the end of the Radar Type 0 burst.</p> <p>Note 2: The Channel Closing Transmission Time is comprised of 200 milliseconds starting at the beginning of the Channel Move Time plus any additional intermittent control signals required to facilitate a Channel move (an aggregate of 60 milliseconds) during the remainder of the 10 second period. The aggregate duration of control signal will not count quiet periods in between transmissions.</p> <p>Note 3: During the U-NII Detection Bandwidth detection test, radar type 0 should be used. For each frequency step the minimum percentage of detection is 90 percent. Measurements are performed with no data traffic.</p>	

UL Japan, Inc.

Ise EMC Lab.

4383-326 Asama-cho, Ise-shi, Mie-ken 516-0021 JAPAN

Telephone : +81 596 24 8999

Facsimile : +81 596 24 8124

Table 4 Short Pulse Radar Test Waveform

Radar Type	Pulse Width (μsec)	PRI (μsec)	Number of Pulses	Minimum Percentage of Successful Detection	Minimum Number of Trials
0	1	1428	18	See Note 1	See Note 1
1	1	Test A: 15 unique PRI values randomly selected from the list of 23 PRI values in Table 5a	Roundup $\{(1/360) * (19 * 10^6 / \text{PRI}_{\mu\text{sec}})\}$	60 %	30
		Test B: 15 unique PRI values randomly selected within the range of 518-3066 μsec, with a minimum increment of 1 μsec, excluding PRI values selected in Test A			
2	1-5	150-230	23-29	60 %	30
3	6-10	200-500	16-18	60 %	30
4	11-20	200-500	12-16	60 %	30
Aggregate (Rader Types 1-4)				80 %	120
Note 1: Short Pulse Radar Type 0 should be used for the detection bandwidth test, channel move time, and channel closing time tests.					

Table 5 Long Pulse Radar Test Waveform

Radar Type	Pulse Width (μsec)	Chip Width (MHz)	PRI (μsec)	Number of Pulses per Burst	Number of Burst	Minimum Percentage of Successful Detection	Minimum Number of Trials
5	50-100	5 - 20	1000-2000	1-3	8-20	80 %	30

Table 6 Frequency Hopping Radar Test Waveform

Radar Type	Pulse Width (μsec)	PRI (μsec)	Pulse per Hop (kHz)	Hopping Rate (kHz)	Hopping Sequence Length (msec)	Minimum Percentage of Successful Detection	Minimum Number of Trials
6	1	333	9	0.333	300	70 %	30

4.3 Addition to standard

No addition, exclusion nor deviation has been made from the standard.

UL Japan, Inc.

Ise EMC Lab.

4383-326 Asama-cho, Ise-shi, Mie-ken 516-0021 JAPAN
Telephone : +81 596 24 8999
Facsimile : +81 596 24 8124

4.4 Test Location

UL Japan, Inc. Ise EMC Lab. *NVLAP Lab. code: 200572-0
4383-326 Asama-cho, Ise-shi, Mie-ken 516-0021 JAPAN
Telephone: +81 596 24 8999, Facsimile: +81 596 24 8124

Test site	IC Registration Number	Width x Depth x Height (m)	Size of reference ground plane (m) / horizontal conducting plane	Other rooms	Maximum measurement distance
No.1 semi-anechoic chamber	2973C-1	19.2 x 11.2 x 7.7	7.0 x 6.0	No.1 Power source room	10 m
No.2 semi-anechoic chamber	2973C-2	7.5 x 5.8 x 5.2	4.0 x 4.0	-	3 m
No.3 semi-anechoic chamber	2973C-3	12.0 x 8.5 x 5.9	6.8 x 5.75	No.3 Preparation room	3 m
No.3 shielded room	-	4.0 x 6.0 x 2.7	N/A	-	-
No.4 semi-anechoic chamber	2973C-4	12.0 x 8.5 x 5.9	6.8 x 5.75	No.4 Preparation room	3 m
No.4 shielded room	-	4.0 x 6.0 x 2.7	N/A	-	-
No.5 semi-anechoic chamber	-	6.0 x 6.0 x 3.9	6.0 x 6.0	-	-
No.6 shielded room	-	4.0 x 4.5 x 2.7	4.0 x 4.5	-	-
No.6 measurement room	-	4.75 x 5.4 x 3.0	4.75 x 4.15	-	-
No.7 shielded room	-	4.7 x 7.5 x 2.7	4.7 x 7.5	-	-
No.8 measurement room	-	3.1 x 5.0 x 2.7	N/A	-	-
No.9 measurement room	-	8.8 x 4.6 x 2.8	2.4 x 2.4	-	-
No.11 measurement room	-	6.2 x 4.7 x 3.0	4.8 x 4.6	-	-

* Size of vertical conducting plane (for Conducted Emission test) : 2.0 x 2.0 m for No.1, No.2, No.3, and No.4 semi-anechoic chambers and No.3 and No.4 shielded rooms.

4.5 Uncertainty

The following uncertainties have been calculated to provide a confidence level of 95% using a coverage factor $k=2$.
Time Measurement uncertainty for this test was: (\pm) 0.012%

4.6 Test instruments of DFS and Test set up

Refer to APPENDIX.

UL Japan, Inc.

Ise EMC Lab.

4383-326 Asama-cho, Ise-shi, Mie-ken 516-0021 JAPAN
Telephone : +81 596 24 8999
Facsimile : +81 596 24 8124

SECTION 5: Operation of E.U.T. during testing

5.1 Operating Modes

The EUT, which is a Client Device without Radar detection capability, operates over the W53 and W56 Band.

The channel-loading of approximately 17% or greater was used for testing, and its test data was transferred from the Master Device to the Client Device for all test configurations.

The EUT utilizes the 802.11a/n/ac architecture, with a 20MHz, 40MHz and 80MHz channel bandwidth.

The FCC ID for the Master Device used with EUT for DFS testing is LDK102087.

The rated output power of the Master unit is >200mW(23dBm). Therefore the required interference threshold level is -64 dBm. After correction for antenna gain and procedural adjustments, the required conducted threshold at the antenna port is $-64 + 1 + 0 = -63.0$ dBm (threshold level + additional 1dB + antenna gain).

It is impossible for users to change DFS control, because the DFS function is written on the firmware and users cannot access it.

The EUT was set by the software as follows:

Software name: iPerf

UL Japan, Inc.

Ise EMC Lab.

4383-326 Asama-cho, Ise-shi, Mie-ken 516-0021 JAPAN

Telephone : +81 596 24 8999

Facsimile : +81 596 24 8124

5.2 Configuration and peripherals

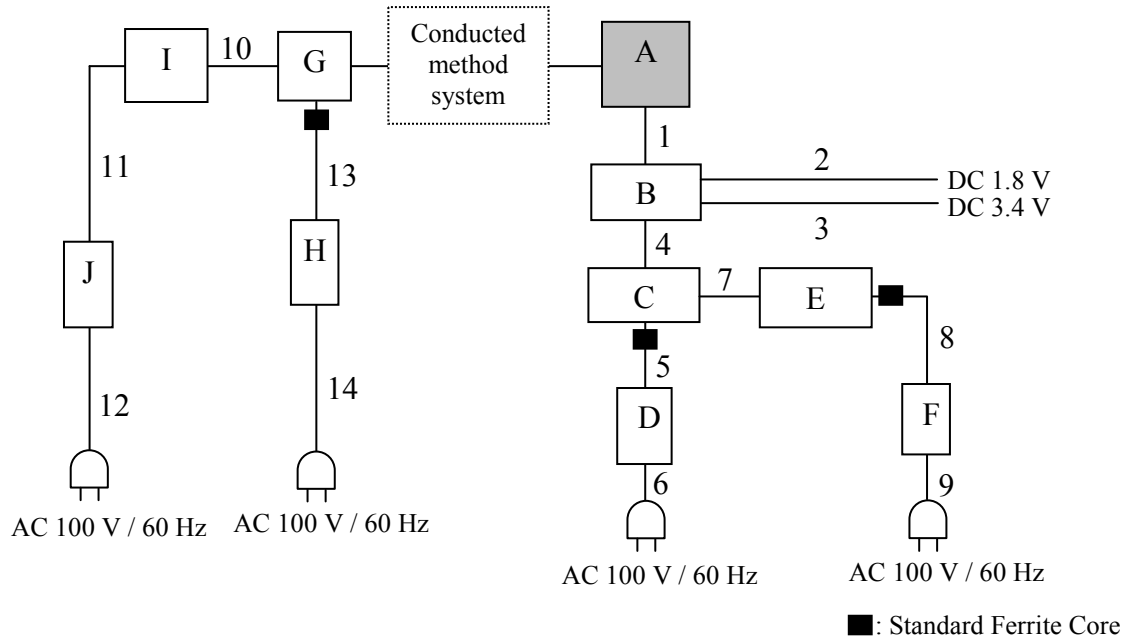

UL Japan, Inc.

Ise EMC Lab.

4383-326 Asama-cho, Ise-shi, Mie-ken 516-0021 JAPAN

Telephone : +81 596 24 8999

Facsimile : +81 596 24 8124

Description of EUT and Support equipment

No.	Item	Model number	Serial number	Manufacturer	Remarks
A	Communication Module	Type1JS	14	Murata Manufacturing Co., Ltd.	EUT
B	Jig	-	-	Murata Manufacturing Co., Ltd.	-
C	Jig	GB-BSi3H-6100	-	GIGABYTE	-
D	AC Adapter	DA-65C19	YL93116118019937800	Asian Power Devices Inc.	-
E	Laptop PC	CF-N8HWCDPS	OBKSA08704	Panasonic	-
F	AC Adapter	CF-AA6372B	6372BM409907232B	Panasonic	-
G	Accesspoint	AIR-CAP3702E-A-K9	FTX182276QC	Cisco Systems	-
H	AC Adapter	AA25480L	ALD030406GR	Cisco Systems	-
I	Laptop PC	FMV-A8260	R8800679	FUJITSU	-
J	AC Adapter	ADP-80NBA	10268063C	FUJITSU	-

List of cables used

No.	Name	Length (m)	Shield	
			Cable	Connector
1	Signal Cable	0.05	Unshielded	Unshielded
2	DC Cable	0.75	Unshielded	Unshielded
3	DC Cable	0.75	Unshielded	Unshielded
4	Signal Cable	0.20	Unshielded	Unshielded
5	DC Cable	1.50	Unshielded	Unshielded
6	AC Cable	0.70	Unshielded	Unshielded
7	LAN Cable	0.50	Unshielded	Unshielded
8	DC Cable	1.10	Unshielded	Unshielded
9	AC Cable	0.90	Unshielded	Unshielded
10	LAN Cable	3.00	Unshielded	Unshielded
11	DC Cable	1.90	Unshielded	Unshielded
12	AC Cable	1.80	Unshielded	Unshielded
13	DC Cable	1.90	Unshielded	Unshielded
14	AC Cable	2.10	Unshielded	Unshielded

UL Japan, Inc.

Ise EMC Lab.

4383-326 Asama-cho, Ise-shi, Mie-ken 516-0021 JAPAN

Telephone : +81 596 24 8999

Facsimile : +81 596 24 8124

5.3 Test and Measurement System

SYSTEM OVERVIEW

The measurement system is based on a conducted test method.

The software selects waveform parameters from within the bounds of the signal type on a random basis using uniform distribution. The short pulse types 1, 2, 3, and 4, the long pulse type 5, and the frequency hopping type 6 parameters are randomized at run-time.

The signal monitoring equipment consists of a spectrum analyzer with the capacity to display 8001 bins on the horizontal axis. A time-domain resolution of 2 msec/bin is achievable with a 16 second sweep time, meeting the 10 seconds short pulse reporting criteria. The aggregate ON time is calculated by multiplying the number of bins above a threshold during a particular observation period by the dwell time per bin, with the analyzer set to peak detection.

FREQUENCY HOPPING RADAR WAVEFORM GENERATING SUBSYSTEM

The first 100 frequencies are selected out of the hopping sequence of the randomized 475 hop frequencies.

Only a *Burst* that has the frequency falling within the receiver bandwidth of the tested U-NII device is selected among those frequencies. (Frequency-domain simulation). The radar waveform generated at the start time of the selected *Burst* (Time-domain simulation) is download to the Signal Generator.

If all of the randomly selected 100 frequencies do not fall within the receiver bandwidth of the U-NII device, the radar waveform is not used for the test.

UL Japan, Inc.

Ise EMC Lab.

4383-326 Asama-cho, Ise-shi, Mie-ken 516-0021 JAPAN

Telephone : +81 596 24 8999

Facsimile : +81 596 24 8124

CONDUCTED METHODS SYSTEM BLOCK DIAGRAM

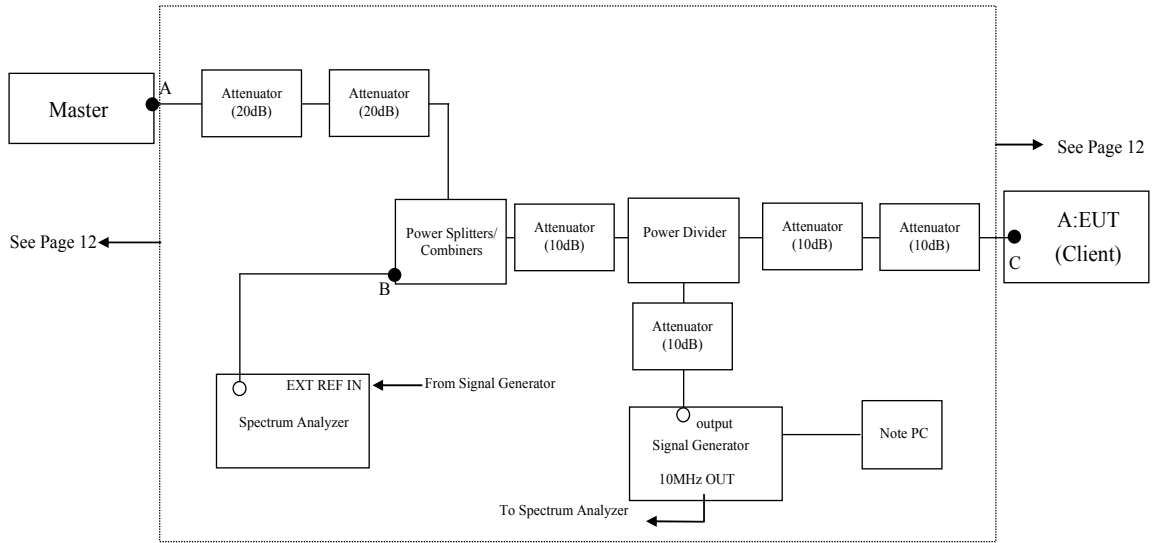

MEASUREMENT SYSTEM FREQUENCY REFERENCE

Lock the signal generator and the spectrum analyzer to the same reference sources as follows: Connect the 10 MHz OUT on the signal generator to the EXT REF IN on the spectrum analyzer and set the spectrum analyzer Ext to On.

UL Japan, Inc.

Ise EMC Lab.

4383-326 Asama-cho, Ise-shi, Mie-ken 516-0021 JAPAN

Telephone : +81 596 24 8999

Facsimile : +81 596 24 8124

SYSTEM CALIBRATION

Step 1: Set the system as shown in Figure 3 of KDB905462 7.2.2.

Step 2: Adjust each attenuator to fulfill the following three conditions:

- WLAN can be communicated, and
- Rader detection threshold level is bigger than Client Device traffic level on the spectrum analyzer, and
- Master Device traffic level is not displayed on the spectrum analyzer.

Step 3: Terminate 50 ohm at B and C points, and connect the spectrum analyzer to the point A. (See the figure on page 14)

At the point A, adjust the signal generator and spectrum analyzer to the center frequency of the channel to be measured.

Download the applicable radar waveforms to the signal generator. Select the radar waveform, trigger a burst manually and measure the amplitude on the spectrum analyzer. Readjust the amplitude of the signal generator as required so that the peak level of the waveform is at a displayed level equal to the required or desired interference detection threshold.

Separate signal generator amplitude settings are determined as required for each radar type.

Step 4: Without changing any of the instrument settings, restore the system setting to Step 2 and adjust the Reference Level Offset of the spectrum analyzer to the level at Step 3.

By taking the above steps 1 to 4, the spectrum analyzer displays the level of the signal generator as received at the antenna ports of the Master Device.

See Clause 5.4 for Plots of Noise, Rader Waveforms, and WLAN signals.

UL Japan, Inc.

Ise EMC Lab.

4383-326 Asama-cho, Ise-shi, Mie-ken 516-0021 JAPAN

Telephone : +81 596 24 8999

Facsimile : +81 596 24 8124

5.4 Plots of Noise, Rader Waveforms, and WLAN signals

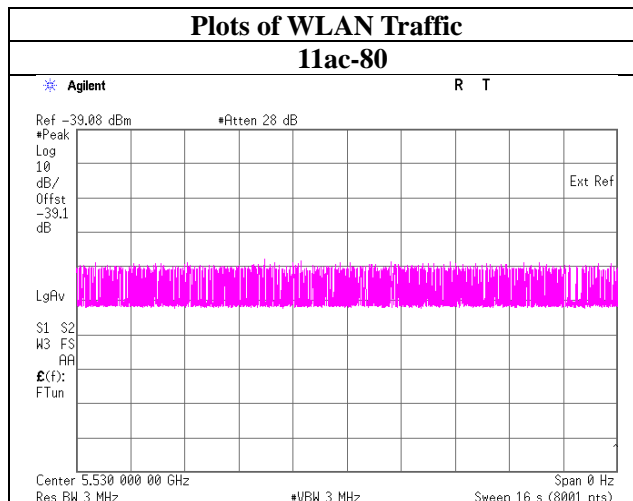
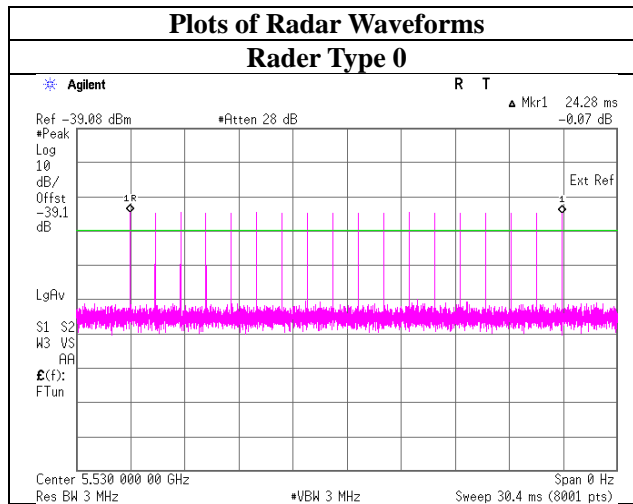
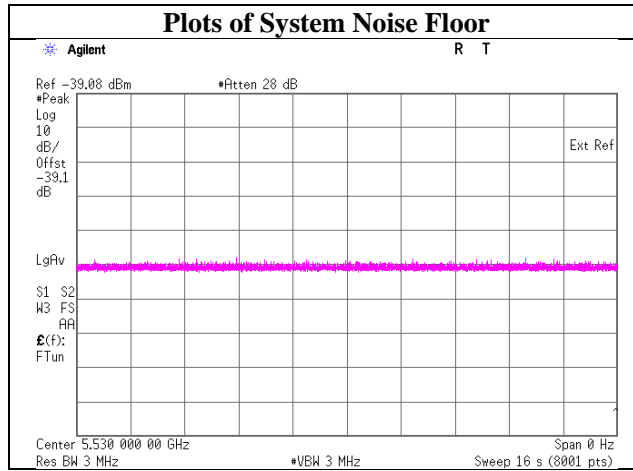

UL Japan, Inc.
Ise EMC Lab.

4383-326 Asama-cho, Ise-shi, Mie-ken 516-0021 JAPAN
 Telephone : +81 596 24 8999
 Facsimile : +81 596 24 8124

SECTION 6: Channel Move Time, Channel Closing Transmission Time

6.1 Operating environment

Test place Ise EMC Lab.No.6 Measurement Room
Date 10/21/2016
Temperature/ Humidity 23deg. C / 43% RH
Engineer Takumi Shimada
Mode 11ac-80

6.2 Test Procedure

Transmit the data from the Master Device to the Client Device on the test Channel for the entire period of the test. The Radar Waveform generator sends a Burst of pulses for one of the Short Pulse Radar Types 0 at levels defined , on the Operating Channel. An additional 1 dB is added to the radar test signal to ensure it is at or above the DFS Detection Threshold, accounting for equipment variations/errors. Observe the transmissions of the EUT at the end of the radar Burst on the Operating Channel for duration greater than 10 seconds.

6.3 Test data

11ac-80

Test Item	Unit	Measurement Time	Limit	Results
Channel Move Time *1)	[sec]	0.048	10.000	Pass
Channel Closing Transmission Time *2)	[msec]	0	60	Pass

*1) Channel Move Time is calculated as follows:

$$(\text{Channel Move Time}) = (\text{End of Transmission}) - (\text{End of Burst}) = 1.872 - 1.824$$

*2) Channel Closing Transmission Time is calculated from (End of Burst + 200msec) to (End of Burst + 10sec)

$$(\text{Channel Closing Transmission Time}) = (\text{Number of analyzer bins showing transmission}) \times (\text{dwell time per bin}) \\ = 0 \times 2 [\text{msec}]$$

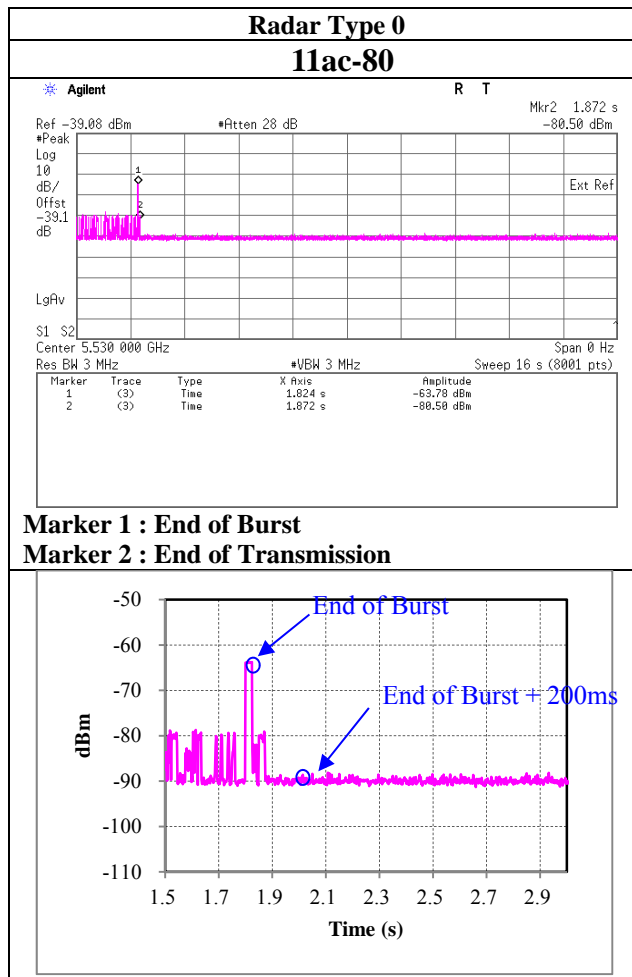

6.4 Test result

Test result: Pass

SECTION 7: Non-Occupancy Period

7.1 Operating environment

Test place	Ise EMC Lab.No.6 Measurement Room
Date	10/21/2016
Temperature/ Humidity	23deg. C / 43% RH
Engineer	Takumi Shimada
Mode	11ac-80

7.2 Test Procedure

The following two tests are performed:

- 1). Transmit the data from the Master Device to the Client Device on the test Channel for the entire period of the test. The Radar Waveform generator sends a Burst of pulses for one of the Radar Types 0 at levels defined on the Operating Channel. An additional 1 dB is added to the radar test signal to ensure it is at or above the DFS Detection Threshold, accounting for equipment variations/errors. Observe the transmissions of the EUT after the Channel Move Time on the Operating Channel for duration greater than 30 minutes.
- 2). Transmit the data from the Master Device to the Client Device on the test Channel for the entire period of the test. Observe the transmissions of the EUT on the Operating Channel for duration greater than 30 minutes after the Master Device is shut off.

UL Japan, Inc.

Ise EMC Lab.

4383-326 Asama-cho, Ise-shi, Mie-ken 516-0021 JAPAN

Telephone : +81 596 24 8999

Facsimile : +81 596 24 8124

7.3 Test data

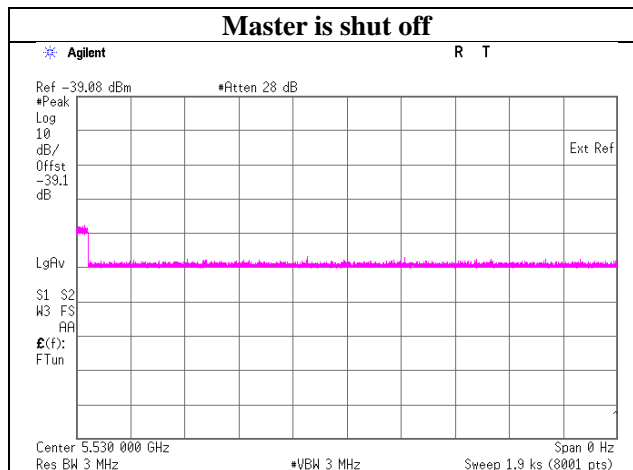
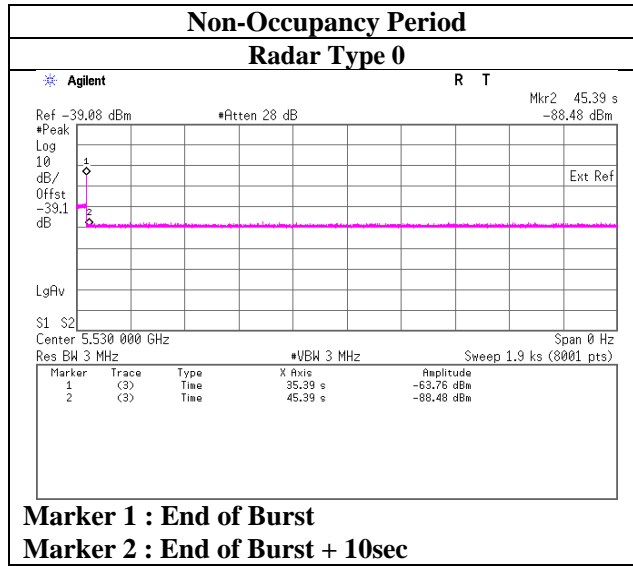

7.4 Test result

Test result: Pass

APPENDIX 1: Test instruments

EMI Test Equipment

Control No.	Instrument	Manufacturer	Model No	Serial No	Test Item	Calibration Date * Interval(month)
MSA-15	Spectrum Analyzer	Agilent	E4440A	MY46187105	DFS	2016/10/13 * 12
MCC-190	Microwave Cable	Junkosha	MWX-221-02000DMSDMS	1507S109	DFS	Pre Check
MCC-183	Microwave Cable	Junkosha	MMX221-00500DMSDMS	1502S310	DFS	Pre Check
MCC-184	Microwave Cable	Junkosha	MMX221-00500DMSDMS	1502S311	DFS	Pre Check
MAT-89	Attenuator	Weinschel Associates	WA56-10	56100305	DFS	2016/06/09 * 12
MAT-90	Attenuator	Weinschel Associates	WA56-10	56100306	DFS	2016/06/09 * 12
MAT-91	Attenuator	Weinschel Associates	WA56-10	56100307	DFS	2016/06/09 * 12
MAT-92	Attenuator	Weinschel Associates	WA56-10	56100308	DFS	2016/06/09 * 12
MAT-59	Attenuator(20dB)	Suhner	6820.19.A	-	DFS	Pre Check
MAT-60	Attenuator(20dB)	Suhner	6820.19.A	-	DFS	Pre Check
MPSC-06	Power Splitters/Combiners	Pasternack Enterprises	ZFRSC-123-S+	ZFRSC-123-00231	DFS	Pre Check
MPSC-07	Power Splitters/Combiners	Pasternack Enterprises	ZFRSC-123-S+	ZFRSC-123-00232	DFS	Pre Check
EST-48	Signal Generator	Agilent	E4438C	MY45090353	DFS	2015/12/30 * 12 *1)
MOS-14	Thermo-Hygrometer	Custom	CTH-201	1401	DFS	2016/01/21 * 12
COTS-MDFS-01	Signal Studio Software for DFS	Agilent	N7620A-101	5010-7739	DFS	-
COTS-MDFS-02	Radar Generating Software for DFS	Agilent	-	-	DFS	-

***1) Signal generator is only used to generate radar test signal, and the wave form is confirmed with spectrum analyzer every time before the test.**

The expiration date of the calibration is the end of the expired month.

All equipment is calibrated with valid calibrations. Each measurement data is traceable to the national or international standards.

As for some calibrations performed after the tested dates, those test equipment have been controlled by means of an unbroken chains of calibrations.

DFS: Dynamic Frequency Selection

UL Japan, Inc.

Ise EMC Lab.

4383-326 Asama-cho, Ise-shi, Mie-ken 516-0021 JAPAN

Telephone : +81 596 24 8999

Facsimile : +81 596 24 8124