

FCC Test Report

Report No.: RF160428C07-1 R1

FCC ID: VPYLB1FD

Test Model: LBEE6ZZ1FD

Received Date: Apr. 28, 2016

Test Date: May 19 ~ Jun. 16, 2016

Issued Date: Jul. 25, 2016

Applicant: Murata Manufacturing Co., Ltd.

Address: 10-1, Higashikotari 1-chome, Nagaokakyo-shi, Kyoto 617-8555, Japan

Issued By: Bureau Veritas Consumer Products Services (H.K.) Ltd., Taoyuan Branch

Lab Address: No. 47-2, 14th Ling, Chia Pau Vil., Lin Kou Dist., New Taipei City, Taiwan, R.O.C.

Test Location: No. 19, Hwa Ya 2nd Rd., Wen Hwa Vil., Kwei Shan Dist., Taoyuan City 33383, TAIWAN (R.O.C.)



This report is for your exclusive use. Any copying or replication of this report to or for any other person or entity, or use of our name or trademark, is permitted only with our prior written permission. This report sets forth our findings solely with respect to the test samples identified herein. The results set forth in this report are not indicative or representative of the quality or characteristics of the lot from which a test sample was taken or any similar or identical product specifically and expressly noted. Our report includes all of the tests requested by you and the results thereof based upon the information that you provided to us. You have 60 days from date of issuance of this report to notify us of any material error or omission caused by our negligence, provided, however, that such notice shall be in writing and shall specifically address the issue you wish to raise. A failure to raise such issue within the prescribed time shall constitute your unqualified acceptance of the completeness of this report, the tests conducted and the correctness of the report contents. Unless specific mention, the uncertainty of measurement has been explicitly taken into account to declare the compliance or non-compliance to the specification. The report must not be used by the client to claim product certification, approval, or endorsement by TAF or any government agencies.

Table of Contents

Release Control Record	4
1 Certificate of Conformity	5
2 Summary of Test Results	6
2.1 Measurement Uncertainty.....	6
2.2 Modification Record.....	6
3 General Information	7
3.1 General Description of EUT.....	7
3.2 Description of Test Modes.....	8
3.2.1 Test Mode Applicability and Tested Channel Detail.....	10
3.3 Duty Cycle of Test Signal.....	12
3.4 Description of Support Units.....	14
3.4.1 Configuration of System under Test.....	14
3.5 General Description of Applied Standards.....	14
4 Test Types and Results	15
4.1 Radiated Emission and Bandedge Measurement.....	15
4.1.1 Limits of Radiated Emission and Bandedge Measurement.....	15
4.1.2 Test Instruments.....	16
4.1.3 Test Procedures.....	17
4.1.4 Deviation from Test Standard.....	17
4.1.5 Test Setup.....	18
4.1.6 EUT Operating Conditions.....	18
4.1.7 Test Results.....	19
4.2 Conducted Emission Measurement.....	89
4.2.1 Limits of Conducted Emission Measurement.....	89
4.2.2 Test Instruments.....	89
4.2.3 Test Procedures.....	90
4.2.4 Deviation from Test Standard.....	90
4.2.5 Test Setup.....	90
4.2.6 EUT Operating Conditions.....	90
4.2.7 Test Results.....	91
4.3 Transmit Power Measurement.....	93
4.3.1 Limits of Transmit Power Measurement.....	93
4.3.2 Test Setup.....	93
4.3.3 Test Instruments.....	93
4.3.4 Test Procedure.....	94
4.3.5 Deviation from Test Standard.....	94
4.3.6 EUT Operating Conditions.....	94
4.3.7 Test Result.....	95
4.4 Peak Power Spectral Density Measurement.....	115
4.4.1 Limits of Peak Power Spectral Density Measurement.....	115
4.4.2 Test Setup.....	115
4.4.3 Test Instruments.....	115
4.4.4 Test Procedures.....	116
4.4.5 Deviation from Test Standard.....	116
4.4.6 EUT Operating Conditions.....	116
4.4.7 Test Results.....	117
4.5 Frequency Stability.....	128
4.5.1 Limits of Frequency Stability Measurement.....	128
4.5.2 Test Setup.....	128
4.5.3 Test Instruments.....	128
4.5.4 Test Procedure.....	128
4.5.5 Deviation from Test Standard.....	128
4.5.6 EUT Operating Condition.....	128

4.5.7 Test Results	129
4.6 6dB Bandwidth Measurement.....	130
4.6.1 Limits of 6dB Bandwidth Measurement.....	130
4.6.2 Test Setup.....	130
4.6.3 Test Instruments	130
4.6.4 Test Procedure	130
4.6.5 Deviation from Test Standard	130
4.6.6 EUT Operating Condition	130
4.6.7 Test Results	131
5 Pictures of Test Arrangements.....	135
Annex A- Radiated Out of Band Emission (OOBE) Measurement (For U-NII-3 band).....	136
Appendix – Information on the Testing Laboratories	141

Release Control Record

Issue No.	Description	Date Issued
RF160428C07-1	Original release.	Jun. 17, 2016
RF160428C07-1 R1	Revised product name	Jul. 25, 2016

1 Certificate of Conformity

Product: Communication Module
Brand: MURATA
Test Model: LBEE6ZZ1FD
Sample Status: Engineering sample
Applicant: Murata Manufacturing Co., Ltd.
Test Date: May 19 ~ Jun. 16, 2016
Standards: 47 CFR FCC Part 15, Subpart E (Section 15.407)
ANSI C63.10:2013

The above equipment has been tested by **Bureau Veritas Consumer Products Services (H.K.) Ltd., Taoyuan Branch**, and found compliance with the requirement of the above standards. The test record, data evaluation & Equipment Under Test (EUT) configurations represented herein are true and accurate accounts of the measurements of the sample's EMC characteristics under the conditions specified in this report.

Prepared by : , **Date:** Jul. 25, 2016
Pettie Chen / Senior Specialist

Approved by : , **Date:** Jul. 25, 2016
Ken Liu / Senior Manager

2 Summary of Test Results

47 CFR FCC Part 15, Subpart E (SECTION 15.407)			
FCC Clause	Test Item	Result	Remarks
15.407(b)(6)	AC Power Conducted Emissions	Pass	Meet the requirement of limit. Minimum passing margin is -31.85dB at 0.89000MHz.
15.407(b) (1/2/3/4(i/ii)/6)	Radiated Emissions & Band Edge Measurement	Pass	Meet the requirement of limit. Minimum passing margin is -1.0dB at 5470.00MHz.
15.407(a) (1/2/3)	Max Average Transmit Power	Pass	Meet the requirement of limit.
15.407(a)(1/2/3)	Peak Power Spectral Density	Pass	Meet the requirement of limit.
15.407(e)	6dB bandwidth	Pass	Meet the requirement of limit. (U-NII-3 Band only)
15.407(g)	Frequency Stability	Pass	Meet the requirement of limit.
15.203	Antenna Requirement	Pass	Antenna connector is SMA(M) Reverse not a standard connector.

*For U-NII-3 band compliance with rule part 15.407(b)(i), the OOB test plots were recorded in Annex A.

2.1 Measurement Uncertainty

Where relevant, the following measurement uncertainty levels have been estimated for tests performed on the EUT as specified in CISPR 16-4-2:

Measurement	Frequency	Expanded Uncertainty (k=2) (±)
Conducted Emissions at mains ports	150kHz ~ 30MHz	2.44 dB
Radiated Emissions up to 1 GHz	30MHz ~ 200MHz	3.86 dB
	200MHz ~ 1000MHz	3.87 dB
Radiated Emissions above 1 GHz	1GHz ~ 18GHz	2.29 dB
	18GHz ~ 40GHz	2.29 dB

2.2 Modification Record

There were no modifications required for compliance.

3 General Information

3.1 General Description of EUT

Product	Communication Module
Brand	MURATA
Test Model	LBEE6ZZ1FD
Status of EUT	Engineering sample
Power Supply Rating	3.6Vdc (Host)
Modulation Type	256QAM, 64QAM, 16QAM, QPSK, BPSK
Modulation Technology	OFDM
Transfer Rate	802.11a: 54.0/ 48.0/ 36.0/ 24.0/ 18.0/ 12.0/ 9.0/ 6.0Mbps 802.11n: up to MCS 7 802.11ac: up to MCS 9
Operating Frequency	5180 ~ 5240MHz, 5260 ~ 5320MHz, 5500 ~ 5720MHz & 5745 ~ 5825MHz
Number of Channel	5180 ~ 5240MHz: 4 for 802.11a, 802.11n (HT20), 802.11ac (VHT20) 2 for 802.11n (HT40), 802.11ac (VHT40) 1 for 802.11ac (VHT80) 5260 ~ 5320MHz: 4 for 802.11a, 802.11n (HT20), 802.11ac (VHT20) 2 for 802.11n (HT40), 802.11ac (VHT40) 1 for 802.11ac (VHT80) 5500 ~ 5720MHz: 12 for 802.11a, 802.11n (HT20), 802.11ac (VHT20) 6 for 802.11n (HT40), 802.11ac (VHT40) 3 for 802.11ac (VHT80) 5745 ~ 5825MHz: 5 for 802.11a, 802.11n (HT20), 802.11ac (VHT20) 2 for 802.11n (HT40), 802.11ac (VHT40) 1 for 802.11ac (VHT80)
Output Power	1TX: 5180 ~ 5240MHz: 8.630mW 5260 ~ 5320MHz: 8.690mW 5500 ~ 5720MHz: 9.594mW 5745 ~ 5825MHz: 10.280mW 2TX: 5180 ~ 5240MHz: 16.404mW 5260 ~ 5320MHz: 16.381mW 5500 ~ 5720MHz: 19.703mW 5745 ~ 5825MHz: 18.735mW
Antenna Type	Dipole antenna with 2.93dBi gain
Antenna Connector	SMA(M) Reverse
Accessory Device	NA
Data Cable Supplied	NA

Note:

1. The EUT incorporates a MIMO function. Physically, the EUT provides 2 completed transmitters and 2 receivers.

Modulation Mode	TX Function
802.11a	1TX
802.11n (HT20)	1TX/2TX
802.11n (HT40)	1TX/2TX
802.11ac (VHT20)	1TX/2TX
802.11ac (VHT40)	1TX/2TX
802.11ac (VHT80)	1TX/2TX

* The modulation and bandwidth are similar between 802.11n mode for HT20 / HT40 and 802.11ac mode for VHT20 / VHT40, and therefore investigated worst case to representative mode in test report. (Final test mode refer section 3.2.1)

* The EUT supports diversity function in 5GHz Band transmitter part.

1TX: The EUT supports chain 0 or chain 1. Chain 0 was the worst for final test.

2. The above EUT information is declared by manufacturer and for more detailed features description, please refer to the manufacturer's specifications or user's manual.

3.2 Description of Test Modes

FOR 5180 ~ 5240MHz:

4 channels are provided for 802.11a, 802.11n (HT20), 802.11ac (VHT20):

Channel	Frequency	Channel	Frequency
36	5180 MHz	44	5220 MHz
40	5200 MHz	48	5240 MHz

2 channels are provided for 802.11n (HT40), 802.11ac (VHT40):

Channel	Frequency	Channel	Frequency
38	5190 MHz	46	5230 MHz

1 channel is provided for 802.11ac (VHT80):

Channel	Frequency
42	5210 MHz

FOR 5260 ~ 5320MHz:

4 channels are provided for 802.11a, 802.11n (HT20), 802.11ac (VHT20):

Channel	Frequency	Channel	Frequency
52	5260 MHz	60	5300 MHz
56	5280 MHz	64	5320 MHz

2 channels are provided for 802.11n (HT40), 802.11ac (VHT40):

Channel	Frequency	Channel	Frequency
54	5270 MHz	62	5310 MHz

1 channel is provided for 802.11ac (VHT80):

Channel	Frequency
58	5290 MHz

FOR 5500 ~ 5720MHz:

12 channels are provided for 802.11a, 802.11n (HT20), 802.11ac (VHT20):

Channel	Frequency	Channel	Frequency
100	5500 MHz	124	5620 MHz
104	5520 MHz	128	5640 MHz
108	5540 MHz	132	5660 MHz
112	5560 MHz	136	5680 MHz
116	5580 MHz	140	5700 MHz
120	5600 MHz	144	5720 MHz

6 channels are provided for 802.11n (HT40), 802.11ac (VHT40):

Channel	Frequency	Channel	Frequency
102	5510 MHz	126	5630 MHz
110	5550 MHz	134	5670 MHz
118	5590 MHz	142	5710 MHz

3 channels are provided for 802.11ac (VHT80):

Channel	Frequency	Channel	Frequency
106	5530 MHz	122	5610 MHz
138	5690 MHz		

FOR 5745 ~ 5825MHz:

5 channels are provided for 802.11a, 802.11n (HT20), 802.11ac (VHT20):

Channel	Frequency	Channel	Frequency
149	5745 MHz	161	5805 MHz
153	5765 MHz	165	5825 MHz
157	5785 MHz		

2 channels are provided for 802.11n (HT40), 802.11ac (VHT40):

Channel	Frequency	Channel	Frequency
151	5755 MHz	159	5795 MHz

1 channel is provided for 802.11ac (VHT80):

Channel	Frequency
155	5775 MHz

3.2.1 Test Mode Applicability and Tested Channel Detail

EUT CONFIGURE MODE	APPLICABLE TO				DESCRIPTION
	RE≥1G	RE<1G	PLC	APCM	
-	√	√	√	√	-

Where **RE≥1G**: Radiated Emission above 1GHz & Bandedge Measurement
RE<1G: Radiated Emission below 1GHz
PLC: Power Line Conducted Emission
APCM: Antenna Port Conducted Measurement

Note: 1. The EUT had been pre-tested on the positioned of each 3 axis. The worst case was found when positioned on **X-axis**.

Radiated Emission Test (Above 1GHz):

Pre-Scan has been conducted to determine the worst-case mode from all possible combinations between available modulations, data rates and antenna ports (if EUT with antenna diversity architecture).

Following channel(s) was (were) selected for the final test as listed below.

EUT CONFIGURE MODE	MODE	FREQ. BAND (MHz)	AVAILABLE CHANNEL	TESTED CHANNEL	MODULATION TECHNOLOGY	MODULATION TYPE	DATA RATE (Mbps)	TX CONDITION
-	802.11a	5180-5240	36 to 48	36, 40, 48	OFDM	BPSK	6.0	1TX
-	802.11ac (VHT20)		36 to 48	36, 40, 48	OFDM	BPSK	7.2/14.4	1TX/2TX
-	802.11ac (VHT40)		38 to 46	38, 46	OFDM	BPSK	15/30	1TX/2TX
-	802.11ac (VHT80)		42	42	OFDM	BPSK	32.5/65	1TX/2TX
-	802.11a	5260-5320	52 to 64	52, 60, 64	OFDM	BPSK	6.0	1TX
-	802.11ac (VHT20)		52 to 64	52, 60, 64	OFDM	BPSK	7.2/14.4	1TX/2TX
-	802.11ac (VHT40)		54 to 62	54, 62	OFDM	BPSK	15/30	1TX/2TX
-	802.11ac (VHT80)		58	58	OFDM	BPSK	32.5/65	1TX/2TX
-	802.11a	5500-5720	100 to 144	100, 116, 140, 144	OFDM	BPSK	6.0	1TX
-	802.11ac (VHT20)		100 to 144	100, 116, 140, 144	OFDM	BPSK	7.2/14.4	1TX/2TX
-	802.11ac (VHT40)		102 to 142	102, 110, 134, 142	OFDM	BPSK	15/30	1TX/2TX
-	802.11ac (VHT80)		106 to 138	106, 138	OFDM	BPSK	32.5/65	1TX/2TX
-	802.11a	5745-5825	149 to 165	149, 157, 165	OFDM	BPSK	6.0	1TX
-	802.11ac (VHT20)		149 to 165	149, 157, 165	OFDM	BPSK	7.2/14.4	1TX/2TX
-	802.11ac (VHT40)		151 to 159	151, 159	OFDM	BPSK	15/30	1TX/2TX
-	802.11ac (VHT80)		155	155	OFDM	BPSK	32.5/65	1TX/2TX

Radiated Emission Test (Below 1GHz):

Pre-Scan has been conducted to determine the worst-case mode from all possible combinations between available modulations, data rates and antenna ports (if EUT with antenna diversity architecture).

Following channel(s) was (were) selected for the final test as listed below.

EUT CONFIGURE MODE	MODE	FREQ. BAND (MHz)	AVAILABLE CHANNEL	TESTED CHANNEL	MODULATION TECHNOLOGY	MODULATION TYPE	DATA RATE (Mbps)	TX CONDITION
-	802.11ac (VHT20)	5180-5240	36 to 48	36	OFDM	BPSK	14.4	2TX
	802.11ac (VHT20)	5260-5320	52 to 64		OFDM	BPSK	14.4	2TX
	802.11ac (VHT20)	5500-5720	100 to 144		OFDM	BPSK	14.4	2TX
	802.11ac (VHT20)	5745-5825	149 to 165		OFDM	BPSK	14.4	2TX



Power Line Conducted Emission Test:

- Pre-Scan has been conducted to determine the worst-case mode from all possible combinations between available modulations, data rates and antenna ports (if EUT with antenna diversity architecture).
- Following channel(s) was (were) selected for the final test as listed below.

EUT CONFIGURE MODE	MODE	FREQ. BAND (MHz)	AVAILABLE CHANNEL	TESTED CHANNEL	MODULATION TECHNOLOGY	MODULATION TYPE	DATA RATE (Mbps)	TX CONDITION
-	802.11ac (VHT20)	5180-5240	36 to 48	36	OFDM	BPSK	14.4	2TX
	802.11ac (VHT20)	5260-5320	52 to 64		OFDM	BPSK	14.4	2TX
	802.11ac (VHT20)	5500-5720	100 to 144		OFDM	BPSK	14.4	2TX
	802.11ac (VHT20)	5745-5825	149 to 165		OFDM	BPSK	14.4	2TX

Antenna Port Conducted Measurement:

- This item includes all test value of each mode, but only includes spectrum plot of worst value of each mode.
- Pre-Scan has been conducted to determine the worst-case mode from all possible combinations between available modulations, data rates and antenna ports (if EUT with antenna diversity architecture).
- Following channel(s) was (were) selected for the final test as listed below.

EUT CONFIGURE MODE	MODE	FREQ. BAND (MHz)	AVAILABLE CHANNEL	TESTED CHANNEL	MODULATION TECHNOLOGY	MODULATION TYPE	DATA RATE (Mbps)	TX CONDITION
-	802.11a	5180-5240	36 to 48	36, 40, 48	OFDM	BPSK	6.0	1TX
-	802.11ac (VHT20)		36 to 48	36, 40, 48	OFDM	BPSK	7.2/14.4	1TX/2TX
-	802.11ac (VHT40)		38 to 46	38, 46	OFDM	BPSK	15/30	1TX/2TX
-	802.11ac (VHT80)		42	42	OFDM	BPSK	32.5/65	1TX/2TX
-	802.11a	5260-5320	52 to 64	52, 60, 64	OFDM	BPSK	6.0	1TX
-	802.11ac (VHT20)		52 to 64	52, 60, 64	OFDM	BPSK	7.2/14.4	1TX/2TX
-	802.11ac (VHT40)		54 to 62	54, 62	OFDM	BPSK	15/30	1TX/2TX
-	802.11ac (VHT80)		58	58	OFDM	BPSK	32.5/65	1TX/2TX
-	802.11a	5500-5720	100 to 144	100, 116, 140, 144	OFDM	BPSK	6.0	1TX
-	802.11ac (VHT20)		100 to 144	100, 116, 140, 144	OFDM	BPSK	7.2/14.4	1TX/2TX
-	802.11ac (VHT40)		102 to 142	102, 110, 134, 142	OFDM	BPSK	15/30	1TX/2TX
-	802.11ac (VHT80)		106 to 138	106, 138	OFDM	BPSK	32.5/65	1TX/2TX
-	802.11a	5745-5825	149 to 165	149, 157, 165	OFDM	BPSK	6.0	1TX
-	802.11ac (VHT20)		149 to 165	149, 157, 165	OFDM	BPSK	7.2/14.4	1TX/2TX
-	802.11ac (VHT40)		151 to 159	151, 159	OFDM	BPSK	15/30	1TX/2TX
-	802.11ac (VHT80)		155	155	OFDM	BPSK	32.5/65	1TX/2TX

Test Condition:

APPLICABLE TO	ENVIRONMENTAL CONDITIONS	INPUT POWER	TESTED BY
RE≥1G	21deg. C, 66%RH	120Vac, 60Hz	Nick Hsu Jones Chang
RE<1G	21deg. C, 66%RH	120Vac, 60Hz	Jones Chang
PLC	20deg. C, 70%RH	120Vac, 60Hz	Jones Chang
APCM	25deg. C, 60%RH	120Vac, 60Hz	Ted Chang

3.3 Duty Cycle of Test Signal

Duty cycle of test signal is > 98%, duty factor is not required.

Duty cycle of test signal is < 98%, duty factor is required.

802.11a_1TX: Duty cycle = 1.427/1.547 = 0.922, Duty factor = $10 * \log(1/0.922) = 0.35$

802.11ac (VHT20)_1TX: Duty cycle = 1.332/1.454 = 0.916, Duty factor = $10 * \log(1/0.916) = 0.38$

802.11ac (VHT40)_1TX: Duty cycle = 0.657/0.769 = 0.854, Duty factor = $10 * \log(1/0.854) = 0.68$

802.11ac (VHT80)_1TX: Duty cycle = 0.325/0.440 = 0.739, Duty factor = $10 * \log(1/0.739) = 1.32$

802.11ac (VHT20)_2TX: Duty cycle = 1.329/1.454 = 0.914, Duty factor = $10 * \log(1/0.914) = 0.39$

802.11ac (VHT40)_2TX: Duty cycle = 0.655/0.782 = 0.838, Duty factor = $10 * \log(1/0.838) = 0.77$

802.11ac (VHT80)_2TX: Duty cycle = 0.330/0.445 = 0.742, Duty factor = $10 * \log(1/0.742) = 1.30$

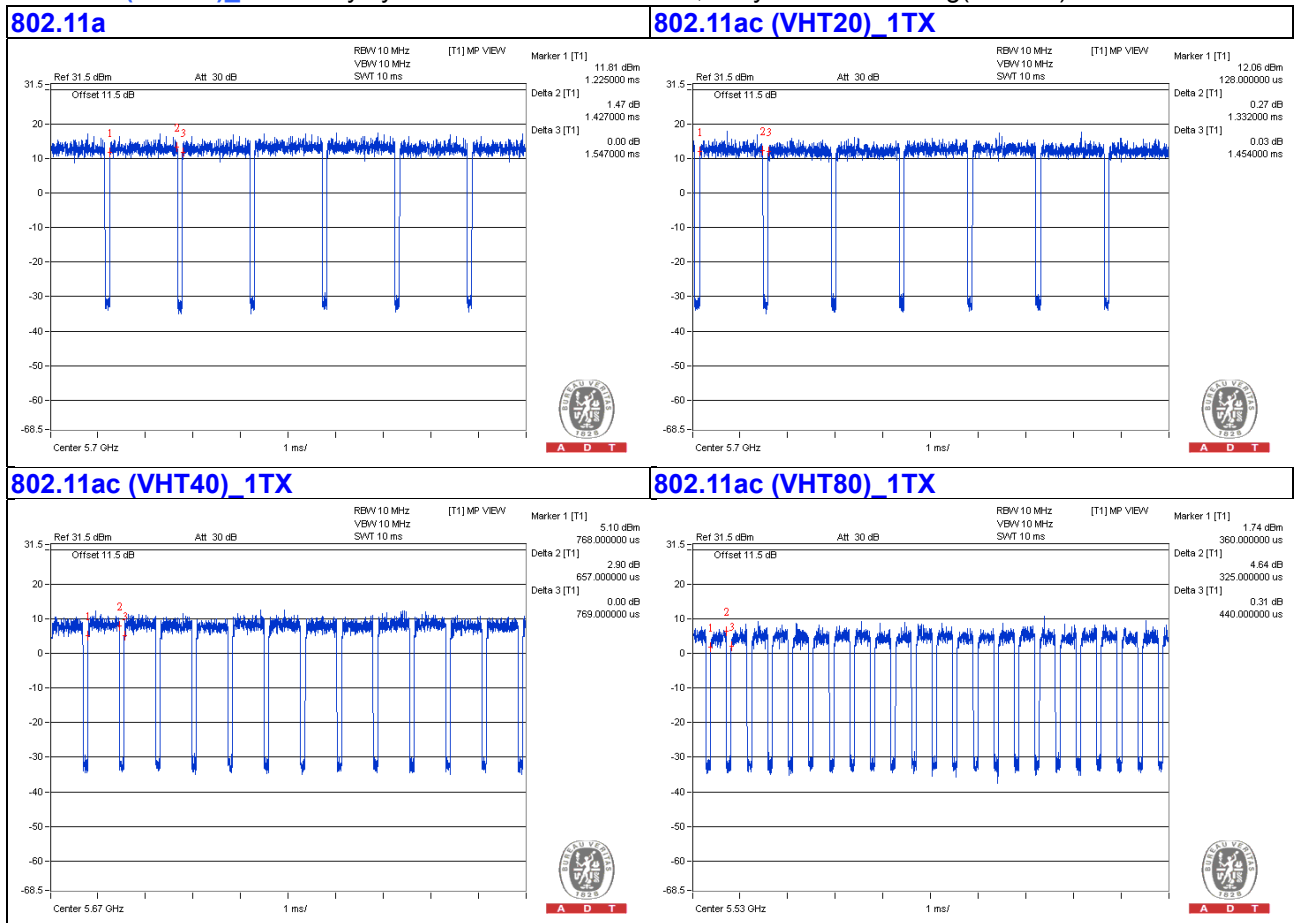



802.11ac (VHT20)_2TX

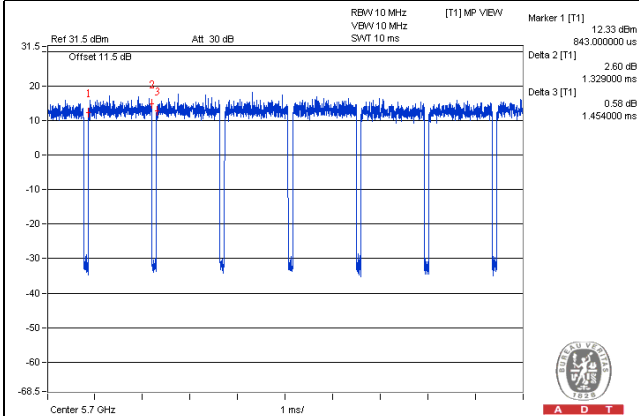

802.11ac (VHT40)_2TX

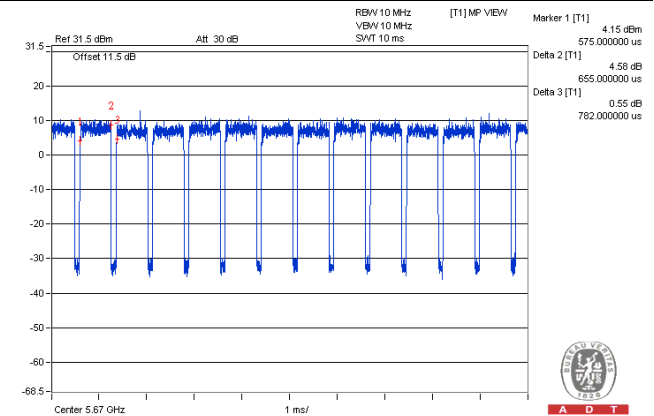

802.11ac (VHT80)_2TX

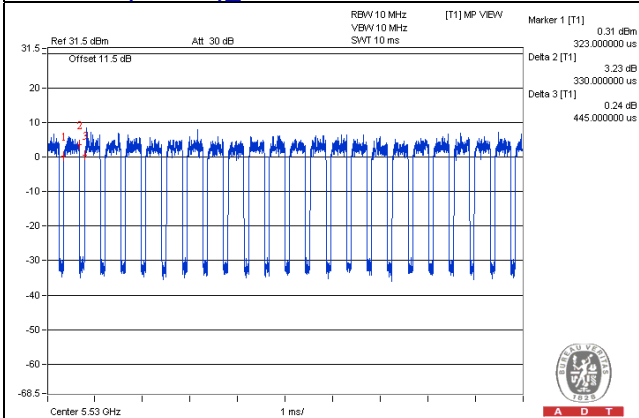

3.4 Description of Support Units

The EUT has been tested as an independent unit together with other necessary accessories or support units. The following support units or accessories were used to form a representative test configuration during the tests.

ID	Product	Brand	Model No.	Serial No.	FCC ID	Remarks
A.	DC Power Supply	TOPWARD	6303D	802236	NA	-

Note:

1. All power cords of the above support units are non-shielded (1.8m).

3.4.1 Configuration of System under Test

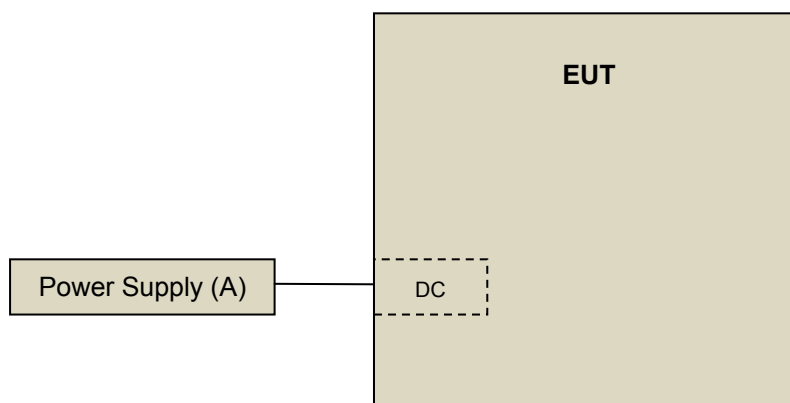

3.5 General Description of Applied Standards

The EUT is a RF Product. According to the specifications of the manufacturer, it must comply with the requirements of the following standards:

FCC Part 15, Subpart E (15.407)

KDB 789033 D02 General UNII Test Procedures New Rules v01r03

KDB 662911 D01 Multiple Transmitter Output v02r01

ANSI C63.10-2013

All test items have been performed and recorded as per the above standards.

4 Test Types and Results

4.1 Radiated Emission and Bandedge Measurement

4.1.1 Limits of Radiated Emission and Bandedge Measurement

Radiated emissions which fall in the restricted bands must comply with the radiated emission limits specified as below table. Other emissions shall be at least 20dB below the highest level of the desired power:

Frequencies (MHz)	Field Strength (microvolts/meter)	Measurement Distance (meters)
0.009 ~ 0.490	2400/F(kHz)	300
0.490 ~ 1.705	24000/F(kHz)	30
1.705 ~ 30.0	30	30
30 ~ 88	100	3
88 ~ 216	150	3
216 ~ 960	200	3
Above 960	500	3

NOTE:

1. The lower limit shall apply at the transition frequencies.
2. Emission level (dBuV/m) = 20 log Emission level (uV/m).
3. For frequencies above 1000MHz, the field strength limits are based on average detector, however, the peak field strength of any emission shall not exceed the maximum permitted average limits, specified above by more than 20dB under any condition of modulation.

LIMITS OF UNWANTED EMISSION OUT OF THE RESTRICTED BANDS

Applicable To	Limit	
789033 D02 General UNII Test Procedure New Rules v01r03	FIELD STRENGTH at 3m	
	PK:74 (dBµV/m)	AV:54 (dBµV/m)
Applicable To	EIRP Limit	Equivalent Field Strength at 3m
15.407(b)(1)	PK:-27 (dBm/MHz)	PK:68.2 (dBµV/m)
15.407(b)(2)		
15.407(b)(3)		
15.407(b)(4)(i)	PK: -27 (dBm/MHz) ^{*1} PK: 10 (dBm/MHz) ^{*2} PK: 15.6 (dBm/MHz) ^{*3} PK: 27 (dBm/MHz) ^{*4}	PK: 68.2 (dBµV/m) ^{*1} PK: 105.2 (dBµV/m) ^{*2} PK: 110.8 (dBµV/m) ^{*3} PK: 122.2 (dBµV/m) ^{*4}
15.407(b)(4)(ii)	FIELD STRENGTH at 3m / § 15.247(d),	
	PK:74 (dBµV/m)	AV:54 (dBµV/m)
^{*1} beyond 75 MHz or more above of the band edge. ^{*2} below the band edge increasing linearly to 10 dBm/MHz at 25 MHz above. ^{*3} below the band edge increasing linearly to a level of 15.6 dBm/MHz at 5 MHz above. ^{*4} from 5 MHz above or below the band edge increasing linearly to a level of 27 dBm/MHz at the band edge.		

NOTE: The following formula is used to convert the equipment isotropic radiated power (eirp) to field strength:

$$E = \frac{1000000 \sqrt{30P}}{3} \mu\text{V/m, where P is the eirp (Watts).}$$



4.1.2 Test Instruments

DESCRIPTION & MANUFACTURER	MODEL NO.	SERIAL NO.	DATE OF CALIBRATION	DUE DATE OF CALIBRATION
Test Receiver ROHDE & SCHWARZ	ESIB7	100187	Apr. 18, 2016	Apr. 17, 2017
Spectrum Analyzer ROHDE & SCHWARZ	FSV40	100979	Feb. 19, 2016	Feb. 18, 2017
BILOG Antenna SCHWARZBECK	VULB9168	9168-171	Jan. 07, 2016	Jan. 06, 2017
HORN Antenna SCHWARZBECK	9120D	209	Jan. 20, 2016	Jan. 19, 2017
HORN Antenna SCHWARZBECK	BBHA 9170	BBHA9170241	Jan. 18, 2016	Jan. 17, 2017
Preamplifier Agilent	8447D	2944A10738	Oct.18, 2015	Oct. 17, 2016
Preamplifier Agilent	8449B	3008A01964	Aug. 22, 2015	Aug. 21, 2016
RF signal cable HUBER+SUHNER	SUCOFLEX 104	Cable-CH3-03 (214378)	Aug. 22, 2015	Aug. 21, 2016
RF signal cable HUBER+SUHNER	SUCOFLEX 106	Cable-CH3-03 (309224+12738)	Aug. 22, 2015	Aug. 21, 2016
Software BV ADT	ADT_Radiated_ V7.6.15.9.4	NA	NA	NA
Antenna Tower inn-co GmbH	MA 4000	013303	NA	NA
Antenna Tower Controller BV ADT	AT100	AT93021702	NA	NA
Turn Table BV ADT	TT100	TT93021702	NA	NA
Turn Table Controller BV ADT	SC100	SC93021702	NA	NA
26GHz ~ 40GHz Amplifier	EM26400	815221	Oct. 18, 2015	Oct. 17, 2016
High Speed Peak Power Meter	ML2495A	0824011	Jul. 09, 2015	Jul. 08, 2016
Power Sensor	MA2411B	0738171	Jul. 09, 2015	Jul. 08, 2016

- Note: 1. The calibration interval of the above test instruments is 12 months and the calibrations are traceable to NML/ROC and NIST/USA.
2. The test was performed in HwaYa Chamber 3.
3. The horn antenna and preamplifier (model: 8449B) are used only for the measurement of emission frequency above 1GHz if tested.
4. The FCC Site Registration No. is 988962.
5. The IC Site Registration No. is IC 7450F-3.

4.1.3 Test Procedures

- a. The EUT was placed on the top of a rotating table 0.8 meters (for below 1GHz) / 1.5 meters (for above 1GHz) above the ground at 3 meter chamber room for test. The table was rotated 360 degrees to determine the position of the highest radiation.
- b. The EUT was set 3 meters away from the interference-receiving antenna, which was mounted on the top of a variable-height antenna tower.
- c. The height of antenna is varied from one meter to four meters above the ground to determine the maximum value of the field strength. Both horizontal and vertical polarizations of the antenna are set to make the measurement.
- d. For each suspected emission, the EUT was arranged to its worst case and then the antenna was tuned to heights from 1 meter to 4 meters and the rotatable table was turned from 0 degrees to 360 degrees to find the maximum reading.
- e. The test-receiver system was set to quasi-peak detect function and specified bandwidth with maximum hold mode when the test frequency is below 1 GHz.
- f. The test-receiver system was set to peak and average detect function and specified bandwidth with maximum hold mode when the test frequency is above 1 GHz. If the peak reading value also meets average limit, measurement with the average detector is unnecessary.

Note:

1. The resolution bandwidth and video bandwidth of test receiver/spectrum analyzer is 120kHz for Quasi-peak detection (QP) at frequency below 1GHz.
2. The resolution bandwidth of test receiver/spectrum analyzer is 1 MHz and the video bandwidth is 3 MHz for Peak detection (PK) at frequency above 1GHz.
3. The resolution bandwidth of test receiver/spectrum analyzer is 1MHz and the video bandwidth is 3MHz for RMS Average (Duty cycle < 98%) for Average detection (AV) at frequency above 1GHz, then the measurement results was added to a correction factor ($10 \log(1/\text{duty cycle})$).
4. The resolution bandwidth of test receiver/spectrum analyzer is 1MHz and the video bandwidth is 10Hz (Duty cycle $\geq 98\%$) for Average detection (AV) at frequency above 1GHz.
5. All modes of operation were investigated and the worst-case emissions are reported.

4.1.4 Deviation from Test Standard

No deviation.

4.1.5 Test Setup

<Frequency Range 30MHz ~ 1GHz>

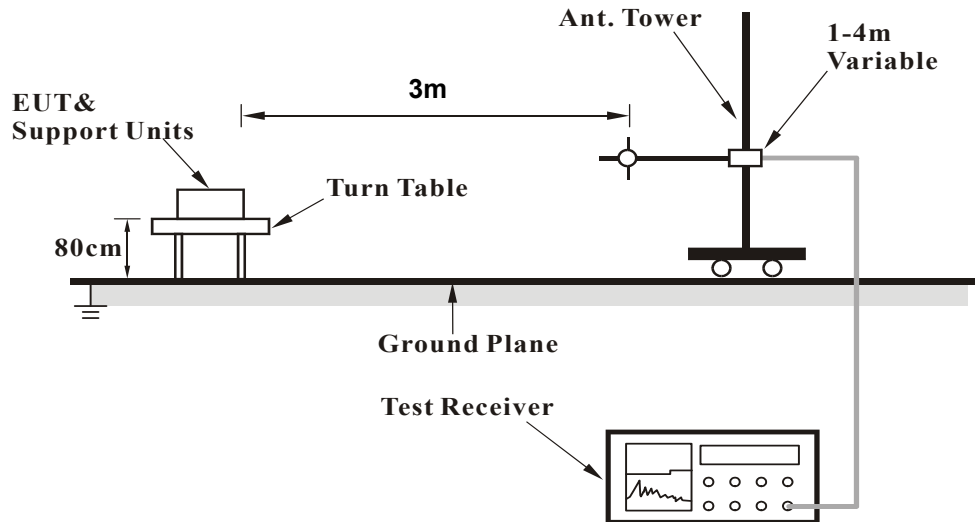

<Frequency Range above 1GHz>

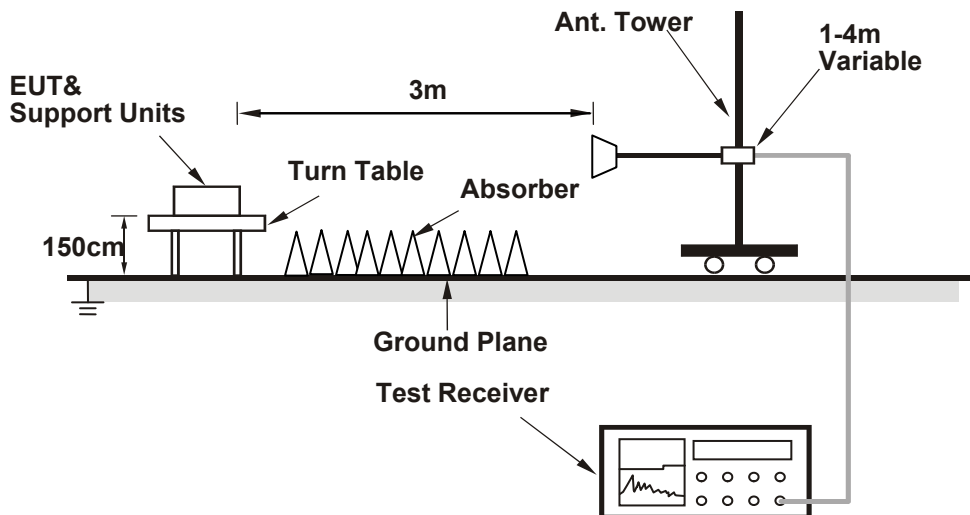

For the actual test configuration, please refer to the attached file (Test Setup Photo)

4.1.6 EUT Operating Conditions

Set the EUT under transmission condition continuously at specific channel frequency.

4.1.7 Test Results

Above 1GHz data:

802.11a

CHANNEL	TX Channel 36	DETECTOR FUNCTION	Peak (PK)
FREQUENCY RANGE	1GHz ~ 40GHz		Average (AV)

ANTENNA POLARITY & TEST DISTANCE: HORIZONTAL AT 3 M								
NO.	FREQ. (MHz)	EMISSION LEVEL (dBuV/m)	LIMIT (dBuV/m)	MARGIN (dB)	ANTENNA HEIGHT (m)	TABLE ANGLE (Degree)	RAW VALUE (dBuV)	CORRECTION FACTOR (dB/m)
1	5150.00	56.3 PK	74.0	-17.7	2.02 H	69	50.30	6.00
2	5150.00	44.6 AV	54.0	-9.4	2.02 H	69	38.60	6.00
3	*5180.00	95.7 PK			2.78 H	0	56.30	39.40
4	*5180.00	85.5 AV			2.78 H	0	46.10	39.40
5	#10360.00	59.9 PK	74.0	-14.1	1.58 H	184	42.10	17.80
6	#10360.00	46.8 AV	54.0	-7.2	1.58 H	184	29.00	17.80
ANTENNA POLARITY & TEST DISTANCE: VERTICAL AT 3 M								
NO.	FREQ. (MHz)	EMISSION LEVEL (dBuV/m)	LIMIT (dBuV/m)	MARGIN (dB)	ANTENNA HEIGHT (m)	TABLE ANGLE (Degree)	RAW VALUE (dBuV)	CORRECTION FACTOR (dB/m)
1	5150.00	56.3 PK	74.0	-17.7	2.07 V	189	50.30	6.00
2	5150.00	46.7 AV	54.0	-7.3	2.07 V	189	40.70	6.00
3	*5180.00	103.8 PK			2.17 V	196	64.40	39.40
4	*5180.00	93.8 AV			2.17 V	196	54.40	39.40
5	#10360.00	61.3 PK	74.0	-12.7	1.80 V	160	43.50	17.80
6	#10360.00	48.7 AV	54.0	-5.3	1.80 V	160	30.90	17.80

REMARKS:

1. Emission Level(dBuV/m) = Raw Value(dBuV) + Correction Factor(dB/m)
2. Correction Factor(dB/m) = Antenna Factor(dB/m) + Cable Factor(dB) – Pre-Amplifier Factor(dB)
3. The other emission levels were very low against the limit.
4. Margin value = Emission Level – Limit value
5. " * ": Fundamental frequency.
6. " # ": The radiated frequency is out of the restricted band.

CHANNEL	TX Channel 40	DETECTOR FUNCTION	Peak (PK)
FREQUENCY RANGE	1GHz ~ 40GHz		Average (AV)

ANTENNA POLARITY & TEST DISTANCE: HORIZONTAL AT 3 M

NO.	FREQ. (MHz)	EMISSION LEVEL (dBuV/m)	LIMIT (dBuV/m)	MARGIN (dB)	ANTENNA HEIGHT (m)	TABLE ANGLE (Degree)	RAW VALUE (dBuV)	CORRECTION FACTOR (dB/m)
1	*5200.00	95.2 PK			2.75 H	26	55.70	39.50
2	*5200.00	85.4 AV			2.75 H	26	45.90	39.50
3	#10400.00	59.2 PK	74.0	-14.8	1.88 H	189	41.50	17.70
4	#10400.00	46.3 AV	54.0	-7.7	1.88 H	189	28.60	17.70

ANTENNA POLARITY & TEST DISTANCE: VERTICAL AT 3 M

NO.	FREQ. (MHz)	EMISSION LEVEL (dBuV/m)	LIMIT (dBuV/m)	MARGIN (dB)	ANTENNA HEIGHT (m)	TABLE ANGLE (Degree)	RAW VALUE (dBuV)	CORRECTION FACTOR (dB/m)
1	*5200.00	103.7 PK			2.35 V	191	64.20	39.50
2	*5200.00	93.8 AV			2.35 V	191	54.30	39.50
3	#10400.00	60.7 PK	74.0	-13.3	1.92 V	203	43.00	17.70
4	#10400.00	47.6 AV	54.0	-6.4	1.92 V	203	29.90	17.70

REMARKS:

1. Emission Level(dBuV/m) = Raw Value(dBuV) + Correction Factor(dB/m)
2. Correction Factor(dB/m) = Antenna Factor(dB/m) + Cable Factor(dB) – Pre-Amplifier Factor(dB)
3. The other emission levels were very low against the limit.
4. Margin value = Emission Level – Limit value
5. " * ": Fundamental frequency.
6. " # ": The radiated frequency is out of the restricted band.

CHANNEL	TX Channel 48	DETECTOR FUNCTION	Peak (PK)
FREQUENCY RANGE	1GHz ~ 40GHz		Average (AV)

ANTENNA POLARITY & TEST DISTANCE: HORIZONTAL AT 3 M

NO.	FREQ. (MHz)	EMISSION LEVEL (dBuV/m)	LIMIT (dBuV/m)	MARGIN (dB)	ANTENNA HEIGHT (m)	TABLE ANGLE (Degree)	RAW VALUE (dBuV)	CORRECTION FACTOR (dB/m)
1	*5240.00	94.7 PK			2.68 H	2	55.10	39.60
2	*5240.00	85.7 AV			2.68 H	2	46.10	39.60
3	5400.00	57.3 PK	74.0	-16.7	2.10 H	179	50.60	6.70
4	5400.00	46.4 AV	54.0	-7.6	2.10 H	179	39.70	6.70
5	#10480.00	60.4 PK	74.0	-13.6	1.68 H	245	41.70	18.70
6	#10480.00	47.5 AV	54.0	-6.5	1.68 H	245	28.80	18.70

ANTENNA POLARITY & TEST DISTANCE: VERTICAL AT 3 M

NO.	FREQ. (MHz)	EMISSION LEVEL (dBuV/m)	LIMIT (dBuV/m)	MARGIN (dB)	ANTENNA HEIGHT (m)	TABLE ANGLE (Degree)	RAW VALUE (dBuV)	CORRECTION FACTOR (dB/m)
1	*5240.00	103.1 PK			2.32 V	191	63.50	39.60
2	*5240.00	93.5 AV			2.32 V	191	53.90	39.60
3	5350.00	59.8 PK	74.0	-14.2	2.11 V	202	53.30	6.50
4	5350.00	47.1 AV	54.0	-6.9	2.11 V	202	40.60	6.50
5	#10480.00	61.4 PK	74.0	-12.6	1.79 V	181	42.70	18.70
6	#10480.00	48.8 AV	54.0	-5.2	1.79 V	181	30.10	18.70

REMARKS:

1. Emission Level(dBuV/m) = Raw Value(dBuV) + Correction Factor(dB/m)
2. Correction Factor(dB/m) = Antenna Factor(dB/m) + Cable Factor(dB) – Pre-Amplifier Factor(dB)
3. The other emission levels were very low against the limit.
4. Margin value = Emission Level – Limit value
5. " * ": Fundamental frequency.
6. " # ": The radiated frequency is out of the restricted band.

CHANNEL	TX Channel 52	DETECTOR FUNCTION	Peak (PK)
FREQUENCY RANGE	1GHz ~ 40GHz		Average (AV)

ANTENNA POLARITY & TEST DISTANCE: HORIZONTAL AT 3 M

NO.	FREQ. (MHz)	EMISSION LEVEL (dBuV/m)	LIMIT (dBuV/m)	MARGIN (dB)	ANTENNA HEIGHT (m)	TABLE ANGLE (Degree)	RAW VALUE (dBuV)	CORRECTION FACTOR (dB/m)
1	*5260.00	97.1 PK			2.07 H	263	57.50	39.60
2	*5260.00	87.4 AV			2.07 H	263	47.80	39.60
3	5400.00	57.3 PK	74.0	-16.7	2.00 H	115	50.60	6.70
4	5400.00	46.0 AV	54.0	-8.0	2.00 H	115	39.30	6.70
5	#10520.00	60.6 PK	74.0	-13.4	1.56 H	19	41.70	18.90
6	#10520.00	47.6 AV	54.0	-6.4	1.56 H	19	28.70	18.90

ANTENNA POLARITY & TEST DISTANCE: VERTICAL AT 3 M

NO.	FREQ. (MHz)	EMISSION LEVEL (dBuV/m)	LIMIT (dBuV/m)	MARGIN (dB)	ANTENNA HEIGHT (m)	TABLE ANGLE (Degree)	RAW VALUE (dBuV)	CORRECTION FACTOR (dB/m)
1	*5260.00	104.6 PK			2.37 V	192	65.00	39.60
2	*5260.00	94.6 AV			2.37 V	192	55.00	39.60
3	5400.00	61.2 PK	74.0	-12.8	2.30 V	277	54.50	6.70
4	5400.00	47.1 AV	54.0	-6.9	2.30 V	277	40.40	6.70
5	#10520.00	61.0 PK	74.0	-13.0	1.89 V	254	42.10	18.90
6	#10520.00	48.4 AV	54.0	-5.6	1.89 V	254	29.50	18.90

REMARKS:

1. Emission Level(dBuV/m) = Raw Value(dBuV) + Correction Factor(dB/m)
2. Correction Factor(dB/m) = Antenna Factor(dB/m) + Cable Factor(dB) – Pre-Amplifier Factor(dB)
3. The other emission levels were very low against the limit.
4. Margin value = Emission Level – Limit value
5. " * ": Fundamental frequency.
6. " # ": The radiated frequency is out of the restricted band.

CHANNEL	TX Channel 60	DETECTOR FUNCTION	Peak (PK)
FREQUENCY RANGE	1GHz ~ 40GHz		Average (AV)

ANTENNA POLARITY & TEST DISTANCE: HORIZONTAL AT 3 M

NO.	FREQ. (MHz)	EMISSION LEVEL (dBuV/m)	LIMIT (dBuV/m)	MARGIN (dB)	ANTENNA HEIGHT (m)	TABLE ANGLE (Degree)	RAW VALUE (dBuV)	CORRECTION FACTOR (dB/m)
1	*5300.00	95.7 PK			2.89 H	140	56.00	39.70
2	*5300.00	85.5 AV			2.89 H	140	45.80	39.70
3	10600.00	60.4 PK	74.0	-13.6	1.89 H	202	41.50	18.90
4	10600.00	47.2 AV	54.0	-6.8	1.89 H	202	28.30	18.90

ANTENNA POLARITY & TEST DISTANCE: VERTICAL AT 3 M

NO.	FREQ. (MHz)	EMISSION LEVEL (dBuV/m)	LIMIT (dBuV/m)	MARGIN (dB)	ANTENNA HEIGHT (m)	TABLE ANGLE (Degree)	RAW VALUE (dBuV)	CORRECTION FACTOR (dB/m)
1	*5300.00	105.5 PK			2.45 V	184	65.80	39.70
2	*5300.00	95.3 AV			2.45 V	184	55.60	39.70
3	10600.00	61.2 PK	74.0	-12.8	1.77 V	174	42.30	18.90
4	10600.00	48.1 AV	54.0	-5.9	1.77 V	174	29.20	18.90

REMARKS:

1. Emission Level(dBuV/m) = Raw Value(dBuV) + Correction Factor(dB/m)
2. Correction Factor(dB/m) = Antenna Factor(dB/m) + Cable Factor(dB) – Pre-Amplifier Factor(dB)
3. The other emission levels were very low against the limit.
4. Margin value = Emission Level – Limit value
5. " * ": Fundamental frequency.
6. " # ": The radiated frequency is out of the restricted band.

CHANNEL	TX Channel 64	DETECTOR FUNCTION	Peak (PK)
FREQUENCY RANGE	1GHz ~ 40GHz		Average (AV)

ANTENNA POLARITY & TEST DISTANCE: HORIZONTAL AT 3 M

NO.	FREQ. (MHz)	EMISSION LEVEL (dBuV/m)	LIMIT (dBuV/m)	MARGIN (dB)	ANTENNA HEIGHT (m)	TABLE ANGLE (Degree)	RAW VALUE (dBuV)	CORRECTION FACTOR (dB/m)
1	*5320.00	94.3 PK			2.85 H	143	54.60	39.70
2	*5320.00	85.2 AV			2.85 H	143	45.50	39.70
3	5350.00	56.5 PK	74.0	-17.5	2.45 H	212	50.00	6.50
4	5350.00	45.8 AV	54.0	-8.2	2.45 H	212	39.30	6.50
5	10640.00	60.4 PK	74.0	-13.6	2.11 H	190	41.60	18.80
6	10640.00	47.2 AV	54.0	-6.8	2.11 H	190	28.40	18.80

ANTENNA POLARITY & TEST DISTANCE: VERTICAL AT 3 M

NO.	FREQ. (MHz)	EMISSION LEVEL (dBuV/m)	LIMIT (dBuV/m)	MARGIN (dB)	ANTENNA HEIGHT (m)	TABLE ANGLE (Degree)	RAW VALUE (dBuV)	CORRECTION FACTOR (dB/m)
1	*5320.00	103.6 PK			2.27 V	191	63.90	39.70
2	*5320.00	94.0 AV			2.27 V	191	54.30	39.70
3	5350.00	59.6 PK	74.0	-14.4	2.27 V	191	53.10	6.50
4	5350.00	46.9 AV	54.0	-7.1	2.27 V	191	40.40	6.50
5	10640.00	60.8 PK	74.0	-13.2	2.00 V	222	42.00	18.80
6	10640.00	48.0 AV	54.0	-6.0	2.00 V	222	29.20	18.80

REMARKS:

1. Emission Level(dBuV/m) = Raw Value(dBuV) + Correction Factor(dB/m)
2. Correction Factor(dB/m) = Antenna Factor(dB/m) + Cable Factor(dB) – Pre-Amplifier Factor(dB)
3. The other emission levels were very low against the limit.
4. Margin value = Emission Level – Limit value
5. " * ": Fundamental frequency.

CHANNEL	TX Channel 100	DETECTOR FUNCTION	Peak (PK)
FREQUENCY RANGE	1GHz ~ 40GHz		Average (AV)

ANTENNA POLARITY & TEST DISTANCE: HORIZONTAL AT 3 M

NO.	FREQ. (MHz)	EMISSION LEVEL (dBuV/m)	LIMIT (dBuV/m)	MARGIN (dB)	ANTENNA HEIGHT (m)	TABLE ANGLE (Degree)	RAW VALUE (dBuV)	CORRECTION FACTOR (dB/m)
1	5360.00	57.3 PK	74.0	-16.7	2.20 H	198	50.80	6.50
2	5360.00	46.3 AV	54.0	-7.7	2.20 H	198	39.80	6.50
3	#5470.00	60.3 PK	74.0	-13.7	2.28 H	255	53.40	6.90
4	#5470.00	48.4 AV	54.0	-5.6	2.28 H	255	41.50	6.90
5	*5500.00	96.6 PK			2.30 H	255	56.40	40.20
6	*5500.00	87.4 AV			2.30 H	255	47.20	40.20
7	11000.00	61.1 PK	74.0	-12.9	1.88 H	25	41.20	19.90
8	11000.00	48.3 AV	54.0	-5.7	1.88 H	25	28.40	19.90

ANTENNA POLARITY & TEST DISTANCE: VERTICAL AT 3 M

NO.	FREQ. (MHz)	EMISSION LEVEL (dBuV/m)	LIMIT (dBuV/m)	MARGIN (dB)	ANTENNA HEIGHT (m)	TABLE ANGLE (Degree)	RAW VALUE (dBuV)	CORRECTION FACTOR (dB/m)
1	5460.00	56.9 PK	74.0	-17.1	2.15 V	93	50.00	6.90
2	5460.00	45.2 AV	54.0	-8.8	2.15 V	93	38.30	6.90
3	#5470.00	58.8 PK	74.0	-15.2	1.99 V	201	51.90	6.90
4	#5470.00	47.2 AV	54.0	-6.8	1.99 V	201	40.30	6.90
5	*5500.00	103.8 PK			2.40 V	189	63.60	40.20
6	*5500.00	94.1 AV			2.40 V	189	53.90	40.20
7	11000.00	62.3 PK	74.0	-11.7	2.00 V	221	42.40	19.90
8	11000.00	49.2 AV	54.0	-4.8	2.00 V	221	29.30	19.90

REMARKS:

1. Emission Level(dBuV/m) = Raw Value(dBuV) + Correction Factor(dB/m)
2. Correction Factor(dB/m) = Antenna Factor(dB/m) + Cable Factor(dB) – Pre-Amplifier Factor(dB)
3. The other emission levels were very low against the limit.
4. Margin value = Emission Level – Limit value
5. " * ": Fundamental frequency.
6. " # ": The radiated frequency is out of the restricted band.

CHANNEL	TX Channel 116	DETECTOR FUNCTION	Peak (PK)
FREQUENCY RANGE	1GHz ~ 40GHz		Average (AV)

ANTENNA POLARITY & TEST DISTANCE: HORIZONTAL AT 3 M

NO.	FREQ. (MHz)	EMISSION LEVEL (dBuV/m)	LIMIT (dBuV/m)	MARGIN (dB)	ANTENNA HEIGHT (m)	TABLE ANGLE (Degree)	RAW VALUE (dBuV)	CORRECTION FACTOR (dB/m)
1	*5580.00	94.8 PK			2.57 H	37	54.50	40.30
2	*5580.00	85.2 AV			2.57 H	37	44.90	40.30
3	11160.00	60.8 PK	74.0	-13.2	1.94 H	56	41.40	19.40
4	11160.00	47.7 AV	54.0	-6.3	1.94 H	56	28.30	19.40

ANTENNA POLARITY & TEST DISTANCE: VERTICAL AT 3 M

NO.	FREQ. (MHz)	EMISSION LEVEL (dBuV/m)	LIMIT (dBuV/m)	MARGIN (dB)	ANTENNA HEIGHT (m)	TABLE ANGLE (Degree)	RAW VALUE (dBuV)	CORRECTION FACTOR (dB/m)
1	*5580.00	104.1 PK			2.37 V	167	63.80	40.30
2	*5580.00	94.6 AV			2.37 V	167	54.30	40.30
3	11600.00	61.7 PK	74.0	-12.3	1.97 V	197	42.90	18.80
4	11600.00	48.4 AV	54.0	-5.6	1.97 V	197	29.60	18.80

REMARKS:

1. Emission Level(dBuV/m) = Raw Value(dBuV) + Correction Factor(dB/m)
2. Correction Factor(dB/m) = Antenna Factor(dB/m) + Cable Factor(dB) – Pre-Amplifier Factor(dB)
3. The other emission levels were very low against the limit.
4. Margin value = Emission Level – Limit value
5. " * ": Fundamental frequency.

CHANNEL	TX Channel 140	DETECTOR FUNCTION	Peak (PK)
FREQUENCY RANGE	1GHz ~ 40GHz		Average (AV)

ANTENNA POLARITY & TEST DISTANCE: HORIZONTAL AT 3 M

NO.	FREQ. (MHz)	EMISSION LEVEL (dBuV/m)	LIMIT (dBuV/m)	MARGIN (dB)	ANTENNA HEIGHT (m)	TABLE ANGLE (Degree)	RAW VALUE (dBuV)	CORRECTION FACTOR (dB/m)
1	*5700.00	96.6 PK			2.39 H	256	56.20	40.40
2	*5700.00	86.8 AV			2.39 H	256	46.40	40.40
3	#5725.00	58.1 PK	74.0	-15.9	2.39 H	256	50.70	7.40
4	#5725.00	46.5 AV	54.0	-7.5	2.39 H	256	39.10	7.40
5	11400.00	59.8 PK	74.0	-14.2	1.80 H	156	41.00	18.80
6	11400.00	47.0 AV	54.0	-7.0	1.80 H	156	28.20	18.80

ANTENNA POLARITY & TEST DISTANCE: VERTICAL AT 3 M

NO.	FREQ. (MHz)	EMISSION LEVEL (dBuV/m)	LIMIT (dBuV/m)	MARGIN (dB)	ANTENNA HEIGHT (m)	TABLE ANGLE (Degree)	RAW VALUE (dBuV)	CORRECTION FACTOR (dB/m)
1	*5700.00	104.1 PK			2.31 V	161	63.70	40.40
2	*5700.00	94.8 AV			2.31 V	161	54.40	40.40
3	#5725.00	58.7 PK	74.0	-15.3	2.31 V	161	51.30	7.40
4	#5725.00	47.7 AV	54.0	-6.3	2.31 V	161	40.30	7.40
5	11400.00	61.0 PK	74.0	-13.0	1.85 V	231	42.20	18.80
6	11400.00	48.3 AV	54.0	-5.7	1.85 V	231	29.50	18.80

REMARKS:

1. Emission Level(dBuV/m) = Raw Value(dBuV) + Correction Factor(dB/m)
2. Correction Factor(dB/m) = Antenna Factor(dB/m) + Cable Factor(dB) – Pre-Amplifier Factor(dB)
3. The other emission levels were very low against the limit.
4. Margin value = Emission Level – Limit value
5. " * ": Fundamental frequency.
6. " # ": The radiated frequency is out of the restricted band.

CHANNEL	TX Channel 144	DETECTOR FUNCTION	Peak (PK)
FREQUENCY RANGE	1GHz ~ 40GHz		Average (AV)

ANTENNA POLARITY & TEST DISTANCE: HORIZONTAL AT 3 M

NO.	FREQ. (MHz)	EMISSION LEVEL (dBuV/m)	LIMIT (dBuV/m)	MARGIN (dB)	ANTENNA HEIGHT (m)	TABLE ANGLE (Degree)	RAW VALUE (dBuV)	CORRECTION FACTOR (dB/m)
1	#5470.00	57.3 PK	74.0	-16.7	2.49 H	266	50.40	6.90
2	#5470.00	45.9 AV	54.0	-8.1	2.49 H	266	39.00	6.90
3	*5720.00	97.0 PK			2.49 H	266	56.50	40.50
4	*5720.00	86.6 AV			2.49 H	266	46.10	40.50
5	#5850.00	58.8 PK	74.0	-15.2	2.43 H	281	51.20	7.60
6	#5850.00	47.8 AV	54.0	-6.2	2.43 H	281	40.20	7.60
7	11440.00	59.6 PK	74.0	-14.4	1.79 H	154	40.90	18.70
8	11440.00	46.7 AV	54.0	-7.3	1.79 H	154	28.00	18.70

ANTENNA POLARITY & TEST DISTANCE: VERTICAL AT 3 M

NO.	FREQ. (MHz)	EMISSION LEVEL (dBuV/m)	LIMIT (dBuV/m)	MARGIN (dB)	ANTENNA HEIGHT (m)	TABLE ANGLE (Degree)	RAW VALUE (dBuV)	CORRECTION FACTOR (dB/m)
1	#5470.00	57.9 PK	74.0	-16.1	2.36 V	181	51.00	6.90
2	#5470.00	46.9 AV	54.0	-7.1	2.36 V	181	40.00	6.90
3	*5720.00	103.9 PK			2.30 V	159	63.40	40.50
4	*5720.00	95.1 AV			2.30 V	159	54.60	40.50
5	#5850.00	58.6 PK	74.0	-15.4	2.24 V	163	51.00	7.60
6	#5850.00	48.3 AV	54.0	-5.7	2.24 V	163	40.70	7.60
7	11440.00	61.0 PK	74.0	-13.0	1.89 V	234	42.30	18.70
8	11440.00	48.0 AV	54.0	-6.0	1.89 V	234	29.30	18.70

REMARKS:

1. Emission Level(dBuV/m) = Raw Value(dBuV) + Correction Factor(dB/m)
2. Correction Factor(dB/m) = Antenna Factor(dB/m) + Cable Factor(dB) – Pre-Amplifier Factor(dB)
3. The other emission levels were very low against the limit.
4. Margin value = Emission Level – Limit value
5. " * ": Fundamental frequency.
6. " # ": The radiated frequency is out of the restricted band.

CHANNEL	TX Channel 149	DETECTOR FUNCTION	Peak (PK)
FREQUENCY RANGE	1GHz ~ 40GHz		Average (AV)

ANTENNA POLARITY & TEST DISTANCE: HORIZONTAL AT 3 M

NO.	FREQ. (MHz)	EMISSION LEVEL (dBuV/m)	LIMIT (dBuV/m)	MARGIN (dB)	ANTENNA HEIGHT (m)	TABLE ANGLE (Degree)	RAW VALUE (dBuV)	CORRECTION FACTOR (dB/m)
1	#5644.00	56.7 PK	68.2	-11.5	2.75 H	191	49.60	7.10
2	*5745.00	96.0 PK			2.75 H	191	55.50	40.50
3	*5745.00	86.6 AV			2.75 H	191	46.10	40.50
4	#5985.60	59.3 PK	68.2	-8.9	2.75 H	191	51.40	7.90
5	11490.00	60.5 PK	74.0	-13.5	2.32 H	254	41.80	18.70
6	11490.00	47.3 AV	54.0	-6.7	2.32 H	254	28.60	18.70

ANTENNA POLARITY & TEST DISTANCE: VERTICAL AT 3 M

NO.	FREQ. (MHz)	EMISSION LEVEL (dBuV/m)	LIMIT (dBuV/m)	MARGIN (dB)	ANTENNA HEIGHT (m)	TABLE ANGLE (Degree)	RAW VALUE (dBuV)	CORRECTION FACTOR (dB/m)
1	#5640.00	56.8 PK	68.2	-11.4	2.38 V	160	49.70	7.10
2	*5745.00	104.7 PK			2.38 V	160	64.20	40.50
3	*5745.00	94.8 AV			2.38 V	160	54.30	40.50
4	#5936.80	57.8 PK	68.2	-10.4	2.38 V	160	50.10	7.70
5	11490.00	61.7 PK	74.0	-12.3	2.02 V	184	43.00	18.70
6	11490.00	48.6 AV	54.0	-5.4	2.02 V	184	29.90	18.70

REMARKS:

1. Emission Level(dBuV/m) = Raw Value(dBuV) + Correction Factor(dB/m)
2. Correction Factor(dB/m) = Antenna Factor(dB/m) + Cable Factor(dB) – Pre-Amplifier Factor(dB)
3. The other emission levels were very low against the limit.
4. Margin value = Emission Level – Limit value
5. " * ": Fundamental frequency.
6. " # ": The radiated frequency is out of the restricted band.

CHANNEL	TX Channel 157	DETECTOR FUNCTION	Peak (PK)
FREQUENCY RANGE	1GHz ~ 40GHz		Average (AV)

ANTENNA POLARITY & TEST DISTANCE: HORIZONTAL AT 3 M

NO.	FREQ. (MHz)	EMISSION LEVEL (dBuV/m)	LIMIT (dBuV/m)	MARGIN (dB)	ANTENNA HEIGHT (m)	TABLE ANGLE (Degree)	RAW VALUE (dBuV)	CORRECTION FACTOR (dB/m)
1	#5641.60	55.5 PK	68.2	-12.7	2.87 H	254	48.40	7.10
2	*5785.00	97.3 PK			2.87 H	254	56.70	40.60
3	*5785.00	87.5 AV			2.87 H	254	46.90	40.60
4	#5954.40	57.8 PK	68.2	-10.4	2.87 H	254	50.10	7.70
5	11570.00	60.6 PK	74.0	-13.4	2.25 H	195	41.90	18.70
6	11570.00	47.6 AV	54.0	-6.4	2.25 H	195	28.90	18.70

ANTENNA POLARITY & TEST DISTANCE: VERTICAL AT 3 M

NO.	FREQ. (MHz)	EMISSION LEVEL (dBuV/m)	LIMIT (dBuV/m)	MARGIN (dB)	ANTENNA HEIGHT (m)	TABLE ANGLE (Degree)	RAW VALUE (dBuV)	CORRECTION FACTOR (dB/m)
1	#5600.00	60.3 PK	68.2	-7.9	2.40 V	160	53.20	7.10
2	*5785.00	104.5 PK			2.36 V	161	63.90	40.60
3	*5785.00	94.8 AV			2.36 V	161	54.20	40.60
4	#5976.80	59.1 PK	68.2	-9.1	2.40 V	160	51.20	7.90
5	11570.00	61.0 PK	74.0	-13.0	1.96 V	200	42.30	18.70
6	11570.00	47.8 AV	54.0	-6.2	1.96 V	200	29.10	18.70

REMARKS:

1. Emission Level(dBuV/m) = Raw Value(dBuV) + Correction Factor(dB/m)
2. Correction Factor(dB/m) = Antenna Factor(dB/m) + Cable Factor(dB) – Pre-Amplifier Factor(dB)
3. The other emission levels were very low against the limit.
4. Margin value = Emission Level – Limit value
5. " * ": Fundamental frequency.

CHANNEL	TX Channel 165	DETECTOR FUNCTION	Peak (PK)
FREQUENCY RANGE	1GHz ~ 40GHz		Average (AV)

ANTENNA POLARITY & TEST DISTANCE: HORIZONTAL AT 3 M

NO.	FREQ. (MHz)	EMISSION LEVEL (dBuV/m)	LIMIT (dBuV/m)	MARGIN (dB)	ANTENNA HEIGHT (m)	TABLE ANGLE (Degree)	RAW VALUE (dBuV)	CORRECTION FACTOR (dB/m)
1	#5647.20	56.6 PK	68.2	-11.6	2.56 H	255	49.50	7.10
2	*5825.00	94.5 PK			2.56 H	255	53.90	40.60
3	*5825.00	84.5 AV			2.56 H	255	43.90	40.60
4	#5940.80	57.5 PK	68.2	-10.7	2.56 H	255	49.80	7.70
5	11650.00	60.8 PK	74.0	-13.2	2.25 H	230	41.60	19.20
6	11650.00	48.0 AV	54.0	-6.0	2.25 H	230	28.80	19.20

ANTENNA POLARITY & TEST DISTANCE: VERTICAL AT 3 M

NO.	FREQ. (MHz)	EMISSION LEVEL (dBuV/m)	LIMIT (dBuV/m)	MARGIN (dB)	ANTENNA HEIGHT (m)	TABLE ANGLE (Degree)	RAW VALUE (dBuV)	CORRECTION FACTOR (dB/m)
1	#5600.00	60.1 PK	68.2	-8.1	2.38 V	161	53.00	7.10
2	*5825.00	102.9 PK			2.38 V	161	62.30	40.60
3	*5825.00	92.7 AV			2.38 V	161	52.10	40.60
4	#5987.20	58.0 PK	68.2	-10.2	2.38 V	161	50.10	7.90
5	11650.00	61.3 PK	74.0	-12.7	1.68 V	203	42.10	19.20
6	11650.00	48.5 AV	54.0	-5.5	1.68 V	203	29.30	19.20

REMARKS:

1. Emission Level(dBuV/m) = Raw Value(dBuV) + Correction Factor(dB/m)
2. Correction Factor(dB/m) = Antenna Factor(dB/m) + Cable Factor(dB) – Pre-Amplifier Factor(dB)
3. The other emission levels were very low against the limit.
4. Margin value = Emission Level – Limit value
5. " * ": Fundamental frequency.
6. " # ": The radiated frequency is out of the restricted band.



802.11ac (VHT20)_1TX

CHANNEL	TX Channel 36	DETECTOR FUNCTION	Peak (PK)
FREQUENCY RANGE	1GHz ~ 40GHz		Average (AV)

ANTENNA POLARITY & TEST DISTANCE: HORIZONTAL AT 3 M

NO.	FREQ. (MHz)	EMISSION LEVEL (dBuV/m)	LIMIT (dBuV/m)	MARGIN (dB)	ANTENNA HEIGHT (m)	TABLE ANGLE (Degree)	RAW VALUE (dBuV)	CORRECTION FACTOR (dB/m)
1	5150.00	55.6 PK	74.0	-18.4	1.41 H	158	49.60	6.00
2	5150.00	43.3 AV	54.0	-10.7	1.41 H	158	37.30	6.00
3	*5180.00	96.0 PK			1.52 H	172	56.60	39.40
4	*5180.00	85.3 AV			1.52 H	172	45.90	39.40
5	#10360.00	58.4 PK	74.0	-15.6	1.32 H	118	40.60	17.80
6	#10360.00	46.1 AV	54.0	-7.9	1.32 H	118	28.30	17.80

ANTENNA POLARITY & TEST DISTANCE: VERTICAL AT 3 M

NO.	FREQ. (MHz)	EMISSION LEVEL (dBuV/m)	LIMIT (dBuV/m)	MARGIN (dB)	ANTENNA HEIGHT (m)	TABLE ANGLE (Degree)	RAW VALUE (dBuV)	CORRECTION FACTOR (dB/m)
1	5150.00	56.7 PK	74.0	-17.3	1.88 V	306	50.70	6.00
2	5150.00	44.1 AV	54.0	-9.9	1.88 V	306	38.10	6.00
3	*5180.00	103.9 PK			2.05 V	315	64.50	39.40
4	*5180.00	93.3 AV			2.05 V	315	53.90	39.40
5	#10360.00	59.1 PK	74.0	-14.9	2.16 V	167	41.30	17.80
6	#10360.00	46.3 AV	54.0	-7.7	2.16 V	167	28.50	17.80

REMARKS:

1. Emission Level(dBuV/m) = Raw Value(dBuV) + Correction Factor(dB/m)
2. Correction Factor(dB/m) = Antenna Factor(dB/m) + Cable Factor(dB) – Pre-Amplifier Factor(dB)
3. The other emission levels were very low against the limit.
4. Margin value = Emission Level – Limit value
5. " * ": Fundamental frequency.
6. " # ": The radiated frequency is out of the restricted band.

CHANNEL	TX Channel 40	DETECTOR FUNCTION	Peak (PK)
FREQUENCY RANGE	1GHz ~ 40GHz		Average (AV)

ANTENNA POLARITY & TEST DISTANCE: HORIZONTAL AT 3 M

NO.	FREQ. (MHz)	EMISSION LEVEL (dBuV/m)	LIMIT (dBuV/m)	MARGIN (dB)	ANTENNA HEIGHT (m)	TABLE ANGLE (Degree)	RAW VALUE (dBuV)	CORRECTION FACTOR (dB/m)
1	*5200.00	96.8 PK			1.75 H	197	57.30	39.50
2	*5200.00	86.4 AV			1.75 H	197	46.90	39.50
3	#10400.00	58.5 PK	74.0	-15.5	1.62 H	154	40.80	17.70
4	#10400.00	46.0 AV	54.0	-8.0	1.62 H	154	28.30	17.70

ANTENNA POLARITY & TEST DISTANCE: VERTICAL AT 3 M

NO.	FREQ. (MHz)	EMISSION LEVEL (dBuV/m)	LIMIT (dBuV/m)	MARGIN (dB)	ANTENNA HEIGHT (m)	TABLE ANGLE (Degree)	RAW VALUE (dBuV)	CORRECTION FACTOR (dB/m)
1	*5200.00	104.2 PK			1.17 V	323	64.70	39.50
2	*5200.00	93.2 AV			1.17 V	323	53.70	39.50
3	#10400.00	59.8 PK	74.0	-14.2	1.34 V	164	42.10	17.70
4	#10400.00	46.3 AV	54.0	-7.7	1.34 V	164	28.60	17.70

REMARKS:

1. Emission Level(dBuV/m) = Raw Value(dBuV) + Correction Factor(dB/m)
2. Correction Factor(dB/m) = Antenna Factor(dB/m) + Cable Factor(dB) – Pre-Amplifier Factor(dB)
3. The other emission levels were very low against the limit.
4. Margin value = Emission Level – Limit value
5. " * ": Fundamental frequency.
6. " # ": The radiated frequency is out of the restricted band.

CHANNEL	TX Channel 48	DETECTOR FUNCTION	Peak (PK)
FREQUENCY RANGE	1GHz ~ 40GHz		Average (AV)

ANTENNA POLARITY & TEST DISTANCE: HORIZONTAL AT 3 M

NO.	FREQ. (MHz)	EMISSION LEVEL (dBuV/m)	LIMIT (dBuV/m)	MARGIN (dB)	ANTENNA HEIGHT (m)	TABLE ANGLE (Degree)	RAW VALUE (dBuV)	CORRECTION FACTOR (dB/m)
1	*5240.00	95.6 PK			1.92 H	204	56.00	39.60
2	*5240.00	85.3 AV			1.92 H	204	45.70	39.60
3	5350.00	56.3 PK	74.0	-17.7	1.78 H	190	49.80	6.50
4	5350.00	44.3 AV	54.0	-9.7	1.78 H	190	37.80	6.50
5	#10480.00	58.4 PK	74.0	-15.6	1.62 H	134	39.70	18.70
6	#10480.00	45.8 AV	54.0	-8.2	1.62 H	134	27.10	18.70

ANTENNA POLARITY & TEST DISTANCE: VERTICAL AT 3 M

NO.	FREQ. (MHz)	EMISSION LEVEL (dBuV/m)	LIMIT (dBuV/m)	MARGIN (dB)	ANTENNA HEIGHT (m)	TABLE ANGLE (Degree)	RAW VALUE (dBuV)	CORRECTION FACTOR (dB/m)
1	*5240.00	104.1 PK			1.94 V	317	64.50	39.60
2	*5240.00	93.7 AV			1.94 V	317	54.10	39.60
3	5350.00	56.4 PK	74.0	-17.6	1.79 V	303	49.90	6.50
4	5350.00	44.0 AV	54.0	-10.0	1.79 V	303	37.50	6.50
5	#10480.00	58.6 PK	74.0	-15.4	1.73 V	231	39.90	18.70
6	#10480.00	46.3 AV	54.0	-7.7	1.73 V	231	27.60	18.70

REMARKS:

1. Emission Level(dBuV/m) = Raw Value(dBuV) + Correction Factor(dB/m)
2. Correction Factor(dB/m) = Antenna Factor(dB/m) + Cable Factor(dB) – Pre-Amplifier Factor(dB)
3. The other emission levels were very low against the limit.
4. Margin value = Emission Level – Limit value
5. " * ": Fundamental frequency.
6. " # ": The radiated frequency is out of the restricted band.

CHANNEL	TX Channel 52	DETECTOR FUNCTION	Peak (PK)
FREQUENCY RANGE	1GHz ~ 40GHz		Average (AV)

ANTENNA POLARITY & TEST DISTANCE: HORIZONTAL AT 3 M

NO.	FREQ. (MHz)	EMISSION LEVEL (dBuV/m)	LIMIT (dBuV/m)	MARGIN (dB)	ANTENNA HEIGHT (m)	TABLE ANGLE (Degree)	RAW VALUE (dBuV)	CORRECTION FACTOR (dB/m)
1	*5260.00	96.4 PK			1.69 H	199	56.80	39.60
2	*5260.00	86.1 AV			1.69 H	199	46.50	39.60
3	5350.00	47.5 PK	74.0	-26.5	1.76 H	184	41.00	6.50
4	5350.00	44.6 AV	54.0	-9.4	1.76 H	184	38.10	6.50
5	#10520.00	59.0 PK	74.0	-15.0	1.57 H	110	40.10	18.90
6	#10520.00	46.0 AV	54.0	-8.0	1.57 H	110	27.10	18.90

ANTENNA POLARITY & TEST DISTANCE: VERTICAL AT 3 M

NO.	FREQ. (MHz)	EMISSION LEVEL (dBuV/m)	LIMIT (dBuV/m)	MARGIN (dB)	ANTENNA HEIGHT (m)	TABLE ANGLE (Degree)	RAW VALUE (dBuV)	CORRECTION FACTOR (dB/m)
1	*5260.00	104.8 PK			1.00 V	291	65.20	39.60
2	*5260.00	94.1 AV			1.00 V	291	54.50	39.60
3	5350.00	57.2 PK	74.0	-16.8	1.11 V	281	50.70	6.50
4	5350.00	44.3 AV	54.0	-9.7	1.11 V	281	37.80	6.50
5	#10520.00	58.3 PK	74.0	-15.7	1.23 V	215	39.40	18.90
6	#10520.00	46.0 AV	54.0	-8.0	1.23 V	215	27.10	18.90

REMARKS:

1. Emission Level(dBuV/m) = Raw Value(dBuV) + Correction Factor(dB/m)
2. Correction Factor(dB/m) = Antenna Factor(dB/m) + Cable Factor(dB) – Pre-Amplifier Factor(dB)
3. The other emission levels were very low against the limit.
4. Margin value = Emission Level – Limit value
5. " * ": Fundamental frequency.
6. " # ": The radiated frequency is out of the restricted band.

CHANNEL	TX Channel 60	DETECTOR FUNCTION	Peak (PK)
FREQUENCY RANGE	1GHz ~ 40GHz		Average (AV)

ANTENNA POLARITY & TEST DISTANCE: HORIZONTAL AT 3 M

NO.	FREQ. (MHz)	EMISSION LEVEL (dBuV/m)	LIMIT (dBuV/m)	MARGIN (dB)	ANTENNA HEIGHT (m)	TABLE ANGLE (Degree)	RAW VALUE (dBuV)	CORRECTION FACTOR (dB/m)
1	*5300.00	96.6 PK			1.48 H	201	56.90	39.70
2	*5300.00	86.0 AV			1.48 H	201	46.30	39.70
3	10600.00	58.4 PK	74.0	-15.6	1.63 H	252	39.50	18.90
4	10600.00	46.3 AV	54.0	-7.7	1.63 H	252	27.40	18.90

ANTENNA POLARITY & TEST DISTANCE: VERTICAL AT 3 M

NO.	FREQ. (MHz)	EMISSION LEVEL (dBuV/m)	LIMIT (dBuV/m)	MARGIN (dB)	ANTENNA HEIGHT (m)	TABLE ANGLE (Degree)	RAW VALUE (dBuV)	CORRECTION FACTOR (dB/m)
1	*5300.00	104.3 PK			2.04 V	319	64.60	39.70
2	*5300.00	93.5 AV			2.04 V	319	53.80	39.70
3	10600.00	59.3 PK	74.0	-14.7	1.76 V	244	40.40	18.90
4	10600.00	46.4 AV	54.0	-7.6	1.76 V	244	27.50	18.90

REMARKS:

1. Emission Level(dBuV/m) = Raw Value(dBuV) + Correction Factor(dB/m)
2. Correction Factor(dB/m) = Antenna Factor(dB/m) + Cable Factor(dB) – Pre-Amplifier Factor(dB)
3. The other emission levels were very low against the limit.
4. Margin value = Emission Level – Limit value
5. " * ": Fundamental frequency.

CHANNEL	TX Channel 64	DETECTOR FUNCTION	Peak (PK)
FREQUENCY RANGE	1GHz ~ 40GHz		Average (AV)

ANTENNA POLARITY & TEST DISTANCE: HORIZONTAL AT 3 M

NO.	FREQ. (MHz)	EMISSION LEVEL (dBuV/m)	LIMIT (dBuV/m)	MARGIN (dB)	ANTENNA HEIGHT (m)	TABLE ANGLE (Degree)	RAW VALUE (dBuV)	CORRECTION FACTOR (dB/m)
1	*5320.00	97.5 PK			1.71 H	196	57.80	39.70
2	*5320.00	86.5 AV			1.71 H	196	46.80	39.70
3	5350.00	56.6 PK	74.0	-17.4	1.53 H	175	50.10	6.50
4	5350.00	44.0 AV	54.0	-10.0	1.53 H	175	37.50	6.50
5	10640.00	57.5 PK	74.0	-16.5	1.38 H	99	38.70	18.80
6	10640.00	45.5 AV	54.0	-8.5	1.38 H	99	26.70	18.80

ANTENNA POLARITY & TEST DISTANCE: VERTICAL AT 3 M

NO.	FREQ. (MHz)	EMISSION LEVEL (dBuV/m)	LIMIT (dBuV/m)	MARGIN (dB)	ANTENNA HEIGHT (m)	TABLE ANGLE (Degree)	RAW VALUE (dBuV)	CORRECTION FACTOR (dB/m)
1	*5320.00	105.4 PK			2.09 V	283	65.70	39.70
2	*5320.00	94.6 AV			2.09 V	283	54.90	39.70
3	5350.00	49.0 PK	74.0	-25.0	2.21 V	282	42.50	6.50
4	5350.00	45.9 AV	54.0	-8.1	2.21 V	282	39.40	6.50
5	10640.00	57.5 PK	74.0	-16.5	1.67 V	243	38.70	18.80
6	10640.00	45.3 AV	54.0	-8.7	1.67 V	243	26.50	18.80

REMARKS:

1. Emission Level(dBuV/m) = Raw Value(dBuV) + Correction Factor(dB/m)
2. Correction Factor(dB/m) = Antenna Factor(dB/m) + Cable Factor(dB) – Pre-Amplifier Factor(dB)
3. The other emission levels were very low against the limit.
4. Margin value = Emission Level – Limit value
5. " * ": Fundamental frequency.



CHANNEL	TX Channel 100	DETECTOR FUNCTION	Peak (PK)
FREQUENCY RANGE	1GHz ~ 40GHz		Average (AV)

ANTENNA POLARITY & TEST DISTANCE: HORIZONTAL AT 3 M

NO.	FREQ. (MHz)	EMISSION LEVEL (dBuV/m)	LIMIT (dBuV/m)	MARGIN (dB)	ANTENNA HEIGHT (m)	TABLE ANGLE (Degree)	RAW VALUE (dBuV)	CORRECTION FACTOR (dB/m)
1	5460.00	57.6 PK	74.0	-16.4	1.31 H	221	50.70	6.90
2	5460.00	45.0 AV	54.0	-9.0	1.31 H	221	38.10	6.90
3	#5470.00	58.1 PK	74.0	-15.9	1.44 H	209	51.20	6.90
4	#5470.00	44.7 AV	54.0	-9.3	1.44 H	209	37.80	6.90
5	*5500.00	97.8 PK			1.34 H	191	57.60	40.20
6	*5500.00	87.6 AV			1.34 H	191	47.40	40.20
7	11000.00	59.3 PK	74.0	-14.7	1.42 H	128	39.40	19.90
8	11000.00	47.3 AV	54.0	-6.7	1.42 H	128	27.40	19.90

ANTENNA POLARITY & TEST DISTANCE: VERTICAL AT 3 M

NO.	FREQ. (MHz)	EMISSION LEVEL (dBuV/m)	LIMIT (dBuV/m)	MARGIN (dB)	ANTENNA HEIGHT (m)	TABLE ANGLE (Degree)	RAW VALUE (dBuV)	CORRECTION FACTOR (dB/m)
1	5460.00	57.6 PK	74.0	-16.4	1.63 V	320	50.70	6.90
2	5460.00	45.4 AV	54.0	-8.6	1.63 V	320	38.50	6.90
3	#5470.00	59.0 PK	74.0	-15.0	1.56 V	322	52.10	6.90
4	#5470.00	45.6 AV	54.0	-8.4	1.56 V	322	38.70	6.90
5	*5500.00	103.5 PK			1.52 V	322	63.30	40.20
6	*5500.00	92.5 AV			1.52 V	322	52.30	40.20
7	11000.00	60.1 PK	74.0	-13.9	1.67 V	69	40.20	19.90
8	11000.00	47.0 AV	54.0	-7.0	1.67 V	69	27.10	19.90

REMARKS:

1. Emission Level(dBuV/m) = Raw Value(dBuV) + Correction Factor(dB/m)
2. Correction Factor(dB/m) = Antenna Factor(dB/m) + Cable Factor(dB) – Pre-Amplifier Factor(dB)
3. The other emission levels were very low against the limit.
4. Margin value = Emission Level – Limit value
5. " * " : Fundamental frequency.
6. " # " : The radiated frequency is out of the restricted band.

CHANNEL	TX Channel 116	DETECTOR FUNCTION	Peak (PK)
FREQUENCY RANGE	1GHz ~ 40GHz		Average (AV)

ANTENNA POLARITY & TEST DISTANCE: HORIZONTAL AT 3 M

NO.	FREQ. (MHz)	EMISSION LEVEL (dBuV/m)	LIMIT (dBuV/m)	MARGIN (dB)	ANTENNA HEIGHT (m)	TABLE ANGLE (Degree)	RAW VALUE (dBuV)	CORRECTION FACTOR (dB/m)
1	*5580.00	98.0 PK			1.49 H	189	57.70	40.30
2	*5580.00	88.0 AV			1.49 H	189	47.70	40.30
3	11160.00	60.2 PK	74.0	-13.8	1.29 H	202	40.80	19.40
4	11160.00	46.8 AV	54.0	-7.2	1.29 H	202	27.40	19.40

ANTENNA POLARITY & TEST DISTANCE: VERTICAL AT 3 M

NO.	FREQ. (MHz)	EMISSION LEVEL (dBuV/m)	LIMIT (dBuV/m)	MARGIN (dB)	ANTENNA HEIGHT (m)	TABLE ANGLE (Degree)	RAW VALUE (dBuV)	CORRECTION FACTOR (dB/m)
1	*5580.00	103.1 PK			1.53 V	311	62.80	40.30
2	*5580.00	92.3 AV			1.53 V	311	52.00	40.30
3	11160.00	59.1 PK	74.0	-14.9	1.60 V	218	39.70	19.40
4	11160.00	47.0 AV	54.0	-7.0	1.60 V	218	27.60	19.40

REMARKS:

1. Emission Level(dBuV/m) = Raw Value(dBuV) + Correction Factor(dB/m)
2. Correction Factor(dB/m) = Antenna Factor(dB/m) + Cable Factor(dB) – Pre-Amplifier Factor(dB)
3. The other emission levels were very low against the limit.
4. Margin value = Emission Level – Limit value
5. " * ": Fundamental frequency.

CHANNEL	TX Channel 140	DETECTOR FUNCTION	Peak (PK)
FREQUENCY RANGE	1GHz ~ 40GHz		Average (AV)

ANTENNA POLARITY & TEST DISTANCE: HORIZONTAL AT 3 M

NO.	FREQ. (MHz)	EMISSION LEVEL (dBuV/m)	LIMIT (dBuV/m)	MARGIN (dB)	ANTENNA HEIGHT (m)	TABLE ANGLE (Degree)	RAW VALUE (dBuV)	CORRECTION FACTOR (dB/m)
1	*5700.00	96.5 PK			1.36 H	201	56.10	40.40
2	*5700.00	86.5 AV			1.36 H	201	46.10	40.40
3	#5725.00	58.5 PK	74.0	-15.5	1.44 H	179	51.10	7.40
4	#5725.00	45.2 AV	54.0	-8.8	1.44 H	179	37.80	7.40
5	11400.00	59.5 PK	74.0	-14.5	1.34 H	115	40.70	18.80
6	11400.00	47.4 AV	54.0	-6.6	1.34 H	115	28.60	18.80

ANTENNA POLARITY & TEST DISTANCE: VERTICAL AT 3 M

NO.	FREQ. (MHz)	EMISSION LEVEL (dBuV/m)	LIMIT (dBuV/m)	MARGIN (dB)	ANTENNA HEIGHT (m)	TABLE ANGLE (Degree)	RAW VALUE (dBuV)	CORRECTION FACTOR (dB/m)
1	*5700.00	100.1 PK			1.32 V	322	59.70	40.40
2	*5700.00	89.4 AV			1.32 V	322	49.00	40.40
3	#5725.00	58.4 PK	74.0	-15.6	1.41 V	312	51.00	7.40
4	#5725.00	45.7 AV	54.0	-8.3	1.41 V	312	38.30	7.40
5	11400.00	60.1 PK	74.0	-13.9	1.33 V	218	41.30	18.80
6	11400.00	47.4 AV	54.0	-6.6	1.33 V	218	28.60	18.80

REMARKS:

1. Emission Level(dBuV/m) = Raw Value(dBuV) + Correction Factor(dB/m)
2. Correction Factor(dB/m) = Antenna Factor(dB/m) + Cable Factor(dB) – Pre-Amplifier Factor(dB)
3. The other emission levels were very low against the limit.
4. Margin value = Emission Level – Limit value
5. " * ": Fundamental frequency.
6. " # ": The radiated frequency is out of the restricted band.

CHANNEL	TX Channel 144	DETECTOR FUNCTION	Peak (PK)
FREQUENCY RANGE	1GHz ~ 40GHz		Average (AV)

ANTENNA POLARITY & TEST DISTANCE: HORIZONTAL AT 3 M

NO.	FREQ. (MHz)	EMISSION LEVEL (dBuV/m)	LIMIT (dBuV/m)	MARGIN (dB)	ANTENNA HEIGHT (m)	TABLE ANGLE (Degree)	RAW VALUE (dBuV)	CORRECTION FACTOR (dB/m)
1	#5470.00	58.0 PK	74.0	-16.0	1.46 H	179	51.10	6.90
2	#5470.00	45.7 AV	54.0	-8.3	1.46 H	179	38.80	6.90
3	*5720.00	96.5 PK			1.39 H	211	56.00	40.50
4	*5720.00	85.6 AV			1.39 H	211	45.10	40.50
5	#5850.00	58.9 PK	74.0	-15.1	1.33 H	205	51.30	7.60
6	#5850.00	45.7 AV	54.0	-8.3	1.33 H	205	38.10	7.60
7	11440.00	59.4 PK	74.0	-14.6	1.34 H	115	40.70	18.70
8	11440.00	47.3 AV	54.0	-6.7	1.34 H	115	28.60	18.70

ANTENNA POLARITY & TEST DISTANCE: VERTICAL AT 3 M

NO.	FREQ. (MHz)	EMISSION LEVEL (dBuV/m)	LIMIT (dBuV/m)	MARGIN (dB)	ANTENNA HEIGHT (m)	TABLE ANGLE (Degree)	RAW VALUE (dBuV)	CORRECTION FACTOR (dB/m)
1	#5470.00	56.9 PK	74.0	-17.1	1.46 V	312	50.00	6.90
2	#5470.00	45.9 AV	54.0	-8.1	1.49 V	312	39.00	6.90
3	*5720.00	99.9 PK			1.30 V	329	59.40	40.50
4	*5720.00	89.7 AV			1.30 V	329	49.20	40.50
5	#5850.00	59.1 PK	74.0	-14.9	1.32 V	288	51.50	7.60
6	#5850.00	46.6 AV	54.0	-7.4	1.32 V	288	39.00	7.60
7	11440.00	59.7 PK	74.0	-14.3	1.30 V	220	41.00	18.70
8	11440.00	46.3 AV	54.0	-7.7	1.30 V	220	27.60	18.70

REMARKS:

1. Emission Level(dBuV/m) = Raw Value(dBuV) + Correction Factor(dB/m)
2. Correction Factor(dB/m) = Antenna Factor(dB/m) + Cable Factor(dB) – Pre-Amplifier Factor(dB)
3. The other emission levels were very low against the limit.
4. Margin value = Emission Level – Limit value
5. " * ": Fundamental frequency.
6. " # ": The radiated frequency is out of the restricted band.

CHANNEL	TX Channel 149	DETECTOR FUNCTION	Peak (PK)
FREQUENCY RANGE	1GHz ~ 40GHz		Average (AV)

ANTENNA POLARITY & TEST DISTANCE: HORIZONTAL AT 3 M

NO.	FREQ. (MHz)	EMISSION LEVEL (dBuV/m)	LIMIT (dBuV/m)	MARGIN (dB)	ANTENNA HEIGHT (m)	TABLE ANGLE (Degree)	RAW VALUE (dBuV)	CORRECTION FACTOR (dB/m)
1	#5603.20	56.7 PK	68.2	-11.5	1.52 H	193	49.60	7.10
2	*5745.00	97.8 PK			1.52 H	193	57.30	40.50
3	*5745.00	86.9 AV			1.52 H	193	46.40	40.50
4	#5972.80	57.1 PK	68.2	-11.1	1.52 H	193	49.20	7.90
5	11490.00	59.2 PK	74.0	-14.8	1.58 H	202	40.50	18.70
6	11490.00	46.0 AV	54.0	-8.0	1.58 H	202	27.30	18.70

ANTENNA POLARITY & TEST DISTANCE: VERTICAL AT 3 M

NO.	FREQ. (MHz)	EMISSION LEVEL (dBuV/m)	LIMIT (dBuV/m)	MARGIN (dB)	ANTENNA HEIGHT (m)	TABLE ANGLE (Degree)	RAW VALUE (dBuV)	CORRECTION FACTOR (dB/m)
1	#5621.60	57.5 PK	68.2	-10.7	3.29 V	299	50.40	7.10
2	*5745.00	105.3 PK			3.29 V	299	64.80	40.50
3	*5745.00	95.0 AV			3.29 V	299	54.50	40.50
4	#5983.20	58.3 PK	68.2	-9.9	3.29 V	299	50.40	7.90
5	11490.00	59.4 PK	74.0	-14.6	3.09 V	320	40.70	18.70
6	11490.00	46.8 AV	54.0	-7.2	3.09 V	320	28.10	18.70

REMARKS:

1. Emission Level(dBuV/m) = Raw Value(dBuV) + Correction Factor(dB/m)
2. Correction Factor(dB/m) = Antenna Factor(dB/m) + Cable Factor(dB) – Pre-Amplifier Factor(dB)
3. The other emission levels were very low against the limit.
4. Margin value = Emission Level – Limit value
5. " * ": Fundamental frequency.
6. " # ": The radiated frequency is out of the restricted band.

CHANNEL	TX Channel 157	DETECTOR FUNCTION	Peak (PK)
FREQUENCY RANGE	1GHz ~ 40GHz		Average (AV)

ANTENNA POLARITY & TEST DISTANCE: HORIZONTAL AT 3 M

NO.	FREQ. (MHz)	EMISSION LEVEL (dBuV/m)	LIMIT (dBuV/m)	MARGIN (dB)	ANTENNA HEIGHT (m)	TABLE ANGLE (Degree)	RAW VALUE (dBuV)	CORRECTION FACTOR (dB/m)
1	#5628.80	56.7 PK	68.2	-11.5	1.52 H	206	49.60	7.10
2	*5785.00	96.1 PK			1.52 H	206	55.50	40.60
3	*5785.00	85.3 AV			1.52 H	206	44.70	40.60
4	#5936.80	57.4 PK	68.2	-10.8	1.52 H	206	49.70	7.70
5	11570.00	59.4 PK	74.0	-14.6	1.39 H	228	40.70	18.70
6	11570.00	46.7 AV	54.0	-7.3	1.39 H	228	28.00	18.70

ANTENNA POLARITY & TEST DISTANCE: VERTICAL AT 3 M

NO.	FREQ. (MHz)	EMISSION LEVEL (dBuV/m)	LIMIT (dBuV/m)	MARGIN (dB)	ANTENNA HEIGHT (m)	TABLE ANGLE (Degree)	RAW VALUE (dBuV)	CORRECTION FACTOR (dB/m)
1	#5635.20	57.9 PK	68.2	-10.3	3.16 V	342	50.80	7.10
2	*5785.00	104.8 PK			3.16 V	342	64.20	40.60
3	*5785.00	94.4 AV			3.16 V	342	53.80	40.60
4	#5936.00	58.7 PK	68.2	-9.5	3.16 V	342	51.00	7.70
5	11570.00	60.5 PK	74.0	-13.5	3.02 V	354	41.80	18.70
6	11570.00	46.7 AV	54.0	-7.3	3.02 V	354	28.00	18.70

REMARKS:

1. Emission Level(dBuV/m) = Raw Value(dBuV) + Correction Factor(dB/m)
2. Correction Factor(dB/m) = Antenna Factor(dB/m) + Cable Factor(dB) – Pre-Amplifier Factor(dB)
3. The other emission levels were very low against the limit.
4. Margin value = Emission Level – Limit value
5. " * ": Fundamental frequency.

CHANNEL	TX Channel 165	DETECTOR FUNCTION	Peak (PK)
FREQUENCY RANGE	1GHz ~ 40GHz		Average (AV)

ANTENNA POLARITY & TEST DISTANCE: HORIZONTAL AT 3 M

NO.	FREQ. (MHz)	EMISSION LEVEL (dBuV/m)	LIMIT (dBuV/m)	MARGIN (dB)	ANTENNA HEIGHT (m)	TABLE ANGLE (Degree)	RAW VALUE (dBuV)	CORRECTION FACTOR (dB/m)
1	#5638.40	57.7 PK	68.2	-10.5	1.36 H	207	50.60	7.10
2	*5825.00	97.5 PK			1.36 H	207	56.90	40.60
3	*5825.00	86.4 AV			1.36 H	207	45.80	40.60
4	#5971.20	57.2 PK	68.2	-11.0	1.36 H	207	49.40	7.80
5	11650.00	59.6 PK	74.0	-14.4	1.22 H	134	40.40	19.20
6	11650.00	47.5 AV	54.0	-6.5	1.22 H	134	28.30	19.20

ANTENNA POLARITY & TEST DISTANCE: VERTICAL AT 3 M

NO.	FREQ. (MHz)	EMISSION LEVEL (dBuV/m)	LIMIT (dBuV/m)	MARGIN (dB)	ANTENNA HEIGHT (m)	TABLE ANGLE (Degree)	RAW VALUE (dBuV)	CORRECTION FACTOR (dB/m)
1	#5628.00	57.0 PK	68.2	-11.2	3.50 V	301	49.90	7.10
2	*5825.00	104.9 PK			3.50 V	301	64.30	40.60
3	*5825.00	95.1 AV			3.50 V	301	54.50	40.60
4	#5945.60	58.8 PK	68.2	-9.4	3.50 V	301	51.10	7.70
5	11650.00	59.8 PK	74.0	-14.2	2.84 V	246	40.60	19.20
6	11650.00	47.2 AV	54.0	-6.8	2.84 V	246	28.00	19.20

REMARKS:

1. Emission Level(dBuV/m) = Raw Value(dBuV) + Correction Factor(dB/m)
2. Correction Factor(dB/m) = Antenna Factor(dB/m) + Cable Factor(dB) – Pre-Amplifier Factor(dB)
3. The other emission levels were very low against the limit.
4. Margin value = Emission Level – Limit value
5. " * ": Fundamental frequency.
6. " # ": The radiated frequency is out of the restricted band.

802.11ac (VHT40)_1TX

CHANNEL	TX Channel 38	DETECTOR FUNCTION	Peak (PK)
FREQUENCY RANGE	1GHz ~ 40GHz		Average (AV)

ANTENNA POLARITY & TEST DISTANCE: HORIZONTAL AT 3 M

NO.	FREQ. (MHz)	EMISSION LEVEL (dBuV/m)	LIMIT (dBuV/m)	MARGIN (dB)	ANTENNA HEIGHT (m)	TABLE ANGLE (Degree)	RAW VALUE (dBuV)	CORRECTION FACTOR (dB/m)
1	5150.00	56.7 PK	74.0	-17.3	1.06 H	163	50.70	6.00
2	5150.00	44.2 AV	54.0	-9.8	1.06 H	163	38.20	6.00
3	*5190.00	92.9 PK			1.00 H	159	53.50	39.40
4	*5190.00	83.0 AV			1.00 H	159	43.60	39.40
5	#10380.00	58.5 PK	74.0	-15.5	1.17 H	108	40.80	17.70
6	#10380.00	46.2 AV	54.0	-7.8	1.17 H	108	28.50	17.70

ANTENNA POLARITY & TEST DISTANCE: VERTICAL AT 3 M

NO.	FREQ. (MHz)	EMISSION LEVEL (dBuV/m)	LIMIT (dBuV/m)	MARGIN (dB)	ANTENNA HEIGHT (m)	TABLE ANGLE (Degree)	RAW VALUE (dBuV)	CORRECTION FACTOR (dB/m)
1	5150.00	61.4 PK	74.0	-12.6	1.96 V	295	55.40	6.00
2	5150.00	48.0 AV	54.0	-6.0	1.96 V	295	42.00	6.00
3	*5190.00	99.5 PK			1.98 V	315	60.10	39.40
4	*5190.00	89.7 AV			1.98 V	315	50.30	39.40
5	#10380.00	58.4 PK	74.0	-15.6	1.81 V	218	40.70	17.70
6	#10380.00	46.4 AV	54.0	-7.6	1.81 V	218	28.70	17.70

REMARKS:

1. Emission Level(dBuV/m) = Raw Value(dBuV) + Correction Factor(dB/m)
2. Correction Factor(dB/m) = Antenna Factor(dB/m) + Cable Factor(dB) – Pre-Amplifier Factor(dB)
3. The other emission levels were very low against the limit.
4. Margin value = Emission Level – Limit value
5. " * ": Fundamental frequency.
6. " # ": The radiated frequency is out of the restricted band.

CHANNEL	TX Channel 46	DETECTOR FUNCTION	Peak (PK)
FREQUENCY RANGE	1GHz ~ 40GHz		Average (AV)

ANTENNA POLARITY & TEST DISTANCE: HORIZONTAL AT 3 M

NO.	FREQ. (MHz)	EMISSION LEVEL (dBuV/m)	LIMIT (dBuV/m)	MARGIN (dB)	ANTENNA HEIGHT (m)	TABLE ANGLE (Degree)	RAW VALUE (dBuV)	CORRECTION FACTOR (dB/m)
1	5150.00	55.9 PK	74.0	-18.1	1.06 H	155	49.90	6.00
2	5150.00	44.2 AV	54.0	-9.8	1.06 H	155	38.20	6.00
3	*5230.00	93.1 PK			1.02 H	161	53.50	39.60
4	*5230.00	83.1 AV			1.02 H	161	43.50	39.60
5	#10460.00	58.6 PK	74.0	-15.4	1.04 H	187	40.10	18.50
6	#10460.00	46.4 AV	54.0	-7.6	1.04 H	187	27.90	18.50

ANTENNA POLARITY & TEST DISTANCE: VERTICAL AT 3 M

NO.	FREQ. (MHz)	EMISSION LEVEL (dBuV/m)	LIMIT (dBuV/m)	MARGIN (dB)	ANTENNA HEIGHT (m)	TABLE ANGLE (Degree)	RAW VALUE (dBuV)	CORRECTION FACTOR (dB/m)
1	*5230.00	100.0 PK			1.94 V	305	60.40	39.60
2	*5230.00	90.5 AV			1.94 V	305	50.90	39.60
3	5350.00	56.6 PK	74.0	-17.4	1.78 V	295	50.10	6.50
4	5350.00	45.3 AV	54.0	-8.7	1.78 V	295	38.80	6.50
5	#10460.00	58.1 PK	74.0	-15.9	1.64 V	321	39.60	18.50
6	#10460.00	46.8 AV	54.0	-7.2	1.64 V	321	28.30	18.50

REMARKS:

1. Emission Level(dBuV/m) = Raw Value(dBuV) + Correction Factor(dB/m)
2. Correction Factor(dB/m) = Antenna Factor(dB/m) + Cable Factor(dB) – Pre-Amplifier Factor(dB)
3. The other emission levels were very low against the limit.
4. Margin value = Emission Level – Limit value
5. " * ": Fundamental frequency.
6. " # ": The radiated frequency is out of the restricted band.

CHANNEL	TX Channel 54	DETECTOR FUNCTION	Peak (PK)
FREQUENCY RANGE	1GHz ~ 40GHz		Average (AV)

ANTENNA POLARITY & TEST DISTANCE: HORIZONTAL AT 3 M

NO.	FREQ. (MHz)	EMISSION LEVEL (dBuV/m)	LIMIT (dBuV/m)	MARGIN (dB)	ANTENNA HEIGHT (m)	TABLE ANGLE (Degree)	RAW VALUE (dBuV)	CORRECTION FACTOR (dB/m)
1	*5270.00	92.1 PK			1.00 H	162	52.50	39.60
2	*5270.00	83.0 AV			1.00 H	162	43.40	39.60
3	5350.00	57.2 PK	74.0	-16.8	1.11 H	184	50.70	6.50
4	5350.00	45.0 AV	54.0	-9.0	1.11 H	184	38.50	6.50
5	#10540.00	58.1 PK	74.0	-15.9	1.22 H	84	39.10	19.00
6	#10540.00	46.6 AV	54.0	-7.4	1.22 H	84	27.60	19.00

ANTENNA POLARITY & TEST DISTANCE: VERTICAL AT 3 M

NO.	FREQ. (MHz)	EMISSION LEVEL (dBuV/m)	LIMIT (dBuV/m)	MARGIN (dB)	ANTENNA HEIGHT (m)	TABLE ANGLE (Degree)	RAW VALUE (dBuV)	CORRECTION FACTOR (dB/m)
1	*5270.00	100.2 PK			1.77 V	314	60.60	39.60
2	*5270.00	90.2 AV			1.77 V	314	50.60	39.60
3	5350.00	57.2 PK	74.0	-16.8	1.63 V	326	50.70	6.50
4	5350.00	45.6 AV	54.0	-8.4	1.63 V	326	39.10	6.50
5	#10540.00	59.0 PK	74.0	-15.0	1.53 V	294	40.00	19.00
6	#10540.00	47.3 AV	54.0	-6.7	1.53 V	294	28.30	19.00

REMARKS:

1. Emission Level(dBuV/m) = Raw Value(dBuV) + Correction Factor(dB/m)
2. Correction Factor(dB/m) = Antenna Factor(dB/m) + Cable Factor(dB) – Pre-Amplifier Factor(dB)
3. The other emission levels were very low against the limit.
4. Margin value = Emission Level – Limit value
5. " * ": Fundamental frequency.
6. " # ": The radiated frequency is out of the restricted band.

CHANNEL	TX Channel 62	DETECTOR FUNCTION	Peak (PK)
FREQUENCY RANGE	1GHz ~ 40GHz		Average (AV)

ANTENNA POLARITY & TEST DISTANCE: HORIZONTAL AT 3 M

NO.	FREQ. (MHz)	EMISSION LEVEL (dBuV/m)	LIMIT (dBuV/m)	MARGIN (dB)	ANTENNA HEIGHT (m)	TABLE ANGLE (Degree)	RAW VALUE (dBuV)	CORRECTION FACTOR (dB/m)
1	*5310.00	93.7 PK			1.00 H	164	54.00	39.70
2	*5310.00	83.6 AV			1.00 H	164	43.90	39.70
3	5350.00	57.0 PK	74.0	-17.0	1.06 H	184	50.50	6.50
4	5350.00	45.1 AV	54.0	-8.9	1.06 H	184	38.60	6.50
5	10620.00	59.1 PK	74.0	-14.9	1.17 H	152	40.20	18.90
6	10620.00	46.2 AV	54.0	-7.8	1.17 H	152	27.30	18.90

ANTENNA POLARITY & TEST DISTANCE: VERTICAL AT 3 M

NO.	FREQ. (MHz)	EMISSION LEVEL (dBuV/m)	LIMIT (dBuV/m)	MARGIN (dB)	ANTENNA HEIGHT (m)	TABLE ANGLE (Degree)	RAW VALUE (dBuV)	CORRECTION FACTOR (dB/m)
1	*5310.00	100.3 PK			1.95 V	316	60.60	39.70
2	*5310.00	90.5 AV			1.95 V	316	50.80	39.70
3	5350.00	58.8 PK	74.0	-15.2	1.82 V	315	52.30	6.50
4	5350.00	46.6 AV	54.0	-7.4	1.82 V	315	40.10	6.50
5	10620.00	58.6 PK	74.0	-15.4	1.69 V	255	39.70	18.90
6	10620.00	46.8 AV	54.0	-7.2	1.69 V	255	27.90	18.90

REMARKS:

1. Emission Level(dBuV/m) = Raw Value(dBuV) + Correction Factor(dB/m)
2. Correction Factor(dB/m) = Antenna Factor(dB/m) + Cable Factor(dB) – Pre-Amplifier Factor(dB)
3. The other emission levels were very low against the limit.
4. Margin value = Emission Level – Limit value
5. " * ": Fundamental frequency.

CHANNEL	TX Channel 102	DETECTOR FUNCTION	Peak (PK)
FREQUENCY RANGE	1GHz ~ 40GHz		Average (AV)

ANTENNA POLARITY & TEST DISTANCE: HORIZONTAL AT 3 M

NO.	FREQ. (MHz)	EMISSION LEVEL (dBuV/m)	LIMIT (dBuV/m)	MARGIN (dB)	ANTENNA HEIGHT (m)	TABLE ANGLE (Degree)	RAW VALUE (dBuV)	CORRECTION FACTOR (dB/m)
1	5460.00	57.8 PK	74.0	-16.2	1.57 H	146	50.90	6.90
2	5460.00	46.0 AV	54.0	-8.0	1.57 H	146	39.10	6.90
3	#5470.00	59.1 PK	74.0	-14.9	1.48 H	135	52.20	6.90
4	#5470.00	46.6 AV	54.0	-7.4	1.48 H	135	39.70	6.90
5	*5510.00	94.0 PK			1.38 H	136	53.80	40.20
6	*5510.00	85.0 AV			1.38 H	136	44.80	40.20
7	11020.00	59.9 PK	74.0	-14.1	1.44 H	159	40.10	19.80
8	11020.00	48.5 AV	54.0	-5.5	1.44 H	159	28.70	19.80

ANTENNA POLARITY & TEST DISTANCE: VERTICAL AT 3 M

NO.	FREQ. (MHz)	EMISSION LEVEL (dBuV/m)	LIMIT (dBuV/m)	MARGIN (dB)	ANTENNA HEIGHT (m)	TABLE ANGLE (Degree)	RAW VALUE (dBuV)	CORRECTION FACTOR (dB/m)
1	5460.00	58.2 PK	74.0	-15.8	1.57 V	313	51.30	6.90
2	5460.00	46.5 AV	54.0	-7.5	1.57 V	313	39.60	6.90
3	#5470.00	61.2 PK	74.0	-12.8	1.48 V	326	54.30	6.90
4	#5470.00	48.0 AV	54.0	-6.0	1.48 V	326	41.10	6.90
5	*5510.00	98.5 PK			1.46 V	323	58.30	40.20
6	*5510.00	89.3 AV			1.46 V	323	49.10	40.20
7	11020.00	60.7 PK	74.0	-13.3	1.47 V	246	40.90	19.80
8	11020.00	48.3 AV	54.0	-5.7	1.47 V	246	28.50	19.80

REMARKS:

1. Emission Level(dBuV/m) = Raw Value(dBuV) + Correction Factor(dB/m)
2. Correction Factor(dB/m) = Antenna Factor(dB/m) + Cable Factor(dB) – Pre-Amplifier Factor(dB)
3. The other emission levels were very low against the limit.
4. Margin value = Emission Level – Limit value
5. " * ": Fundamental frequency.
6. " # ": The radiated frequency is out of the restricted band.

CHANNEL	TX Channel 110	DETECTOR FUNCTION	Peak (PK)
FREQUENCY RANGE	1GHz ~ 40GHz		Average (AV)

ANTENNA POLARITY & TEST DISTANCE: HORIZONTAL AT 3 M

NO.	FREQ. (MHz)	EMISSION LEVEL (dBuV/m)	LIMIT (dBuV/m)	MARGIN (dB)	ANTENNA HEIGHT (m)	TABLE ANGLE (Degree)	RAW VALUE (dBuV)	CORRECTION FACTOR (dB/m)
1	*5550.00	94.4 PK			1.23 H	166	54.20	40.20
2	*5550.00	84.3 AV			1.23 H	166	44.10	40.20
3	11100.00	59.9 PK	74.0	-14.1	1.35 H	154	40.70	19.20
4	11100.00	48.1 AV	54.0	-5.9	1.35 H	154	28.90	19.20

ANTENNA POLARITY & TEST DISTANCE: VERTICAL AT 3 M

NO.	FREQ. (MHz)	EMISSION LEVEL (dBuV/m)	LIMIT (dBuV/m)	MARGIN (dB)	ANTENNA HEIGHT (m)	TABLE ANGLE (Degree)	RAW VALUE (dBuV)	CORRECTION FACTOR (dB/m)
1	*5550.00	97.8 PK			1.64 V	322	57.60	40.20
2	*5550.00	87.9 AV			1.64 V	322	47.70	40.20
3	11100.00	59.5 PK	74.0	-14.5	1.58 V	308	40.30	19.20
4	11100.00	47.6 AV	54.0	-6.4	1.58 V	308	28.40	19.20

REMARKS:

1. Emission Level(dBuV/m) = Raw Value(dBuV) + Correction Factor(dB/m)
2. Correction Factor(dB/m) = Antenna Factor(dB/m) + Cable Factor(dB) – Pre-Amplifier Factor(dB)
3. The other emission levels were very low against the limit.
4. Margin value = Emission Level – Limit value
5. " * ": Fundamental frequency.

CHANNEL	TX Channel 134	DETECTOR FUNCTION	Peak (PK)
FREQUENCY RANGE	1GHz ~ 40GHz		Average (AV)

ANTENNA POLARITY & TEST DISTANCE: HORIZONTAL AT 3 M

NO.	FREQ. (MHz)	EMISSION LEVEL (dBuV/m)	LIMIT (dBuV/m)	MARGIN (dB)	ANTENNA HEIGHT (m)	TABLE ANGLE (Degree)	RAW VALUE (dBuV)	CORRECTION FACTOR (dB/m)
1	*5670.00	93.4 PK			1.37 H	134	53.10	40.30
2	*5670.00	83.7 AV			1.37 H	134	43.40	40.30
3	#5725.00	58.1 PK	74.0	-15.9	1.30 H	123	50.70	7.40
4	#5725.00	45.9 AV	54.0	-8.1	1.30 H	123	38.50	7.40
5	11340.00	60.6 PK	74.0	-13.4	1.23 H	148	41.40	19.20
6	11340.00	48.3 AV	54.0	-5.7	1.23 H	148	29.10	19.20

ANTENNA POLARITY & TEST DISTANCE: VERTICAL AT 3 M

NO.	FREQ. (MHz)	EMISSION LEVEL (dBuV/m)	LIMIT (dBuV/m)	MARGIN (dB)	ANTENNA HEIGHT (m)	TABLE ANGLE (Degree)	RAW VALUE (dBuV)	CORRECTION FACTOR (dB/m)
1	*5670.00	96.1 PK			1.54 V	310	55.80	40.30
2	*5670.00	85.6 AV			1.54 V	310	45.30	40.30
3	#5725.00	57.6 PK	74.0	-16.4	1.66 V	295	50.20	7.40
4	#5725.00	46.3 AV	54.0	-7.7	1.66 V	295	38.90	7.40
5	11340.00	60.5 PK	74.0	-13.5	1.51 V	279	41.30	19.20
6	11340.00	48.7 AV	54.0	-5.3	1.51 V	279	29.50	19.20

REMARKS:

1. Emission Level(dBuV/m) = Raw Value(dBuV) + Correction Factor(dB/m)
2. Correction Factor(dB/m) = Antenna Factor(dB/m) + Cable Factor(dB) – Pre-Amplifier Factor(dB)
3. The other emission levels were very low against the limit.
4. Margin value = Emission Level – Limit value
5. " * ": Fundamental frequency.
6. " # ": The radiated frequency is out of the restricted band.

CHANNEL	TX Channel 142	DETECTOR FUNCTION	Peak (PK)
FREQUENCY RANGE	1GHz ~ 40GHz		Average (AV)

ANTENNA POLARITY & TEST DISTANCE: HORIZONTAL AT 3 M

NO.	FREQ. (MHz)	EMISSION LEVEL (dBuV/m)	LIMIT (dBuV/m)	MARGIN (dB)	ANTENNA HEIGHT (m)	TABLE ANGLE (Degree)	RAW VALUE (dBuV)	CORRECTION FACTOR (dB/m)
1	#5470.00	57.4 PK	74.0	-16.6	1.22 H	123	50.50	6.90
2	#5470.00	44.4 AV	54.0	-9.6	1.22 H	123	37.50	6.90
3	*5710.00	92.6 PK			1.39 H	136	52.10	40.50
4	*5710.00	83.6 AV			1.36 H	136	43.10	40.50
5	#5850.00	58.9 PK	74.0	-15.1	1.33 H	132	51.30	7.60
6	#5850.00	45.8 AV	54.0	-8.2	1.33 H	132	38.20	7.60
7	11420.00	59.7 PK	74.0	-14.3	1.24 H	149	41.00	18.70
8	11420.00	46.8 AV	54.0	-7.2	1.24 H	149	28.10	18.70

ANTENNA POLARITY & TEST DISTANCE: VERTICAL AT 3 M

NO.	FREQ. (MHz)	EMISSION LEVEL (dBuV/m)	LIMIT (dBuV/m)	MARGIN (dB)	ANTENNA HEIGHT (m)	TABLE ANGLE (Degree)	RAW VALUE (dBuV)	CORRECTION FACTOR (dB/m)
1	#5470.00	57.0 PK	74.0	-17.0	1.60 V	299	50.10	6.90
2	#5470.00	44.8 AV	54.0	-9.2	1.60 V	299	37.90	6.90
3	*5710.00	95.9 PK			1.56 V	300	55.40	40.50
4	*5710.00	84.8 AV			1.56 V	300	44.30	40.50
5	#5850.00	58.8 PK	74.0	-15.2	1.53 V	285	51.20	7.60
6	#5850.00	45.6 AV	54.0	-8.4	1.53 V	285	38.00	7.60
7	11420.00	59.7 PK	74.0	-14.3	1.50 V	270	41.00	18.70
8	11420.00	47.2 AV	54.0	-6.8	1.50 V	270	28.50	18.70

REMARKS:

1. Emission Level(dBuV/m) = Raw Value(dBuV) + Correction Factor(dB/m)
2. Correction Factor(dB/m) = Antenna Factor(dB/m) + Cable Factor(dB) – Pre-Amplifier Factor(dB)
3. The other emission levels were very low against the limit.
4. Margin value = Emission Level – Limit value
5. " * " : Fundamental frequency.
6. " # " : The radiated frequency is out of the restricted band.

CHANNEL	TX Channel 151	DETECTOR FUNCTION	Peak (PK)
FREQUENCY RANGE	1GHz ~ 40GHz		Average (AV)

ANTENNA POLARITY & TEST DISTANCE: HORIZONTAL AT 3 M

NO.	FREQ. (MHz)	EMISSION LEVEL (dBuV/m)	LIMIT (dBuV/m)	MARGIN (dB)	ANTENNA HEIGHT (m)	TABLE ANGLE (Degree)	RAW VALUE (dBuV)	CORRECTION FACTOR (dB/m)
1	#5619.20	57.8 PK	68.2	-10.4	1.84 H	198	50.70	7.10
2	*5755.00	94.5 PK			1.84 H	198	53.90	40.60
3	*5755.00	84.0 AV			1.84 H	198	43.40	40.60
4	#5984.80	58.3 PK	68.2	-9.9	1.84 H	198	50.40	7.90
5	11510.00	58.5 PK	74.0	-15.5	1.64 H	218	39.80	18.70
6	11510.00	47.0 AV	54.0	-7.0	1.64 H	218	28.30	18.70

ANTENNA POLARITY & TEST DISTANCE: VERTICAL AT 3 M

NO.	FREQ. (MHz)	EMISSION LEVEL (dBuV/m)	LIMIT (dBuV/m)	MARGIN (dB)	ANTENNA HEIGHT (m)	TABLE ANGLE (Degree)	RAW VALUE (dBuV)	CORRECTION FACTOR (dB/m)
1	#5615.20	57.7 PK	68.2	-10.5	3.82 V	170	50.60	7.10
2	*5755.00	101.5 PK			3.82 V	170	60.90	40.60
3	*5755.00	91.6 AV			3.82 V	170	51.00	40.60
4	#5939.20	57.9 PK	68.2	-10.3	3.82 V	170	50.20	7.70
5	11510.00	59.1 PK	74.0	-14.9	3.53 V	134	40.40	18.70
6	11510.00	47.4 AV	54.0	-6.6	3.53 V	134	28.70	18.70

REMARKS:

1. Emission Level(dBuV/m) = Raw Value(dBuV) + Correction Factor(dB/m)
2. Correction Factor(dB/m) = Antenna Factor(dB/m) + Cable Factor(dB) – Pre-Amplifier Factor(dB)
3. The other emission levels were very low against the limit.
4. Margin value = Emission Level – Limit value
5. " * ": Fundamental frequency.
6. " # ": The radiated frequency is out of the restricted band.

CHANNEL	TX Channel 159	DETECTOR FUNCTION	Peak (PK) Average (AV)
FREQUENCY RANGE	1GHz ~ 40GHz		

ANTENNA POLARITY & TEST DISTANCE: HORIZONTAL AT 3 M

NO.	FREQ. (MHz)	EMISSION LEVEL (dBuV/m)	LIMIT (dBuV/m)	MARGIN (dB)	ANTENNA HEIGHT (m)	TABLE ANGLE (Degree)	RAW VALUE (dBuV)	CORRECTION FACTOR (dB/m)
1	#5615.20	57.7 PK	68.2	-10.5	1.82 H	193	50.60	7.10
2	*5795.00	93.3 PK			1.82 H	193	52.70	40.60
3	*5795.00	83.0 AV			1.82 H	193	42.40	40.60
4	#5964.80	58.1 PK	68.2	-10.1	1.82 H	193	50.30	7.80
5	11590.00	59.6 PK	74.0	-14.4	1.55 H	208	40.80	18.80
6	11590.00	47.9 AV	54.0	-6.1	1.55 H	208	29.10	18.80

ANTENNA POLARITY & TEST DISTANCE: VERTICAL AT 3 M

NO.	FREQ. (MHz)	EMISSION LEVEL (dBuV/m)	LIMIT (dBuV/m)	MARGIN (dB)	ANTENNA HEIGHT (m)	TABLE ANGLE (Degree)	RAW VALUE (dBuV)	CORRECTION FACTOR (dB/m)
1	#5619.20	57.2 PK	68.2	-11.0	3.83 V	146	50.10	7.10
2	*5795.00	100.6 PK			3.83 V	146	60.00	40.60
3	*5795.00	90.6 AV			3.83 V	146	50.00	40.60
4	#5966.40	58.0 PK	68.2	-10.2	3.83 V	146	50.20	7.80
5	11590.00	60.3 PK	74.0	-13.7	3.21 V	134	41.50	18.80
6	11590.00	48.5 AV	54.0	-5.5	3.21 V	134	29.70	18.80

REMARKS:

1. Emission Level(dBuV/m) = Raw Value(dBuV) + Correction Factor(dB/m)
2. Correction Factor(dB/m) = Antenna Factor(dB/m) + Cable Factor(dB) – Pre-Amplifier Factor(dB)
3. The other emission levels were very low against the limit.
4. Margin value = Emission Level – Limit value
5. " * ": Fundamental frequency.
6. " # ": The radiated frequency is out of the restricted band.

802.11ac (VHT80)_1TX

CHANNEL	TX Channel 42	DETECTOR FUNCTION	Peak (PK)
FREQUENCY RANGE	1GHz ~ 40GHz		Average (AV)

ANTENNA POLARITY & TEST DISTANCE: HORIZONTAL AT 3 M

NO.	FREQ. (MHz)	EMISSION LEVEL (dBuV/m)	LIMIT (dBuV/m)	MARGIN (dB)	ANTENNA HEIGHT (m)	TABLE ANGLE (Degree)	RAW VALUE (dBuV)	CORRECTION FACTOR (dB/m)
1	5150.00	57.6 PK	74.0	-16.4	1.38 H	169	51.60	6.00
2	5150.00	45.7 AV	54.0	-8.3	1.38 H	169	39.70	6.00
3	*5210.00	89.3 PK			1.48 H	169	49.80	39.50
4	*5210.00	79.5 AV			1.48 H	169	40.00	39.50
5	#10420.00	58.1 PK	74.0	-15.9	1.42 H	122	40.20	17.90
6	#10420.00	46.6 AV	54.0	-7.4	1.42 H	122	28.70	17.90

ANTENNA POLARITY & TEST DISTANCE: VERTICAL AT 3 M

NO.	FREQ. (MHz)	EMISSION LEVEL (dBuV/m)	LIMIT (dBuV/m)	MARGIN (dB)	ANTENNA HEIGHT (m)	TABLE ANGLE (Degree)	RAW VALUE (dBuV)	CORRECTION FACTOR (dB/m)
1	5150.00	63.6 PK	74.0	-10.4	1.67 V	296	57.60	6.00
2	5150.00	51.0 AV	54.0	-3.0	1.67 V	296	45.00	6.00
3	*5210.00	97.3 PK			1.50 V	293	57.80	39.50
4	*5210.00	87.7 AV			1.50 V	293	48.20	39.50
5	#10420.00	59.6 PK	74.0	-14.4	1.53 V	209	41.70	17.90
6	#10420.00	46.8 AV	54.0	-7.2	1.53 V	209	28.90	17.90

REMARKS:

1. Emission Level(dBuV/m) = Raw Value(dBuV) + Correction Factor(dB/m)
2. Correction Factor(dB/m) = Antenna Factor(dB/m) + Cable Factor(dB) – Pre-Amplifier Factor(dB)
3. The other emission levels were very low against the limit.
4. Margin value = Emission Level – Limit value
5. " * ": Fundamental frequency.
6. " # ": The radiated frequency is out of the restricted band.

CHANNEL	TX Channel 58	DETECTOR FUNCTION	Peak (PK)
FREQUENCY RANGE	1GHz ~ 40GHz		Average (AV)

ANTENNA POLARITY & TEST DISTANCE: HORIZONTAL AT 3 M

NO.	FREQ. (MHz)	EMISSION LEVEL (dBuV/m)	LIMIT (dBuV/m)	MARGIN (dB)	ANTENNA HEIGHT (m)	TABLE ANGLE (Degree)	RAW VALUE (dBuV)	CORRECTION FACTOR (dB/m)
1	*5290.00	89.5 PK			1.74 H	203	49.80	39.70
2	*5290.00	79.2 AV			1.74 H	203	39.50	39.70
3	5350.00	57.8 PK	74.0	-16.2	1.56 H	190	51.30	6.50
4	5350.00	45.8 AV	54.0	-8.2	1.56 H	190	39.30	6.50
5	#10580.00	59.8 PK	74.0	-14.2	1.48 H	171	40.80	19.00
6	#10580.00	47.8 AV	54.0	-6.2	1.48 H	171	28.80	19.00

ANTENNA POLARITY & TEST DISTANCE: VERTICAL AT 3 M

NO.	FREQ. (MHz)	EMISSION LEVEL (dBuV/m)	LIMIT (dBuV/m)	MARGIN (dB)	ANTENNA HEIGHT (m)	TABLE ANGLE (Degree)	RAW VALUE (dBuV)	CORRECTION FACTOR (dB/m)
1	*5290.00	97.5 PK			1.55 V	320	57.80	39.70
2	*5290.00	87.5 AV			1.55 V	320	47.80	39.70
3	5350.00	58.9 PK	74.0	-15.1	1.45 V	314	52.40	6.50
4	5350.00	46.9 AV	54.0	-7.1	1.45 V	314	40.40	6.50
5	#10580.00	59.8 PK	74.0	-14.2	1.30 V	334	40.80	19.00
6	#10580.00	47.8 AV	54.0	-6.2	1.30 V	334	28.80	19.00

REMARKS:

1. Emission Level(dBuV/m) = Raw Value(dBuV) + Correction Factor(dB/m)
2. Correction Factor(dB/m) = Antenna Factor(dB/m) + Cable Factor(dB) – Pre-Amplifier Factor(dB)
3. The other emission levels were very low against the limit.
4. Margin value = Emission Level – Limit value
5. " * ": Fundamental frequency.
6. " # ": The radiated frequency is out of the restricted band.

CHANNEL	TX Channel 106	DETECTOR FUNCTION	Peak (PK)
FREQUENCY RANGE	1GHz ~ 40GHz		Average (AV)

ANTENNA POLARITY & TEST DISTANCE: HORIZONTAL AT 3 M

NO.	FREQ. (MHz)	EMISSION LEVEL (dBuV/m)	LIMIT (dBuV/m)	MARGIN (dB)	ANTENNA HEIGHT (m)	TABLE ANGLE (Degree)	RAW VALUE (dBuV)	CORRECTION FACTOR (dB/m)
1	5460.00	59.2 PK	74.0	-14.8	1.63 H	201	52.30	6.90
2	5460.00	46.6 AV	54.0	-7.4	1.63 H	201	39.70	6.90
3	#5470.00	59.7 PK	74.0	-14.3	1.55 H	201	52.80	6.90
4	#5470.00	47.4 AV	54.0	-6.6	1.55 H	201	40.50	6.90
5	*5530.00	92.1 PK			1.50 H	202	51.90	40.20
6	*5530.00	81.7 AV			1.50 H	202	41.50	40.20
7	#5725.00	58.4 PK	74.0	-15.6	1.37 H	183	51.00	7.40
8	#5725.00	45.8 AV	54.0	-8.2	1.37 H	183	38.40	7.40
9	11060.00	60.5 PK	74.0	-13.5	1.57 H	184	41.00	19.50
10	11060.00	47.6 AV	54.0	-6.4	1.57 H	184	28.10	19.50

ANTENNA POLARITY & TEST DISTANCE: VERTICAL AT 3 M

NO.	FREQ. (MHz)	EMISSION LEVEL (dBuV/m)	LIMIT (dBuV/m)	MARGIN (dB)	ANTENNA HEIGHT (m)	TABLE ANGLE (Degree)	RAW VALUE (dBuV)	CORRECTION FACTOR (dB/m)
1	5460.00	62.1 PK	74.0	-11.9	1.37 V	319	55.20	6.90
2	5460.00	49.4 AV	54.0	-4.6	1.37 V	319	42.50	6.90
3	#5470.00	62.6 PK	74.0	-11.4	1.32 V	320	55.70	6.90
4	#5470.00	50.1 AV	54.0	-3.9	1.32 V	320	43.20	6.90
5	*5530.00	96.1 PK			1.27 V	319	55.90	40.20
6	*5530.00	85.6 AV			1.27 V	319	45.40	40.20
7	#5725.00	57.6 PK	74.0	-16.4	1.31 V	288	50.20	7.40
8	#5725.00	44.9 AV	54.0	-9.1	1.31 V	288	37.50	7.40
9	11060.00	60.4 PK	74.0	-13.6	1.25 V	293	40.90	19.50
10	11060.00	48.5 AV	54.0	-5.5	1.25 V	293	29.00	19.50

REMARKS:

1. Emission Level(dBuV/m) = Raw Value(dBuV) + Correction Factor(dB/m)
2. Correction Factor(dB/m) = Antenna Factor(dB/m) + Cable Factor(dB) – Pre-Amplifier Factor(dB)
3. The other emission levels were very low against the limit.
4. Margin value = Emission Level – Limit value
5. " * ": Fundamental frequency.
6. " # ": The radiated frequency is out of the restricted band.

CHANNEL	TX Channel 138	DETECTOR FUNCTION	Peak (PK)
FREQUENCY RANGE	1GHz ~ 40GHz		Average (AV)

ANTENNA POLARITY & TEST DISTANCE: HORIZONTAL AT 3 M

NO.	FREQ. (MHz)	EMISSION LEVEL (dBuV/m)	LIMIT (dBuV/m)	MARGIN (dB)	ANTENNA HEIGHT (m)	TABLE ANGLE (Degree)	RAW VALUE (dBuV)	CORRECTION FACTOR (dB/m)
1	#5470.00	59.7 PK	74.0	-14.3	1.55 H	201	52.80	6.90
2	#5470.00	47.4 AV	54.0	-6.6	1.55 H	201	40.50	6.90
3	*5690.00	92.3 PK			1.50 H	202	51.90	40.40
4	*5690.00	81.9 AV			1.50 H	202	41.50	40.40
5	#5825.00	56.5 PK	74.0	-17.5	1.61 H	212	49.00	7.50
6	#5825.00	45.8 AV	54.0	-8.2	1.61 H	212	38.30	7.50
7	#5850.00	59.2 PK	74.0	-14.8	1.53 H	227	51.60	7.60
8	#5850.00	45.3 AV	54.0	-8.7	1.53 H	227	37.70	7.60
9	11380.00	59.1 PK	74.0	-14.9	1.59 H	188	40.20	18.90
10	11380.00	46.0 AV	54.0	-8.0	1.59 H	188	27.10	18.90

ANTENNA POLARITY & TEST DISTANCE: VERTICAL AT 3 M

NO.	FREQ. (MHz)	EMISSION LEVEL (dBuV/m)	LIMIT (dBuV/m)	MARGIN (dB)	ANTENNA HEIGHT (m)	TABLE ANGLE (Degree)	RAW VALUE (dBuV)	CORRECTION FACTOR (dB/m)
1	#5470.00	62.0 PK	74.0	-12.0	1.31 V	340	55.10	6.90
2	#5470.00	50.3 AV	54.0	-3.7	1.31 V	340	43.40	6.90
3	*5690.00	96.4 PK			1.27 V	320	56.00	40.40
4	*5690.00	84.8 AV			1.27 V	320	44.40	40.40
5	#5825.00	62.7 PK	74.0	-11.3	1.39 V	320	55.20	7.50
6	#5825.00	50.0 AV	54.0	-4.0	1.39 V	320	42.50	7.50
7	#5850.00	58.7 PK	74.0	-15.3	1.28 V	330	51.10	7.60
8	#5850.00	45.7 AV	54.0	-8.3	1.28 V	330	38.10	7.60
9	11380.00	59.8 PK	74.0	-14.2	1.20 V	290	40.90	18.90
10	11380.00	45.9 AV	54.0	-8.1	1.20 V	290	27.00	18.90

REMARKS:

1. Emission Level(dBuV/m) = Raw Value(dBuV) + Correction Factor(dB/m)
2. Correction Factor(dB/m) = Antenna Factor(dB/m) + Cable Factor(dB) – Pre-Amplifier Factor(dB)
3. The other emission levels were very low against the limit.
4. Margin value = Emission Level – Limit value
5. " * ": Fundamental frequency.
6. " # ": The radiated frequency is out of the restricted band.

CHANNEL	TX Channel 155	DETECTOR FUNCTION	Peak (PK)
FREQUENCY RANGE	1GHz ~ 40GHz		Average (AV)

ANTENNA POLARITY & TEST DISTANCE: HORIZONTAL AT 3 M

NO.	FREQ. (MHz)	EMISSION LEVEL (dBuV/m)	LIMIT (dBuV/m)	MARGIN (dB)	ANTENNA HEIGHT (m)	TABLE ANGLE (Degree)	RAW VALUE (dBuV)	CORRECTION FACTOR (dB/m)
1	#5616.80	57.4 PK	68.2	-10.8	1.82 H	198	50.30	7.10
2	*5775.00	90.6 PK			1.82 H	198	50.00	40.60
3	*5775.00	80.5 AV			1.82 H	198	39.90	40.60
4	#5940.80	57.0 PK	68.2	-11.2	1.82 H	198	49.30	7.70
5	11550.00	59.3 PK	74.0	-14.7	1.57 H	169	40.70	18.60
6	11550.00	47.8 AV	54.0	-6.2	1.57 H	169	29.20	18.60

ANTENNA POLARITY & TEST DISTANCE: VERTICAL AT 3 M

NO.	FREQ. (MHz)	EMISSION LEVEL (dBuV/m)	LIMIT (dBuV/m)	MARGIN (dB)	ANTENNA HEIGHT (m)	TABLE ANGLE (Degree)	RAW VALUE (dBuV)	CORRECTION FACTOR (dB/m)
1	#5635.20	58.3 PK	68.2	-9.9	3.26 V	307	51.20	7.10
2	*5775.00	97.8 PK			3.26 V	307	57.20	40.60
3	*5775.00	88.1 AV			3.26 V	307	47.50	40.60
4	#5943.20	58.3 PK	68.2	-9.9	3.26 V	307	50.60	7.70
5	11550.00	58.9 PK	74.0	-15.1	3.01 V	284	40.30	18.60
6	11550.00	47.5 AV	54.0	-6.5	3.01 V	284	28.90	18.60

REMARKS:

1. Emission Level(dBuV/m) = Raw Value(dBuV) + Correction Factor(dB/m)
2. Correction Factor(dB/m) = Antenna Factor(dB/m) + Cable Factor(dB) – Pre-Amplifier Factor(dB)
3. The other emission levels were very low against the limit.
4. Margin value = Emission Level – Limit value
5. " * ": Fundamental frequency.

802.11ac (VHT20)_2TX

CHANNEL	TX Channel 36	DETECTOR FUNCTION	Peak (PK)
FREQUENCY RANGE	1GHz ~ 40GHz		Average (AV)

ANTENNA POLARITY & TEST DISTANCE: HORIZONTAL AT 3 M								
NO.	FREQ. (MHz)	EMISSION LEVEL (dBuV/m)	LIMIT (dBuV/m)	MARGIN (dB)	ANTENNA HEIGHT (m)	TABLE ANGLE (Degree)	RAW VALUE (dBuV)	CORRECTION FACTOR (dB/m)
1	5150.00	57.1 PK	74.0	-16.9	1.55 H	149	51.10	6.00
2	5150.00	44.4 AV	54.0	-9.6	1.55 H	149	38.40	6.00
3	*5180.00	100.1 PK			1.48 H	134	60.70	39.40
4	*5180.00	89.8 AV			1.48 H	134	50.40	39.40
5	#10360.00	58.7 PK	74.0	-15.3	1.69 H	124	40.90	17.80
6	#10360.00	46.2 AV	54.0	-7.8	1.69 H	124	28.40	17.80

ANTENNA POLARITY & TEST DISTANCE: VERTICAL AT 3 M								
NO.	FREQ. (MHz)	EMISSION LEVEL (dBuV/m)	LIMIT (dBuV/m)	MARGIN (dB)	ANTENNA HEIGHT (m)	TABLE ANGLE (Degree)	RAW VALUE (dBuV)	CORRECTION FACTOR (dB/m)
1	5150.00	59.8 PK	74.0	-14.2	1.77 V	297	53.80	6.00
2	5150.00	47.5 AV	54.0	-6.5	1.77 V	297	41.50	6.00
3	*5180.00	106.1 PK			1.99 V	286	66.70	39.40
4	*5180.00	96.0 AV			1.99 V	286	56.60	39.40
5	#10360.00	60.0 PK	74.0	-14.0	1.77 V	325	42.20	17.80
6	#10360.00	46.7 AV	54.0	-7.3	1.77 V	325	28.90	17.80

REMARKS:

1. Emission Level(dBuV/m) = Raw Value(dBuV) + Correction Factor(dB/m)
2. Correction Factor(dB/m) = Antenna Factor(dB/m) + Cable Factor(dB) – Pre-Amplifier Factor(dB)
3. The other emission levels were very low against the limit.
4. Margin value = Emission Level – Limit value
5. " * ": Fundamental frequency.
6. " # ": The radiated frequency is out of the restricted band.

CHANNEL	TX Channel 40	DETECTOR FUNCTION	Peak (PK)
FREQUENCY RANGE	1GHz ~ 40GHz		Average (AV)

ANTENNA POLARITY & TEST DISTANCE: HORIZONTAL AT 3 M

NO.	FREQ. (MHz)	EMISSION LEVEL (dBuV/m)	LIMIT (dBuV/m)	MARGIN (dB)	ANTENNA HEIGHT (m)	TABLE ANGLE (Degree)	RAW VALUE (dBuV)	CORRECTION FACTOR (dB/m)
1	*5200.00	100.3 PK			1.32 H	199	60.80	39.50
2	*5200.00	89.9 AV			1.32 H	199	50.40	39.50
3	#10400.00	59.0 PK	74.0	-15.0	1.43 H	107	41.30	17.70
4	#10400.00	45.8 AV	54.0	-8.2	1.43 H	107	28.10	17.70

ANTENNA POLARITY & TEST DISTANCE: VERTICAL AT 3 M

NO.	FREQ. (MHz)	EMISSION LEVEL (dBuV/m)	LIMIT (dBuV/m)	MARGIN (dB)	ANTENNA HEIGHT (m)	TABLE ANGLE (Degree)	RAW VALUE (dBuV)	CORRECTION FACTOR (dB/m)
1	*5200.00	106.8 PK			2.38 V	275	67.30	39.50
2	*5200.00	97.0 AV			2.38 V	275	57.50	39.50
3	#10400.00	59.5 PK	74.0	-14.5	1.62 V	165	41.80	17.70
4	#10400.00	46.4 AV	54.0	-7.6	1.62 V	165	28.70	17.70

REMARKS:

1. Emission Level(dBuV/m) = Raw Value(dBuV) + Correction Factor(dB/m)
2. Correction Factor(dB/m) = Antenna Factor(dB/m) + Cable Factor(dB) – Pre-Amplifier Factor(dB)
3. The other emission levels were very low against the limit.
4. Margin value = Emission Level – Limit value
5. " * ": Fundamental frequency.
6. " # ": The radiated frequency is out of the restricted band.

CHANNEL	TX Channel 48	DETECTOR FUNCTION	Peak (PK)
FREQUENCY RANGE	1GHz ~ 40GHz		Average (AV)

ANTENNA POLARITY & TEST DISTANCE: HORIZONTAL AT 3 M

NO.	FREQ. (MHz)	EMISSION LEVEL (dBuV/m)	LIMIT (dBuV/m)	MARGIN (dB)	ANTENNA HEIGHT (m)	TABLE ANGLE (Degree)	RAW VALUE (dBuV)	CORRECTION FACTOR (dB/m)
1	*5240.00	102.0 PK			1.02 H	264	62.40	39.60
2	*5240.00	92.3 AV			1.02 H	264	52.70	39.60
3	5350.00	58.8 PK	74.0	-15.2	1.13 H	249	52.30	6.50
4	5350.00	45.6 AV	54.0	-8.4	1.13 H	249	39.10	6.50
5	#10480.00	59.5 PK	74.0	-14.5	1.32 H	221	40.80	18.70
6	#10480.00	46.7 AV	54.0	-7.3	1.32 H	221	28.00	18.70

ANTENNA POLARITY & TEST DISTANCE: VERTICAL AT 3 M

NO.	FREQ. (MHz)	EMISSION LEVEL (dBuV/m)	LIMIT (dBuV/m)	MARGIN (dB)	ANTENNA HEIGHT (m)	TABLE ANGLE (Degree)	RAW VALUE (dBuV)	CORRECTION FACTOR (dB/m)
1	*5240.00	108.7 PK			2.52 V	164	69.10	39.60
2	*5240.00	98.4 AV			2.52 V	164	58.80	39.60
3	5350.00	58.6 PK	74.0	-15.4	2.20 V	313	52.10	6.50
4	5350.00	46.4 AV	54.0	-7.6	2.20 V	313	39.90	6.50
5	#10480.00	59.8 PK	74.0	-14.2	1.96 V	220	41.10	18.70
6	#10480.00	46.8 AV	54.0	-7.2	1.96 V	220	28.10	18.70

REMARKS:

1. Emission Level(dBuV/m) = Raw Value(dBuV) + Correction Factor(dB/m)
2. Correction Factor(dB/m) = Antenna Factor(dB/m) + Cable Factor(dB) – Pre-Amplifier Factor(dB)
3. The other emission levels were very low against the limit.
4. Margin value = Emission Level – Limit value
5. " * ": Fundamental frequency.
6. " # ": The radiated frequency is out of the restricted band.

CHANNEL	TX Channel 52	DETECTOR FUNCTION	Peak (PK)
FREQUENCY RANGE	1GHz ~ 40GHz		Average (AV)

ANTENNA POLARITY & TEST DISTANCE: HORIZONTAL AT 3 M

NO.	FREQ. (MHz)	EMISSION LEVEL (dBuV/m)	LIMIT (dBuV/m)	MARGIN (dB)	ANTENNA HEIGHT (m)	TABLE ANGLE (Degree)	RAW VALUE (dBuV)	CORRECTION FACTOR (dB/m)
1	5150.00	56.5 PK	74.0	-17.5	1.55 H	184	50.50	6.00
2	5150.00	44.5 AV	54.0	-9.5	1.55 H	184	38.50	6.00
3	*5260.00	100.4 PK			1.48 H	201	60.80	39.60
4	*5260.00	90.6 AV			1.48 H	201	51.00	39.60
5	#10520.00	60.0 PK	74.0	-14.0	1.39 H	133	41.10	18.90
6	#10520.00	46.7 AV	54.0	-7.3	1.39 H	133	27.80	18.90

ANTENNA POLARITY & TEST DISTANCE: VERTICAL AT 3 M

NO.	FREQ. (MHz)	EMISSION LEVEL (dBuV/m)	LIMIT (dBuV/m)	MARGIN (dB)	ANTENNA HEIGHT (m)	TABLE ANGLE (Degree)	RAW VALUE (dBuV)	CORRECTION FACTOR (dB/m)
1	5150.00	57.5 PK	74.0	-16.5	1.39 V	223	51.50	6.00
2	5150.00	45.1 AV	54.0	-8.9	1.39 V	223	39.10	6.00
3	*5260.00	109.2 PK			2.51 V	157	69.60	39.60
4	*5260.00	98.4 AV			2.51 V	157	58.80	39.60
5	#10520.00	60.5 PK	74.0	-13.5	2.31 V	224	41.60	18.90
6	#10520.00	47.6 AV	54.0	-6.4	2.31 V	224	28.70	18.90

REMARKS:

1. Emission Level(dBuV/m) = Raw Value(dBuV) + Correction Factor(dB/m)
2. Correction Factor(dB/m) = Antenna Factor(dB/m) + Cable Factor(dB) – Pre-Amplifier Factor(dB)
3. The other emission levels were very low against the limit.
4. Margin value = Emission Level – Limit value
5. " * ": Fundamental frequency.
6. " # ": The radiated frequency is out of the restricted band.

CHANNEL	TX Channel 60	DETECTOR FUNCTION	Peak (PK)
FREQUENCY RANGE	1GHz ~ 40GHz		Average (AV)

ANTENNA POLARITY & TEST DISTANCE: HORIZONTAL AT 3 M

NO.	FREQ. (MHz)	EMISSION LEVEL (dBuV/m)	LIMIT (dBuV/m)	MARGIN (dB)	ANTENNA HEIGHT (m)	TABLE ANGLE (Degree)	RAW VALUE (dBuV)	CORRECTION FACTOR (dB/m)
1	*5300.00	101.9 PK			1.22 H	267	62.20	39.70
2	*5300.00	91.5 AV			1.22 H	267	51.80	39.70
3	10600.00	60.5 PK	74.0	-13.5	1.29 H	184	41.60	18.90
4	10600.00	47.6 AV	54.0	-6.4	1.29 H	184	28.70	18.90

ANTENNA POLARITY & TEST DISTANCE: VERTICAL AT 3 M

NO.	FREQ. (MHz)	EMISSION LEVEL (dBuV/m)	LIMIT (dBuV/m)	MARGIN (dB)	ANTENNA HEIGHT (m)	TABLE ANGLE (Degree)	RAW VALUE (dBuV)	CORRECTION FACTOR (dB/m)
1	*5300.00	109.4 PK			2.47 V	159	69.70	39.70
2	*5300.00	98.9 AV			2.47 V	159	59.20	39.70
3	10600.00	61.4 PK	74.0	-12.6	2.09 V	208	42.50	18.90
4	10600.00	47.5 AV	54.0	-6.5	2.09 V	208	28.60	18.90

REMARKS:

1. Emission Level(dBuV/m) = Raw Value(dBuV) + Correction Factor(dB/m)
2. Correction Factor(dB/m) = Antenna Factor(dB/m) + Cable Factor(dB) – Pre-Amplifier Factor(dB)
3. The other emission levels were very low against the limit.
4. Margin value = Emission Level – Limit value
5. " * ": Fundamental frequency.



CHANNEL	TX Channel 64	DETECTOR FUNCTION	Peak (PK)
FREQUENCY RANGE	1GHz ~ 40GHz		Average (AV)

ANTENNA POLARITY & TEST DISTANCE: HORIZONTAL AT 3 M

NO.	FREQ. (MHz)	EMISSION LEVEL (dBuV/m)	LIMIT (dBuV/m)	MARGIN (dB)	ANTENNA HEIGHT (m)	TABLE ANGLE (Degree)	RAW VALUE (dBuV)	CORRECTION FACTOR (dB/m)
1	*5320.00	102.0 PK			1.52 H	201	62.30	39.70
2	*5320.00	91.6 AV			1.52 H	201	51.90	39.70
3	5350.00	57.5 PK	74.0	-16.5	1.42 H	186	51.00	6.50
4	5350.00	45.9 AV	54.0	-8.1	1.42 H	186	39.40	6.50
5	10640.00	59.8 PK	74.0	-14.2	1.62 H	184	41.00	18.80
6	10640.00	47.2 AV	54.0	-6.8	1.62 H	184	28.40	18.80

ANTENNA POLARITY & TEST DISTANCE: VERTICAL AT 3 M

NO.	FREQ. (MHz)	EMISSION LEVEL (dBuV/m)	LIMIT (dBuV/m)	MARGIN (dB)	ANTENNA HEIGHT (m)	TABLE ANGLE (Degree)	RAW VALUE (dBuV)	CORRECTION FACTOR (dB/m)
1	*5320.00	108.6 PK			2.30 V	164	68.90	39.70
2	*5320.00	98.7 AV			2.30 V	164	59.00	39.70
3	5350.00	60.9 PK	74.0	-13.1	2.50 V	163	54.40	6.50
4	5350.00	48.4 AV	54.0	-5.6	2.50 V	163	41.90	6.50
5	10640.00	60.1 PK	74.0	-13.9	2.27 V	200	41.30	18.80
6	10640.00	46.9 AV	54.0	-7.1	2.27 V	200	28.10	18.80

REMARKS:

1. Emission Level(dBuV/m) = Raw Value(dBuV) + Correction Factor(dB/m)
2. Correction Factor(dB/m) = Antenna Factor(dB/m) + Cable Factor(dB) – Pre-Amplifier Factor(dB)
3. The other emission levels were very low against the limit.
4. Margin value = Emission Level – Limit value
5. " * ": Fundamental frequency.

CHANNEL	TX Channel 100	DETECTOR FUNCTION	Peak (PK)
FREQUENCY RANGE	1GHz ~ 40GHz		Average (AV)

ANTENNA POLARITY & TEST DISTANCE: HORIZONTAL AT 3 M

NO.	FREQ. (MHz)	EMISSION LEVEL (dBuV/m)	LIMIT (dBuV/m)	MARGIN (dB)	ANTENNA HEIGHT (m)	TABLE ANGLE (Degree)	RAW VALUE (dBuV)	CORRECTION FACTOR (dB/m)
1	5460.00	59.5 PK	74.0	-14.5	1.41 H	210	52.60	6.90
2	5460.00	46.1 AV	54.0	-7.9	1.41 H	210	39.20	6.90
3	#5470.00	59.7 PK	74.0	-14.3	1.54 H	196	52.80	6.90
4	#5470.00	46.4 AV	54.0	-7.6	1.54 H	196	39.50	6.90
5	*5500.00	102.8 PK			1.44 H	199	62.60	40.20
6	*5500.00	92.8 AV			1.44 H	199	52.60	40.20
7	11000.00	59.5 PK	74.0	-14.5	1.35 H	137	39.60	19.90
8	11000.00	46.5 AV	54.0	-7.5	1.35 H	137	26.60	19.90

ANTENNA POLARITY & TEST DISTANCE: VERTICAL AT 3 M

NO.	FREQ. (MHz)	EMISSION LEVEL (dBuV/m)	LIMIT (dBuV/m)	MARGIN (dB)	ANTENNA HEIGHT (m)	TABLE ANGLE (Degree)	RAW VALUE (dBuV)	CORRECTION FACTOR (dB/m)
1	5460.00	57.7 PK	74.0	-16.3	2.31 V	150	50.80	6.90
2	5460.00	46.6 AV	54.0	-7.4	2.31 V	150	39.70	6.90
3	#5470.00	61.4 PK	74.0	-12.6	2.28 V	158	54.50	6.90
4	#5470.00	48.6 AV	54.0	-5.4	2.28 V	158	41.70	6.90
5	*5500.00	109.2 PK			2.53 V	157	69.00	40.20
6	*5500.00	98.6 AV			2.53 V	157	58.40	40.20
7	11000.00	59.2 PK	74.0	-14.8	2.31 V	141	39.30	19.90
8	11000.00	47.2 AV	54.0	-6.8	2.31 V	141	27.30	19.90

REMARKS:

1. Emission Level(dBuV/m) = Raw Value(dBuV) + Correction Factor(dB/m)
2. Correction Factor(dB/m) = Antenna Factor(dB/m) + Cable Factor(dB) – Pre-Amplifier Factor(dB)
3. The other emission levels were very low against the limit.
4. Margin value = Emission Level – Limit value
5. " * ": Fundamental frequency.
6. " # ": The radiated frequency is out of the restricted band.

CHANNEL	TX Channel 116	DETECTOR FUNCTION	Peak (PK)
FREQUENCY RANGE	1GHz ~ 40GHz		Average (AV)

ANTENNA POLARITY & TEST DISTANCE: HORIZONTAL AT 3 M

NO.	FREQ. (MHz)	EMISSION LEVEL (dBuV/m)	LIMIT (dBuV/m)	MARGIN (dB)	ANTENNA HEIGHT (m)	TABLE ANGLE (Degree)	RAW VALUE (dBuV)	CORRECTION FACTOR (dB/m)
1	*5580.00	100.8 PK			1.48 H	202	60.50	40.30
2	*5580.00	91.2 AV			1.48 H	202	50.90	40.30
3	11160.00	60.6 PK	74.0	-13.4	1.62 H	184	41.20	19.40
4	11160.00	47.3 AV	54.0	-6.7	1.62 H	184	27.90	19.40

ANTENNA POLARITY & TEST DISTANCE: VERTICAL AT 3 M

NO.	FREQ. (MHz)	EMISSION LEVEL (dBuV/m)	LIMIT (dBuV/m)	MARGIN (dB)	ANTENNA HEIGHT (m)	TABLE ANGLE (Degree)	RAW VALUE (dBuV)	CORRECTION FACTOR (dB/m)
1	*5580.00	108.6 PK			2.34 V	161	68.30	40.30
2	*5580.00	98.9 AV			2.34 V	161	58.60	40.30
3	11160.00	61.0 PK	74.0	-13.0	2.08 V	166	41.60	19.40
4	11160.00	48.1 AV	54.0	-5.9	2.08 V	166	28.70	19.40

REMARKS:

1. Emission Level(dBuV/m) = Raw Value(dBuV) + Correction Factor(dB/m)
2. Correction Factor(dB/m) = Antenna Factor(dB/m) + Cable Factor(dB) – Pre-Amplifier Factor(dB)
3. The other emission levels were very low against the limit.
4. Margin value = Emission Level – Limit value
5. " * ": Fundamental frequency.
6. " # ": The radiated frequency is out of the restricted band.

CHANNEL	TX Channel 140	DETECTOR FUNCTION	Peak (PK)
FREQUENCY RANGE	1GHz ~ 40GHz		Average (AV)

ANTENNA POLARITY & TEST DISTANCE: HORIZONTAL AT 3 M

NO.	FREQ. (MHz)	EMISSION LEVEL (dBuV/m)	LIMIT (dBuV/m)	MARGIN (dB)	ANTENNA HEIGHT (m)	TABLE ANGLE (Degree)	RAW VALUE (dBuV)	CORRECTION FACTOR (dB/m)
1	*5700.00	100.3 PK			1.33 H	271	59.90	40.40
2	*5700.00	90.1 AV			1.33 H	271	49.70	40.40
3	#5725.00	58.8 PK	74.0	-15.2	1.43 H	273	51.40	7.40
4	#5725.00	46.1 AV	54.0	-7.9	1.43 H	273	38.70	7.40
5	11400.00	60.4 PK	74.0	-13.6	1.56 H	205	41.60	18.80
6	11400.00	46.7 AV	54.0	-7.3	1.56 H	205	27.90	18.80

ANTENNA POLARITY & TEST DISTANCE: VERTICAL AT 3 M

NO.	FREQ. (MHz)	EMISSION LEVEL (dBuV/m)	LIMIT (dBuV/m)	MARGIN (dB)	ANTENNA HEIGHT (m)	TABLE ANGLE (Degree)	RAW VALUE (dBuV)	CORRECTION FACTOR (dB/m)
1	*5700.00	107.1 PK			2.39 V	178	66.70	40.40
2	*5700.00	97.2 AV			2.39 V	178	56.80	40.40
3	#5725.00	65.0 PK	74.0	-9.0	2.38 V	178	57.60	7.40
4	#5725.00	49.3 AV	54.0	-4.7	2.38 V	178	41.90	7.40
5	11400.00	60.0 PK	74.0	-14.0	2.38 V	139	41.20	18.80
6	11400.00	48.0 AV	54.0	-6.0	2.38 V	139	29.20	18.80

REMARKS:

1. Emission Level(dBuV/m) = Raw Value(dBuV) + Correction Factor(dB/m)
2. Correction Factor(dB/m) = Antenna Factor(dB/m) + Cable Factor(dB) – Pre-Amplifier Factor(dB)
3. The other emission levels were very low against the limit.
4. Margin value = Emission Level – Limit value
5. " * ": Fundamental frequency.
6. " # ": The radiated frequency is out of the restricted band.



CHANNEL	TX Channel 144	DETECTOR FUNCTION	Peak (PK)
FREQUENCY RANGE	1GHz ~ 40GHz		Average (AV)

ANTENNA POLARITY & TEST DISTANCE: HORIZONTAL AT 3 M

NO.	FREQ. (MHz)	EMISSION LEVEL (dBuV/m)	LIMIT (dBuV/m)	MARGIN (dB)	ANTENNA HEIGHT (m)	TABLE ANGLE (Degree)	RAW VALUE (dBuV)	CORRECTION FACTOR (dB/m)
1	#5470.00	57.0 PK	74.0	-17.0	1.46 H	277	50.10	6.90
2	#5470.00	45.7 AV	54.0	-8.3	1.46 H	277	38.80	6.90
3	*5720.00	100.5 PK			1.33 H	277	60.00	40.50
4	*5720.00	89.1 AV			1.33 H	277	48.60	40.50
5	#5850.00	58.1 PK	74.0	-15.9	1.38 H	228	50.50	7.60
6	#5850.00	45.8 AV	54.0	-8.2	1.38 H	228	38.20	7.60
7	11440.00	60.0 PK	74.0	-14.0	1.58 H	201	41.30	18.70
8	11440.00	45.9 AV	54.0	-8.1	1.58 H	201	27.20	18.70

ANTENNA POLARITY & TEST DISTANCE: VERTICAL AT 3 M

NO.	FREQ. (MHz)	EMISSION LEVEL (dBuV/m)	LIMIT (dBuV/m)	MARGIN (dB)	ANTENNA HEIGHT (m)	TABLE ANGLE (Degree)	RAW VALUE (dBuV)	CORRECTION FACTOR (dB/m)
1	#5470.00	62.5 PK	74.0	-11.5	2.36 V	180	55.60	6.90
2	#5470.00	48.9 AV	54.0	-5.1	2.36 V	180	42.00	6.90
3	*5720.00	106.2 PK			2.41 V	180	65.70	40.50
4	*5720.00	96.3 AV			2.41 V	180	55.80	40.50
5	#5850.00	58.6 PK	74.0	-15.4	2.45 V	200	51.00	7.60
6	#5850.00	45.8 AV	54.0	-8.2	2.45 V	200	38.20	7.60
7	11440.00	58.9 PK	74.0	-15.1	2.00 V	139	40.20	18.70
8	11440.00	45.9 AV	54.0	-8.1	2.00 V	139	27.20	18.70

REMARKS:

1. Emission Level(dBuV/m) = Raw Value(dBuV) + Correction Factor(dB/m)
2. Correction Factor(dB/m) = Antenna Factor(dB/m) + Cable Factor(dB) – Pre-Amplifier Factor(dB)
3. The other emission levels were very low against the limit.
4. Margin value = Emission Level – Limit value
5. " * " : Fundamental frequency.
6. " # " : The radiated frequency is out of the restricted band.

CHANNEL	TX Channel 149	DETECTOR FUNCTION	Peak (PK)
FREQUENCY RANGE	1GHz ~ 40GHz		Average (AV)

ANTENNA POLARITY & TEST DISTANCE: HORIZONTAL AT 3 M

NO.	FREQ. (MHz)	EMISSION LEVEL (dBuV/m)	LIMIT (dBuV/m)	MARGIN (dB)	ANTENNA HEIGHT (m)	TABLE ANGLE (Degree)	RAW VALUE (dBuV)	CORRECTION FACTOR (dB/m)
1	#5607.20	57.8 PK	68.2	-10.4	1.15 H	282	50.70	7.10
2	*5745.00	100.2 PK			1.15 H	282	59.70	40.50
3	*5745.00	90.4 AV			1.15 H	282	49.90	40.50
4	#5962.40	58.6 PK	68.2	-9.6	1.15 H	282	50.80	7.80
5	11490.00	59.5 PK	74.0	-14.5	1.41 H	187	40.80	18.70
6	11490.00	46.7 AV	54.0	-7.3	1.41 H	187	28.00	18.70

ANTENNA POLARITY & TEST DISTANCE: VERTICAL AT 3 M

NO.	FREQ. (MHz)	EMISSION LEVEL (dBuV/m)	LIMIT (dBuV/m)	MARGIN (dB)	ANTENNA HEIGHT (m)	TABLE ANGLE (Degree)	RAW VALUE (dBuV)	CORRECTION FACTOR (dB/m)
1	#5644.80	58.0 PK	68.2	-10.2	2.32 V	165	50.90	7.10
2	*5745.00	108.0 PK			2.32 V	165	67.50	40.50
3	*5745.00	98.2 AV			2.32 V	165	57.70	40.50
4	#5940.80	59.1 PK	68.2	-9.1	2.32 V	165	51.40	7.70
5	11490.00	60.2 PK	74.0	-13.8	2.05 V	303	41.50	18.70
6	11490.00	46.5 AV	54.0	-7.5	2.05 V	303	27.80	18.70

REMARKS:

1. Emission Level(dBuV/m) = Raw Value(dBuV) + Correction Factor(dB/m)
2. Correction Factor(dB/m) = Antenna Factor(dB/m) + Cable Factor(dB) – Pre-Amplifier Factor(dB)
3. The other emission levels were very low against the limit.
4. Margin value = Emission Level – Limit value
5. " * ": Fundamental frequency.
6. " # ": The radiated frequency is out of the restricted band.

CHANNEL	TX Channel 157	DETECTOR FUNCTION	Peak (PK)
FREQUENCY RANGE	1GHz ~ 40GHz		Average (AV)

ANTENNA POLARITY & TEST DISTANCE: HORIZONTAL AT 3 M

NO.	FREQ. (MHz)	EMISSION LEVEL (dBuV/m)	LIMIT (dBuV/m)	MARGIN (dB)	ANTENNA HEIGHT (m)	TABLE ANGLE (Degree)	RAW VALUE (dBuV)	CORRECTION FACTOR (dB/m)
1	#5616.00	58.4 PK	68.2	-9.8	1.19 H	270	51.30	7.10
2	*5785.00	102.0 PK			1.19 H	270	61.40	40.60
3	*5785.00	91.5 AV			1.19 H	270	50.90	40.60
4	#5995.20	59.2 PK	68.2	-9.0	1.19 H	270	51.30	7.90
5	11570.00	60.7 PK	74.0	-13.3	1.42 H	187	42.00	18.70
6	11570.00	47.1 AV	54.0	-6.9	1.42 H	187	28.40	18.70

ANTENNA POLARITY & TEST DISTANCE: VERTICAL AT 3 M

NO.	FREQ. (MHz)	EMISSION LEVEL (dBuV/m)	LIMIT (dBuV/m)	MARGIN (dB)	ANTENNA HEIGHT (m)	TABLE ANGLE (Degree)	RAW VALUE (dBuV)	CORRECTION FACTOR (dB/m)
1	#5653.60	58.3 PK	70.9	-12.6	2.35 V	159	51.20	7.10
2	*5785.00	108.2 PK			2.35 V	159	67.60	40.60
3	*5785.00	97.6 AV			2.35 V	159	57.00	40.60
4	#5987.20	59.8 PK	68.2	-8.4	2.35 V	159	51.90	7.90
5	11570.00	60.1 PK	74.0	-13.9	1.86 V	145	41.40	18.70
6	11570.00	47.6 AV	54.0	-6.4	1.86 V	145	28.90	18.70

REMARKS:

1. Emission Level(dBuV/m) = Raw Value(dBuV) + Correction Factor(dB/m)
2. Correction Factor(dB/m) = Antenna Factor(dB/m) + Cable Factor(dB) – Pre-Amplifier Factor(dB)
3. The other emission levels were very low against the limit.
4. Margin value = Emission Level – Limit value
5. " * ": Fundamental frequency.
6. " # ": The radiated frequency is out of the restricted band.

CHANNEL	TX Channel 165	DETECTOR FUNCTION	Peak (PK)
FREQUENCY RANGE	1GHz ~ 40GHz		Average (AV)

ANTENNA POLARITY & TEST DISTANCE: HORIZONTAL AT 3 M

NO.	FREQ. (MHz)	EMISSION LEVEL (dBuV/m)	LIMIT (dBuV/m)	MARGIN (dB)	ANTENNA HEIGHT (m)	TABLE ANGLE (Degree)	RAW VALUE (dBuV)	CORRECTION FACTOR (dB/m)
1	#5621.60	57.2 PK	68.2	-11.0	1.48 H	272	50.10	7.10
2	*5825.00	100.8 PK			1.48 H	272	60.20	40.60
3	*5825.00	90.7 AV			1.48 H	272	50.10	40.60
4	#5982.40	59.6 PK	68.2	-8.6	1.48 H	272	51.70	7.90
5	11650.00	60.1 PK	74.0	-13.9	1.53 H	184	40.90	19.20
6	11650.00	47.3 AV	54.0	-6.7	1.53 H	184	28.10	19.20

ANTENNA POLARITY & TEST DISTANCE: VERTICAL AT 3 M

NO.	FREQ. (MHz)	EMISSION LEVEL (dBuV/m)	LIMIT (dBuV/m)	MARGIN (dB)	ANTENNA HEIGHT (m)	TABLE ANGLE (Degree)	RAW VALUE (dBuV)	CORRECTION FACTOR (dB/m)
1	#5653.60	45.7 PK	70.9	-25.2	2.43 V	164	38.60	7.10
2	*5825.00	107.6 PK			2.43 V	164	67.00	40.60
3	*5825.00	97.4 AV			2.43 V	164	56.80	40.60
4	#5921.60	46.8 PK	70.7	-23.9	2.43 V	164	39.10	7.70
5	11650.00	60.9 PK	74.0	-13.1	1.88 V	188	41.70	19.20
6	11650.00	48.0 AV	54.0	-6.0	1.88 V	188	28.80	19.20

REMARKS:

1. Emission Level(dBuV/m) = Raw Value(dBuV) + Correction Factor(dB/m)
2. Correction Factor(dB/m) = Antenna Factor(dB/m) + Cable Factor(dB) – Pre-Amplifier Factor(dB)
3. The other emission levels were very low against the limit.
4. Margin value = Emission Level – Limit value
5. " * ": Fundamental frequency.
6. " # ": The radiated frequency is out of the restricted band.

802.11ac (VHT40)_2TX

CHANNEL	TX Channel 38	DETECTOR FUNCTION	Peak (PK)
FREQUENCY RANGE	1GHz ~ 40GHz		Average (AV)

ANTENNA POLARITY & TEST DISTANCE: HORIZONTAL AT 3 M								
NO.	FREQ. (MHz)	EMISSION LEVEL (dBuV/m)	LIMIT (dBuV/m)	MARGIN (dB)	ANTENNA HEIGHT (m)	TABLE ANGLE (Degree)	RAW VALUE (dBuV)	CORRECTION FACTOR (dB/m)
1	5150.00	61.0 PK	74.0	-13.0	1.15 H	265	55.00	6.00
2	5150.00	47.2 AV	54.0	-6.8	1.15 H	265	41.20	6.00
3	*5190.00	97.4 PK			1.05 H	266	58.00	39.40
4	*5190.00	87.8 AV			1.05 H	266	48.40	39.40
5	#10380.00	58.7 PK	74.0	-15.3	1.44 H	117	41.00	17.70
6	#10380.00	47.1 AV	54.0	-6.9	1.44 H	117	29.40	17.70

ANTENNA POLARITY & TEST DISTANCE: VERTICAL AT 3 M								
NO.	FREQ. (MHz)	EMISSION LEVEL (dBuV/m)	LIMIT (dBuV/m)	MARGIN (dB)	ANTENNA HEIGHT (m)	TABLE ANGLE (Degree)	RAW VALUE (dBuV)	CORRECTION FACTOR (dB/m)
1	5150.00	64.5 PK	74.0	-9.5	2.03 V	323	58.50	6.00
2	5150.00	51.1 AV	54.0	-2.9	2.03 V	323	45.10	6.00
3	*5190.00	101.2 PK			1.49 V	333	61.80	39.40
4	*5190.00	91.5 AV			1.49 V	333	52.10	39.40
5	#10380.00	58.7 PK	74.0	-15.3	1.57 V	246	41.00	17.70
6	#10380.00	46.9 AV	54.0	-7.1	1.57 V	246	29.20	17.70

REMARKS:

1. Emission Level(dBuV/m) = Raw Value(dBuV) + Correction Factor(dB/m)
2. Correction Factor(dB/m) = Antenna Factor(dB/m) + Cable Factor(dB) – Pre-Amplifier Factor(dB)
3. The other emission levels were very low against the limit.
4. Margin value = Emission Level – Limit value
5. " * ": Fundamental frequency.
6. " # ": The radiated frequency is out of the restricted band.

CHANNEL	TX Channel 46	DETECTOR FUNCTION	Peak (PK)
FREQUENCY RANGE	1GHz ~ 40GHz		Average (AV)

ANTENNA POLARITY & TEST DISTANCE: HORIZONTAL AT 3 M

NO.	FREQ. (MHz)	EMISSION LEVEL (dBuV/m)	LIMIT (dBuV/m)	MARGIN (dB)	ANTENNA HEIGHT (m)	TABLE ANGLE (Degree)	RAW VALUE (dBuV)	CORRECTION FACTOR (dB/m)
1	5150.00	56.7 PK	74.0	-17.3	1.22 H	246	50.70	6.00
2	5150.00	45.0 AV	54.0	-9.0	1.22 H	246	39.00	6.00
3	*5230.00	97.4 PK			1.10 H	263	57.80	39.60
4	*5230.00	87.7 AV			1.10 H	263	48.10	39.60
5	#10460.00	59.2 PK	74.0	-14.8	1.38 H	165	40.70	18.50
6	#10460.00	47.5 AV	54.0	-6.5	1.38 H	165	29.00	18.50

ANTENNA POLARITY & TEST DISTANCE: VERTICAL AT 3 M

NO.	FREQ. (MHz)	EMISSION LEVEL (dBuV/m)	LIMIT (dBuV/m)	MARGIN (dB)	ANTENNA HEIGHT (m)	TABLE ANGLE (Degree)	RAW VALUE (dBuV)	CORRECTION FACTOR (dB/m)
1	5150.00	57.1 PK	74.0	-16.9	2.03 V	274	51.10	6.00
2	5150.00	45.6 AV	54.0	-8.4	2.03 V	274	39.60	6.00
3	*5230.00	101.9 PK			2.20 V	276	62.30	39.60
4	*5230.00	92.4 AV			2.20 V	276	52.80	39.60
5	#10460.00	61.1 PK	74.0	-12.9	1.66 V	202	42.60	18.50
6	#10460.00	47.7 AV	54.0	-6.3	1.66 V	202	29.20	18.50

REMARKS:

1. Emission Level(dBuV/m) = Raw Value(dBuV) + Correction Factor(dB/m)
2. Correction Factor(dB/m) = Antenna Factor(dB/m) + Cable Factor(dB) – Pre-Amplifier Factor(dB)
3. The other emission levels were very low against the limit.
4. Margin value = Emission Level – Limit value
5. " * ": Fundamental frequency.
6. " # ": The radiated frequency is out of the restricted band.

CHANNEL	TX Channel 54	DETECTOR FUNCTION	Peak (PK)
FREQUENCY RANGE	1GHz ~ 40GHz		Average (AV)

ANTENNA POLARITY & TEST DISTANCE: HORIZONTAL AT 3 M

NO.	FREQ. (MHz)	EMISSION LEVEL (dBuV/m)	LIMIT (dBuV/m)	MARGIN (dB)	ANTENNA HEIGHT (m)	TABLE ANGLE (Degree)	RAW VALUE (dBuV)	CORRECTION FACTOR (dB/m)
1	*5270.00	95.5 PK			1.48 H	200	55.90	39.60
2	*5270.00	86.1 AV			1.48 H	200	46.50	39.60
3	5350.00	57.2 PK	74.0	-16.8	1.59 H	188	50.70	6.50
4	5350.00	45.6 AV	54.0	-8.4	1.59 H	188	39.10	6.50
5	#10540.00	59.5 PK	74.0	-14.5	1.53 H	205	40.50	19.00
6	#10540.00	47.5 AV	54.0	-6.5	1.53 H	205	28.50	19.00

ANTENNA POLARITY & TEST DISTANCE: VERTICAL AT 3 M

NO.	FREQ. (MHz)	EMISSION LEVEL (dBuV/m)	LIMIT (dBuV/m)	MARGIN (dB)	ANTENNA HEIGHT (m)	TABLE ANGLE (Degree)	RAW VALUE (dBuV)	CORRECTION FACTOR (dB/m)
1	*5270.00	101.1 PK			1.68 V	323	61.50	39.60
2	*5270.00	92.0 AV			1.68 V	323	52.40	39.60
3	5350.00	58.2 PK	74.0	-15.8	1.59 V	310	51.70	6.50
4	5350.00	46.8 AV	54.0	-7.2	1.59 V	310	40.30	6.50
5	#10540.00	60.1 PK	74.0	-13.9	1.52 V	211	41.10	19.00
6	#10540.00	48.2 AV	54.0	-5.8	1.52 V	211	29.20	19.00

REMARKS:

1. Emission Level(dBuV/m) = Raw Value(dBuV) + Correction Factor(dB/m)
2. Correction Factor(dB/m) = Antenna Factor(dB/m) + Cable Factor(dB) – Pre-Amplifier Factor(dB)
3. The other emission levels were very low against the limit.
4. Margin value = Emission Level – Limit value
5. " * ": Fundamental frequency.
6. " # ": The radiated frequency is out of the restricted band.

CHANNEL	TX Channel 62	DETECTOR FUNCTION	Peak (PK)
FREQUENCY RANGE	1GHz ~ 40GHz		Average (AV)

ANTENNA POLARITY & TEST DISTANCE: HORIZONTAL AT 3 M

NO.	FREQ. (MHz)	EMISSION LEVEL (dBuV/m)	LIMIT (dBuV/m)	MARGIN (dB)	ANTENNA HEIGHT (m)	TABLE ANGLE (Degree)	RAW VALUE (dBuV)	CORRECTION FACTOR (dB/m)
1	*5310.00	96.8 PK			1.54 H	202	57.10	39.70
2	*5310.00	87.3 AV			1.54 H	202	47.60	39.70
3	5350.00	57.9 PK	74.0	-16.1	1.68 H	192	51.40	6.50
4	5350.00	45.8 AV	54.0	-8.2	1.68 H	192	39.30	6.50
5	10620.00	59.7 PK	74.0	-14.3	1.48 H	53	40.80	18.90
6	10620.00	47.5 AV	54.0	-6.5	1.48 H	53	28.60	18.90

ANTENNA POLARITY & TEST DISTANCE: VERTICAL AT 3 M

NO.	FREQ. (MHz)	EMISSION LEVEL (dBuV/m)	LIMIT (dBuV/m)	MARGIN (dB)	ANTENNA HEIGHT (m)	TABLE ANGLE (Degree)	RAW VALUE (dBuV)	CORRECTION FACTOR (dB/m)
1	*5310.00	101.5 PK			1.15 V	330	61.80	39.70
2	*5310.00	92.4 AV			1.15 V	330	52.70	39.70
3	5350.00	60.1 PK	74.0	-13.9	2.34 V	161	53.60	6.50
4	5350.00	48.3 AV	54.0	-5.7	2.34 V	161	41.80	6.50
5	10620.00	60.5 PK	74.0	-13.5	2.01 V	31	41.60	18.90
6	10620.00	48.8 AV	54.0	-5.2	2.01 V	31	29.90	18.90

REMARKS:

1. Emission Level(dBuV/m) = Raw Value(dBuV) + Correction Factor(dB/m)
2. Correction Factor(dB/m) = Antenna Factor(dB/m) + Cable Factor(dB) – Pre-Amplifier Factor(dB)
3. The other emission levels were very low against the limit.
4. Margin value = Emission Level – Limit value
5. " * ": Fundamental frequency.

CHANNEL	TX Channel 102	DETECTOR FUNCTION	Peak (PK)
FREQUENCY RANGE	1GHz ~ 40GHz		Average (AV)

ANTENNA POLARITY & TEST DISTANCE: HORIZONTAL AT 3 M

NO.	FREQ. (MHz)	EMISSION LEVEL (dBuV/m)	LIMIT (dBuV/m)	MARGIN (dB)	ANTENNA HEIGHT (m)	TABLE ANGLE (Degree)	RAW VALUE (dBuV)	CORRECTION FACTOR (dB/m)
1	5460.00	58.4 PK	74.0	-15.6	1.84 H	209	51.50	6.90
2	5460.00	46.7 AV	54.0	-7.3	1.84 H	209	39.80	6.90
3	#5470.00	61.0 PK	74.0	-13.0	1.77 H	200	54.10	6.90
4	#5470.00	48.5 AV	54.0	-5.5	1.77 H	200	41.60	6.90
5	*5510.00	96.9 PK			1.67 H	201	56.70	40.20
6	*5510.00	88.2 AV			1.67 H	201	48.00	40.20
7	11020.00	60.0 PK	74.0	-14.0	1.52 H	139	40.20	19.80
8	11020.00	48.2 AV	54.0	-5.8	1.52 H	139	28.40	19.80

ANTENNA POLARITY & TEST DISTANCE: VERTICAL AT 3 M

NO.	FREQ. (MHz)	EMISSION LEVEL (dBuV/m)	LIMIT (dBuV/m)	MARGIN (dB)	ANTENNA HEIGHT (m)	TABLE ANGLE (Degree)	RAW VALUE (dBuV)	CORRECTION FACTOR (dB/m)
1	5460.00	60.1 PK	74.0	-13.9	2.56 V	198	53.20	6.90
2	5460.00	48.4 AV	54.0	-5.6	2.56 V	198	41.50	6.90
3	#5470.00	68.2 PK	74.0	-5.8	2.55 V	172	61.30	6.90
4	#5470.00	53.0 AV	54.0	-1.0	2.55 V	172	46.10	6.90
5	*5510.00	99.4 PK			1.46 V	291	59.20	40.20
6	*5510.00	90.7 AV			1.46 V	291	50.50	40.20
7	11020.00	60.3 PK	74.0	-13.7	1.84 V	54	40.50	19.80
8	11020.00	48.6 AV	54.0	-5.4	1.84 V	54	28.80	19.80

REMARKS:

1. Emission Level(dBuV/m) = Raw Value(dBuV) + Correction Factor(dB/m)
2. Correction Factor(dB/m) = Antenna Factor(dB/m) + Cable Factor(dB) – Pre-Amplifier Factor(dB)
3. The other emission levels were very low against the limit.
4. Margin value = Emission Level – Limit value
5. " * ": Fundamental frequency.
6. " # ": The radiated frequency is out of the restricted band.

CHANNEL	TX Channel 110	DETECTOR FUNCTION	Peak (PK)
FREQUENCY RANGE	1GHz ~ 40GHz		Average (AV)

ANTENNA POLARITY & TEST DISTANCE: HORIZONTAL AT 3 M

NO.	FREQ. (MHz)	EMISSION LEVEL (dBuV/m)	LIMIT (dBuV/m)	MARGIN (dB)	ANTENNA HEIGHT (m)	TABLE ANGLE (Degree)	RAW VALUE (dBuV)	CORRECTION FACTOR (dB/m)
1	*5550.00	96.3 PK			1.51 H	204	56.10	40.20
2	*5550.00	86.8 AV			1.51 H	204	46.60	40.20
3	11100.00	60.4 PK	74.0	-13.6	1.43 H	136	41.20	19.20
4	11100.00	48.3 AV	54.0	-5.7	1.43 H	136	29.10	19.20

ANTENNA POLARITY & TEST DISTANCE: VERTICAL AT 3 M

NO.	FREQ. (MHz)	EMISSION LEVEL (dBuV/m)	LIMIT (dBuV/m)	MARGIN (dB)	ANTENNA HEIGHT (m)	TABLE ANGLE (Degree)	RAW VALUE (dBuV)	CORRECTION FACTOR (dB/m)
1	*5550.00	104.8 PK			3.55 V	302	64.60	40.20
2	*5550.00	94.2 AV			3.55 V	302	54.00	40.20
3	11100.00	61.0 PK	74.0	-13.0	2.02 V	146	41.80	19.20
4	11100.00	48.0 AV	54.0	-6.0	2.02 V	146	28.80	19.20

REMARKS:

1. Emission Level(dBuV/m) = Raw Value(dBuV) + Correction Factor(dB/m)
2. Correction Factor(dB/m) = Antenna Factor(dB/m) + Cable Factor(dB) – Pre-Amplifier Factor(dB)
3. The other emission levels were very low against the limit.
4. Margin value = Emission Level – Limit value
5. " * ": Fundamental frequency.

CHANNEL	TX Channel 134	DETECTOR FUNCTION	Peak (PK)
FREQUENCY RANGE	1GHz ~ 40GHz		Average (AV)

ANTENNA POLARITY & TEST DISTANCE: HORIZONTAL AT 3 M

NO.	FREQ. (MHz)	EMISSION LEVEL (dBuV/m)	LIMIT (dBuV/m)	MARGIN (dB)	ANTENNA HEIGHT (m)	TABLE ANGLE (Degree)	RAW VALUE (dBuV)	CORRECTION FACTOR (dB/m)
1	*5670.00	96.0 PK			1.28 H	267	55.70	40.30
2	*5670.00	86.6 AV			1.28 H	267	46.30	40.30
3	#5725.00	58.0 PK	74.0	-16.0	1.20 H	252	50.60	7.40
4	#5725.00	46.5 AV	54.0	-7.5	1.20 H	252	39.10	7.40
5	11340.00	59.8 PK	74.0	-14.2	1.56 H	166	40.60	19.20
6	11340.00	48.0 AV	54.0	-6.0	1.56 H	166	28.80	19.20

ANTENNA POLARITY & TEST DISTANCE: VERTICAL AT 3 M

NO.	FREQ. (MHz)	EMISSION LEVEL (dBuV/m)	LIMIT (dBuV/m)	MARGIN (dB)	ANTENNA HEIGHT (m)	TABLE ANGLE (Degree)	RAW VALUE (dBuV)	CORRECTION FACTOR (dB/m)
1	*5670.00	104.1 PK			3.85 V	153	63.80	40.30
2	*5670.00	94.8 AV			3.85 V	153	54.50	40.30
3	#5725.00	59.9 PK	74.0	-14.1	3.11 V	348	52.50	7.40
4	#5725.00	48.4 AV	54.0	-5.6	3.11 V	348	41.00	7.40
5	11340.00	60.8 PK	74.0	-13.2	2.67 V	140	41.60	19.20
6	11340.00	50.2 AV	54.0	-3.8	2.67 V	140	31.00	19.20

REMARKS:

1. Emission Level(dBuV/m) = Raw Value(dBuV) + Correction Factor(dB/m)
2. Correction Factor(dB/m) = Antenna Factor(dB/m) + Cable Factor(dB) – Pre-Amplifier Factor(dB)
3. The other emission levels were very low against the limit.
4. Margin value = Emission Level – Limit value
5. " * ": Fundamental frequency.
6. " # ": The radiated frequency is out of the restricted band.

CHANNEL	TX Channel 142	DETECTOR FUNCTION	Peak (PK)
FREQUENCY RANGE	1GHz ~ 40GHz		Average (AV)

ANTENNA POLARITY & TEST DISTANCE: HORIZONTAL AT 3 M

NO.	FREQ. (MHz)	EMISSION LEVEL (dBuV/m)	LIMIT (dBuV/m)	MARGIN (dB)	ANTENNA HEIGHT (m)	TABLE ANGLE (Degree)	RAW VALUE (dBuV)	CORRECTION FACTOR (dB/m)
1	#5470.00	56.5 PK	74.0	-17.5	1.19 H	242	49.60	6.90
2	#5470.00	46.2 AV	54.0	-7.8	1.19 H	242	39.30	6.90
3	*5710.00	96.0 PK			1.29 H	269	55.50	40.50
4	*5710.00	85.8 AV			1.29 H	269	45.30	40.50
5	#5850.00	58.2 PK	74.0	-15.8	1.22 H	281	50.60	7.60
6	#5850.00	45.7 AV	54.0	-8.3	1.22 H	281	38.10	7.60
7	11420.00	59.0 PK	74.0	-15.0	1.59 H	160	40.30	18.70
8	11420.00	46.5 AV	54.0	-7.5	1.59 H	160	27.80	18.70

ANTENNA POLARITY & TEST DISTANCE: VERTICAL AT 3 M

NO.	FREQ. (MHz)	EMISSION LEVEL (dBuV/m)	LIMIT (dBuV/m)	MARGIN (dB)	ANTENNA HEIGHT (m)	TABLE ANGLE (Degree)	RAW VALUE (dBuV)	CORRECTION FACTOR (dB/m)
1	#5470.00	58.4 PK	74.0	-15.6	2.99 V	358	51.50	6.90
2	#5470.00	46.9 AV	54.0	-7.1	2.99 V	358	40.00	6.90
3	*5710.00	104.5 PK			3.20 V	163	64.00	40.50
4	*5710.00	94.8 AV			3.20 V	163	54.30	40.50
5	#5850.00	58.1 PK	74.0	-15.9	3.31 V	173	50.50	7.60
6	#5850.00	45.7 AV	54.0	-8.3	3.31 V	173	38.10	7.60
7	11420.00	59.0 PK	74.0	-15.0	2.55 V	149	40.30	18.70
8	11420.00	46.7 AV	54.0	-7.3	2.55 V	149	28.00	18.70

REMARKS:

1. Emission Level(dBuV/m) = Raw Value(dBuV) + Correction Factor(dB/m)
2. Correction Factor(dB/m) = Antenna Factor(dB/m) + Cable Factor(dB) – Pre-Amplifier Factor(dB)
3. The other emission levels were very low against the limit.
4. Margin value = Emission Level – Limit value
5. " * ": Fundamental frequency.
6. " # ": The radiated frequency is out of the restricted band.

CHANNEL	TX Channel 151	DETECTOR FUNCTION	Peak (PK)
FREQUENCY RANGE	1GHz ~ 40GHz		Average (AV)

ANTENNA POLARITY & TEST DISTANCE: HORIZONTAL AT 3 M

NO.	FREQ. (MHz)	EMISSION LEVEL (dBuV/m)	LIMIT (dBuV/m)	MARGIN (dB)	ANTENNA HEIGHT (m)	TABLE ANGLE (Degree)	RAW VALUE (dBuV)	CORRECTION FACTOR (dB/m)
1	#5615.20	57.7 PK	68.2	-10.5	1.23 H	267	50.60	7.10
2	*5755.00	98.0 PK			1.23 H	267	57.40	40.60
3	*5755.00	87.8 AV			1.23 H	267	47.20	40.60
4	#5976.80	58.5 PK	68.2	-9.7	1.23 H	267	50.60	7.90
5	11510.00	59.2 PK	74.0	-14.8	1.37 H	186	40.50	18.70
6	11510.00	47.6 AV	54.0	-6.4	1.37 H	186	28.90	18.70

ANTENNA POLARITY & TEST DISTANCE: VERTICAL AT 3 M

NO.	FREQ. (MHz)	EMISSION LEVEL (dBuV/m)	LIMIT (dBuV/m)	MARGIN (dB)	ANTENNA HEIGHT (m)	TABLE ANGLE (Degree)	RAW VALUE (dBuV)	CORRECTION FACTOR (dB/m)
1	#5606.40	58.6 PK	68.2	-9.6	3.49 V	301	51.50	7.10
2	*5755.00	103.1 PK			3.49 V	301	62.50	40.60
3	*5755.00	92.9 AV			3.49 V	301	52.30	40.60
4	#5981.60	58.8 PK	68.2	-9.4	3.49 V	301	50.90	7.90
5	11510.00	59.8 PK	74.0	-14.2	2.54 V	97	41.10	18.70
6	11510.00	47.8 AV	54.0	-6.2	2.54 V	97	29.10	18.70

REMARKS:

1. Emission Level(dBuV/m) = Raw Value(dBuV) + Correction Factor(dB/m)
2. Correction Factor(dB/m) = Antenna Factor(dB/m) + Cable Factor(dB) – Pre-Amplifier Factor(dB)
3. The other emission levels were very low against the limit.
4. Margin value = Emission Level – Limit value
5. " * ": Fundamental frequency.
6. " # ": The radiated frequency is out of the restricted band.

CHANNEL	TX Channel 159	DETECTOR FUNCTION	Peak (PK)
FREQUENCY RANGE	1GHz ~ 40GHz		Average (AV)

ANTENNA POLARITY & TEST DISTANCE: HORIZONTAL AT 3 M

NO.	FREQ. (MHz)	EMISSION LEVEL (dBuV/m)	LIMIT (dBuV/m)	MARGIN (dB)	ANTENNA HEIGHT (m)	TABLE ANGLE (Degree)	RAW VALUE (dBuV)	CORRECTION FACTOR (dB/m)
1	#5608.00	57.2 PK	68.2	-11.0	1.37 H	267	50.10	7.10
2	*5795.00	96.2 PK			1.37 H	267	55.60	40.60
3	*5795.00	86.5 AV			1.37 H	267	45.90	40.60
4	#5989.60	57.5 PK	68.2	-10.7	1.37 H	267	49.60	7.90
5	11590.00	59.7 PK	74.0	-14.3	1.32 H	221	40.90	18.80
6	11590.00	48.1 AV	54.0	-5.9	1.32 H	221	29.30	18.80

ANTENNA POLARITY & TEST DISTANCE: VERTICAL AT 3 M

NO.	FREQ. (MHz)	EMISSION LEVEL (dBuV/m)	LIMIT (dBuV/m)	MARGIN (dB)	ANTENNA HEIGHT (m)	TABLE ANGLE (Degree)	RAW VALUE (dBuV)	CORRECTION FACTOR (dB/m)
1	#5607.20	58.2 PK	68.2	-10.0	2.98 V	313	51.10	7.10
2	*5795.00	103.0 PK			2.98 V	313	62.40	40.60
3	*5795.00	94.1 AV			2.98 V	313	53.50	40.60
4	#5972.80	58.7 PK	68.2	-9.5	2.98 V	313	50.80	7.90
5	11590.00	60.2 PK	74.0	-13.8	2.04 V	184	41.40	18.80
6	11590.00	48.1 AV	54.0	-5.9	2.04 V	184	29.30	18.80

REMARKS:

1. Emission Level(dBuV/m) = Raw Value(dBuV) + Correction Factor(dB/m)
2. Correction Factor(dB/m) = Antenna Factor(dB/m) + Cable Factor(dB) – Pre-Amplifier Factor(dB)
3. The other emission levels were very low against the limit.
4. Margin value = Emission Level – Limit value
5. " * ": Fundamental frequency.
6. " # ": The radiated frequency is out of the restricted band.

802.11ac (VHT80)_2TX

CHANNEL	TX Channel 42	DETECTOR FUNCTION	Peak (PK)
FREQUENCY RANGE	1GHz ~ 40GHz		Average (AV)

ANTENNA POLARITY & TEST DISTANCE: HORIZONTAL AT 3 M								
NO.	FREQ. (MHz)	EMISSION LEVEL (dBuV/m)	LIMIT (dBuV/m)	MARGIN (dB)	ANTENNA HEIGHT (m)	TABLE ANGLE (Degree)	RAW VALUE (dBuV)	CORRECTION FACTOR (dB/m)
1	5150.00	58.7 PK	74.0	-15.3	1.23 H	268	52.70	6.00
2	5150.00	47.2 AV	54.0	-6.8	1.23 H	268	41.20	6.00
3	*5210.00	93.3 PK			1.28 H	267	53.80	39.50
4	*5210.00	83.0 AV			1.28 H	267	43.50	39.50
5	#10420.00	58.7 PK	74.0	-15.3	1.38 H	197	40.80	17.90
6	#10420.00	47.1 AV	54.0	-6.9	1.38 H	197	29.20	17.90

ANTENNA POLARITY & TEST DISTANCE: VERTICAL AT 3 M								
NO.	FREQ. (MHz)	EMISSION LEVEL (dBuV/m)	LIMIT (dBuV/m)	MARGIN (dB)	ANTENNA HEIGHT (m)	TABLE ANGLE (Degree)	RAW VALUE (dBuV)	CORRECTION FACTOR (dB/m)
1	5150.00	63.7 PK	74.0	-10.3	1.92 V	331	57.70	6.00
2	5150.00	51.7 AV	54.0	-2.3	1.92 V	331	45.70	6.00
3	*5210.00	98.0 PK			1.66 V	333	58.50	39.50
4	*5210.00	88.1 AV			1.66 V	333	48.60	39.50
5	#10420.00	58.5 PK	74.0	-15.5	1.53 V	211	40.60	17.90
6	#10420.00	47.2 AV	54.0	-6.8	1.53 V	211	29.30	17.90

REMARKS:

1. Emission Level(dBuV/m) = Raw Value(dBuV) + Correction Factor(dB/m)
2. Correction Factor(dB/m) = Antenna Factor(dB/m) + Cable Factor(dB) – Pre-Amplifier Factor(dB)
3. The other emission levels were very low against the limit.
4. Margin value = Emission Level – Limit value
5. " * ": Fundamental frequency.
6. " # ": The radiated frequency is out of the restricted band.

CHANNEL	TX Channel 58	DETECTOR FUNCTION	Peak (PK)
FREQUENCY RANGE	1GHz ~ 40GHz		Average (AV)

ANTENNA POLARITY & TEST DISTANCE: HORIZONTAL AT 3 M

NO.	FREQ. (MHz)	EMISSION LEVEL (dBuV/m)	LIMIT (dBuV/m)	MARGIN (dB)	ANTENNA HEIGHT (m)	TABLE ANGLE (Degree)	RAW VALUE (dBuV)	CORRECTION FACTOR (dB/m)
1	*5290.00	92.5 PK			1.54 H	201	52.80	39.70
2	*5290.00	83.4 AV			1.54 H	201	43.70	39.70
3	5350.00	57.9 PK	74.0	-16.1	1.43 H	184	51.40	6.50
4	5350.00	45.6 AV	54.0	-8.4	1.43 H	184	39.10	6.50
5	#10580.00	59.5 PK	74.0	-14.5	1.47 H	128	40.50	19.00
6	#10580.00	47.5 AV	54.0	-6.5	1.47 H	128	28.50	19.00

ANTENNA POLARITY & TEST DISTANCE: VERTICAL AT 3 M

NO.	FREQ. (MHz)	EMISSION LEVEL (dBuV/m)	LIMIT (dBuV/m)	MARGIN (dB)	ANTENNA HEIGHT (m)	TABLE ANGLE (Degree)	RAW VALUE (dBuV)	CORRECTION FACTOR (dB/m)
1	*5290.00	98.0 PK			1.50 V	330	58.30	39.70
2	*5290.00	88.3 AV			1.50 V	330	48.60	39.70
3	5350.00	58.6 PK	74.0	-15.4	1.57 V	322	52.10	6.50
4	5350.00	46.6 AV	54.0	-7.4	1.57 V	322	40.10	6.50
5	#10580.00	59.6 PK	74.0	-14.4	1.53 V	219	40.60	19.00
6	#10580.00	46.6 AV	54.0	-7.4	1.53 V	219	27.60	19.00

REMARKS:

1. Emission Level(dBuV/m) = Raw Value(dBuV) + Correction Factor(dB/m)
2. Correction Factor(dB/m) = Antenna Factor(dB/m) + Cable Factor(dB) – Pre-Amplifier Factor(dB)
3. The other emission levels were very low against the limit.
4. Margin value = Emission Level – Limit value
5. " * ": Fundamental frequency.
6. " # ": The radiated frequency is out of the restricted band.



CHANNEL	TX Channel 106	DETECTOR FUNCTION	Peak (PK)
FREQUENCY RANGE	1GHz ~ 40GHz		Average (AV)

ANTENNA POLARITY & TEST DISTANCE: HORIZONTAL AT 3 M

NO.	FREQ. (MHz)	EMISSION LEVEL (dBuV/m)	LIMIT (dBuV/m)	MARGIN (dB)	ANTENNA HEIGHT (m)	TABLE ANGLE (Degree)	RAW VALUE (dBuV)	CORRECTION FACTOR (dB/m)
1	5460.00	59.7 PK	74.0	-14.3	1.49 H	199	52.80	6.90
2	5460.00	48.1 AV	54.0	-5.9	1.49 H	199	41.20	6.90
3	#5470.00	60.8 PK	74.0	-13.2	1.44 H	199	53.90	6.90
4	#5470.00	49.2 AV	54.0	-4.8	1.44 H	199	42.30	6.90
5	*5530.00	92.6 PK			1.25 H	201	52.40	40.20
6	*5530.00	83.8 AV			1.25 H	201	43.60	40.20
7	#5725.00	58.3 PK	74.0	-15.7	1.22 H	208	50.90	7.40
8	#5725.00	45.1 AV	54.0	-8.9	1.22 H	208	37.70	7.40
9	11060.00	60.8 PK	74.0	-13.2	1.61 H	187	41.30	19.50
10	11060.00	48.5 AV	54.0	-5.5	1.61 H	187	29.00	19.50

ANTENNA POLARITY & TEST DISTANCE: VERTICAL AT 3 M

NO.	FREQ. (MHz)	EMISSION LEVEL (dBuV/m)	LIMIT (dBuV/m)	MARGIN (dB)	ANTENNA HEIGHT (m)	TABLE ANGLE (Degree)	RAW VALUE (dBuV)	CORRECTION FACTOR (dB/m)
1	5460.00	64.3 PK	74.0	-9.7	3.66 V	300	57.40	6.90
2	5460.00	52.0 AV	54.0	-2.0	3.66 V	300	45.10	6.90
3	#5470.00	67.0 PK	74.0	-7.0	3.66 V	303	60.10	6.90
4	#5470.00	52.8 AV	54.0	-1.2	3.66 V	303	45.90	6.90
5	*5530.00	99.9 PK			3.84 V	175	59.70	40.20
6	*5530.00	89.7 AV			3.84 V	175	49.50	40.20
7	#5725.00	57.6 PK	74.0	-16.4	3.69 V	186	50.20	7.40
8	#5725.00	48.4 AV	54.0	-5.6	3.69 V	186	41.00	7.40
9	11060.00	60.2 PK	74.0	-13.8	2.84 V	293	40.70	19.50
10	11060.00	48.7 AV	54.0	-5.3	2.84 V	293	29.20	19.50

REMARKS:

1. Emission Level(dBuV/m) = Raw Value(dBuV) + Correction Factor(dB/m)
2. Correction Factor(dB/m) = Antenna Factor(dB/m) + Cable Factor(dB) – Pre-Amplifier Factor(dB)
3. The other emission levels were very low against the limit.
4. Margin value = Emission Level – Limit value
5. " * ": Fundamental frequency.
6. " # ": The radiated frequency is out of the restricted band.

CHANNEL	TX Channel 138	DETECTOR FUNCTION	Peak (PK)
FREQUENCY RANGE	1GHz ~ 40GHz		Average (AV)

ANTENNA POLARITY & TEST DISTANCE: HORIZONTAL AT 3 M

NO.	FREQ. (MHz)	EMISSION LEVEL (dBuV/m)	LIMIT (dBuV/m)	MARGIN (dB)	ANTENNA HEIGHT (m)	TABLE ANGLE (Degree)	RAW VALUE (dBuV)	CORRECTION FACTOR (dB/m)
1	#5470.00	59.8 PK	74.0	-14.2	1.34 H	109	52.90	6.90
2	#5470.00	48.4 AV	54.0	-5.6	1.34 H	109	41.50	6.90
3	*5690.00	92.0 PK			1.23 H	200	51.60	40.40
4	*5690.00	83.0 AV			1.23 H	200	42.60	40.40
5	#5825.00	58.3 PK	74.0	-15.7	1.47 H	299	50.80	7.50
6	#5825.00	49.6 AV	54.0	-4.4	1.47 H	299	42.10	7.50
7	#5850.00	59.5 PK	74.0	-14.5	1.44 H	303	51.90	7.60
8	#5850.00	46.1 AV	54.0	-7.9	1.44 H	303	38.50	7.60
9	11380.00	59.9 PK	74.0	-14.1	1.41 H	167	41.00	18.90
10	11380.00	46.9 AV	54.0	-7.1	1.41 H	167	28.00	18.90

ANTENNA POLARITY & TEST DISTANCE: VERTICAL AT 3 M

NO.	FREQ. (MHz)	EMISSION LEVEL (dBuV/m)	LIMIT (dBuV/m)	MARGIN (dB)	ANTENNA HEIGHT (m)	TABLE ANGLE (Degree)	RAW VALUE (dBuV)	CORRECTION FACTOR (dB/m)
1	#5470.00	59.0 PK	74.0	-15.0	3.46 V	303	52.10	6.90
2	#5470.00	49.8 AV	54.0	-4.2	3.46 V	303	42.90	6.90
3	*5690.00	98.8 PK			3.54 V	195	58.40	40.40
4	*5690.00	88.9 AV			3.54 V	195	48.50	40.40
5	#5825.00	60.9 PK	74.0	-13.1	3.46 V	303	53.40	7.50
6	#5825.00	49.6 AV	54.0	-4.4	3.46 V	303	42.10	7.50
7	#5850.00	58.7 PK	74.0	-15.3	3.52 V	317	51.10	7.60
8	#5850.00	45.8 AV	54.0	-8.2	3.52 V	317	38.20	7.60
9	11380.00	59.6 PK	74.0	-14.4	2.74 V	273	40.70	18.90
10	11380.00	46.1 AV	54.0	-7.9	2.74 V	273	27.20	18.90

REMARKS:

1. Emission Level(dBuV/m) = Raw Value(dBuV) + Correction Factor(dB/m)
2. Correction Factor(dB/m) = Antenna Factor(dB/m) + Cable Factor(dB) – Pre-Amplifier Factor(dB)
3. The other emission levels were very low against the limit.
4. Margin value = Emission Level – Limit value
5. " * ": Fundamental frequency.
6. " # ": The radiated frequency is out of the restricted band.

CHANNEL	TX Channel 155	DETECTOR FUNCTION	Peak (PK)
FREQUENCY RANGE	1GHz ~ 40GHz		Average (AV)

ANTENNA POLARITY & TEST DISTANCE: HORIZONTAL AT 3 M

NO.	FREQ. (MHz)	EMISSION LEVEL (dBuV/m)	LIMIT (dBuV/m)	MARGIN (dB)	ANTENNA HEIGHT (m)	TABLE ANGLE (Degree)	RAW VALUE (dBuV)	CORRECTION FACTOR (dB/m)
1	#5601.60	57.2 PK	68.2	-11.0	1.22 H	267	50.10	7.10
2	*5775.00	93.6 PK			1.22 H	267	53.00	40.60
3	*5775.00	83.5 AV			1.22 H	267	42.90	40.60
4	#5973.60	58.3 PK	68.2	-9.9	1.22 H	267	50.40	7.90
5	11550.00	60.0 PK	74.0	-14.0	1.07 H	206	41.40	18.60
6	11550.00	47.7 AV	54.0	-6.3	1.07 H	206	29.10	18.60

ANTENNA POLARITY & TEST DISTANCE: VERTICAL AT 3 M

NO.	FREQ. (MHz)	EMISSION LEVEL (dBuV/m)	LIMIT (dBuV/m)	MARGIN (dB)	ANTENNA HEIGHT (m)	TABLE ANGLE (Degree)	RAW VALUE (dBuV)	CORRECTION FACTOR (dB/m)
1	#5640.00	58.6 PK	68.2	-9.6	3.40 V	315	51.50	7.10
2	*5775.00	98.6 PK			3.40 V	315	58.00	40.60
3	*5775.00	88.8 AV			3.40 V	315	48.20	40.60
4	#5956.80	57.8 PK	68.2	-10.4	3.40 V	315	50.10	7.70
5	11550.00	59.9 PK	74.0	-14.1	2.11 V	184	41.30	18.60
6	11550.00	47.6 AV	54.0	-6.4	2.11 V	184	29.00	18.60

REMARKS:

1. Emission Level(dBuV/m) = Raw Value(dBuV) + Correction Factor(dB/m)
2. Correction Factor(dB/m) = Antenna Factor(dB/m) + Cable Factor(dB) – Pre-Amplifier Factor(dB)
3. The other emission levels were very low against the limit.
4. Margin value = Emission Level – Limit value
5. " * ": Fundamental frequency.
6. " # ": The radiated frequency is out of the restricted band.

Below 1GHz worst-case data:

802.11ac (VHT20)_2TX

CHANNEL	TX Channel 36	DETECTOR FUNCTION	Quasi-Peak (QP)
FREQUENCY RANGE	30MHz ~ 1GHz		

ANTENNA POLARITY & TEST DISTANCE: HORIZONTAL AT 3 M								
NO.	FREQ. (MHz)	EMISSION LEVEL (dBuV/m)	LIMIT (dBuV/m)	MARGIN (dB)	ANTENNA HEIGHT (m)	TABLE ANGLE (Degree)	RAW VALUE (dBuV)	CORRECTION FACTOR (dB/m)
1	29.90	23.6 QP	40.0	-16.4	1.00 H	46	39.80	-16.20
2	57.12	28.5 QP	40.0	-11.5	1.50 H	39	43.10	-14.60
3	70.73	24.7 QP	40.0	-15.3	1.00 H	140	41.30	-16.60
4	84.34	17.9 QP	40.0	-22.1	1.50 H	17	37.30	-19.40
5	132.95	17.2 QP	43.5	-26.3	1.50 H	12	32.50	-15.30
6	899.00	32.5 QP	46.0	-13.5	1.00 H	270	32.50	0.00
ANTENNA POLARITY & TEST DISTANCE: VERTICAL AT 3 M								
NO.	FREQ. (MHz)	EMISSION LEVEL (dBuV/m)	LIMIT (dBuV/m)	MARGIN (dB)	ANTENNA HEIGHT (m)	TABLE ANGLE (Degree)	RAW VALUE (dBuV)	CORRECTION FACTOR (dB/m)
1	29.90	25.1 QP	40.0	-14.9	1.00 V	329	41.30	-16.20
2	57.12	26.4 QP	40.0	-13.6	1.00 V	320	41.00	-14.60
3	103.78	26.0 QP	43.5	-17.5	1.00 V	333	44.20	-18.20
4	111.56	28.3 QP	43.5	-15.2	1.00 V	50	45.40	-17.10
5	132.95	20.0 QP	43.5	-23.5	1.00 V	7	35.30	-15.30
6	757.06	27.5 QP	46.0	-18.5	1.00 V	100	30.20	-2.70

REMARKS:

1. Emission Level(dBuV/m) = Raw Value(dBuV) + Correction Factor(dB/m)
2. Correction Factor(dB/m) = Antenna Factor(dB/m) + Cable Factor(dB)
3. The other emission levels were very low against the limit.
4. Margin value = Emission Level – Limit value

4.2 Conducted Emission Measurement

4.2.1 Limits of Conducted Emission Measurement

Frequency (MHz)	Conducted Limit (dBuV)	
	Quasi-peak	Average
0.15 - 0.5	66 - 56	56 - 46
0.50 - 5.0	56	46
5.0 - 30.0	60	50

- Note:** 1. The lower limit shall apply at the transition frequencies.
 2. The limit decreases in line with the logarithm of the frequency in the range of 0.15 to 0.50MHz.

4.2.2 Test Instruments

Description & Manufacturer	Model No.	Serial No.	Date Of Calibration	Due Date Of Calibration
Test Receiver ROHDE & SCHWARZ	ESCI	100613	Nov. 16, 2015	Nov. 15, 2016
RF signal cable (with 10dB PAD) Woken	5D-FB	Cable-cond1-01	Dec. 26, 2015	Dec. 25, 2016
LISN ROHDE & SCHWARZ (EUT)	ESH3-Z5	835239/001	Feb. 26, 2016	Feb. 25, 2017
LISN ROHDE & SCHWARZ (Peripheral)	ESH3-Z5	100311	Jul. 24, 2015	Jul. 23, 2016
Software ADT	BV ADT_Cond_ V7.3.7.3	NA	NA	NA

- Note:** 1. The calibration interval of the above test instruments is 12 months and the calibrations are traceable to NML/ROC and NIST/USA.
 2. The test was performed in HwaYa Shielded Room 1.
 3. The VCCI Site Registration No. is C-2040.

4.2.3 Test Procedures

- The EUT was placed 0.4 meters from the conducting wall of the shielded room with EUT being connected to the power mains through a line impedance stabilization network (LISN). Other support units were connected to the power mains through another LISN. The two LISNs provide 50 ohm/ 50uH of coupling impedance for the measuring instrument.
- Both lines of the power mains connected to the EUT were checked for maximum conducted interference.
- The frequency range from 150kHz to 30MHz was searched. Emission levels under (Limit - 20dB) was not recorded.

NOTE: The resolution bandwidth and video bandwidth of test receiver is 9kHz for quasi-peak detection (QP) and average detection (AV) at frequency 0.15MHz-30MHz.

4.2.4 Deviation from Test Standard

No deviation.

4.2.5 Test Setup

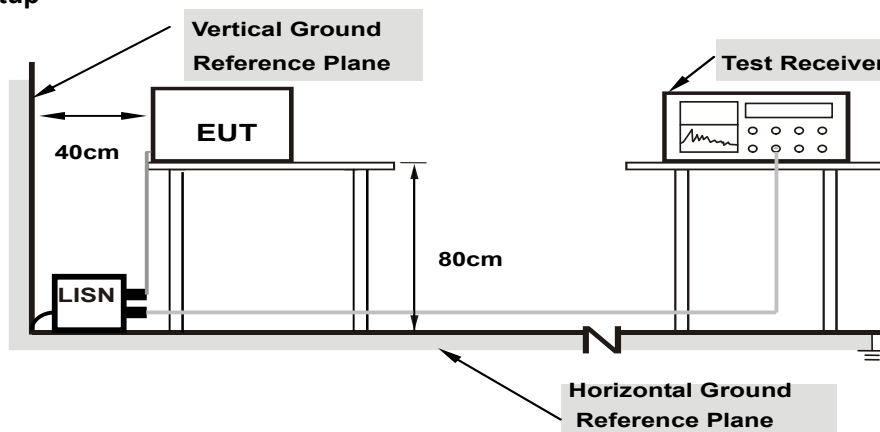

Note: 1.Support units were connected to second LISN.

For the actual test configuration, please refer to the attached file (Test Setup Photo).

4.2.6 EUT Operating Conditions

Same as 4.1.6.

4.2.7 Test Results

Phase	Line (L)	Detector Function	Quasi-Peak (QP) / Average (AV)
-------	----------	-------------------	--------------------------------

No	Freq. [MHz]	Corr. Factor (dB)	Reading Value		Emission Level		Limit		Margin	
			[dB (uV)]		[dB (uV)]		[dB (uV)]		(dB)	
			Q.P.	AV.	Q.P.	AV.	Q.P.	AV.	Q.P.	AV.
1	0.16600	10.02	7.75	5.96	17.77	15.98	65.16	55.16	-47.39	-39.18
2	0.53000	10.14	11.21	2.69	21.35	12.83	56.00	46.00	-34.65	-33.17
3	0.73800	10.17	6.24	1.84	16.41	12.01	56.00	46.00	-39.59	-33.99
4	0.91000	10.19	7.06	2.59	17.25	12.78	56.00	46.00	-38.75	-33.22
5	1.17000	10.21	3.22	0.67	13.43	10.88	56.00	46.00	-42.57	-35.12
6	26.61000	11.78	6.03	2.44	17.81	14.22	60.00	50.00	-42.19	-35.78

REMARKS:

1. Q.P. and AV. are abbreviations of quasi-peak and average individually.
2. The emission levels of other frequencies were very low against the limit.
3. Margin value = Emission level - Limit value
4. Correction factor = Insertion loss + Cable loss
5. Emission Level = Correction Factor + Reading Value.

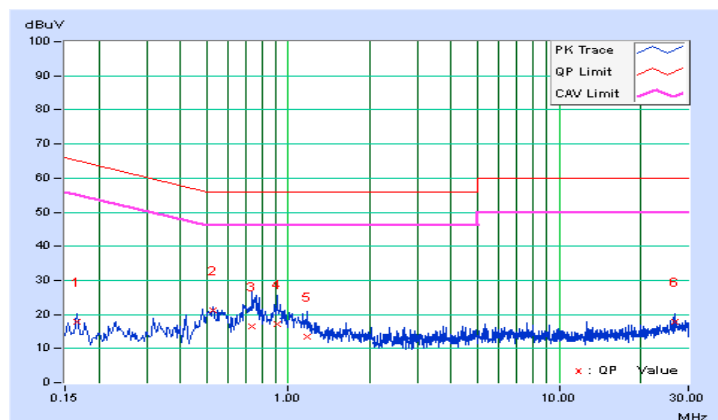

Phase	Neutral (N)	Detector Function	Quasi-Peak (QP) / Average (AV)
-------	-------------	-------------------	--------------------------------

No	Freq. [MHz]	Corr. Factor (dB)	Reading Value [dB (uV)]		Emission Level [dB (uV)]		Limit [dB (uV)]		Margin (dB)	
			Q.P.	AV.	Q.P.	AV.	Q.P.	AV.	Q.P.	AV.
			1	0.39400	10.13	0.91	0.45	11.04	10.58	57.98
2	0.55800	10.15	8.13	1.64	18.28	11.79	56.00	46.00	-37.72	-34.21
3	0.69502	10.17	7.44	2.28	17.61	12.45	56.00	46.00	-38.39	-33.55
4	0.89000	10.20	8.44	3.95	18.64	14.15	56.00	46.00	-37.36	-31.85
5	5.66600	10.53	5.40	0.91	15.93	11.44	60.00	50.00	-44.07	-38.56
6	26.61000	11.94	8.27	5.00	20.21	16.94	60.00	50.00	-39.79	-33.06

REMARKS:

1. Q.P. and AV. are abbreviations of quasi-peak and average individually.
2. The emission levels of other frequencies were very low against the limit.
3. Margin value = Emission level - Limit value
4. Correction factor = Insertion loss + Cable loss
5. Emission Level = Correction Factor + Reading Value.

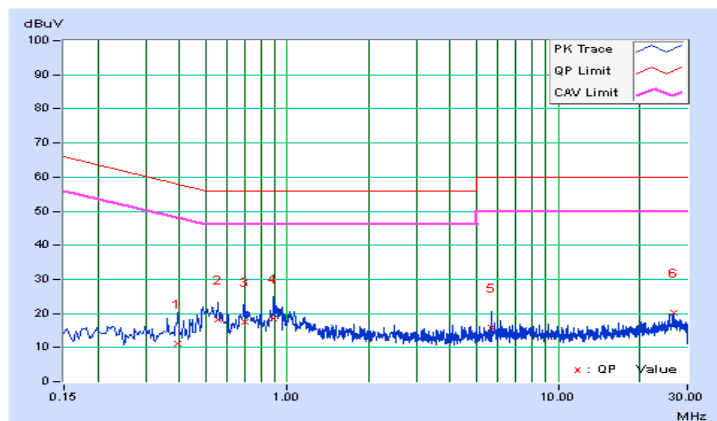

4.3 Transmit Power Measurement

4.3.1 Limits of Transmit Power Measurement

Operation Band	EUT Category		LIMIT
U-NII-1		Outdoor Access Point	1 Watt (30 dBm) (Max. e.i.r.p \leq 125mW(21 dBm) at any elevation angle above 30 degrees as measured from the horizon)
		Fixed point-to-point Access Point	1 Watt (30 dBm)
		Indoor Access Point	1 Watt (30 dBm)
	√	Mobile and Portable client device	250mW (24 dBm)
U-NII-2A		√	250mW (24 dBm) or 11 dBm+10 log B*
U-NII-2C		√	250mW (24 dBm) or 11 dBm+10 log B*
U-NII-3		√	1 Watt (30 dBm)

*B is the 26 dB emission bandwidth in megahertz

Per KDB 662911 Method of conducted output power measurement on IEEE 802.11 devices,

Array Gain = 0 dB (i.e., no array gain) for $N_{ANT} \leq 4$;

Array Gain = 0 dB (i.e., no array gain) for channel widths ≥ 40 MHz for any N_{ANT} ;

Array Gain = $5 \log(N_{ANT}/N_{SS})$ dB or 3 dB, whichever is less for 20-MHz channel widths with $N_{ANT} \geq 5$.

For power measurements on all other devices: Array Gain = $10 \log(N_{ANT}/N_{SS})$ dB.

4.3.2 Test Setup

For Power Output Measurement

For 802.11a, 802.11ac (VHT20), 802.11ac (VHT40)

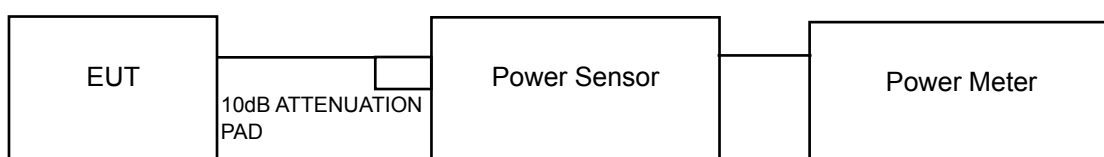

For 802.11ac (VHT80)

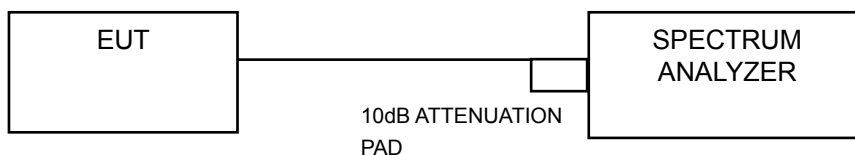

For 26dB and Occupied Bandwidth

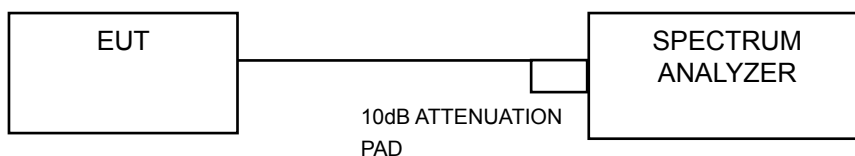

4.3.3 Test Instruments

Refer to section 4.1.2 to get information of above instrument.

4.3.4 Test Procedure

FOR AVERAGE POWER MEASUREMENT

For 802.11a, 802.11ac (VHT20), 802.11ac (VHT40)

Method PM is used to perform output power measurement, trigger and gating function of wide band power meter is enabled to measure max output power of TX on burst. Duty factor is not added to measured value.

For 802.11ac (VHT80)

- 1) Set span to encompass the entire 26 dB EBW (or, alternatively, the entire 99% occupied bandwidth) of the signal.
- 2) Set sweep trigger to "free run".
- 3) Set RBW = 1 MHz.
- 4) Set VBW \geq 3 MHz
- 5) Number of points in sweep \geq 2 Span / RBW.
- 6) Sweep time \leq (number of points in sweep) * T
- 7) Using emission bandwidth to determine the frequency span for integration the channel bandwidth.
- 8) Detector = RMS.
- 9) Trace mode = max hold.
- 10) Allow max hold to run for at least 60 seconds, or longer as needed to allow the trace to stabilize.

FOR 26dB BANDWIDTH

- 1) Set RBW = approximately 1% of the emission bandwidth.
- 2) Set the VBW > RBW.
- 3) Detector = Peak.
- 4) Trace mode = max hold.
- 5) Measure the maximum width of the emission that is 26 dB down from the peak of the emission. Compare this with the RBW setting of the analyzer. Readjust RBW and repeat measurement as needed until the RBW/EBW ratio is approximately 1%.

FOR OCCUPIED BANDWIDTH

The transmitter output was connected to the spectrum analyzer through an attenuator. The bandwidth of the fundamental frequency was measured by spectrum analyzer with resolution bandwidth in the range of 1% to 5% of the anticipated emission bandwidth, and a video bandwidth at least 3x the resolution bandwidth and set the detector to Sampling. The width of a frequency band such that, below the lower and above the upper frequency limits, the mean powers emitted are each equal to a specified percentage 0.5 % of the total mean power of a given emission.

4.3.5 Deviation from Test Standard

No deviation.

4.3.6 EUT Operating Conditions

The software provided by client to enable the EUT under transmission condition continuously at lowest, middle and highest channel frequencies individually.

4.3.7 Test Result

POWER OUTPUT:

802.11a

Chan.	Freq. (MHz)	Maximum Conducted Power (mW)	Maximum Conducted Power (dBm)	Power Limit (dBm)	Pass / Fail
36	5180	8.511	9.30	24.00	Pass
40	5200	8.551	9.32	24.00	Pass
48	5240	8.035	9.05	24.00	Pass
52	5260	8.453	9.27	24.00	Pass
60	5300	8.551	9.32	24.00	Pass
64	5320	8.356	9.22	24.00	Pass
100	5500	8.110	9.09	24.00	Pass
116	5580	8.974	9.53	24.00	Pass
140	5700	9.162	9.62	24.00	Pass
149	5745	9.290	9.68	30.00	Pass
157	5785	9.419	9.74	30.00	Pass
165	5825	9.572	9.81	30.00	Pass

Chan.	Freq. (MHz)	Maximum Conducted Power without Duty Factor (dBm)	Duty factor	Maximum Conducted Power with Duty Factor (mW)	Maximum Conducted Power with Duty Factor (dBm)	Power Limit (dBm)	Pass / Fail
144	5720 For U-NII-2C	5.47	0.35	3.822	5.82	23.00	Pass
144	5720 For U-NII-3	0.74	0.35	1.286	1.09	30.00	Pass

NOTE:

For U-NII-2A, U-NII-2C Band:

- $11\text{dBm} + 10\log(21.85) = 24.39\text{ dBm} > 24\text{dBm}$.
- $11\text{dBm} + 10\log(21.77) = 24.38\text{ dBm} > 24\text{dBm}$.
- $11\text{dBm} + 10\log(21.90) = 24.40\text{ dBm} > 24\text{dBm}$.
- $11\text{dBm} + 10\log(21.86) = 24.40\text{ dBm} > 24\text{dBm}$.
- $11\text{dBm} + 10\log(21.64) = 24.35\text{ dBm} > 24\text{dBm}$.
- $11\text{dBm} + 10\log(21.69) = 24.36\text{ dBm} > 24\text{dBm}$.
- $11\text{dBm} + 10\log(5725.00 - 5709.13) = 23.00\text{ dBm} < 24\text{dBm}$.

802.11ac (VHT20)

Chan.	Freq. (MHz)	Maximum Conducted Power (mW)	Maximum Conducted Power (dBm)	Power Limit (dBm)	Pass / Fail
36	5180	8.630	9.36	24.00	Pass
40	5200	7.907	8.98	24.00	Pass
48	5240	8.356	9.22	24.00	Pass
52	5260	8.690	9.39	24.00	Pass
60	5300	8.433	9.26	24.00	Pass
64	5320	8.279	9.18	24.00	Pass
100	5500	8.790	9.44	24.00	Pass
116	5580	9.016	9.55	24.00	Pass
140	5700	9.594	9.82	24.00	Pass
149	5745	9.120	9.60	30.00	Pass
157	5785	10.280	10.12	30.00	Pass
165	5825	9.954	9.98	30.00	Pass

Chan.	Freq. (MHz)	Maximum Conducted Power without Duty Factor (dBm)	Duty factor	Maximum Conducted Power with Duty Factor (mW)	Maximum Conducted Power with Duty Factor (dBm)	Power Limit (dBm)	Pass / Fail
144	5720 For U-NII-2C	5.14	0.38	3.566	5.52	23.04	Pass
144	5720 For U-NII-3	-0.51	0.38	0.9707	-0.13	30.00	Pass

NOTE:
For U-NII-2A, U-NII-2C Band:

- $11\text{dBm} + 10\log(22.08) = 24.44\text{ dBm} > 24\text{dBm}$.
- $11\text{dBm} + 10\log(22.17) = 24.46\text{ dBm} > 24\text{dBm}$.
- $11\text{dBm} + 10\log(22.10) = 24.44\text{ dBm} > 24\text{dBm}$.
- $11\text{dBm} + 10\log(22.18) = 24.46\text{ dBm} > 24\text{dBm}$.
- $11\text{dBm} + 10\log(22.02) = 24.43\text{ dBm} > 24\text{dBm}$.
- $11\text{dBm} + 10\log(22.25) = 24.47\text{ dBm} > 24\text{dBm}$.
- $11\text{dBm} + 10\log(5725.00 - 5708.97) = 23.04\text{ dBm} < 24\text{dBm}$.



802.11ac (VHT40)

Chan.	Freq. (MHz)	Maximum Conducted Power (mW)	Maximum Conducted Power (dBm)	Power Limit (dBm)	Pass / Fail
38	5190	6.577	8.18	24.00	Pass
46	5230	6.383	8.05	24.00	Pass
54	5270	6.471	8.11	24.00	Pass
62	5310	5.943	7.74	24.00	Pass
102	5510	6.383	8.05	24.00	Pass
110	5550	6.501	8.13	24.00	Pass
134	5670	5.754	7.60	24.00	Pass
151	5755	5.768	7.61	30.00	Pass
159	5795	6.368	8.04	30.00	Pass

Chan.	Freq. (MHz)	Maximum Conducted Power without Duty Factor (dBm)	Duty factor	Maximum Conducted Power with Duty Factor (mW)	Maximum Conducted Power with Duty Factor (dBm)	Power Limit (dBm)	Pass / Fail
142	5710 For U-NII-2C	1.43	0.68	1.628	2.12	24.00	Pass
142	5710 For U-NII-3	-8.89	0.68	0.1512	-8.20	30.00	Pass

NOTE:

For U-NII-2A, U-NII-2C Band:

1. $11\text{dBm} + 10\log(41.72) = 27.20\text{ dBm} > 24\text{dBm}$.
2. $11\text{dBm} + 10\log(41.58) = 27.19\text{ dBm} > 24\text{dBm}$.
3. $11\text{dBm} + 10\log(41.80) = 27.21\text{ dBm} > 24\text{dBm}$.
4. $11\text{dBm} + 10\log(41.67) = 27.20\text{ dBm} > 24\text{dBm}$.
5. $11\text{dBm} + 10\log(41.68) = 27.20\text{ dBm} > 24\text{dBm}$.
6. $11\text{dBm} + 10\log(5725.00 - 5689.43) = 26.51\text{ dBm} > 24\text{dBm}$.



802.11ac (VHT80)

Chan.	Freq. (MHz)	Maximum Conducted Power (mW)	Maximum Conducted Power (dBm)	Power Limit (dBm)	Pass / Fail
42	5210	6.934	8.41	24.00	Pass
58	5290	6.792	8.32	24.00	Pass
106	5530	7.228	8.59	24.00	Pass
155	5775	6.918	8.40	30.00	Pass

Chan.	Freq. (MHz)	Maximum Conducted Power without Duty Factor (dBm)	Duty factor	Maximum Conducted Power with Duty Factor (mW)	Maximum Conducted Power with Duty Factor (dBm)	Power Limit (dBm)	Pass / Fail
138	5690 For U-NII-2C	-2.21	1.32	0.8135	-0.90	24.00	Pass
138	5690 For U-NII-3	-15.74	1.32	0.0361	-14.42	30.00	Pass

NOTE:

For U-NII-2A, U-NII-2C Band:

1. $11\text{dBm} + 10\log(83.18) = 30.20\text{ dBm} > 24\text{dBm}$.
2. $11\text{dBm} + 10\log(82.56) = 30.17\text{ dBm} > 24\text{dBm}$.
3. $11\text{dBm} + 10\log(5725.00 - 5648.56) = 29.83\text{ dBm} > 24\text{dBm}$.

802.11ac (VHT20)

Chan.	Freq. (MHz)	Maximum Conducted Power (dBm)		Total Power (mW)	Total Power (dBm)	Power Limit (dBm)	Pass / Fail
		Chain 0	Chain 1				
36	5180	9.27	8.86	16.144	12.08	24.00	Pass
40	5200	9.33	8.94	16.404	12.15	24.00	Pass
48	5240	9.06	8.83	15.692	11.96	24.00	Pass
52	5260	9.29	8.97	16.381	12.14	24.00	Pass
60	5300	9.11	8.75	15.646	11.94	24.00	Pass
64	5320	9.12	8.99	16.091	12.07	24.00	Pass
100	5500	9.07	9.25	16.486	12.17	24.00	Pass
116	5580	9.72	9.25	17.790	12.50	24.00	Pass
140	5700	9.92	9.95	19.703	12.95	24.00	Pass
149	5745	9.82	9.61	18.735	12.73	30.00	Pass
157	5785	9.80	9.34	18.140	12.59	30.00	Pass
165	5825	9.22	9.24	16.751	12.24	30.00	Pass

Chan.	Freq. (MHz)	Maximum Conducted Power (dBm)		Duty factor	Maximum Conducted Power with Duty Factor (mW)	Maximum Conducted Power with Duty Factor (dBm)	Power Limit (dBm)	Pass / Fail
		Chain 0	Chain 1					
144	5720 For U-NII-2C	3.67	4.40	0.39	5.56	7.45	23.04	Pass
144	5720 For U-NII-3	-0.53	-2.39	0.39	1.5995	2.04	30.00	Pass

NOTE:
For U-NII-2A, U-NII-2C Band:
Chain 0

1. $11\text{dBm} + 10\log(22.18) = 24.46\text{ dBm} > 24\text{dBm}$.
2. $11\text{dBm} + 10\log(21.98) = 24.42\text{ dBm} > 24\text{dBm}$.
3. $11\text{dBm} + 10\log(21.99) = 24.42\text{ dBm} > 24\text{dBm}$.
4. $11\text{dBm} + 10\log(22.15) = 24.45\text{ dBm} > 24\text{dBm}$.
5. $11\text{dBm} + 10\log(22.96) = 24.61\text{ dBm} > 24\text{dBm}$.
6. $11\text{dBm} + 10\log(22.03) = 24.43\text{ dBm} > 24\text{dBm}$.
7. $11\text{dBm} + 10\log(5725.00 - 5709.00) = 23.04\text{ dBm} < 24\text{dBm}$.

Chain 1

1. $11\text{dBm} + 10\log(21.81) = 24.39\text{ dBm} > 24\text{dBm}$.
2. $11\text{dBm} + 10\log(21.79) = 24.38\text{ dBm} > 24\text{dBm}$.
3. $11\text{dBm} + 10\log(21.82) = 24.39\text{ dBm} > 24\text{dBm}$.
4. $11\text{dBm} + 10\log(21.95) = 24.41\text{ dBm} > 24\text{dBm}$.
5. $11\text{dBm} + 10\log(21.81) = 24.39\text{ dBm} > 24\text{dBm}$.
6. $11\text{dBm} + 10\log(21.76) = 24.38\text{ dBm} > 24\text{dBm}$.
7. $11\text{dBm} + 10\log(5725.00 - 5708.78) = 23.10\text{ dBm} < 24\text{dBm}$.



802.11ac (VHT40)

Chan.	Freq. (MHz)	Maximum Conducted Power (dBm)		Total Power (mW)	Total Power (dBm)	Power Limit (dBm)	Pass / Fail
		Chain 0	Chain 1				
38	5190	7.04	6.63	9.661	9.85	24.00	Pass
46	5230	7.13	6.76	9.906	9.96	24.00	Pass
54	5270	7.17	6.94	10.155	10.07	24.00	Pass
62	5310	9.11	8.75	15.646	11.94	24.00	Pass
102	5510	9.59	9.60	18.219	12.61	24.00	Pass
110	5550	7.10	6.60	9.700	9.87	24.00	Pass
134	5670	7.20	6.90	10.146	10.06	24.00	Pass
151	5755	7.61	7.02	10.803	10.34	30.00	Pass
159	5795	8.04	6.99	11.368	10.56	30.00	Pass

Chan.	Freq. (MHz)	Maximum Conducted Power (dBm)		Duty factor	Maximum Conducted Power with Duty Factor (mW)	Maximum Conducted Power with Duty Factor (dBm)	Power Limit (dBm)	Pass / Fail
		Chain 0	Chain 1					
142	5710 For U-NII-2C	0.64	1.29	0.77	2.989	4.76	24.00	Pass
142	5710 For U-NII-3	-8.47	-9.19	0.77	0.3135	-5.04	30.00	Pass

NOTE:

For U-NII-2A, U-NII-2C Band:

Chain 0

1. $11\text{dBm} + 10\log(41.67) = 27.20\text{ dBm} > 24\text{dBm}$.
2. $11\text{dBm} + 10\log(42.10) = 27.24\text{ dBm} > 24\text{dBm}$.
3. $11\text{dBm} + 10\log(41.53) = 27.18\text{ dBm} > 24\text{dBm}$.
4. $11\text{dBm} + 10\log(41.94) = 27.23\text{ dBm} > 24\text{dBm}$.
5. $11\text{dBm} + 10\log(41.55) = 27.19\text{ dBm} > 24\text{dBm}$.
6. $11\text{dBm} + 10\log(5725.00 - 5689.41) = 26.51\text{ dBm} > 24\text{dBm}$.

Chain 1

1. $11\text{dBm} + 10\log(41.78) = 27.21\text{ dBm} > 24\text{dBm}$.
2. $11\text{dBm} + 10\log(41.43) = 27.17\text{ dBm} > 24\text{dBm}$.
3. $11\text{dBm} + 10\log(41.52) = 27.18\text{ dBm} > 24\text{dBm}$.
4. $11\text{dBm} + 10\log(41.27) = 27.16\text{ dBm} > 24\text{dBm}$.
5. $11\text{dBm} + 10\log(41.56) = 27.19\text{ dBm} > 24\text{dBm}$.
6. $11\text{dBm} + 10\log(5725.00 - 5649.27) = 29.79\text{ dBm} > 24\text{dBm}$.

802.11ac (VHT80)

Chan.	Freq. (MHz)	Maximum Conducted Power (dBm)		Total Power (mW)	Total Power (dBm)	Power Limit (dBm)	Pass / Fail
		Chain 0	Chain 1				
42	5210	6.27	6.13	8.338	9.21	24.00	Pass
58	5290	6.10	6.20	8.243	9.16	24.00	Pass
106	5530	6.15	6.09	8.185	9.13	24.00	Pass
155	5775	5.91	6.04	7.917	8.99	30.00	Pass

Chan.	Freq. (MHz)	Maximum Conducted Power (dBm)		Duty factor	Maximum Conducted Power with Duty Factor (mW)	Maximum Conducted Power with Duty Factor (dBm)	Power Limit (dBm)	Pass / Fail
		Chain 0	Chain 1					
138	5690 For U-NII-2C	-4.11	-3.21	1.30	1.1667	0.67	24.00	Pass
138	5690 For U-NII-3	-15.97	-17.94	1.30	0.0558	-12.53	30.00	Pass

NOTE:
For U-NII-2A, U-NII-2C Band:
Chain 0

1. $11\text{dBm} + 10\log(82.63) = 30.17\text{ dBm} > 24\text{dBm}$.
2. $11\text{dBm} + 10\log(82.56) = 30.17\text{ dBm} > 24\text{dBm}$.
3. $11\text{dBm} + 10\log(5725.00 - 5648.72) = 29.82\text{ dBm} > 24\text{dBm}$.

Chain 1

1. $11\text{dBm} + 10\log(82.51) = 30.17\text{ dBm} > 24\text{dBm}$.
2. $11\text{dBm} + 10\log(81.84) = 30.13\text{ dBm} > 24\text{dBm}$.
3. $11\text{dBm} + 10\log(5725.00 - 5648.89) = 29.81\text{ dBm} > 24\text{dBm}$.



26dB BANDWIDTH:

802.11a

Chan.	Freq. (MHz)	26dBc Bandwidth (MHz)
36	5180	21.69
40	5200	21.94
48	5240	21.67
52	5260	21.85
60	5300	21.77
64	5320	21.90
100	5500	21.86
116	5580	21.64
140	5700	21.69
144	5720 For U-NII-2C	15.87

802.11ac (VHT20)

Chan.	Freq. (MHz)	26dBc Bandwidth (MHz)
36	5180	22.07
40	5200	21.95
48	5240	21.98
52	5260	22.08
60	5300	22.17
64	5320	22.10
100	5500	22.18
116	5580	22.02
140	5700	22.25
144	5720 For U-NII-2C	16.03

802.11ac (VHT40)

Chan.	Freq. (MHz)	26dBc Bandwidth (MHz)
38	5190	41.62
46	5230	41.58
54	5270	41.72
62	5310	41.58
102	5510	41.80
110	5550	41.67
134	5670	41.68
142	5710 For U-NII-2C	35.57

802.11ac (VHT80)

Chan.	Freq. (MHz)	26dBc Bandwidth (MHz)
42	5210	83.09
58	5290	83.18
106	5530	82.56
138	5690 For U-NII-2C	76.44

802.11ac (VHT20)

Chan.	Freq. (MHz)	26dBc Bandwidth (MHz)	
		Chain 0	Chain 1
36	5180	21.98	21.82
40	5200	22.05	21.75
48	5240	22.36	21.62
52	5260	22.18	21.81
60	5300	21.98	21.79
64	5320	21.99	21.82
100	5500	22.15	21.95
116	5580	22.96	21.81
140	5700	22.03	21.76
144	5720 For U-NII-2C	16.00	16.22

802.11ac (VHT40)

Chan.	Freq. (MHz)	26dBc Bandwidth (MHz)	
		Chain 0	Chain 1
38	5190	41.77	41.47
46	5230	41.79	41.51
54	5270	41.67	41.78
62	5310	42.10	41.43
102	5510	41.53	41.52
110	5550	41.94	41.27
134	5670	41.55	41.56
142	5710 For U-NII-2C	35.59	35.58

802.11ac (VHT80)

Chan.	Freq. (MHz)	26dBc Bandwidth (MHz)	
		Chain 0	Chain 1
42	5210	82.67	82.29
58	5290	82.63	82.51
106	5530	82.56	81.84
138	5690 For U-NII-2C	76.28	76.11



BUREAU
VERITAS

Spectrum Plot of Worst Value

802.11a

802.11ac (VHT20)_1TX

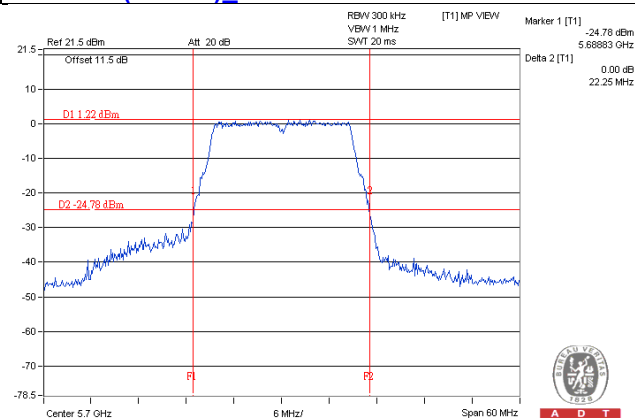
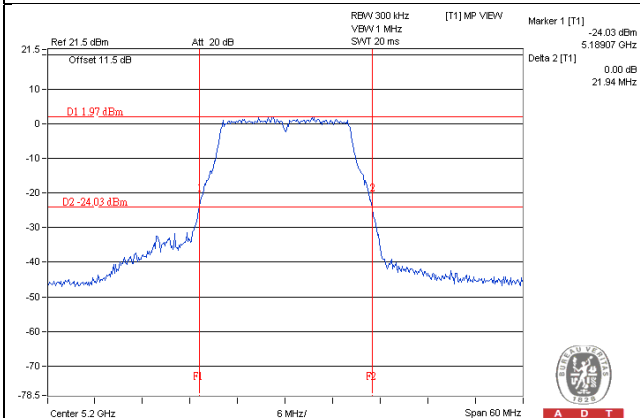

802.11ac (VHT40)_1TX

802.11ac (VHT80)_1TX

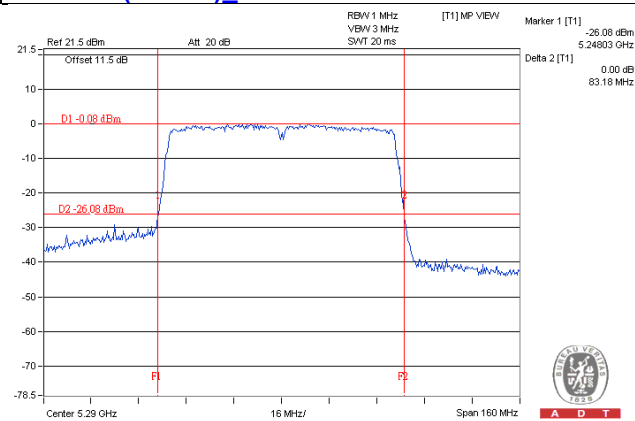
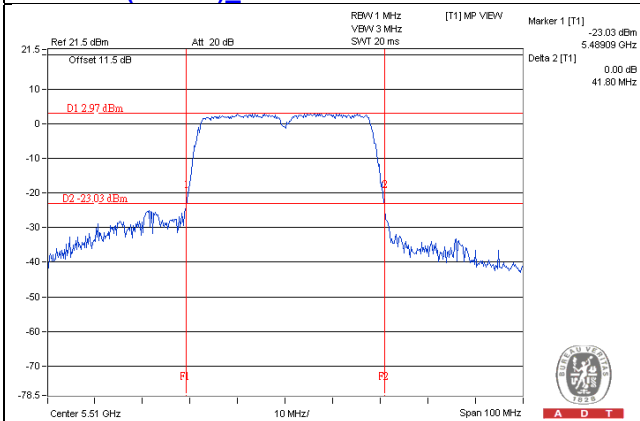



Spectrum Plot of Worst Value

802.11ac (VHT20)_2TX

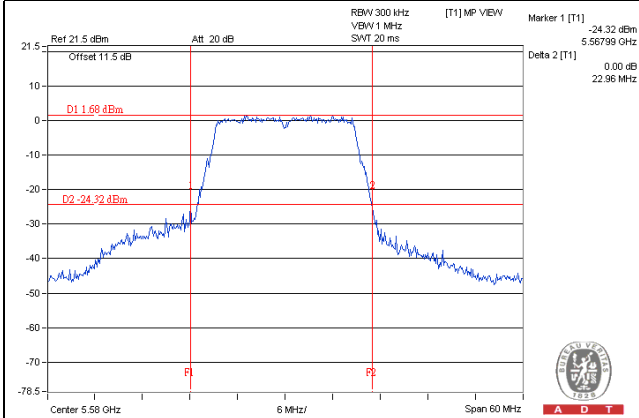

802.11ac (VHT40)_2TX

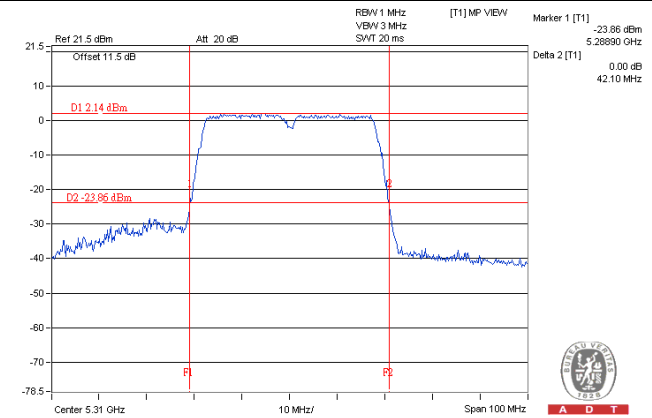

802.11ac (VHT80)_2TX

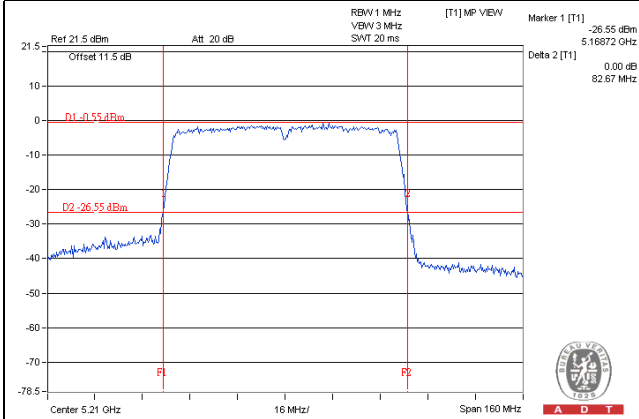

OCCUPIED BANDWIDTH:
802.11a

Chan.	Freq. (MHz)	Occupied Bandwidth (MHz)
36	5180	18.12
40	5200	17.16
48	5240	17.04
52	5260	16.92
60	5300	16.92
64	5320	17.04
100	5500	17.16
116	5580	16.92
140	5700	16.92
144	5720 For U-NII-2C	13.40
144	5720 For U-NII-3	3.16
149	5745	16.92
157	5785	17.04
165	5825	17.16

802.11ac (VHT20)

Chan.	Freq. (MHz)	Occupied Bandwidth (MHz)
36	5180	18.12
40	5200	18.00
48	5240	18.12
52	5260	18.12
60	5300	17.88
64	5320	18.00
100	5500	18.12
116	5580	18.12
140	5700	17.88
144	5720 For U-NII-2C	13.88
144	5720 For U-NII-3	3.88
149	5745	18.24
157	5785	18.12
165	5825	18.00

802.11ac (VHT40)

Chan.	Freq. (MHz)	Occupied Bandwidth (MHz)
38	5190	36.60
46	5230	36.72
54	5270	36.60
62	5310	36.60
102	5510	36.60
110	5550	36.60
134	5670	36.84
142	5710 For U-NII-2C	33.36
142	5710 For U-NII-3	3.36
151	5755	36.84
159	5795	36.72

802.11ac (VHT80)

Chan.	Freq. (MHz)	Occupied Bandwidth (MHz)
42	5210	75.88
58	5290	75.88
106	5530	75.88
138	5690 For U-NII-2C	72.92
138	5690 For U-NII-3	2.92
155	5775	75.88

802.11ac (VHT20)

Chan.	Freq. (MHz)	Occupied Bandwidth (MHz)	
		Chain 0	Chain 1
36	5180	18.12	18.00
40	5200	18.12	18.00
48	5240	17.88	18.12
52	5260	18.12	17.88
60	5300	17.88	18.00
64	5320	18.00	18.00
100	5500	18.12	18.12
116	5580	18.00	18.12
140	5700	18.12	18.12
144	5720 For U-NII-2C	14.00	14.00
144	5720 For U-NII-3	3.88	3.76
149	5745	18.17	18.00
157	5785	18.36	18.12
165	5825	18.24	18.00

802.11ac (VHT40)

Chan.	Freq. (MHz)	Occupied Bandwidth (MHz)	
		Chain 0	Chain 1
38	5190	36.72	36.84
46	5230	36.72	36.72
54	5270	36.60	36.72
62	5310	36.72	36.72
102	5510	36.60	36.72
110	5550	36.72	36.72
134	5670	36.84	36.60
142	5710 For U-NII-2C	33.36	33.36
142	5710 For U-NII-3	3.36	3.36
151	5755	36.84	36.72
159	5795	36.84	36.84

802.11ac (VHT80)

Chan.	Freq. (MHz)	Occupied Bandwidth (MHz)	
		Chain 0	Chain 1
42	5210	75.88	76.16
58	5290	75.88	76.16
106	5530	76.16	76.16
138	5690 For U-NII-2C	73.16	72.92
138	5690 For U-NII-3	2.92	2.92
155	5775	75.88	75.88



Spectrum Plot of Worst Value

802.11a

802.11ac (VHT20)_1TX

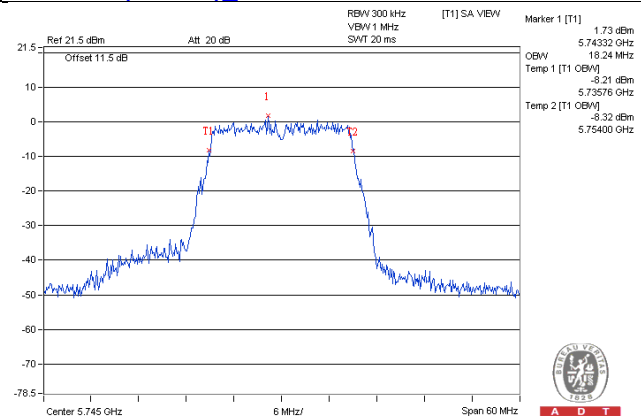
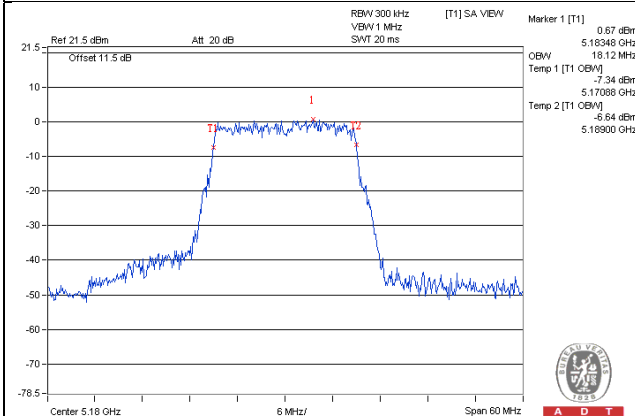

802.11ac (VHT40)_1TX

802.11ac (VHT80)_1TX

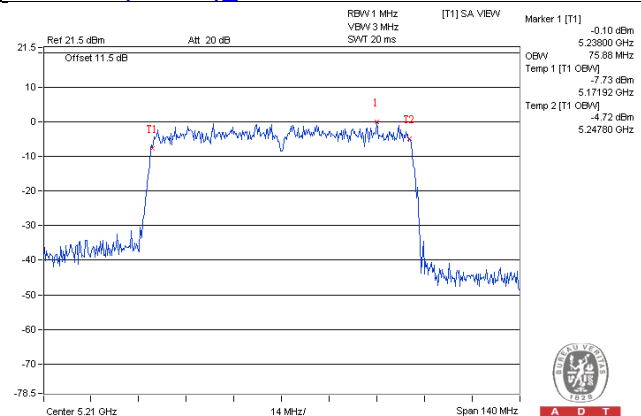
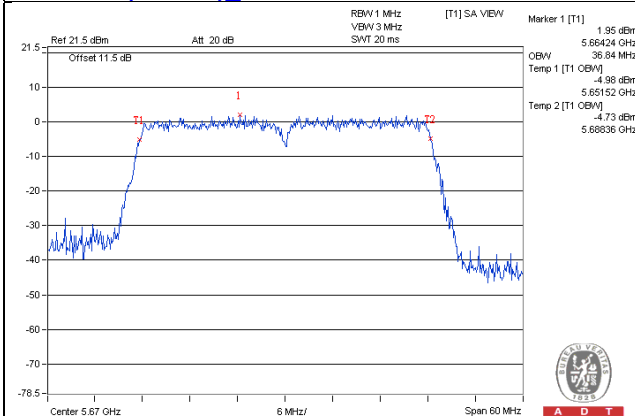



Spectrum Plot of Worst Value

802.11ac (VHT20)_2TX

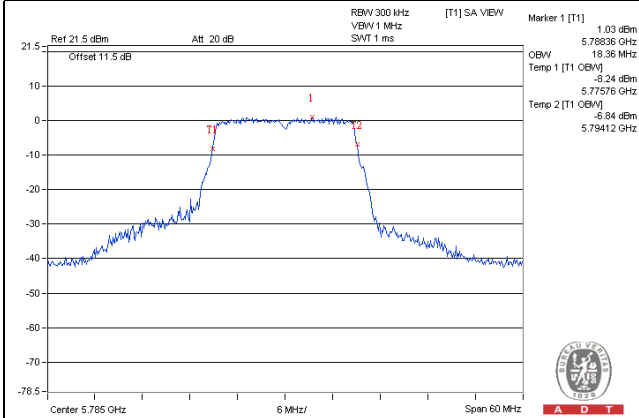

802.11ac (VHT40)_2TX

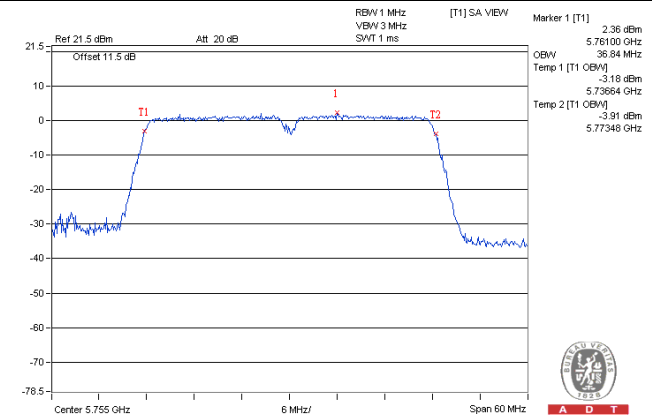

802.11ac (VHT80)_2TX

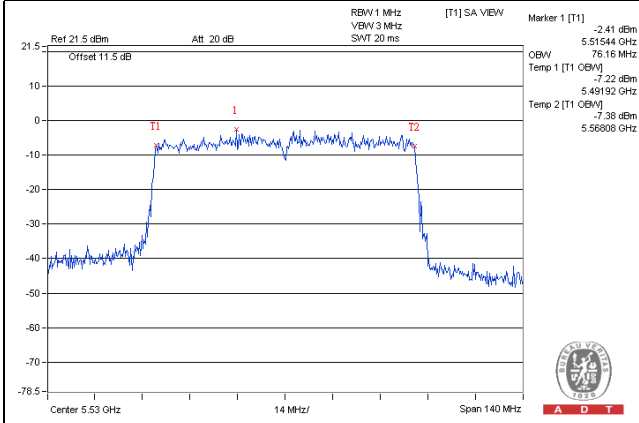

EUT MAXIMUM CONDUCTED POWER

802.11a

Frequency Band (MHz)	Max. Power	
	Output Power (mW)	Output Power (dBm)
5250~5350	8.551	9.32
5470~5725	9.162	9.62

NOTE: Manufacturer provides Transmit Power Control description to meet this requirement.

802.11ac (VHT20)_1TX

Frequency Band (MHz)	Max. Power	
	Output Power (mW)	Output Power (dBm)
5250~5350	8.690	9.39
5470~5725	9.594	9.82

NOTE: Manufacturer provides Transmit Power Control description to meet this requirement.

802.11ac (VHT40)_1TX

Frequency Band (MHz)	Max. Power	
	Output Power (mW)	Output Power (dBm)
5250~5350	6.471	8.11
5470~5725	6.501	8.13

NOTE: Manufacturer provides Transmit Power Control description to meet this requirement.

802.11ac (VHT80)_1TX

Frequency Band (MHz)	Max. Power	
	Output Power (mW)	Output Power (dBm)
5250~5350	6.792	8.32
5470~5725	7.228	8.59

NOTE: Manufacturer provides Transmit Power Control description to meet this requirement.

802.11ac (VHT20)_2TX

Frequency Band (MHz)	Max. Power	
	Output Power (mW)	Output Power (dBm)
5250~5350	16.381	12.14
5470~5725	19.703	12.95

NOTE: Manufacturer provides Transmit Power Control description to meet this requirement.

802.11ac (VHT40)_2TX

Frequency Band (MHz)	Max. Power	
	Output Power (mW)	Output Power (dBm)
5250~5350	15.646	11.94
5470~5725	18.219	12.61

NOTE: Manufacturer provides Transmit Power Control description to meet this requirement.

802.11ac (VHT80)_2TX

Frequency Band (MHz)	Max. Power	
	Output Power (mW)	Output Power (dBm)
5250~5350	8.243	9.16
5470~5725	8.185	9.13

NOTE: Manufacturer provides Transmit Power Control description to meet this requirement.

4.4 Peak Power Spectral Density Measurement

4.4.1 Limits of Peak Power Spectral Density Measurement

Operation Band	EUT Category		LIMIT
U-NII-1		Outdoor Access Point	17dBm/ MHz
		Fixed point-to-point Access Point	
		Indoor Access Point	
	√	Mobile and Portable client device	11dBm/ MHz
U-NII-2A		√	11dBm/ MHz
U-NII-2C		√	11dBm/ MHz
U-NII-3		√	30dBm/ 500kHz

4.4.2 Test Setup

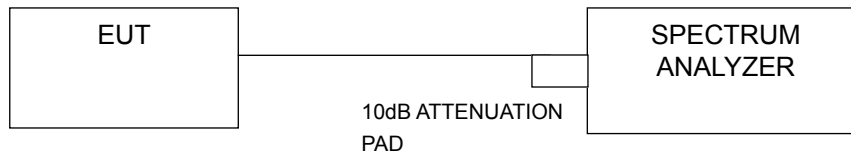

4.4.3 Test Instruments

Refer to section 4.1.2 to get information of above instrument.

4.4.4 Test Procedures

For U-NII-1, U-NII-2A, U-NII-2C band:

Without duty cycle (Using method SA-1):

- 1) Set span to encompass the entire emission bandwidth (EBW) of the signal.
- 2) Set RBW = 1MHz, Set VBW \geq 3MHz, Detector = RMS
- 3) Set Channel power measure = 1MHz
- 4) Sweep time = auto, trigger set to "free run".
- 5) Trace average at least 100 traces in power averaging mode.
- 6) Record the max value

With duty cycle (Using method SA-2):

- 1) Set span to encompass the entire emission bandwidth (EBW) of the signal.
- 2) Set RBW = 1MHz, Set VBW \geq 3MHz, Detector = RMS
- 3) Set Channel power measure = 1MHz
- 4) Sweep time = auto, trigger set to "free run".
- 5) Trace average at least 100 traces in power averaging mode.
- 6) Record the max value and add $10 \log (1/\text{duty cycle})$

For U-NII-3 band:

- 1) Set span to encompass the entire emission bandwidth (EBW) of the signal.
- 2) Set RBW = 300 kHz, Set VBW \geq 1 MHz, Detector = RMS
- 3) Use the peak marker function to determine the maximum power level in any 300 kHz band segment within the fundamental EBW.
- 4) Scale the observed power level to an equivalent value in 500 kHz by adjusting (reducing) the measured power by a bandwidth correction factor (BWCF) where $BWCF = 10\log(500\text{kHz}/300\text{kHz})$
- 5) Sweep time = auto, trigger set to "free run".
- 6) Trace average at least 100 traces in power averaging mode.
- 7) Record the max value and add $10 \log (1/\text{duty cycle})$

4.4.5 Deviation from Test Standard

No deviation.

4.4.6 EUT Operating Conditions

Same as Item 4.3.6.

4.4.7 Test Results

For U-NII-1, U-NII-2A, U-NII-2C Band

802.11a

Chan.	Freq. (MHz)	PSD w/o duty factor (dBm)	Duty factor	PSD with duty factor (dBm)	Max. Limit (dBm)	Pass / Fail
36	5180	-5.05	0.35	-4.70	11.00	Pass
40	5200	-3.25	0.35	-2.90	11.00	Pass
48	5240	-3.13	0.35	-2.78	11.00	Pass
52	5260	-3.50	0.35	-3.15	11.00	Pass
60	5300	-3.81	0.35	-3.46	11.00	Pass
64	5320	-3.97	0.35	-3.62	11.00	Pass
100	5500	-3.95	0.35	-3.60	11.00	Pass
116	5580	-3.93	0.35	-3.58	11.00	Pass
140	5700	-3.76	0.35	-3.41	11.00	Pass
144	5720 For U-NII-2C	-2.79	0.35	-2.44	11.00	Pass

NOTE: Refer to section 3.3 for duty cycle spectrum plot.

802.11ac (VHT20)

Chan.	Freq. (MHz)	PSD w/o duty factor (dBm)	Duty factor	PSD with duty factor (dBm)	Max. Limit (dBm)	Pass / Fail
36	5180	-3.47	0.38	-3.09	11.00	Pass
40	5200	-3.40	0.38	-3.02	11.00	Pass
48	5240	-3.37	0.38	-2.99	11.00	Pass
52	5260	-3.74	0.38	-3.36	11.00	Pass
60	5300	-4.26	0.38	-3.88	11.00	Pass
64	5320	-4.34	0.38	-3.96	11.00	Pass
100	5500	-4.31	0.38	-3.93	11.00	Pass
116	5580	-4.29	0.38	-3.91	11.00	Pass
140	5700	-4.31	0.38	-3.93	11.00	Pass
144	5720 For U-NII-2C	-3.60	0.38	-3.22	11.00	Pass

NOTE: Refer to section 3.3 for duty cycle spectrum plot.

802.11ac (VHT40)

Chan.	Freq. (MHz)	PSD w/o duty factor (dBm)	Duty factor	PSD with duty factor (dBm)	Max. Limit (dBm)	Pass / Fail
38	5190	-8.01	0.68	-7.33	11.00	Pass
46	5230	-7.97	0.68	-7.28	11.00	Pass
54	5270	-8.36	0.68	-7.68	11.00	Pass
62	5310	-8.90	0.68	-8.22	11.00	Pass
102	5510	-8.54	0.68	-7.85	11.00	Pass
110	5550	-8.57	0.68	-7.88	11.00	Pass
134	5670	-8.54	0.68	-7.85	11.00	Pass
142	5710 For U-NII-2C	-7.85	0.68	-7.16	11.00	Pass

NOTE: Refer to section 3.3 for duty cycle spectrum plot.

802.11ac (VHT80)

Chan.	Freq. (MHz)	PSD w/o duty factor (dBm)	Duty factor	PSD with duty factor (dBm)	Max. Limit (dBm)	Pass / Fail
42	5210	-11.49	1.32	-10.17	11.00	Pass
58	5290	-11.91	1.32	-10.60	11.00	Pass
106	5530	-11.93	1.32	-10.62	11.00	Pass
138	5690 For U-NII-2C	-11.83	1.32	-10.52	11.00	Pass

NOTE: Refer to section 3.3 for duty cycle spectrum plot.



802.11ac (VHT20)

Chan.	Freq. (MHz)	PSD (dBm)		Total PSD w/o duty factor (dBm)	Duty factor	Total PSD with duty factor (dBm)	Max. Limit (dBm)	Pass / Fail
		Chain 0	Chain 1					
36	5180	-3.59	-4.08	-0.82	0.39	-0.43	11	Pass
40	5200	-3.34	-3.75	-0.53	0.39	-0.14	11	Pass
48	5240	-3.39	-3.85	-0.60	0.39	-0.21	11	Pass
52	5260	-3.59	-4.12	-0.84	0.39	-0.45	11	Pass
60	5300	-4.19	-4.44	-1.30	0.39	-0.91	11	Pass
64	5320	-4.20	-4.55	-1.36	0.39	-0.97	11	Pass
100	5500	-4.03	-5.07	-1.51	0.39	-1.12	11	Pass
116	5580	-3.91	-4.98	-1.40	0.39	-1.01	11	Pass
140	5700	-3.87	-4.47	-1.15	0.39	-0.76	11	Pass
144	5720 For U-NII-2C	-4.15	-4.36	-1.24	0.39	-0.85	11	Pass

Note:

1. Method 1 of power density measurement of KDB 662911 is using for calculating total power density. Total power density is summing entire spectra across corresponding frequency bins on the various outputs by computer.
2. Directional gain = $2.93\text{dBi} + 10\log(2) = 5.94\text{dBi} < 6\text{dBi}$, so the power density limit no need to reduced.
3. Refer to section 3.3 for duty cycle spectrum plot.



802.11ac (VHT40)

Chan.	Freq. (MHz)	PSD (dBm)		Total PSD w/o duty factor (dBm)	Duty factor	Total PSD with duty factor (dBm)	Max. Limit (dBm)	Pass / Fail
		Chain 0	Chain 1					
38	5190	-9.18	-9.38	-6.27	0.77	-5.50	11	Pass
46	5230	-8.92	-9.07	-5.99	0.77	-5.22	11	Pass
54	5270	-9.52	-9.40	-6.45	0.77	-5.68	11	Pass
62	5310	-9.62	-9.93	-6.77	0.77	-6.00	11	Pass
102	5510	-9.63	-10.10	-6.85	0.77	-6.08	11	Pass
110	5550	-9.30	-10.04	-6.65	0.77	-5.88	11	Pass
134	5670	-9.80	-9.85	-6.82	0.77	-6.05	11	Pass
142	5710 For U-NII-2C	-9.62	-9.03	-6.31	0.77	-5.54	11	Pass

Note:

1. Method 1 of power density measurement of KDB 662911 is using for calculating total power density. Total power density is summing entire spectra across corresponding frequency bins on the various outputs by computer.
2. Directional gain = $2.93\text{dBi} + 10\log(2) = 5.94\text{dBi} < 6\text{dBi}$, so the power density limit no need to reduced.
3. Refer to section 3.3 for duty cycle spectrum plot.

802.11ac (VHT80)

Chan.	Freq. (MHz)	PSD (dBm)		Total PSD w/o duty factor (dBm)	Duty factor	Total PSD with duty factor (dBm)	Max. Limit (dBm)	Pass / Fail
		Chain 0	Chain 1					
42	5210	-13.40	-13.38	-10.38	1.30	-9.08	11	Pass
58	5290	-13.71	-14.16	-10.92	1.30	-9.62	11	Pass
106	5530	-14.14	-14.61	-11.37	1.30	-10.07	11	Pass
138	5690 For U-NII-2C	-14.04	-13.28	-10.64	1.30	-9.34	11	Pass

Note:

1. Method 1 of power density measurement of KDB 662911 is using for calculating total power density. Total power density is summing entire spectra across corresponding frequency bins on the various outputs by computer.
2. Directional gain = $2.93\text{dBi} + 10\log(2) = 5.94\text{dBi} < 6\text{dBi}$, so the power density limit no need to reduced.
3. Refer to section 3.3 for duty cycle spectrum plot.



Spectrum Plot of Worst Value

802.11a

802.11ac (VHT20)_1TX

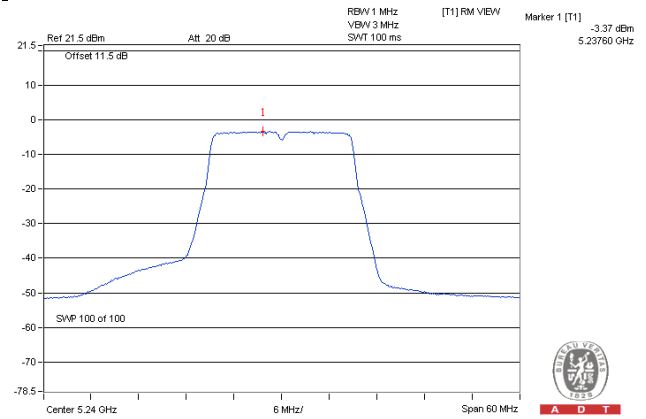
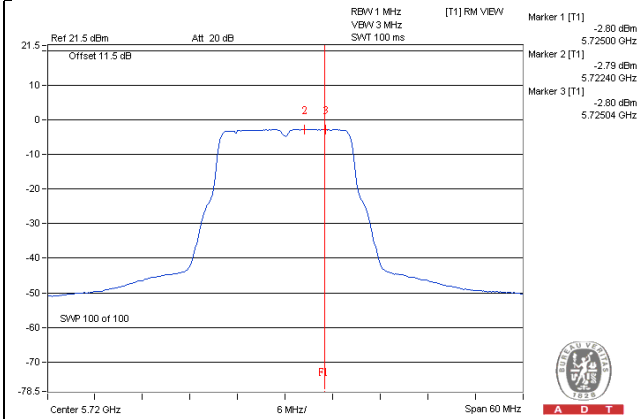

802.11ac (VHT40)_1TX

802.11ac (VHT80)_1TX

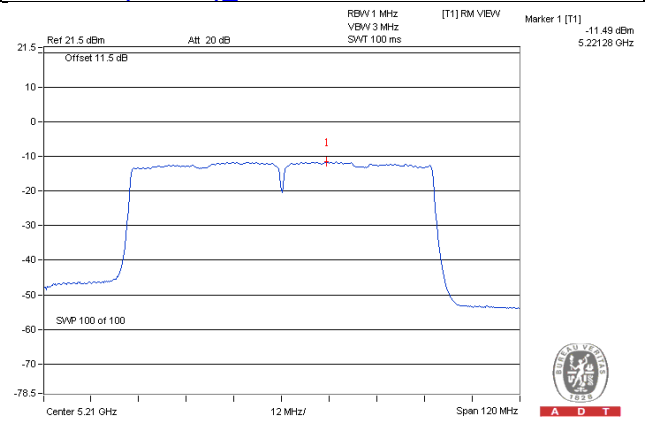
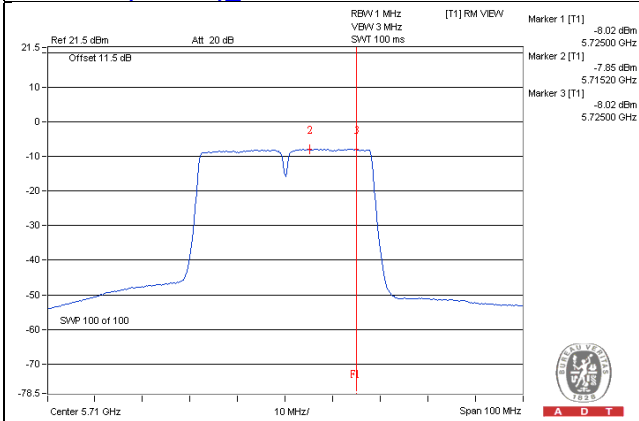



BUREAU
VERITAS

Spectrum Plot of Worst Value

802.11ac (VHT20)_2TX / Chain 0 / Ch 40

802.11ac (VHT40)_2TX / Chain 0 / Ch 46

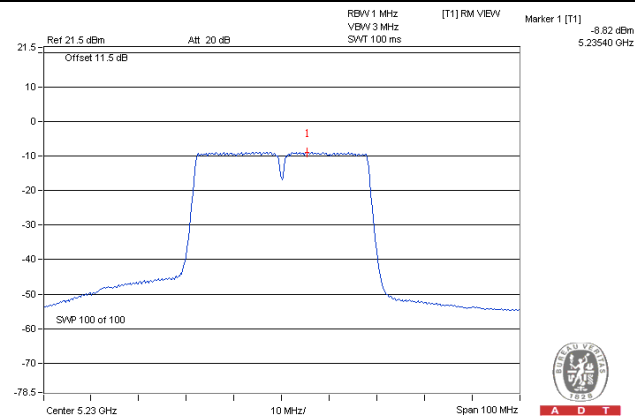
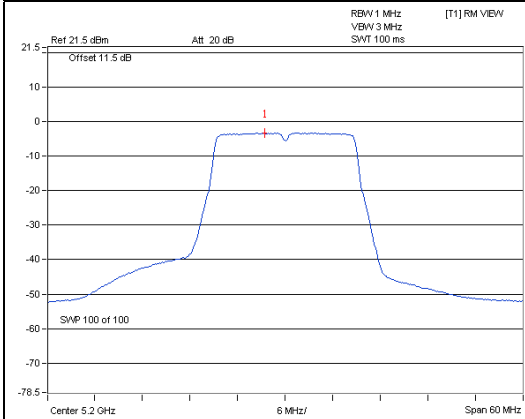

802.11ac (VHT80)_2TX / Chain 1 / Ch 138

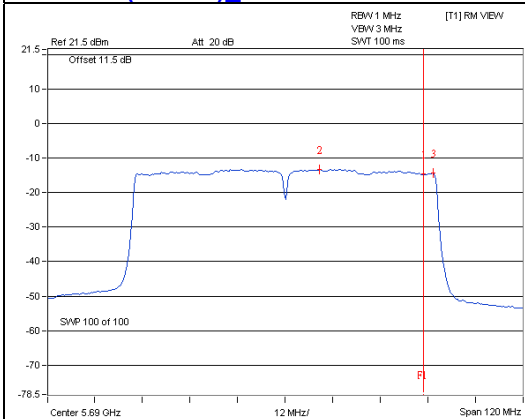

For U-NII-3 Band

802.11a

Chan.	Freq. (MHz)	PSD (dBm/300k Hz)	PSD (dBm/500k Hz)	Duty factor	Total PSD (dBm/500k Hz)	Limit (dBm/500k Hz)	Pass / Fail
144	5720 For U-NII-3	-11.13	-8.91	0.35	-8.56	30.00	Pass
149	5745	-11.39	-9.17	0.35	-8.82	30.00	Pass
157	5785	-11.43	-9.21	0.35	-8.86	30.00	Pass
165	5825	-11.42	-9.20	0.35	-8.85	30.00	Pass

NOTE: Refer to section 3.3 for duty cycle spectrum plot.

802.11ac (VHT20)

Chan.	Freq. (MHz)	PSD (dBm/300k Hz)	PSD (dBm/500k Hz)	Duty factor	Total PSD (dBm/500k Hz)	Limit (dBm/500k Hz)	Pass / Fail
144	5720 For U-NII-3	-12.11	-9.89	0.38	-9.51	30.00	Pass
149	5745	-11.66	-9.44	0.38	-9.06	30.00	Pass
157	5785	-11.82	-9.60	0.38	-9.22	30.00	Pass
165	5825	-12.28	-10.06	0.38	-9.68	30.00	Pass

NOTE: Refer to section 3.3 for duty cycle spectrum plot.

802.11ac (VHT40)

Chan.	Freq. (MHz)	PSD (dBm/300k Hz)	PSD (dBm/500k Hz)	Duty factor	Total PSD (dBm/500k Hz)	Limit (dBm/500k Hz)	Pass / Fail
142	5710 For U-NII-3	-16.57	-14.35	0.68	-13.67	30.00	Pass
151	5755	-16.33	-14.11	0.68	-13.43	30.00	Pass
159	5795	-16.63	-14.41	0.68	-13.73	30.00	Pass

NOTE: Refer to section 3.3 for duty cycle spectrum plot.

802.11ac (VHT80)

Chan.	Freq. (MHz)	PSD (dBm/300k Hz)	PSD (dBm/500k Hz)	Duty factor	Total PSD (dBm/500k Hz)	Limit (dBm/500k Hz)	Pass / Fail
138	5690 For U-NII-3	-21.63	-19.41	1.32	-18.09	30.00	Pass
155	5775	-20.28	-18.06	1.32	-16.74	30.00	Pass

NOTE: Refer to section 3.3 for duty cycle spectrum plot.

802.11ac (VHT20)

TX chain	Chan.	Freq. (MHz)	PSD (dBm/300 kHz)	PSD (dBm/500 kHz)	10 log (N=2) dB	Duty factor	Total PSD (dBm/500 kHz)	Limit (dBm/500 kHz)	Pass / Fail
0	144	5720 For U-NII-3	-12.62	-10.40	3.01	0.39	-7.00	30.00	Pass
	149	5745	-11.72	-9.50	3.01	0.39	-6.10	30.00	Pass
	157	5785	-11.60	-9.38	3.01	0.39	-5.98	30.00	Pass
	165	5825	-11.50	-9.28	3.01	0.39	-5.88	30.00	Pass
1	144	5720 For U-NII-3	-12.58	-10.36	3.01	0.39	-6.96	30.00	Pass
	149	5745	-12.22	-10.00	3.01	0.39	-6.60	30.00	Pass
	157	5785	-12.24	-10.02	3.01	0.39	-6.62	30.00	Pass
	165	5825	-12.18	-9.96	3.01	0.39	-6.56	30.00	Pass

Note:

1. Method 1 of power density measurement of KDB 662911 is using for calculating total power density. Total power density is summing entire spectra across corresponding frequency bins on the various outputs by computer.
2. Directional gain = 2.93dBi + 10log(2) = 5.94dBi < 6dBi, so the power density limit no need to reduced.
3. Refer to section 3.3 for duty cycle spectrum plot.

802.11ac (VHT40)

TX chain	Chan.	Freq. (MHz)	PSD (dBm/300 kHz)	PSD (dBm/500 kHz)	10 log (N=2) dB	Duty factor	Total PSD (dBm/500 kHz)	Limit (dBm/500 kHz)	Pass / Fail
0	142	5710 For U-NII-3	-18.28	-16.06	3.01	0.77	-12.28	30.00	Pass
	151	5755	-17.29	-15.07	3.01	0.77	-11.29	30.00	Pass
	159	5795	-17.39	-15.17	3.01	0.77	-11.39	30.00	Pass
1	142	5710 For U-NII-3	-17.74	-15.52	3.01	0.77	-11.74	30.00	Pass
	151	5755	-17.56	-15.34	3.01	0.77	-11.56	30.00	Pass
	159	5795	-17.57	-15.35	3.01	0.77	-11.57	30.00	Pass

Note:

1. Method 1 of power density measurement of KDB 662911 is using for calculating total power density. Total power density is summing entire spectra across corresponding frequency bins on the various outputs by computer.
2. Directional gain = 2.93dBi + 10log(2) = 5.94dBi < 6dBi, so the power density limit no need to reduced.
3. Refer to section 3.3 for duty cycle spectrum plot.

802.11ac (VHT80)

TX chain	Chan.	Freq. (MHz)	PSD (dBm/300 kHz)	PSD (dBm/500 kHz)	10 log (N=2) dB	Duty factor	Total PSD (dBm/500 kHz)	Limit (dBm/500 kHz)	Pass / Fail
0	138	5690 For U-NII-3	-23.83	-21.61	3.01	1.30	-17.30	28.09	Pass
	155	5775	-21.72	-19.50	3.01	1.30	-15.19	28.09	Pass
1	138	5690 For U-NII-3	-23.09	-20.87	3.01	1.30	-16.56	28.09	Pass
	155	5775	-22.01	-19.79	3.01	1.30	-15.48	28.09	Pass

Note:

1. Method 1 of power density measurement of KDB 662911 is using for calculating total power density. Total power density is summing entire spectra across corresponding frequency bins on the various outputs by computer.
2. Directional gain = $2.93\text{dBi} + 10\log(2) = 5.94\text{dBi} < 6\text{dBi}$, so the power density limit no need to reduced.
3. Refer to section 3.3 for duty cycle spectrum plot.



Spectrum Plot of Worst Value

802.11a

802.11ac (VHT20)_1TX

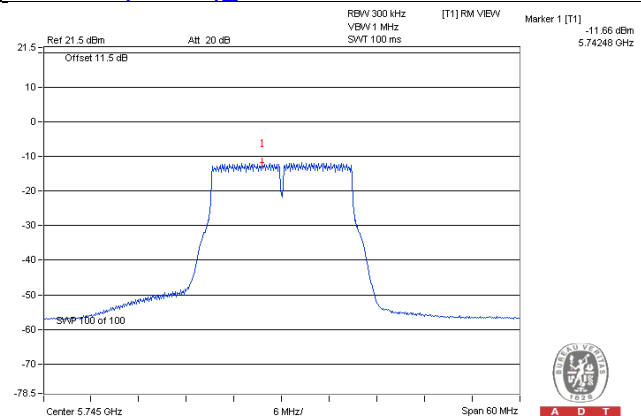
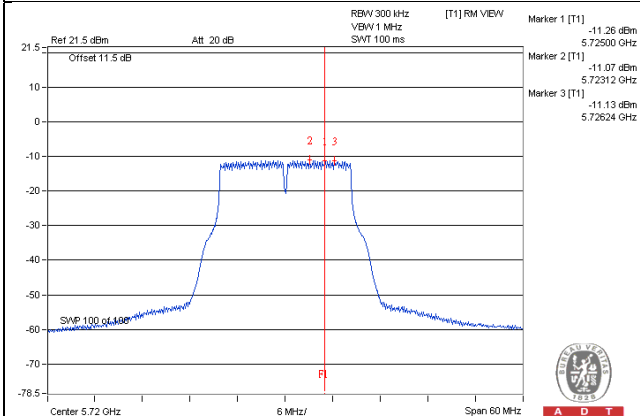

802.11ac (VHT40)_1TX

802.11ac (VHT80)_1TX

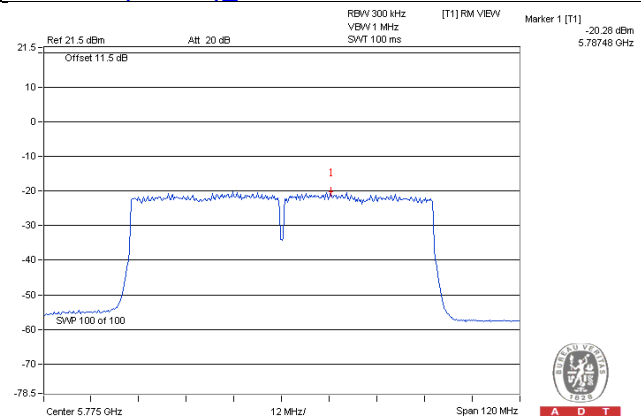
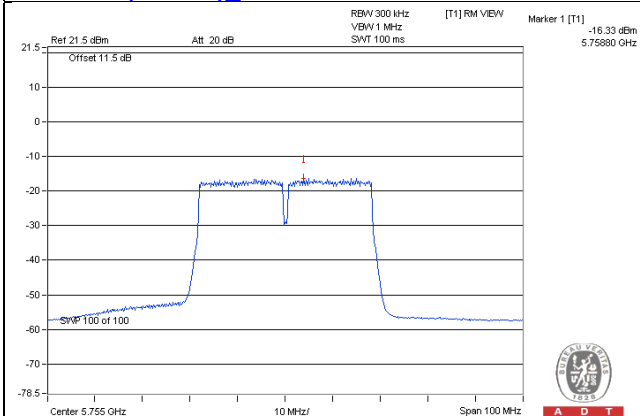

Spectrum Plot of Worst Value

802.11ac (VHT20)_2TX

802.11ac (VHT40)_2TX

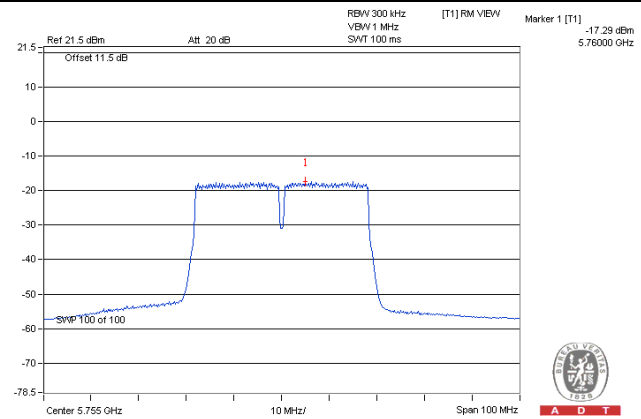
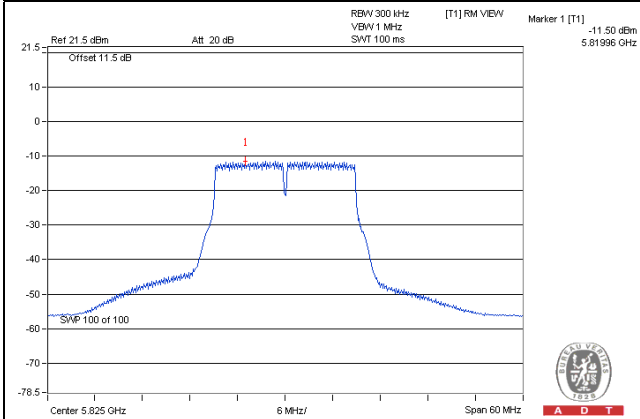

802.11ac (VHT80)_2TX

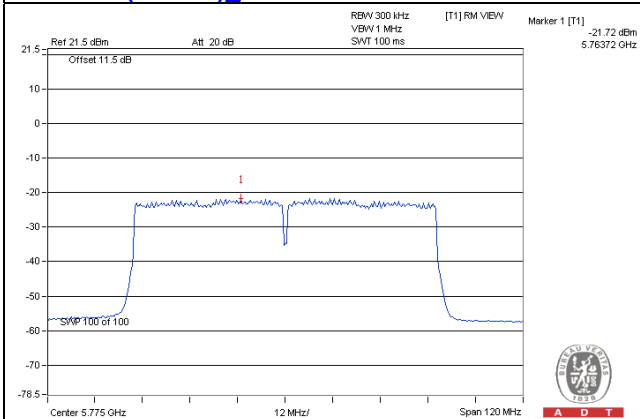

4.5 Frequency Stability

4.5.1 Limits of Frequency Stability Measurement

The frequency of the carrier signal shall be maintained within band of operation

4.5.2 Test Setup

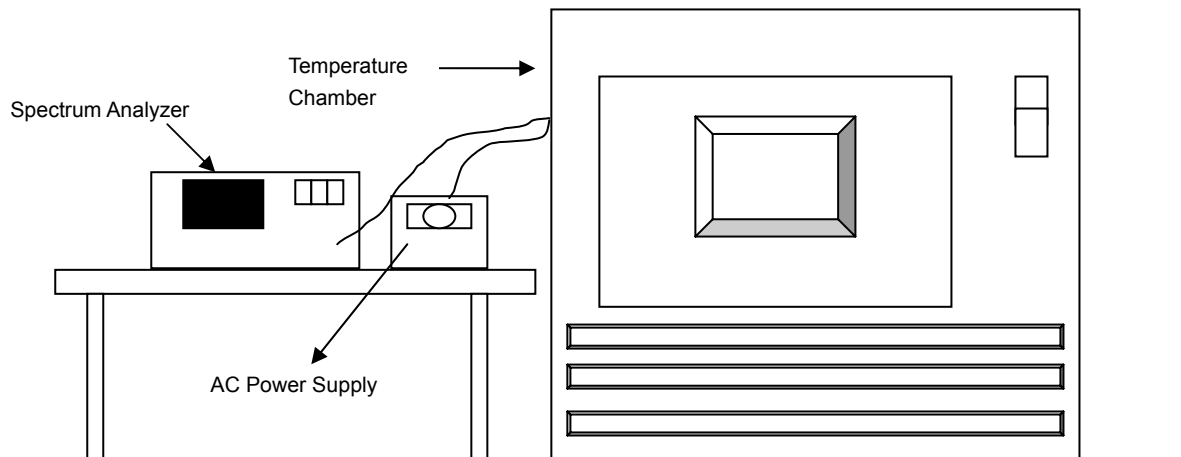

4.5.3 Test Instruments

Refer to section 4.1.2 to get information of above instrument.

4.5.4 Test Procedure

- The EUT was placed inside the environmental test chamber and powered by nominal AC voltage.
- Turn the EUT on and couple its output to a spectrum analyzer.
- Turn the EUT off and set the chamber to the highest temperature specified.
- Allow sufficient time (approximately 30 min) for the temperature of the chamber to stabilize, turn the EUT on and measure the operating frequency after 2, 5, and 10 minutes.
- Repeat step 2 and 3 with the temperature chamber set to the lowest temperature.
- The test chamber was allowed to stabilize at +20 degree C for a minimum of 30 minutes. The supply voltage was then adjusted on the EUT from 85% to 115% and the frequency record.

4.5.5 Deviation from Test Standard

No deviation.

4.5.6 EUT Operating Condition

Set the EUT transmit at un-modulation mode to test frequency stability.

4.5.7 Test Results

Frequency Stability Versus Temp.									
Operating Frequency: 5240MHz									
Temp. (°C)	Power Supply (Vac)	0 Minute		2 Minute		5 Minute		10 Minute	
		Measured Frequency (MHz)	Frequency Drift (%)	Measured Frequency (MHz)	Frequency Drift (%)	Measured Frequency (MHz)	Frequency Drift (%)	Measured Frequency (MHz)	Frequency Drift (%)
50	120	5239.9852	-0.00028	5239.9838	-0.00031	5239.9828	-0.00033	5239.9846	-0.00029
40	120	5239.9999	0.00000	5239.9953	-0.00009	5239.9982	-0.00003	5239.9959	-0.00008
30	120	5239.9814	-0.00035	5239.9820	-0.00034	5239.9823	-0.00034	5239.9813	-0.00036
20	120	5240.0134	0.00026	5240.0143	0.00027	5240.0172	0.00033	5240.0150	0.00029
10	120	5240.0099	0.00019	5240.0080	0.00015	5240.0112	0.00021	5240.0074	0.00014
0	120	5240.0220	0.00042	5240.0254	0.00048	5240.0219	0.00042	5240.0220	0.00042
-10	120	5239.9882	-0.00023	5239.9898	-0.00019	5239.9893	-0.00020	5239.9896	-0.00020
-20	120	5240.0241	0.00046	5240.0250	0.00048	5240.0209	0.00040	5240.0239	0.00046
-30	120	5239.9826	-0.00033	5239.9838	-0.00031	5239.9828	-0.00033	5239.9817	-0.00035

Frequency Stability Versus Voltage									
Operating Frequency: 5240MHz									
Temp. (°C)	Power Supply (Vac)	0 Minute		2 Minute		5 Minute		10 Minute	
		Measured Frequency (MHz)	Frequency Drift (%)	Measured Frequency (MHz)	Frequency Drift (%)	Measured Frequency (MHz)	Frequency Drift (%)	Measured Frequency (MHz)	Frequency Drift (%)
20	138	5240.0134	0.00026	5240.0141	0.00027	5240.0170	0.00032	5240.0153	0.00029
	120	5240.0134	0.00026	5240.0143	0.00027	5240.0172	0.00033	5240.0150	0.00029
	102	5240.0143	0.00027	5240.0135	0.00026	5240.0177	0.00034	5240.0155	0.00030

4.6 6dB Bandwidth Measurement

4.6.1 Limits of 6dB Bandwidth Measurement

The minimum of 6dB Bandwidth Measurement is 0.5MHz.

4.6.2 Test Setup

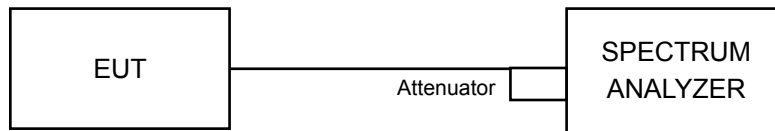

4.6.3 Test Instruments

Refer to section 4.1.2 to get information of above instrument.

4.6.4 Test Procedure

MEASUREMENT PROCEDURE REF

- Set resolution bandwidth (RBW) = 100kHz
- Set the video bandwidth (VBW) $\geq 3 \times$ RBW, Detector = Peak.
- Trace mode = max hold.
- Sweep = auto couple.
- Measure the maximum width of the emission that is constrained by the frequencies associated with the two amplitude points (upper and lower) that are attenuated by 6 dB relative to the maximum level measured in the fundamental emission

4.6.5 Deviation from Test Standard

No deviation.

4.6.6 EUT Operating Condition

The software provided by client to enable the EUT under transmission condition continuously at lowest, middle and highest channel frequencies individually.

4.6.7 Test Results

802.11a

Channel	Frequency (MHz)	6dB Bandwidth (MHz)	Minimum Limit (MHz)	Pass / Fail
144	5720 For U-NII-3	3.22	0.5	Pass
149	5745	16.44	0.5	Pass
157	5785	16.41	0.5	Pass
165	5825	16.45	0.5	Pass

802.11ac (VHT20)_1TX

Channel	Frequency (MHz)	6dB Bandwidth (MHz)	Minimum Limit (MHz)	Pass / Fail
144	5720 For U-NII-3	3.84	0.5	Pass
149	5745	17.66	0.5	Pass
157	5785	17.67	0.5	Pass
165	5825	17.65	0.5	Pass

802.11ac (VHT40)_1TX

Channel	Frequency (MHz)	6dB Bandwidth (MHz)	Minimum Limit (MHz)	Pass / Fail
142	5710 For U-NII-3	3.25	0.5	Pass
151	5755	36.45	0.5	Pass
159	5795	36.48	0.5	Pass

802.11ac (VHT80)_1TX

Channel	Frequency (MHz)	6dB Bandwidth (MHz)	Minimum Limit (MHz)	Pass / Fail
138	5690 For U-NII-3	3.23	0.5	Pass
155	5775	76.12	0.5	Pass



802.11ac (VHT20)_2TX

Channel	Frequency (MHz)	6dB Bandwidth (MHz)		Minimum Limit (MHz)	Pass / Fail
		Chain 0	Chain 1		
144	5720 For U-NII-3	3.83	3.83	0.5	Pass
149	5745	17.64	17.66	0.5	Pass
157	5785	17.69	17.70	0.5	Pass
165	5825	17.67	17.68	0.5	Pass

802.11ac (VHT40)_2TX

Channel	Frequency (MHz)	6dB Bandwidth (MHz)		Minimum Limit (MHz)	Pass / Fail
		Chain 0	Chain 1		
142	5710 For U-NII-3	3.25	3.24	0.5	Pass
151	5755	36.46	36.50	0.5	Pass
159	5795	36.47	36.50	0.5	Pass

802.11ac (VHT80)_2TX

Channel	Frequency (MHz)	6dB Bandwidth (MHz)		Minimum Limit (MHz)	Pass / Fail
		Chain 0	Chain 1		
138	5690 For U-NII-3	3.21	3.26	0.5	Pass
155	5775	76.33	76.43	0.5	Pass



Spectrum Plot of Worst Value

802.11a

802.11ac (VHT20)_1TX

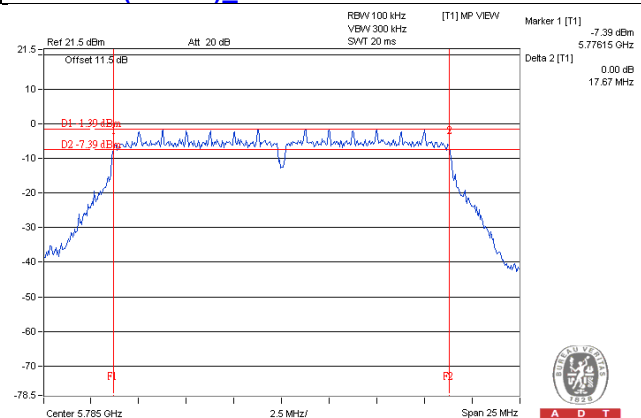
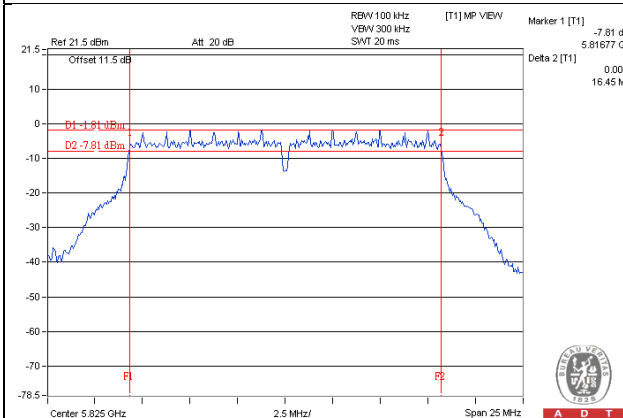

802.11ac (VHT40)_1TX

802.11ac (VHT80)_1TX

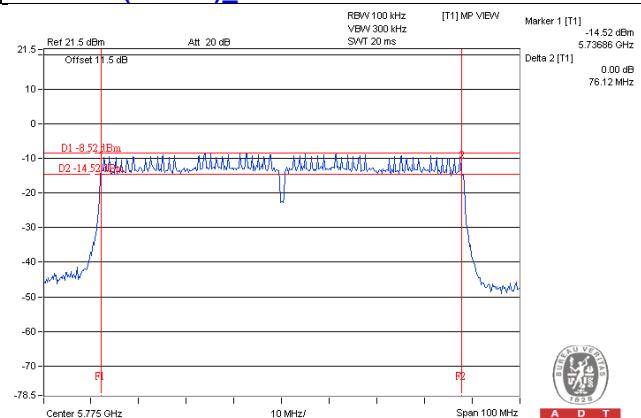
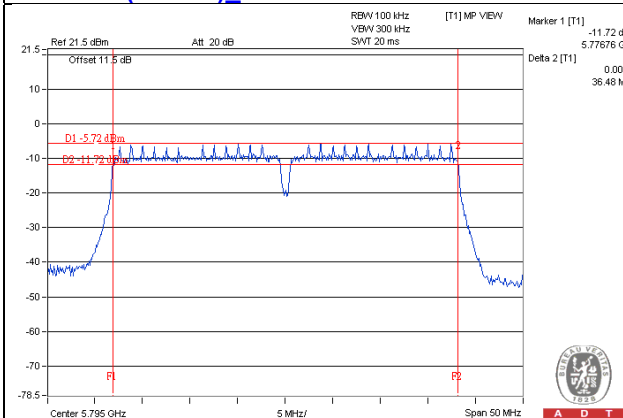



BUREAU
VERITAS

Spectrum Plot of Worst Value

802.11ac (VHT20)_2TX

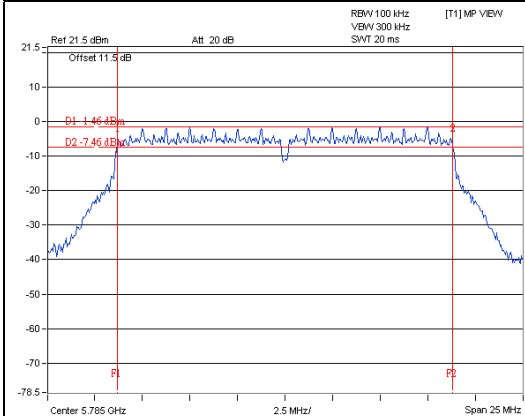

802.11ac (VHT40)_2TX

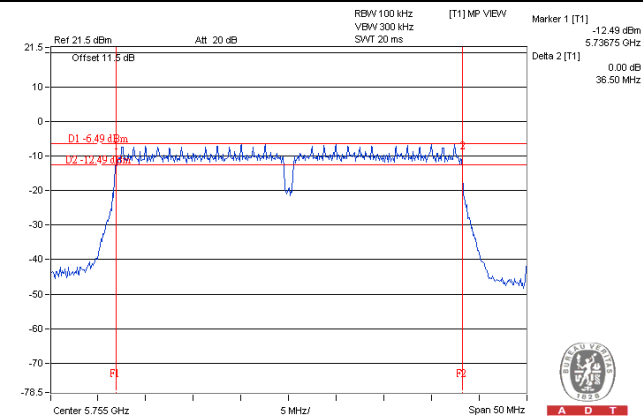

802.11ac (VHT80)_2TX

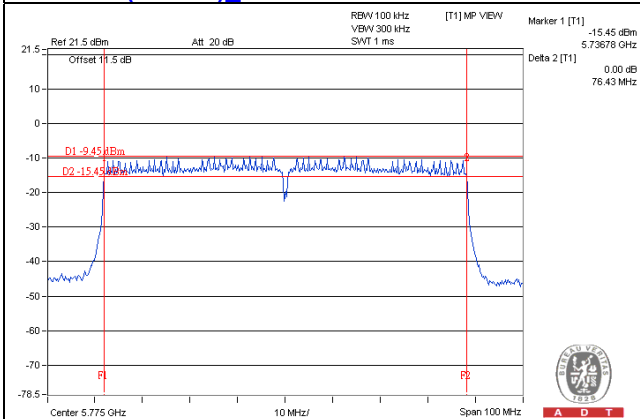

5 Pictures of Test Arrangements

Please refer to the attached file (Test Setup Photo).

Annex A- Radiated Out of Band Emission (OOBE) Measurement (For U-NII-3 band)

802.11a

CH149

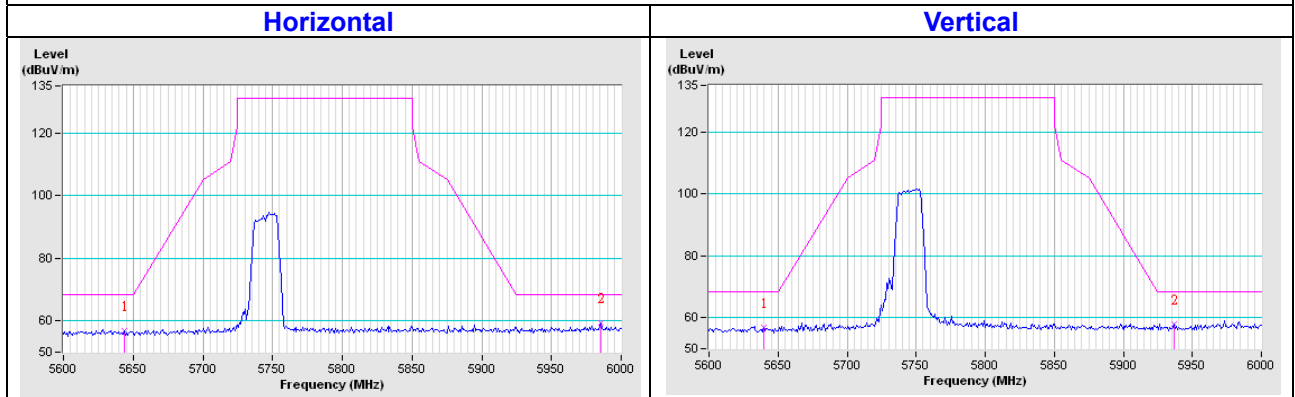

CH157

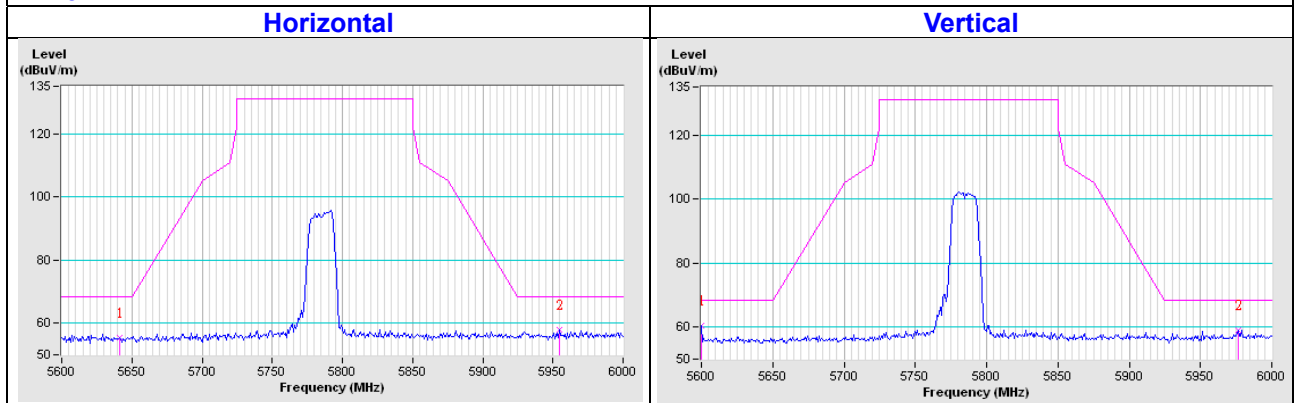

CH165

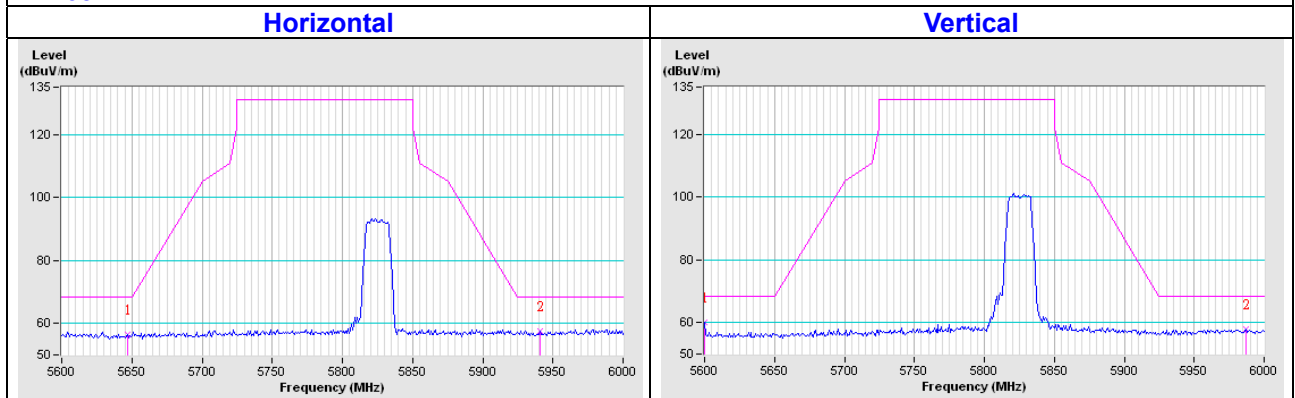

802.11ac (VHT20)_1TX

CH149

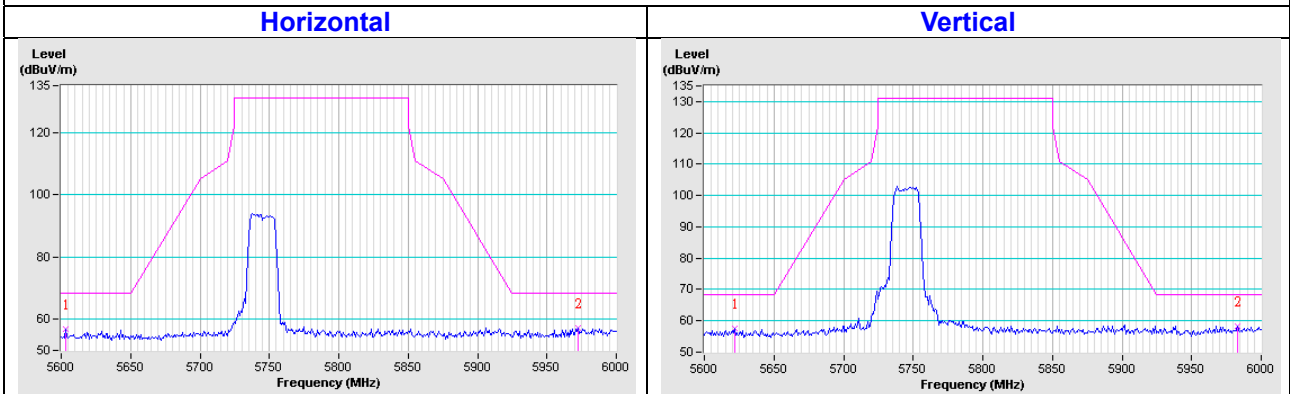

CH157

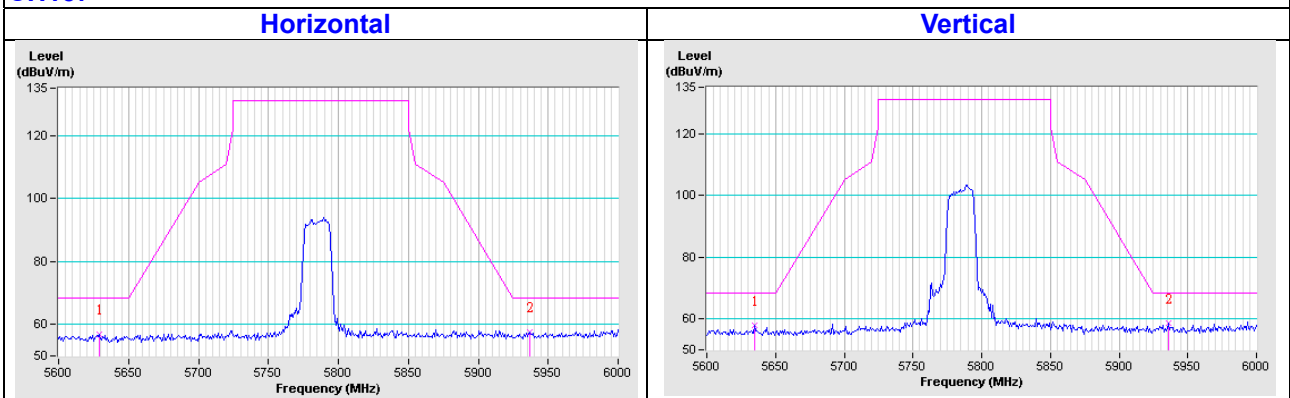

CH165

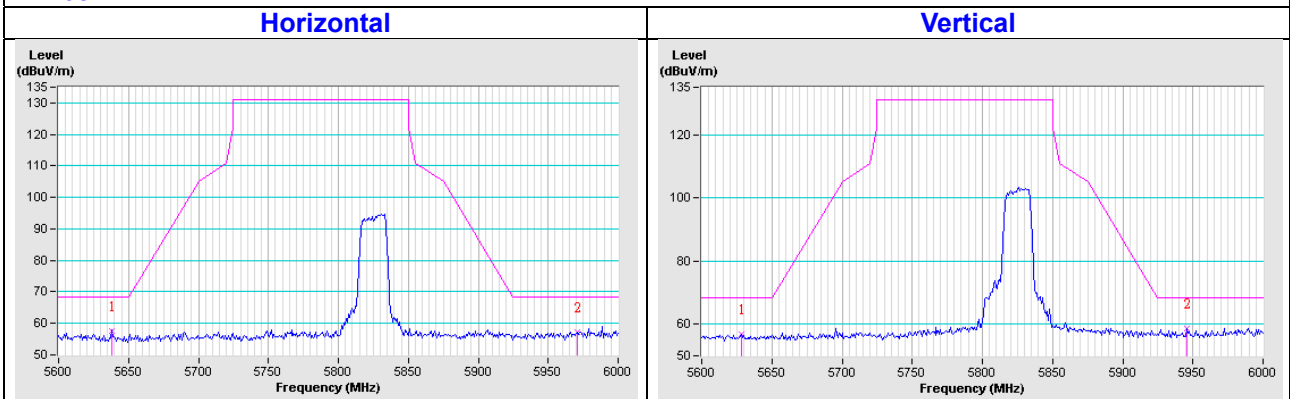

802.11ac (VHT40)_1TX

CH151

Horizontal

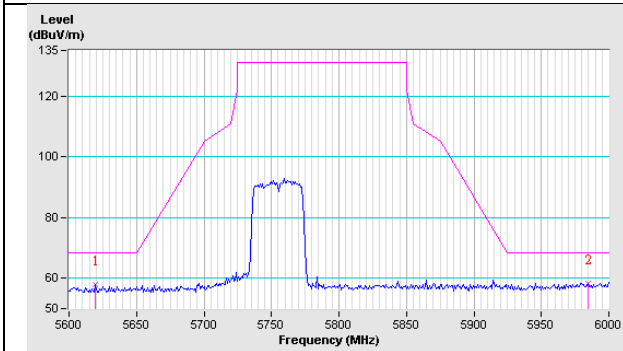

Vertical

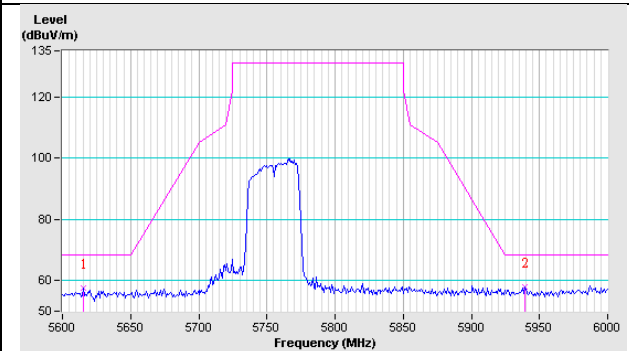

CH159

Horizontal

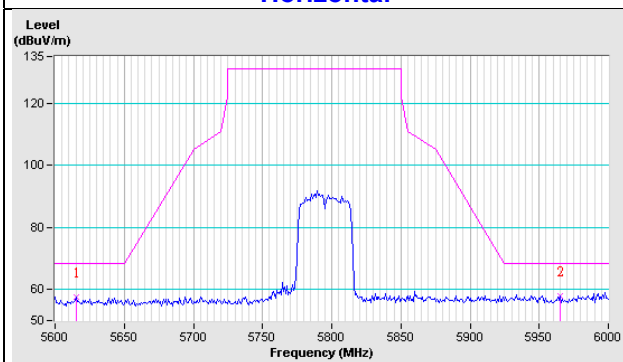

Vertical

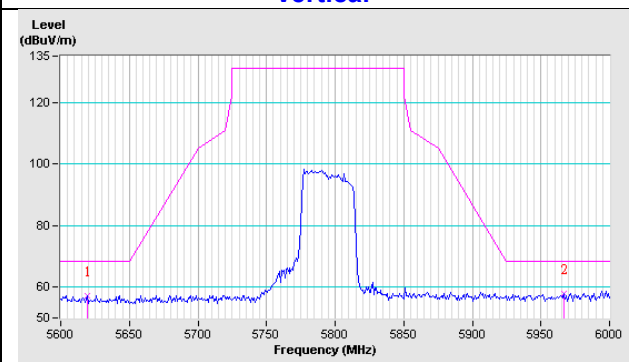

802.11ac (VHT80)_1TX

CH155

Horizontal

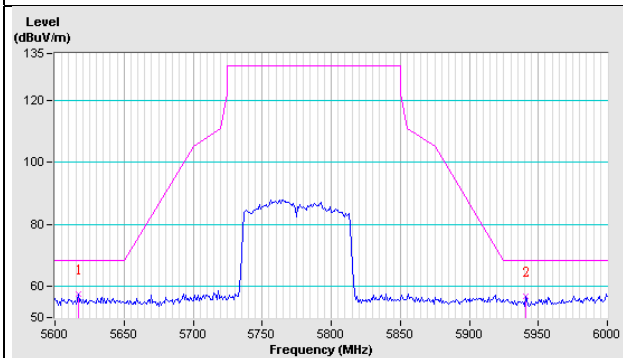

Vertical

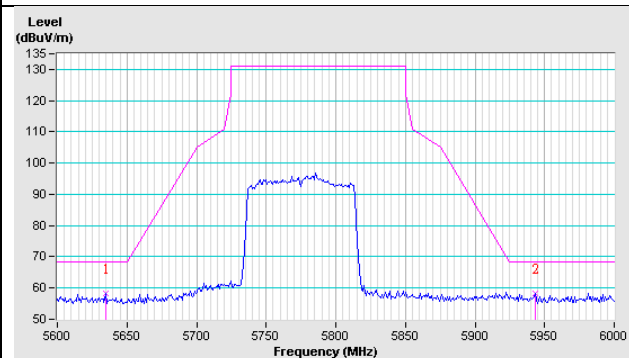



802.11ac (VHT20)_2TX

CH149

Horizontal

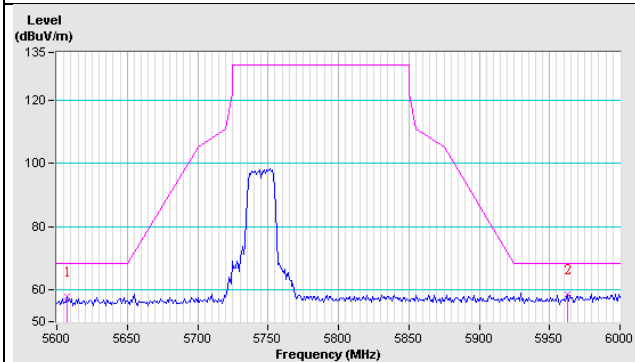

Vertical

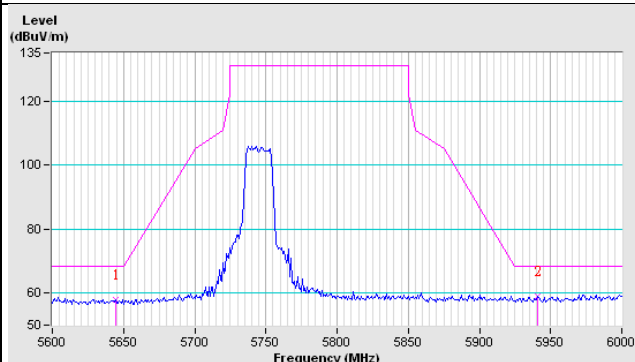

CH157

Horizontal

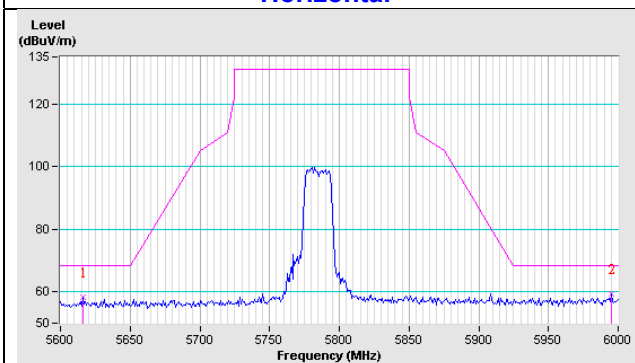

Vertical

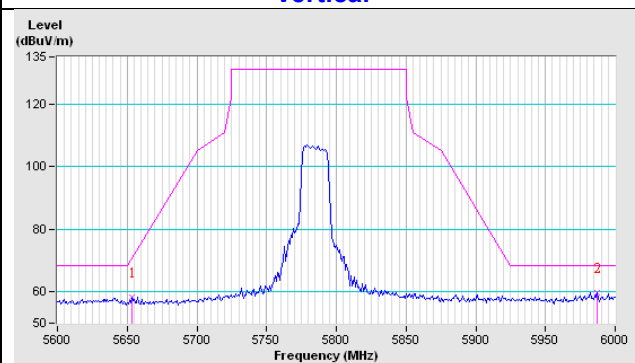

CH165

Horizontal

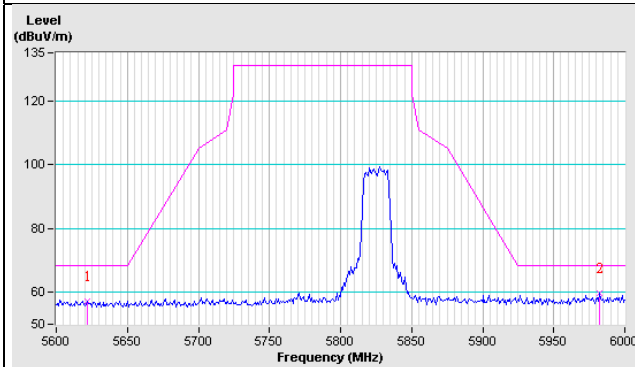

Vertical

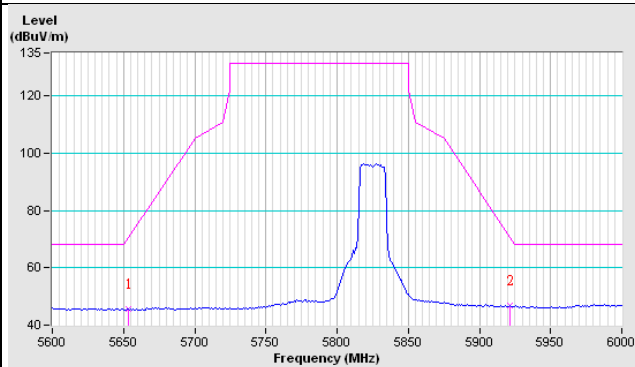



802.11ac (VHT40)_2TX

CH151

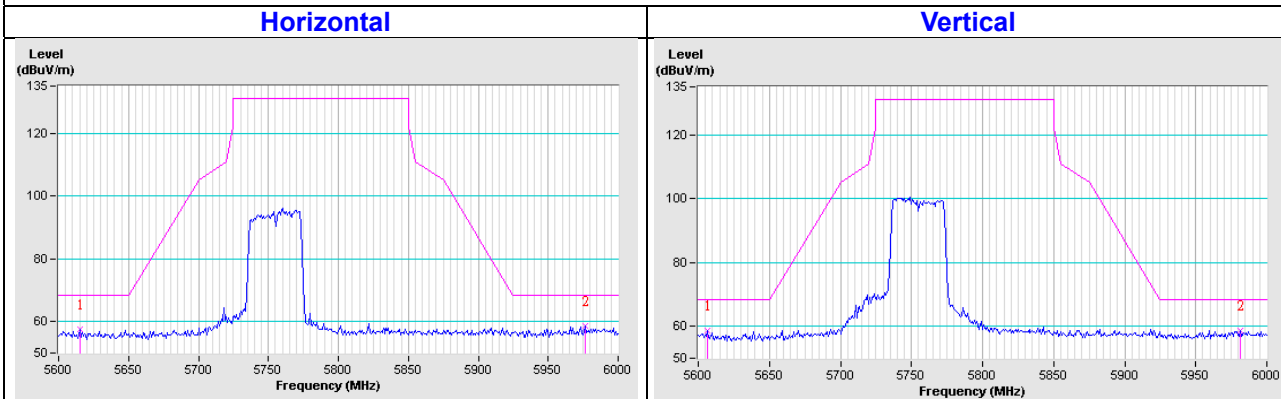

CH159

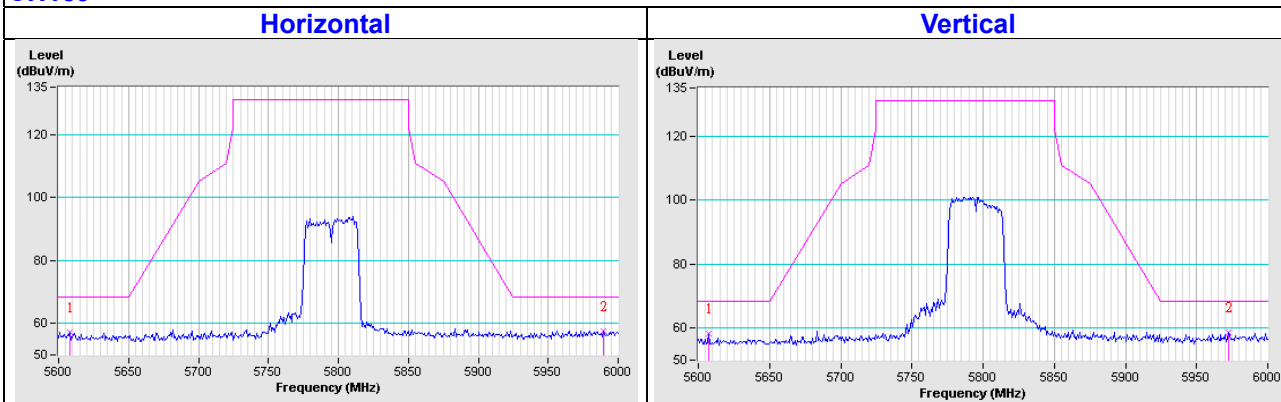

802.11ac (VHT80)_2TX

CH155

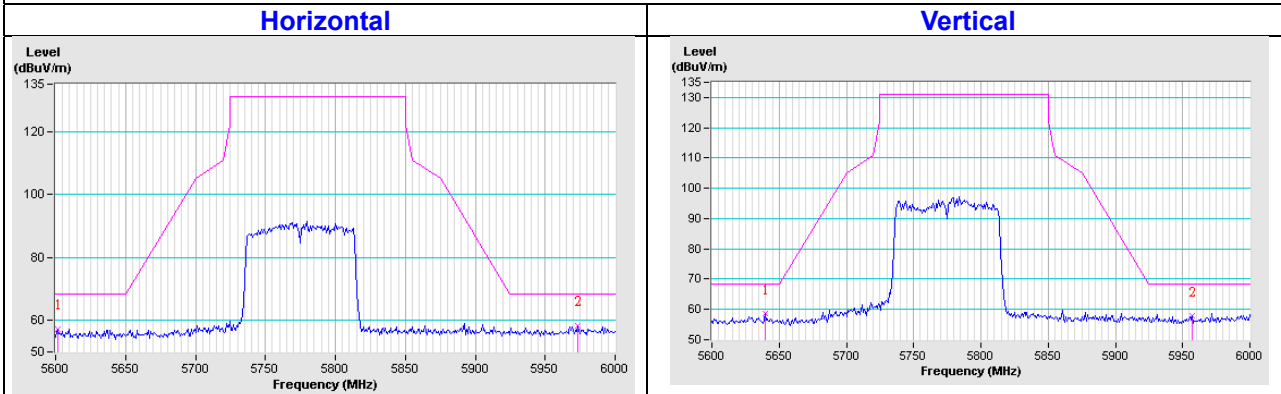

Appendix – Information on the Testing Laboratories

We, Bureau Veritas Consumer Products Services (H.K.) Ltd., Taoyuan Branch, were founded in 1988 to provide our best service in EMC, Radio, Telecom and Safety consultation. Our laboratories are accredited and approved according to ISO/IEC 17025.

If you have any comments, please feel free to contact us at the following:

Linko EMC/RF Lab

Tel: 886-2-26052180

Fax: 886-2-26051924

Hsin Chu EMC/RF/Telecom Lab

Tel: 886-3-6668565

Fax: 886-3-6668323

Hwa Ya EMC/RF/Safety

Tel: 886-3-3183232

Fax: 886-3-3270892

Email: service.adt@tw.bureauveritas.com

Web Site: www.bureauveritas-adt.com

The address and road map of all our labs can be found in our web site also.

--- END ---