

Partial FCC Test Report

Report No.: RF160316C18

FCC ID: VPYLB1EN

Test Model: LBEE5ZZ1EN

Received Date: Mar. 16, 2016

Test Date: Apr. 01, 2016 ~ Apr. 12, 2016

Issued Date: Apr. 26, 2016

Applicant: MURATA MANUFACTURING CO., LTD.

Address: 10-1, Higashikotari 1-chome, Nagaokakyo-shi, Kyoto 617-8555 Japan

Issued By: Bureau Veritas Consumer Products Services (H.K.) Ltd., Taoyuan Branch

Lab Address: No. 47-2, 14th Ling, Chia Pau Vil., Lin Kou Dist., New Taipei City, Taiwan
(R.O.C)

Test Location: No. 19, Hwa Ya 2nd Rd, Wen Hwa Tsuen, Kwei Shan Hsiang, Taoyuan
Hsien 333, Taiwan, R.O.C.



This report is for your exclusive use. Any copying or replication of this report to or for any other person or entity, or use of our name or trademark, is permitted only with our prior written permission. This report sets forth our findings solely with respect to the test samples identified herein. The results set forth in this report are not indicative or representative of the quality or characteristics of the lot from which a test sample was taken or any similar or identical product unless specifically and expressly noted. Our report includes all of the tests requested by you and the results thereof based upon the information that you provided to us. You have 60 days from date of issuance of this report to notify us of any material error or omission caused by our negligence, provided, however, that such notice shall be in writing and shall specifically address the issue you wish to raise. A failure to raise such issue within the prescribed time shall constitute your unqualified acceptance of the completeness of this report, the tests conducted and the correctness of the report contents. Unless specific mention, the uncertainty of measurement has been explicitly taken into account to declare the compliance or non-compliance to the specification.

Table of Contents

Release Control Record	3
1 Certificate of Conformity	4
2 Summary of Test Results	5
2.1 Measurement Uncertainty	5
2.2 Modification Record	5
3 General Information	6
3.1 General Description of EUT	6
3.2 Description of Test Modes.....	7
3.2.1 Test Mode Applicability and Tested Channel Detail	7
3.3 Description of Support Units	9
3.3.1 Configuration of System under Test	9
3.4 General Description of Applied Standards.....	9
4 Test Types and Results	10
4.1 Radiated Emission and Bandedge Measurement	10
4.1.1 Limits of Radiated Emission and Bandedge Measurement	10
4.1.2 Test Instruments	11
4.1.3 Test Procedures.....	12
4.1.4 Deviation from Test Standard	12
4.1.5 Test Set Up	13
4.1.6 EUT Operating Conditions.....	13
4.1.7 Test Results	14
4.2 Conducted Emission Measurement.....	40
4.2.1 Limits of Conducted Emission Measurement	40
4.2.2 Test Instruments	40
4.2.3 Test Procedures.....	41
4.2.4 Deviation from Test Standard	41
4.2.5 Test Setup.....	41
4.2.6 EUT Operating Conditions.....	41
4.2.7 Test Results	42
5 Pictures of Test Arrangements	46
Appendix – Information on the Testing Laboratories	47



Release Control Record

Issue No.	Description	Date Issued
RF160316C18	Original Release	Apr. 26, 2016

1 Certificate of Conformity

Product: Communication Module

Brand: Murata

Test Model: LBEE5ZZ1EN

Sample Status: Identical Prototype

Applicant: MURATA MANUFACTURING CO., LTD.

Test Date: Apr. 01, 2016 ~ Apr. 12, 2016

Standards: 47 CFR FCC Part 15, Subpart C (Section 15.247)
ANSI C63.10:2013

The above equipment has been tested by **Bureau Veritas Consumer Products Services (H.K.) Ltd., Taoyuan Branch**, and found compliance with the requirement of the above standards. The test record, data evaluation & Equipment Under Test (EUT) configurations represented herein are true and accurate accounts of the measurements of the sample's EMC characteristics under the conditions specified in this report.

Prepared by : Gina Liu , **Date:** Apr. 26, 2016
Gina Liu / Specialist

Approved by : David Huang , **Date:** Apr. 26, 2016
David Huang / Project Engineer

2 Summary of Test Results

47 CFR FCC Part 15, Subpart C (Section 15.247)			
FCC Clause	Test Item	Result	Remarks
15.207	AC Power Conducted Emission	Pass	Meet the requirement of limit. Minimum passing margin is -14.98 dB at 2.502 MHz.
15.205 / 15.209 / 15.247(d)	Radiated Emissions and Band Edge Measurement	Pass	Meet the requirement of limit. Minimum passing margin is -4.06 dB at 2386 MHz.
15.247(d)	Antenna Port Emission	N/A	Refer to Note
15.247(a)(2)	6 dB Bandwidth	N/A	Refer to Note
15.247(b)	Conducted power	N/A	Refer to Note
15.247(e)	Power Spectral Density	N/A	Refer to Note
15.203	Antenna Requirement	N/A	Refer to Note

Note: Only test item of Conducted and Radiated Emissions were performed for this report. Other testing data is referring to UL Japan, Inc. module report (Test Report No.: 10689818H-A, Issue Date: Jun. 17, 2015).

2.1 Measurement Uncertainty

Where relevant, the following measurement uncertainty levels have been estimated for tests performed on the EUT:

The listed uncertainties are the worst case uncertainty for the entire range of measurement. Please note that the uncertainty values are provided for informational purposes only and are not used in determining the PASS/FAIL results.

Measurement	Frequency	Expanded Uncertainty (k=2) (±)
Radiated Emissions up to 1 GHz	30 MHz ~ 200 MHz	2.93 dB
	200 MHz ~1000 MHz	2.95 dB
Radiated Emissions above 1 GHz	1 GHz ~ 18 GHz	2.26 dB
	18 GHz ~ 40 GHz	1.94 dB

2.2 Modification Record

There were no modifications required for compliance.

3 General Information

3.1 General Description of EUT

Product	Communication Module
Brand	Murata
Test Model	LBEE5ZZ1EN
Status of EUT	Identical Prototype
Power Supply Rating	19.5 Vdc (adapter)
Modulation Type	CCK, DQPSK, DBPSK for DSSS 64QAM, 16QAM, QPSK, BPSK for OFDM
Modulation Technology	DSSS, OFDM
Transfer Rate	802.11b: 11.0 / 5.5 / 2.0 / 1.0 Mbps 802.11g: 54.0 / 48.0 / 36.0 / 24.0 / 18.0 / 12.0 / 9.0 / 6.0 Mbps 802.11n: up to MCS7
Operating Frequency	2412 ~ 2462 MHz
Number of Channel	11 for 802.11b, 802.11g, 802.11n (HT20)
Antenna Type	Refer to Note as below
Antenna Connector	N/A
Accessory Device	N/A
Data Cable Supplied	N/A

Note:

- The EUT incorporates a MIMO function. Physically, the EUT provides two completed transmitters and two receivers.

Modulation Mode	TX Function
802.11b	1TX
802.11g	1TX
802.11n (HT20)	1TX, 2TX

- The antenna information is listed as below.

Antenna Type	Brand Name	Parts Number	Antenna Gain (dBi)
			2.4GHz
Dipole	Laird	WLAN Main Antenna: PDV24515-DE1 WLAN Aux Antenna: PDV24515-DE1	Main: 2.9 Aux: 2.9
Monopole	Taoglas Antenna Solution Ltd.	WLAN Main Antenna: MA761.B.BICG.014 WLAN Aux Antenna: MA761.B.BICG.014	Main: 2.82 Aux: 2.79

- The EUT is authorized for use in specific End-product. Please refer to below table for more details.

Item	Brand	Model
Industrial Computer	Dell	N01PC

- The above EUT information is declared by manufacturer and for more detailed features description, please refer to the manufacturer's specifications or user's manual.

3.2 Description of Test Modes

11 channels are provided for 802.11b, 802.11g and 802.11n (HT20):

Channel	Frequency (MHz)	Channel	Frequency (MHz)
1	2412	7	2442
2	2417	8	2447
3	2422	9	2452
4	2427	10	2457
5	2432	11	2462
6	2437		

3.2.1 Test Mode Applicability and Tested Channel Detail

EUT Configure Mode	Applicable To				Description
	RE \geq 1G	RE $<$ 1G	PLC	APCM	
A	√	√	√	-	1TX (Dipol Antenna)
B	√	-	-	-	2TX (Dipol Antenna)
C	√	√	√	-	1TX (Momopole Antenna)
D	√	-	-	-	2TX (Momopole Antenna)

Where **RE \geq 1G**: Radiated Emission above 1 GHz **RE $<$ 1G**: Radiated Emission below 1 GHz
PLC: Power Line Conducted Emission **APCM**: Antenna Port Conducted Measurement

NOTE: The EUT had been pre-tested on the positioned of each 3 axis. The worst case was found when positioned on **Z-plane**.
NOTE: "-" means no effect.

Radiated Emission Test (Above 1 GHz):

- Pre-Scan has been conducted to determine the worst-case mode from all possible combinations between available modulations, data rates and antenna ports (if EUT with antenna diversity architecture).
- Following channel(s) was (were) selected for the final test as listed below.

EUT Configure Mode	Mode	Available Channel	Tested Channel	Modulation Technology	Modulation Type	Data Rate (Mbps)
A, C	802.11b	1 to 11	1, 6, 11	DSSS	DBPSK	1.0
A, C	802.11g	1 to 11	1, 6, 11	OFDM	BPSK	6.0
A, B, C, D	802.11n (HT20)	1 to 11	1, 6, 11	OFDM	BPSK	MCS0

Radiated Emission Test (Below 1 GHz):

- Pre-Scan has been conducted to determine the worst-case mode from all possible combinations between available modulations, data rates and antenna ports (if EUT with antenna diversity architecture).
- Following channel(s) was (were) selected for the final test as listed below.

EUT Configure Mode	Mode	Available Channel	Tested Channel	Modulation Technology	Modulation Type	Data Rate (Mbps)
A	802.11b	1 to 11	1	DSSS	DBPSK	1.0
C	802.11b	1 to 11	1	DSSS	DBPSK	1.0

Power Line Conducted Emission Test:

- Pre-Scan has been conducted to determine the worst-case mode from all possible combinations between available modulations, data rates and antenna ports (if EUT with antenna diversity architecture).
- Following channel(s) was (were) selected for the final test as listed below.

EUT Configure Mode	Mode	Available Channel	Tested Channel	Modulation Technology	Modulation Type	Data Rate (Mbps)
A	802.11b	1 to 11	1	DSSS	DBPSK	1.0
C	802.11b	1 to 11	1	DSSS	DBPSK	1.0

Test Condition:

Applicable To	Environmental Conditions	Input Power	Tested by
RE \geq 1G	25 deg. C, 65 % RH	120 Vac, 60 Hz	Gavin Wu, Anson Lin
RE<1G	25 deg. C, 65 % RH	120 Vac, 60 Hz	Toby Tian
PLC	25 deg. C, 65 % RH	120 Vac, 60 Hz	Toby Tian

3.3 Description of Support Units

The EUT has been tested as an independent unit together with other necessary accessories or support units.

3.3.1 Configuration of System under Test

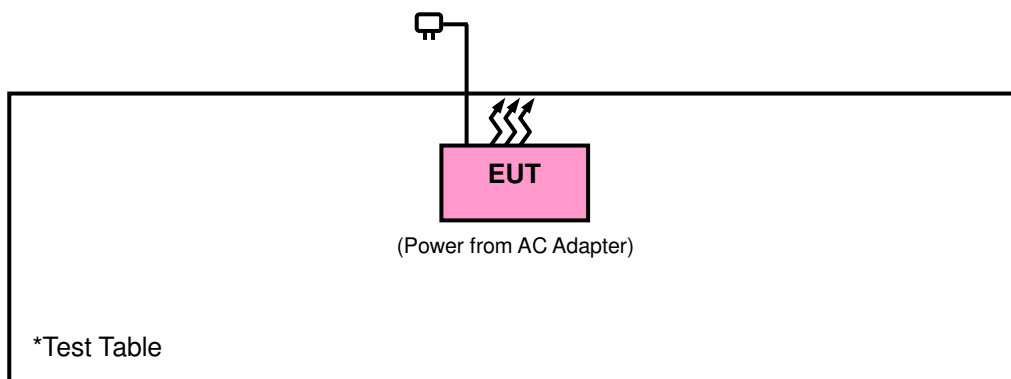

3.4 General Description of Applied Standards

The EUT is a RF Product. According to the specifications of the manufacturer, it must comply with the requirements of the following standards:

FCC Part 15, Subpart C (15.247)

558074 D01 DTS Meas Guidance v03r05

662911 D01 Multiple Transmitter Output v02r01

ANSI C63.10-2013

All test items have been performed and recorded as per the above standards.

NOTE: The EUT has been verified to comply with the requirements of FCC Part 15, Subpart B, Class B (DoC).
The test report has been issued separately.

4 Test Types and Results

4.1 Radiated Emission and Bandedge Measurement

4.1.1 Limits of Radiated Emission and Bandedge Measurement

Radiated emissions which fall in the restricted bands must comply with the radiated emission limits specified as below table. Other emissions shall be at least 20 dB below the highest level of the desired power:

Frequencies (MHz)	Field Strength (microvolts/meter)	Measurement Distance (meters)
0.009 ~ 0.490	2400/F (kHz)	300
0.490 ~ 1.705	24000/F (kHz)	30
1.705 ~ 30.0	30	30
30 ~ 88	100	3
88 ~ 216	150	3
216 ~ 960	200	3
Above 960	500	3

NOTE:

1. The lower limit shall apply at the transition frequencies.
2. Emission level (dBuV/m) = 20 log Emission level (uV/m).
3. For frequencies above 1000 MHz, the field strength limits are based on average detector, however, the peak field strength of any emission shall not exceed the maximum permitted average limits, specified above by more than 20 dB under any condition of modulation.

4.1.2 Test Instruments

Description & Manufacturer	Model No.	Serial No.	Date of Calibration	Due Date of Calibration
Test Receiver Agilent	N9038A	MY51210203	Jan. 21, 2016	Jan. 20, 2017
Spectrum Analyzer Agilent	N9010A	MY52220314	Sep. 03, 2015	Sep. 02, 2016
Spectrum Analyzer ROHDE & SCHWARZ	FSU43	101261	Dec. 17, 2015	Dec. 16, 2016
BILOG Antenna SCHWARZBECK	VULB9168	9168-472	Jan. 07, 2016	Jan. 06, 2017
HORN Antenna SCHWARZBECK	BBHA 9120 D	9120D-969	Jan. 18, 2016	Jan. 17, 2017
HORN Antenna SCHWARZBECK	BBHA 9170	9170-480	Jan. 08, 2016	Jan. 07, 2017
Loop Antenna	EM-6879	269	Jul. 31, 2015	Jul. 30, 2016
Preamplifier EMCI	EMC 012645	980115	Dec. 21, 2015	Dec. 20, 2016
Preamplifier EMCI	EMC 184045	980116	Dec. 21, 2015	Dec. 20, 2016
Preamplifier EMCI	EMC 330H	980112	Dec. 28, 2015	Dec. 27, 2016
Power Meter Anritsu	ML2495A	1232002	Sep. 21, 2015	Sep. 20, 2016
Power Sensor Anritsu	MA2411B	1207325	Sep. 21, 2015	Sep. 20, 2016
RF signal cable HUBER+SUHNNER	SUCOFLEX 104	309219/4 2950114	Oct. 12, 2015	Oct. 11, 2016
RF signal cable HUBER+SUHNNER	SUCOFLEX 104	250130/4	Oct. 12, 2015	Oct. 11, 2016
RF Coaxial Cable Worken	8D-FB	Cable-Ch10-01	Oct. 12, 2015	Oct. 11, 2016
Software BV ADT	E3 6.120103	NA	NA	NA
Antenna Tower MF	MFA-440H	NA	NA	NA
Turn Table MF	MFT-201SS	NA	NA	NA
Antenna Tower & Turn Table Controller MF	MF-7802	NA	NA	NA

- Note: 1. The calibration interval of the above test instruments is 12 months and the calibrations are traceable to NML/ROC and NIST/USA.
2. The test was performed in HwaYa Chamber 10.
3. The horn antenna and preamplifier (model: EMC 184045) are used only for the measurement of emission frequency above 1 GHz if tested.
4. The FCC Site Registration No. is 690701.
5. The IC Site Registration No. is IC7450F-10.

4.1.3 Test Procedures

- a. The EUT was placed on the top of a rotating table 0.8 meters (for below 1 GHz) / 1.5 meters (for above 1 GHz) above the ground at 3 meter chamber room for test. The table was rotated 360 degrees to determine the position of the highest radiation.
- b. The EUT was set 3 meters away from the interference-receiving antenna, which was mounted on the top of a variable-height antenna tower.
- c. The height of antenna is varied from one meter to four meters above the ground to determine the maximum value of the field strength. Both horizontal and vertical polarizations of the antenna are set to make the measurement.
- d. For each suspected emission, the EUT was arranged to its worst case and then the antenna was tuned to heights from 1 meter to 4 meters and the rotatable table was turned from 0 degrees to 360 degrees to find the maximum reading.
- e. The test-receiver system was set to quasi-peak detect function and specified bandwidth with maximum hold mode when the test frequency is below 1 GHz.
- f. The test-receiver system was set to peak and average detected function and specified bandwidth with maximum hold mode when the test frequency is above 1 GHz. If the peak reading value also meets average limit, measurement with the average detector is unnecessary.

Note:

1. The resolution bandwidth and video bandwidth of test receiver/spectrum analyzer is 120 kHz for Quasi-peak detection (QP) at frequency below 1 GHz.
2. The resolution bandwidth of test receiver/spectrum analyzer is 1 MHz and the video bandwidth is 3 MHz for Peak detection (PK) at frequency above 1 GHz.
3. The resolution bandwidth of test receiver/spectrum analyzer is 1 MHz and the video bandwidth is 3 MHz for RMS Average (Duty cycle < 98 %) for Average detection (AV) at frequency above 1 GHz, then the measurement results was added to a correction factor ($10 \log(1/\text{duty cycle})$).
4. The resolution bandwidth of test receiver/spectrum analyzer is 1MHz and the video bandwidth is 10 Hz (Duty cycle ≥ 98 %) for Average detection (AV) at frequency above 1 GHz.
5. All modes of operation were investigated and the worst-case emissions are reported.

4.1.4 Deviation from Test Standard

No deviation.

4.1.5 Test Set Up

<Frequency Range below 1 GHz>

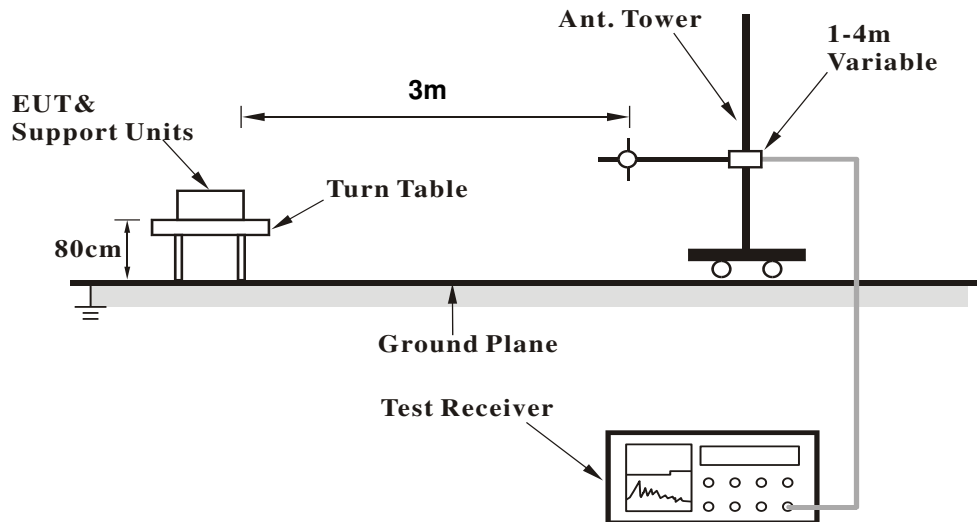

<Frequency Range above 1 GHz>

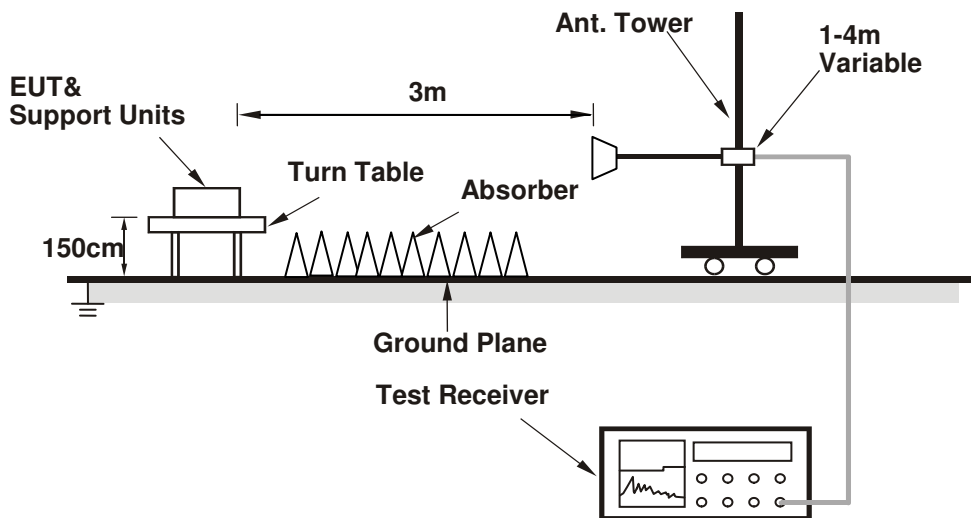

For the actual test configuration, please refer to the attached file (Test Setup Photo).

4.1.6 EUT Operating Conditions

- Placed the EUT on a testing table.
- Use the software to control the EUT under transmission condition continuously at specific channel frequency.

4.1.7 Test Results

Above 1 GHz Data :

Mode A

802.11b

EUT Test Condition		Measurement Detail	
Channel	Channel 1	Frequency Range	1 GHz ~ 25 GHz
Input Power	120 Vac, 60 Hz	Detector Function	Peak (PK) Average (AV)
Environmental Conditions	25 deg. C, 65 % RH	Tested By	Gavin Wu

Antennal Polarity & Test Distance: Horizontal at 3 m										
Frequency (MHz)	Emission Level (dBuV/m)	Read Level (dBuV)	Limit (dBuV/m)	Margin (dB)	Antenna Factor (dB/m)	Cable Loss (dB)	Preamp Factor (dB)	Antenna Height (cm)	Table Angle (Degree)	Remark
2384	49.23	55.79	54	-4.77	26.86	4.08	37.5	184	63	Average
2384	59.23	65.79	74	-14.77	26.86	4.08	37.5	184	63	Peak
2412	105.65	112.12			26.96	4.09	37.52	184	63	Average
2412	109.86	116.33			26.96	4.09	37.52	184	63	Peak
2486	35.57	41.59	54	-18.43	27.15	4.15	37.32	184	63	Average
2486	56.76	62.78	74	-17.24	27.15	4.15	37.32	184	63	Peak
4824	36.52	51.82	54	-17.48	30.99	6.79	53.08	100	125	Average
4824	44.71	60.01	74	-29.29	30.99	6.79	53.08	100	125	Peak

Antennal Polarity & Test Distance: Vertical at 3 m										
Frequency (MHz)	Emission Level (dBuV/m)	Read Level (dBuV)	Limit (dBuV/m)	Margin (dB)	Antenna Factor (dB/m)	Cable Loss (dB)	Preamp Factor (dB)	Antenna Height (cm)	Table Angle (Degree)	Remark
2354	37.19	43.82	54	-16.81	26.81	4.05	37.49	219	63	Average
2354	56.79	63.42	74	-17.21	26.81	4.05	37.49	219	63	Peak
2412	96.78	103.25			26.96	4.09	37.52	219	63	Average
2412	101.01	107.48			26.96	4.09	37.52	219	63	Peak
2486	35.02	41.04	54	-18.98	27.15	4.15	37.32	219	63	Average
2486	56.85	62.87	74	-17.15	27.15	4.15	37.32	219	63	Peak
4824	38.29	53.59	54	-15.71	30.99	6.79	53.08	100	255	Average
4824	45.29	60.59	74	-28.71	30.99	6.79	53.08	100	255	Peak

Remarks:

- Emission Level = Read Level + Antenna Factor + Cable Loss - Preamp Factor
Margin value = Emission level – Limit value
- 2412 MHz: Fundamental frequency.

EUT Test Condition		Measurement Detail	
Channel	Channel 6	Frequency Range	1 GHz ~ 25 GHz
Input Power	120 Vac, 60 Hz	Detector Function	Peak (PK) Average (AV)
Environmental Conditions	25 deg. C, 65 % RH	Tested By	Gavin Wu

Antennal Polarity & Test Distance: Horizontal at 3 m										
Frequency (MHz)	Emission Level (dBuV/m)	Read Level (dBuV)	Limit (dBuV/m)	Margin (dB)	Antenna Factor (dB/m)	Cable Loss (dB)	Preamp Factor (dB)	Antenna Height (cm)	Table Angle (Degree)	Remark
2362	35.16	41.79	54	-18.84	26.81	4.05	37.49	180	63	Average
2362	56.54	63.17	74	-17.46	26.81	4.05	37.49	180	63	Peak
2437	106.52	112.8			27.06	4.12	37.46	180	63	Average
2437	110.25	116.53			27.06	4.12	37.46	180	63	Peak
2484	36.8	42.82	54	-17.2	27.15	4.15	37.32	180	63	Average
2484	56.17	62.19	74	-17.83	27.15	4.15	37.32	180	63	Peak
4874	39.55	54.69	54	-14.45	31.06	6.85	53.05	100	28	Average
4874	46.7	61.84	74	-27.3	31.06	6.85	53.05	100	28	Peak
Antennal Polarity & Test Distance: Vertical at 3 m										
Frequency (MHz)	Emission Level (dBuV/m)	Read Level (dBuV)	Limit (dBuV/m)	Margin (dB)	Antenna Factor (dB/m)	Cable Loss (dB)	Preamp Factor (dB)	Antenna Height (cm)	Table Angle (Degree)	Remark
2378	34.2	40.77	54	-19.8	26.86	4.07	37.5	217	58	Average
2378	56.73	63.3	74	-17.27	26.86	4.07	37.5	217	58	Peak
2437	99.13	105.41			27.06	4.12	37.46	217	58	Average
2437	102.95	109.23			27.06	4.12	37.46	217	58	Peak
2488	35.08	41.04	54	-18.92	27.2	4.16	37.32	217	58	Average
2488	56.37	62.33	74	-17.63	27.2	4.16	37.32	217	58	Peak
4874	45.27	60.41	54	-8.73	31.06	6.85	53.05	140	53	Average
4874	49.29	64.43	74	-24.71	31.06	6.85	53.05	140	53	Peak

Remarks:

- Emission Level = Read Level + Antenna Factor + Cable Loss - Preamp Factor
Margin value = Emission level – Limit value
- 2437 MHz: Fundamental frequency.

EUT Test Condition		Measurement Detail	
Channel	Channel 11	Frequency Range	1 GHz ~ 25 GHz
Input Power	120 Vac, 60 Hz	Detector Function	Peak (PK) Average (AV)
Environmental Conditions	25 deg. C, 65 % RH	Tested By	Gavin Wu

Antennal Polarity & Test Distance: Horizontal at 3 m										
Frequency (MHz)	Emission Level (dBuV/m)	Read Level (dBuV)	Limit (dBuV/m)	Margin (dB)	Antenna Factor (dB/m)	Cable Loss (dB)	Preamp Factor (dB)	Antenna Height (cm)	Table Angle (Degree)	Remark
2386	35.23	41.74	54	-18.77	26.91	4.08	37.5	235	63	Average
2386	56.79	63.3	74	-17.21	26.91	4.08	37.5	235	63	Peak
2462	105.32	111.48			27.1	4.13	37.39	235	63	Average
2462	109.57	115.73			27.1	4.13	37.39	235	63	Peak
2494	40.33	46.22	54	-13.67	27.2	4.16	37.25	235	63	Average
2494	58.23	64.12	74	-15.77	27.2	4.16	37.25	235	63	Peak
4924	42.53	57.56	54	-11.47	31.12	6.88	53.03	100	54	Average
4924	47.09	62.12	74	-26.91	31.12	6.88	53.03	100	54	Peak
Antennal Polarity & Test Distance: Vertical at 3 m										
Frequency (MHz)	Emission Level (dBuV/m)	Read Level (dBuV)	Limit (dBuV/m)	Margin (dB)	Antenna Factor (dB/m)	Cable Loss (dB)	Preamp Factor (dB)	Antenna Height (cm)	Table Angle (Degree)	Remark
2356	34.05	40.68	54	-19.95	26.81	4.05	37.49	202	59	Average
2356	56.97	63.6	74	-17.03	26.81	4.05	37.49	202	59	Peak
2462	97.61	103.77			27.1	4.13	37.39	202	59	Average
2462	101.89	108.05			27.1	4.13	37.39	202	59	Peak
2492	35.76	41.65	54	-18.24	27.2	4.16	37.25	202	59	Average
2492	56.48	62.37	74	-17.52	27.2	4.16	37.25	202	59	Peak
4924	47.69	62.72	54	-6.31	31.12	6.88	53.03	100	53	Average
4924	51.29	66.32	74	-22.71	31.12	6.88	53.03	100	53	Peak

Remarks:

- Emission Level = Read Level + Antenna Factor + Cable Loss - Preamp Factor
Margin value = Emission level – Limit value
- 2462 MHz: Fundamental frequency.

802.11g

EUT Test Condition		Measurement Detail	
Channel	Channel 1	Frequency Range	1 GHz ~ 25 GHz
Input Power	120 Vac, 60 Hz	Detector Function	Peak (PK) Average (AV)
Environmental Conditions	25 deg. C, 65 % RH	Tested By	Anson Lin

Antennal Polarity & Test Distance: Horizontal at 3 m

Frequency (MHz)	Emission Level (dBuV/m)	Read Level (dBuV)	Limit (dBuV/m)	Margin (dB)	Antenna Factor (dB/m)	Cable Loss (dB)	Preamp Factor (dB)	Antenna Height (cm)	Table Angle (Degree)	Remark
2390	47.2	53.73	54	-6.8	26.91	4.08	37.52	182	65	Average
2390	63.13	69.66	74	-10.87	26.91	4.08	37.52	182	65	Peak
2412	96.99	103.46			26.96	4.09	37.52	182	65	Average
2412	107.18	113.65			26.96	4.09	37.52	182	65	Peak
2484	36.75	42.77	54	-17.25	27.15	4.15	37.32	182	65	Average
2484	57.35	63.37	74	-16.65	27.15	4.15	37.32	182	65	Peak

Antennal Polarity & Test Distance: Vertical at 3 m

Frequency (MHz)	Emission Level (dBuV/m)	Read Level (dBuV)	Limit (dBuV/m)	Margin (dB)	Antenna Factor (dB/m)	Cable Loss (dB)	Preamp Factor (dB)	Antenna Height (cm)	Table Angle (Degree)	Remark
2376	37.73	44.3	54	-16.27	26.86	4.07	37.5	216	60	Average
2376	56.82	63.39	74	-17.18	26.86	4.07	37.5	216	60	Peak
2412	90.07	96.54			26.96	4.09	37.52	216	60	Average
2412	100.63	107.1			26.96	4.09	37.52	216	60	Peak
2484	35.08	41.1	54	-18.92	27.15	4.15	37.32	216	60	Average
2484	57.68	63.7	74	-16.32	27.15	4.15	37.32	216	60	Peak

Remarks:

- Emission Level = Read Level + Antenna Factor + Cable Loss - Preamp Factor
Margin value = Emission level – Limit value
- 2412 MHz: Fundamental frequency.

EUT Test Condition		Measurement Detail	
Channel	Channel 6	Frequency Range	1 GHz ~ 25 GHz
Input Power	120 Vac, 60 Hz	Detector Function	Peak (PK) Average (AV)
Environmental Conditions	25 deg. C, 65 % RH	Tested By	Anson Lin

Antennal Polarity & Test Distance: Horizontal at 3 m										
Frequency (MHz)	Emission Level (dBuV/m)	Read Level (dBuV)	Limit (dBuV/m)	Margin (dB)	Antenna Factor (dB/m)	Cable Loss (dB)	Preamp Factor (dB)	Antenna Height (cm)	Table Angle (Degree)	Remark
2366	38.21	44.83	54	-15.79	26.81	4.07	37.5	201	65	Average
2366	56.96	63.58	74	-17.04	26.81	4.07	37.5	201	65	Peak
2437	100.21	106.49			27.06	4.12	37.46	201	65	Average
2437	110.19	116.47			27.06	4.12	37.46	201	65	Peak
2500	36.52	42.41	54	-17.48	27.2	4.16	37.25	201	65	Average
2500	58.06	63.95	74	-15.94	27.2	4.16	37.25	201	65	Peak
Antennal Polarity & Test Distance: Vertical at 3 m										
Frequency (MHz)	Emission Level (dBuV/m)	Read Level (dBuV)	Limit (dBuV/m)	Margin (dB)	Antenna Factor (dB/m)	Cable Loss (dB)	Preamp Factor (dB)	Antenna Height (cm)	Table Angle (Degree)	Remark
2340	36.27	42.95	54	-17.73	26.77	4.04	37.49	185	60	Average
2340	56.99	63.67	74	-17.01	26.77	4.04	37.49	185	60	Peak
2437	94.13	100.41			27.06	4.12	37.46	185	60	Average
2437	103.24	109.52			27.06	4.12	37.46	185	60	Peak
2498	36.96	42.85	54	-17.04	27.2	4.16	37.25	185	60	Average
2498	57.38	63.27	74	-16.62	27.2	4.16	37.25	185	60	Peak

Remarks:

- Emission Level = Read Level + Antenna Factor + Cable Loss - Preamp Factor
Margin value = Emission level – Limit value
- 2437 MHz: Fundamental frequency.

EUT Test Condition		Measurement Detail	
Channel	Channel 11	Frequency Range	1 GHz ~ 25 GHz
Input Power	120 Vac, 60 Hz	Detector Function	Peak (PK) Average (AV)
Environmental Conditions	25 deg. C, 65 % RH	Tested By	Anson Lin

Antennal Polarity & Test Distance: Horizontal at 3 m										
Frequency (MHz)	Emission Level (dBuV/m)	Read Level (dBuV)	Limit (dBuV/m)	Margin (dB)	Antenna Factor (dB/m)	Cable Loss (dB)	Preamp Factor (dB)	Antenna Height (cm)	Table Angle (Degree)	Remark
2368	38.53	45.15	54	-15.47	26.81	4.07	37.5	100	65	Average
2368	58.13	64.75	74	-15.87	26.81	4.07	37.5	100	65	Peak
2462	98.53	104.69			27.1	4.13	37.39	100	65	Average
2462	108.35	114.51			27.1	4.13	37.39	100	65	Peak
2484	48.43	54.45	54	-5.57	27.15	4.15	37.32	100	65	Average
2484	63.39	69.41	74	-10.61	27.15	4.15	37.32	100	65	Peak
Antennal Polarity & Test Distance: Vertical at 3 m										
Frequency (MHz)	Emission Level (dBuV/m)	Read Level (dBuV)	Limit (dBuV/m)	Margin (dB)	Antenna Factor (dB/m)	Cable Loss (dB)	Preamp Factor (dB)	Antenna Height (cm)	Table Angle (Degree)	Remark
2334	36.06	42.77	54	-17.94	26.72	4.04	37.47	222	66	Average
2334	56.92	63.63	74	-17.08	26.72	4.04	37.47	222	66	Peak
2462	94.46	100.62			27.1	4.13	37.39	222	66	Average
2462	104.49	110.65			27.1	4.13	37.39	222	66	Peak
2498	41.78	47.67	54	-12.22	27.2	4.16	37.25	222	66	Average
2498	57.53	63.42	74	-16.47	27.2	4.16	37.25	222	66	Peak

Remarks:

- Emission Level = Read Level + Antenna Factor + Cable Loss - Preamp Factor
Margin value = Emission level – Limit value
- 2462 MHz: Fundamental frequency.

802.11n (HT20)

EUT Test Condition		Measurement Detail	
Channel	Channel 1	Frequency Range	1 GHz ~ 25 GHz
Input Power	120 Vac, 60 Hz	Detector Function	Peak (PK) Average (AV)
Environmental Conditions	25 deg. C, 65 % RH	Tested By	Anson Lin

Antennal Polarity & Test Distance: Horizontal at 3 m

Frequency (MHz)	Emission Level (dBuV/m)	Read Level (dBuV)	Limit (dBuV/m)	Margin (dB)	Antenna Factor (dB/m)	Cable Loss (dB)	Preamp Factor (dB)	Antenna Height (cm)	Table Angle (Degree)	Remark
2388	47.97	54.48	54	-6.03	26.91	4.08	37.5	182	64	Average
2388	64.67	71.18	74	-9.33	26.91	4.08	37.5	182	64	Peak
2412	97.77	104.24			26.96	4.09	37.52	182	64	Average
2412	106.48	112.95			26.96	4.09	37.52	182	64	Peak
2486	39.18	45.2	54	-14.82	27.15	4.15	37.32	182	64	Average
2486	58.26	64.28	74	-15.74	27.15	4.15	37.32	182	64	Peak

Antennal Polarity & Test Distance: Vertical at 3 m

Frequency (MHz)	Emission Level (dBuV/m)	Read Level (dBuV)	Limit (dBuV/m)	Margin (dB)	Antenna Factor (dB/m)	Cable Loss (dB)	Preamp Factor (dB)	Antenna Height (cm)	Table Angle (Degree)	Remark
2374	39.49	46.06	54	-14.51	26.86	4.07	37.5	212	62	Average
2374	57.54	64.11	74	-16.46	26.86	4.07	37.5	212	62	Peak
2412	90.16	96.63			26.96	4.09	37.52	212	62	Average
2412	98.63	105.1			26.96	4.09	37.52	212	62	Peak
2490	37.11	43.07	54	-16.89	27.2	4.16	37.32	212	62	Average
2490	57.88	63.84	74	-16.12	27.2	4.16	37.32	212	62	Peak

Remarks:

- Emission Level = Read Level + Antenna Factor + Cable Loss - Preamp Factor
Margin value = Emission level – Limit value
- 2412 MHz: Fundamental frequency.

EUT Test Condition		Measurement Detail	
Channel	Channel 6	Frequency Range	1 GHz ~ 25 GHz
Input Power	120 Vac, 60 Hz	Detector Function	Peak (PK) Average (AV)
Environmental Conditions	25 deg. C, 65 % RH	Tested By	Anson Lin

Antennal Polarity & Test Distance: Horizontal at 3 m										
Frequency (MHz)	Emission Level (dBuV/m)	Read Level (dBuV)	Limit (dBuV/m)	Margin (dB)	Antenna Factor (dB/m)	Cable Loss (dB)	Preamp Factor (dB)	Antenna Height (cm)	Table Angle (Degree)	Remark
2388	39.07	45.58	54	-14.93	26.91	4.08	37.5	218	64	Average
2388	57.96	64.47	74	-16.04	26.91	4.08	37.5	218	64	Peak
2437	100.39	106.67			27.06	4.12	37.46	218	64	Average
2437	108.93	115.21			27.06	4.12	37.46	218	64	Peak
2484	38.65	44.67	54	-15.35	27.15	4.15	37.32	218	64	Average
2484	57.08	63.1	74	-16.92	27.15	4.15	37.32	218	64	Peak
Antennal Polarity & Test Distance: Vertical at 3 m										
Frequency (MHz)	Emission Level (dBuV/m)	Read Level (dBuV)	Limit (dBuV/m)	Margin (dB)	Antenna Factor (dB/m)	Cable Loss (dB)	Preamp Factor (dB)	Antenna Height (cm)	Table Angle (Degree)	Remark
2374	36.39	42.96	54	-17.61	26.86	4.07	37.5	120	64	Average
2374	58.08	64.65	74	-15.92	26.86	4.07	37.5	120	64	Peak
2437	92.76	99.04			27.06	4.12	37.46	120	64	Average
2437	101.8	108.08			27.06	4.12	37.46	120	64	Peak
2498	37.13	43.02	54	-16.87	27.2	4.16	37.25	120	64	Average
2498	57.93	63.82	74	-16.07	27.2	4.16	37.25	120	64	Peak

Remarks:

- Emission Level = Read Level + Antenna Factor + Cable Loss - Preamp Factor
Margin value = Emission level – Limit value
- 2437 MHz: Fundamental frequency.

EUT Test Condition		Measurement Detail	
Channel	Channel 11	Frequency Range	1 GHz ~ 25 GHz
Input Power	120 Vac, 60 Hz	Detector Function	Peak (PK) Average (AV)
Environmental Conditions	25 deg. C, 65 % RH	Tested By	Anson Lin

Antennal Polarity & Test Distance: Horizontal at 3 m										
Frequency (MHz)	Emission Level (dBuV/m)	Read Level (dBuV)	Limit (dBuV/m)	Margin (dB)	Antenna Factor (dB/m)	Cable Loss (dB)	Preamp Factor (dB)	Antenna Height (cm)	Table Angle (Degree)	Remark
2382	38.47	45.03	54	-15.53	26.86	4.08	37.5	237	65	Average
2382	57	63.56	74	-17	26.86	4.08	37.5	237	65	Peak
2462	98.6	104.76			27.1	4.13	37.39	237	65	Average
2462	107.27	113.43			27.1	4.13	37.39	237	65	Peak
2484	48.71	54.73	54	-5.29	27.15	4.15	37.32	237	65	Average
2484	63.9	69.92	74	-10.1	27.15	4.15	37.32	237	65	Peak
Antennal Polarity & Test Distance: Vertical at 3 m										
Frequency (MHz)	Emission Level (dBuV/m)	Read Level (dBuV)	Limit (dBuV/m)	Margin (dB)	Antenna Factor (dB/m)	Cable Loss (dB)	Preamp Factor (dB)	Antenna Height (cm)	Table Angle (Degree)	Remark
2360	36.11	42.74	54	-17.89	26.81	4.05	37.49	165	62	Average
2360	57.12	63.75	74	-16.88	26.81	4.05	37.49	165	62	Peak
2462	90.32	96.48			27.1	4.13	37.39	165	62	Average
2462	99.36	105.52			27.1	4.13	37.39	165	62	Peak
2496	39.98	45.87	54	-14.02	27.2	4.16	37.25	165	62	Average
2496	57.97	63.86	74	-16.03	27.2	4.16	37.25	165	62	Peak

Remarks:

- Emission Level = Read Level + Antenna Factor + Cable Loss - Preamp Factor
Margin value = Emission level – Limit value
- 2462 MHz: Fundamental frequency.

Mode B

802.11n (HT20)

EUT Test Condition		Measurement Detail	
Channel	Channel 1	Frequency Range	1 GHz ~ 25 GHz
Input Power	120 Vac, 60 Hz	Detector Function	Peak (PK) Average (AV)
Environmental Conditions	25 deg. C, 65 % RH	Tested By	Gavin Wu

Antennal Polarity & Test Distance: Horizontal at 3 m										
Frequency (MHz)	Emission Level (dBuV/m)	Read Level (dBuV)	Limit (dBuV/m)	Margin (dB)	Antenna Factor (dB/m)	Cable Loss (dB)	Preamp Factor (dB)	Antenna Height (cm)	Table Angle (Degree)	Remark
2390	42.77	49.3	54	-11.23	26.91	4.08	37.52	199	66	Average
2390	58.89	65.42	74	-15.11	26.91	4.08	37.52	199	66	Peak
2412	92.26	98.73			26.96	4.09	37.52	199	66	Average
2412	107.23	113.7			26.96	4.09	37.52	199	66	Peak
2500	36.13	42.02	54	-17.87	27.2	4.16	37.25	199	66	Average
2500	57.05	62.94	74	-16.95	27.2	4.16	37.25	199	66	Peak

Antennal Polarity & Test Distance: Vertical at 3 m										
Frequency (MHz)	Emission Level (dBuV/m)	Read Level (dBuV)	Limit (dBuV/m)	Margin (dB)	Antenna Factor (dB/m)	Cable Loss (dB)	Preamp Factor (dB)	Antenna Height (cm)	Table Angle (Degree)	Remark
2388	38.46	44.97	54	-15.54	26.91	4.08	37.5	202	71	Average
2388	57.36	63.87	74	-16.64	26.91	4.08	37.5	202	71	Peak
2412	88.73	95.2			26.96	4.09	37.52	202	71	Average
2412	103.44	109.91			26.96	4.09	37.52	202	71	Peak
2494	35.12	41.01	54	-18.88	27.2	4.16	37.25	202	71	Average
2494	58	63.89	74	-16	27.2	4.16	37.25	202	71	Peak

Remarks:

- Emission Level = Read Level + Antenna Factor + Cable Loss - Preamp Factor
Margin value = Emission level – Limit value
- 2412 MHz: Fundamental frequency.

EUT Test Condition		Measurement Detail	
Channel	Channel 6	Frequency Range	1 GHz ~ 25 GHz
Input Power	120 Vac, 60 Hz	Detector Function	Peak (PK) Average (AV)
Environmental Conditions	25 deg. C, 65 % RH	Tested By	Gavin Wu

Antennal Polarity & Test Distance: Horizontal at 3 m										
Frequency (MHz)	Emission Level (dBuV/m)	Read Level (dBuV)	Limit (dBuV/m)	Margin (dB)	Antenna Factor (dB/m)	Cable Loss (dB)	Preamp Factor (dB)	Antenna Height (cm)	Table Angle (Degree)	Remark
2322	34.6	41.32	54	-19.4	26.72	4.03	37.47	199	68	Average
2322	55.98	62.7	74	-18.02	26.72	4.03	37.47	199	68	Peak
2437	94.15	100.43			27.06	4.12	37.46	199	68	Average
2437	108.48	114.76			27.06	4.12	37.46	199	68	Peak
2496	35.42	41.31	54	-18.58	27.2	4.16	37.25	199	68	Average
2496	56.89	62.78	74	-17.11	27.2	4.16	37.25	199	68	Peak
Antennal Polarity & Test Distance: Vertical at 3 m										
Frequency (MHz)	Emission Level (dBuV/m)	Read Level (dBuV)	Limit (dBuV/m)	Margin (dB)	Antenna Factor (dB/m)	Cable Loss (dB)	Preamp Factor (dB)	Antenna Height (cm)	Table Angle (Degree)	Remark
2358	34.78	41.41	54	-19.22	26.81	4.05	37.49	186	65	Average
2358	57.24	63.87	74	-16.76	26.81	4.05	37.49	186	65	Peak
2437	90.44	96.72			27.06	4.12	37.46	186	65	Average
2437	105.4	111.68			27.06	4.12	37.46	186	65	Peak
2484	35.27	41.29	54	-18.73	27.15	4.15	37.32	186	65	Average
2484	57.67	63.69	74	-16.33	27.15	4.15	37.32	186	65	Peak

Remarks:

- Emission Level = Read Level + Antenna Factor + Cable Loss - Preamp Factor
Margin value = Emission level – Limit value
- 2437 MHz: Fundamental frequency.

EUT Test Condition		Measurement Detail	
Channel	Channel 11	Frequency Range	1 GHz ~ 25 GHz
Input Power	120 Vac, 60 Hz	Detector Function	Peak (PK) Average (AV)
Environmental Conditions	25 deg. C, 65 % RH	Tested By	Gavin Wu

Antennal Polarity & Test Distance: Horizontal at 3 m										
Frequency (MHz)	Emission Level (dBuV/m)	Read Level (dBuV)	Limit (dBuV/m)	Margin (dB)	Antenna Factor (dB/m)	Cable Loss (dB)	Preamp Factor (dB)	Antenna Height (cm)	Table Angle (Degree)	Remark
2376	37.29	43.86	54	-16.71	26.86	4.07	37.5	199	64	Average
2376	57.57	64.14	74	-16.43	26.86	4.07	37.5	199	64	Peak
2462	92.25	98.41			27.1	4.13	37.39	199	64	Average
2462	107.16	113.32			27.1	4.13	37.39	199	64	Peak
2484	41.14	47.16	54	-12.86	27.15	4.15	37.32	199	64	Average
2484	65.14	71.16	74	-8.86	27.15	4.15	37.32	199	64	Peak
Antennal Polarity & Test Distance: Vertical at 3 m										
Frequency (MHz)	Emission Level (dBuV/m)	Read Level (dBuV)	Limit (dBuV/m)	Margin (dB)	Antenna Factor (dB/m)	Cable Loss (dB)	Preamp Factor (dB)	Antenna Height (cm)	Table Angle (Degree)	Remark
2370	34.26	40.83	54	-19.74	26.86	4.07	37.5	199	60	Average
2370	56.86	63.43	74	-17.14	26.86	4.07	37.5	199	60	Peak
2462	88.74	94.9			27.1	4.13	37.39	199	60	Average
2462	103.36	109.52			27.1	4.13	37.39	199	60	Peak
2488	38.43	44.39	54	-15.57	27.2	4.16	37.32	199	60	Average
2488	61.84	67.8	74	-12.16	27.2	4.16	37.32	199	60	Peak

Remarks:

1. Emission Level = Read Level + Antenna Factor + Cable Loss - Preamp Factor
Margin value = Emission level – Limit value
2. 2462 MHz: Fundamental frequency.

Mode C

802.11b

EUT Test Condition		Measurement Detail	
Channel	Channel 1	Frequency Range	1 GHz ~ 25 GHz
Input Power	120 Vac, 60 Hz	Detector Function	Peak (PK) Average (AV)
Environmental Conditions	25 deg. C, 65 % RH	Tested By	Gavin Wu

Antennal Polarity & Test Distance: Horizontal at 3 m										
Frequency (MHz)	Emission Level (dBuV/m)	Read Level (dBuV)	Limit (dBuV/m)	Margin (dB)	Antenna Factor (dB/m)	Cable Loss (dB)	Preamp Factor (dB)	Antenna Height (cm)	Table Angle (Degree)	Remark
2386	49.94	56.45	54	-4.06	26.91	4.08	37.5	171	322	Average
2386	60.17	66.68	74	-13.83	26.91	4.08	37.5	171	322	Peak
2412	106.74	113.21			26.96	4.09	37.52	171	322	Average
2412	110.76	117.23			26.96	4.09	37.52	171	322	Peak
2496	35.5	41.39	54	-18.5	27.2	4.16	37.25	171	322	Average
2496	56.34	62.23	74	-17.66	27.2	4.16	37.25	171	322	Peak
4824	47.6	62.9	54	-6.4	30.99	6.79	53.08	101	119	Average
4824	49.11	64.41	74	-24.89	30.99	6.79	53.08	101	119	Peak

Antennal Polarity & Test Distance: Vertical at 3 m										
Frequency (MHz)	Emission Level (dBuV/m)	Read Level (dBuV)	Limit (dBuV/m)	Margin (dB)	Antenna Factor (dB/m)	Cable Loss (dB)	Preamp Factor (dB)	Antenna Height (cm)	Table Angle (Degree)	Remark
2368	44.13	50.75	54	-9.87	26.81	4.07	37.5	190	336	Average
2368	55.92	62.54	74	-18.08	26.81	4.07	37.5	190	336	Peak
2412	100.62	107.09			26.96	4.09	37.52	190	336	Average
2412	105	111.47			26.96	4.09	37.52	190	336	Peak
2488	34.35	40.31	54	-19.65	27.2	4.16	37.32	190	336	Average
2488	55.45	61.41	74	-18.55	27.2	4.16	37.32	190	336	Peak
4824	44.23	59.53	54	-9.77	30.99	6.79	53.08	115	236	Average
4824	46.44	61.74	74	-27.56	30.99	6.79	53.08	115	236	Peak

Remarks:

- Emission Level = Read Level + Antenna Factor + Cable Loss - Preamp Factor
Margin value = Emission level – Limit value
- 2412 MHz: Fundamental frequency.

EUT Test Condition		Measurement Detail	
Channel	Channel 6	Frequency Range	1 GHz ~ 25 GHz
Input Power	120 Vac, 60 Hz	Detector Function	Peak (PK) Average (AV)
Environmental Conditions	25 deg. C, 65 % RH	Tested By	Gavin Wu

Antennal Polarity & Test Distance: Horizontal at 3 m										
Frequency (MHz)	Emission Level (dBuV/m)	Read Level (dBuV)	Limit (dBuV/m)	Margin (dB)	Antenna Factor (dB/m)	Cable Loss (dB)	Preamp Factor (dB)	Antenna Height (cm)	Table Angle (Degree)	Remark
2388	35.66	42.17	54	-18.34	26.91	4.08	37.5	169	320	Average
2388	56.42	62.93	74	-17.58	26.91	4.08	37.5	169	320	Peak
2437	106.6	112.88			27.06	4.12	37.46	169	320	Average
2437	110.41	116.69			27.06	4.12	37.46	169	320	Peak
2500	36.48	42.37	54	-17.52	27.2	4.16	37.25	169	320	Average
2500	55.81	61.7	74	-18.19	27.2	4.16	37.25	169	320	Peak
4874	46.31	61.45	54	-7.69	31.06	6.85	53.05	176	336	Average
4874	48.72	63.86	74	-25.28	31.06	6.85	53.05	176	336	Peak
Antennal Polarity & Test Distance: Vertical at 3 m										
Frequency (MHz)	Emission Level (dBuV/m)	Read Level (dBuV)	Limit (dBuV/m)	Margin (dB)	Antenna Factor (dB/m)	Cable Loss (dB)	Preamp Factor (dB)	Antenna Height (cm)	Table Angle (Degree)	Remark
2376	34.16	40.73	54	-19.84	26.86	4.07	37.5	212	335	Average
2376	57.4	63.97	74	-16.6	26.86	4.07	37.5	212	335	Peak
2437	101.51	107.79			27.06	4.12	37.46	212	335	Average
2437	106.48	112.76			27.06	4.12	37.46	212	335	Peak
2496	34.63	40.52	54	-19.37	27.2	4.16	37.25	212	335	Average
2496	55.6	61.49	74	-18.4	27.2	4.16	37.25	212	335	Peak
4874	43.51	58.65	54	-10.49	31.06	6.85	53.05	117	235	Average
4874	46.98	62.12	74	-27.02	31.06	6.85	53.05	117	235	Peak

Remarks:

- Emission Level = Read Level + Antenna Factor + Cable Loss - Preamp Factor
Margin value = Emission level – Limit value
- 2437 MHz: Fundamental frequency.

EUT Test Condition		Measurement Detail	
Channel	Channel 11	Frequency Range	1 GHz ~ 25 GHz
Input Power	120 Vac, 60 Hz	Detector Function	Peak (PK) Average (AV)
Environmental Conditions	25 deg. C, 65 % RH	Tested By	Gavin Wu

Antennal Polarity & Test Distance: Horizontal at 3 m										
Frequency (MHz)	Emission Level (dBuV/m)	Read Level (dBuV)	Limit (dBuV/m)	Margin (dB)	Antenna Factor (dB/m)	Cable Loss (dB)	Preamp Factor (dB)	Antenna Height (cm)	Table Angle (Degree)	Remark
2338	34.35	41.01	54	-19.65	26.77	4.04	37.47	168	322	Average
2338	56.16	62.82	74	-17.84	26.77	4.04	37.47	168	322	Peak
2462	103.29	109.45			27.1	4.13	37.39	168	322	Average
2462	107.42	113.58			27.1	4.13	37.39	168	322	Peak
2494	39.82	45.71	54	-14.18	27.2	4.16	37.25	168	322	Average
2494	56.26	62.15	74	-17.74	27.2	4.16	37.25	168	322	Peak
4924	48.2	63.23	54	-5.8	31.12	6.88	53.03	100	120	Average
4924	52.04	67.07	74	-21.96	31.12	6.88	53.03	100	120	Peak
Antennal Polarity & Test Distance: Vertical at 3 m										
Frequency (MHz)	Emission Level (dBuV/m)	Read Level (dBuV)	Limit (dBuV/m)	Margin (dB)	Antenna Factor (dB/m)	Cable Loss (dB)	Preamp Factor (dB)	Antenna Height (cm)	Table Angle (Degree)	Remark
2378	33.94	40.51	54	-20.06	26.86	4.07	37.5	198	313	Average
2378	56.69	63.26	74	-17.31	26.86	4.07	37.5	198	313	Peak
2462	97.21	103.37			27.1	4.13	37.39	198	313	Average
2462	101.38	107.54			27.1	4.13	37.39	198	313	Peak
2500	35.75	41.64	54	-18.25	27.2	4.16	37.25	198	313	Average
2500	56.53	62.42	74	-17.47	27.2	4.16	37.25	198	313	Peak
4924	44.16	59.19	54	-9.84	31.12	6.88	53.03	100	234	Average
4924	47.13	62.16	74	-26.87	31.12	6.88	53.03	100	234	Peak

Remarks:

- Emission Level = Read Level + Antenna Factor + Cable Loss - Preamp Factor
Margin value = Emission level – Limit value
- 2462 MHz: Fundamental frequency.

802.11g

EUT Test Condition		Measurement Detail	
Channel	Channel 1	Frequency Range	1 GHz ~ 25 GHz
Input Power	120 Vac, 60 Hz	Detector Function	Peak (PK) Average (AV)
Environmental Conditions	25 deg. C, 65 % RH	Tested By	Gavin Wu

Antennal Polarity & Test Distance: Horizontal at 3 m										
Frequency (MHz)	Emission Level (dBuV/m)	Read Level (dBuV)	Limit (dBuV/m)	Margin (dB)	Antenna Factor (dB/m)	Cable Loss (dB)	Preamp Factor (dB)	Antenna Height (cm)	Table Angle (Degree)	Remark
2390	43.95	50.48	54	-10.05	26.91	4.08	37.52	172	322	Average
2390	62.31	68.84	74	-11.69	26.91	4.08	37.52	172	322	Peak
2412	96.86	103.33			26.96	4.09	37.52	172	322	Average
2412	106.67	113.14			26.96	4.09	37.52	172	322	Peak
2492	35.97	41.86	54	-18.03	27.2	4.16	37.25	172	322	Average
2492	56.22	62.11	74	-17.78	27.2	4.16	37.25	172	322	Peak

Antennal Polarity & Test Distance: Vertical at 3 m										
Frequency (MHz)	Emission Level (dBuV/m)	Read Level (dBuV)	Limit (dBuV/m)	Margin (dB)	Antenna Factor (dB/m)	Cable Loss (dB)	Preamp Factor (dB)	Antenna Height (cm)	Table Angle (Degree)	Remark
2388	38.33	44.84	54	-15.67	26.91	4.08	37.5	188	335	Average
2388	56.24	62.75	74	-17.76	26.91	4.08	37.5	188	335	Peak
2412	91.89	98.36			26.96	4.09	37.52	188	335	Average
2412	101.88	108.35			26.96	4.09	37.52	188	335	Peak
2494	34.4	40.29	54	-19.6	27.2	4.16	37.25	188	335	Average
2494	56.58	62.47	74	-17.42	27.2	4.16	37.25	188	335	Peak

Remarks:

- Emission Level = Read Level + Antenna Factor + Cable Loss - Preamp Factor
Margin value = Emission level – Limit value
- 2412 MHz: Fundamental frequency.

EUT Test Condition		Measurement Detail	
Channel	Channel 6	Frequency Range	1 GHz ~ 25 GHz
Input Power	120 Vac, 60 Hz	Detector Function	Peak (PK) Average (AV)
Environmental Conditions	25 deg. C, 65 % RH	Tested By	Gavin Wu

Antennal Polarity & Test Distance: Horizontal at 3 m										
Frequency (MHz)	Emission Level (dBuV/m)	Read Level (dBuV)	Limit (dBuV/m)	Margin (dB)	Antenna Factor (dB/m)	Cable Loss (dB)	Preamp Factor (dB)	Antenna Height (cm)	Table Angle (Degree)	Remark
2364	35.25	41.86	54	-18.75	26.81	4.07	37.49	151	322	Average
2364	56.74	63.35	74	-17.26	26.81	4.07	37.49	151	322	Peak
2437	99.32	105.6			27.06	4.12	37.46	151	322	Average
2437	108.78	115.06			27.06	4.12	37.46	151	322	Peak
2488	35.92	41.88	54	-18.08	27.2	4.16	37.32	151	322	Average
2488	56.48	62.44	74	-17.52	27.2	4.16	37.32	151	322	Peak
Antennal Polarity & Test Distance: Vertical at 3 m										
Frequency (MHz)	Emission Level (dBuV/m)	Read Level (dBuV)	Limit (dBuV/m)	Margin (dB)	Antenna Factor (dB/m)	Cable Loss (dB)	Preamp Factor (dB)	Antenna Height (cm)	Table Angle (Degree)	Remark
2388	34.24	40.75	54	-19.76	26.91	4.08	37.5	179	312	Average
2388	56.14	62.65	74	-17.86	26.91	4.08	37.5	179	312	Peak
2437	94.11	100.39			27.06	4.12	37.46	179	312	Average
2437	103.6	109.88			27.06	4.12	37.46	179	312	Peak
2488	34.48	40.44	54	-19.52	27.2	4.16	37.32	179	312	Average
2488	56.16	62.12	74	-17.84	27.2	4.16	37.32	179	312	Peak

Remarks:

- Emission Level = Read Level + Antenna Factor + Cable Loss - Preamp Factor
Margin value = Emission level – Limit value
- 2437 MHz: Fundamental frequency.

EUT Test Condition		Measurement Detail	
Channel	Channel 11	Frequency Range	1 GHz ~ 25 GHz
Input Power	120 Vac, 60 Hz	Detector Function	Peak (PK) Average (AV)
Environmental Conditions	25 deg. C, 65 % RH	Tested By	Gavin Wu

Antennal Polarity & Test Distance: Horizontal at 3 m										
Frequency (MHz)	Emission Level (dBuV/m)	Read Level (dBuV)	Limit (dBuV/m)	Margin (dB)	Antenna Factor (dB/m)	Cable Loss (dB)	Preamp Factor (dB)	Antenna Height (cm)	Table Angle (Degree)	Remark
2386	35.68	42.19	54	-18.32	26.91	4.08	37.5	166	324	Average
2386	56.45	62.96	74	-17.55	26.91	4.08	37.5	166	324	Peak
2462	99.42	105.58			27.1	4.13	37.39	166	324	Average
2462	109.14	115.3			27.1	4.13	37.39	166	324	Peak
2488	48.97	54.93	54	-5.03	27.2	4.16	37.32	166	324	Average
2488	71.02	76.98	74	-2.98	27.2	4.16	37.32	166	324	Peak
Antennal Polarity & Test Distance: Vertical at 3 m										
Frequency (MHz)	Emission Level (dBuV/m)	Read Level (dBuV)	Limit (dBuV/m)	Margin (dB)	Antenna Factor (dB/m)	Cable Loss (dB)	Preamp Factor (dB)	Antenna Height (cm)	Table Angle (Degree)	Remark
2322	36.26	42.98	54	-17.74	26.72	4.03	37.47	197	313	Average
2322	55.69	62.41	74	-18.31	26.72	4.03	37.47	197	313	Peak
2462	93.49	99.65			27.1	4.13	37.39	197	313	Average
2462	103.22	109.38			27.1	4.13	37.39	197	313	Peak
2484	42.44	48.46	54	-11.56	27.15	4.15	37.32	197	313	Average
2484	60.79	66.81	74	-13.21	27.15	4.15	37.32	197	313	Peak

Remarks:

- Emission Level = Read Level + Antenna Factor + Cable Loss - Preamp Factor
Margin value = Emission level – Limit value
- 2462 MHz: Fundamental frequency.

802.11n (HT20)

EUT Test Condition		Measurement Detail	
Channel	Channel 1	Frequency Range	1 GHz ~ 25 GHz
Input Power	120 Vac, 60 Hz	Detector Function	Peak (PK) Average (AV)
Environmental Conditions	25 deg. C, 65 % RH	Tested By	Gavin Wu

Antennal Polarity & Test Distance: Horizontal at 3 m

Frequency (MHz)	Emission Level (dBuV/m)	Read Level (dBuV)	Limit (dBuV/m)	Margin (dB)	Antenna Factor (dB/m)	Cable Loss (dB)	Preamp Factor (dB)	Antenna Height (cm)	Table Angle (Degree)	Remark
2390	42.05	48.58	54	-11.95	26.91	4.08	37.52	170	323	Average
2390	62.2	68.73	74	-11.8	26.91	4.08	37.52	170	323	Peak
2412	96.18	102.65			26.96	4.09	37.52	170	323	Average
2412	106.31	112.78			26.96	4.09	37.52	170	323	Peak
2486	35.77	41.79	54	-18.23	27.15	4.15	37.32	170	323	Average
2486	57.14	63.16	74	-16.86	27.15	4.15	37.32	170	323	Peak

Antennal Polarity & Test Distance: Vertical at 3 m

Frequency (MHz)	Emission Level (dBuV/m)	Read Level (dBuV)	Limit (dBuV/m)	Margin (dB)	Antenna Factor (dB/m)	Cable Loss (dB)	Preamp Factor (dB)	Antenna Height (cm)	Table Angle (Degree)	Remark
2390	39.31	45.84	54	-14.69	26.91	4.08	37.52	215	336	Average
2390	58.02	64.55	74	-15.98	26.91	4.08	37.52	215	336	Peak
2412	92.43	98.9			26.96	4.09	37.52	215	336	Average
2412	102.17	108.64			26.96	4.09	37.52	215	336	Peak
2484	34.67	40.69	54	-19.33	27.15	4.15	37.32	215	336	Average
2484	56.79	62.81	74	-17.21	27.15	4.15	37.32	215	336	Peak

Remarks:

- Emission Level = Read Level + Antenna Factor + Cable Loss - Preamp Factor
Margin value = Emission level – Limit value
- 2412 MHz: Fundamental frequency.

EUT Test Condition		Measurement Detail	
Channel	Channel 6	Frequency Range	1 GHz ~ 25 GHz
Input Power	120 Vac, 60 Hz	Detector Function	Peak (PK) Average (AV)
Environmental Conditions	25 deg. C, 65 % RH	Tested By	Gavin Wu

Antennal Polarity & Test Distance: Horizontal at 3 m										
Frequency (MHz)	Emission Level (dBuV/m)	Read Level (dBuV)	Limit (dBuV/m)	Margin (dB)	Antenna Factor (dB/m)	Cable Loss (dB)	Preamp Factor (dB)	Antenna Height (cm)	Table Angle (Degree)	Remark
2378	36.29	42.86	54	-17.71	26.86	4.07	37.5	170	322	Average
2378	56.3	62.87	74	-17.7	26.86	4.07	37.5	170	322	Peak
2437	99.52	105.8			27.06	4.12	37.46	170	322	Average
2437	109.08	115.36			27.06	4.12	37.46	170	322	Peak
2486	36.11	42.13	54	-17.89	27.15	4.15	37.32	170	322	Average
2486	56.41	62.43	74	-17.59	27.15	4.15	37.32	170	322	Peak
Antennal Polarity & Test Distance: Vertical at 3 m										
Frequency (MHz)	Emission Level (dBuV/m)	Read Level (dBuV)	Limit (dBuV/m)	Margin (dB)	Antenna Factor (dB/m)	Cable Loss (dB)	Preamp Factor (dB)	Antenna Height (cm)	Table Angle (Degree)	Remark
2388	34.67	41.18	54	-19.33	26.91	4.08	37.5	215	336	Average
2388	57.12	63.63	74	-16.88	26.91	4.08	37.5	215	336	Peak
2437	94.83	101.11			27.06	4.12	37.46	215	336	Average
2437	104.8	111.08			27.06	4.12	37.46	215	336	Peak
2488	34.47	40.43	54	-19.53	27.2	4.16	37.32	215	336	Average
2488	56.53	62.49	74	-17.47	27.2	4.16	37.32	215	336	Peak

Remarks:

- Emission Level = Read Level + Antenna Factor + Cable Loss - Preamp Factor
Margin value = Emission level – Limit value
- 2437 MHz: Fundamental frequency.

EUT Test Condition		Measurement Detail	
Channel	Channel 11	Frequency Range	1 GHz ~ 25 GHz
Input Power	120 Vac, 60 Hz	Detector Function	Peak (PK) Average (AV)
Environmental Conditions	25 deg. C, 65 % RH	Tested By	Gavin Wu

Antennal Polarity & Test Distance: Horizontal at 3 m										
Frequency (MHz)	Emission Level (dBuV/m)	Read Level (dBuV)	Limit (dBuV/m)	Margin (dB)	Antenna Factor (dB/m)	Cable Loss (dB)	Preamp Factor (dB)	Antenna Height (cm)	Table Angle (Degree)	Remark
2356	36.25	42.88	54	-17.75	26.81	4.05	37.49	169	324	Average
2356	56.35	62.98	74	-17.65	26.81	4.05	37.49	169	324	Peak
2462	96.1	102.26			27.1	4.13	37.39	169	324	Average
2462	106.14	112.3			27.1	4.13	37.39	169	324	Peak
2484	43.79	49.81	54	-10.21	27.15	4.15	37.32	169	324	Average
2484	64.43	70.45	74	-9.57	27.15	4.15	37.32	169	324	Peak
Antennal Polarity & Test Distance: Vertical at 3 m										
Frequency (MHz)	Emission Level (dBuV/m)	Read Level (dBuV)	Limit (dBuV/m)	Margin (dB)	Antenna Factor (dB/m)	Cable Loss (dB)	Preamp Factor (dB)	Antenna Height (cm)	Table Angle (Degree)	Remark
2364	34.28	40.89	54	-19.72	26.81	4.07	37.49	199	311	Average
2364	56.65	63.26	74	-17.35	26.81	4.07	37.49	199	311	Peak
2462	91.08	97.24			27.1	4.13	37.39	199	311	Average
2462	100.62	106.78			27.1	4.13	37.39	199	311	Peak
2484	38.83	44.85	54	-15.17	27.15	4.15	37.32	199	311	Average
2484	59.57	65.59	74	-14.43	27.15	4.15	37.32	199	311	Peak

Remarks:

- Emission Level = Read Level + Antenna Factor + Cable Loss - Preamp Factor
Margin value = Emission level – Limit value
- 2462 MHz: Fundamental frequency.

Mode D

802.11n (HT20)

EUT Test Condition		Measurement Detail	
Channel	Channel 1	Frequency Range	1 GHz ~ 25 GHz
Input Power	120 Vac, 60 Hz	Detector Function	Peak (PK) Average (AV)
Environmental Conditions	25 deg. C, 65 % RH	Tested By	Gavin Wu

Antennal Polarity & Test Distance: Horizontal at 3 m										
Frequency (MHz)	Emission Level (dBuV/m)	Read Level (dBuV)	Limit (dBuV/m)	Margin (dB)	Antenna Factor (dB/m)	Cable Loss (dB)	Preamp Factor (dB)	Antenna Height (cm)	Table Angle (Degree)	Remark
2390	42.79	49.32	54	-11.21	26.91	4.08	37.52	132	345	Average
2390	64.85	71.38	74	-9.15	26.91	4.08	37.52	132	345	Peak
2412	94.41	100.88			26.96	4.09	37.52	132	345	Average
2412	104.87	111.34			26.96	4.09	37.52	132	345	Peak
2492	35.98	41.87	54	-18.02	27.2	4.16	37.25	132	345	Average
2492	56.06	61.95	74	-17.94	27.2	4.16	37.25	132	345	Peak

Antennal Polarity & Test Distance: Vertical at 3 m										
Frequency (MHz)	Emission Level (dBuV/m)	Read Level (dBuV)	Limit (dBuV/m)	Margin (dB)	Antenna Factor (dB/m)	Cable Loss (dB)	Preamp Factor (dB)	Antenna Height (cm)	Table Angle (Degree)	Remark
2390	40.82	47.35	54	-13.18	26.91	4.08	37.52	255	354	Average
2390	60.34	66.87	74	-13.66	26.91	4.08	37.52	255	354	Peak
2412	90.07	96.54			26.96	4.09	37.52	255	354	Average
2412	100.25	106.72			26.96	4.09	37.52	255	354	Peak
2488	34.38	40.34	54	-19.62	27.2	4.16	37.32	255	354	Average
2488	56.97	62.93	74	-17.03	27.2	4.16	37.32	255	354	Peak

Remarks:

- Emission Level = Read Level + Antenna Factor + Cable Loss - Preamp Factor
Margin value = Emission level – Limit value
- 2412 MHz: Fundamental frequency.

EUT Test Condition		Measurement Detail	
Channel	Channel 6	Frequency Range	1 GHz ~ 25 GHz
Input Power	120 Vac, 60 Hz	Detector Function	Peak (PK) Average (AV)
Environmental Conditions	25 deg. C, 65 % RH	Tested By	Gavin Wu

Antennal Polarity & Test Distance: Horizontal at 3 m										
Frequency (MHz)	Emission Level (dBuV/m)	Read Level (dBuV)	Limit (dBuV/m)	Margin (dB)	Antenna Factor (dB/m)	Cable Loss (dB)	Preamp Factor (dB)	Antenna Height (cm)	Table Angle (Degree)	Remark
2362	34.88	41.51	54	-19.12	26.81	4.05	37.49	116	330	Average
2362	56.34	62.97	74	-17.66	26.81	4.05	37.49	116	330	Peak
2437	97.46	103.74			27.06	4.12	37.46	116	330	Average
2437	107.35	113.63			27.06	4.12	37.46	116	330	Peak
2484	34.7	40.72	54	-19.3	27.15	4.15	37.32	116	330	Average
2484	56.56	62.58	74	-17.44	27.15	4.15	37.32	116	330	Peak
Antennal Polarity & Test Distance: Vertical at 3 m										
Frequency (MHz)	Emission Level (dBuV/m)	Read Level (dBuV)	Limit (dBuV/m)	Margin (dB)	Antenna Factor (dB/m)	Cable Loss (dB)	Preamp Factor (dB)	Antenna Height (cm)	Table Angle (Degree)	Remark
2340	34.08	40.76	54	-19.92	26.77	4.04	37.49	252	355	Average
2340	55.88	62.56	74	-18.12	26.77	4.04	37.49	252	355	Peak
2437	92.08	98.36			27.06	4.12	37.46	252	355	Average
2437	102.09	108.37			27.06	4.12	37.46	252	355	Peak
2490	34.3	40.26	54	-19.7	27.2	4.16	37.32	252	355	Average
2490	56.7	62.66	74	-17.3	27.2	4.16	37.32	252	355	Peak

Remarks:

- Emission Level = Read Level + Antenna Factor + Cable Loss - Preamp Factor
Margin value = Emission level – Limit value
- 2437 MHz: Fundamental frequency.

EUT Test Condition		Measurement Detail	
Channel	Channel 11	Frequency Range	1 GHz ~ 25 GHz
Input Power	120 Vac, 60 Hz	Detector Function	Peak (PK) Average (AV)
Environmental Conditions	25 deg. C, 65 % RH	Tested By	Gavin Wu

Antennal Polarity & Test Distance: Horizontal at 3 m										
Frequency (MHz)	Emission Level (dBuV/m)	Read Level (dBuV)	Limit (dBuV/m)	Margin (dB)	Antenna Factor (dB/m)	Cable Loss (dB)	Preamp Factor (dB)	Antenna Height (cm)	Table Angle (Degree)	Remark
2318	34.6	41.32	54	-19.4	26.72	4.03	37.47	101	334	Average
2318	56.13	62.85	74	-17.87	26.72	4.03	37.47	101	334	Peak
2462	95	101.16			27.1	4.13	37.39	101	334	Average
2462	104.59	110.75			27.1	4.13	37.39	101	334	Peak
2486	39.82	45.84	54	-14.18	27.15	4.15	37.32	101	334	Average
2486	57.83	63.85	74	-16.17	27.15	4.15	37.32	101	334	Peak
Antennal Polarity & Test Distance: Vertical at 3 m										
Frequency (MHz)	Emission Level (dBuV/m)	Read Level (dBuV)	Limit (dBuV/m)	Margin (dB)	Antenna Factor (dB/m)	Cable Loss (dB)	Preamp Factor (dB)	Antenna Height (cm)	Table Angle (Degree)	Remark
2324	33.79	40.51	54	-20.21	26.72	4.03	37.47	245	358	Average
2324	56.53	63.25	74	-17.47	26.72	4.03	37.47	245	358	Peak
2462	89.83	95.99			27.1	4.13	37.39	245	358	Average
2462	100.12	106.28			27.1	4.13	37.39	245	358	Peak
2494	36.87	42.76	54	-17.13	27.2	4.16	37.25	245	358	Average
2494	56.46	62.35	74	-17.54	27.2	4.16	37.25	245	358	Peak

Remarks:

- Emission Level = Read Level + Antenna Factor + Cable Loss - Preamp Factor
Margin value = Emission level – Limit value
- 2462 MHz: Fundamental frequency.

9 kHz ~ 30 MHz DATA:

The amplitude of spurious emissions attenuated more than 20 dB below the permissible value is not required to be report.

30 MHz ~ 1 GHz WORST-CASE DATA:

Mode A

802.11b

EUT Test Condition		Measurement Detail	
Channel	Channel 1	Frequency Range	30 MHz ~ 1 GHz
Input Power	120 Vac, 60 Hz	Detector Function	Peak (PK) Quasi-peak (QP)
Environmental Conditions	25 deg. C, 65 % RH	Tested By	Toby Tian

Antennal Polarity & Test Distance: Horizontal at 3 m

Frequency (MHz)	Emission Level (dBuV/m)	Read Level (dBuV)	Limit (dBuV/m)	Margin (dB)	Antenna Factor (dB/m)	Cable Loss (dB)	Preamp Factor (dB)	Antenna Height (cm)	Table Angle (Degree)	Remark
34.85	25.8	43.47	40	-14.2	12.79	0.6	31.06	136	4	Peak
127.97	39.8	58.99	43.5	-3.7	11.55	1.14	31.88	140	188	Peak
183.26	23.03	43.06	43.5	-20.47	10.53	1.23	31.79	123	129	Peak
332.64	16.96	33.32	46	-29.04	13.73	1.72	31.81	12	310	Peak
460.68	19.32	32.75	46	-26.68	16.54	2.01	31.98	131	145	Peak
580.96	22.14	32.87	46	-23.86	19.17	2.22	32.12	136	45	Peak

Antennal Polarity & Test Distance: Vertical at 3 m

Frequency (MHz)	Emission Level (dBuV/m)	Read Level (dBuV)	Limit (dBuV/m)	Margin (dB)	Antenna Factor (dB/m)	Cable Loss (dB)	Preamp Factor (dB)	Antenna Height (cm)	Table Angle (Degree)	Remark
33.88	36.88	54.73	40	-3.12	12.63	0.6	31.08	117	248	Peak
122.15	37.27	56.87	43.5	-6.23	11.15	1.15	31.9	112	251	Peak
221.09	18.24	38.32	46	-27.76	10.26	1.38	31.72	129	169	Peak
423.82	18.51	32.78	46	-27.49	15.81	1.95	32.03	106	8	Peak
514.03	21.74	33.56	46	-24.26	17.64	2.12	31.58	107	356	Peak
630.43	23.32	33.18	46	-22.68	19.97	2.31	32.14	125	241	Peak

Remarks:

- Emission Level = Read Level + Antenna Factor + Cable Loss - Preamp Factor
Margin value = Emission level – Limit value

Mode C

802.11b

EUT Test Condition		Measurement Detail	
Channel	Channel 1	Frequency Range	30 MHz ~ 1 GHz
Input Power	120 Vac, 60 Hz	Detector Function	Peak (PK) Quasi-peak (QP)
Environmental Conditions	25 deg. C, 65 % RH	Tested By	Toby Tian

Antennal Polarity & Test Distance: Horizontal at 3 m										
Frequency (MHz)	Emission Level (dBuV/m)	Read Level (dBuV)	Limit (dBuV/m)	Margin (dB)	Antenna Factor (dB/m)	Cable Loss (dB)	Preamp Factor (dB)	Antenna Height (cm)	Table Angle (Degree)	Remark
33.88	27.34	45.19	40	-12.66	12.63	0.6	31.08	104	270	Peak
127.97	39.73	58.92	43.5	-3.77	11.55	1.14	31.88	101	185	Peak
182.29	22.73	42.72	43.5	-20.77	10.6	1.22	31.81	127	358	Peak
336.52	17.05	33.32	46	-28.95	13.82	1.73	31.82	108	51	Peak
493.66	20.89	33.33	46	-25.11	17.2	2.08	31.72	121	81	Peak
583.87	22.58	33.25	46	-23.42	19.23	2.23	32.13	109	264	Peak

Antennal Polarity & Test Distance: Vertical at 3 m										
Frequency (MHz)	Emission Level (dBuV/m)	Read Level (dBuV)	Limit (dBuV/m)	Margin (dB)	Antenna Factor (dB/m)	Cable Loss (dB)	Preamp Factor (dB)	Antenna Height (cm)	Table Angle (Degree)	Remark
33.88	37.06	54.91	40	-2.94	12.63	0.6	31.08	135	165	Peak
120.21	37.77	57.49	43.5	-5.73	11.02	1.16	31.9	139	286	Peak
223.03	18.02	38.04	46	-27.98	10.34	1.39	31.75	129	334	Peak
426.73	19.96	34.16	46	-26.04	15.87	1.95	32.02	137	86	Peak
508.21	21.63	33.61	46	-24.37	17.51	2.11	31.6	109	53	Peak
602.3	23.09	33.42	46	-22.91	19.63	2.26	32.22	118	58	Peak

Remarks:

1. Emission Level = Read Level + Antenna Factor + Cable Loss - Preamp Factor

Margin value = Emission level – Limit value

4.2 Conducted Emission Measurement

4.2.1 Limits of Conducted Emission Measurement

Frequency (MHz)	Conducted Limit (dBuV)	
	Quasi-peak	Average
0.15 - 0.5	66 - 56	56 - 46
0.50 - 5.0	56	46
5.0 - 30.0	60	50

Note: 1. The lower limit shall apply at the transition frequencies.

2. The limit decreases in line with the logarithm of the frequency in the range of 0.15 to 0.50 MHz.

4.2.2 Test Instruments

Description & Manufacturer	Model No.	Serial No.	Date of Calibration	Due Date of Calibration
Test Receiver ROHDE & SCHWARZ	ESCI	100613	Nov. 16, 2015	Nov. 15, 2016
RF signal cable (with 10dB PAD) Woken	5D-FB	Cable-cond1-01	Dec. 26, 2015	Dec. 25, 2016
LISN ROHDE & SCHWARZ (EUT)	ESH3-Z5	835239/001	Feb. 26, 2016	Feb. 25, 2017
LISN ROHDE & SCHWARZ (Peripheral)	ESH3-Z5	100311	Jul. 24, 2015	Jul. 23, 2016
Software ADT	BV ADT_Cond_ V7.3.7.3	NA	NA	NA

Note: 1. The calibration interval of the above test instruments is 12 months and the calibrations are traceable to NML/ROC and NIST/USA.

2. The test was performed in HwaYa Shielded Room 1.

3. The VCCI Site Registration No. is C-2040.

4.2.3 Test Procedures

- a. The EUT was placed 0.4 meters from the conducting wall of the shielded room with EUT being connected to the power mains through a line impedance stabilization network (LISN). Other support units were connected to the power mains through another LISN. The two LISNs provide 50 ohm/50 uH of coupling impedance for the measuring instrument.
- b. Both lines of the power mains connected to the EUT were checked for maximum conducted interference.
- c. The frequency range from 150 kHz to 30 MHz was searched. Emission levels under (Limit – 20 dB) was not recorded.

NOTE: All modes of operation were investigated and the worst-case emissions are reported.

4.2.4 Deviation from Test Standard

No deviation.

4.2.5 Test Setup

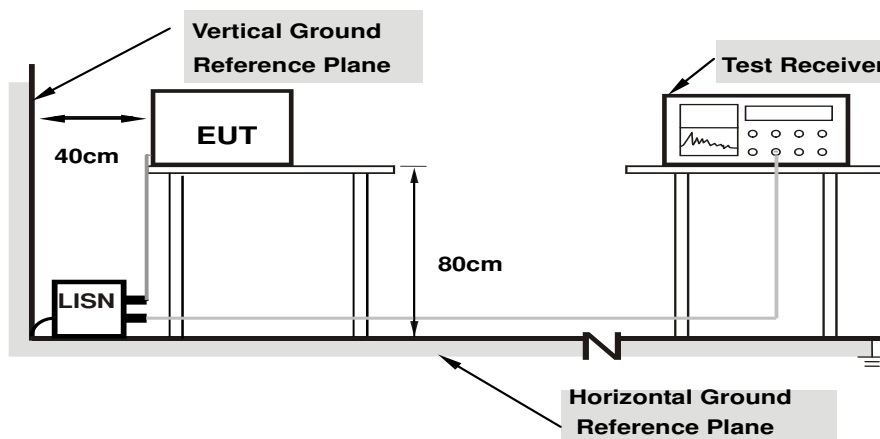

Note: 1. Support units were connected to second LISN.

For the actual test configuration, please refer to the attached file (Test Setup Photo).

4.2.6 EUT Operating Conditions

- a. Placed the EUT on a testing table.
- b. Use the software to control the EUT under transmission condition continuously at specific channel frequency.

4.2.7 Test Results

Mode A

Phase	Line (L)	Detector Function	Quasi-Peak (QP) / Average (AV)
-------	----------	-------------------	--------------------------------

No	Freq. [MHz]	Corr.	Reading Value		Emission Level		Limit		Margin	
		Factor	[dB (uV)]		[dB (uV)]		[dB (uV)]		(dB)	
	(dB)	Q.P.	AV.	Q.P.	AV.	Q.P.	AV.	Q.P.	AV.	
1	0.15000	10.01	34.88	14.90	44.89	24.91	66.00	56.00	-21.11	-31.09
2	0.16600	10.02	32.20	11.00	42.22	21.02	65.16	55.16	-22.94	-34.14
3	0.23800	10.05	24.05	5.58	34.10	15.63	62.17	52.17	-28.07	-36.54
4	0.42600	10.12	23.56	11.54	33.68	21.66	57.33	47.33	-23.65	-25.67
5	2.51395	10.31	22.00	20.39	32.31	30.70	56.00	46.00	-23.69	-15.30
6	4.83800	10.45	15.65	6.94	26.10	17.39	56.00	46.00	-29.90	-28.61

REMARKS:

1. Q.P. and AV. are abbreviations of quasi-peak and average individually.
2. The emission levels of other frequencies were very low against the limit.
3. Margin value = Emission level - Limit value
4. Correction factor = Insertion loss + Cable loss
5. Emission Level = Correction Factor + Reading Value.

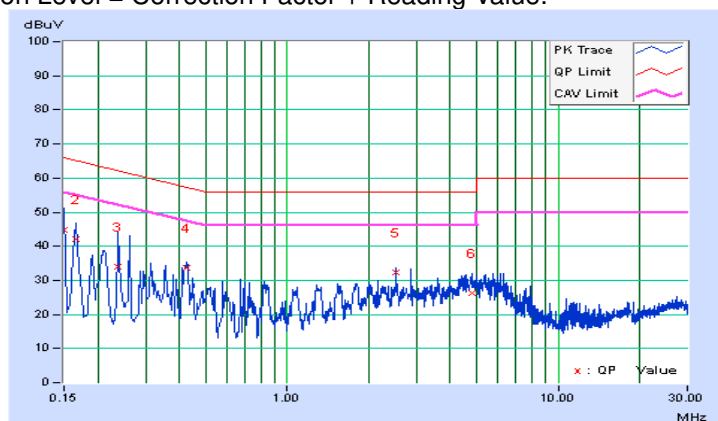

Phase	Neutral (N)	Detector Function	Quasi-Peak (QP) / Average (AV)
-------	-------------	-------------------	--------------------------------

No	Freq. [MHz]	Corr.	Reading Value		Emission Level		Limit		Margin	
		Factor	[dB (uV)]		[dB (uV)]		[dB (uV)]		(dB)	
	(dB)	Q.P.	AV.	Q.P.	AV.	Q.P.	AV.	Q.P.	AV.	
1	0.15000	10.03	34.68	14.48	44.71	24.51	66.00	56.00	-21.29	-31.49
2	0.17000	10.03	32.19	9.61	42.22	19.64	64.96	54.96	-22.74	-35.32
3	0.26200	10.07	21.79	1.47	31.86	11.54	61.37	51.37	-29.51	-39.83
4	0.42131	10.13	21.35	9.82	31.48	19.95	57.42	47.42	-25.94	-27.47
5	2.51800	10.32	21.18	18.47	31.50	28.79	56.00	46.00	-24.50	-17.21
6	4.31000	10.45	20.37	15.27	30.82	25.72	56.00	46.00	-25.18	-20.28

REMARKS:

1. Q.P. and AV. are abbreviations of quasi-peak and average individually.
2. The emission levels of other frequencies were very low against the limit.
3. Margin value = Emission level - Limit value
4. Correction factor = Insertion loss + Cable loss
5. Emission Level = Correction Factor + Reading Value.

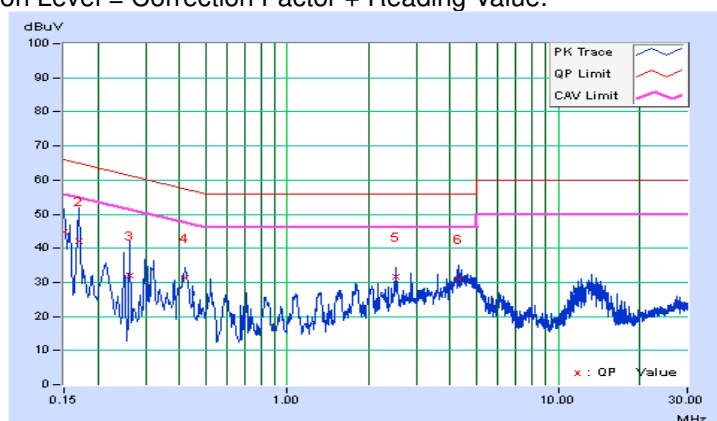

Mode C

Phase	Line (L)	Detector Function	Quasi-Peak (QP) / Average (AV)
-------	----------	-------------------	--------------------------------

No	Freq. [MHz]	Corr. Factor	Reading Value [dB (uV)]		Emission Level [dB (uV)]		Limit [dB (uV)]		Margin (dB)	
		(dB)	Q.P.	AV.	Q.P.	AV.	Q.P.	AV.	Q.P.	AV.
	1	0.15000	10.01	35.81	15.46	45.82	25.47	66.00	56.00	-20.18
2	0.17000	10.02	32.22	10.74	42.24	20.76	64.96	54.96	-22.72	-34.20
3	0.25800	10.06	22.45	3.88	32.51	13.94	61.50	51.50	-28.99	-37.56
4	0.42600	10.12	22.93	9.92	33.05	20.04	57.33	47.33	-24.28	-27.29
5	2.50200	10.31	22.48	20.45	32.79	30.76	56.00	46.00	-23.21	-15.24
6	4.49400	10.44	17.56	9.48	28.00	19.92	56.00	46.00	-28.00	-26.08

REMARKS:

1. Q.P. and AV. are abbreviations of quasi-peak and average individually.
2. The emission levels of other frequencies were very low against the limit.
3. Margin value = Emission level - Limit value
4. Correction factor = Insertion loss + Cable loss
5. Emission Level = Correction Factor + Reading Value.

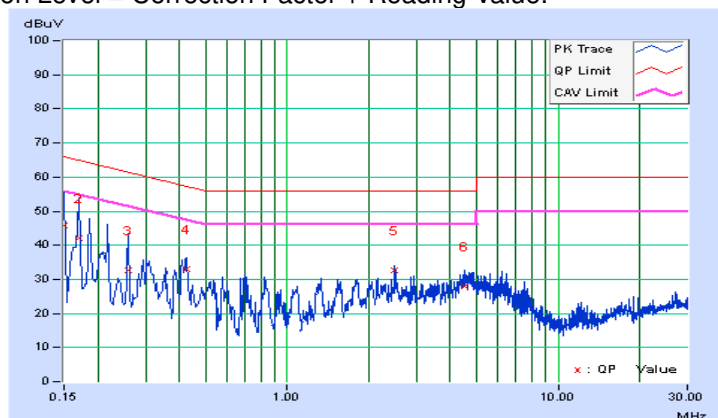

Phase	Neutral (N)	Detector Function	Quasi-Peak (QP) / Average (AV)
-------	-------------	-------------------	--------------------------------

No	Freq. [MHz]	Corr.	Reading Value		Emission Level		Limit		Margin	
		Factor	[dB (uV)]		[dB (uV)]		[dB (uV)]		(dB)	
		(dB)	Q.P.	AV.	Q.P.	AV.	Q.P.	AV.	Q.P.	AV.
1	0.15770	10.03	33.41	13.35	43.44	23.38	65.58	55.58	-22.15	-32.21
2	0.22985	10.05	25.10	5.08	35.15	15.13	62.46	52.46	-27.30	-37.32
3	0.27400	10.07	20.95	2.73	31.02	12.80	61.00	51.00	-29.97	-38.19
4	0.70609	10.17	11.32	-0.53	21.49	9.64	56.00	46.00	-34.51	-36.36
5	2.50200	10.32	17.65	20.70	27.97	31.02	56.00	46.00	-28.03	-14.98
6	5.99800	10.55	18.21	15.17	28.76	25.72	60.00	50.00	-31.24	-24.28

REMARKS:

1. Q.P. and AV. are abbreviations of quasi-peak and average individually.
2. The emission levels of other frequencies were very low against the limit.
3. Margin value = Emission level - Limit value
4. Correction factor = Insertion loss + Cable loss
5. Emission Level = Correction Factor + Reading Value.

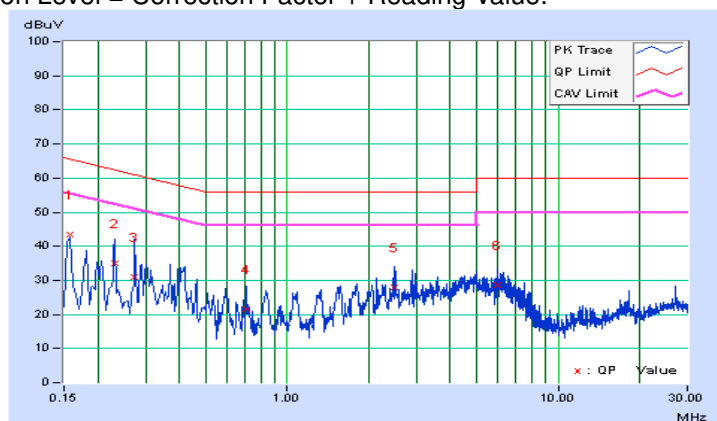

5 Pictures of Test Arrangements

Please refer to the attached file (Test Setup Photo).

Appendix – Information on the Testing Laboratories

We, Bureau Veritas Consumer Products Services (H.K.) Ltd., Taoyuan Branch, were founded in 1988 to provide our best service in EMC, Radio, Telecom and Safety consultation. Our laboratories are accredited and approved according to ISO/IEC 17025.

If you have any comments, please feel free to contact us at the following:

Linko EMC/RF Lab

Tel: 886-2-26052180

Fax: 886-2-26051924

Hsin Chu EMC/RF/Telecom Lab

Tel: 886-3-6668565

Fax: 886-3-6668323

Hwa Ya EMC/RF/Safety Lab

Tel: 886-3-3183232

Fax: 886-3-3270892

Email: service.adt@tw.bureauveritas.com

Web Site: www.bureauveritas-adt.com

The address and road map of all our labs can be found in our web site also.

--- END ---