



EMI TEST REPORT

Test Report No. : 31HE0183-HO-01-C-R1

Applicant : Murata Manufacturing Co., Ltd.
Type of Equipment : Wireless LAN Module
Model No. : LBWA1ZZUN1
FCC ID : VPY-LBUN
Test regulation : FCC Part 15 Subpart E: 2010
(DFS test only)
Test Result : Complied

1. This test report shall not be reproduced in full or partial, without the written approval of UL Japan, Inc.
2. The results in this report apply only to the sample tested.
3. This sample tested is in compliance with above regulation.
4. The test results in this report are traceable to the national or international standards.
5. This test report must not be used by the customer to claim product certification, approval, or endorsement by NVLAP, NIST, or any agency of the Federal Government.
6. This report is a revised version of 31HE0183-HO-01-C. 31HE0183-HO-01-C is replaced with this report.

Date of test :

May 31, 2010

Representative test engineer:

Takayuki Shimada
Engineer of WiSE Japan,
UL Verification Service

Approved by :

Takahiro Hatakeda
Engineer of WiSE Japan,
UL Verification Service



NVLAP LAB CODE: 200572-0

This laboratory is accredited by the NVLAP LAB CODE 200572-0, U.S.A. The tests reported herein have been performed in accordance with its terms of accreditation. *As for the range of Accreditation in NVLAP, you may refer to the WEB address, <http://www.ul.com/japan/jpn/pages/services/emc/about/mark1/index.jsp#nvlap>

UL Japan, Inc.

Head Office EMC Lab.

4383-326 Asama-cho, Ise-shi, Mie-ken 516-0021 JAPAN

Telephone : +81 596 24 8116

Facsimile : +81 596 24 8124

13-EM-F0429

CONTENTS	PAGE
SECTION 1: Customer information.....	3
SECTION 2: Equipment under test (E.U.T.).....	3
SECTION 3: Scope of Report.....	5
SECTION 4: Test specification, procedures & results.....	5
SECTION 5: Operation of E.U.T. during testing	10
SECTION 6: In-Service Monitoring for Channel Move Time, Channel Closing Transmission Time.....	17
SECTION 7: In-Service Monitoring for Non-Occupancy Period	20
APPENDIX 1: Photographs of test setup	22
APPENDIX 2: Data of DFS test	23
Parameter Data for Radar Type 5.....	23
APPENDIX 3: Test instruments	24

SECTION 1: Customer information

Company Name : Murata Manufacturing Co., Ltd.
Address : 10-1, Higashikotari 1-chome, Nagaokakyo-shi, Kyoto 617-8555 Japan
Telephone Number : +81-75-955-6315
Facsimile Number : +81-75-955-7097
Contact Person : Mitsuhiro Hoshii

SECTION 2: Equipment under test (E.U.T.)

2.1 Identification of E.U.T.

Type of Equipment : Wireless LAN Module
Model No. : LBWA1ZZUN1
Serial No. : Refer to Section 4, Clause 4.2
Rating : DC5.0V
Receipt Date of Sample : April 3, 2011
Country of Mass-production : China
Condition of EUT : Production prototype
(Not for Sale: This sample is equivalent to mass-produced items.)
Modification of EUT : No Modification by the test lab

UL Japan, Inc.

Head Office EMC Lab.

4383-326 Asama-cho, Ise-shi, Mie-ken 516-0021 JAPAN

Telephone : +81 596 24 8116

Facsimile : +81 596 24 8124

2.2 Product Description

General Specification

Clock frequency in the system : CRYSTAL: 20MHz

Specification of WLAN (IEEE802.11a/b/g)

Type of radio	Wireless LAN (IEEE802.11a)	Wireless LAN (IEEE802.11b/g)
Equipment Type	Transceiver	
Frequency of Operation	5180MHz - 5320MHz 5500MHz - 5700MHz 5745MHz - 5825MHz	2412MHz - 2462MHz
Bandwidth & Channel spacing	Bandwidth : 18MHz Ch spacing : 20MHz	Bandwidth : 20MHz Ch spacing : 5MHz
Type of Modulation	OFDM	11b: DSSS 11g: OFDM
Antenna Type	Pattern antenna(1/4 lambda monopole antenna) [Antenna 0, Antenna 1]	
Antenna Gain	5150-5350MHz : Antenna 0: 2.3dBi Antenna 1: 2.8dBi 5470-5725MHz : Antenna 0: 3.5dBi Antenna 1: 2.7dBi 5725-5850MHz : Antenna 0: 3.7dBi Antenna 1: 2.9dBi	Antenna 0 : -0.6dBi Antenna 1 : 0.8dBi
Power Supply	DC 5.0V	
Operating temperature range	0 to +55 deg. C.	

Specification of WLAN (IEEE802.11n)

Type of radio	Wireless LAN (IEEE802.11n)			
	2.4G Band MISO (20M Band)	2.4G Band MISO (40M Band)	5G Band MISO (20M Band)	5G Band MISO (40M Band)
Equipment Type	Transceiver			
Frequency of Operation	2412MHz - 2462MHz	2422MHz - 2452MHz	5180MHz - 5320MHz 5500MHz - 5700MHz 5745MHz - 5825MHz	5190MHz - 5310MHz 5510MHz - 5670MHz 5755MHz - 5795MHz
Bandwidth & Channel spacing	Bandwidth : 20MHz Ch spacing : 5MHz	Bandwidth : 40MHz Ch spacing : 5MHz	Bandwidth : 18MHz Ch spacing : 20MHz	Bandwidth : 40MHz Ch spacing : 40MHz
Type of Modulation	OFDM			
Antenna Type	Pattern antenna(1/4 lambda monopole antenna) [Antenna 0, Antenna 1]			
Antenna Gain	Antenna 0 : -0.6dBi Antenna 1: 0.8dBi		5150-5350MHz : Antenna 0: 2.3dBi Antenna 1: 2.8dBi 5470-5725MHz : Antenna 0: 3.5dBi Antenna 1: 2.7dBi 5725-5850MHz : Antenna 0: 3.7dBi Antenna 1: 2.9dBi	
Power Supply	DC 5.0V			
Operating temperature range	0 to +55 deg. C.			
Notes: 5600-5650MHz is not used in Canada.				

UL Japan, Inc.

Head Office EMC Lab.

4383-326 Asama-cho, Ise-shi, Mie-ken 516-0021 JAPAN

Telephone : +81 596 24 8116

Facsimile : +81 596 24 8124

SECTION 3: Scope of Report

This report only covers DFS requirement, as specified by the following referenced procedures.

SECTION 4: Test specification, procedures & results

4.1 Test Specification

Test Specification	:	FCC Part 15 Subpart C: 2010, final revised on December 6, 2010 and effective January 5, 2011
Title	:	FCC 47CFR Part15 Radio Frequency Device Subpart E Unlicensed National Information Infrastructure Devices Section 15.407 General technical requirements
Test Specification	:	FCC 06-96 APPENDIX
Title	:	COMPLIANCE MEASUREMENT PROCEDURES FOR UNLICENSED-NATIONAL INFORMATION INFRASTRUCTURE DEVICES OPERATING IN THE 5250-5350 MHz AND 5470- 5725MHz BANDS INCORPORATING DYNAMIC FREQUENCY SELECTION

FCC 15.31 (e)

The RF Module has its own regulator.

The RF Module is constantly provided voltage (DC3.3V/1.2V) through own regulator regardless of input voltage. Therefore, this EUT complies with the requirement.

FCC Part 15.203 Antenna requirement

It is impossible for end users to replace the antenna, because it is soldered on the circuit board. Therefore the equipment complies with the requirement of 15.203/212.

UL Japan, Inc.

Head Office EMC Lab.

4383-326 Asama-cho, Ise-shi, Mie-ken 516-0021 JAPAN

Telephone : +81 596 24 8116

Facsimile : +81 596 24 8124

4.2 Procedures and results

Table 1: Applicability of DFS Requirements

Requirement	Operating Mode	Test Procedures & Limits	Deviation	Results
	Client without Radar Detection			
U-NII Detection Bandwidth	Not required	FCC 06-96 Appendix 7.8.1	N/A	N/A
Initial Channel Availability Check Time	Not required	FCC15.407 (h)	N/A	N/A
		FCC 06-96 Appendix 7.8.2.1		
		RSS-210 A9.3		
Radar Burst at the Beginning of the Channel Availability Check Time	Not required	FCC15.407 (h)	N/A	N/A
		FCC 06-96 Appendix 7.8.2.2		
		RSS-210 A9.3		
Radar Burst at the End of the Channel Availability Check Time	Not required	FCC15.407 (h)	N/A	N/A
		FCC 06-96 Appendix 7.8.2.3		
		RSS-210 A9.3		
In-Service Monitoring for Channel Move Time, Channel Closing Transmission Time	Yes	FCC15.407 (h)	N/A	Complied
		FCC 06-96 Appendix 7.8.3		
		RSS-210 A9.3		
In-Service Monitoring for Non-Occupancy period	Yes *	FCC15.407 (h)	N/A	Complied
		FCC 06-96 Appendix 7.8.3		
		RSS-210 A9.3		
Statistical Performance Check	Not required	FCC15.407 (h)	N/A	N/A
		FCC 06-96 Appendix 7.8.4		

*Although this test was not required in FCC 06-96, it was performed as additional test.

Table 2: DFS Detection Thresholds for Master Devices and Client Devices With Radar

Maximum Transmit Power	Value (See Notes 1 and 2)
≥ 200 milliwatt	-64 dBm
< 200 milliwatt	-62 dBm
<p>Note 1: This is the level at the input of the receiver assuming a 0 dBi receive antenna.</p> <p>Note 2: Throughout these test procedures an additional 1 dB has been added to the amplitude of the test transmission waveforms to account for variations in measurement equipment. This will ensure that the test signal is at or above the detection threshold level to trigger a DFS response.</p>	

Table 3 DFS Response Requirement Values

Parameter	Value
Non-occupancy period	Minimum 30 minutes
Channel Availability Check Time	60 seconds
Channel Move Time	10 seconds See Note 1
Channel Closing Transmission Time	200 milliseconds + an aggregate of 60 milliseconds over remaining 10 second period. See Notes 1 and 2
U-NII Detection Bandwidth	Minimum 80% of the U-NII 99% transmission power bandwidth See Note 3
<p>Note 1: The instant that the Channel Move Time and the Channel Closing Transmission Time begins is as follows:</p> <ul style="list-style-type: none"> • For the Short Pulse Radar Test Signals this instant is the end of the <i>Burst</i>. • For the Frequency Hopping radar Test Signal, this instant is the end of the last radar <i>Burst</i> generated • For the Long Pulse Radar Test Signal this instant is the end of the 12 second period defining the <i>Radar Waveform</i>. <p>Note 2: The Channel Closing Transmission Time is comprised of 200 milliseconds starting at the beginning of the Channel Move Time plus any additional intermittent control signals required to facilitate a Channel move (an aggregate of 60 milliseconds) during the remainder of the 10 second period. The aggregate duration of control signal will not count quiet periods in between transmissions.</p> <p>Note 3: During the U-NII Detection Bandwidth detection test, radar type 1 is used and for each frequency step the minimum percentage of detection is 90 percent. Measurements are performed with no data traffic.</p>	

Table 4 Short Pulse Radar Test Waveform

Radar Type	Pulse Width (μsec)	PRI (μsec)	Number of Pulses	Minimum Percentage of Successful Detection	Minimum Number of Trials
1	1	1428	18	60%	30
2	1-5	150-230	23-29	60%	30
3	6-10	200-500	16-18	60%	30
4	11-20	200-500	12-16	60%	30
Aggregate (Rader Types 1-4)				80%	120

Table 5 Long Pulse Radar Test Waveform

Radar Type	Pulse Width (μsec)	Chip Width (MHz)	PRI (μsec)	Number of Pulses per Burst	Number of Burst	Minimum Percentage of Successful Detection	Minimum Number of Trials
5	50-100	5-20	1000-2000	1-3	8-20	80%	30

Table 6 Frequency Hopping Radar Test Waveform

Radar Type	Pulse Width (μsec)	PRI (μsec)	Pulse per Hop (kHz)	Hopping Rate (kHz)	Hopping Sequence Length (msec)	Minimum Percentage of Successful Detection	Minimum Number of Trials
6	1	333	9	0.333	300	70%	30

4.3 Test Location

UL Japan, Inc. Head Office EMC Lab. *NVLAP Lab. code: 200572-0
4383-326 Asama-cho, Ise-shi, Mie-ken 516-0021 JAPAN
Telephone : +81 596 24 8116 Facsimile : +81 596 24 8124

	FCC Registration Number	IC Registration Number	Width x Depth x Height (m)	Size of reference ground plane (m) / horizontal conducting plane	Other rooms
No.1 semi-anechoic chamber	313583	2973C-1	19.2 x 11.2 x 7.7m	7.0 x 6.0m	No.1 Power source room
No.2 semi-anechoic chamber	655103	2973C-2	7.5 x 5.8 x 5.2m	4.0 x 4.0m	-
No.3 semi-anechoic chamber	148738	2973C-3	12.0 x 8.5 x 5.9m	6.8 x 5.75m	No.3 Preparation room
No.3 shielded room	-	-	4.0 x 6.0 x 2.7m	N/A	-
No.4 semi-anechoic chamber	134570	2973C-4	12.0 x 8.5 x 5.9m	6.8 x 5.75m	No.4 Preparation room
No.4 shielded room	-	-	4.0 x 6.0 x 2.7m	N/A	-
No.5 semi-anechoic chamber	-	-	6.0 x 6.0 x 3.9m	6.0 x 6.0m	-
No.6 shielded room	-	-	4.0 x 4.5 x 2.7m	4.75 x 5.4 m	-
No.6 measurement room	-	-	4.75 x 5.4 x 3.0m	4.75 x 4.15 m	-
No.7 shielded room	-	-	4.7 x 7.5 x 2.7m	4.7 x 7.5m	-
No.8 measurement room	-	-	3.1 x 5.0 x 2.7m	N/A	-
No.9 measurement room	-	-	8.0 x 4.5 x 2.8m	2.0 x 2.0m	-
No.10 measurement room	-	-	2.6 x 2.8 x 2.5m	2.4 x 2.4m	-
No.11 measurement room	-	-	3.1 x 3.4 x 3.0m	2.4 x 3.4m	-

* Size of vertical conducting plane (for Conducted Emission test) : 2.0 x 2.0m for No.1, No.2, No.3, and No.4 semi-anechoic chambers and No.3 and No.4 shielded rooms.

4.4 Test set up, Data of DFS test, and Test instruments of DFS

Refer to APPENDIX 1 to 3.

SECTION 5: Operation of E.U.T. during testing

5.1 Operating Modes

The EUT, which is a Client Device without Radar detection capability, operates over the 5180MHz - 5320MHz and 5500MHz - 5825MHz ranges.

Power level (EIRP) of the EUT [dBm]

5250-5350MHz Band*		5470-5725MHz Band*	
Output Power (Min)	Output Power(Max)	Output Power (Min)	Output Power(Max)
12.05	14.47	11.67	15.39

*Refer to 31HE0183-HO-01-B, FCC Part 15E (FCC 15.407) report for other parts than DFS.

The EUT uses one transmitter connected to two 50-ohm coaxial antenna ports via a diversity switch. Both antenna ports are connected to the test system via a power divider to perform conducted tests.

WLAN traffic is generated by streaming the MPEG Test file "6 ½ Magic Hours" from the Master to the Client in full motion video mode using the media player with the V2.61 Codec package.

The EUT utilizes the 802.11a and 802.11n architecture, with a nominal channel bandwidth

The FCC ID for the Master Device used with EUT for DFS testing is LDK102056.

The rated output power of the Master unit is >200mW(23dBm). Therefore the required interference threshold level is -64 dBm. After correction for antenna gain and procedural adjustments, the required conducted threshold at the antenna port is $-64 + 1 + 3.5 = -59.5$ dBm (threshold level + additional 1dB + Master unit antenna gain).

It is impossible for users to change DFS control, because the DFS function is written on the firmware and users cannot access it.

The EUT was set by the software as follows:

Software name & version: WLAN Driver, Version 5.100.68.5

UL Japan, Inc.

Head Office EMC Lab.

4383-326 Asama-cho, Ise-shi, Mie-ken 516-0021 JAPAN

Telephone : +81 596 24 8116

Facsimile : +81 596 24 8124

5.2 Configuration and peripherals

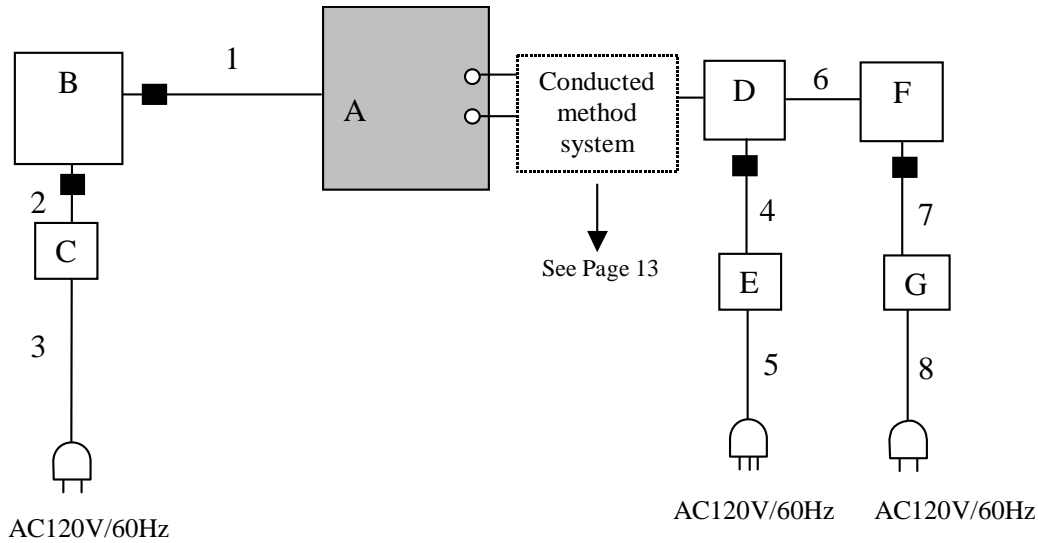

Description of EUT and Support equipment

No.	Item	Model number	Serial number	Manufacturer	Remarks
A	Wireless LAN Module	LBWA1ZZUN1	13	MURATA	EUT
B	Laptop PC	TYPE 2373-GQ7	L3-03T2G	IBM	-
C	AC Adapter	92P1020	11S92P1020Z1Z9R M64CH86	IBM	-
D	Wireless LAN access point	AIR-AP1242AG-A-K9	FTX1045B9L0	Cisco Systems, Inc.	-
E	AC Adapter	ADP-18PB	PZT0639562214	DELTA ELECTRONICS, INC.	-
F	Laptop PC	TYPE 2373-GQ7	L3-4842N	IBM	-
G	AC Adapter	92P1020	11S92P1020Z1Z9R M67H1YC	IBM	-

List of cables used

No.	Name	Length (m)	Shield	
			Cable	Connector
1	USB cable	1.0	Shielded	Shielded
2	DC cable	1.8	Unshielded	Unshielded
3	AC cable	1.0	Unshielded	Unshielded
4	DC cable	1.8	Unshielded	Unshielded
5	AC cable	2.0	Unshielded	Unshielded
6	LAN cable	1.0	Unshielded	Unshielded
7	DC cable	1.8	Unshielded	Unshielded
8	AC cable	1.0	Unshielded	Unshielded

UL Japan, Inc.

Head Office EMC Lab.

4383-326 Asama-cho, Ise-shi, Mie-ken 516-0021 JAPAN

Telephone : +81 596 24 8116

Facsimile : +81 596 24 8124

5.3 Test and Measurement System

SYSTEM OVERVIEW

The measurement system is based on a conducted test method.

The software selects waveform parameters from within the bounds of the signal type on a random basis using uniform distribution. The short pulse types 2, 3, and 4, the long pulse type 5, and the frequency hopping type 6 parameters are randomized at run-time.

The signal monitoring equipment consists of a spectrum analyzer with the capacity to display 8001 bins on the horizontal axis. A time-domain resolution of 2 msec/bin is achievable with a 16 second sweep time, meeting the 10 seconds short pulse reporting criteria. The aggregate ON time is calculated by multiplying the number of bins above a threshold during a particular observation period by the dwell time per bin, with the analyzer set to peak detection. A time-domain resolution of 3 msec/bin is achievable with a 24 second sweep time, meeting the 22 second long pulse reporting criteria and allowing a minimum of 10 seconds after the end of the long pulse waveform.

FREQUENCY HOPPING RADAR WAVEFORM GENERATING SUBSYSTEM

The first 100 frequencies are selected out of the hopping sequence of the randomized 475 hop frequencies. Only a *Burst* that has the frequency falling within the receiver bandwidth of the tested U-NII device is selected among those frequencies. (Frequency-domain simulation). The radar waveform generated at the start time of the selected *Burst* (Time-domain simulation) is download to the Signal Generator. If all of the randomly selected 100 frequencies do not fall within the receiver bandwidth of the U-NII device, the radar waveform is not used for the test.

UL Japan, Inc.

Head Office EMC Lab.

4383-326 Asama-cho, Ise-shi, Mie-ken 516-0021 JAPAN

Telephone : +81 596 24 8116

Facsimile : +81 596 24 8124

CONDUCTED METHODS SYSTEM BLOCK DIAGRAM

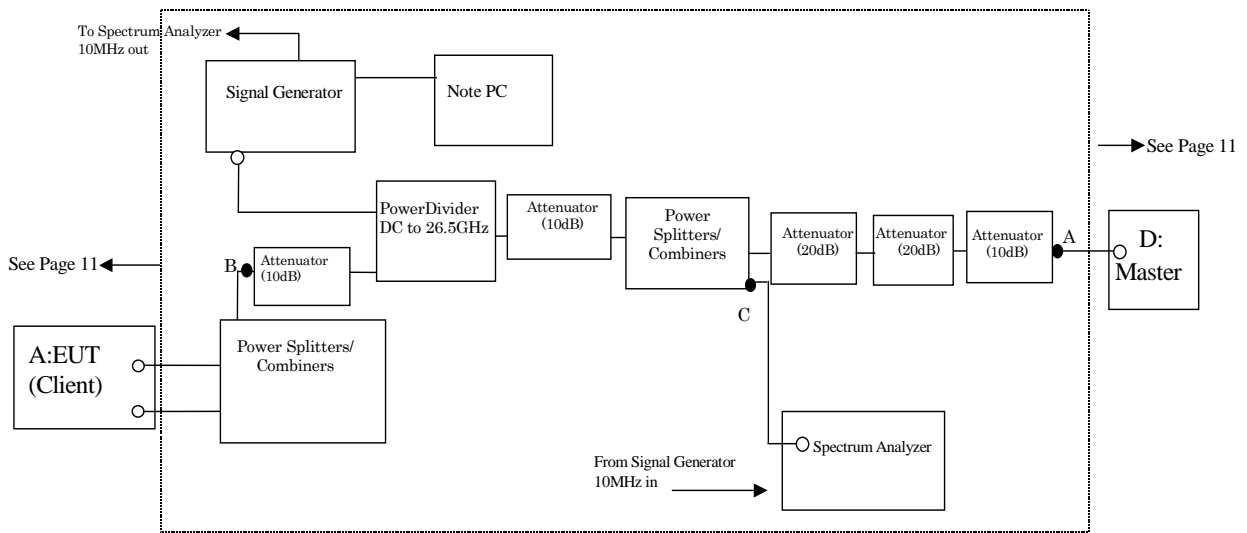

MEASUREMENT SYSTEM FREQUENCY REFERENCE

Lock the signal generator and the spectrum analyzer to the same reference sources as follows: Connect the 10MHz OUT on the signal generator to the 10MHz IN on the spectrum analyzer and set the spectrum analyzer 10MHz In to On.

SYSTEM CALIBRATION

Step 1: Set the system as shown in Figure 3 of FCC 06-96 7.2.1.

Step 2: Adjust each attenuator to fulfill the following three conditions:

- WLAN can be communicated, and
- Rader detection threshold level is bigger than Client Device traffic level on the spectrum analyzer, and
- Master Device traffic level is not displayed on the spectrum analyzer.

Step 3: Terminate 50 ohm at B and C points, and connect the spectrum analyzer to the point A. (See the figure on page 13) At the point A, adjust the signal generator and spectrum analyzer to the center frequency of the channel to be measured. Download the applicable radar waveforms to the signal generator. Select the radar waveform, trigger a burst manually and measure the amplitude on the spectrum analyzer. Readjust the amplitude of the signal generator as required so that the peak level of the waveform is at a displayed level equal to the required or desired interference detection threshold. Separate signal generator amplitude settings are determined as required for each radar type.

Step 4: Without changing any of the instrument settings, restore the system setting to Step 2 and adjust the Reference Level Offset of the spectrum analyzer to the level at Step 3.

By taking the above steps 1 to 4, the spectrum analyzer displays the level of the signal generator as received at the antenna ports of the Master Device.

See Clause 5.4 for Plots of Noise, Rader Waveforms, and WLAN signals.

5.4 Plots of Noise, Rader Waveforms, and WLAN signals

Plots of System Noise Floor

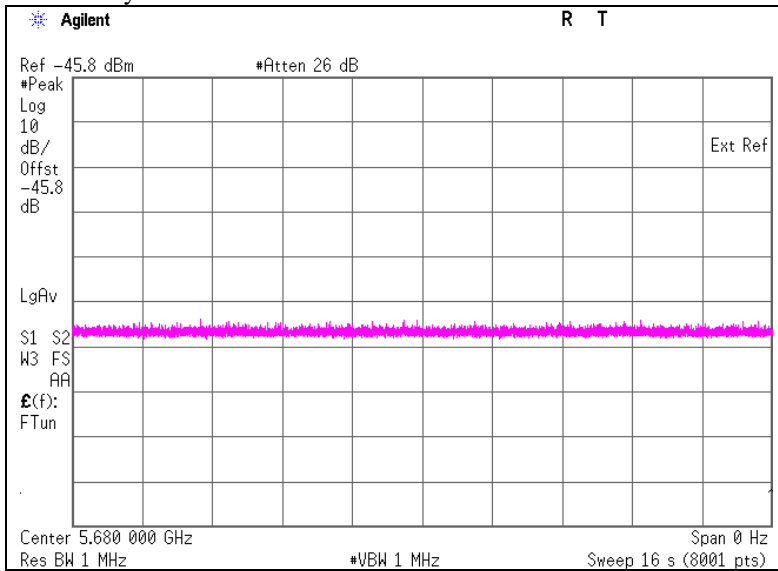

It was confirmed that the EUT did not transmit before having received appropriate control signals from a Master Device.

Plots of Radar Waveforms

Rader Type 1

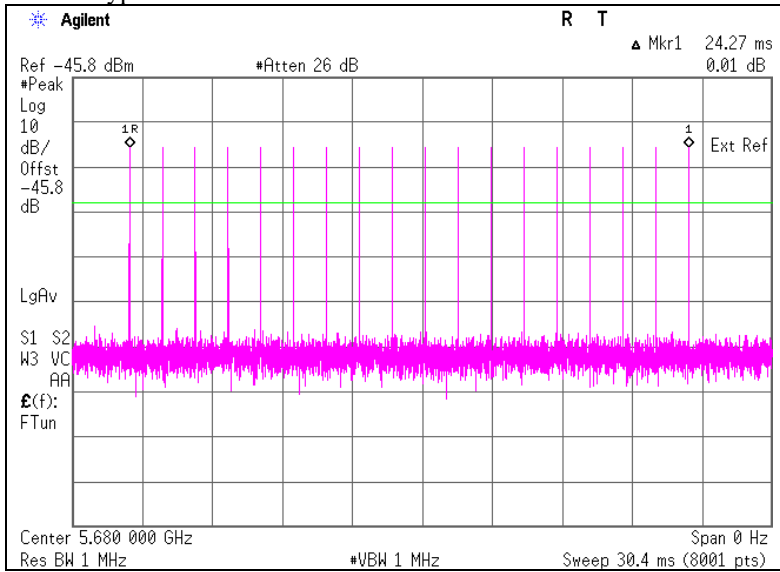

Rader Type 5

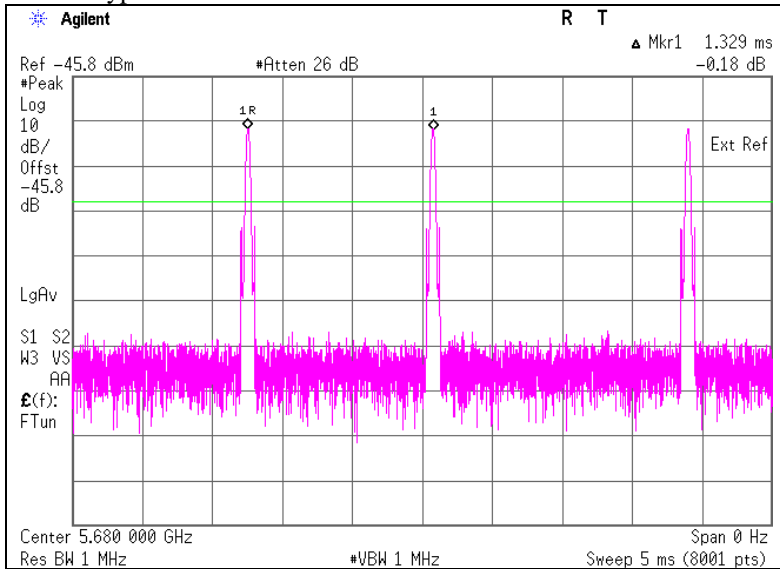

UL Japan, Inc.

Head Office EMC Lab.

4383-326 Asama-cho, Ise-shi, Mie-ken 516-0021 JAPAN

Telephone : +81 596 24 8116

Facsimile : +81 596 24 8124

Plots of WLAN Traffic

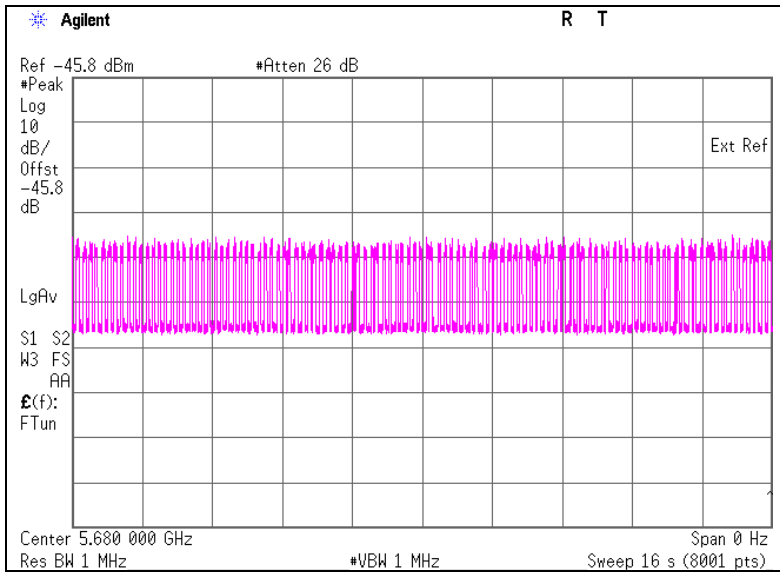

SECTION 6: In-Service Monitoring for Channel Move Time, Channel Closing Transmission Time

6.1 Operating environment

Test place : No.11 Measurement room
Temperature : 24 deg. C
Humidity : 50 % RH

6.2 Test Procedure

Stream the MPEG test file from the Master Device to the Client Device on the test Channel for the entire period of the test. The Radar Waveform generator sends a Burst of pulses for one of the Short Pulse Radar Types 1-4 at levels defined , on the Operating Channel. An additional 1 dB is added to the radar test signal to ensure it is at or above the DFS Detection Threshold, accounting for equipment variations/errors.

Observe the transmissions of the EUT at the end of the radar Burst on the Operating Channel for duration greater than 10 seconds.

6.3 Test data

Test Item	Unit	Measurement Time	Limit	Results
Channel Move Time *1)	[sec]	0.086	10.000	Pass
Channel Closing Transmission Time *2)	[msec]	0	60	Pass

*1) Channel Move Time is calculated as follows:

$$(\text{Channel Move Time}) = (\text{End of Transmission}) - (\text{End of Burst}) = 0.810 - 0.724$$

*2) Channel Closing Transmission Time is calculated from (End of Burst + 200msec) to (End of Burst + 10sec)

$$(\text{Channel Closing Transmission Time}) = (\text{Number of analyzer bins showing transmission}) * (\text{dwell time per bin}) \\ = 0 * 2(\text{msec})$$

UL Japan, Inc.

Head Office EMC Lab.

4383-326 Asama-cho, Ise-shi, Mie-ken 516-0021 JAPAN

Telephone : +81 596 24 8116

Facsimile : +81 596 24 8124

Radar Type 1

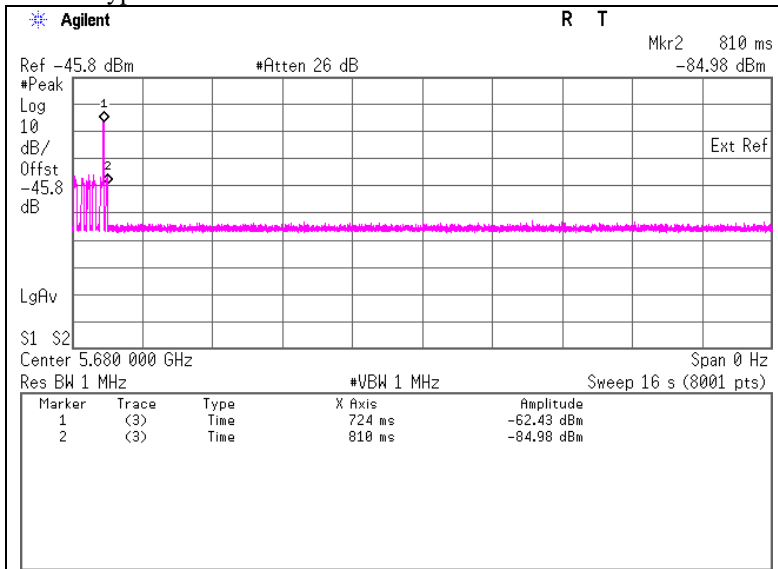

Marker 1 : End of Burst : 724 ms
Marker 2 : End of Transmission : 810 ms

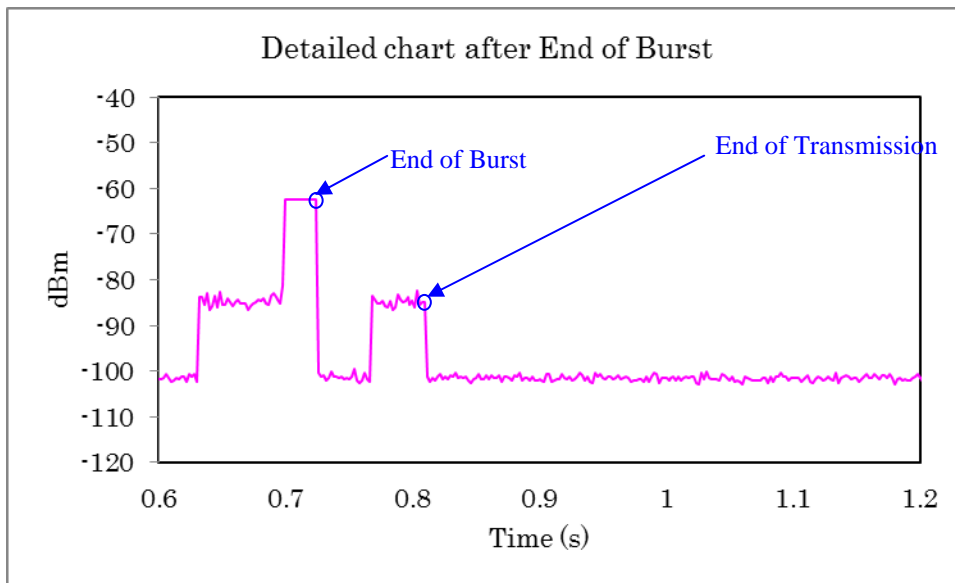

Radar Type 5

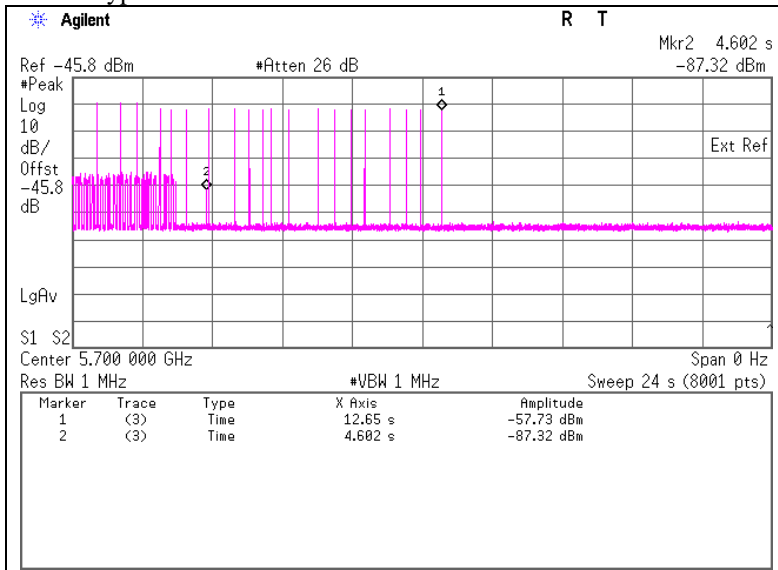

Marker 1 : End of Burst : 12650 ms
Marker 2 : End of Transmission : 4602 ms

6.4 Test result

Test result: Pass

Date : May 31, 2011

Test engineer : Takayuki Shimada

SECTION 7: In-Service Monitoring for Non-Occupancy Period

7.1 Operating environment

Test place : No.11 Measurement room
Temperature : 24 deg. C
Humidity : 50 % RH

7.2 Test Procedure

The following two tests are performed:

- 1).Stream the MPEG test file from the Master Device to the Client Device on the test Channel for the entire period of the test.
The Radar Waveform generator sends a Burst of pulses for one of the Radar Types 1-6 at levels defined on the Operating Channel. An additional 1 dB is added to the radar test signal to ensure it is at or above the DFS Detection Threshold, accounting for equipment variations/errors.
Observe the transmissions of the EUT after the Channel Move Time on the Operating Channel for duration greater than 30 minutes.
- 2). Stream the MPEG test file from the Master Device to the Client Device on the test Channel for the entire period of the test.
Observe the transmissions of the EUT on the Operating Channel for duration greater than 30 minutes after the Master Device is shut off.

7.3 Test data

1).Radar Type 1

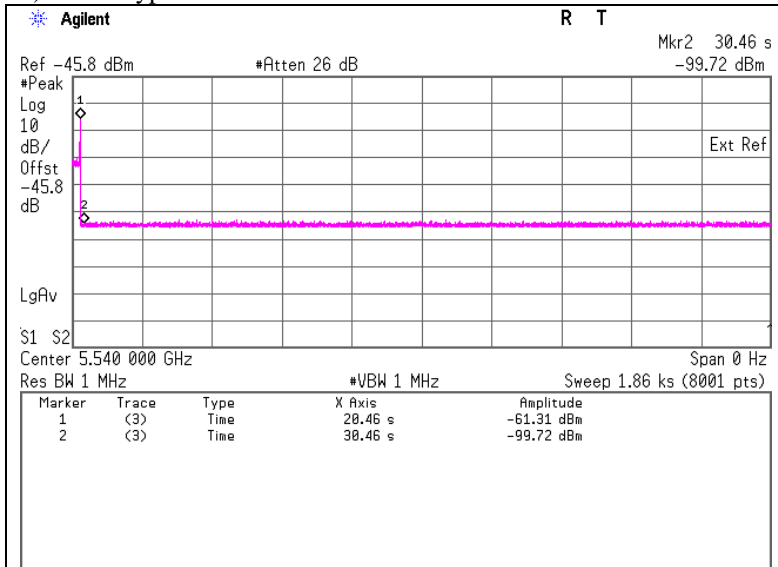

Marker 1 : End of Burst : 20.46 sec
Marker 2 : End of Burst +10sec : 30.46 sec

2).Master is shut off

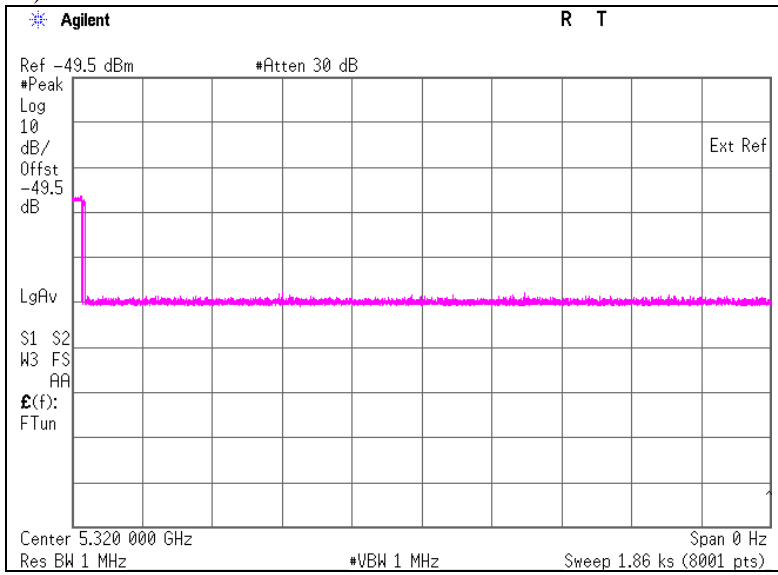

7.4 Test result

Test result: Pass

Date : May 31, 2011

Test engineer : Takayuki Shimada