

FCC Radio Test Report

FCC ID: VOB-P2897

This report concerns (check one): Original Grant Class I Change Class II Change

Project No. : 1602C038E
Equipment : SHIELD Android TV Game Console
Test Model : P2897
Series Model : N/A
Applicant : NVIDIA Corporation
Address : 2788 San Tomas Expressway, Santa Clara, California
95051, United States

Date of Receipt : Oct. 31, 2017
Oct. 26, 2018
Date of Test : Oct. 31, 2017 ~ Apr. 09, 2018
Oct. 30, 2018 ~ Mar. 18, 2019
Issued Date : Jun. 11, 2019
Tested by : BTL Inc.

Testing Engineer : Kai Xu
(Kai Xu)

Technical Manager : Steven Lu
(Steven Lu)

Authorized Signatory : Ethan Ma
(Ethan Ma)

B T L I N C .

No.3, Jinshagang 1st Road, Shixia, Dalang Town, Dongguan,
Guangdong, China.

TEL: +86-769-8318-3000 FAX: +86-769-8319-6000



Certificate #5123.02

Declaration

BTL represents to the client that testing is done in accordance with standard procedures as applicable and that test instruments used has been calibrated with standards traceable to international standard(s) and/or national standard(s).

BTL's reports apply only to the specific samples tested under conditions. It is manufacture's responsibility to ensure that additional production units of this model are manufactured with the identical electrical and mechanical components. **BTL** shall have no liability for any declarations, inferences or generalizations drawn by the client or others from **BTL** issued reports.

The report must not be used by the client to claim product certification, approval, or endorsement by NVLAP, NIST, A2LA, or any agency of the U.S. Government.

This report is the confidential property of the client. As a mutual protection to the clients, the public and ourselves, the test report shall not be reproduced, except in full, without our written approval.

BTL's laboratory quality assurance procedures are in compliance with the **ISO/IEC 17025** requirements, and accredited by the conformity assessment authorities listed in this test report.

BTL is not responsible for the sampling stage, so the results only apply to the sample as received.

The information, data and test plan are provided by manufacturer which may affect the validity of results, so it is manufacturer's responsibility to ensure that the apparatus meets the essential requirements of applied standards and in all the possible configurations as representative of its intended use.

Limitation

For the use of the authority's logo is limited unless the Test Standard(s)/Scope(s)/Item(s) mentioned in this test report is (are) included in the conformity assessment authorities acceptance respective.

Please note that the measurement uncertainty is provided for informational purpose only and are not use in determining the Pass/Fail results.

Table of Contents	Page
REPORT ISSUED HISTORY	6
1 . GENERAL SUMMARY	7
2 . SUMMARY OF TEST RESULTS	8
2.1 TEST FACILITY	9
2.2 MEASUREMENT UNCERTAINTY	9
3 . GENERAL INFORMATION	10
3.1 GENERAL DESCRIPTION OF EUT	10
3.2 DESCRIPTION OF TEST MODES	12
3.3 BLOCK DIAGRAM SHOWING THE CONFIGURATION OF SYSTEM TESTED	13
3.4 DESCRIPTION OF SUPPORT UNITS	13
4 . EMC EMISSION TEST	14
4.1 CONDUCTED EMISSION MEASUREMENT	14
4.1.1 POWER LINE CONDUCTED EMISSION LIMITS	14
4.1.2 TEST PROCEDURE	14
4.1.3 DEVIATION FROM TEST STANDARD	14
4.1.4 TEST SETUP	15
4.1.5 EUT OPERATING CONDITIONS	15
4.1.6 EUT TEST CONDITIONS	15
4.1.7 TEST RESULTS	15
4.2 RADIATED EMISSION MEASUREMENT	16
4.2.1 RADIATED EMISSION LIMITS	16
4.2.2 TEST PROCEDURE	17
4.2.3 DEVIATION FROM TEST STANDARD	17
4.2.4 TEST SETUP	18
4.2.5 EUT OPERATING CONDITIONS	19
4.2.6 EUT TEST CONDITIONS	19
4.2.7 TEST RESULTS (9KHZ TO 30MHZ)	19
4.2.8 TEST RESULTS (30MHZ TO 1000MHZ)	19
4.2.9 TEST RESULTS (ABOVE 1000MHZ)	19
5 . NUMBER OF HOPPING CHANNEL	20
5.1 APPLIED PROCEDURES	20
5.1.1 TEST PROCEDURE	20
5.1.2 DEVIATION FROM STANDARD	20
5.1.3 TEST SETUP	20
5.1.4 EUT OPERATION CONDITIONS	20
5.1.5 EUT TEST CONDITIONS	20
5.1.6 TEST RESULTS	20
6 . AVERAGE TIME OF OCCUPANCY	21

Table of Contents	Page
6.1 APPLIED PROCEDURES / LIMIT	21
6.1.1 TEST PROCEDURE	21
6.1.2 DEVIATION FROM STANDARD	21
6.1.3 TEST SETUP	22
6.1.4 EUT OPERATION CONDITIONS	22
6.1.5 EUT TEST CONDITIONS	22
6.1.6 TEST RESULTS	22
7 . HOPPING CHANNEL SEPARATION MEASUREMENT	23
7.1 APPLIED PROCEDURES / LIMIT	23
7.1.1 TEST PROCEDURE	23
7.1.2 DEVIATION FROM STANDARD	23
7.1.3 TEST SETUP	23
7.1.4 EUT TEST CONDITIONS	23
7.1.5 TEST RESULTS	23
8 . BANDWIDTH TEST	24
8.1 APPLIED PROCEDURES	24
8.1.1 TEST PROCEDURE	24
8.1.2 DEVIATION FROM STANDARD	24
8.1.3 TEST SETUP	24
8.1.4 EUT OPERATION CONDITIONS	24
8.1.5 EUT TEST CONDITIONS	24
8.1.6 TEST RESULTS	24
9 . MAXIMUM OUTPUT POWER TEST	25
9.1 APPLIED PROCEDURES / LIMIT	25
9.1.1 TEST PROCEDURE	25
9.1.2 DEVIATION FROM STANDARD	25
9.1.3 TEST SETUP	25
9.1.4 EUT OPERATION CONDITIONS	25
9.1.5 EUT TEST CONDITIONS	25
9.1.6 TEST RESULTS	25
10 . CONDUCTED SPURIOUS EMISSION	26
10.1 APPLIED PROCEDURES / LIMIT	26
10.1.1 TEST PROCEDURE	26
10.1.2 DEVIATION FROM STANDARD	26
10.1.3 TEST SETUP	26
10.1.4 EUT OPERATION CONDITIONS	26
10.1.5 EUT TEST CONDITIONS	26
10.1.6 TEST RESULTS	26
11 . MEASUREMENT INSTRUMENTS LIST	27
12 . EUT TEST PHOTO	29

Table of Contents**Page**

APPENDIX A - CONDUCTED EMISSION	33
APPENDIX B - RADIATED EMISSION (9KHZ-30MHZ)	36
APPENDIX C - RADIATED EMISSION (30MHZ TO 1000MHZ)	41
APPENDIX D - RADIATED EMISSION (ABOVE 1000MHZ)	48
APPENDIX E - NUMBER OF HOPPING CHANNEL	73
APPENDIX F - AVERAGE TIME OF OCCUPANCY	75
APPENDIX G - HOPPING CHANNEL SEPARATION MEASUREMENT	88
APPENDIX H - BANDWIDTH	93
APPENDIX I - MAXIMUM OUTPUT POWER	98
APPENDIX J - CONDUCTED SPURIOUS EMISSION	103

REPORT ISSUED HISTORY

Report Version	Description	Issued Date
R00	<p>Original Issue. This is a supplementary report to the original test report (BTL-FCCP-1-1602C038D). Based on the original report, this report has below changed:</p> <ol style="list-style-type: none"> 1. The applicant and manufacturer address are changed. 2. RF chip changed from BCM4354 to CYW4356. 3. The CYW4356 is based on the BCM4354 and is pin-to-pin compatible. Both chipset possess the same Wi-Fi RF features and performance. 4. The CYW4356 removed the FM section, which was not used in originally released product. 5. The CYW4356 is capable of supporting Bluetooth v5.0, however none of Bluetooth 5.0 features have been incorporated into this product update. <p>So the Maximum Output Power test item have been retested and recorded in this report. Other are kept the same.</p>	Jun. 11, 2019

1. GENERAL SUMMARY

Equipment : SHIELD Android TV Game Console
Brand Name : NVIDIA
Test Model : P2897
Series Model : N/A
Applicant : NVIDIA Corporation
Manufacturer : NVIDIA Corporation
Address : 2788 San Tomas Expressway, Santa Clara, California 95051, United States
Date of Test : Nov. 21, 2017 ~ Apr. 09, 2018
Oct. 30, 2018 ~ Mar. 18, 2019
Test Sample : Engineering Sample No.: D181009693
Standard(s) : FCC Part15, Subpart C (15.247)/ ANSI C63.10-2013

The above equipment has been tested and found compliance with the requirement of the relative standards by BTL Inc.

The test data, data evaluation, and equipment configuration contained in our test report (Ref No. BTL-FCCP-1-1602C038E) were obtained utilizing the test procedures, test instruments, test sites that has been accredited by the Authority of A2LA according to the ISO/IEC 17025 quality assessment standard and technical standard(s).

Test results included in this report are only for the Bluetooth EDR part.

2. SUMMARY OF TEST RESULTS

Test procedures according to the technical standard(s):

Applied Standard(s): FCC Part15, Subpart C (15.247)			
Standard(s) Section	Test Item	Judgment	Remark
15.207	Conducted Emission	PASS	
15.247(d)	Conducted Spurious Emission	PASS	
15.247(a)(1)	Hopping Channel Separation	PASS	
15.247(a)(1)	Bandwidth	PASS	
15.247(a)(1)	Maximum Output Power	PASS	
15.247(d) 15.205(a) 15.209(a)	Radiated Spurious Emission	PASS	
15.247(a)(1)(iii)	Number of Hopping Frequency	PASS	
15.203	Antenna Requirement	PASS	

Note:

(1) "N/A" denotes test is not applicable in this test report

2.1 TEST FACILITY

The test facilities used to collect the test data in this report is at the location of No.3, Jinshagang 1st Road, Shixia, Dalang Town, Dongguan, Guangdong, China.

BTL's Test Firm Registration Number for FCC: 357015

BTL's Designation Number for FCC: CN1240

2.2 MEASUREMENT UNCERTAINTY

The measurement uncertainty figures shall be calculated according the methods described in the ETSI TR 100 028 and shall correspond to an expansion factor (coverage factor) $k=1.96$ or $k=2$ (which provide confidence levels of respectively 90% and 95.45% in the case where the distributions characterizing the actual measurement uncertainties are normal (Gaussian)). Measurement Uncertainty for a Level of Confidence of 95 %, $U=2xUc(y)$.

The BTL measurement uncertainty as below table:

A. Conducted Measurement :

Test Site	Method	Measurement Frequency Range	U, (dB)
DG-C02	CISPR	150 KHz ~ 30MHz	2.32

B. Radiated Measurement :

Test Site	Method	Measurement Frequency Range	Ant. H / V	U, (dB)
DG-CB03	CISPR	9KHz~30MHz	V	3.79
		9KHz~30MHz	H	3.57
		30MHz ~ 200MHz	V	3.82
		30MHz ~ 200MHz	H	3.78
		200MHz ~ 1,000MHz	V	4.10
		200MHz ~ 1,000MHz	H	4.06
		1GHz~18GHz	V	3.12
		1GHz~18GHz	H	3.68
		18GHz~40GHz	V	4.15
		18GHz~40GHz	H	4.14

C. Other Measurement:

Test Item	Uncertainty
Conducted Spurious Emission	2.67dB
Hopping Channel Separation	53.46MHz
Peak Output Power	0.95dB
Number of Hopping Frequency	53.46MHz
Temperature	0.08°C
Humidity	1.5%

Note: Unless specifically mentioned, the uncertainty of measurement has not been taken into account to declare the compliance or non-compliance to the specification.

3. GENERAL INFORMATION

3.1 GENERAL DESCRIPTION OF EUT

Equipment	SHIELD Android TV Game Console	
Brand Name	NVIDIA	
Test Model	P2897	
Series Model	N/A	
Model Difference(s)	N/A	
Output Power (Max.)	Operation Frequency	2402 MHz ~ 2480 MHz
	Modulation Technology	GFSK(1Mbps) $\pi/4$ -DQPSK(2Mbps)
	Bit Rate of Transmitter	8-DPSK(3Mbps)
	Output Power Max.	8.98dBm(1Mbps) 7.77dBm(3Mbps)
Power Source	DC Voltage supplied from adapter. Manufacturer: FSP GROUP INC. Model: SPA040A19W2	
Power Rating	Adapter: Input: 100-240V~,1.2A,50-60Hz Output: 19.0V---2.1A EUT: Input: 19Vdc, 2.1A	

Note:

1. For a more detailed features description, please refer to the manufacturer's specifications or the user's manual.

2. Channel List:

Channel	Frequency (MHz)	Channel	Frequency (MHz)	Channel	Frequency (MHz)
00	2402	27	2429	54	2456
01	2403	28	2430	55	2457
02	2404	29	2431	56	2458
03	2405	30	2432	57	2459
04	2406	31	2433	58	2460
05	2407	32	2434	59	2461
06	2408	33	2435	60	2462
07	2409	34	2436	61	2463
08	2410	35	2437	62	2464
09	2411	36	2438	63	2465
10	2412	37	2439	64	2466
11	2413	38	2440	65	2467
12	2414	39	2441	66	2468
13	2415	40	2442	67	2469
14	2416	41	2443	68	2470
15	2417	42	2444	69	2471
16	2418	43	2445	70	2472
17	2419	44	2446	71	2473
18	2420	45	2447	72	2474
19	2421	46	2448	73	2475
20	2422	47	2449	74	2476
21	2423	48	2450	75	2477
22	2424	49	2451	76	2478
23	2425	50	2452	77	2479
24	2426	51	2453	78	2480
25	2427	52	2454		
26	2428	53	2455		

3. Table for Filed Antenna:

Ant.	Brand/Mfr.	Model Name	Antenna Type	Connector	Gain(dBi)
1	NVIDIA Corporation	N/A	Monopole Antenna	IPEX	2.70

3.2 DESCRIPTION OF TEST MODES

To investigate the maximum EMI emission characteristics generated from EUT, the test system was pre-scanning tested based on the consideration of following EUT operation mode or test configuration mode which possibly have effect on EMI emission level. Each of these EUT operation mode(s) or test configuration mode(s) mentioned above was evaluated respectively.

Pretest Mode	Description
Mode 1	TX Mode Note (1)

The EUT system operated these modes were found to be the worst case during the pre-scanning test as following:

For Conducted Emission	
Final Test Mode	Description
Mode 1	TX Mode

For Radiated Emission	
Final Test Mode	Description
Mode 1	TX Mode Note (1)

Note:

- (1) The measurements are performed at the high, middle, low available channels.
- (2) The measurements for Hopping Channel Separation, Bandwidth and Maximum Output Power were tested during 1Mbps, 2Mbps and 3Mbps, the worst case are 1Mbps and 3Mbps, only worst case was documented.

3.3 BLOCK DIAGRAM SHOWING THE CONFIGURATION OF SYSTEM TESTED

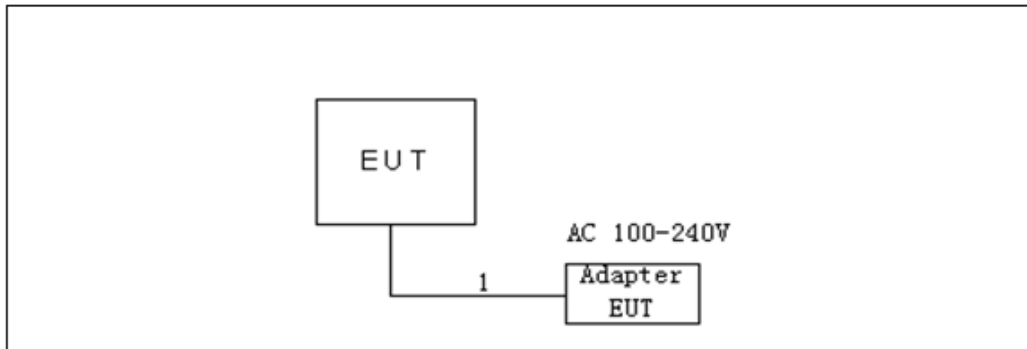

3.4 DESCRIPTION OF SUPPORT UNITS

The EUT has been tested as an independent unit together with other necessary accessories or support units. The following support units or accessories were used to form a representative test configuration during the tests.

Item	Equipment	Mfr/Brand	Model/Type No.	Series No.
-	-	-	-	-

Item	Shielded Type	Ferrite Core	Length	Note
1	NO	NO	1.8m	AC Cable

4. EMC EMISSION TEST

4.1 CONDUCTED EMISSION MEASUREMENT

4.1.1 POWER LINE CONDUCTED EMISSION LIMITS (Frequency Range 150KHz-30MHz)

Frequency of Emission (MHz)	Conducted Limit (dB μ V)	
	Quasi-peak	Average
0.15 -0.50	66 to 56*	56 to 46*
0.50 -5.0	56	46
5.0 -30.0	60	50

Note:

- (1) The limit of " * " decreases with the logarithm of the frequency
- (2) The test result calculated as following:
 Measurement Value = Reading Level + Correct Factor
 Correct Factor = Insertion Loss + Cable Loss + Attenuator Factor(if use)
 Margin Level = Measurement Value - Limit Value

The following table is the setting of the receiver

Receiver Parameters	Setting
Attenuation	10 dB
Start Frequency	0.15 MHz
Stop Frequency	30 MHz
IF Bandwidth	9 KHz

4.1.2 TEST PROCEDURE

- a. The EUT was placed 0.8 meters from the horizontal ground plane with EUT being connected to the power mains through a line impedance stabilization network (LISN). All other support equipment powered from additional LISN(s). The LISN provide 50 Ohm/ 50uH of coupling impedance for the measuring instrument.
- b. Interconnecting cables that hang closer than 40 cm to the ground plane shall be folded back and forth in the center forming a bundle 30 to 40 cm long.
- c. I/O cables that are not connected to a peripheral shall be bundled in the center. The end of the cable may be terminated, if required, using the correct terminating impedance. The overall length shall not exceed 1 m.
- d. LISN at least 80 cm from nearest part of EUT chassis.
- e. For the actual test configuration, please refer to the related Item –EUT Test Photos.

4.1.3 DEVIATION FROM TEST STANDARD

No deviation

4.1.4 TEST SETUP

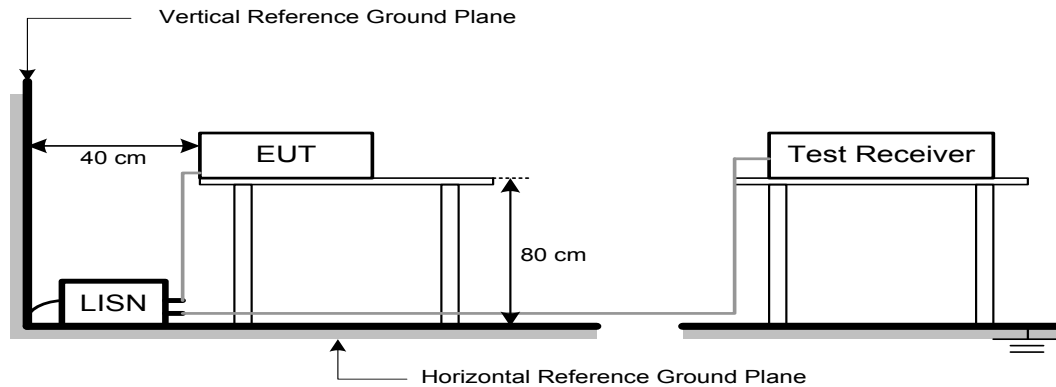

4.1.5 EUT OPERATING CONDITIONS

The EUT was configured for testing in a typical function (as a customer would normally use it), EUT was programmed to be in continuously transmitting/receiving data or hopping on mode.

4.1.6 EUT TEST CONDITIONS

Temperature: 25°C Relative Humidity: 55% Test Voltage: AC 120V/60Hz

4.1.7 TEST RESULTS

Please refer to the Appendix A.

Remark:

- (1) All readings are QP Mode value unless otherwise stated AVG in column of『Note』. If the QP Mode Measured value compliance with the QP Limits and lower than AVG Limits, the EUT shall be deemed to meet both QP & AVG Limits and then only QP Mode was measured, but AVG Mode didn't perform in this case, a "*" marked in AVG Mode column of Interference Voltage Measured.
- (2) Measuring frequency range from 150KHz to 30MHz.

4.2 RADIATED EMISSION MEASUREMENT

4.2.1 RADIATED EMISSION LIMITS (Frequency Range 9KHz -1000MHz)

In case the emission fall within the restricted band specified on 15.205(a), then the 15.209(a) limit in the table below has to be followed.

Frequency (MHz)	Field Strength (microvolts/meter)	Measurement Distance (meters)
0.009-0.490	2400/F(kHz)	300
0.490-1.705	24000/F(kHz)	30
1.705-30.0	30	30
30-88	100	3
88-216	150	3
216-960	200	3
Above 960	500	3

LIMITS OF RADIATED EMISSION MEASUREMENT (Above 1000MHz)

Frequency (MHz)	(dBuV/m) (at 3 meters)	
	PEAK	AVERAGE
Above 1000	74	54

Notes:

- (1) The limit for radiated test was performed according to FCC PART 15.
- (2) The tighter limit applies at the band edges.
- (3) Emission level (dBuV/m)=20log Emission level (uV/m).
- (4) The test result calculated as following:
 Measurement Value = Reading Level + Correct Factor
 Correct Factor = Antenna Factor + Cable Loss - Amplifier Gain(if use)
 Margin Level = Measurement Value - Limit Value

Spectrum Parameter	Setting
Attenuation	Auto
Start Frequency	1000 MHz
Stop Frequency	10th carrier harmonic
RBW / VBW (emission in restricted band)	1 MHz / 1 MHz for Peak, 1 MHz / 10Hz for Average

Spectrum Receiver Parameter	Setting
Attenuation	Auto
Start ~ Stop Frequency	9KHz ~90KHz for PK/AVG detector
Start ~ Stop Frequency	90KHz ~110KHz for QP detector
Start ~ Stop Frequency	110KHz ~490KHz for PK/AVG detector
Start ~ Stop Frequency	490KHz ~30MHz for QP detector
Start ~ Stop Frequency	30MHz~1000MHz for QP detector

4.2.2 TEST PROCEDURE

- a. The measuring distance of 3 m shall be used for measurements. The EUT was placed on the top of a rotating table 0.8 meter above the ground at a 3 meter semi-anechoic chamber. The table was rotated 360 degrees to determine the position of the highest radiation.(below 1GHz)
- b. The measuring distance of 3 m shall be used for measurements. The EUT was placed on the top of a rotating table 1.5 meter above the ground at a 3 meter semi-anechoic chamber. The table was rotated 360 degrees to determine the position of the highest radiation.(above 1GHz)
- c. The height of the equipment or of the substitution antenna shall be 0.8m or 1.5m; the height of the test antenna shall vary between 1 m to 4 m. Both horizontal and vertical polarizations of the antenna are set to make the measurement.
- d. For each suspected emission, the EUT was arranged to its worst case and then the antenna was tuned to heights find the maximum reading (used Bore sight function).
- e. The receiver system was set to peak and average detect function and specified bandwidth with maximum hold mode when the test frequency is above 1GHz.
- f. The initial step in collecting radiated emission data is a receiver peak detector mode pre-scanning the measurement frequency range. Significant peaks are then marked and then Quasi Peak detector mode re-measured.
- g. All readings are Peak unless otherwise stated QP in column of Note. Peak denotes that the Peak reading compliance with the QP Limits and then QP Mode measurement didn't perform. (below 1GHz)
- h. All readings are Peak Mode value unless otherwise stated AVG in column of Note. If the Peak Mode Measured value compliance with the Peak Limits and lower than AVG Limits, the EUT shall be deemed to meet both Peak & AVG Limits and then only Peak Mode was measured, but AVG Mode didn't perform. (above 1GHz)
- i. For the actual test configuration, please refer to the related Item –EUT Test Photos.

4.2.3 DEVIATION FROM TEST STANDARD

No deviation

4.2.4 TEST SETUP

(A) For Radiated Emissions Below 30MHz

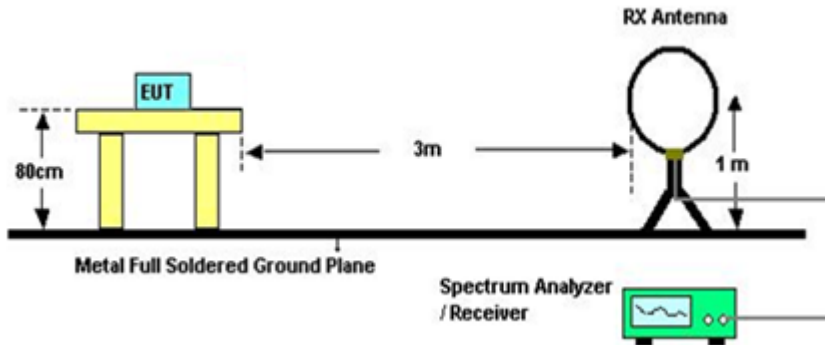

(B) Radiated Emission Test Set-Up Frequency Below 1 GHz

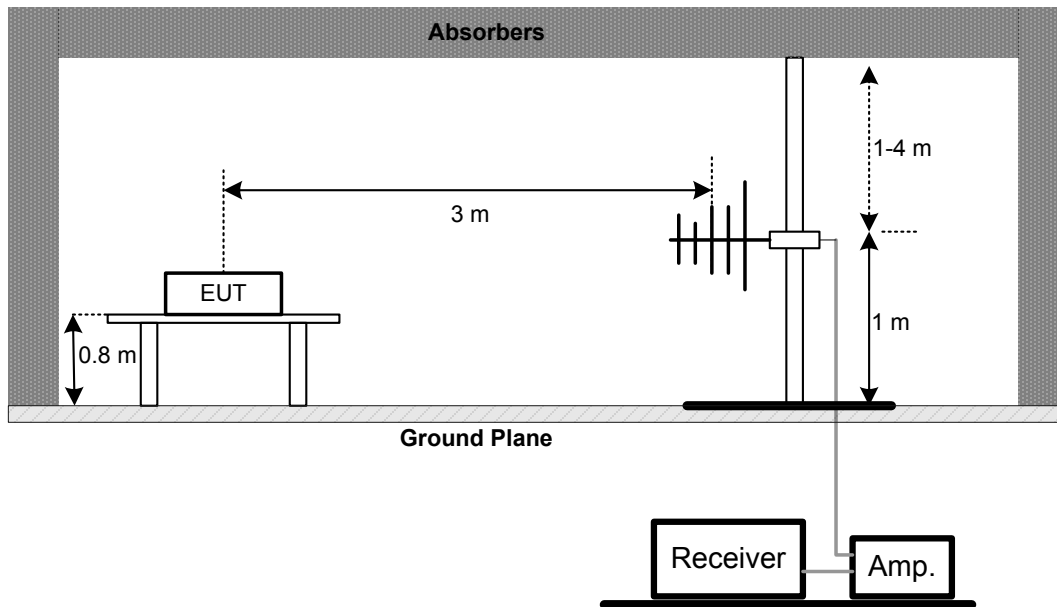

(C) Radiated Emission Test Set-Up Frequency Above 1 GHz

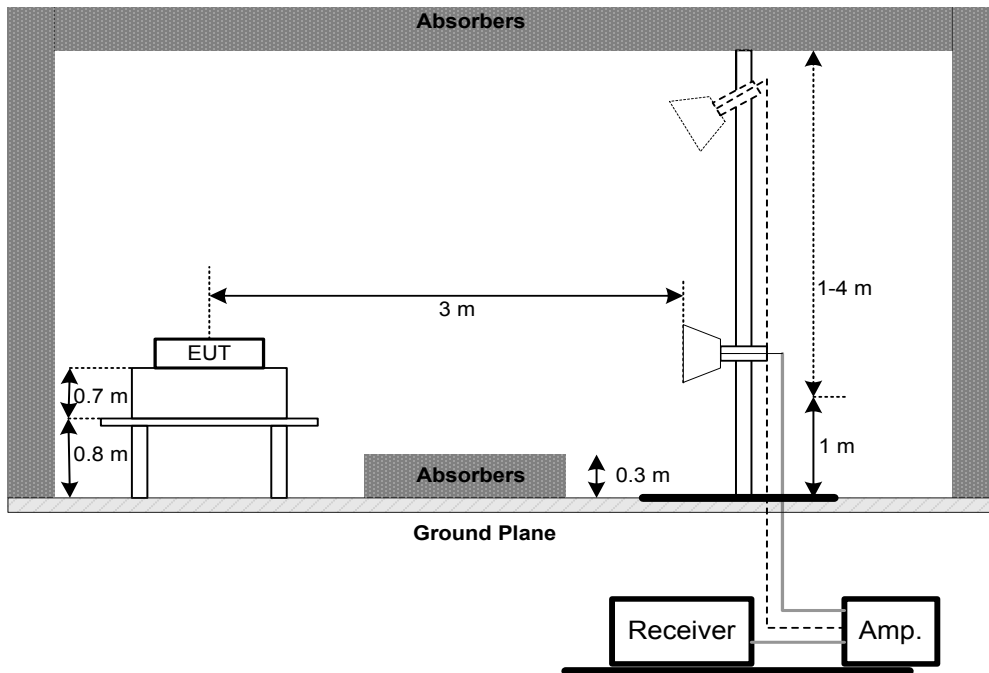

4.2.5 EUT OPERATING CONDITIONS

The EUT was programmed to be in continuously transmitting mode.

4.2.6 EUT TEST CONDITIONS

Temperature: 25°C Relative Humidity: 55% Test Voltage: AC 120V/60Hz

4.2.7 TEST RESULTS (9KHZ TO 30MHZ)

Please refer to the Appendix B

Remark:

- (1) The amplitude of spurious emissions which are attenuated by more than 20 dB below the permissible value has no need to be reported.
- (2) Distance extrapolation factor = $40 \log (\text{specific distance} / \text{test distance})$ (dB).
- (3) Limit line = specific limits (dBuV) + distance extrapolation factor.

4.2.8 TEST RESULTS (30MHZ TO 1000MHZ)

Please refer to the Appendix C.

4.2.9 TEST RESULTS (ABOVE 1000MHZ)

Please refer to the Appendix D.

Remark:

- (1) No limit: This is fundamental signal, the judgment is not applicable.
For fundamental signal judgment was referred to Peak output test.

5. NUMBER OF HOPPING CHANNEL

5.1 APPLIED PROCEDURES

FCC Part15 (15.247) , Subpart C			
Section	Test Item	Frequency Range (MHz)	Result
15.247(a)(1)(iii)	Number of Hopping Channel	2400-2483.5	PASS

Spectrum Parameters	Setting
Attenuation	Auto
Span Frequency	> Operating Frequency Range
RBW	100 KHz
VBW	100 KHz
Detector	Peak
Trace	Max Hold
Sweep Time	Auto

5.1.1 TEST PROCEDURE

- a. The EUT was directly connected to the spectrum analyzer and antenna output port as show in the block diagram below,
- b. Spectrum Setting: RBW=100KHz, VBW=100KHz, Sweep time = Auto.

5.1.2 DEVIATION FROM STANDARD

No deviation.

5.1.3 TEST SETUP

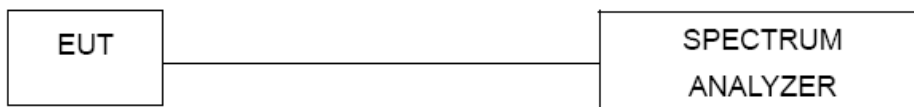

5.1.4 EUT OPERATION CONDITIONS

The EUT tested system was configured as the statements of 4.5 unless otherwise a special operating condition is specified in the follows during the testing.

5.1.5 EUT TEST CONDITIONS

Temperature: 25°C Relative Humidity: 55% Test Voltage: AC 120V/60Hz

5.1.6 TEST RESULTS

Please refer to the Appendix E

6. AVERAGE TIME OF OCCUPANCY

6.1 APPLIED PROCEDURES / LIMIT

FCC Part15 (15.247) , Subpart C				
Section	Test Item	Limit	Frequency Range (MHz)	Result
15.247(a)(1)(iii)	Average Time of Occupancy	0.4sec	2400-2483.5	PASS

6.1.1 TEST PROCEDURE

- a. The transmitter output (antenna port) was connected to the spectrum analyzer
- b. Set RBW of spectrum analyzer to 1MHz and VBW to 1MHz.
- c. Use a video trigger with the trigger level set to enable triggering only on full pulses.
- d. Sweep Time is more than once pulse time.
- e. Set the center frequency on any frequency would be measure and set the frequency span to zero span.
- f. Measure the maximum time duration of one single pulse.
- g. Set the EUT for DH5, DH3 and DH1 packet transmitting.
- h. Measure the maximum time duration of one single pulse.
 - i. DH5 Packet permit maximum $1600 / 79 / 6 = 3.37$ hops per second in each channel (5 time slots TX, 1 time slot RX). So, the dwell time is the time duration of the pulse times $3.37 \times 31.6 = 106.6$ within 31.6 seconds.
 - j. DH3 Packet permit maximum $1600 / 79 / 4 = 5.06$ hops per second in each channel (3 time slots TX, 1 time slot RX). So, the dwell time is the time duration of the pulse times $5.06 \times 31.6 = 160$ within 31.6 seconds.
 - k. DH1 Packet permit maximum $1600 / 79 / 2 = 10.12$ hops per second in each channel (1 time slot TX, 1 time slot RX). So, the dwell time is the time duration of the pulse times $10.12 \times 31.6 = 320$ within 31.6 seconds.

6.1.2 DEVIATION FROM STANDARD

No deviation.

6.1.3 TEST SETUP

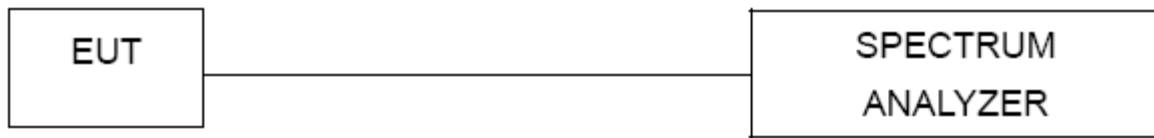

6.1.4 EUT OPERATION CONDITIONS

The EUT tested system was configured as the statements of 4.5 unless otherwise a special operating condition is specified in the follows during the testing.

6.1.5 EUT TEST CONDITIONS

Temperature: 25°C Relative Humidity: 55% Test Voltage: AC 120V/60Hz

6.1.6 TEST RESULTS

Please refer to the Appendix F

7. HOPPING CHANNEL SEPARATION MEASUREMENT

7.1 APPLIED PROCEDURES / LIMIT

Frequency hopping systems operating in the 2400-2483.5 MHz band may have hopping channel carrier frequencies that are separated by 25 KHz or two-thirds of the 20 dB bandwidth of the hopping channel, whichever is greater.

Spectrum Parameter	Setting
Attenuation	Auto
Span Frequency	> Measurement Bandwidth or Channel Separation
RBW	30 KHz
VBW	100 KHz
Detector	Peak
Trace	Max Hold
Sweep Time	Auto

7.1.1 TEST PROCEDURE

- a. The EUT must have its hopping function enabled
- b. Span = wide enough to capture the peaks of two adjacent channels
 - Resolution (or IF) Bandwidth (RBW) \geq 1% of the span
 - Video (or Average) Bandwidth (VBW) \geq RBW
 - Sweep = Auto
 - Detector function = Peak
 - Trace = Max Hold

7.1.2 DEVIATION FROM STANDARD

No deviation.

7.1.3 TEST SETUP



7.1.4 EUT TEST CONDITIONS

Temperature: 25°C Relative Humidity: 55% Test Voltage: AC 120V/60Hz

7.1.5 TEST RESULTS

Please refer to the Appendix G

8. BANDWIDTH TEST

8.1 APPLIED PROCEDURES

FCC Part15 (15.247) , Subpart C		
Section	Test Item	Frequency Range (MHz)
15.247(a)(1)	Bandwidth	2400-2483.5

Spectrum Parameter	Setting
Attenuation	Auto
Span Frequency	> Measurement Bandwidth or Channel Separation
RBW	30 KHz (20dB Bandwidth) / 30 KHz (Channel Separation)
VBW	100 KHz (20dB Bandwidth) / 100 KHz (Channel Separation)
Detector	Peak
Trace	Max Hold
Sweep Time	Auto

8.1.1 TEST PROCEDURE

- a. The EUT was directly connected to the spectrum analyzer and antenna output port as show in the block diagram below,
- b. Spectrum Setting: RBW= 30KHz, VBW=100KHz, Sweep Time = Auto.

8.1.2 DEVIATION FROM STANDARD

No deviation.

8.1.3 TEST SETUP



8.1.4 EUT OPERATION CONDITIONS

The EUT tested system was configured as the statements of 4.5 unless otherwise a special operating condition is specified in the follows during the testing.

8.1.5 EUT TEST CONDITIONS

Temperature: 25°C Relative Humidity: 55% Test Voltage: AC 120V/60Hz

8.1.6 TEST RESULTS

Please refer to the Appendix H

9. MAXIMUM OUTPUT POWER TEST

9.1 APPLIED PROCEDURES / LIMIT

FCC Part15 (15.247) , Subpart C				
Section	Test Item	Limit	Frequency Range (MHz)	Result
15.247(a)(1)	Maximum Output Power	0.125Watt or 21dBm	2400-2483.5	PASS

Note: Frequency hopping systems shall have hopping channel carrier frequencies separated by a minimum of 25 kHz or the 20 dB bandwidth of the hopping channel, whichever is greater. Alternatively, frequency hopping systems operating in the 2400-2483.5 MHz band may have hopping channel carrier frequencies that are separated by 25 kHz or two-thirds of the 20 dB bandwidth of the hopping channel, whichever is greater, provided the systems operate with an output power no greater than 125 mW.

9.1.1 TEST PROCEDURE

- a. The EUT was directly connected to the spectrum analyzer and antenna output port as show in the block diagram below,
- b. Spectrum Setting: RBW= 1MHz/3MHz, VBW= 1MHz/3MHz, Sweep time = Auto.

9.1.2 DEVIATION FROM STANDARD

No deviation.

9.1.3 TEST SETUP

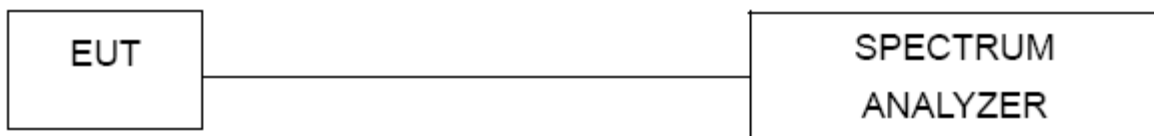

9.1.4 EUT OPERATION CONDITIONS

The EUT tested system was configured as the statements of 4.5 unless otherwise a special operating condition is specified in the follows during the testing.

9.1.5 EUT TEST CONDITIONS

Temperature: 25°C Relative Humidity: 55% Test Voltage: AC 120V/60Hz

9.1.6 TEST RESULTS

Please refer to the Appendix I

10. CONDUCTED SPURIOUS EMISSION

10.1 APPLIED PROCEDURES / LIMIT

In any 100 kHz bandwidth outside the frequency band in which the spread spectrum or digitally modulated intentional radiator is operating, the radio frequency power that is produced by the intentional radiator shall be at least 20 dB below that in the 100 kHz bandwidth within the band that contains the highest level of the desired power, based on either an RF conducted or a radiated measurement, provided the transmitter demonstrates compliance with the peak Output Power limits. If the transmitter complies with the Output Power limits based on the use of RMS averaging over a time interval, as permitted under paragraph (b)(3) of this section, the attenuation required under this paragraph shall be 30 dB instead of 20 dB. Attenuation below the general limits specified in Section 15.209(a) is not required. In addition, radiated emissions which fall in the restricted bands, as defined in Section 15.205(a), must also comply with the radiated emission limits specified in Section 15.209(a) (see Section 15.205(c)).

10.1.1 TEST PROCEDURE

- a. The EUT was directly connected to the spectrum analyzer and antenna output port as show in the block diagram below,
- b. Spectrum Setting: RBW= 100KHz, VBW=100KHz, Sweep time = Auto.

10.1.2 DEVIATION FROM STANDARD

No deviation.

10.1.3 TEST SETUP



10.1.4 EUT OPERATION CONDITIONS

The EUT tested system was configured as the statements of 4.5 unless otherwise a special operating condition is specified in the follows during the testing.

10.1.5 EUT TEST CONDITIONS

Temperature: 25°C Relative Humidity: 55% Test Voltage: AC 120V/60Hz

10.1.6 TEST RESULTS

Please refer to the Appendix J

11. MEASUREMENT INSTRUMENTS LIST

Conducted Emission Measurement					
Item	Kind of Equipment	Manufacturer	Type No.	Serial No.	Calibrated until
1	EMI Test Receiver	R&S	ESCI	100382	Mar. 11, 2019
2	LISN	EMCO	3816/2	52765	Mar. 11, 2019
3	50Ω Terminator	SHX	TF2-3G-A	8122901	Mar. 11, 2019
4	TWO-LINE V-NETWORK	R&S	ENV216	101447	Mar. 11, 2019
5	Measurement Software	Farad	EZ-EMC Ver.NB-03A1-01	N/A	N/A
6	Cable	N/A	RG223	12m	Oct. 19, 2018

Radiated Emission Measurement - Below 1GHz					
Item	Kind of Equipment	Manufacturer	Type No.	Serial No.	Calibrated until
1	Antenna	Schwarbeck	VULB9160	9160-3232	Mar. 11, 2019
2	Amplifier	HP	8447D	2944A09673	Oct. 19, 2018
3	Receiver	Agilent	N9038A	MY52130039	Aug. 20, 2018
4	Cable	emci	LMR-400(30MHz-1 GHz)(8m+5m)	N/A	Jun. 26, 2018
5	Controller	CT	SC100	N/A	N/A
6	Controller	MF	MF-7802	MF780208416	N/A
7	Measurement Software	Farad	EZ-EMC Ver.NB-03A1-01	N/A	N/A
8	Antenna	EM	EM-6876-1	230	Feb. 07, 2019

Radiated Emission Measurement - Above 1GHz					
Item	Kind of Equipment	Manufacturer	Type No.	Serial No.	Calibrated until
1	Double Ridged Guide Antenna	ETS	3115	75789	Mar. 11, 2019
2	Broad-Band Horn Antenna	Schwarzbeck	BBHA 9170	9170319	Jun. 08, 2018
3	Amplifier	Agilent	8449B	3008A02274	Mar. 11, 2019
4	Microwave Preamplifier With Adaptor	EMC INSTRUMENT	EMC2654045	980039 & HA01	Mar. 11, 2019
5	Receiver	Agilent	N9038A	MY52130039	Aug. 20, 2018
6	Controller	CT	SC100	N/A	N/A
7	Controller	MF	MF-7802	MF780208416	N/A
8	Cable	emci	EMC104-SM-SM-1 2000(12m)	N/A	Jun. 26, 2018
9	Measurement Software	Farad	EZ-EMC Ver.NB-03A1-01	N/A	N/A

Number of Hopping Channel					
Item	Kind of Equipment	Manufacturer	Type No.	Serial No.	Calibrated until
1	Spectrum Analyzer	R&S	FSP40	100185	Aug. 20, 2018

Average Time of Occupancy					
Item	Kind of Equipment	Manufacturer	Type No.	Serial No.	Calibrated until
1	Spectrum Analyzer	R&S	FSP40	100185	Aug. 20, 2018

Hopping Channel Separation Measurement					
Item	Kind of Equipment	Manufacturer	Type No.	Serial No.	Calibrated until
1	Spectrum Analyzer	R&S	FSP40	100185	Aug. 20, 2018

Bandwidth					
Item	Kind of Equipment	Manufacturer	Type No.	Serial No.	Calibrated until
1	Spectrum Analyzer	R&S	FSP40	100185	Aug. 20, 2018

Maximum Output Power					
Item	Kind of Equipment	Manufacturer	Type No.	Serial No.	Calibrated until
1	Spectrum Analyzer	R&S	FSP40	100185	Aug. 11, 2019

Conducted Spurious Emission					
Item	Kind of Equipment	Manufacturer	Type No.	Serial No.	Calibrated until
1	Spectrum Analyzer	R&S	FSP40	100185	Aug. 20, 2018

Remark: "N/A" denotes no model name, serial no. or calibration specified.
 All calibration period of equipment list is one year.

APPENDIX A - CONDUCTED EMISSION

Test Mode: TX Mode

Line

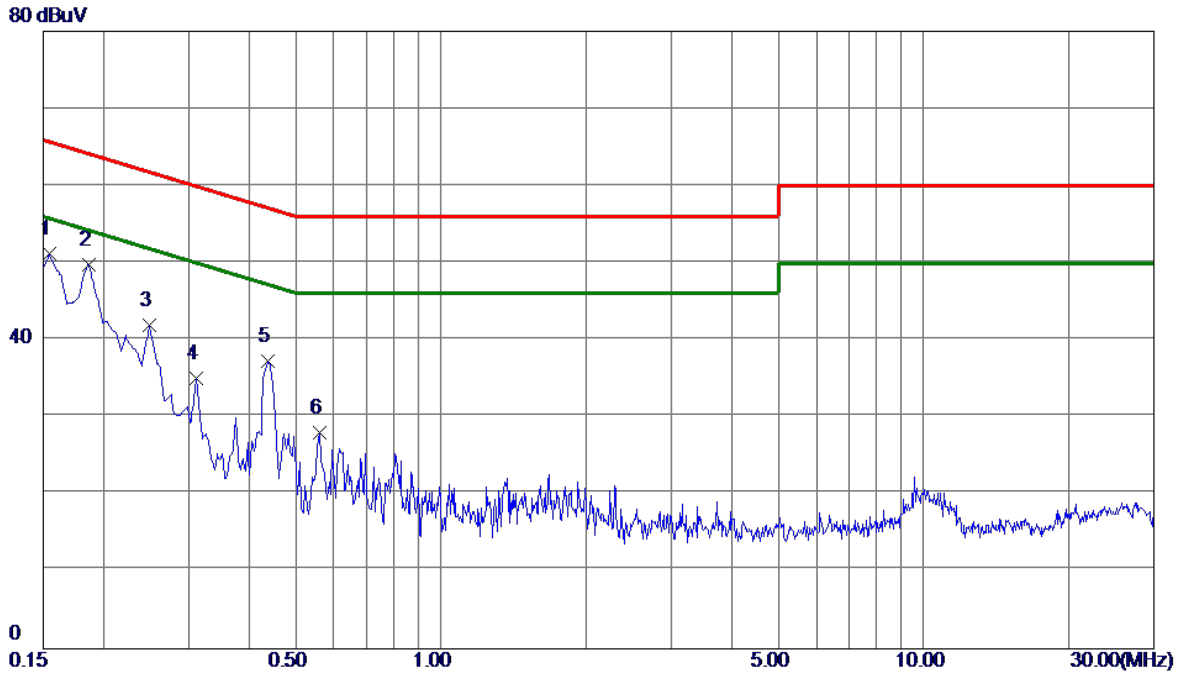

No.	Freq. MHz	Reading Level dBuV	Correct Factor dB	Measure ment dBuV	Limit dBuV	Margin dB	Detector	Comment
1	0.1545	41.48	9.75	51.23	65.75	-14.52	Peak	
2 *	0.1860	40.09	9.73	49.82	64.21	-14.39	Peak	
3	0.2490	32.26	9.72	41.98	61.79	-19.81	Peak	
4	0.3120	25.39	9.72	35.11	59.92	-24.81	Peak	
5	0.4380	27.53	9.75	37.28	57.10	-19.82	Peak	
6	0.5595	18.18	9.76	27.94	56.00	-28.06	Peak	

Test Mode: TX Mode

Neutral

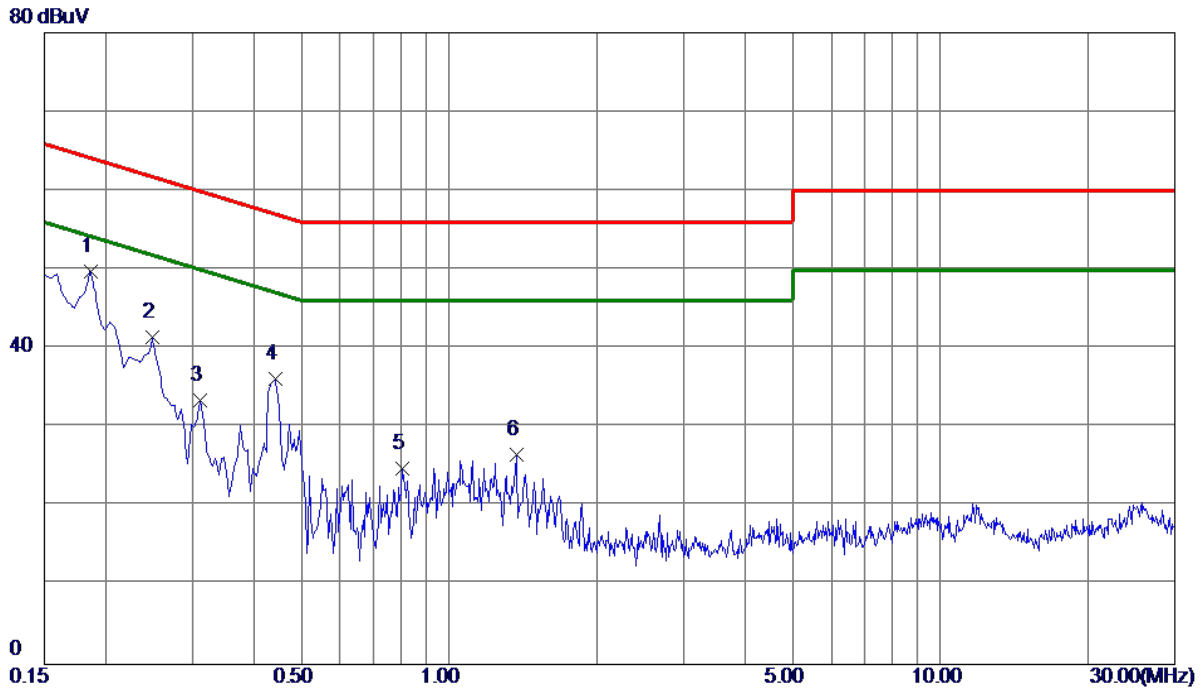

No.	Freq. MHz	Reading Level dBuV	Correct Factor dB	Measure ment dBuV	Limit dBuV	Margin dB	Detector	Comment
1 *	0.1860	40.14	9.65	49.79	64.21	-14.42	Peak	
2	0.2490	31.84	9.63	41.47	61.79	-20.32	Peak	
3	0.3120	23.81	9.64	33.45	59.92	-26.47	Peak	
4	0.4425	26.51	9.65	36.16	57.01	-20.85	Peak	
5	0.8025	15.08	9.66	24.74	56.00	-31.26	Peak	
6	1.3695	16.93	9.69	26.62	56.00	-29.38	Peak	

APPENDIX B - RADIATED EMISSION (9KHZ-30MHZ)

Test Mode: TX Mode

Ant 0°

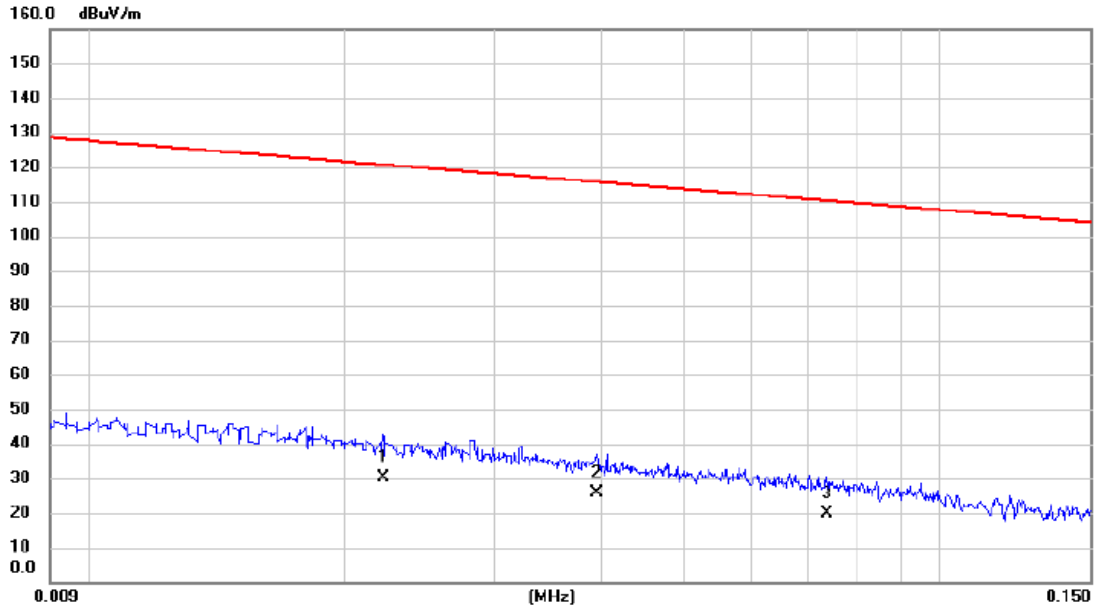

No.	Mk.	Freq. MHz	Reading Level dBuV	Correct Factor dB	Measure- ment dBuV/m	Limit dBuV/m	Margin dB	Detector	Comment
1		0.0222	30.10	0.02	30.12	120.68	-90.56	AVG	
2	*	0.0395	25.60	0.02	25.62	115.67	-90.05	AVG	
3		0.0736	19.60	0.03	19.63	110.27	-90.64	AVG	

Test Mode: TX Mode

Ant 0°

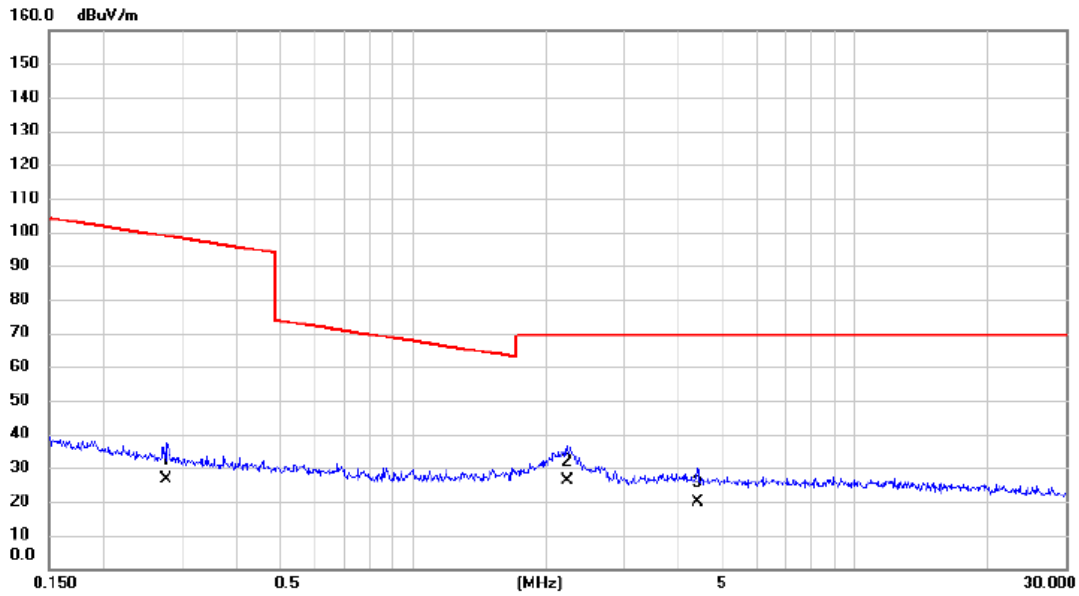

No.	Mk.	Freq. MHz	Reading Level dBuV	Correct Factor dB	Measure- ment dBuV/m	Limit dBuV/m	Margin dB	Detector	Comment
1		0.2773	26.50	0.06	26.56	98.75	-72.19	AVG	
2	*	2.2367	26.10	0.11	26.21	69.54	-43.33	QP	
3		4.4071	19.60	0.16	19.76	69.54	-49.78	QP	

Test Mode: TX Mode

Ant 90°

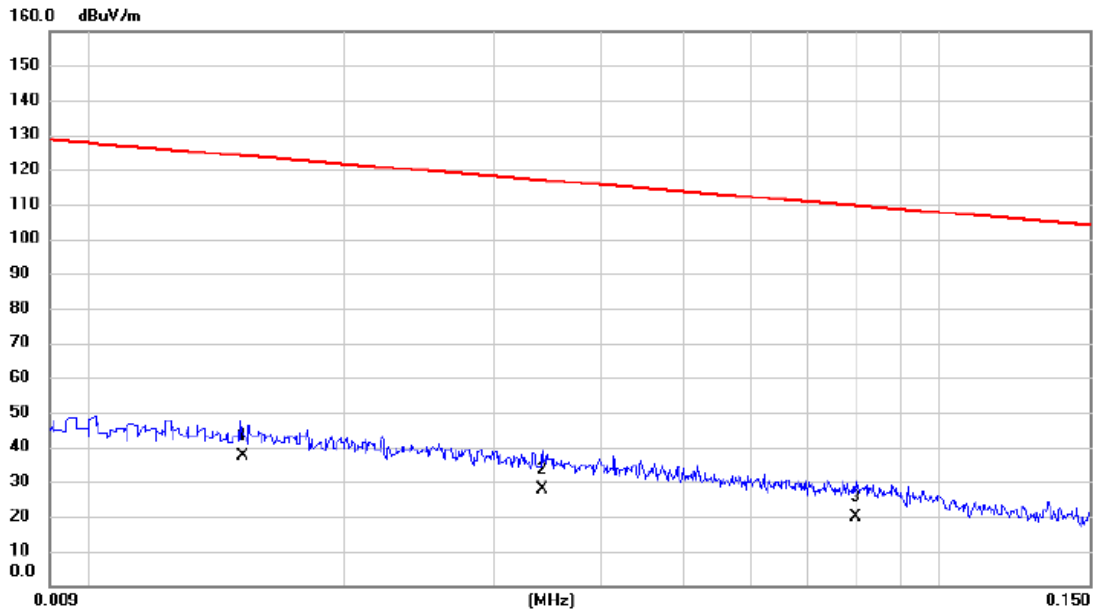

No.	Mk.	Freq. MHz	Reading Level dBuV	Correct Factor dB	Measure- ment dBuV/m	Limit dBuV/m	Margin dB	Detector	Comment
1	*	0.0152	37.50	0.02	37.52	123.97	-86.45	AVG	
2		0.0342	27.90	0.02	27.92	116.92	-89.00	AVG	
3		0.0796	19.60	0.03	19.63	109.59	-89.96	AVG	

Test Mode: TX Mode

Ant 90°

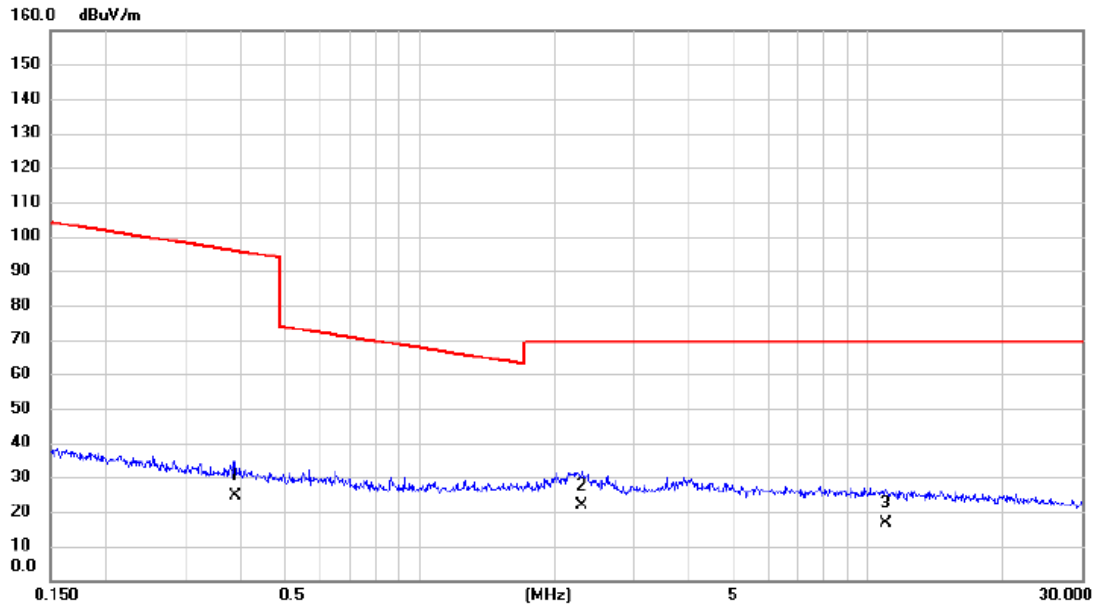

No.	Mk.	Freq. MHz	Reading Level dBuV	Correct Factor dB	Measure- ment dBuV/m	Limit dBuV/m	Margin dB	Detector	Comment
1		0.3871	24.50	0.06	24.56	95.85	-71.29	AVG	
2	*	2.2967	21.50	0.12	21.62	69.54	-47.92	QP	
3		10.9630	16.40	0.26	16.66	69.54	-52.88	QP	

APPENDIX C - RADIATED EMISSION (30MHZ TO 1000MHZ)

Test Mode: TX 2402MHz _CH00_1Mbps

Vertical

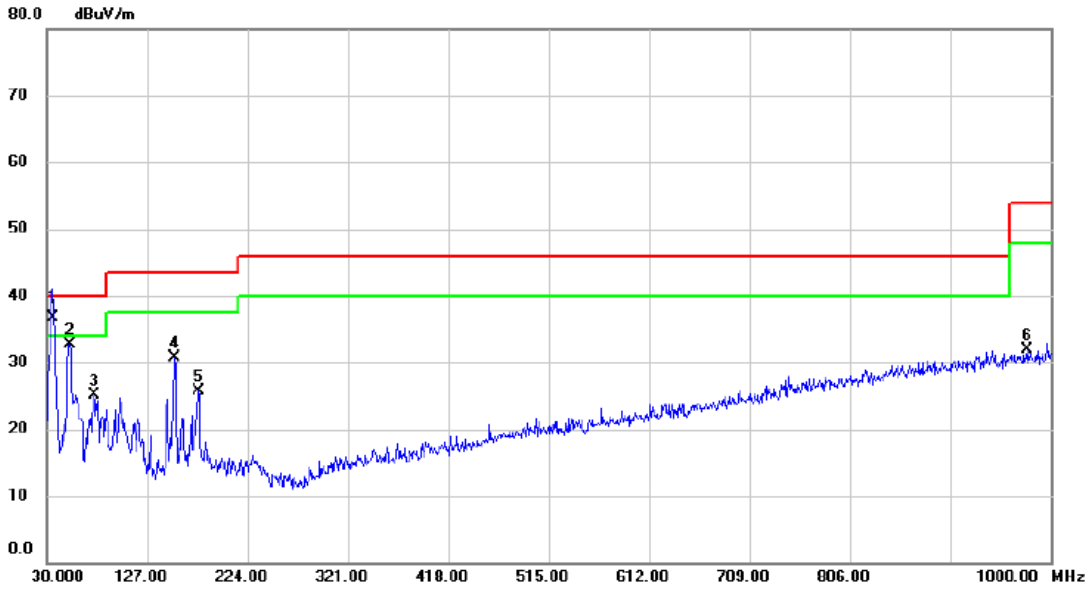

No.	Mk.	Freq. MHz	Reading Level dBuV	Correct Factor dB	Measure- ment dBuV/m	Limit dBuV/m	Margin dB	Detector	Comment
1	*	35.820	51.20	-14.51	36.69	40.00	-3.31	QP	
2		52.310	46.50	-13.79	32.71	40.00	-7.29	peak	
3		75.590	42.34	-17.22	25.12	40.00	-14.88	peak	
4		153.190	44.04	-13.33	30.71	43.50	-12.79	peak	
5		176.470	37.93	-12.14	25.79	43.50	-17.71	peak	
6		977.690	29.41	2.53	31.94	54.00	-22.06	peak	

Test Mode: TX 2402MHz _CH00_1Mbps

Horizontal

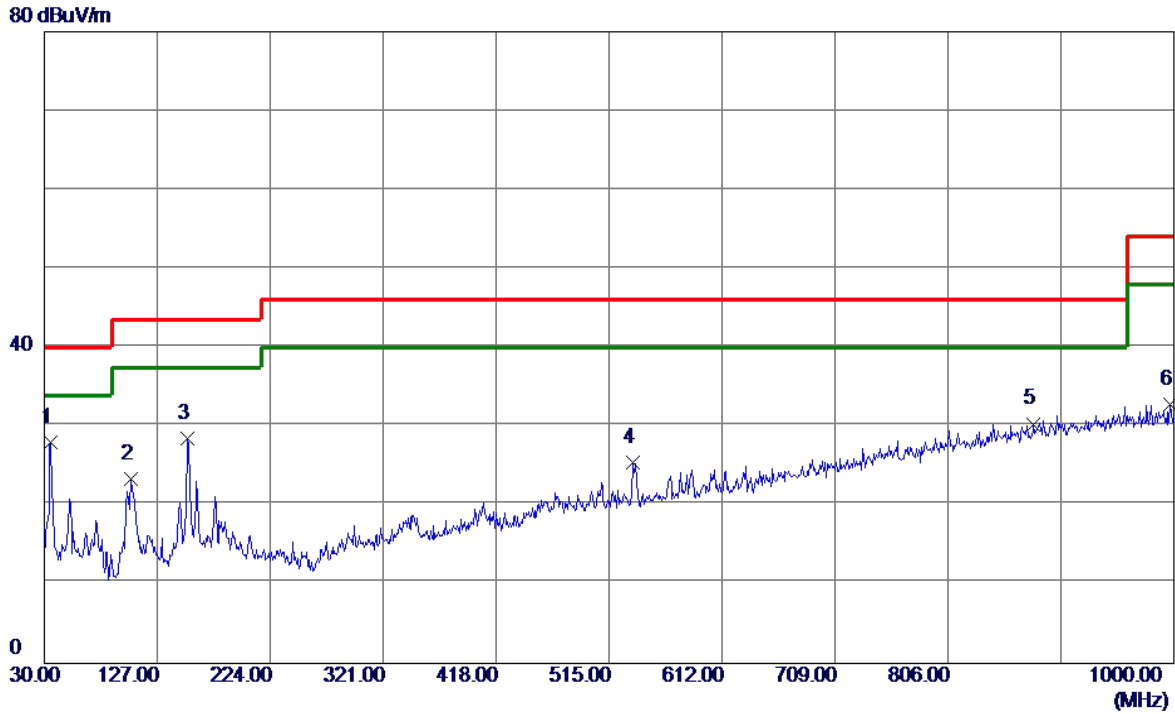

No.	Freq. MHz	Reading Level dBuV/m	Correct Factor dB	Measure ment dBuV/m	Limit dBuV/m	Margin dB	Detector	Comment
1 *	35.8200	42.48	-14.51	27.97	40.00	-12.03	Peak	
2	104.6900	40.21	-16.87	23.34	43.50	-20.16	Peak	
3	153.1900	41.80	-13.34	28.46	43.50	-15.04	Peak	
4	535.3700	33.52	-8.01	25.51	46.00	-20.49	Peak	
5	879.7200	29.71	0.61	30.32	46.00	-15.68	Peak	
6	997.0900	29.93	2.90	32.83	54.00	-21.17	Peak	

Test Mode: TX 2441MHz _CH39_1Mbps

Vertical

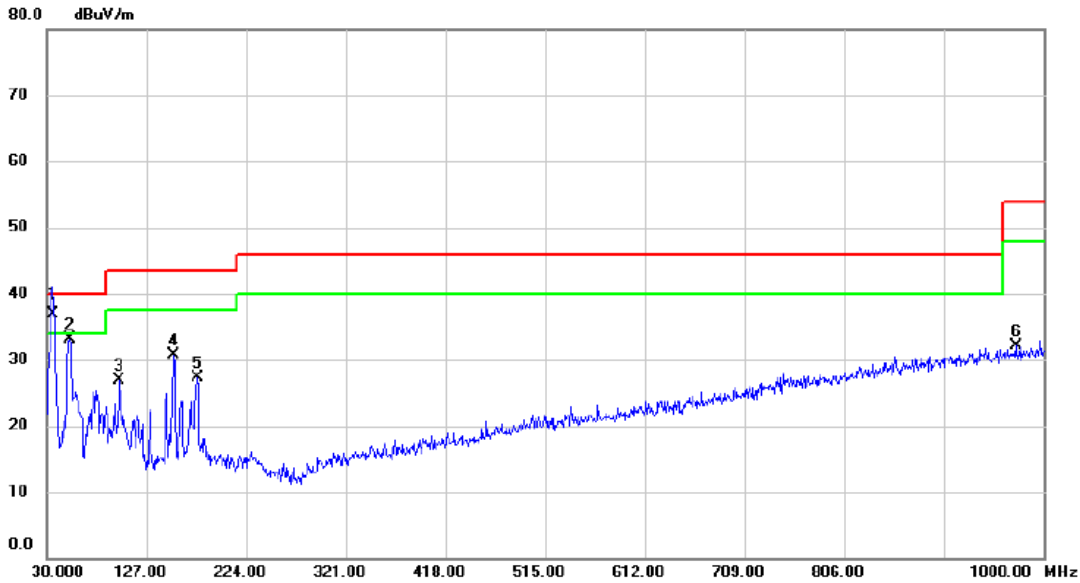

No.	Mk.	Freq. MHz	Reading Level dBuV	Correct Factor dB	Measure- ment dBuV/m	Limit dBuV/m	Margin dB	Detector	Comment
1	*	35.820	51.36	-14.51	36.85	40.00	-3.15	QP	
2		52.310	46.87	-13.79	33.08	40.00	-6.92	peak	
3		100.810	44.25	-17.38	26.87	43.50	-16.63	peak	
4		153.190	44.04	-13.33	30.71	43.50	-12.79	peak	
5		176.470	39.46	-12.14	27.32	43.50	-16.18	peak	
6		972.840	29.61	2.43	32.04	54.00	-21.96	peak	

Test Mode: TX 2441MHz _CH39_1Mbps

Horizontal

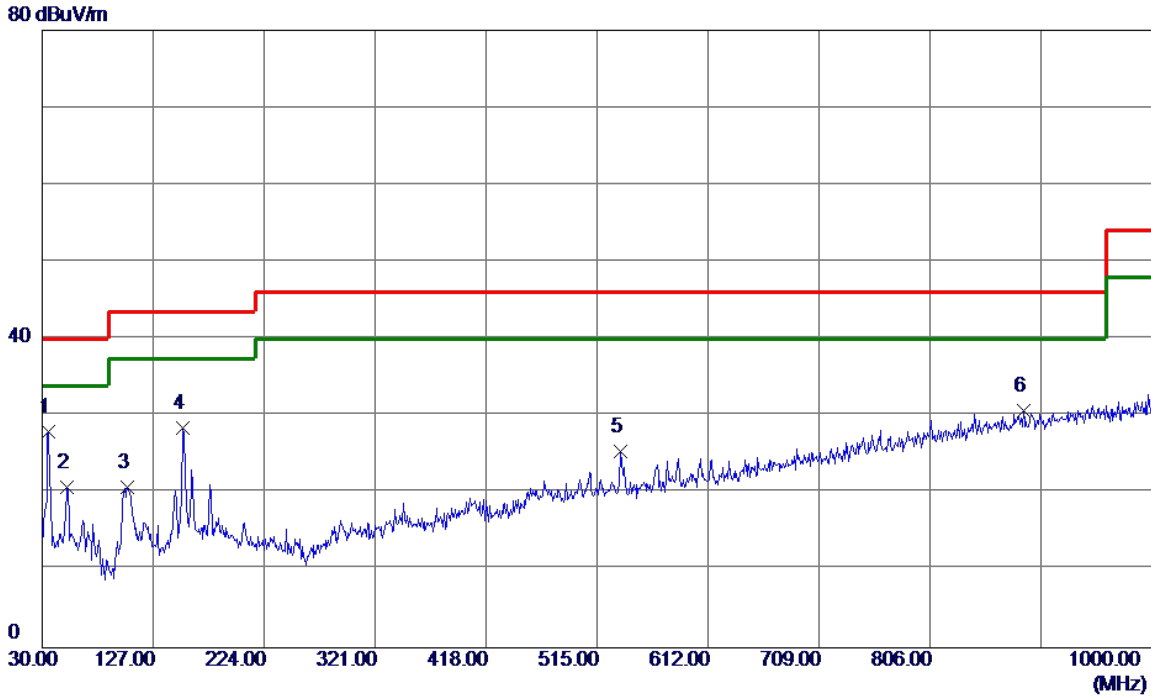

No.	Freq. MHz	Reading Level dBuV/m	Correct Factor dB	Measure ment dBuV/m	Limit dBuV/m	Margin dB	Detector	Comment
1 *	35.8200	42.48	-14.51	27.97	40.00	-12.03	Peak	
2	51.3400	34.51	-13.70	20.81	40.00	-19.19	Peak	
3	104.6900	37.73	-16.87	20.86	43.50	-22.64	Peak	
4	153.1900	41.80	-13.34	28.46	43.50	-15.04	Peak	
5	535.3700	33.52	-8.01	25.51	46.00	-20.49	Peak	
6	887.4800	29.93	0.77	30.70	46.00	-15.30	Peak	

Test Mode: TX 2480MHz _CH78_1Mbps

Vertical

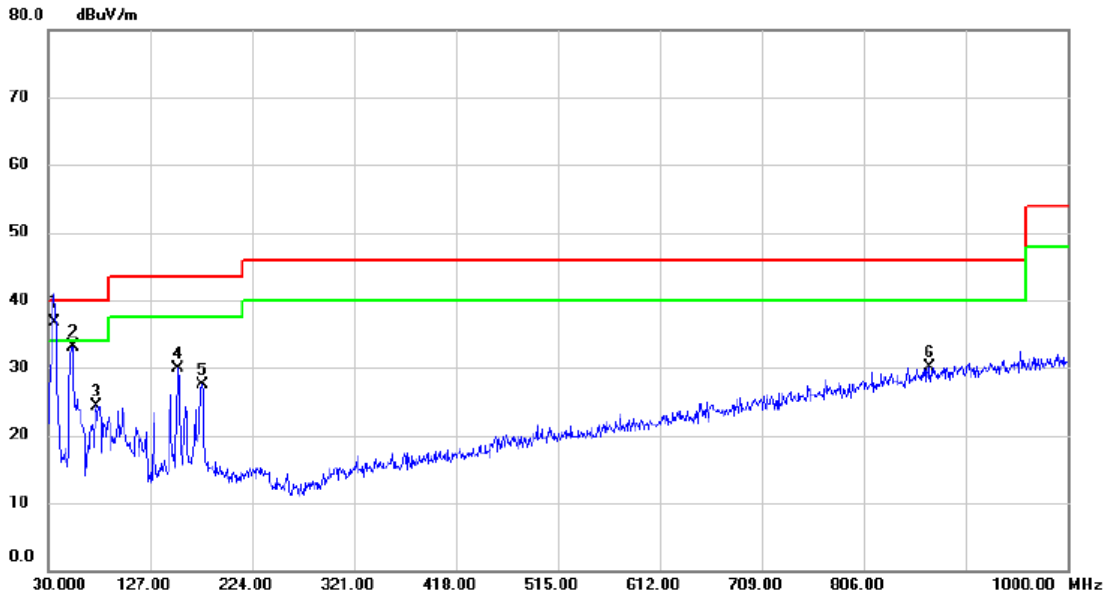

No.	Mk.	Freq. MHz	Reading Level dBuV	Correct Factor dB	Measure- ment dBuV/m	Limit dBuV/m	Margin dB	Detector	Comment
1	*	35.820	51.31	-14.51	36.80	40.00	-3.20	QP	
2		53.280	46.96	-13.88	33.08	40.00	-6.92	peak	
3		75.590	41.62	-17.22	24.40	40.00	-15.60	peak	
4		153.190	43.26	-13.33	29.93	43.50	-13.57	peak	
5		176.470	39.73	-12.14	27.59	43.50	-15.91	peak	
6		869.050	29.68	0.40	30.08	46.00	-15.92	peak	

Test Mode: TX 2480MHz _CH78_1Mbps

Horizontal

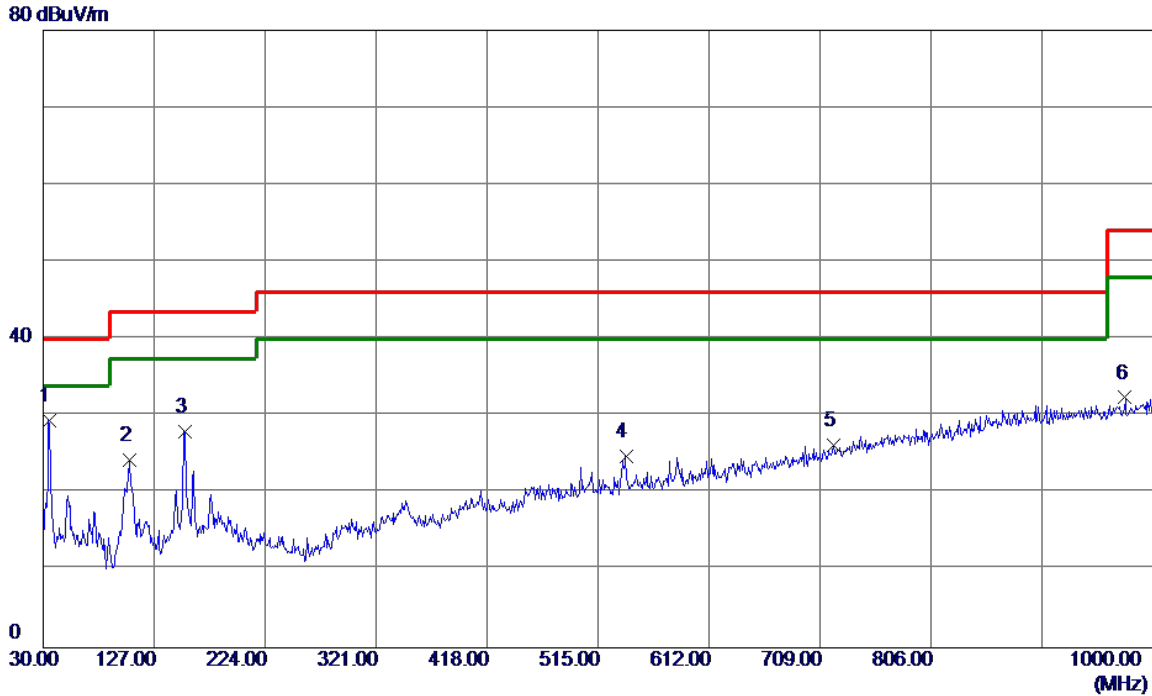

No.	Freq. MHz	Reading Level dBuV/m	Correct Factor dB	Measure ment dBuV/m	Limit dBuV/m	Margin dB	Detector	Comment
1 *	34.8500	44.08	-14.62	29.46	40.00	-10.54	Peak	
2	105.6600	41.12	-16.75	24.37	43.50	-19.13	Peak	
3	154.1600	41.27	-13.28	27.99	43.50	-15.51	Peak	
4	539.2500	32.78	-7.93	24.85	46.00	-21.15	Peak	
5	720.6400	29.50	-3.32	26.18	46.00	-19.82	Peak	
6	975.7500	29.91	2.49	32.40	54.00	-21.60	Peak	

APPENDIX D - RADIATED EMISSION (ABOVE 1000MHZ)

Test Mode : TX 2402MHz _CH00_1Mbps

Vertical

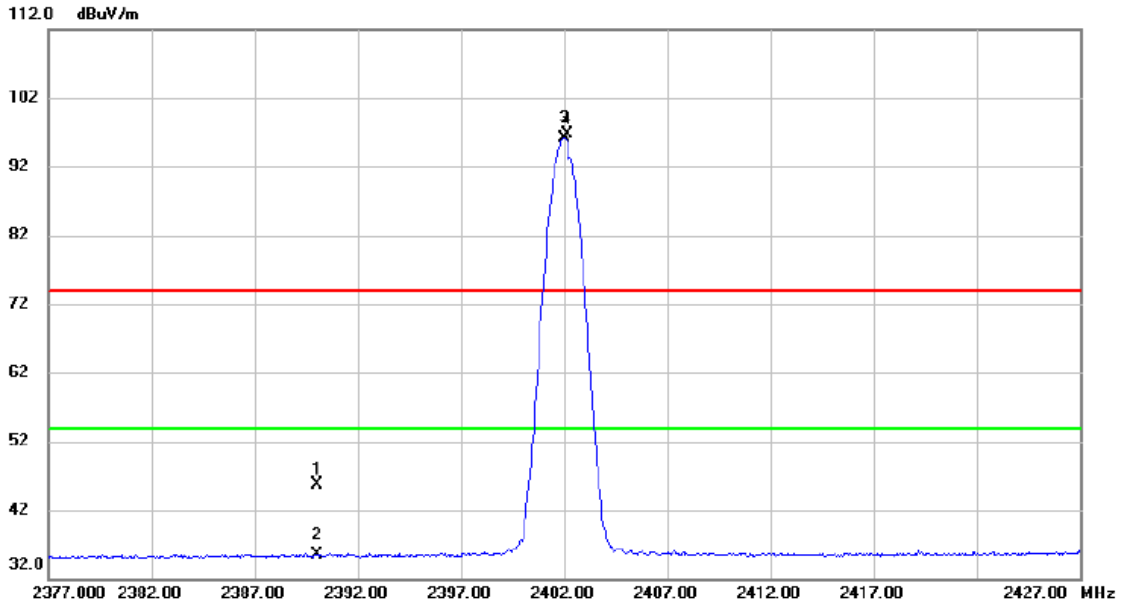

No.	Mk.	Freq. MHz	Reading Level dBuV	Correct Factor dB	Measure- ment dBuV/m	Limit dBuV/m	Margin dB	Detector	Comment
1		2390.000	36.14	9.54	45.68	74.00	-28.32	peak	
2		2390.000	26.02	9.54	35.56	54.00	-18.44	AVG	
3	*	2402.000	86.50	9.60	96.10	54.00	42.10	AVG	No Limit
4	X	2402.150	87.13	9.60	96.73	74.00	22.73	peak	No Limit

Test Mode : TX 2402MHz _CH00_ 1Mbps

Vertical

80 dBuV/m

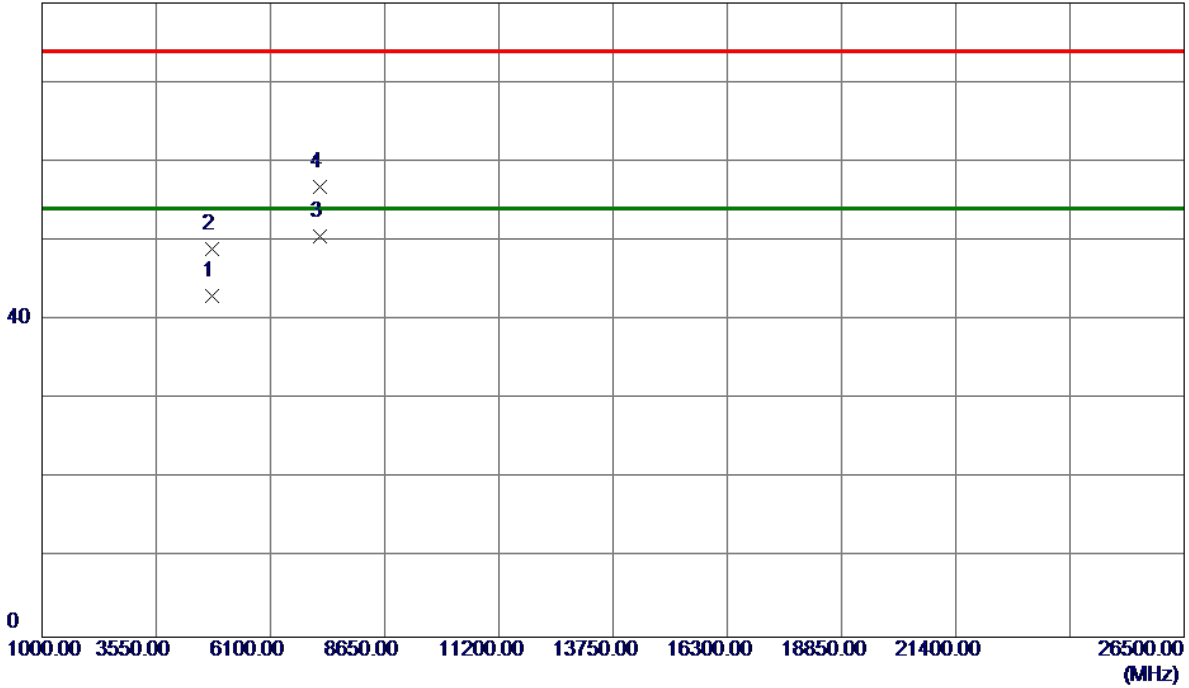

No.	Freq. MHz	Reading Level dBuV/m	Correct Factor dB	Measure ment dBuV/m	Limit dBuV/m	Margin dB	Detector	Comment
1	4804.0620	36.44	6.59	43.03	54.00	-10.97	AVG	
2	4804.3080	42.31	6.59	48.90	74.00	-25.10	Peak	
3 *	7205.9250	37.40	13.13	50.53	54.00	-3.47	AVG	
4	7206.3650	43.69	13.13	56.82	74.00	-17.18	Peak	

Test Mode : TX 2402MHz _CH00_ 1Mbps

Horizontal

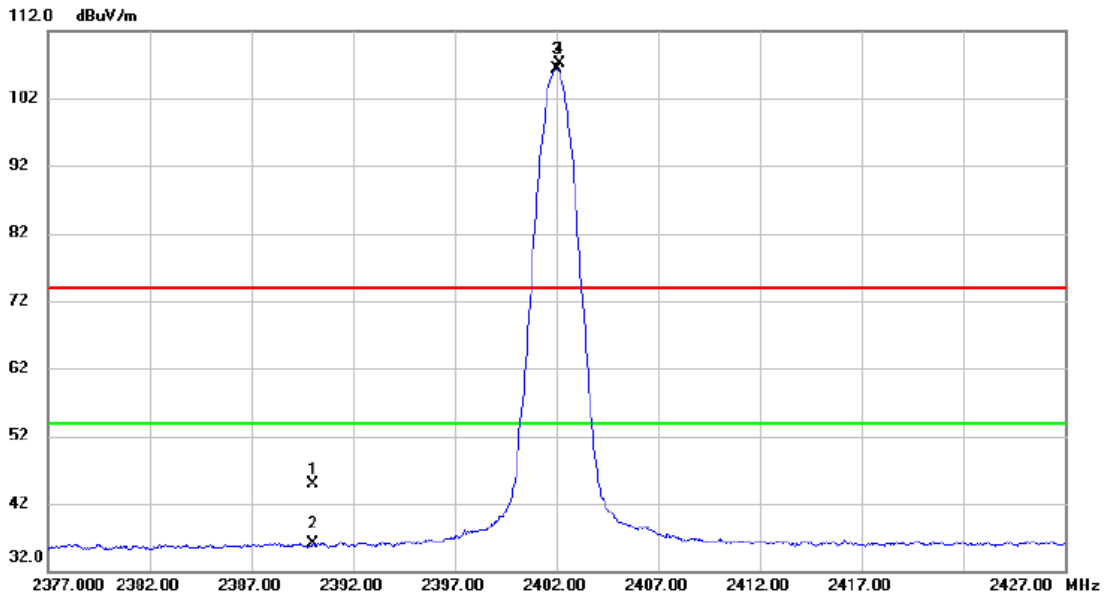

No.	Mk.	Freq. MHz	Reading Level dBuV	Correct Factor dB	Measure- ment dBuV/m	Limit dBuV/m	Margin dB	Detector	Comment
1		2390.000	35.46	9.54	45.00	74.00	-29.00	peak	
2		2390.000	26.49	9.54	36.03	54.00	-17.97	AVG	
3	*	2402.000	96.72	9.60	106.32	54.00	52.32	AVG	No Limit
4	X	2402.200	97.58	9.60	107.18	74.00	33.18	peak	No Limit

Test Mode : TX 2402MHz _CH00_ 1Mbps

Horizontal

80 dBuV/m

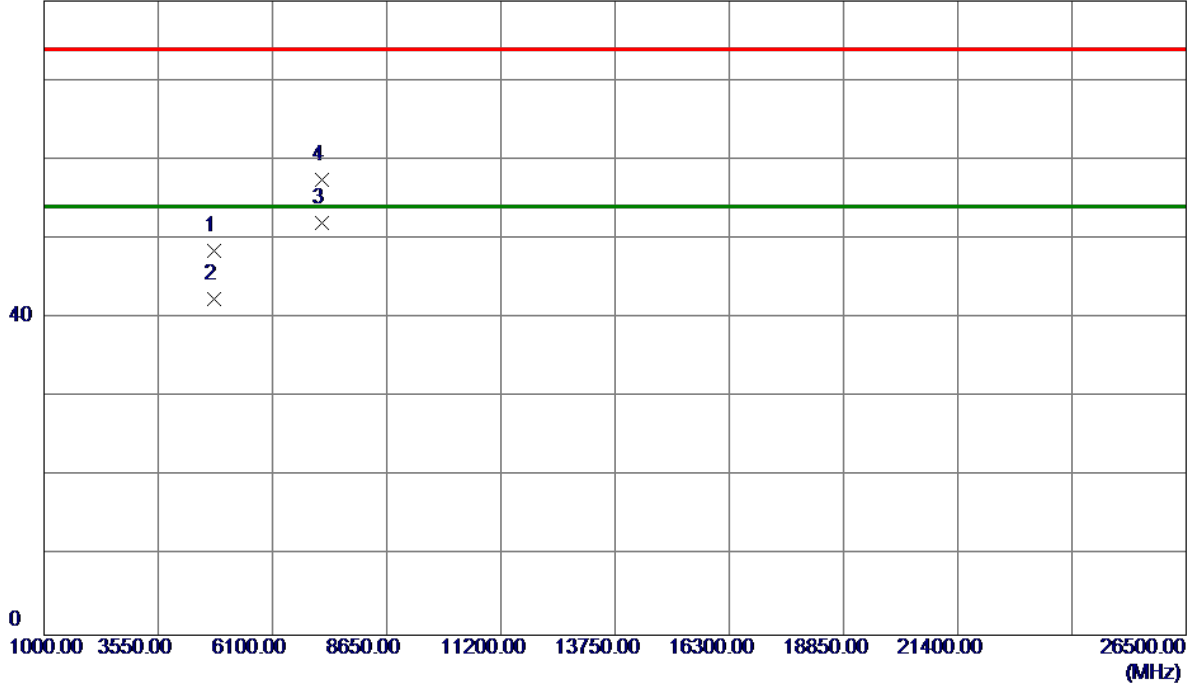

No.	Freq. MHz	Reading Level dBuV/m	Correct Factor dB	Measure ment dBuV/m	Limit dBuV/m	Margin dB	Detector	Comment
1	4803.7200	41.86	6.59	48.45	74.00	-25.55	Peak	
2	4804.0050	35.86	6.59	42.45	54.00	-11.55	AVG	
3 *	7206.0400	38.84	13.13	51.97	54.00	-2.03	AVG	
4	7206.4550	44.29	13.13	57.42	74.00	-16.58	Peak	

Test Mode : TX 2441MHz _CH39_1Mbps

Vertical

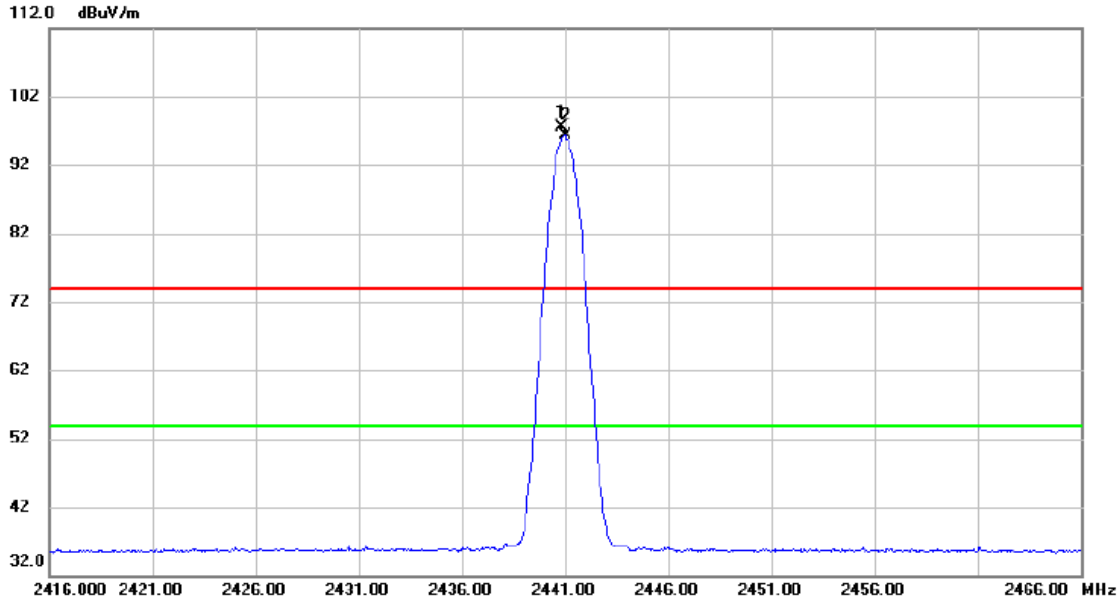

No.	Mk.	Freq. MHz	Reading Level dBuV	Correct Factor dB	Measure- ment dBuV/m	Limit dBuV/m	Margin dB	Detector	Comment
1	X	2440.850	87.77	9.72	97.49	74.00	23.49	peak	No Limit
2	*	2441.000	86.58	9.72	96.30	54.00	42.30	AVG	No Limit

Test Mode : TX 2441MHz _CH39_ 1Mbps

Vertical

80 dBuV/m

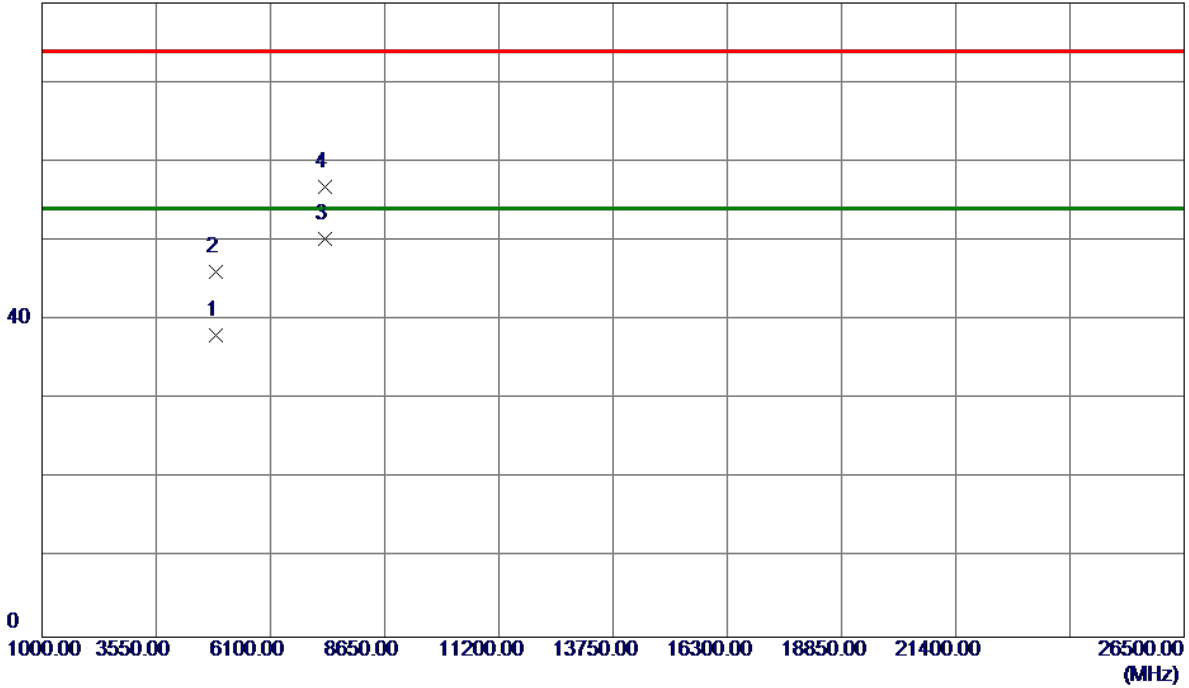

No.	Freq. MHz	Reading Level dBuV/m	Correct Factor dB	Measure ment dBuV/m	Limit dBuV/m	Margin dB	Detector	Comment
1	4881.9240	31.21	6.87	38.08	54.00	-15.92	AVG	
2	4882.4180	39.16	6.87	46.03	74.00	-27.97	Peak	
3 *	7322.8760	36.96	13.22	50.18	54.00	-3.82	AVG	
4	7323.3100	43.60	13.22	56.82	74.00	-17.18	Peak	

Test Mode : TX 2441MHz _CH39_ 1Mbps

Horizontal

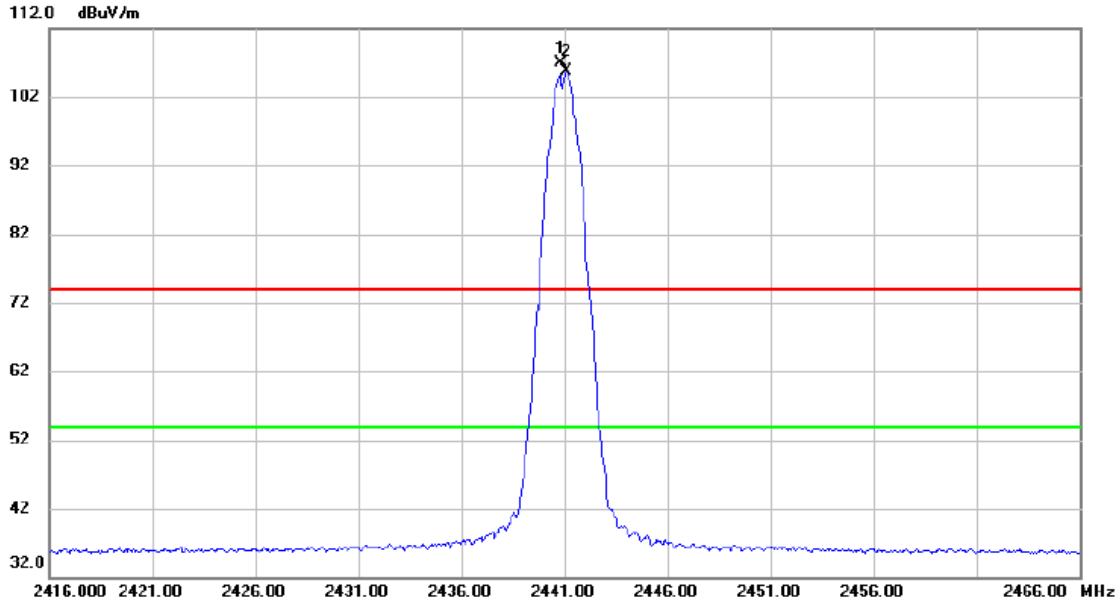

No.	Mk.	Freq. MHz	Reading Level dBuV	Correct Factor dB	Measure- ment dBuV/m	Limit dBuV/m	Margin dB	Detector	Comment
1	X	2440.850	97.14	9.72	106.86	74.00	32.86	peak	No Limit
2	*	2441.100	95.90	9.72	105.62	54.00	51.62	AVG	No Limit

Test Mode : TX 2441MHz _CH39_ 1Mbps

Horizontal

80 dBuV/m

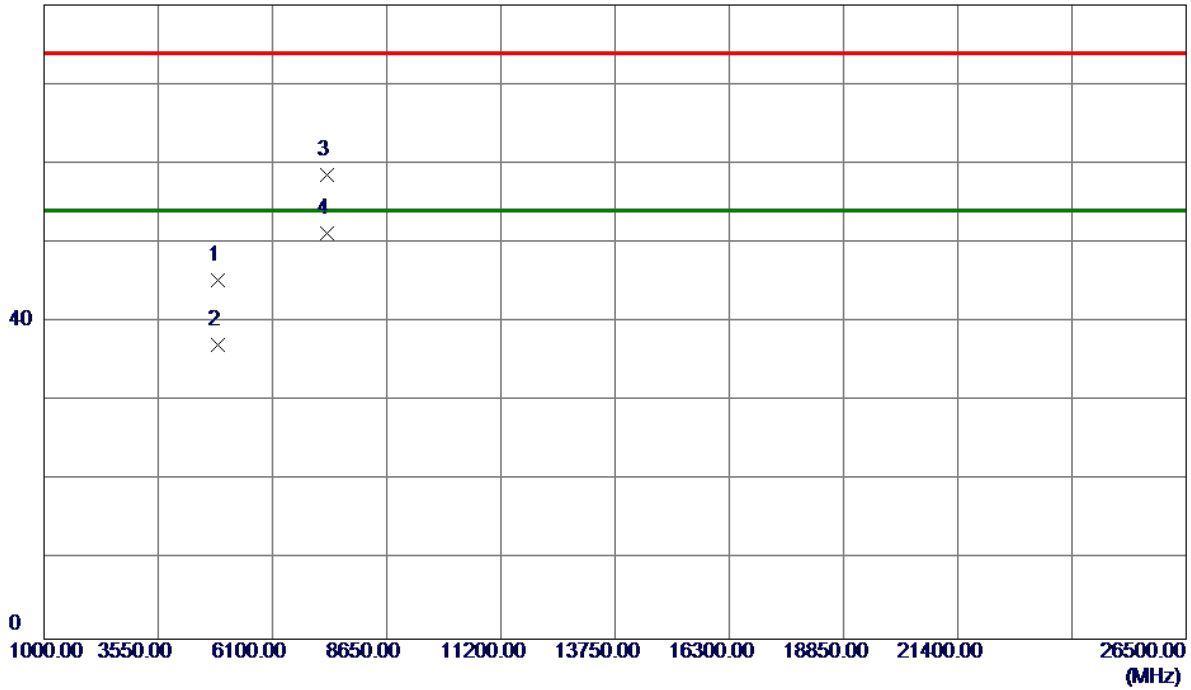

No.	Freq. MHz	Reading Level dBuV/m	Correct Factor dB	Measure ment dBuV/m	Limit dBuV/m	Margin dB	Detector	Comment
1	4881.8660	38.37	6.87	45.24	74.00	-28.76	Peak	
2	4881.9880	30.20	6.87	37.07	54.00	-16.93	AVG	
3	7322.5460	45.37	13.22	58.59	74.00	-15.41	Peak	
4 *	7322.9700	38.01	13.22	51.23	54.00	-2.77	AVG	

Test Mode : TX 2480MHz _CH78_1Mbps

Vertical

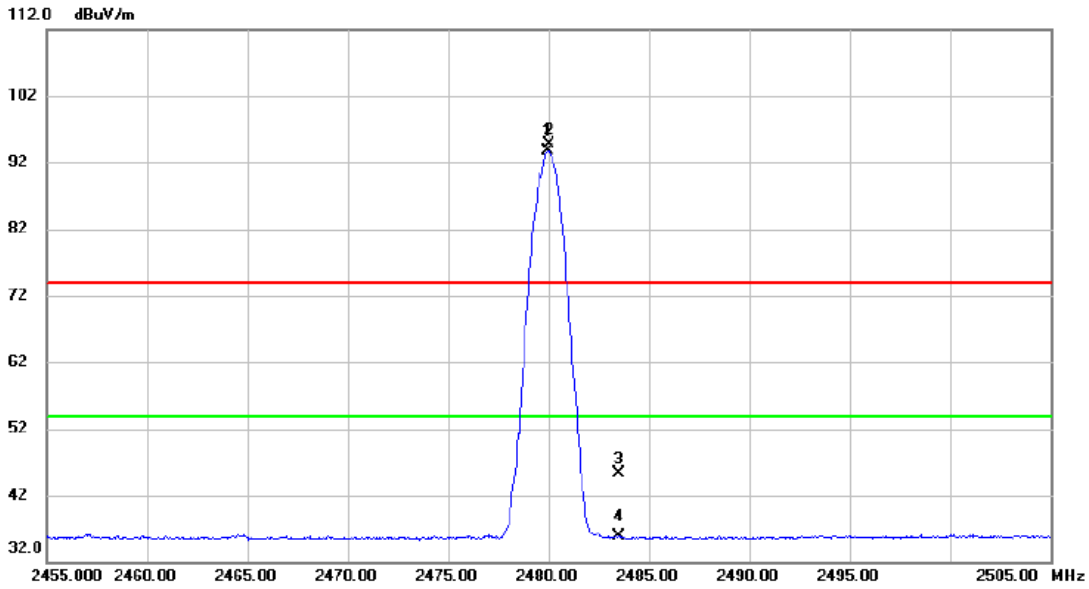

No.	Mk.	Freq. MHz	Reading Level dBuV	Correct Factor dB	Measure- ment dBuV/m	Limit dBuV/m	Margin dB	Detector	Comment
1	*	2479.950	83.84	9.85	93.69	54.00	39.69	AVG	No Limit
2	X	2480.000	84.83	9.85	94.68	74.00	20.68	peak	No Limit
3		2483.500	35.46	9.86	45.32	74.00	-28.68	peak	
4		2483.500	26.08	9.86	35.94	54.00	-18.06	AVG	

Test Mode : TX 2480MHz _CH78_ 1Mbps

Vertical

80 dBuV/m

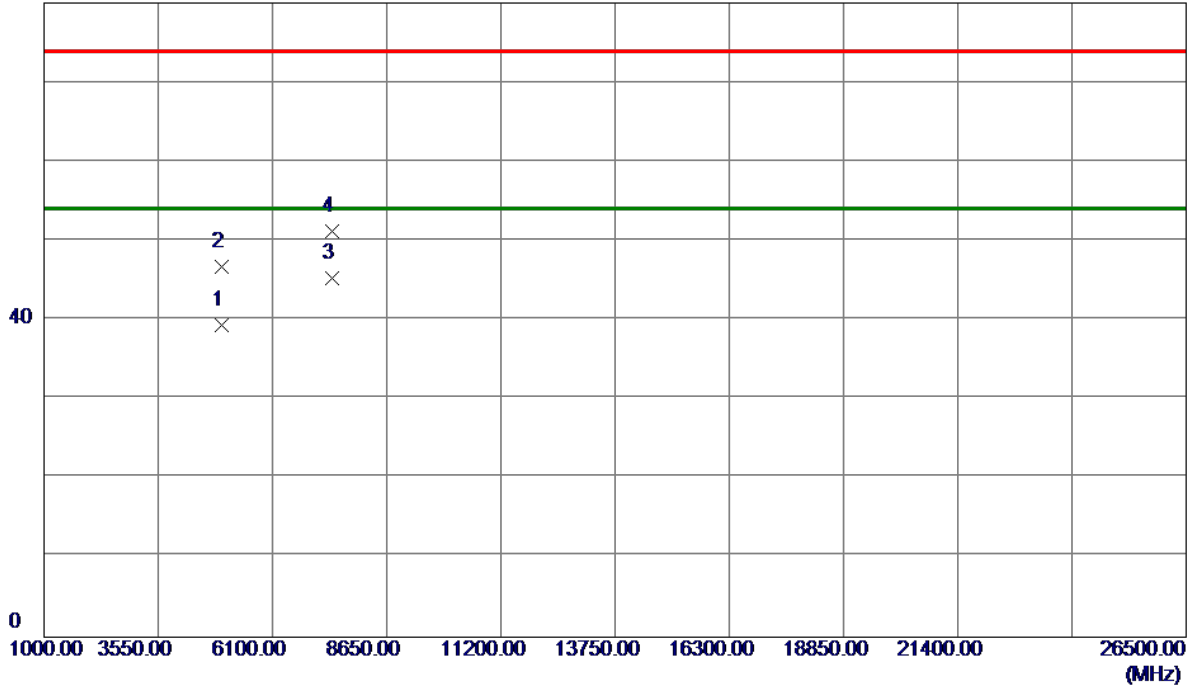

No.	Freq. MHz	Reading Level dBuV/m	Correct Factor dB	Measure ment dBuV/m	Limit dBuV/m	Margin dB	Detector	Comment
1	4959.9600	32.27	7.15	39.42	54.00	-14.58	AVG	
2	4960.0400	39.62	7.15	46.77	74.00	-27.23	Peak	
3 *	7439.8620	31.92	13.31	45.23	54.00	-8.77	AVG	
4	7440.4700	37.89	13.31	51.20	74.00	-22.80	Peak	

Test Mode : TX 2480MHz _CH78_ 1Mbps

Horizontal

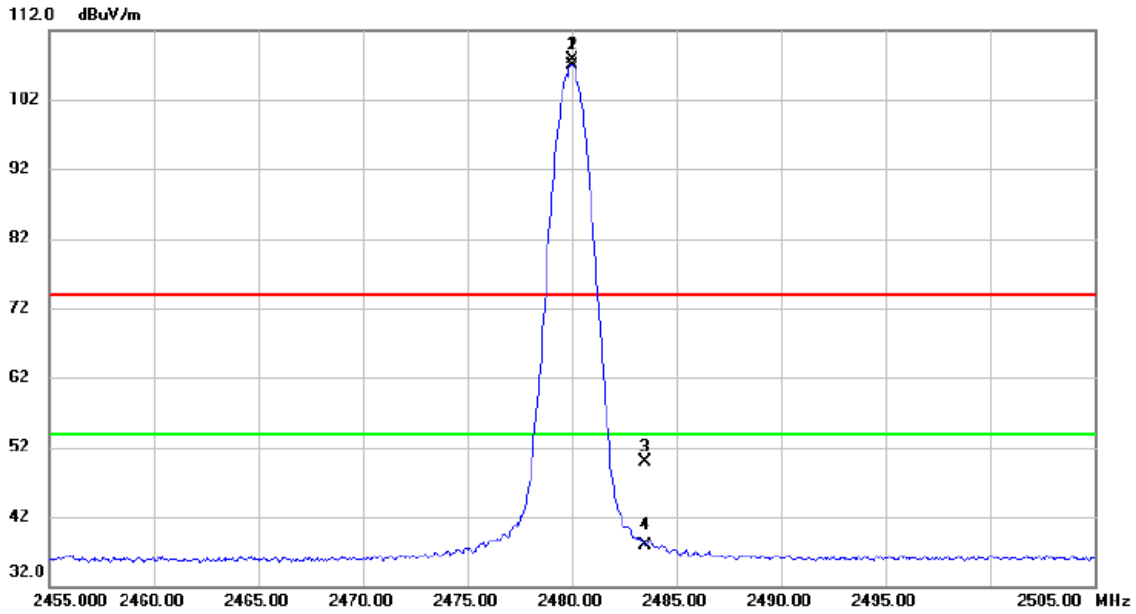

No.	Mk.	Freq. MHz	Reading Level dBuV	Correct Factor dB	Measure- ment dBuV/m	Limit dBuV/m	Margin dB	Detector	Comment
1	X	2480.000	97.94	9.85	107.79	74.00	33.79	peak	No Limit
2	*	2480.000	97.08	9.85	106.93	54.00	52.93	AVG	No Limit
3		2483.500	40.03	9.86	49.89	74.00	-24.11	peak	
4		2483.500	28.09	9.86	37.95	54.00	-16.05	AVG	

Test Mode : TX 2480MHz _CH78_ 1Mbps

Horizontal

80 dBuV/m

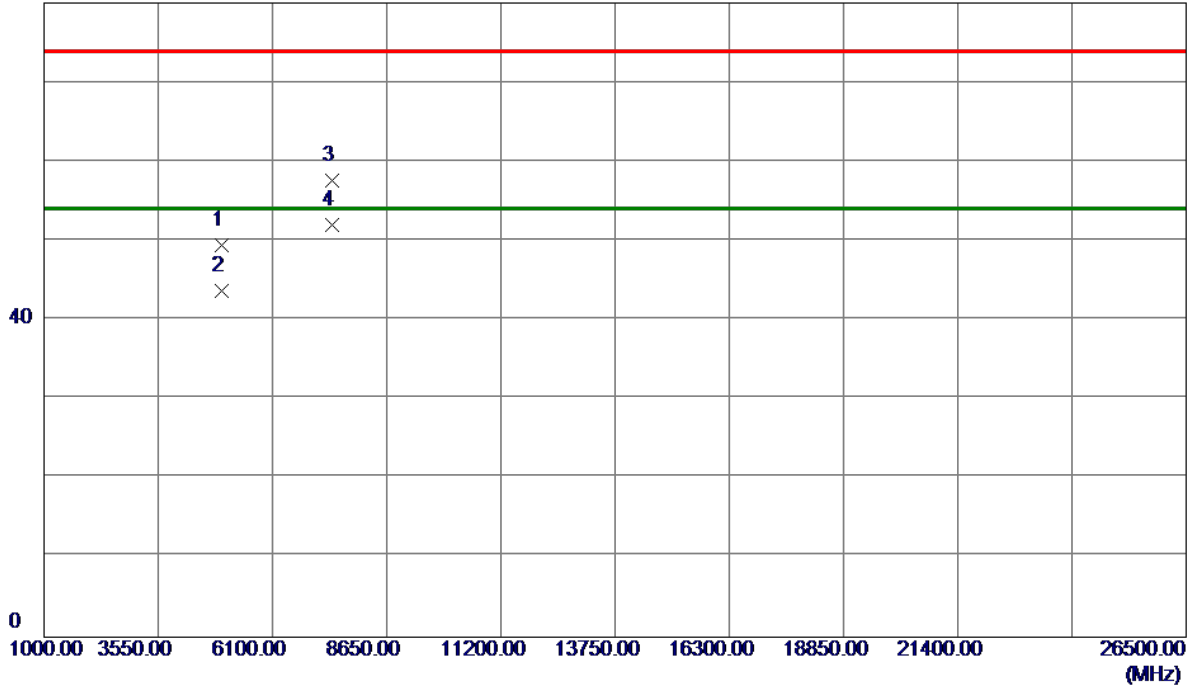

No.	Freq. MHz	Reading Level dBuV/m	Correct Factor dB	Measurement dBuV/m	Limit dBuV/m	Margin dB	Detector	Comment
1	4959.7080	42.27	7.15	49.42	74.00	-24.58	Peak	
2	4959.9020	36.47	7.15	43.62	54.00	-10.38	AVG	
3	7439.5780	44.27	13.31	57.58	74.00	-16.42	Peak	
4 *	7439.9440	38.75	13.31	52.06	54.00	-1.94	AVG	

Test Mode : TX 2402MHz _CH00_3Mbps

Vertical

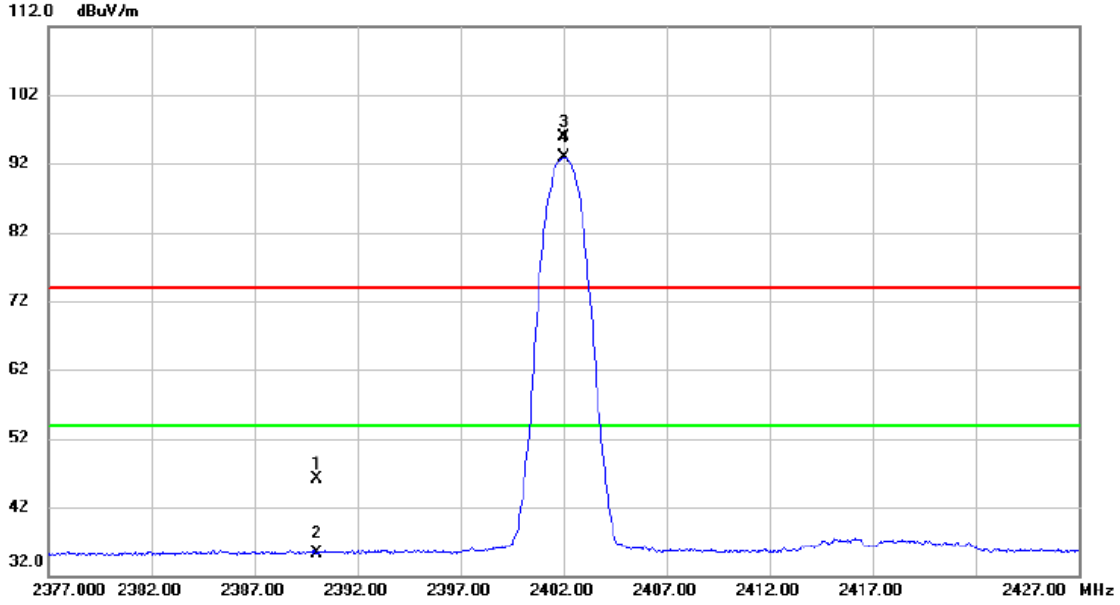

No.	Mk.	Freq. MHz	Reading Level dBuV	Correct Factor dB	Measure- ment dBuV/m	Limit dBuV/m	Margin dB	Detector	Comment
1		2390.000	36.55	9.54	46.09	74.00	-27.91	peak	
2		2390.000	25.84	9.54	35.38	54.00	-18.62	AVG	
3	X	2402.050	86.39	9.60	95.99	74.00	21.99	peak	No Limit
4	*	2402.050	83.31	9.60	92.91	54.00	38.91	AVG	No Limit

Test Mode : TX 2402MHz _CH00_3Mbps

Vertical

80 dBuV/m

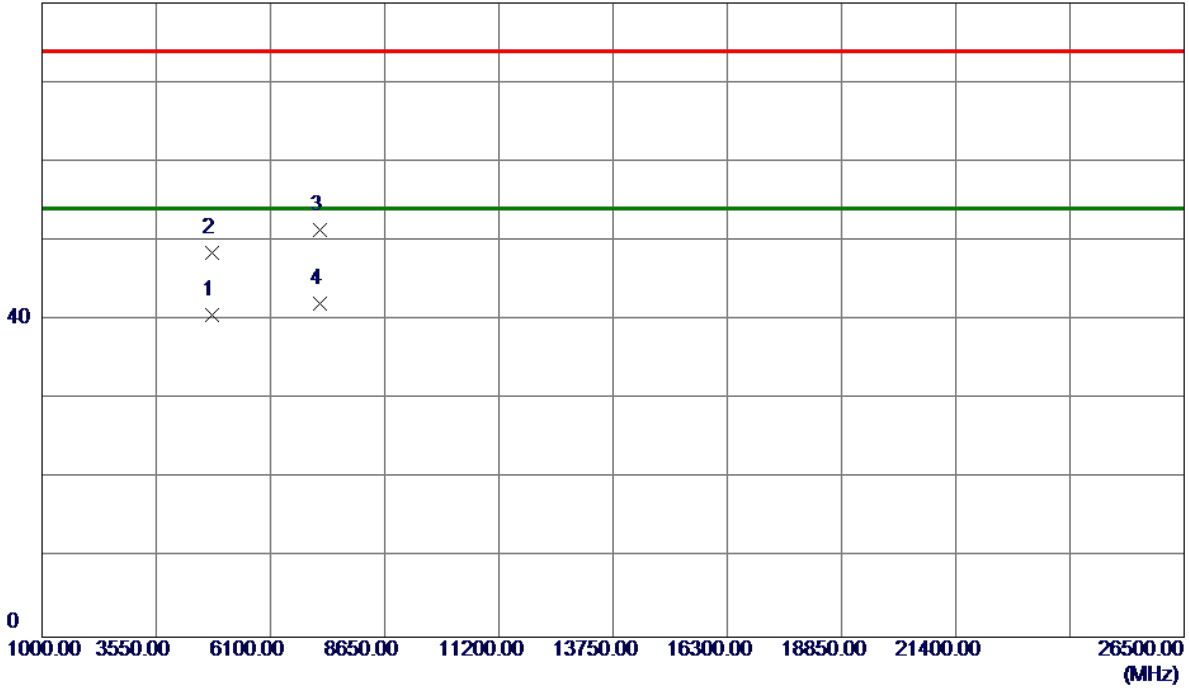

No.	Freq. MHz	Reading Level dBuV/m	Correct Factor dB	Measure ment dBuV/m	Limit dBuV/m	Margin dB	Detector	Comment
1	4804.1560	34.02	6.59	40.61	54.00	-13.39	AVG	
2	4804.3620	41.89	6.59	48.48	74.00	-25.52	Peak	
3	7206.3510	38.16	13.13	51.29	74.00	-22.71	Peak	
4 *	7206.9510	28.91	13.14	42.05	54.00	-11.95	AVG	

Test Mode : TX 2402MHz _CH00_3Mbps

Horizontal

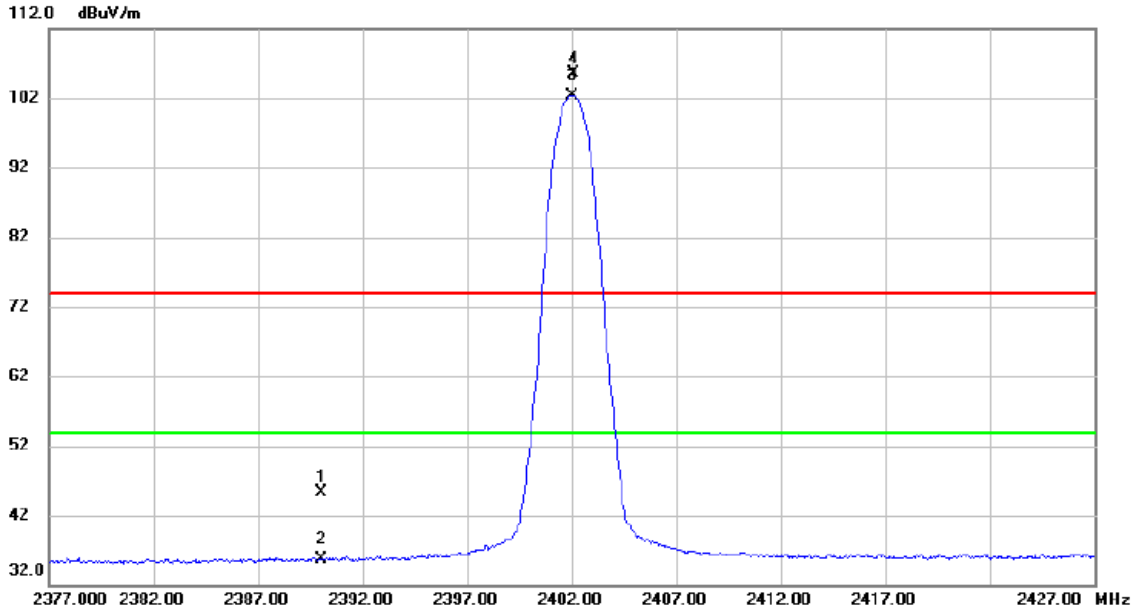

No.	Mk.	Freq. MHz	Reading Level dBuV	Correct Factor dB	Measure- ment dBuV/m	Limit dBuV/m	Margin dB	Detector	Comment
1		2390.000	35.67	9.54	45.21	74.00	-28.79	peak	
2		2390.000	26.08	9.54	35.62	54.00	-18.38	AVG	
3	*	2402.050	92.79	9.60	102.39	54.00	48.39	AVG	No Limit
4	X	2402.100	95.97	9.60	105.57	74.00	31.57	peak	No Limit

Test Mode : TX 2402MHz _CH00_3Mbps

Horizontal

80 dBuV/m

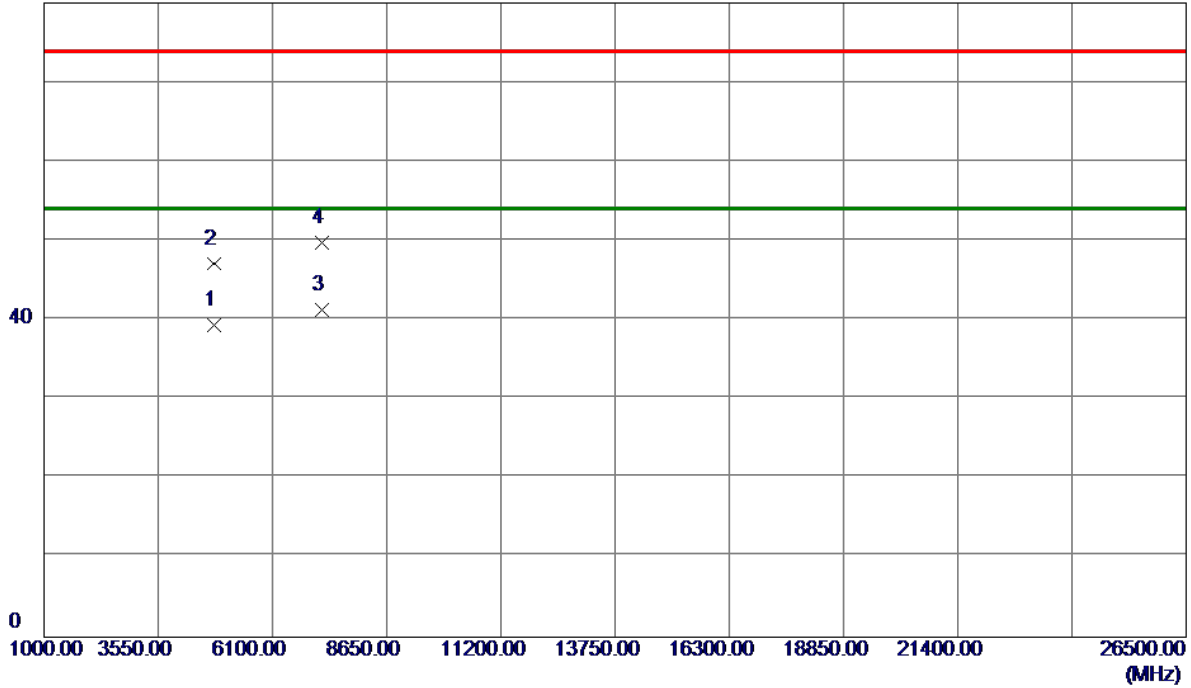

No.	Freq. MHz	Reading Level dBuV/m	Correct Factor dB	Measurement dBuV/m	Limit dBuV/m	Margin dB	Detector	Comment
1	4802.9480	32.74	6.58	39.32	54.00	-14.68	AVG	
2	4802.9900	40.54	6.58	47.12	74.00	-26.88	Peak	
3 *	7206.6480	28.13	13.13	41.26	54.00	-12.74	AVG	
4	7206.7550	36.58	13.14	49.72	74.00	-24.28	Peak	

Test Mode : TX 2441MHz _CH39_3Mbps

Vertical

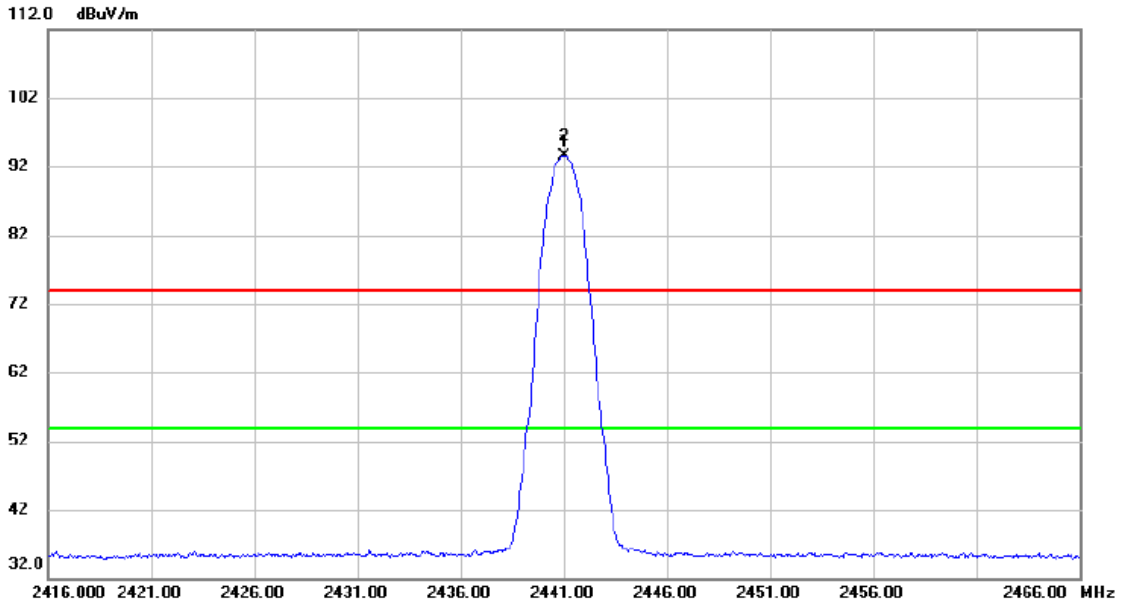

No.	Mk.	Freq. MHz	Reading Level dBuV	Correct Factor dB	Measure- ment dBuV/m	Limit dBuV/m	Margin dB	Detector	Comment
1	X	2441.050	83.84	9.72	93.56	74.00	19.56	peak	No Limit
2	*	2441.050	83.84	9.72	93.56	54.00	39.56	AVG	No Limit

Test Mode : TX 2441MHz _CH39_ 3Mbps

Vertical

80 dBuV/m

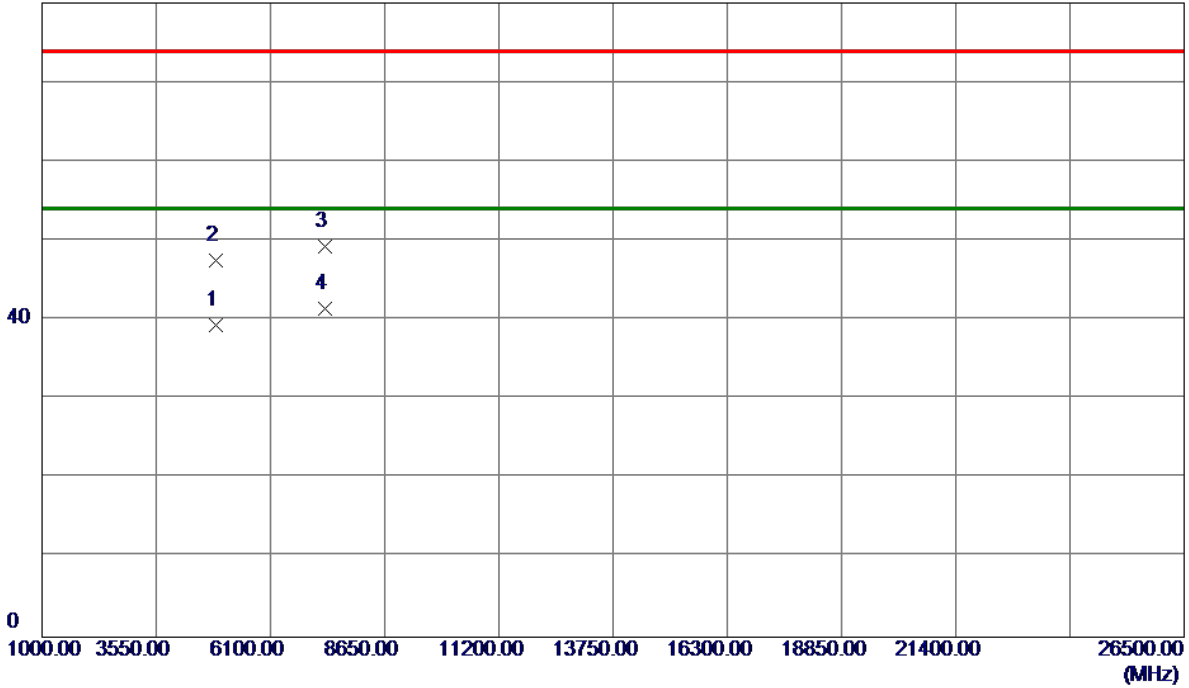

No.	Freq. MHz	Reading Level dBuV/m	Correct Factor dB	Measure ment dBuV/m	Limit dBuV/m	Margin dB	Detector	Comment
1	4882.1500	32.54	6.87	39.41	54.00	-14.59	AVG	
2	4882.2500	40.64	6.87	47.51	74.00	-26.49	Peak	
3	7323.8710	36.03	13.22	49.25	74.00	-24.75	Peak	
4 *	7323.9500	28.24	13.22	41.46	54.00	-12.54	AVG	

Test Mode : TX 2441MHz _CH39_ 3Mbps

Horizontal

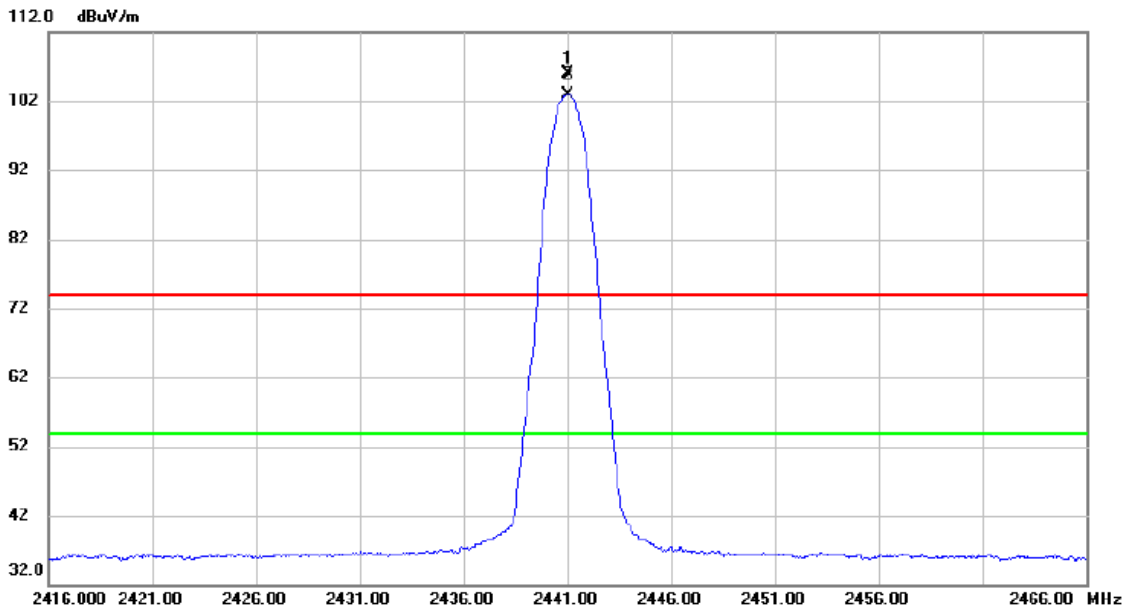

No.	Mk.	Freq. MHz	Reading Level dBuV	Correct Factor dB	Measure- ment dBuV/m	Limit dBuV/m	Margin dB	Detector	Comment
1	X	2441.000	96.17	9.72	105.89	74.00	31.89	peak	No Limit
2	*	2441.050	93.17	9.72	102.89	54.00	48.89	AVG	No Limit

Test Mode : TX 2441MHz _CH39_ 3Mbps

Horizontal

80 dBuV/m

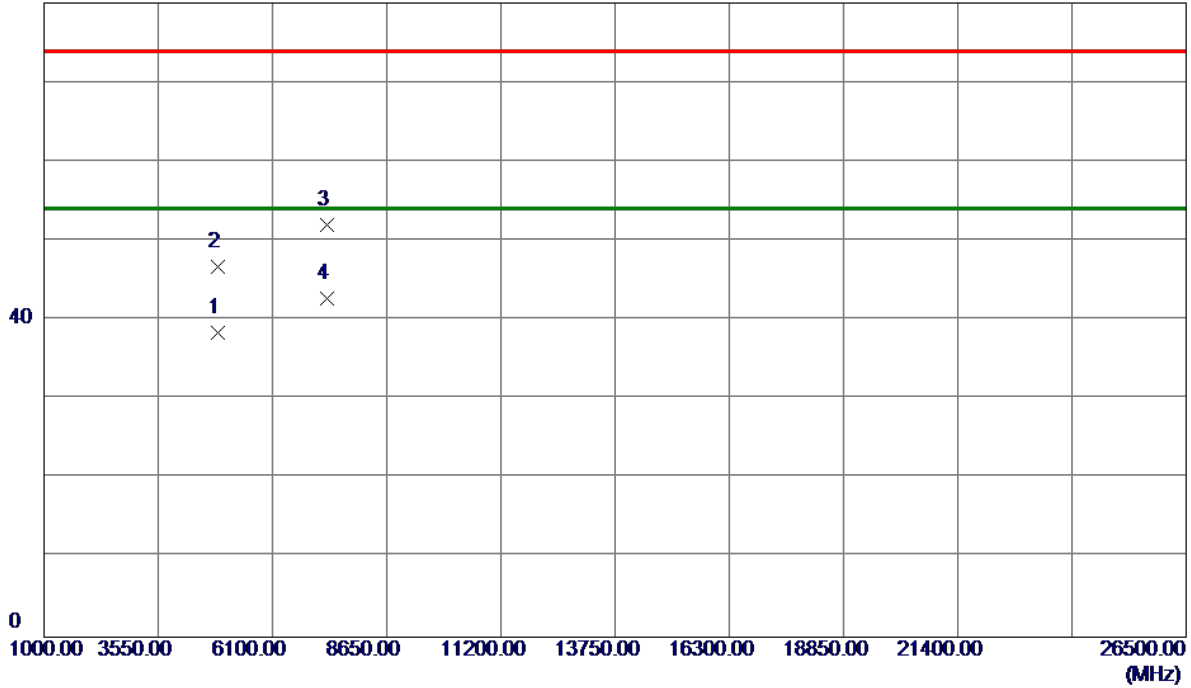

No.	Freq. MHz	Reading Level dBuV/m	Correct Factor dB	Measurement dBuV/m	Limit dBuV/m	Margin dB	Detector	Comment
1	4882.1000	31.54	6.87	38.41	54.00	-15.59	AVG	
2	4882.1500	39.81	6.87	46.68	74.00	-27.32	Peak	
3	7323.5130	38.83	13.22	52.05	74.00	-21.95	Peak	
4 *	7323.6450	29.45	13.22	42.67	54.00	-11.33	AVG	

Test Mode : TX 2480MHz _CH78_3Mbps

Vertical

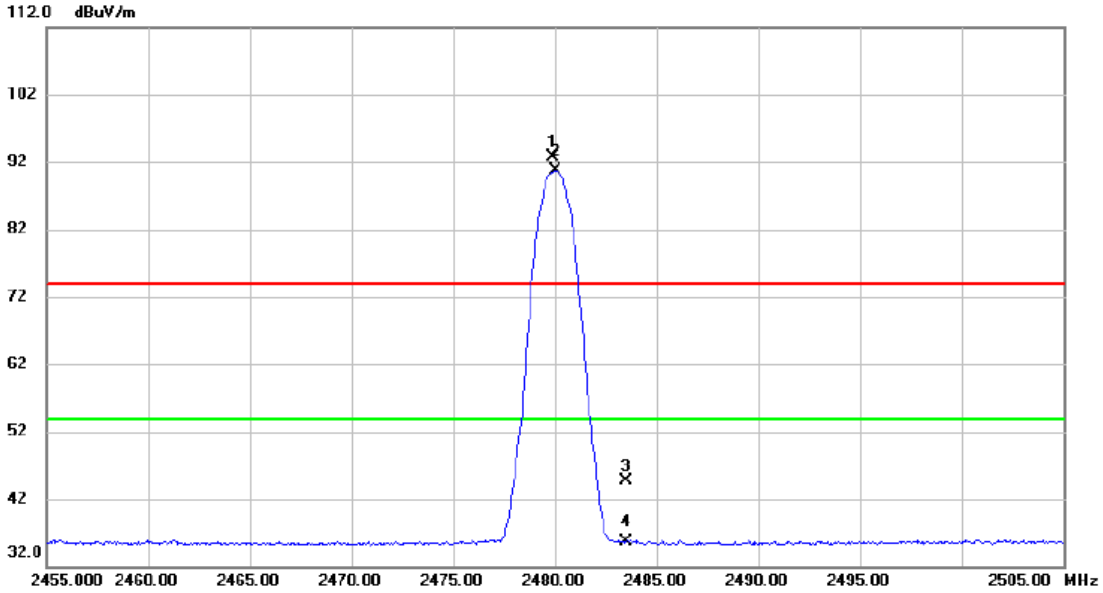

No.	Mk.	Freq. MHz	Reading Level dBuV	Correct Factor dB	Measure- ment dBuV/m	Limit dBuV/m	Margin dB	Detector	Comment
1	X	2479.900	82.95	9.85	92.80	74.00	18.80	peak	No Limit
2	*	2480.000	80.79	9.85	90.64	54.00	36.64	AVG	No Limit
3		2483.500	34.79	9.86	44.65	74.00	-29.35	peak	
4		2483.500	25.85	9.86	35.71	54.00	-18.29	AVG	

Test Mode : TX 2480MHz _CH78_ 3Mbps

Vertical

80 dBuV/m

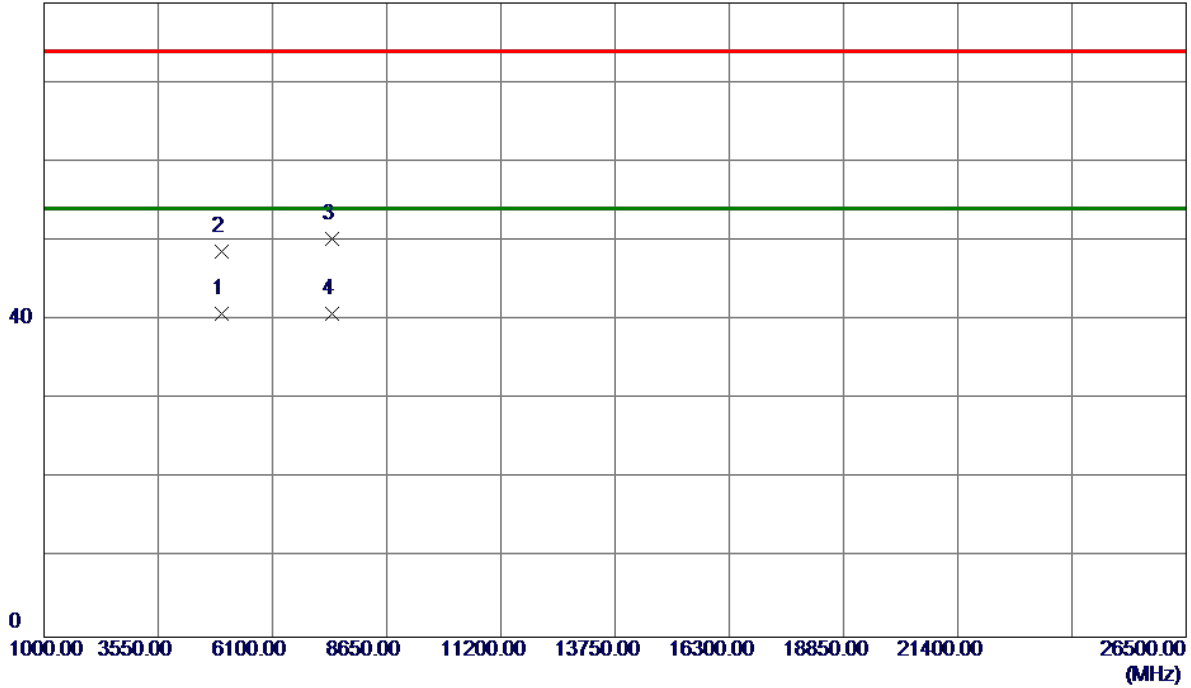

No.	Freq. MHz	Reading Level dBuV/m	Correct Factor dB	Measure ment dBuV/m	Limit dBuV/m	Margin dB	Detector	Comment
1	4960.0240	33.65	7.15	40.80	54.00	-13.20	AVG	
2	4960.2540	41.54	7.15	48.69	74.00	-25.31	Peak	
3	7439.8720	36.96	13.31	50.27	74.00	-23.73	Peak	
4 *	7439.9820	27.54	13.31	40.85	54.00	-13.15	AVG	

Test Mode : TX 2480MHz _CH78_ 3Mbps

Horizontal

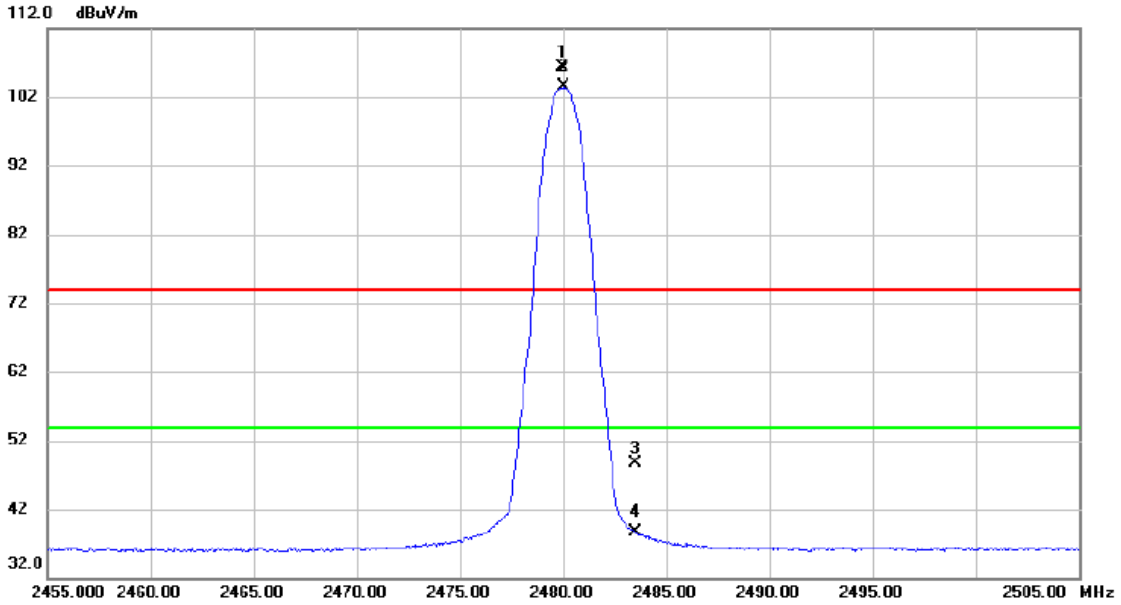

No.	Mk.	Freq. MHz	Reading Level dBuV	Correct Factor dB	Measure- ment dBuV/m	Limit dBuV/m	Margin dB	Detector	Comment
1	X	2479.950	96.55	9.85	106.40	74.00	32.40	peak	No Limit
2	*	2480.050	93.56	9.85	103.41	54.00	49.41	AVG	No Limit
3		2483.500	38.76	9.86	48.62	74.00	-25.38	peak	
4		2483.500	28.86	9.86	38.72	54.00	-15.28	AVG	

Test Mode : TX 2480MHz _CH78_ 3Mbps

Horizontal

80 dBuV/m

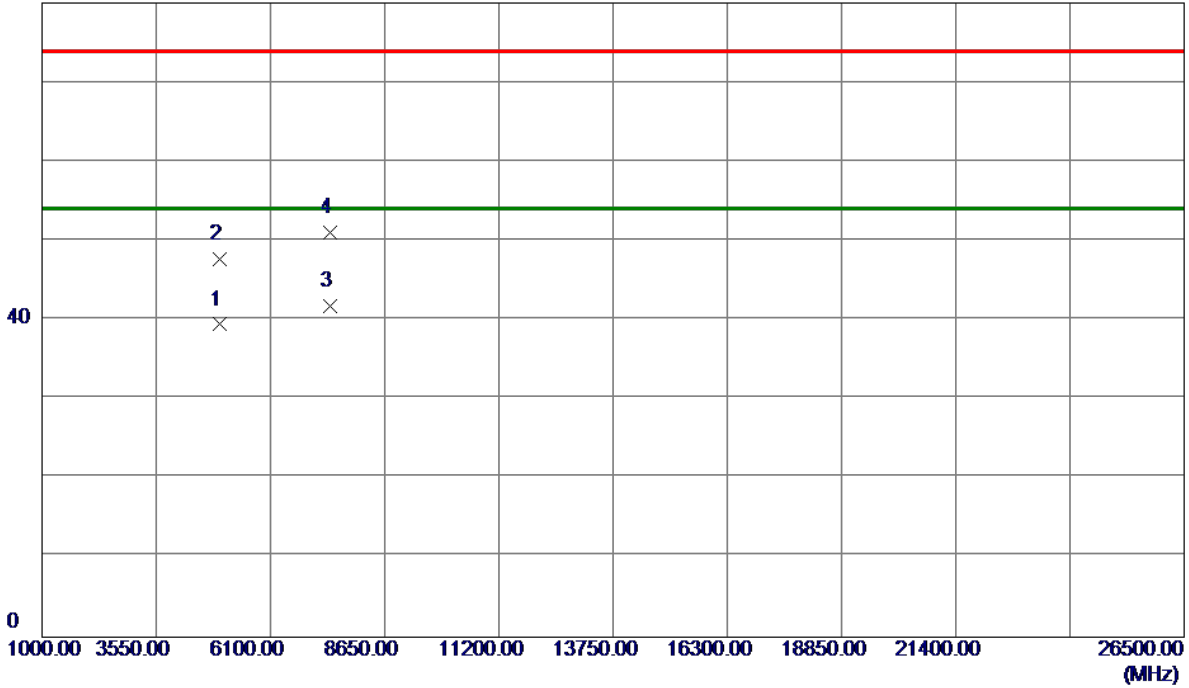

No.	Freq. MHz	Reading Level dBuV/m	Correct Factor dB	Measure ment dBuV/m	Limit dBuV/m	Margin dB	Detector	Comment
1	4959.9480	32.29	7.15	39.44	54.00	-14.56	AVG	
2	4960.2000	40.52	7.15	47.67	74.00	-26.33	Peak	
3 *	7440.0540	28.43	13.31	41.74	54.00	-12.26	AVG	
4	7440.6980	37.75	13.31	51.06	74.00	-22.94	Peak	

APPENDIX E - NUMBER OF HOPPING CHANNEL

Test Mode Hopping Mode_1Mbps

Number of Hopping Channel 79

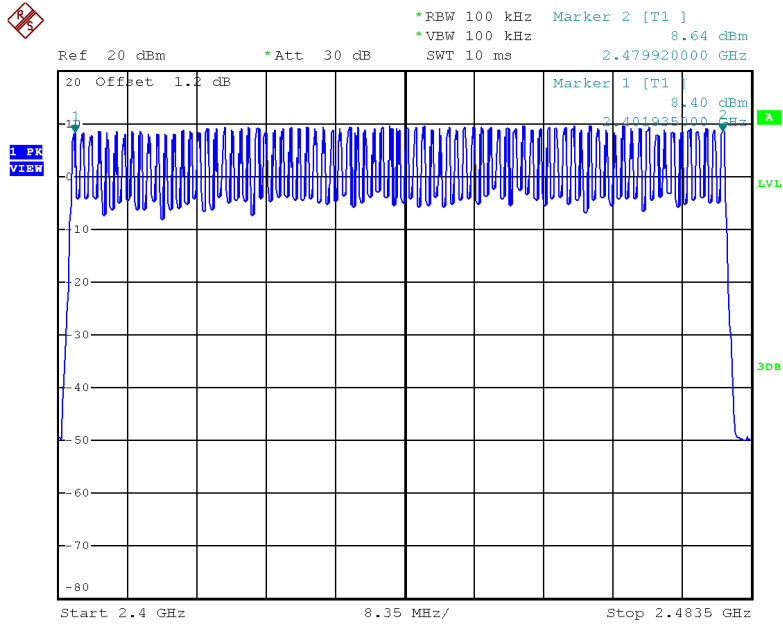

Date: 4.APR.2018 20:56:58

Test Mode Hopping Mode_3Mbps

Number of Hopping Channel 79

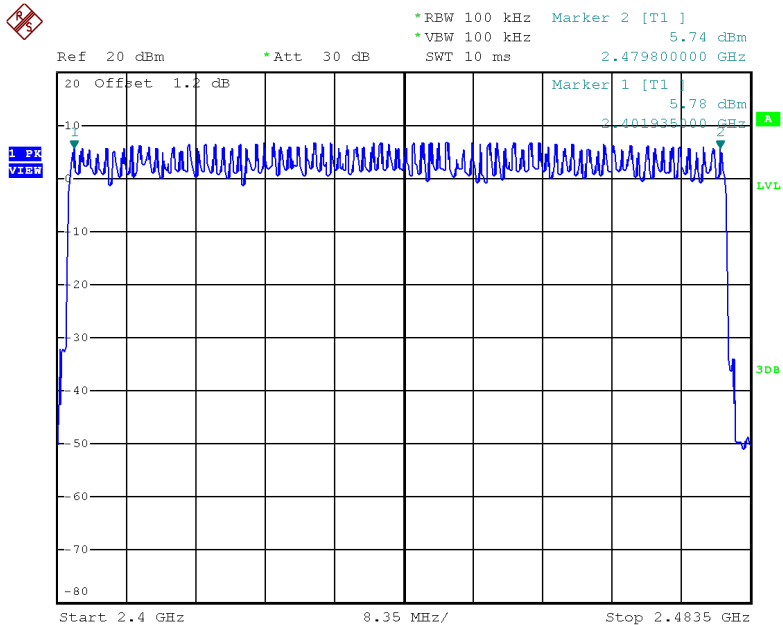

Date: 4.APR.2018 21:15:11

APPENDIX F - AVERAGE TIME OF OCCUPANCY

Test Mode : TX Mode_1Mbps

Data Packet	Frequency (MHz)	Pulse Duration (ms)	Dwell Time (s)	Limits (s)	Test Result
DH5	2402	2.9200	0.3115	0.4000	Pass
DH3	2402	1.6600	0.2656	0.4000	Pass
DH1	2402	0.3850	0.1232	0.4000	Pass
DH5	2441	2.8800	0.3072	0.4000	Pass
DH3	2441	1.6400	0.2624	0.4000	Pass
DH1	2441	0.3850	0.1232	0.4000	Pass
DH5	2480	2.8800	0.3072	0.4000	Pass
DH3	2480	1.6600	0.2656	0.4000	Pass
DH1	2480	0.3850	0.1232	0.4000	Pass

CH00-DH1

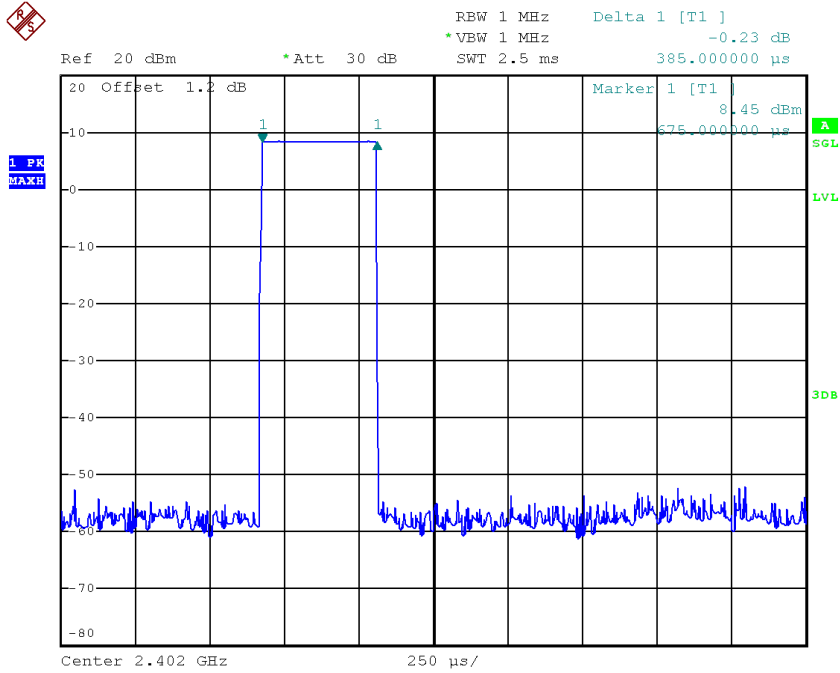

Date: 4.APR.2018 20:51:28

CH00-DH3

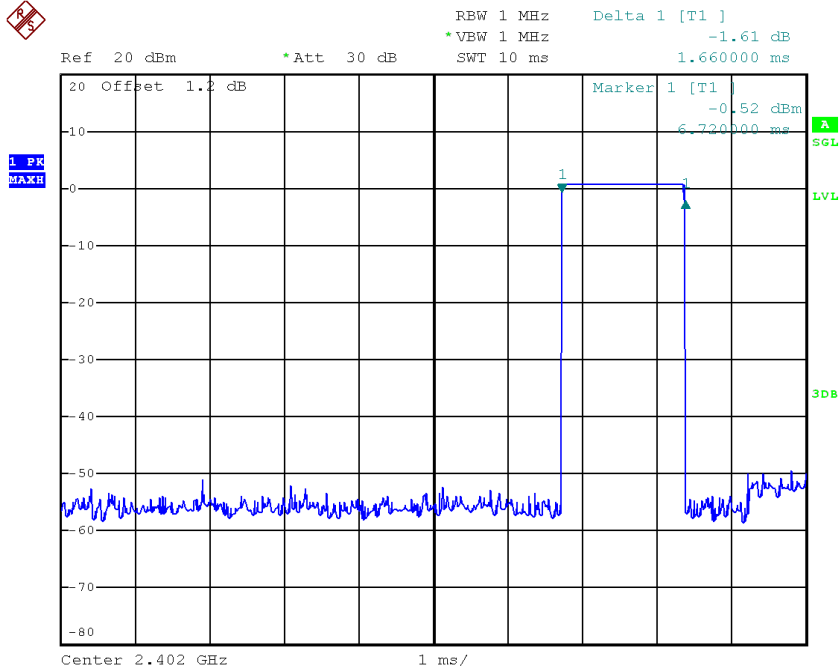

Date: 4.APR.2018 20:58:37

CH00-DH5

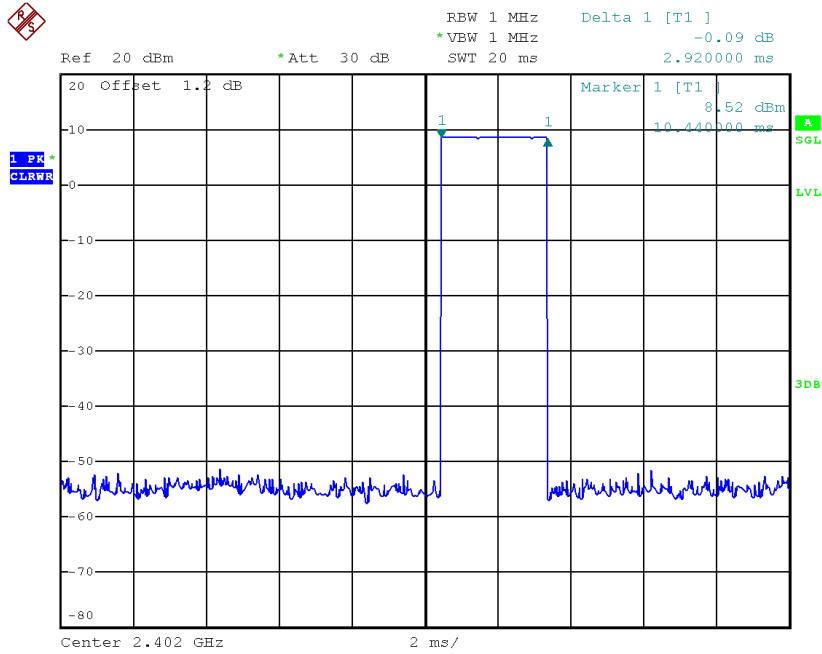

Date: 4.APR.2018 20:59:42

CH39-DH1

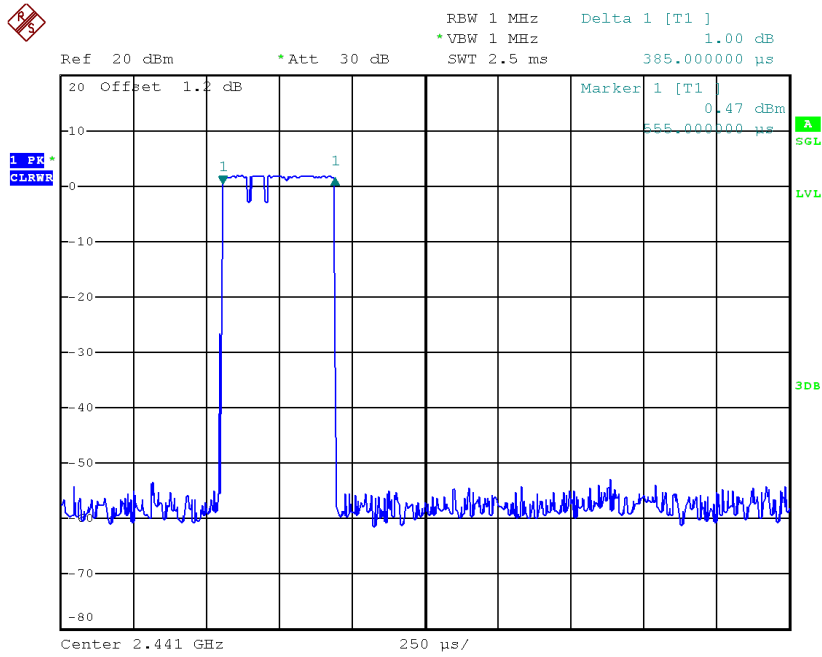

Date: 4.APR.2018 20:51:33

CH39-DH3

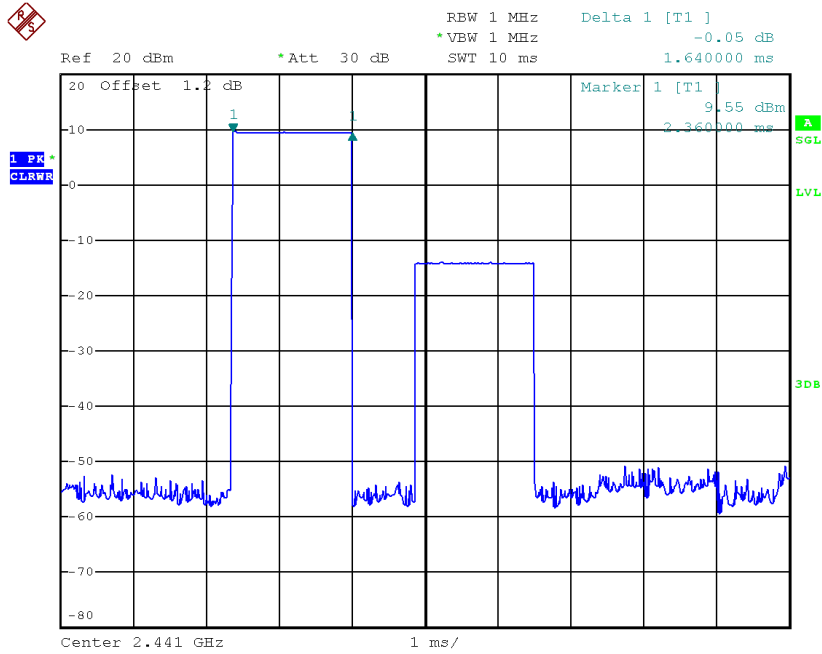

Date: 4.APR.2018 20:59:12

CH39-DH5

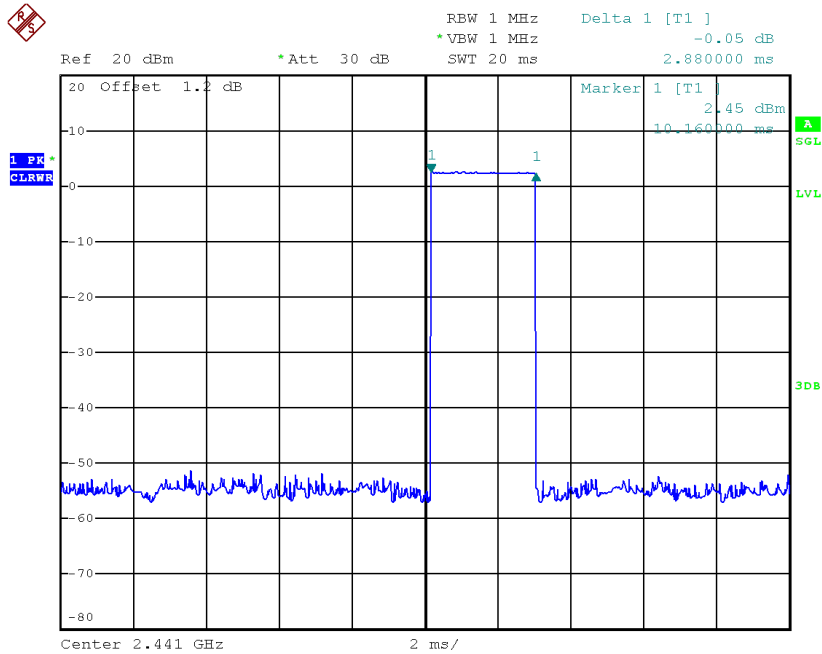

Date: 4.APR.2018 20:59:46

CH78-DH1

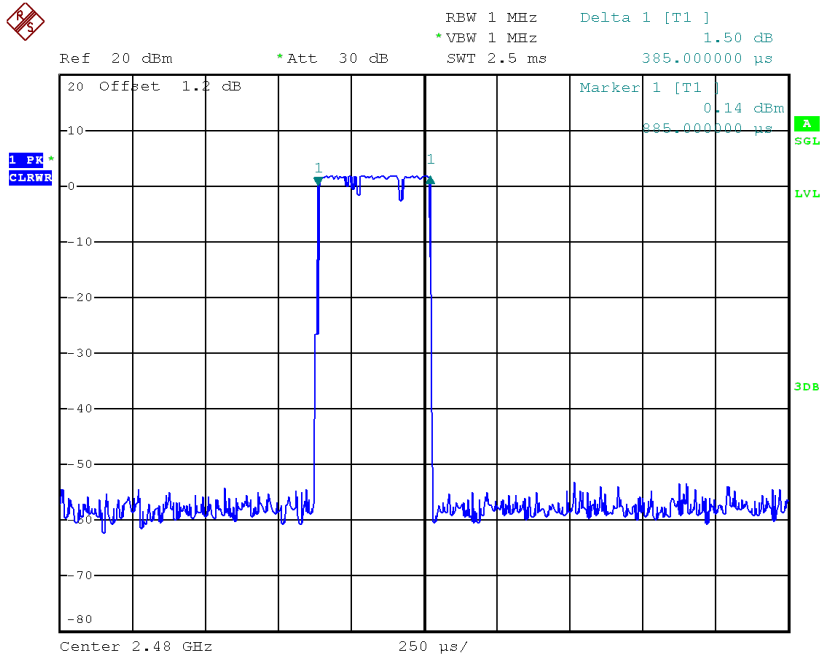

Date: 4.APR.2018 20:51:37

CH78-DH3

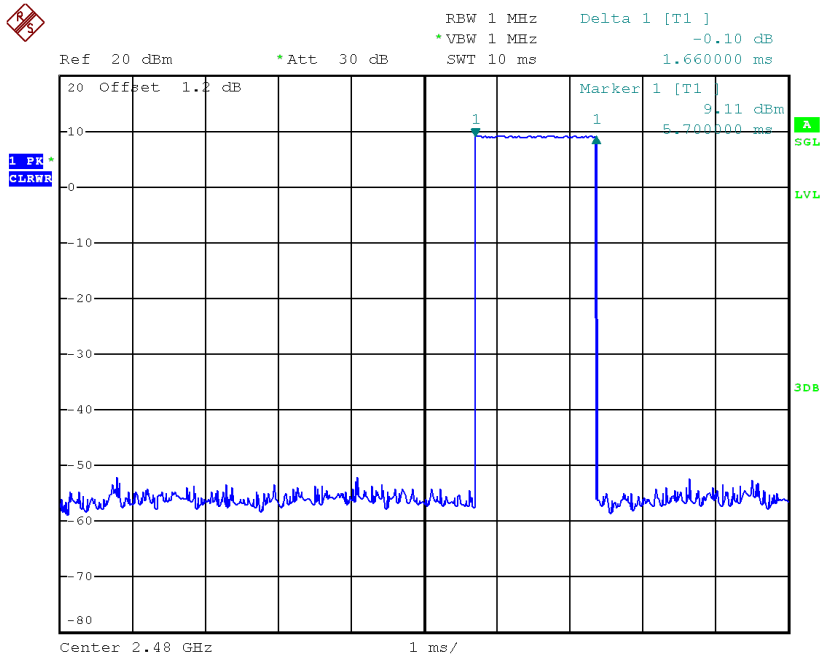

Date: 4.APR.2018 20:59:16

CH78-DH5

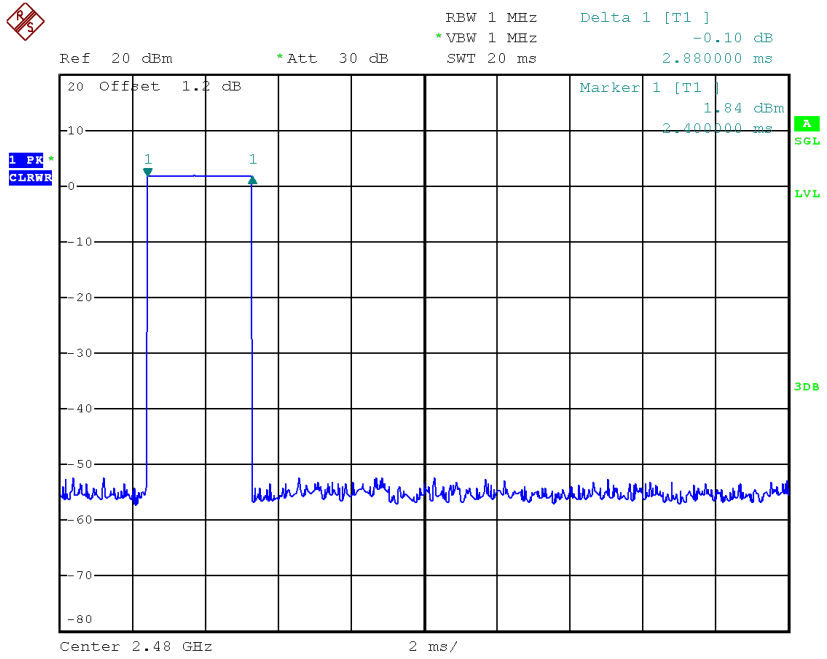

Date: 4.APR.2018 20:59:49

Test Mode :	TX Mode_3Mbps
-------------	---------------

Data Packet	Frequency	Pulse Duration(ms)	Dwell Time(s)	Limits(s)	Test Result
DH5	2402	2.8800	0.3072	0.4000	Pass
DH3	2402	1.6400	0.2624	0.4000	Pass
DH1	2402	0.3900	0.1248	0.4000	Pass
DH5	2441	2.8800	0.3072	0.4000	Pass
DH3	2441	1.6400	0.2624	0.4000	Pass
DH1	2441	0.3900	0.1248	0.4000	Pass
DH5	2480	2.8800	0.3072	0.4000	Pass
DH3	2480	1.6400	0.2624	0.4000	Pass
DH1	2480	0.3900	0.1248	0.4000	Pass

CH00-DH1

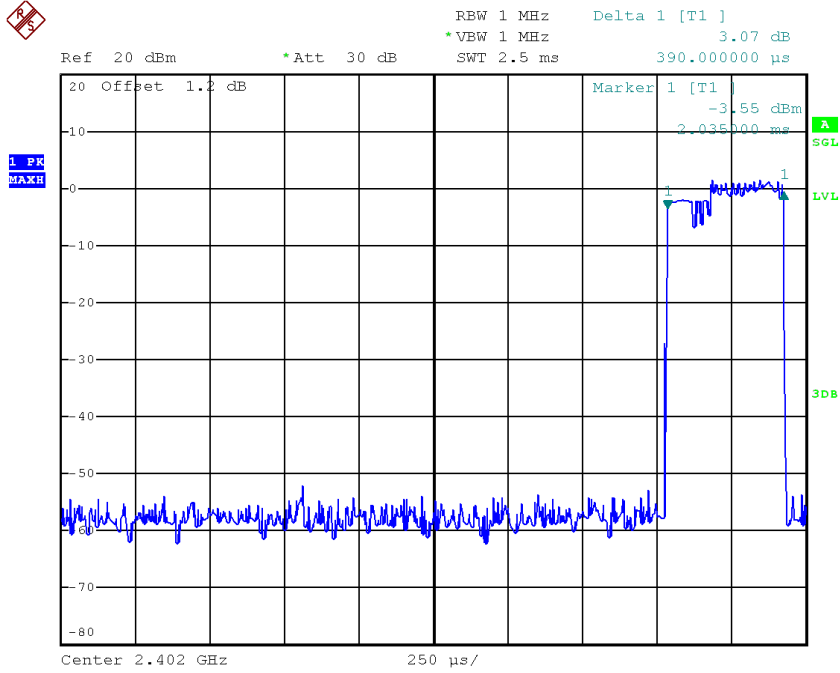

Date: 4.APR.2018 21:08:14

CH00-DH3

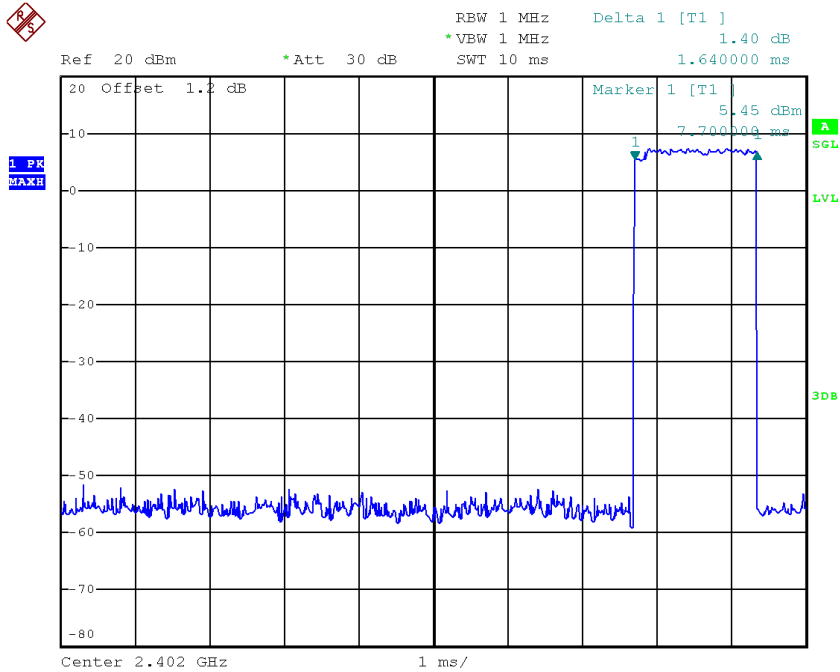

Date: 4.APR.2018 21:17:12

CH00-DH5

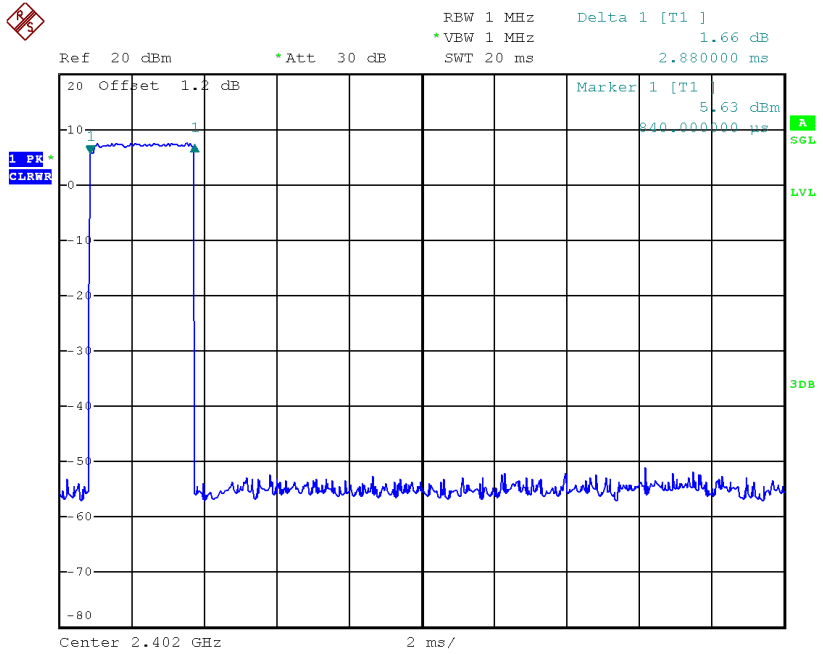

Date: 4.APR.2018 21:17:53

CH39-DH1

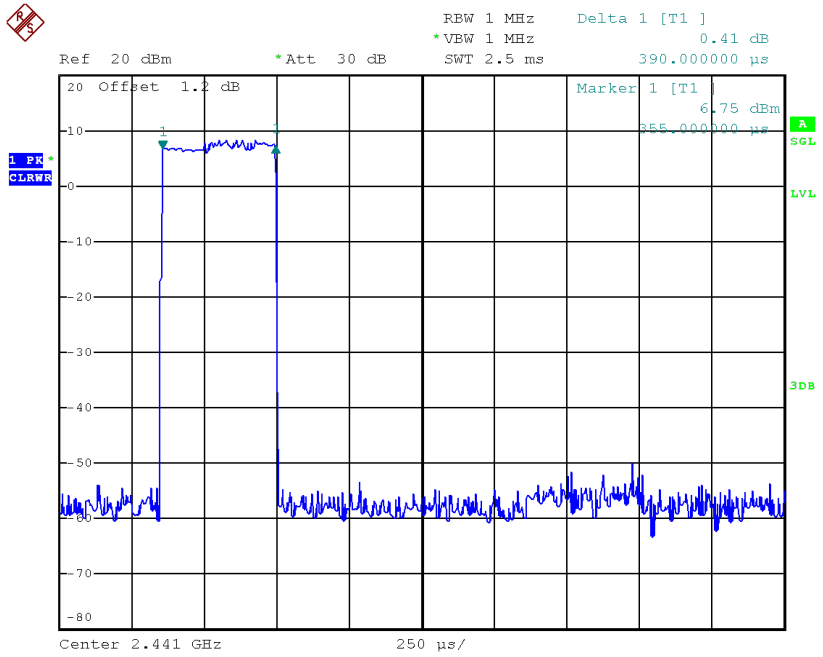

Date: 4.APR.2018 21:08:36

CH39-DH3

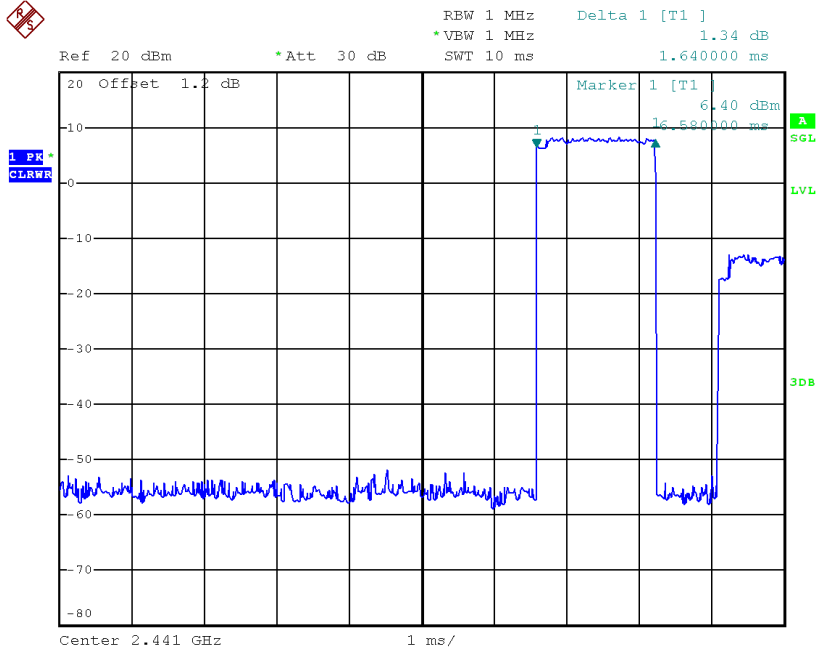

Date: 4.APR.2018 21:17:32

CH39-DH5

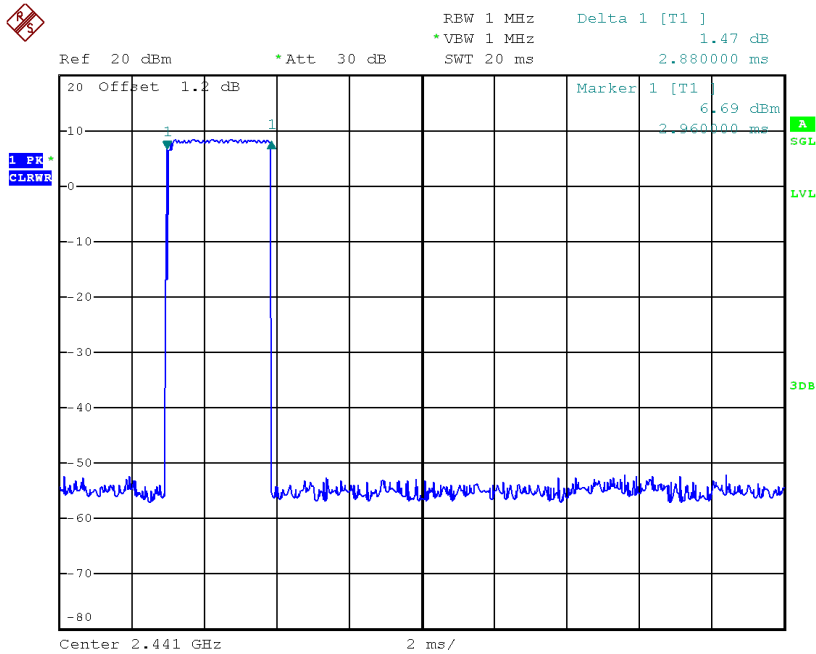

Date: 4.APR.2018 21:17:57

CH78-DH1

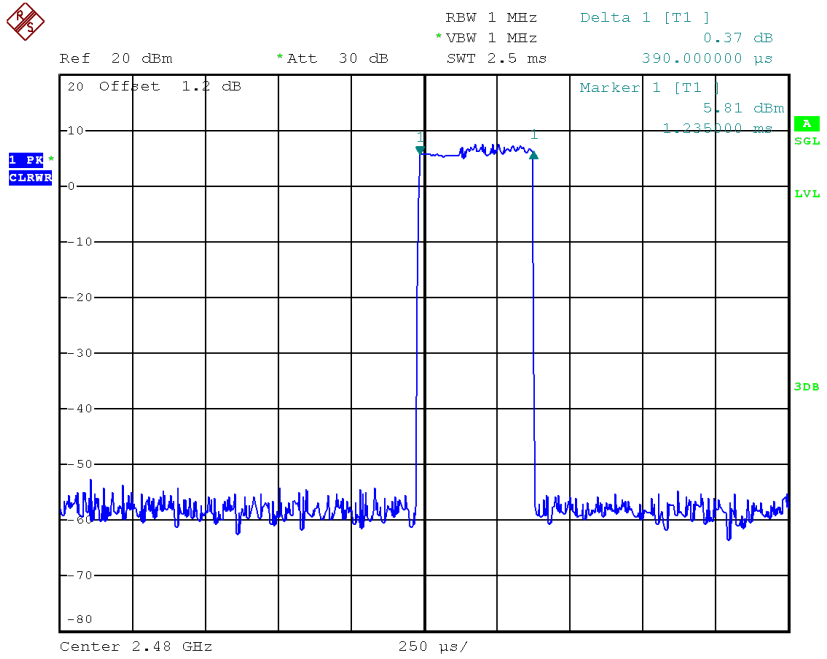

Date: 4.APR.2018 21:08:42

CH78-DH3

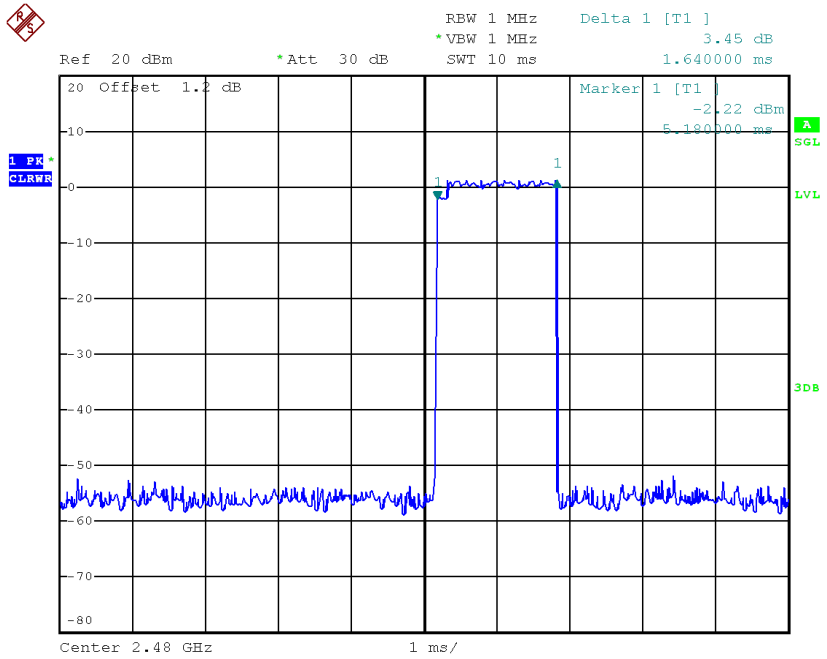

Date: 4.APR.2018 21:17:40

CH78-DH5

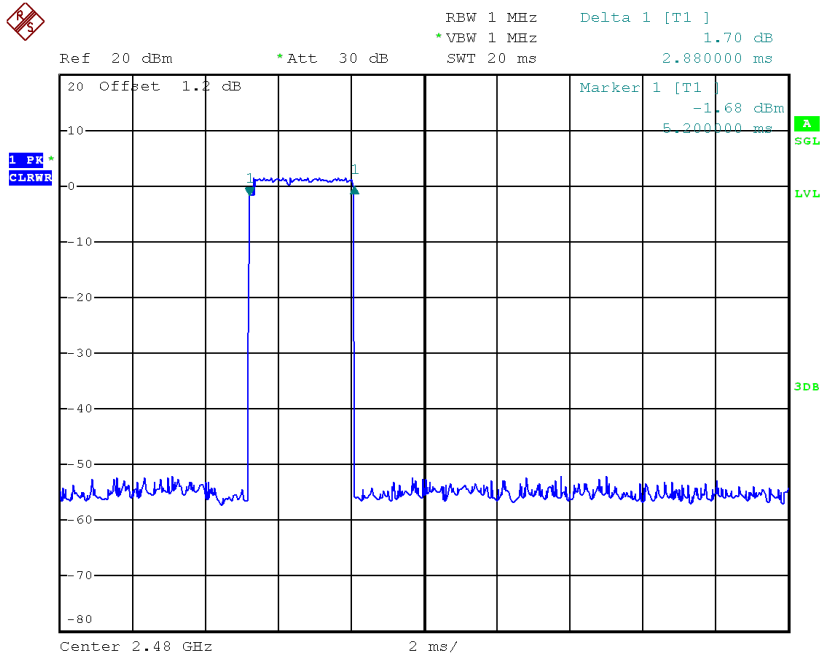

Date: 4.APR.2018 21:18:02

APPENDIX G - HOPPING CHANNEL SEPARATION MEASUREMENT

Test Mode : Hopping on _1Mbps

Frequency (MHz)	Channel Separation (MHz)	2/3 of 20dB Bandwidth (MHz)	Test Result
2402	0.983	0.685	Pass
2441	0.987	0.684	Pass
2480	0.989	0.672	Pass

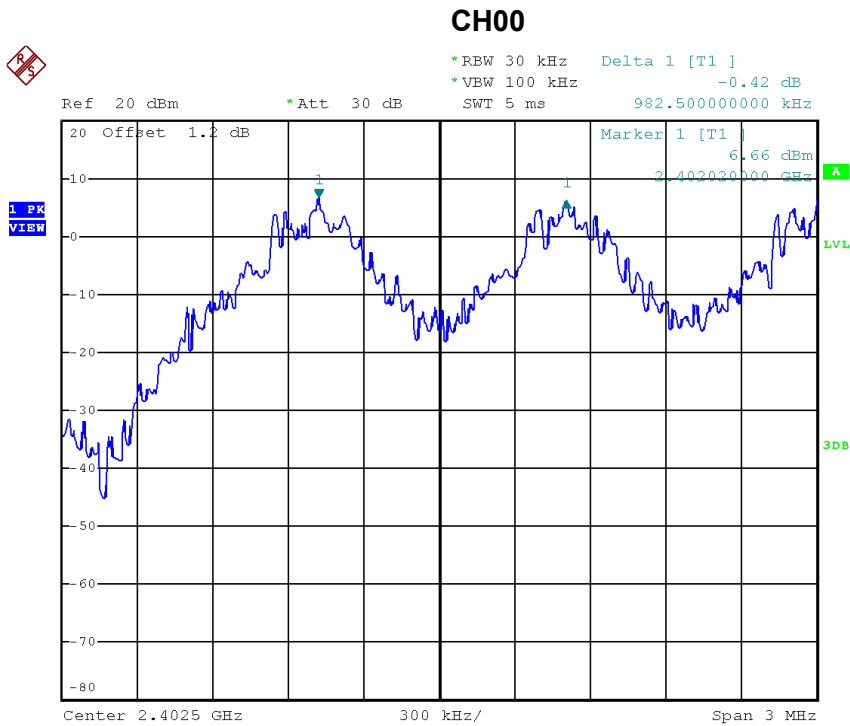

Date: 4.APR.2018 20:52:48

CH39



*RBW 30 kHz Delta 1 [T1]
*VBW 100 kHz -0.33 dB
SWT 5 ms 987.000000000 kHz

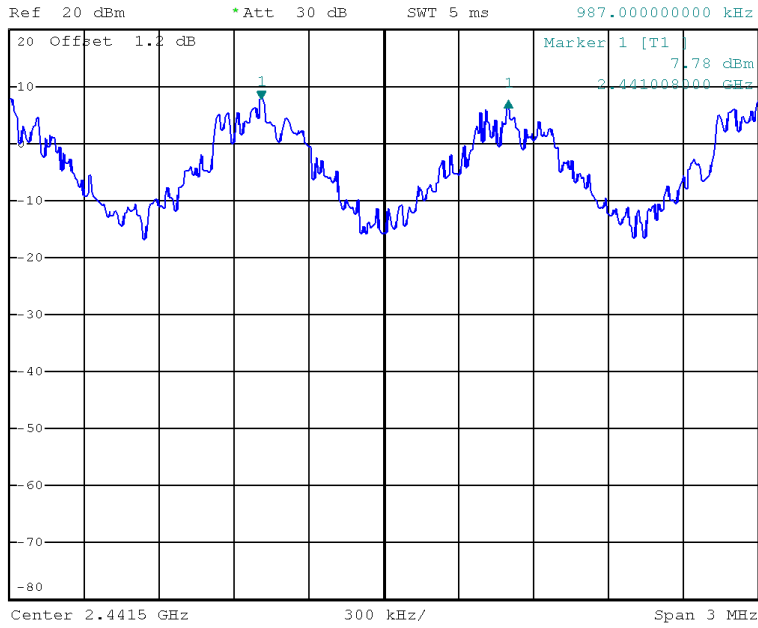

Date: 4.APR.2018 20:53:58

CH78



*RBW 30 kHz Delta 1 [T1]
*VBW 100 kHz -0.80 dB
SWT 5 ms 989.000000000 kHz

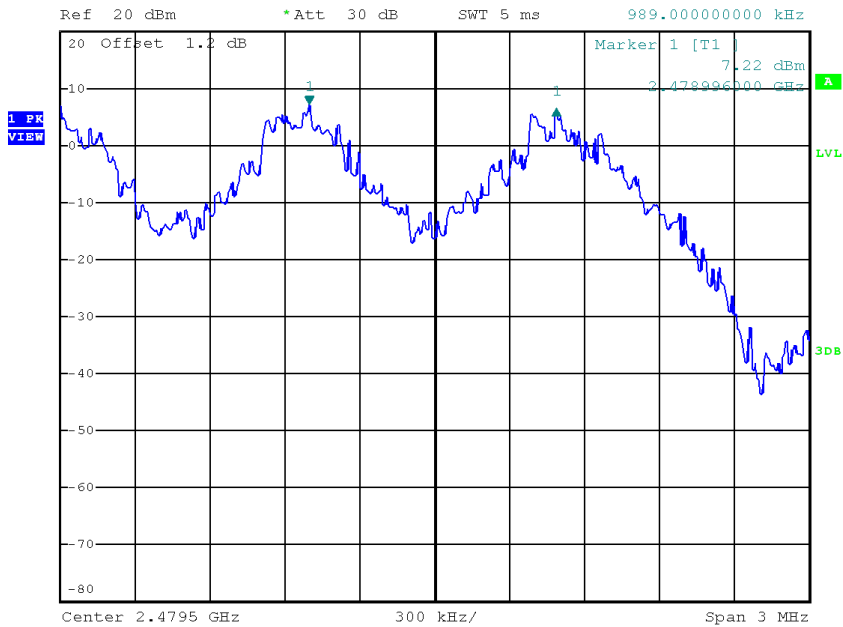

Date: 4.APR.2018 20:55:08

Test Mode : Hopping on _3Mbps

Frequency (MHz)	Channel Separation (MHz)	2/3 of 20dB Bandwidth (MHz)	Test Result
2402	0.993	0.884	Pass
2441	1.160	0.883	Pass
2480	1.002	0.879	Pass

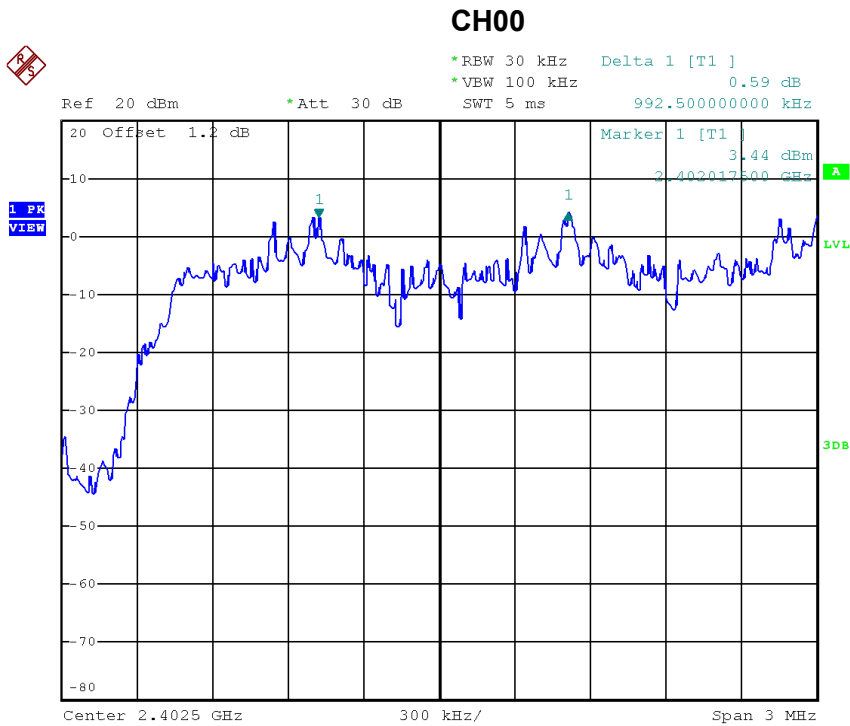

Date: 4.APR.2018 21:09:51

CH39

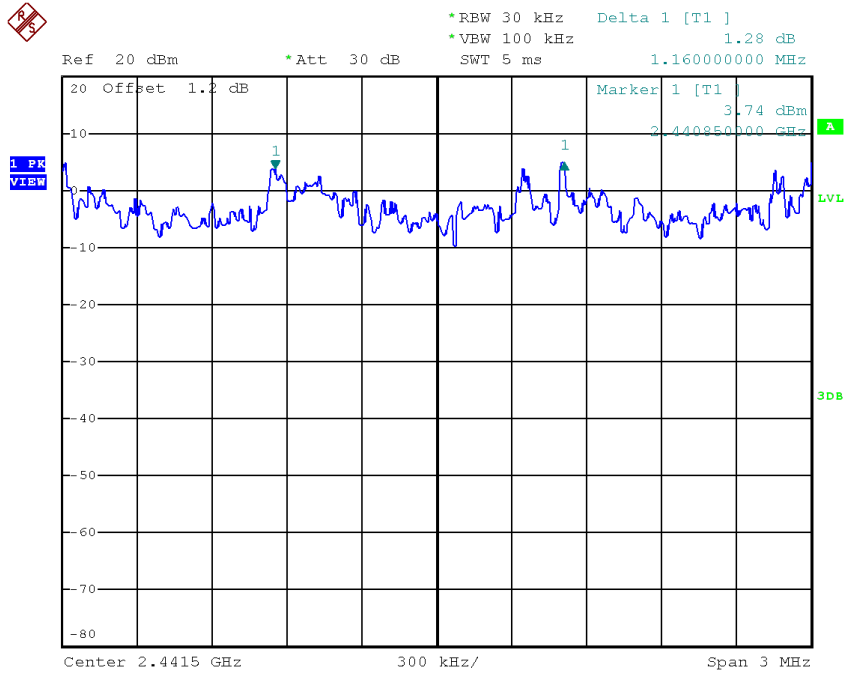

Date: 4.APR.2018 21:12:18

CH78

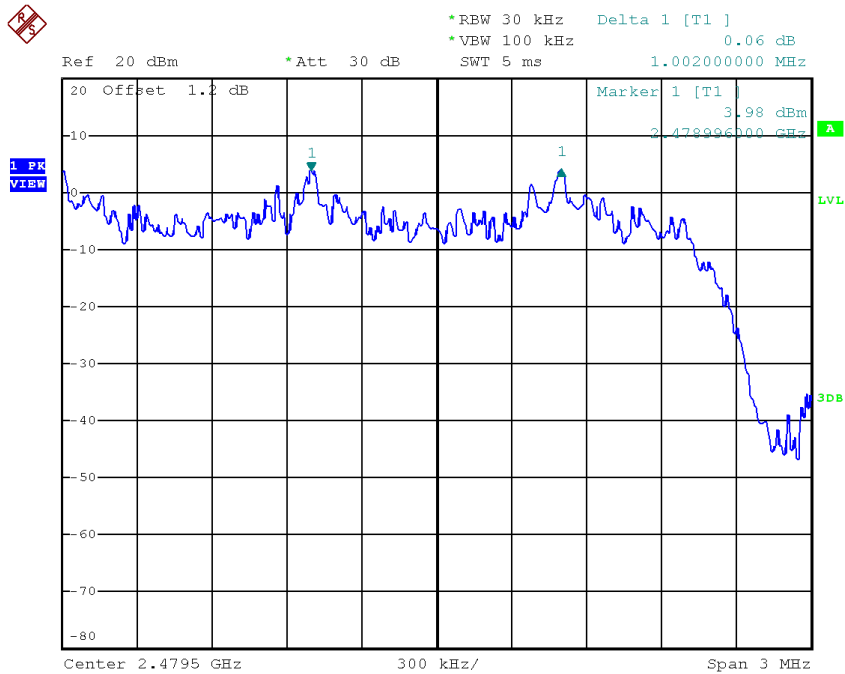

Date: 4.APR.2018 21:13:22

APPENDIX H - BANDWIDTH

Test Mode : TX Mode _1Mbps

Frequency (MHz)	20dB Bandwidth (MHz)	99% Occupied BW (MHz)	Test Result
2402	1.028	0.916	Pass
2441	1.026	0.896	Pass
2480	1.008	0.900	Pass

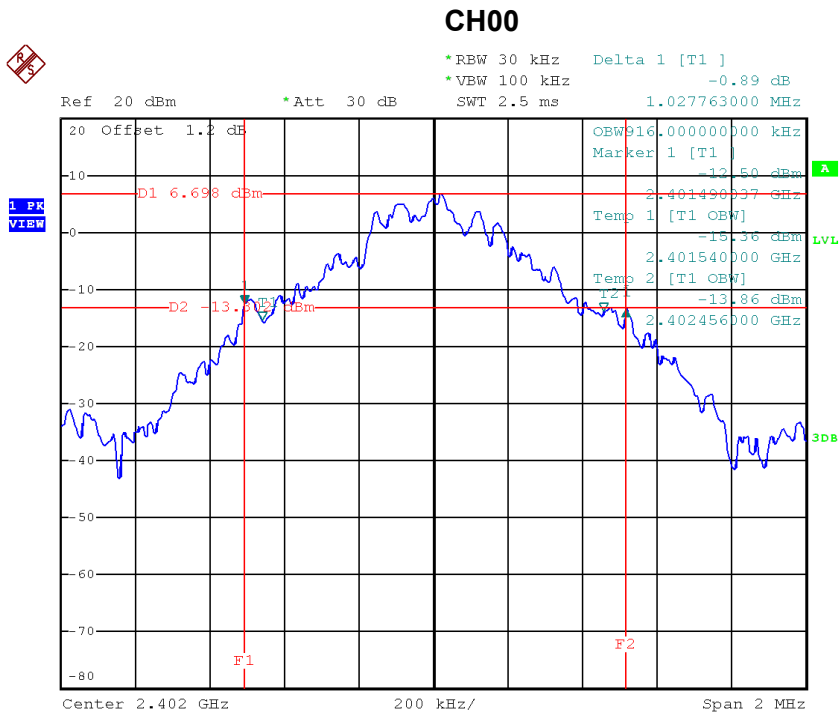

Date: 4.APR.2018 20:44:39

CH39

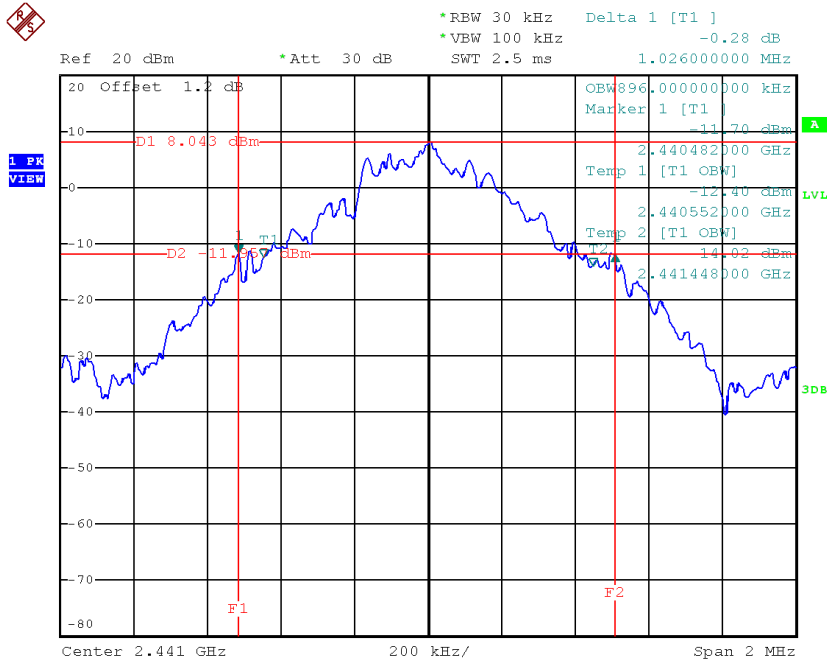

Date: 4.APR.2018 20:46:46

CH78

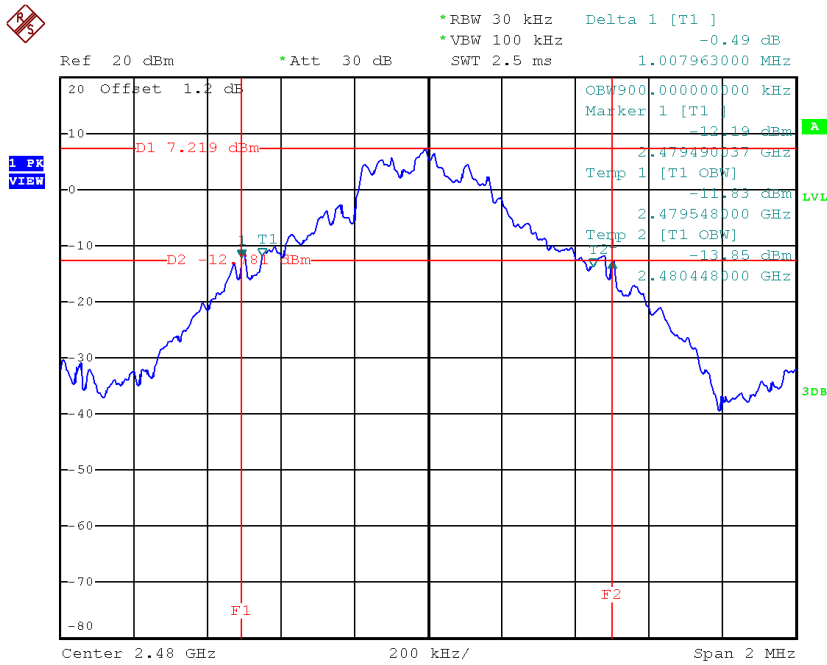

Date: 4.APR.2018 20:48:34

Test Mode : TX Mode _3Mbps

Frequency (MHz)	20dB Bandwidth (MHz)	99% Occupied BW (MHz)	Test Result
2402	1.326	1.220	Pass
2441	1.324	1.212	Pass
2480	1.318	1.216	Pass

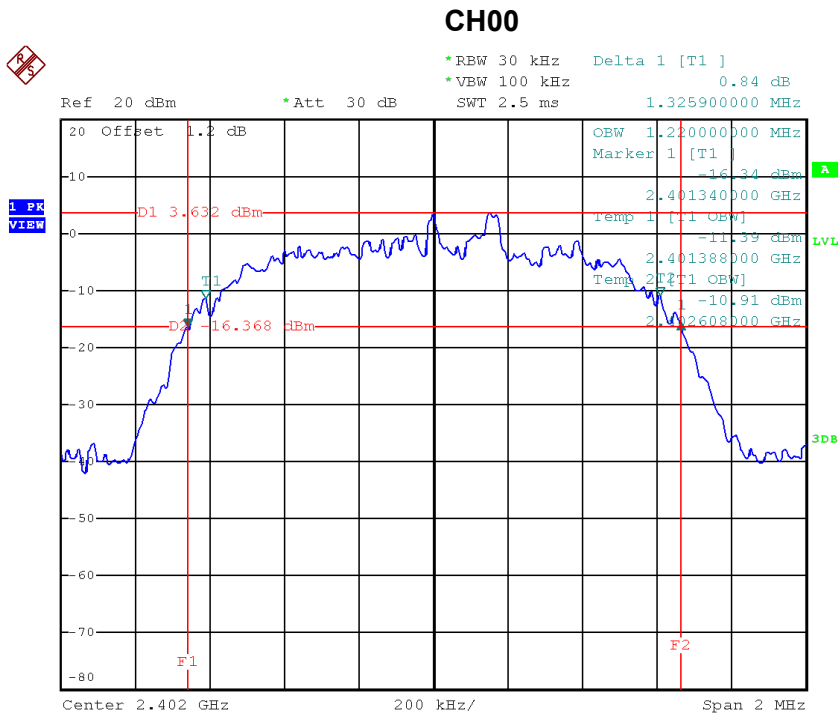

Date: 4.APR.2018 21:03:24

CH39

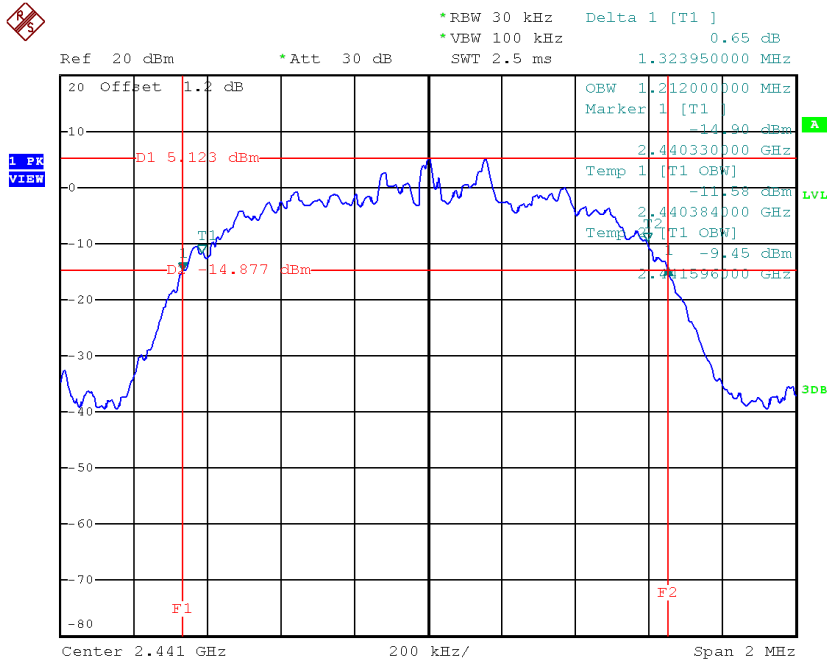

Date: 4.APR.2018 21:05:35

CH78

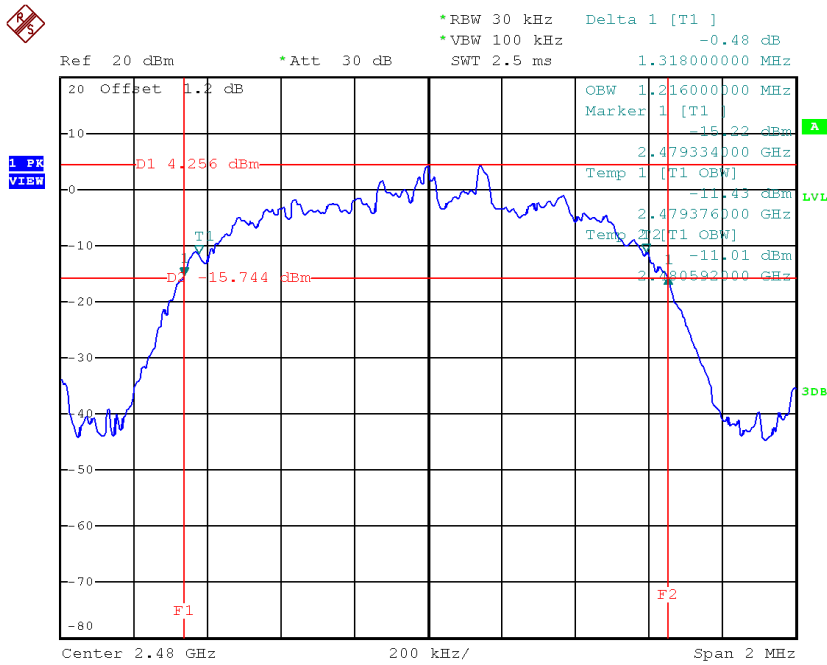

Date: 4.APR.2018 21:06:55

APPENDIX I - MAXIMUM OUTPUT POWER

Test Mode : TX Mode _1Mbps

Frequency (MHz)	Output Power (dBm)	Output Power (W)	Max. Limit (dBm)	Max. Limit (W)	Test Result
2402	8.40	0.0069	21.00	0.125	Pass
2441	8.98	0.0079	21.00	0.125	Pass
2480	8.68	0.0074	21.00	0.125	Pass

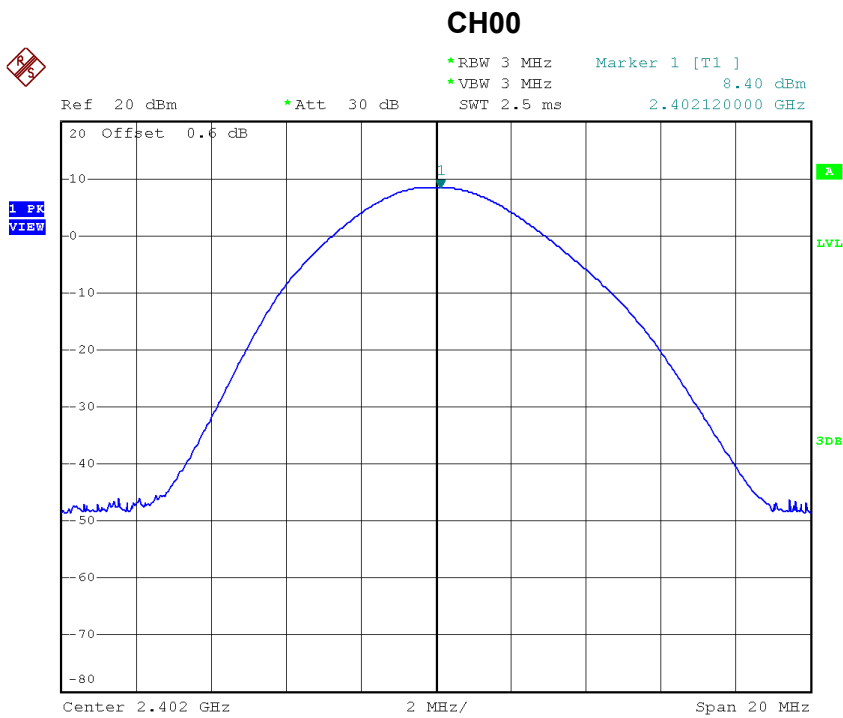

Date: 2.MAR.2019 10:06:02

CH39

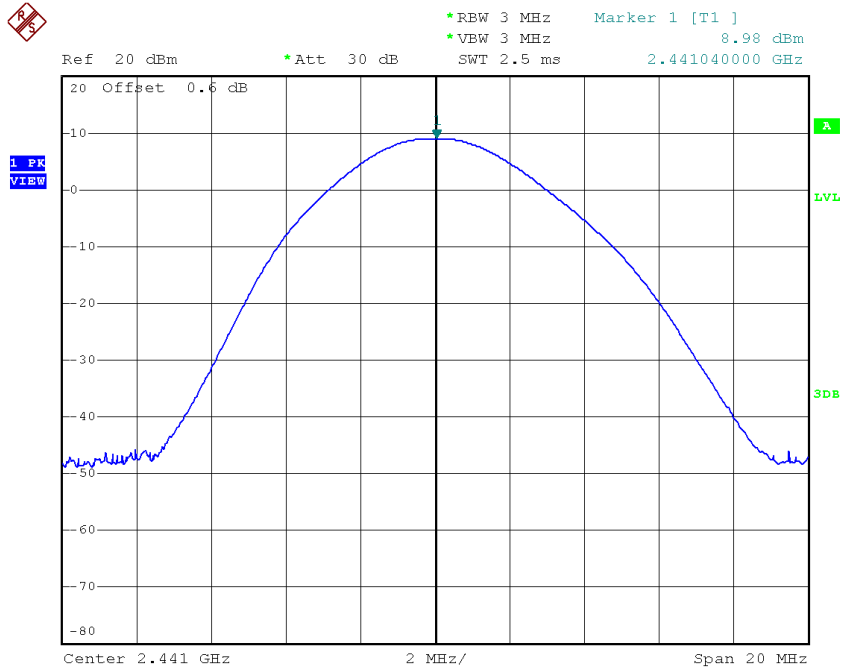

Date: 2.MAR.2019 10:00:11

CH78

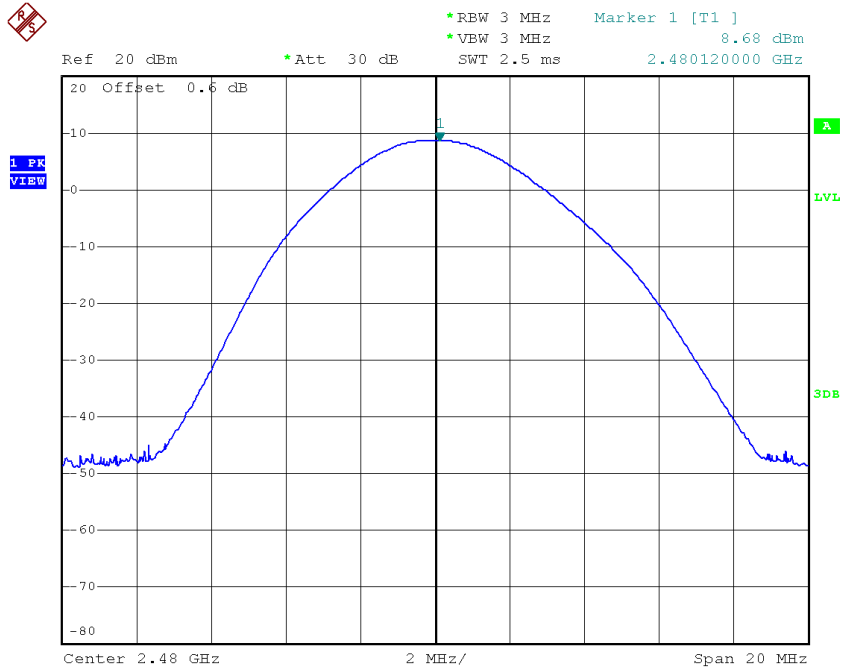

Date: 2.MAR.2019 10:00:41

Test Mode : TX Mode _3Mbps

Frequency (MHz)	Conducted Power (dBm)	Conducted Power (W)	Max. Limit (dBm)	Max. Limit (W)	Test Result
2402	7.34	0.0054	21.00	0.125	Pass
2441	7.77	0.0060	21.00	0.125	Pass
2480	7.60	0.0058	21.00	0.125	Pass

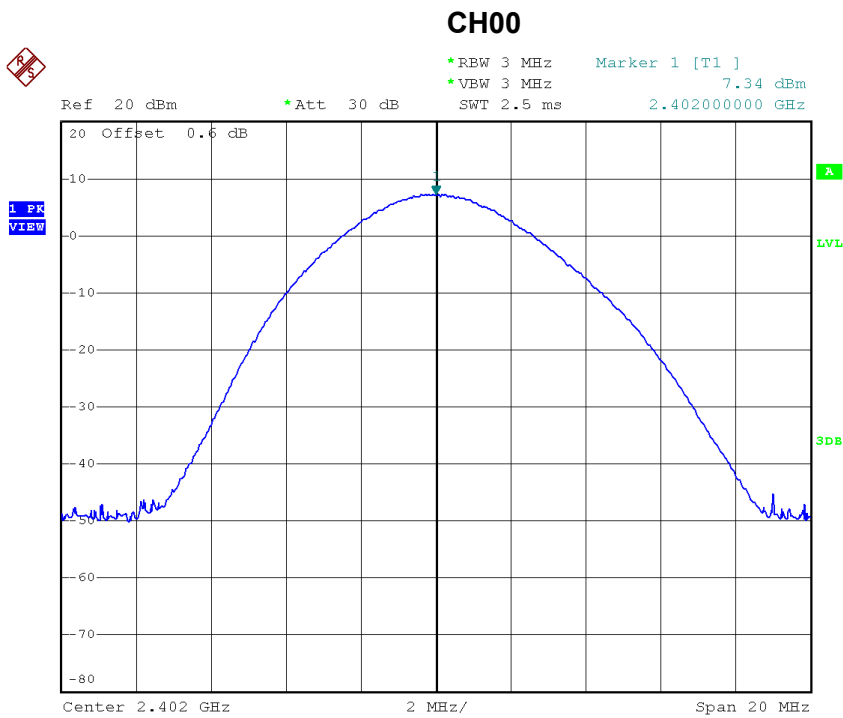

Date: 2.MAR.2019 10:01:10

CH39

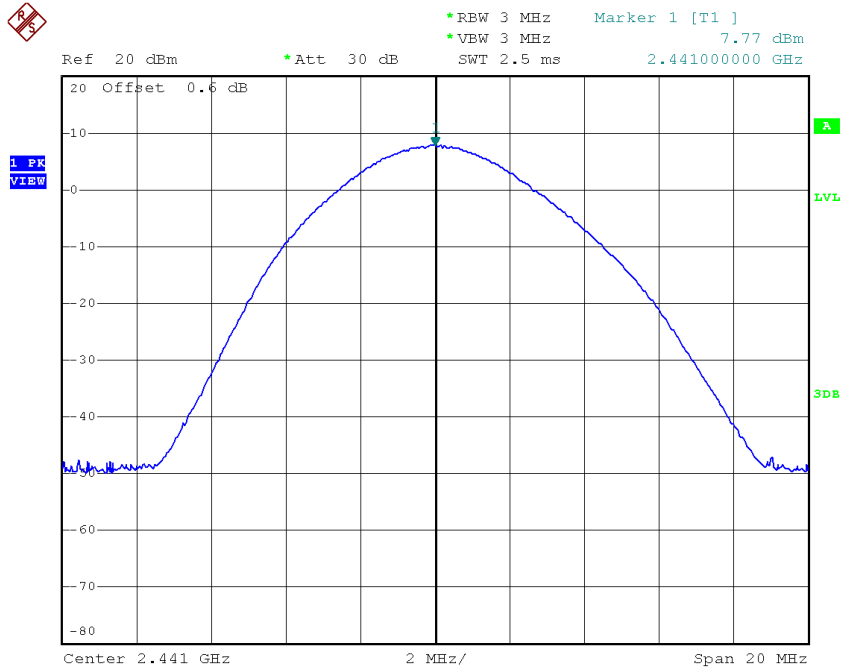

Date: 2.MAR.2019 10:01:39

CH78

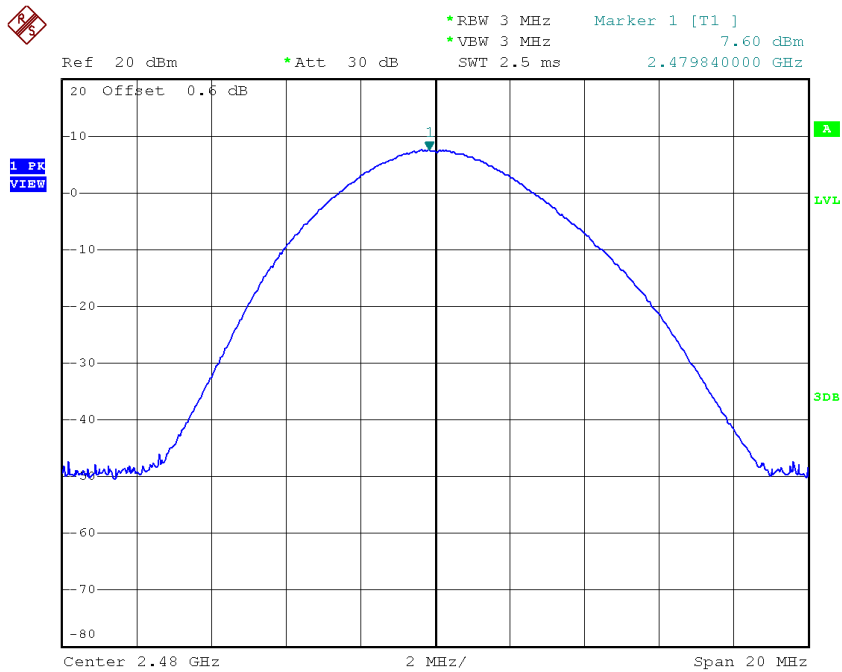

Date: 2.MAR.2019 10:02:10

APPENDIX J - CONDUCTED SPURIOUS EMISSION

CH00 (Lower)_1Mbps

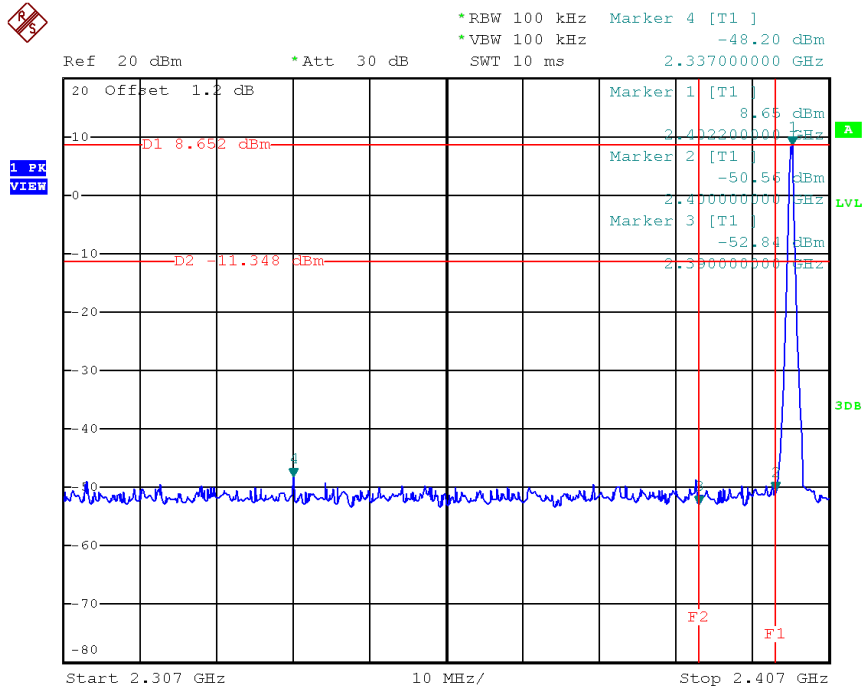

Date: 4.APR.2018 20:43:59

CH78 (Upper)_1Mbps

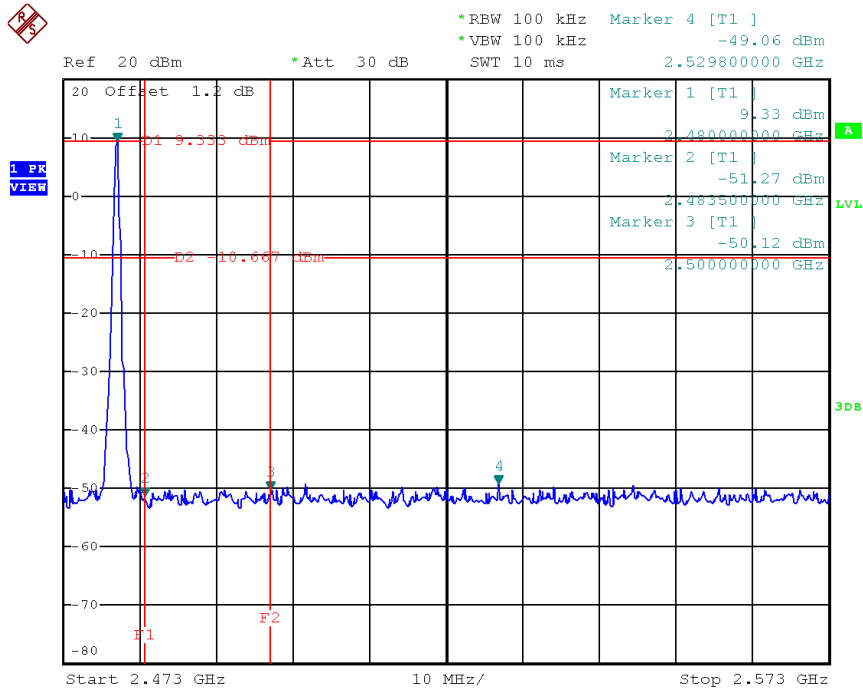

Date: 4.APR.2018 20:47:58

CH00 Hopping on mode (Lower)_1Mbps

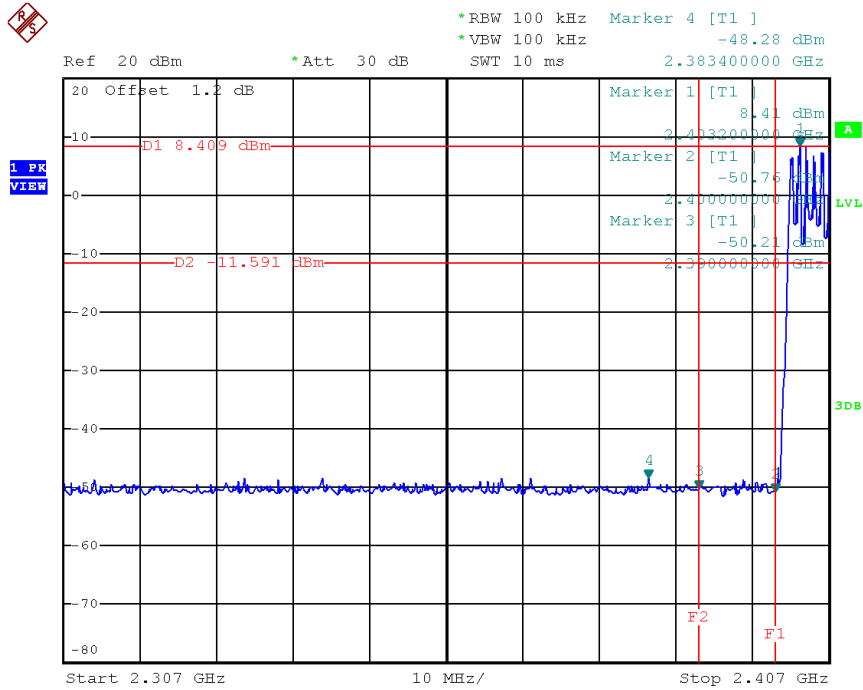

Date: 4.APR.2018 20:57:32

CH78 Hopping on mode (Upper)_1Mbps

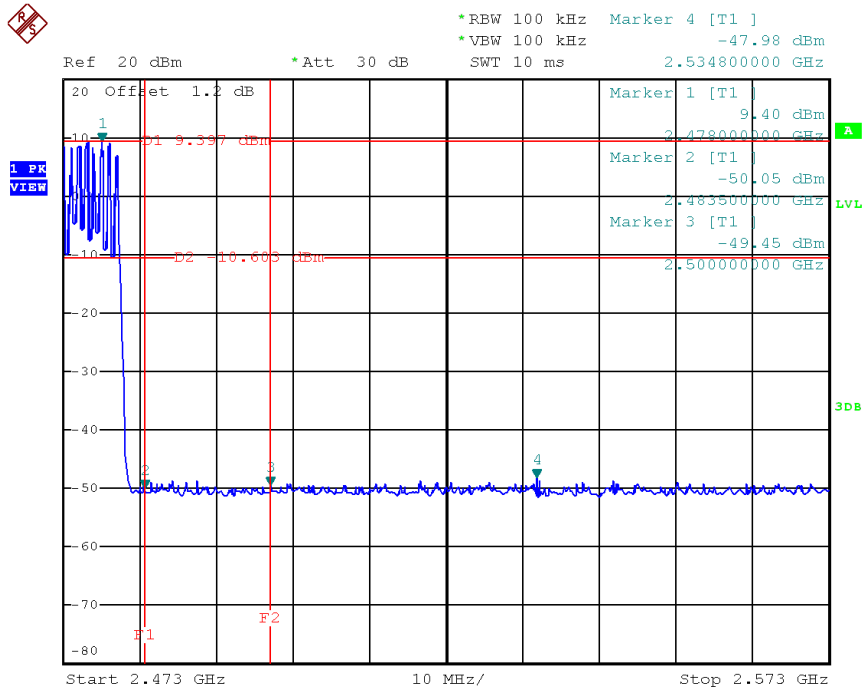

Date: 4.APR.2018 20:58:06

CH00 (10th Harmonic of the fundamental frequency) _1Mbps

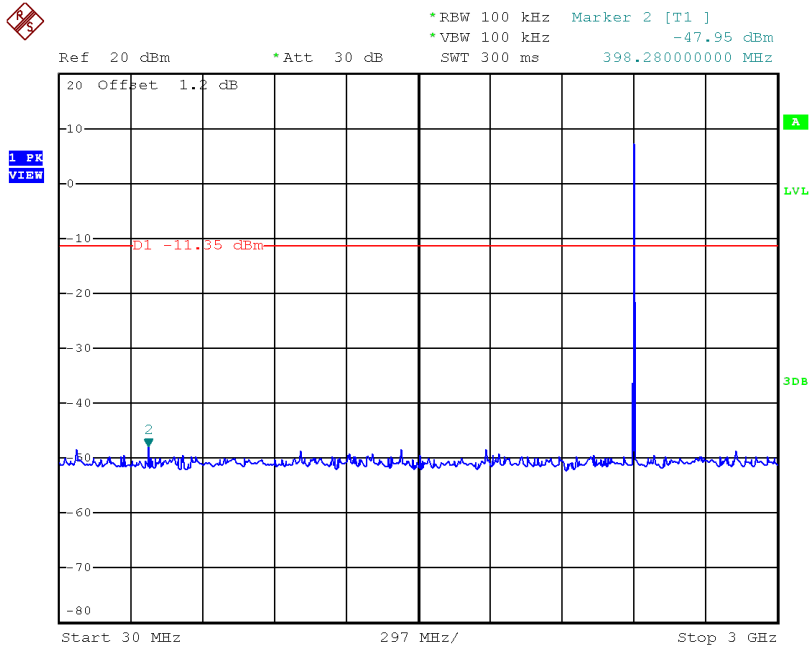

Date: 4.APR.2018 20:44:52

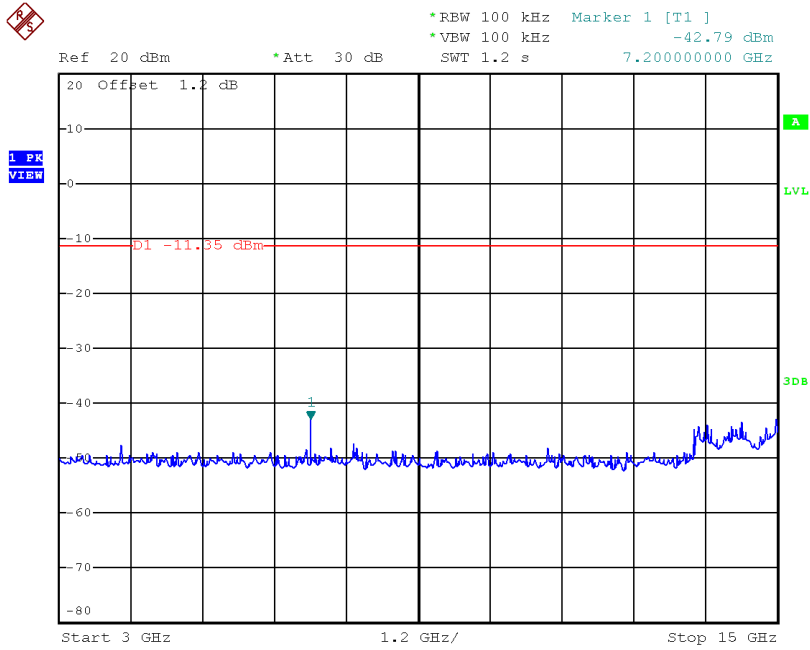

Date: 4.APR.2018 20:44:59

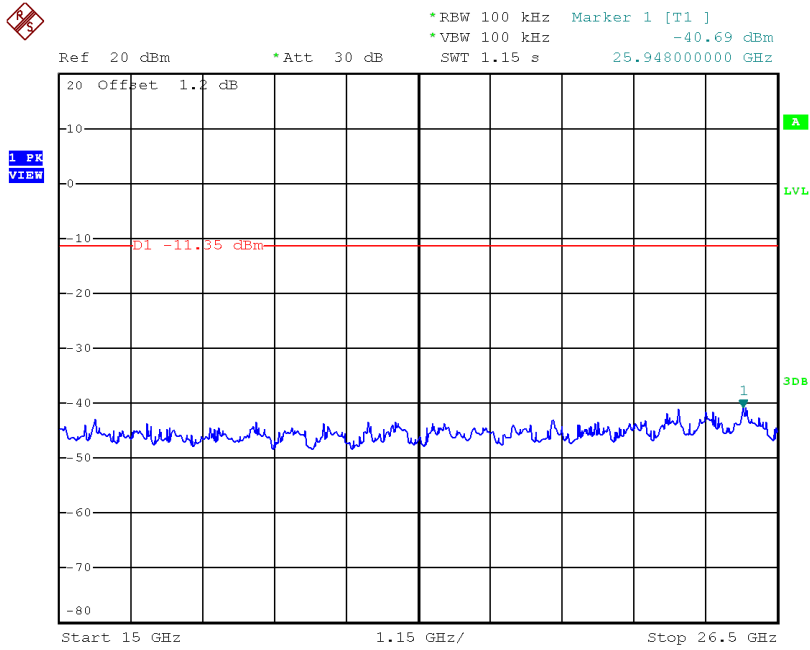

Date: 4.APR.2018 20:45:06

CH39 (10th Harmonic of the fundamental frequency) _1Mbps

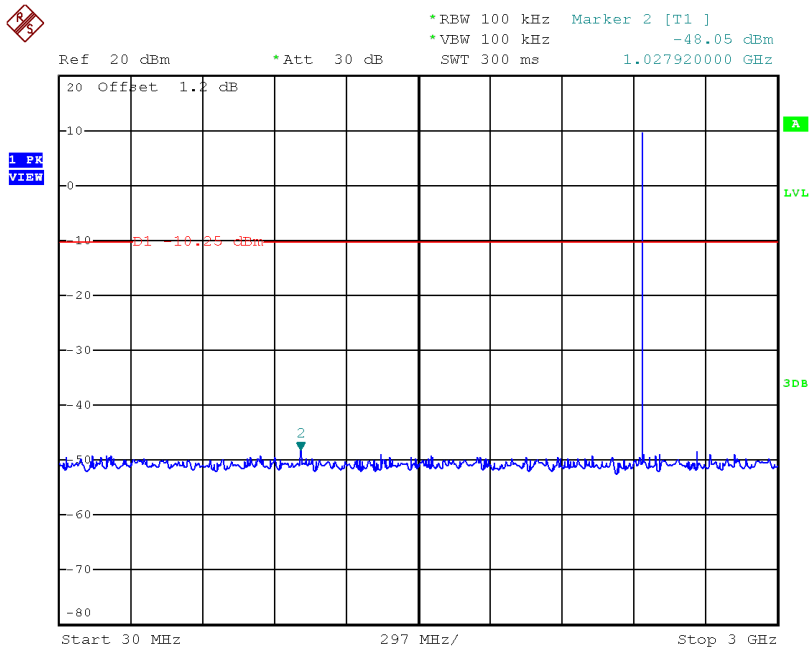

Date: 4.APR.2018 20:45:55

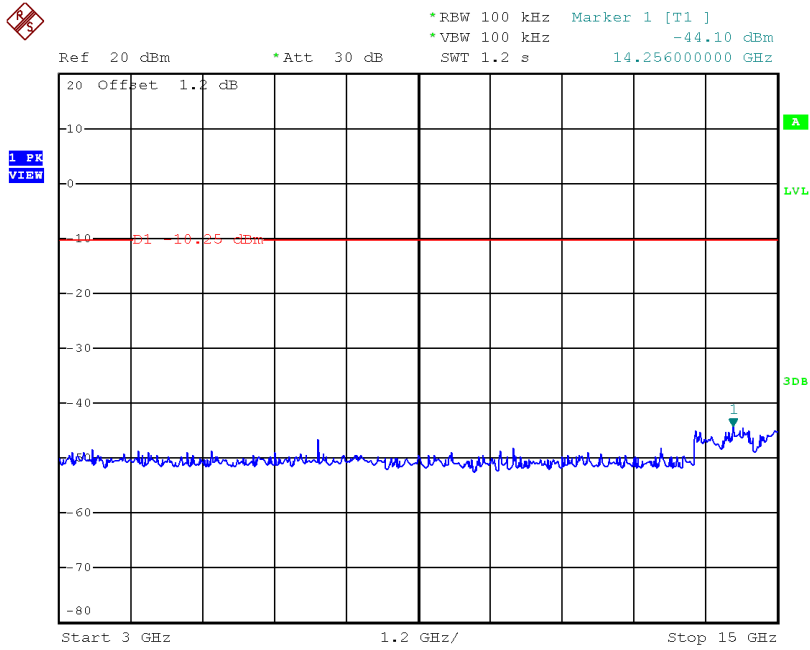

Date: 4.APR.2018 20:46:02

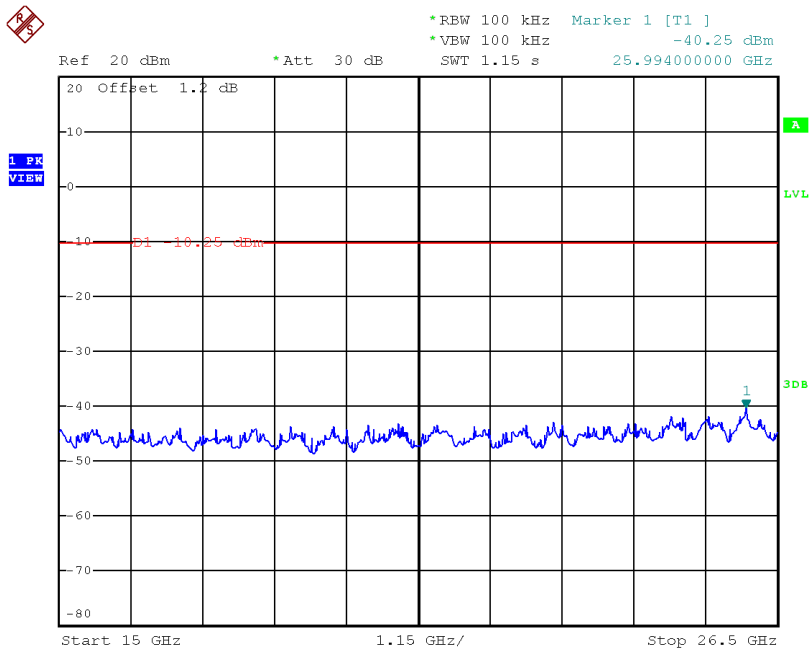

Date: 4.APR.2018 20:46:09

CH78 (10th Harmonic of the fundamental frequency) _1Mbps

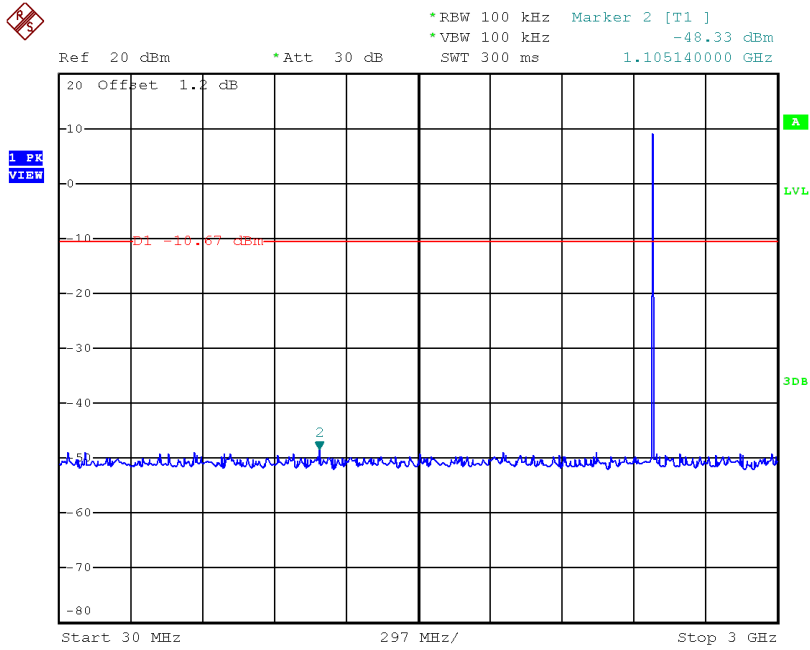

Date: 4.APR.2018 20:48:47

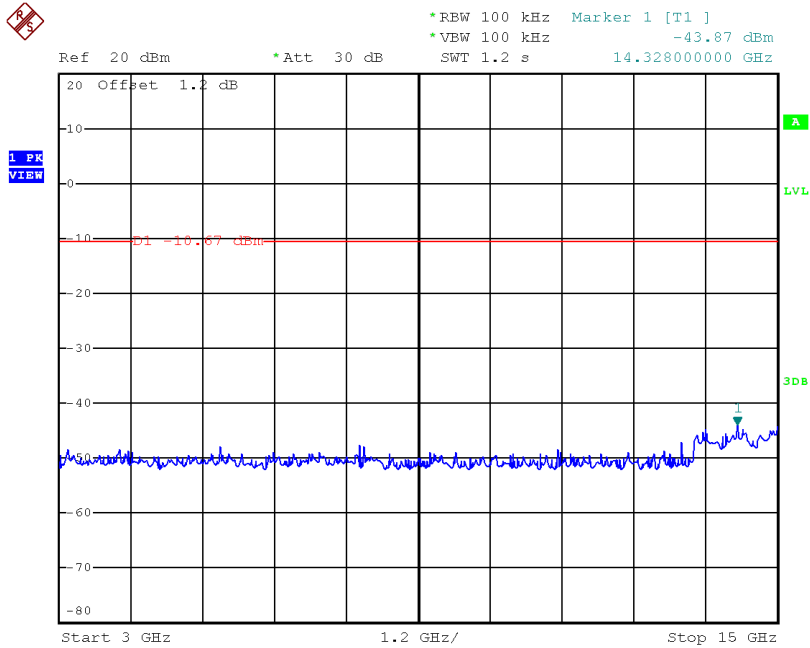

Date: 4.APR.2018 20:48:54

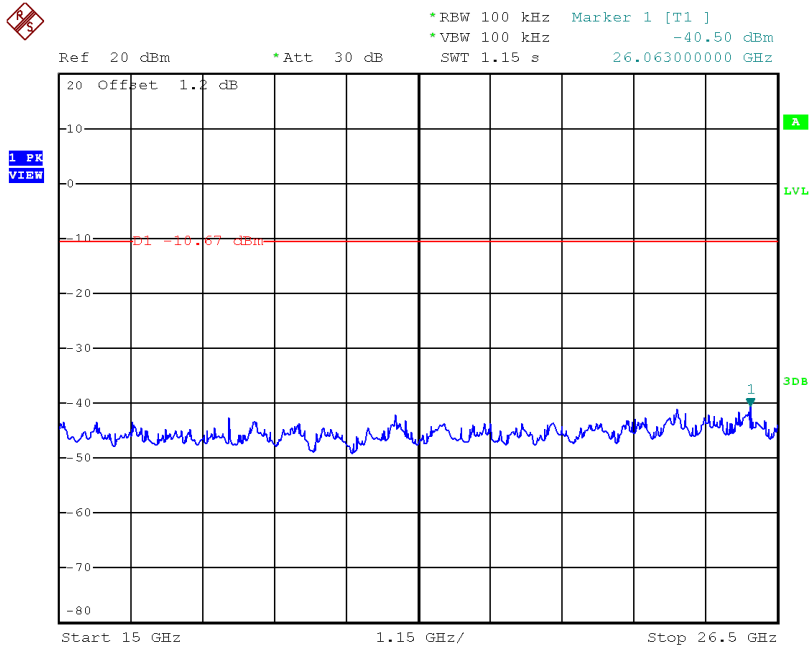

Date: 4.APR.2018 20:49:01

CH00 (Lower) _3Mbps

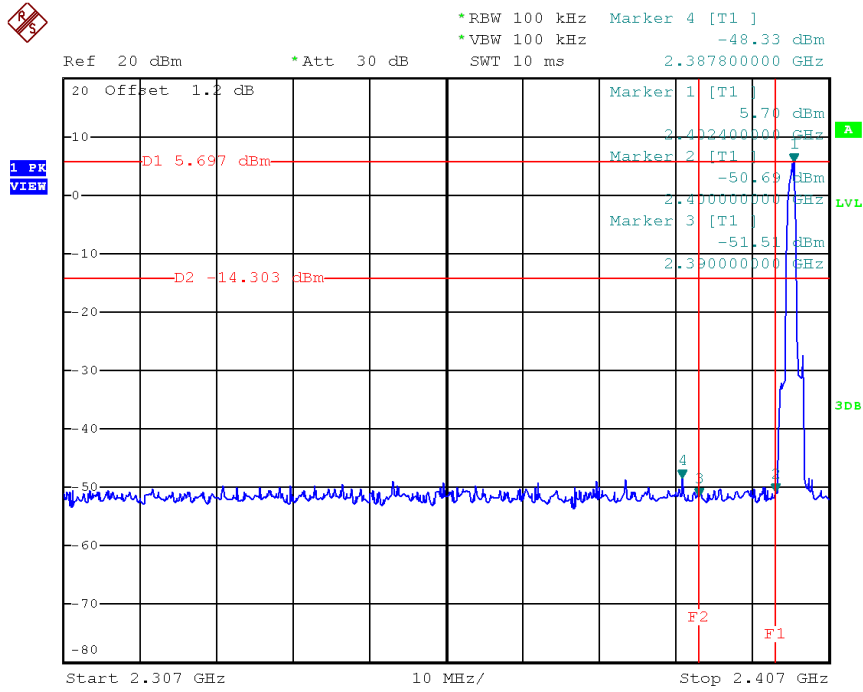

Date: 4.APR.2018 21:02:55

CH78 (Upper) _3Mbps

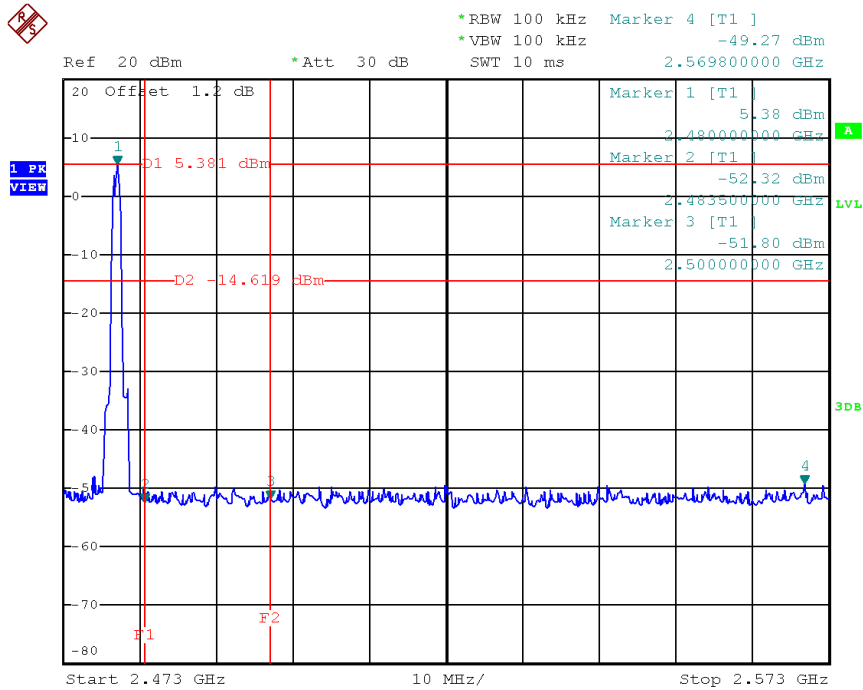

Date: 4.APR.2018 21:06:27

CH00 Hopping on mode (Lower)_3Mbps

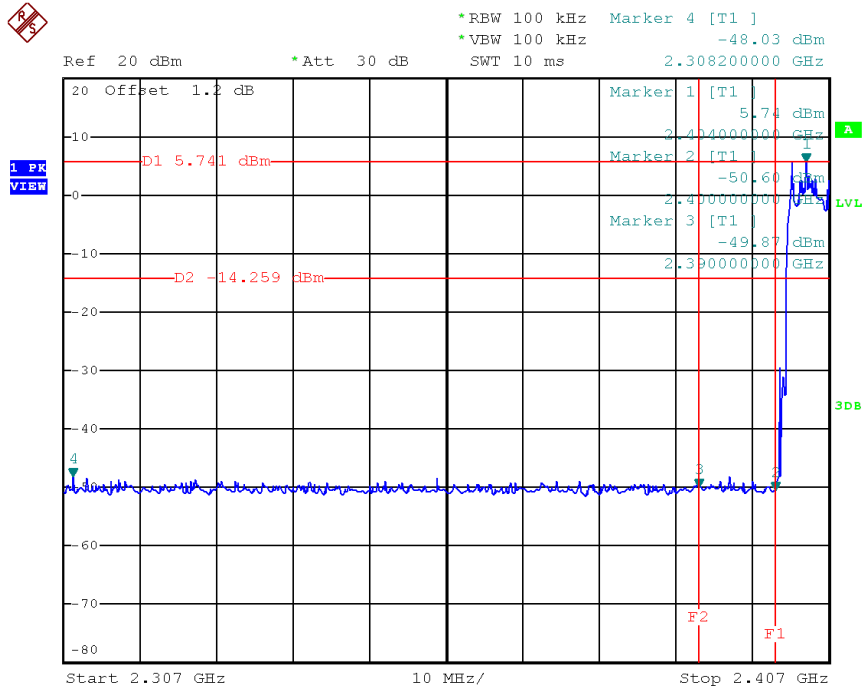

Date: 4.APR.2018 21:16:02

CH78 Hopping on mode (Upper)_3Mbps

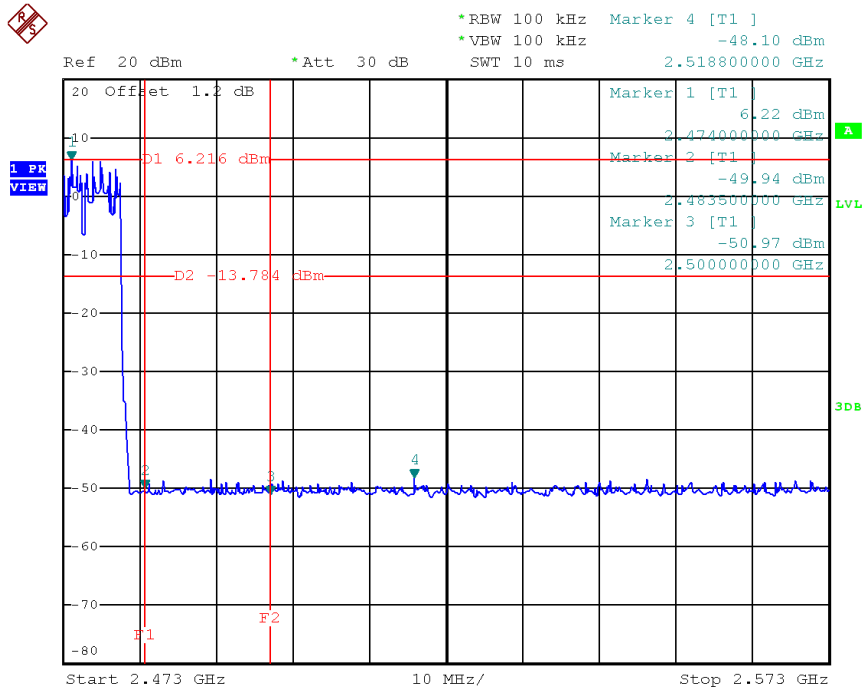

Date: 4.APR.2018 21:16:53

CH00 (10th Harmonic of the fundamental frequency) _3Mbps

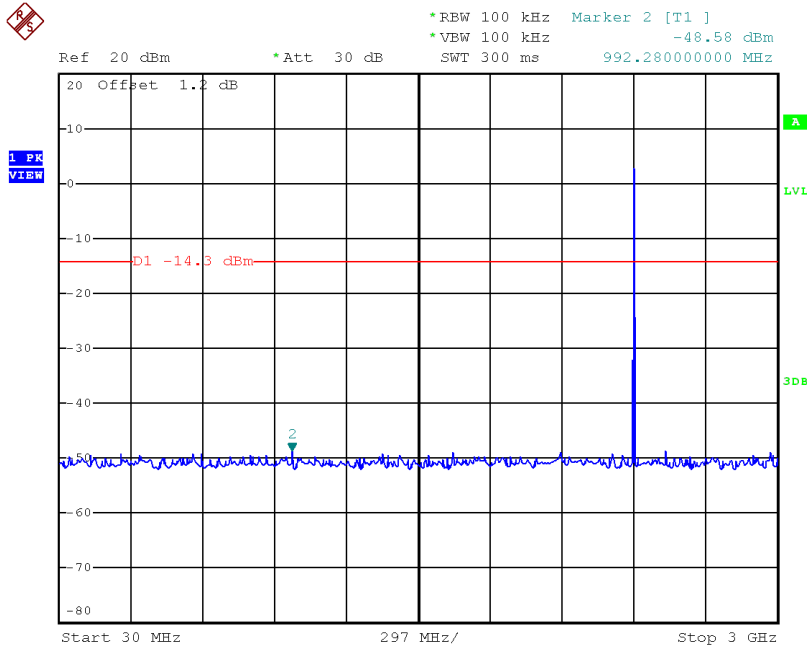

Date: 4.APR.2018 21:03:37

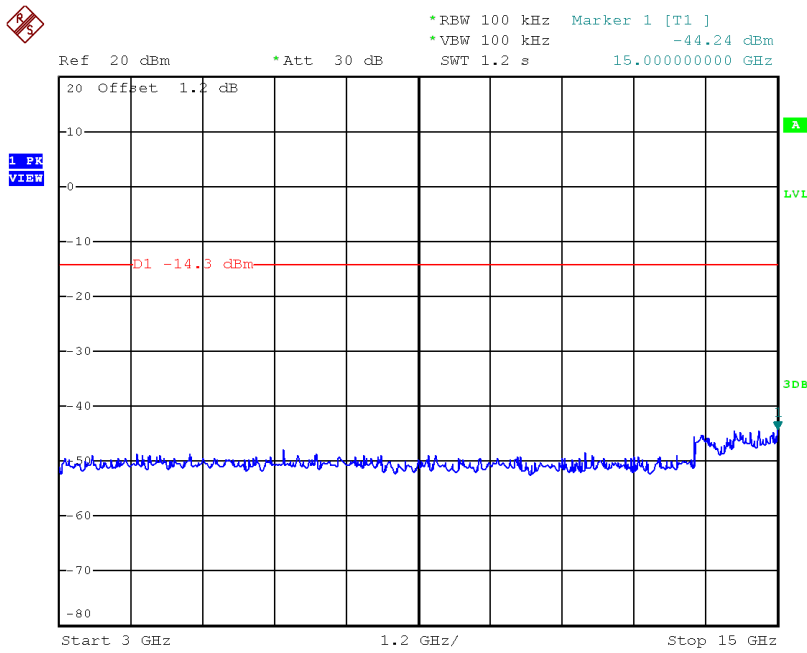

Date: 4.APR.2018 21:03:44

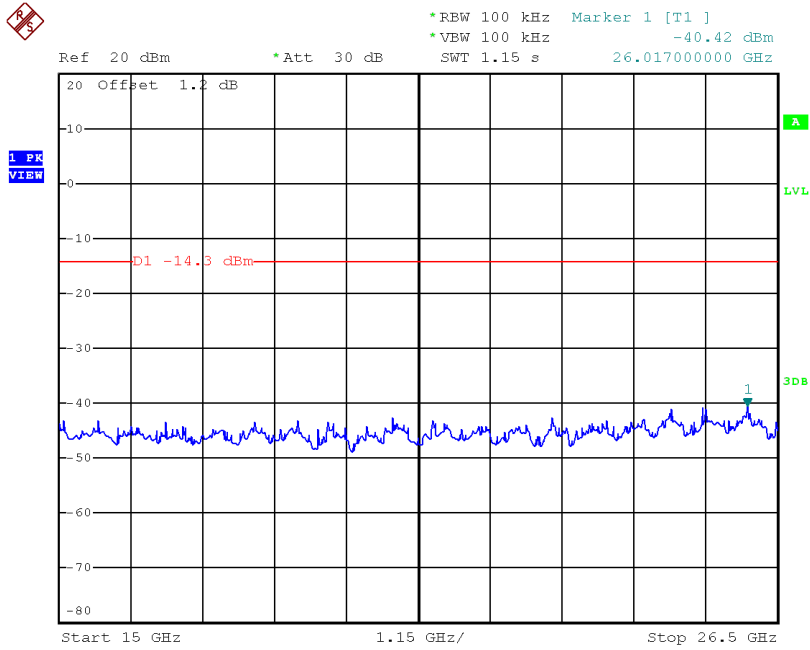

Date: 4.APR.2018 21:03:51

CH39 (10th Harmonic of the fundamental frequency) _3Mbps

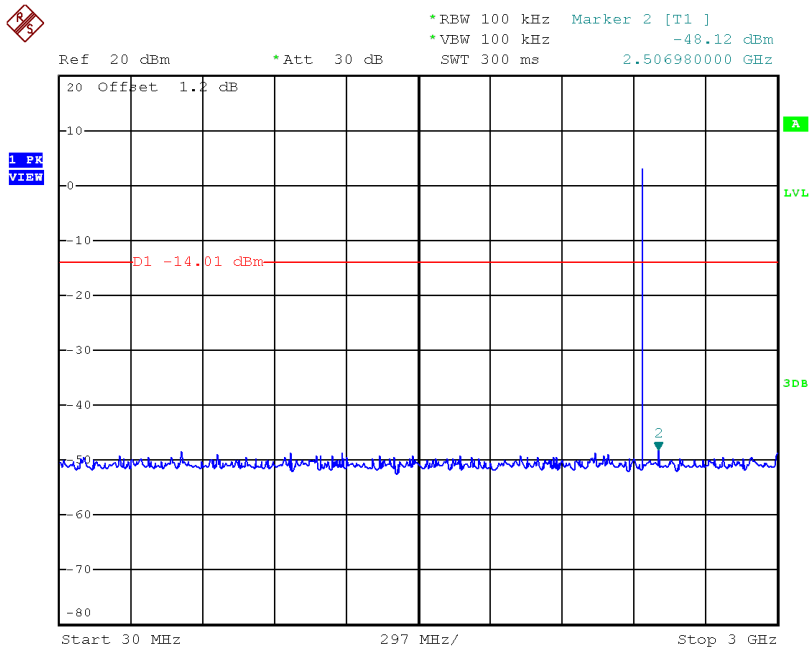

Date: 4.APR.2018 21:04:52

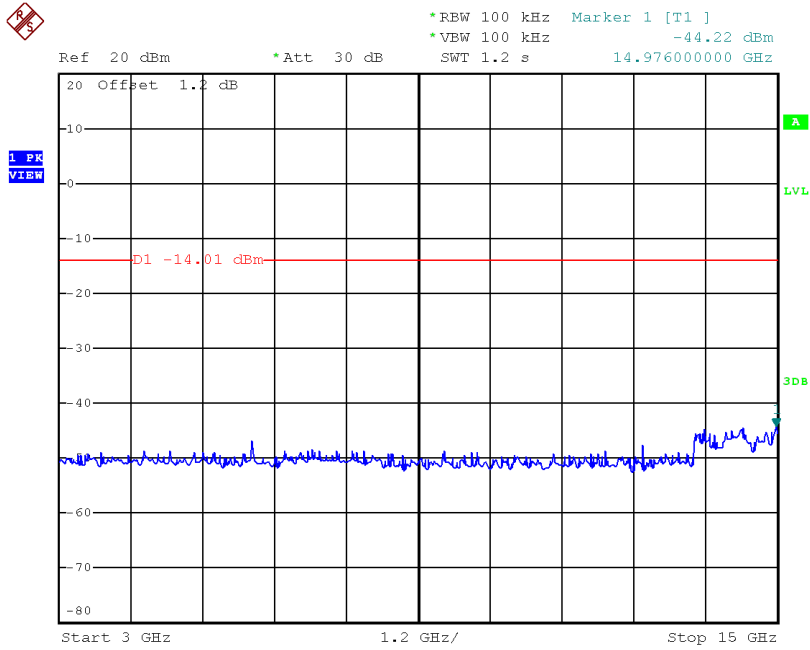

Date: 4.APR.2018 21:04:59

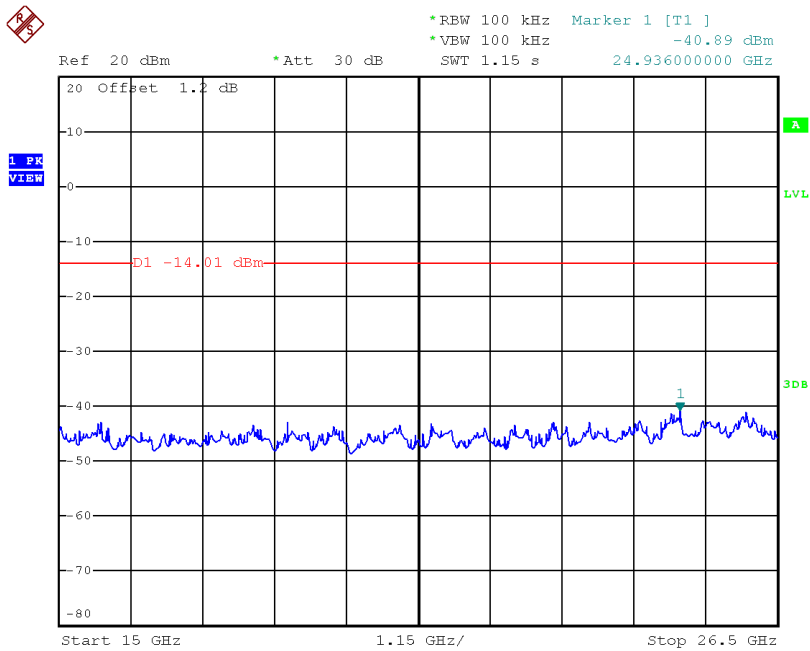

Date: 4.APR.2018 21:05:06

CH78 (10th Harmonic of the fundamental frequency) _3Mbps

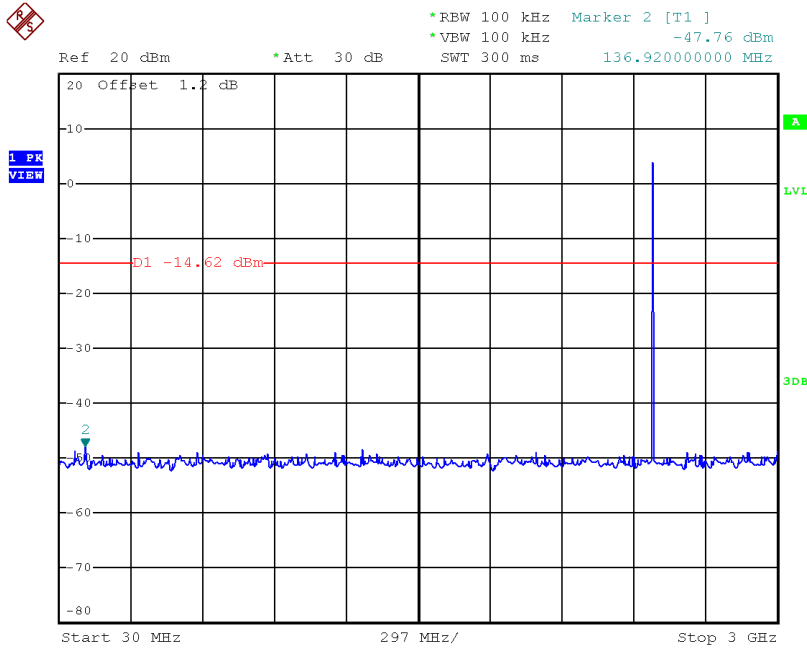

Date: 4.APR.2018 21:07:08

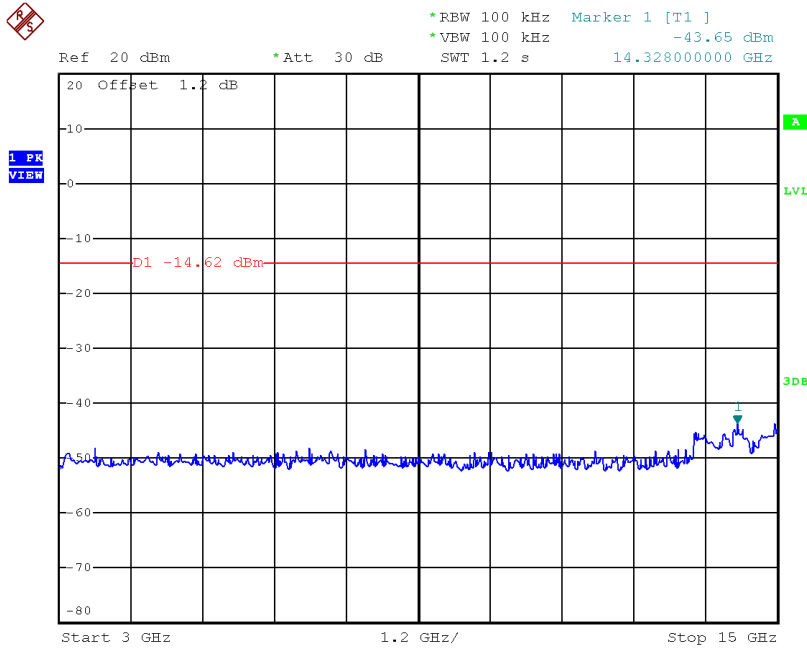

Date: 4.APR.2018 21:07:15

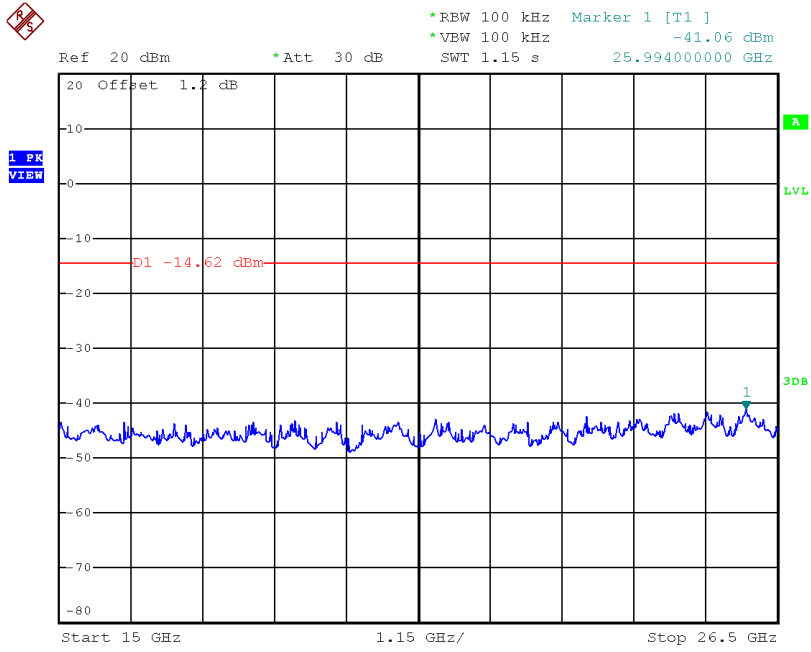

Date: 4.APR.2018 21:07:22

End of Test Report