

13. SETUP PHOTOS

RADIATED AND POWERLINE CONDUCTED EMISSIONS MEASUREMENT SETUP

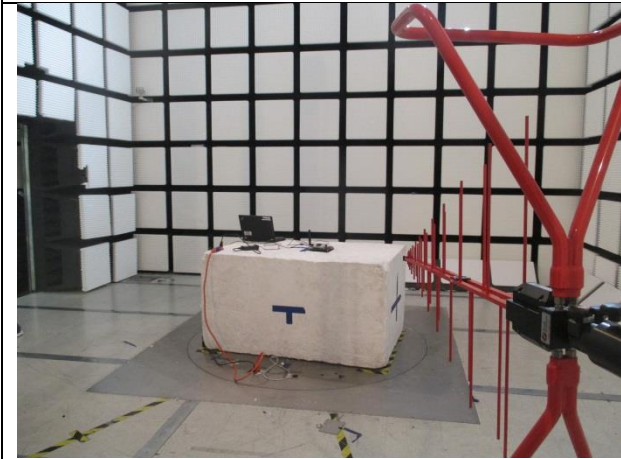

RADIATED FRONT PHOTO (BELOW 1 GHz)

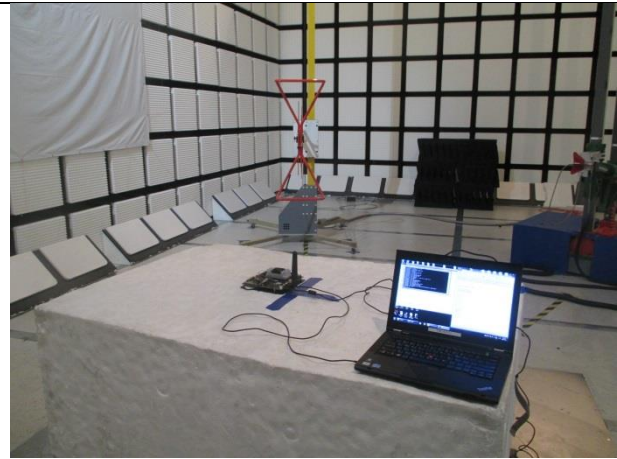

RADIATED BACK PHOTO (BELOW 1 GHz)

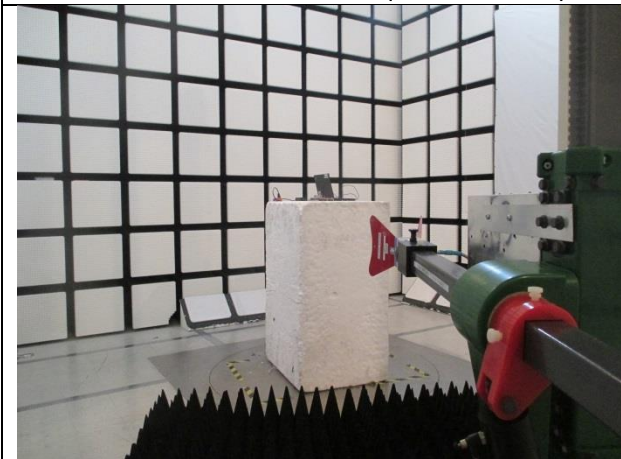

RADIATED FRONT PHOTO (ABOVE 1 GHz)



RADIATED BACK PHOTO (ABOVE 1 GHz)

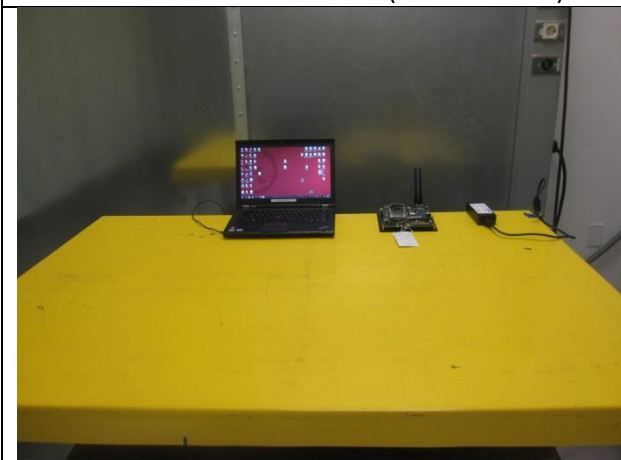

LINE CONDUCTED FRONT PHOTO



LINE CONDUCTED SIDE VIEW PHOTO

**ANTENNA PORT CONDUCTED RF MEASUREMENT SETUP AND
RADIATED RF MEASUREMENT SETUP FOR PORTABLE CONFIGURATION**

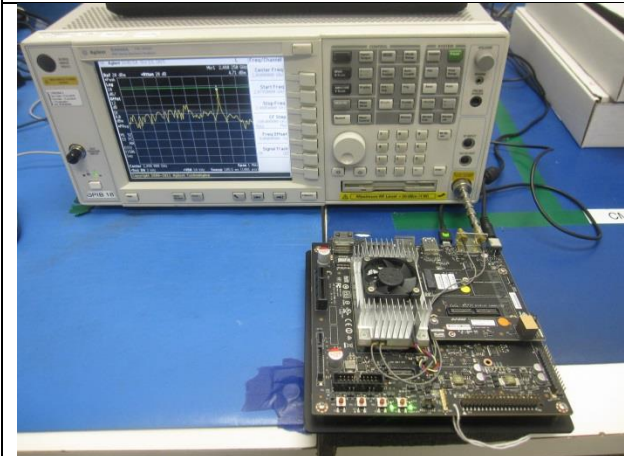

ANTENNA PORT CONDUCTED PHOTO

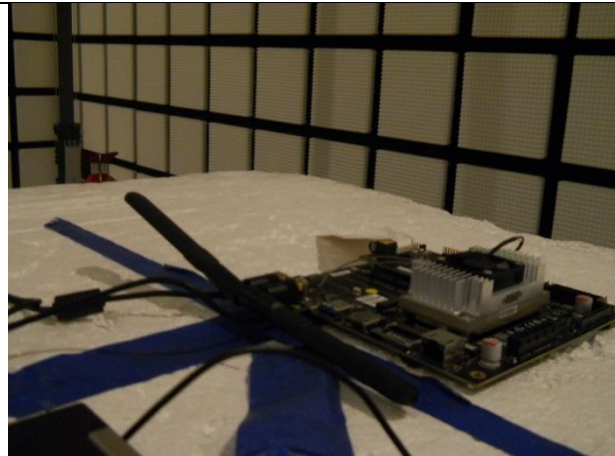

0 Degrees PHOTO

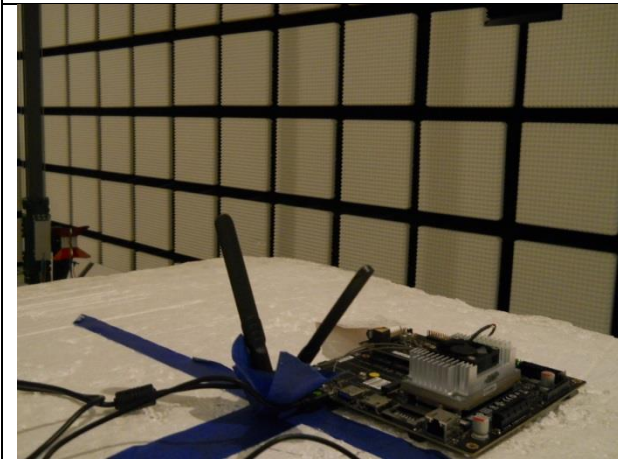

45 Degrees PHOTO

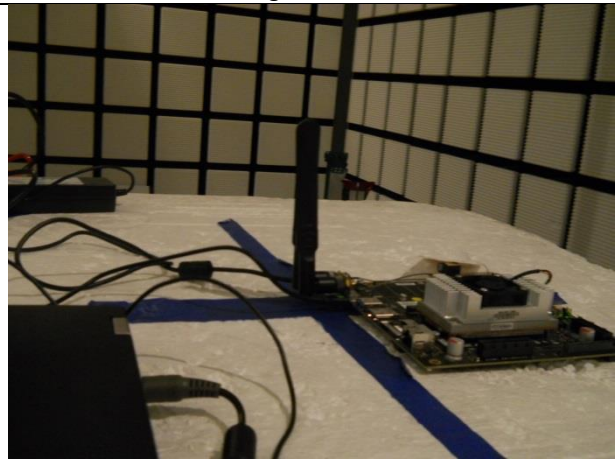

90 Degrees PHOTO

END OF REPORT

14. EUT PHOTOS

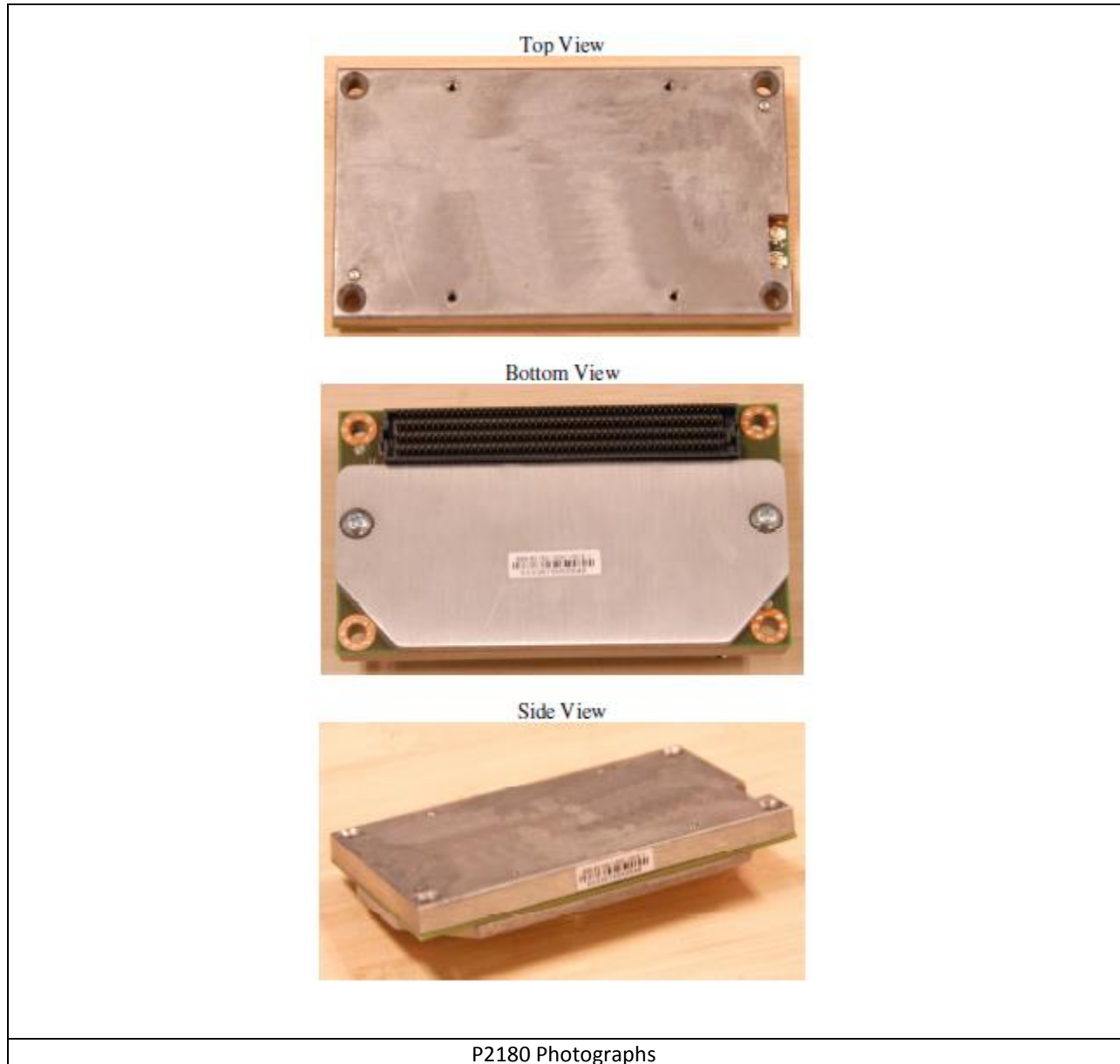

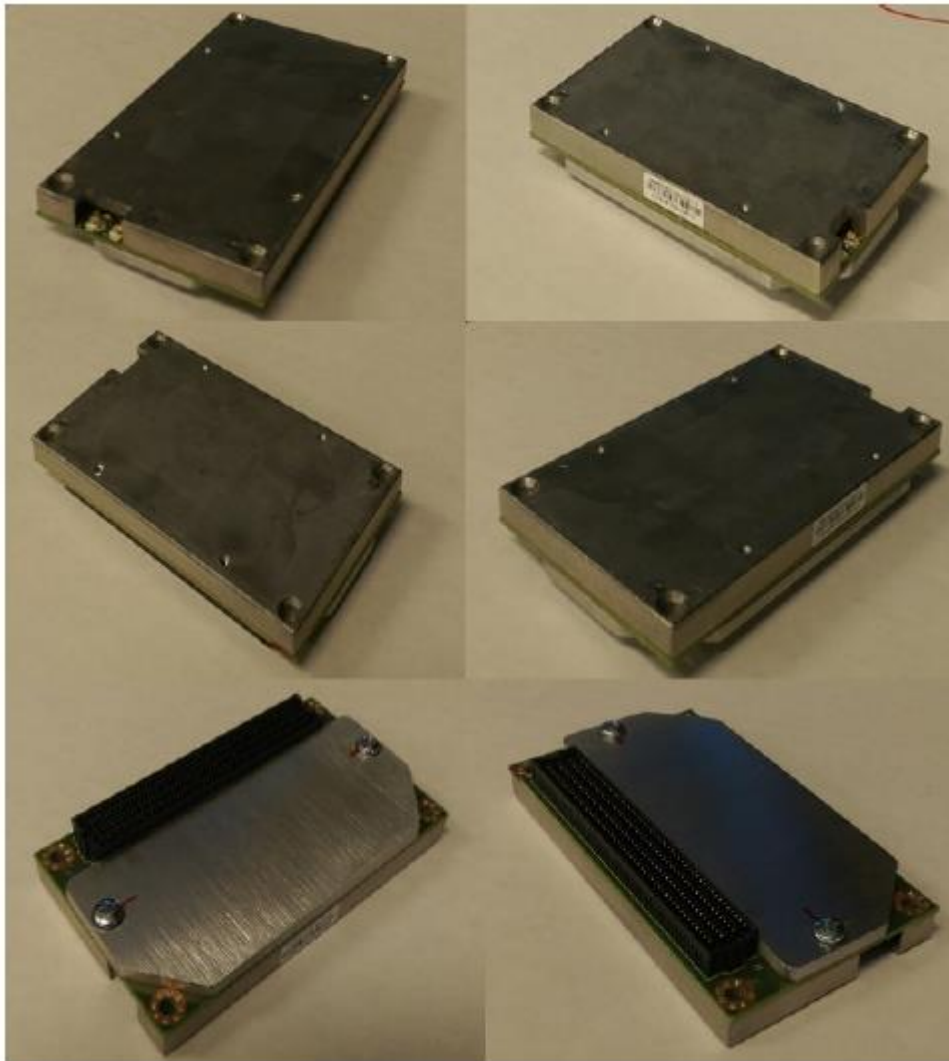

Side View (continued)

PCB View

Top View



Bottom View



PCB View

Heat Sink Internal View



Heat Sink Internal View

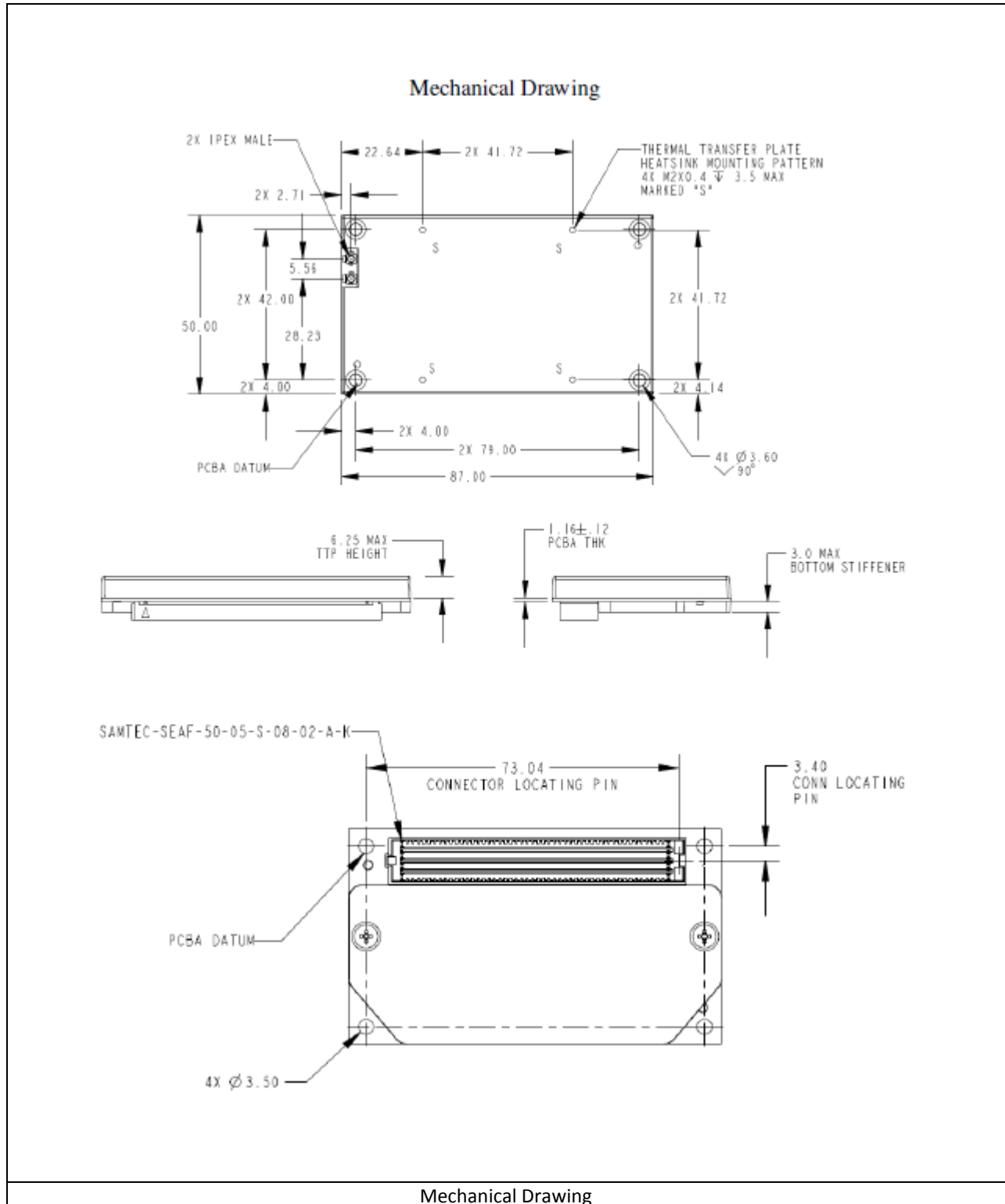

END OF REPORT