

# Table of Contents

<b>1. Introduction</b>	<b>7</b>
ABOUT SHIELD TABLET	7
NVIDIA Apps	7
Additional Apps	7
ABOUT SHIELD TABLET	8
NVIDIA Apps	8
Additional Apps	8
How to Use This Guide	9
SHIELD Tablet Overview	9
SHIELD Tablet with DirectStylus	10
Get Started	14
How to Charge Your SHIELD Device	14
How to Turn On Your Tablet	14
How to Use the Touchscreen	14
How to Complete NVIDIA Setup	15
How to Complete Android Setup	15
How to Turn Off Your Tablet	16
How to Restart Your Tablet	16
<b>2. Manage Your Tablet</b>	<b>17</b>
How to Navigate Your Tablet	17
Navigation Overview	17
How to Navigate Your Tablet	18
Navigation Overview	18
How to Connect to Wi-Fi	19
How to Connect to Wi-Fi	19
How to Scan for Available Wi-Fi Networks	19
How to Remove a Wi-Fi Network Connection	20
LTE Models	20
Setting up an lte connection	21
LTE settings	21
How to Use the Stylus	22
Stylus Behavior	22
Stylus Apps	24
How to Customize Your Device	25
How to Open Settings	25
Sounds	25
Display	25
How to Change the System Font Size	26
Power Saving	26
How to Organize Your Apps	27
Home Screen	27
Apps and Widgets	28
Folders	29
SD Card	29
How to Manage Notifications	29
How to Change the Notification Sound	29
How to View or Hide Notification Details	30
How to Clear a Notification	30
How to Use Quick Settings	30
How to Use the Google Keyboard	31

Google Keyboard (Alphabet)	31
Google Keyboard (Numbers and Symbols)	32
How to Insert Emoticons or Emoji Characters	32
How to Enter Letter Accents and Variations	32
How to Use Gesture Typing	33
how to use handwriting recognition	33
How to Use Voice Typing	34
How to Use Voice Typing	34
How to Allow Offensive Words	35
How to Add Languages	35
How to Use Offline Voice Typing	35
How to View Device Status	36
System Bar Status Icons	36
How to View Device Status Details	36
How to Secure Your Device	36
How to Lock Your Tablet	36
How to Unlock Your Tablet	36
How to Set a Screen Lock	37
Screen Lock Options	37
How to Update Your Device	37
How to Install Updates	37
<b>3. Play Games</b>	<b>39</b>
How To Find Games and Gaming News	39
How to Open the SHIELD Hub	39
How to View Gaming News	39
How to View Your Installed Android Games	39
How to Play PC Games from Your SHIELD Device	39
How to Turn On or Turn Off SHIELD App Notifications	39
How to Shop for SHIELD Devices and Accessories	40
How To Find Games and Gaming News	40
How to Open the SHIELD Hub	40
How to View Gaming News	40
How to View Your Installed Android Games	40
How to Play PC Games from Your SHIELD Device	40
How to Turn On or Turn Off SHIELD App Notifications	41
How to Shop for SHIELD Devices and Accessories	41
How to Connect Your Controller to a SHIELD Device	41
How to Connect Your Controller	41
How to Reconnect the Controller	42
How to Troubleshoot Connection Problems	42
Use Your Tablet as a Game Console	43
How to Connect Your Device to an HDTV	43
How to Record and Share Your Gameplay	43
How to Record and Share Your Gameplay	44
How to Record Your Gameplay Without Sharing	44
How to Set the Video Quality	45
How to Find Your Gameplay Videos	45
How to Record Your Gameplay Automatically	45
How to Mute the Microphone for Gameplay Videos	47
How to Block Chat from Your Twitch Broadcast	47
How to View Recording and Broadcasting Status	48
How to Broadcast Your Gameplay to Twitch TV	49
How to Create a Twitch Account	49
How to Connect Your Tablet to Twitch	49
How to Broadcast Your Gameplay to Twitch	49

How to Stop Broadcasting	50
How to Share Your Broadcast	50
How to Apply the Recommended Quality and Server Settings	50
How to Change the Twitch Server	51
How to Pause Broadcasting Automatically When You Switch Apps	51
<b>4. GameStream</b>	<b>53</b>
nvidia gamestream	53
System Requirements for GAMESTREAM	53
PC Games Supported by GameStream	54
how gamestream works	54
How to Configure GameStream PC	54
how to configure gamestream PC	55
Streaming non-GAMESTREAM ready games	57
Remote GAMESTREAM BETA	57
Wake on LAN / Remote Log-In	59
Advanced GAMESTREAM Features	59
GAMESTREAM for GeForce Notebooks	60
steam big picture	61
troubleshooting pc game streaming	61
General Troubleshooting Issues	61
bluetooth keyboard and mouse support	62
using gamestream in console mode	62
Setup Requirements	63
Configure GameStream for 1080p	63
geforce experience	64
<b>5. shield controller</b>	<b>65</b>
Connect SHIELD controller to your SHIELD portable	65
SHIELD controller Overview	65
how to turn on the controller	66
How to turn off the controller	66
<b>6. gamepad mapper</b>	<b>67</b>
creating your own gamepad mapper profile	67
<b>7. Extend Your Tablet</b>	<b>69</b>
How to Use Bluetooth Accessories	69
Bluetooth Behavior	69
Bluetooth Accessories	69
How to Use Bluetooth Accessories	70
Bluetooth Behavior	70
Bluetooth Accessories	71
How to Use Headphones or Headsets	72
How to Add Storage with a MicroSD Card	72
How to Insert a MicroSD Card	72
How to Unmount and Eject a MicroSD Card	73
How to Move Content to a MicroSD Card	73
How to View MicroSD Card Storage	73
How to Install a Micro-SIM Card	73
How to Install a Micro-SIM Card	73
How to Remove a Micro-SIM Card	74

<b>8. How to Use NVIDIA Lasso Capture</b>	<b>75</b>
How to Enable Access to Lasso Capture	75
How to Open Lasso Capture	75
Captures	75
How to Capture a Screenshot of the Whole Screen	75
How to Capture a Rectangular Region	75
How to Capture a Free-Hand Region	76
How to Share a Capture	76
How to Save a Capture to PDF	76
How to Take a Full-Screen Screenshot Without the Stylus	76
<b>9. How to Use NVIDIA Dabblers</b>	<b>77</b>
How to Open NVIDIA Dabblers	77
Learn the NVIDIA Dabblers Workspace	77
Manage	78
How to View the NVIDIA Dabblers Help Tips	78
How to Undo or Redo the Previous Action	78
How to Save Your Work	78
How to Load Your Work	78
How to Print Your Work	78
How to Show or Hide the Toolbar	78
Create Artwork	79
NVIDIA Dabblers Painting Styles	79
NVIDIA Dabblers Tools	79
How to Adjust Brush Styles	80
How to Show or Hide the Color Palette	80
How to Mix Colors	82
How to Select RGB Colors	82
How to Adjust the Water Level	83
How to Lock the Water Level	84
How to Use Shape Recognition	84
How to Use Gravity	84
How to Dry Your Watercolor Instantly	85
How to Add Vector Shapes	85
Layers	86
Accessing Layer Operations	86
The following table shows the available layer options.	88
Layer Tools	88
How to Zoom and Move Canvas	88
Sharing	88
Video Recording	88
File Sharing	89
Global Effects	89
How to Dynamically Adjust Lighting	89
Stylus-Only Mode	89
<b>10. SHIELD Legal</b>	<b>91</b>
SHIELD LEGAL	91
Regulatory	91
health and safety information	91
important safety information	91
symbols on equipment	92
Headset/Earphone volume level notice	92
general precautions	92
POWER RATING	93

SHIELD Tablet Compliance	94
United States	94
Canada	95
Europe	95
Japan	96
Australia/New Zealand	96
Russia/kazakhstan/belarus	96
South Korea	97
Bluetooth	97
Wi-Fi Alliance	97
notices and trademarks	98



# Introduction

## ABOUT SHIELD TABLET

Thank you for choosing the NVIDIA® SHIELD™ tablet.

Your NVIDIA device is powered by the NVIDIA Tegra K1 mobile processor and the Google Android operating system. The included apps take full advantage of the NVIDIA Tegra K1's Kepler graphics core.

Your device also comes with several additional apps so you can get started right away -- surf the web, check your e-mail, take pictures, play games, and more.

## NVIDIA Apps

### DirectStylus Launcher

The DirectStylus Launcher provides quick access to apps that work well with a stylus. For more information, see [How to Use the Stylus](#).

### NVIDIA Dabblers

NVIDIA® Dabblers™ is a drawing and painting app that provides watercolor, oil painting, and sketching capabilities. For more information, see [How to Use NVIDIA Dabblers](#).

### NVIDIA Lasso Capture

NVIDIA® Lasso Capture provides a quick and easy way to take screenshots of all or part of your screen. You can also annotate and share the captures.

For more information, see [How to Use NVIDIA Lasso Capture](#).

### NVIDIA SHIELD Hub

NVIDIA® SHIELD Hub is the place to find Android and PC games that are optimized for your SHIELD devices, providing a console-quality gaming experience wherever you are. Read professional game reviews and view high-resolution screenshots, HD videos, and behind-the-scenes footage. For more information, see [How to Find Games and Gaming News](#).

## Additional Apps

### Adobe Reader by Adobe

Adobe Reader allows you to view and annotate PDF files on your device. To learn more, visit [Adobe Reader](#) in the Google Play store.

### Camera Awesome by SmugMug

Camera Awesome provides slow-motion video, enhanced HDR, and integrated stylus support in addition to a number of shooting and editing features. To learn more, visit [Camera Awesome](#) in the Google Play store.

### ES File Explorer by ES APP Group

ES File Explorer is a file and application manager. Kill tasks, manage downloads, and store files in the cloud. ES File Explorer also allows you to access your media on other Android devices and computers. To learn more, visit [es File Explorer](#) in the Google Play store.

### Evernote by Evernote Corporation

Evernote helps you remember things across all of your devices. Your notes, images, voice reminders, and lists are all searchable wherever you are, from any device. To learn more, visit [Evernote](#) in the Google Play store.

### JusWrite by Plackal Tech

JusWrite is a handwriting-friendly organizational app. Use your stylus to write lists by hand. You can categorize and prioritize your lists, mark list items complete, and more. To learn more, visit [JusWrite](#) in the Google Play store.

## Write by Stylus Labs

Write is a word processor for handwriting. Use your stylus to write, edit, sketch, organize, and bookmark handwritten documents on your tablet. To learn more, visit [Write](#) in the Google Play store.

## Twitch by Twitch Interactive

With the Twitch viewing app, you can watch live broadcasts of the games you love and chat with the players you follow. To learn more, visit [Twitch](#) in the Google Play store.

# ABOUT SHIELD TABLET

Thank you for choosing the NVIDIA® SHIELD™ tablet.

Your NVIDIA device is powered by the NVIDIA Tegra K1 mobile processor and the Google Android operating system. The included apps take full advantage of the NVIDIA Tegra K1's Kepler graphics core.

Your device also comes with several additional apps so you can get started right away -- surf the web, check your e-mail, take pictures, play games, and more.

## NVIDIA Apps

### DirectStylus Launcher

The DirectStylus Launcher provides quick access to apps that work well with a stylus. For more information, see [How to Use the Stylus](#).

### NVIDIA Dabbler

NVIDIA® Dabbler™ is a drawing and painting app that provides watercolor, oil painting, and sketching capabilities. For more information, see [How to Use NVIDIA Dabbler](#).

### NVIDIA Lasso Capture

NVIDIA® Lasso Capture provides a quick and easy way to take screenshots of all or part of your screen. You can also annotate and share the captures.

For more information, see [How to Use NVIDIA Lasso Capture](#).

### NVIDIA SHIELD Hub

NVIDIA® SHIELD Hub is the place to find Android and PC games that are optimized for your SHIELD devices, providing a console-quality gaming experience wherever you are. Read professional game reviews and view high-resolution screenshots, HD videos, and behind-the-scenes footage. For more information, see [How to Find Games and Gaming News](#).

## Additional Apps

### Adobe Reader by Adobe

Adobe Reader allows you to view and annotate PDF files on your device. To learn more, visit [Adobe Reader](#) in the Google Play store.

### Camera Awesome by SmugMug

Camera Awesome provides slow-motion video, enhanced HDR, and integrated stylus support in addition to a number of shooting and editing features. To learn more, visit [Camera Awesome](#) in the Google Play store.

### ES File Explorer by ES APP Group

ES File Explorer is a file and application manager. Kill tasks, manage downloads, and store files in the cloud. ES File Explorer also allows you to access your media on other Android devices and computers. To learn more, visit [es File Explorer](#) in the Google Play store.



## **Evernote by Evernote Corporation**

Evernote helps you remember things across all of your devices. Your notes, images, voice reminders, and lists are all searchable wherever you are, from any device. To learn more, visit [Evernote](#) in the Google Play store.

## **JusWrite by Plackal Tech**

JusWrite is a handwriting-friendly organizational app. Use your stylus to write lists by hand. You can categorize and prioritize your lists, mark list items complete, and more. To learn more, visit [JusWrite](#) in the Google Play store.

## **Write by Stylus Labs**

Write is a word processor for handwriting. Use your stylus to write, edit, sketch, organize, and bookmark handwritten documents on your tablet. To learn more, visit [Write](#) in the Google Play store.

## **Twitch by Twitch Interactive**

With the Twitch viewing app, you can watch live broadcasts of the games you love and chat with the players you follow. To learn more, visit [Twitch](#) in the Google Play store.

## **How to Use This Guide**

This guide includes instructions and information about the NVIDIA features and apps that come with your NVIDIA device. In cases where there are multiple ways to accomplish a task, this document describes the most common procedure.

For help with the Android OS, please visit Google's support website at <http://support.google.com/android/>.

Google provides help for Android OS features and for Google apps such as Gmail, Google Keyboard, Google Plus, Google Play, Chrome, and YouTube.

For help with pre-installed and third-party apps, please visit the app's support website. Most apps include a Help button or an About button that provides a link to the app's support website.

## **SHIELD Tablet Overview**

The SHIELD tablet box includes one SHIELD tablet with DirectStylus™, a charger, one USB charging cable, and one Safety Guide.

# SHIELD Tablet with DirectStylus

Front View

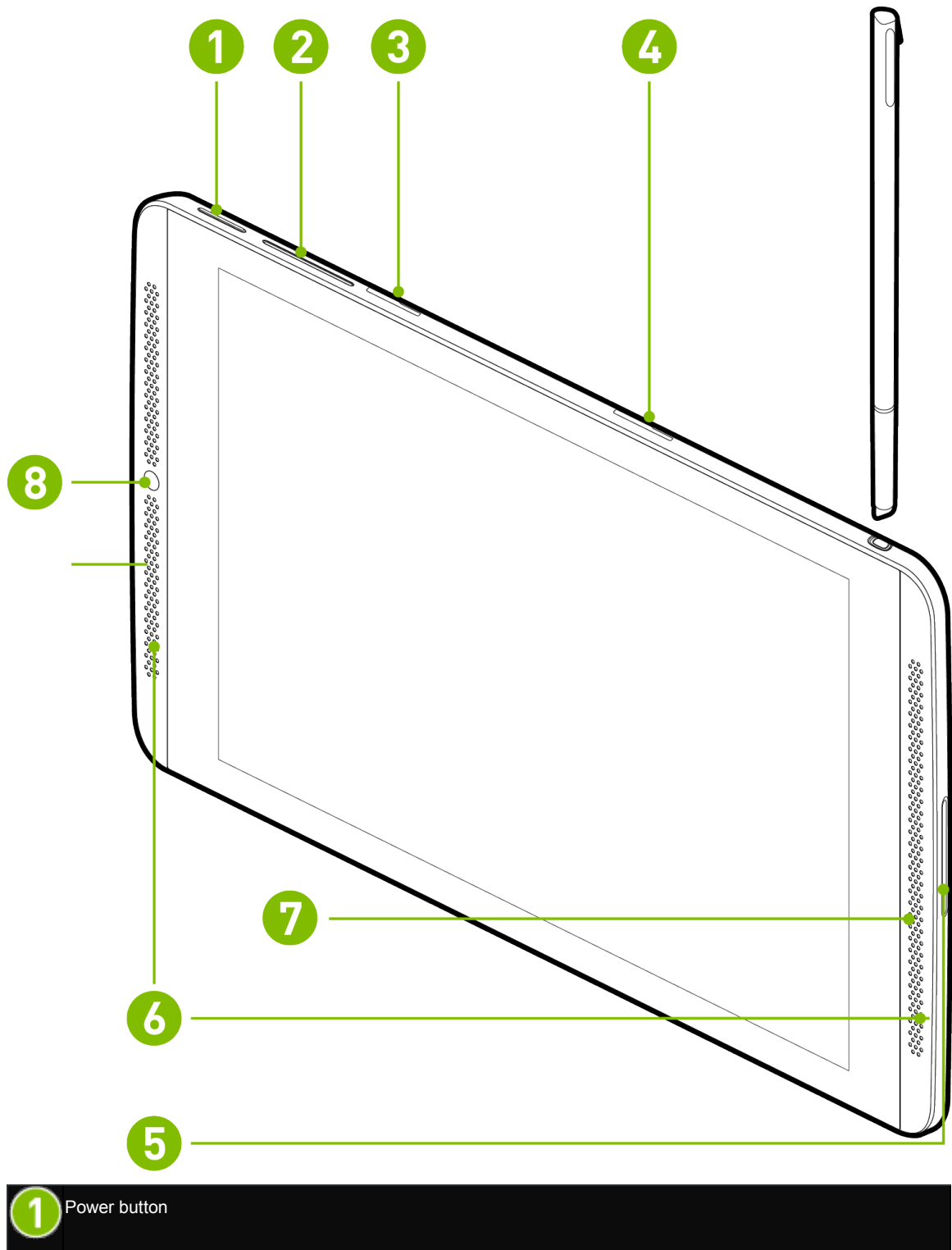

2	Volume button
3	MicroSD card slot
4	Micro-SIM card slot (on LTE model only)
5	Bass reflex port
6	Speakers
7	Microphone (located behind the speaker grill)
8	Front camera

**Rear View**

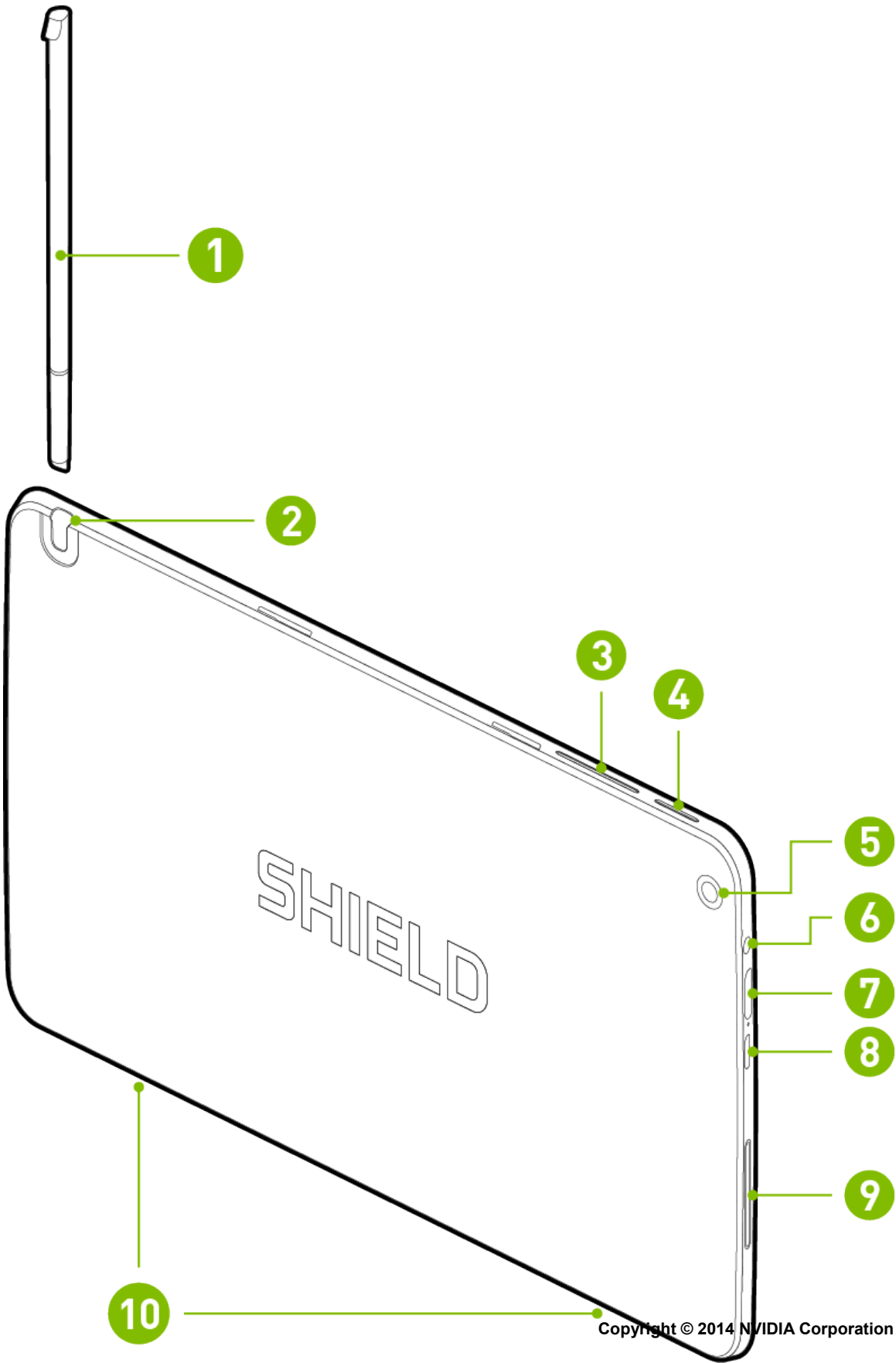

<b>1</b>	DirectStylus
<b>2</b>	Stylus holder
<b>3</b>	Volume button
<b>4</b>	Power button
<b>5</b>	Rear camera
<b>6</b>	Headphone jack (3.5 mm)
<b>7</b>	Mini-HDMI slot for connecting the tablet to an external display
<b>8</b>	Micro-USB slot for connecting the charger
<b>9</b>	Bass reflex port
<b>10</b>	Magnetic slots for the snap-on cover. The cover is sold separately.

## Get Started

Your device should arrive with at least a 50 percent charge in the battery. However, if the battery level is low or empty, we recommend that you use the included charger to charge your device for 2 hours before you begin the setup process.

### How to Charge Your SHIELD Device

1. Plug the micro-USB end of the USB cable into the micro-USB slot of the device.
2. Plug the standard USB end of the USB cable into a USB power source, such as an AC adapter or a computer.

**NOTE** You can use the device while the device is plugged into your computer or other power source. However, when the device is in use, the charging time is extended.

### How to Turn On Your Tablet

Press and hold the **Power** button until the screen turns on, and then release the button. It may take three or four seconds for the screen to turn on.

### How to Use the Touchscreen

Use your fingertip or the stylus to perform these touchscreen gestures.

<b>Tap</b>	Tap an icon to perform an action. For example, tap the Maps icon to open Google Maps.
------------	---------------------------------------------------------------------------------------

<b>Double-tap</b>	Tap twice quickly. Use double-tap to zoom a photo, webpage, map, or other content. Double-tap again to return to the original size. Not all apps support double-tap.
<b>Tap and hold</b>	Touch an icon and hold until the action occurs. For example, on the Home screen, touch an app icon until all of the icons begin to wiggle.
<b>Drag</b>	Touch and hold, and then move your finger to drag. For example, on the Home screen, touch an app icon until all of the icons begin to wiggle. Drag your finger to move the app icon to another area of the screen. When you lift your finger off the screen, the icon stays in its new position.
<b>Swipe</b>	Swipe your finger up, down, or across to move through lists, screens, photos, and other content. Do not pause while swiping. A pause may change the action from a swipe to a drag.
<b>Pinch</b>	Place two fingers on the screen, a few inches apart. Move the fingers together to zoom out. Not all apps support pinch.
<b>Spread</b>	Place two fingers on the screen, close together. Move the fingers apart to zoom in. Not all apps support spread.

## How to Complete NVIDIA Setup

Turn on your device. Follow the prompts to select a language and to accept the NVIDIA Software License Agreement, Privacy Policy, and Tegra Experience Terms of Service. For more information about these agreements and policies, see [SHIELD Legal](#).

## How to Complete Android Setup

After you complete the NVIDIA setup process, the Android setup process begins automatically. Android prompts you to connect to Wi-Fi, enter your Google account, and set your initial preferences for location services and other features. You may change these preferences later in **Settings**. You must accept the Google terms of service.

**NOTE**  If you do not already have a Google account, you can create one during the set up process. If you have multiple Google accounts, you can add other accounts later in **Settings**.

You may use your NVIDIA device without signing in to a Google account. However, you must have a Google account to use Google mobile services.

Your Google account is the e-mail address and password that you use to log into Gmail, YouTube, Google Drive, and other Google services.

Your Google account enables the following features:

- Synchronize and back up your e-mail, calendar events, contacts, messages, and other data across devices.
- Use Google Play to purchase and access movies, TV shows, books, music, magazines, and apps.
- Connect to Google Wallet.
- Secure your personal data.

## How to Turn Off Your Tablet

1. Press and hold the **Power** button for three seconds. The device control panel opens.



2. Tap the **Power Off** icon.

**NOTE**  You can also hold the power button for four seconds to turn off the device.

## How to Restart Your Tablet

1. Press and hold the **Power** button for three seconds. The device control panel opens.



2. Tap the **Restart** icon.
3. At the prompt, tap **Restart**.

**NOTE**  You can also hold the power button for 12 seconds to shut down the device.



# Manage Your Tablet

## How to Navigate Your Tablet



Your NVIDIA device supports standard Android navigation, such as the Notification shade and the Favorites bar.

This guide includes instructions for the most common navigation elements. Most of the elements are standard with the Android operating system.

For help with the Android OS, please visit Google's support website at <http://support.google.com/android/>.

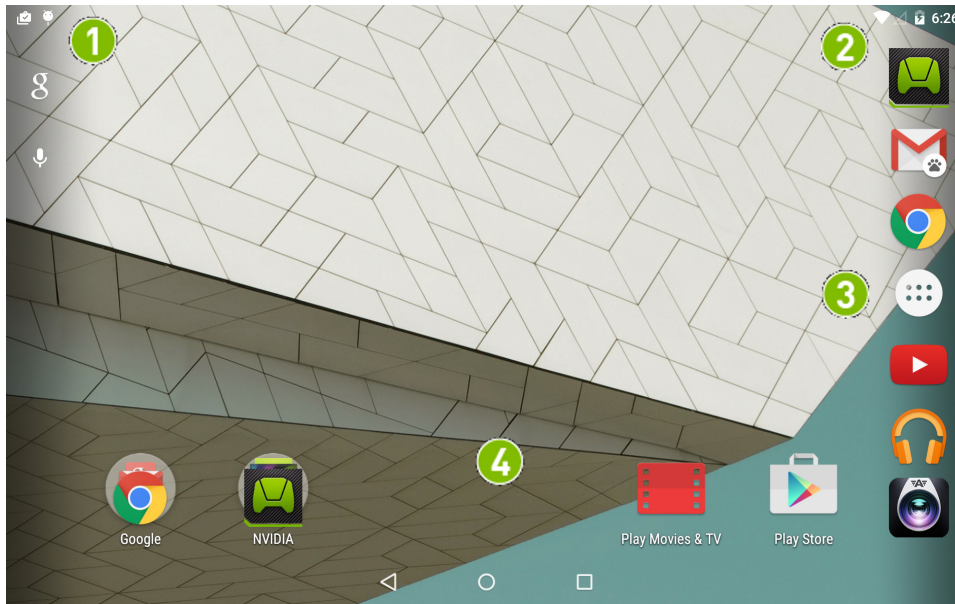
### Navigation Overview



<b>1</b>	<b>Notification bar.</b> Notification icons show that you have new e-mail, calendar events, alarms, and other notifications. Swipe down to view details in the Notification shade.
<b>2</b>	<b>System bar.</b> System icons show the Wi-Fi signal strength, battery level, Bluetooth connectivity, and other statuses. For more information, see <a href="#">How to View Device Status</a> .  Swipe down from the System bar to view the Quick Settings shade. For more information, see <a href="#">How to Use Quick Settings</a> .
<b>3</b>	<b>Favorites.</b> The Favorites tray provides quick access to up to six apps. The Favorites tray is visible on all Home pages. For more information, see <a href="#">Organizing Your Apps</a> .
<b>4</b>	<b>Navigation bar.</b> These icons provide common navigation functions, such as return to the previous screen, open the main Home screen, and view recently opened apps.   <b>Back.</b> Tap to return to the previous screen.   <b>Home.</b> Tap to return to the main Home screen.



Recently Used Apps. Tap to view apps that are currently open, in order of recent use.



**NOTE** If the Navigation bar is hidden, swipe up from the bottom of the screen to open it. Some apps hide the Navigation bar to provide you with a full-screen experience. The Navigation bar also hides after a period of disuse.

## How to Navigate Your Tablet

Your NVIDIA device supports standard Android navigation, such as the Notification shade and the Favorites bar.

This guide includes instructions for the most common navigation elements. Most of the elements are standard with the Android operating system.

For help with the Android OS, please visit Google's support website at <http://support.google.com/android/>.

### Navigation Overview



1	<b>Notification bar.</b> Notification icons show that you have new e-mail, calendar events, alarms, and other notifications. Swipe down to view details in the Notification shade.
2	<b>System bar.</b> System icons show the Wi-Fi signal strength, battery level, Bluetooth connectivity, and other statuses. For more information, see <a href="#">How to View Device Status</a> .  Swipe down from the System bar to view the Quick Settings shade. For more information, see <a href="#">How to Use Quick Settings</a> .
3	<b>Favorites.</b> The Favorites tray provides quick access to up to six apps. The Favorites tray is visible on all Home pages. For more information, see <a href="#">Organizing Your Apps</a> .
4	<b>Navigation bar.</b> These icons provide common navigation functions, such as return to the previous screen, open the main Home screen, and view recently opened apps.

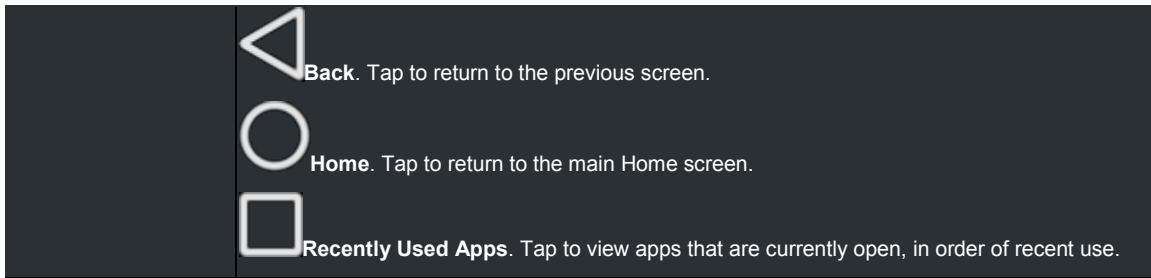

**NOTE** If the Navigation bar is hidden, swipe up from the bottom of the screen to open it. Some apps hide the Navigation bar to provide you with a full-screen experience. The Navigation bar also hides after a period of disuse.



## How to Connect to Wi-Fi

Your device scans automatically for available Wi-Fi networks and connects to known networks when you are within range.

The Android operating system provides several options for connecting to Wi-Fi. This section describes the most common options.

For help with the Android OS, please visit Google's support website at <http://support.google.com/android/>.

### How to Connect to Wi-Fi

1. Go to **Settings > Wireless & Networks > Wi-Fi**. Wi-Fi settings are also available on the Quick Settings shade. For more information, see [How to Use Quick Settings](#).
2. If Wi-Fi is set to **OFF**, tap the **ON/OFF**  switch to turn it on. When Wi-Fi is on, the **ON/OFF** switch shows **ON** .
3. Tap **Wi-Fi**. The Wi-Fi control panel shows the wireless networks that are in range and indicates their signal strength. The control panel also shows any wireless networks that your device has connected to in the past. If you are already connected to Wi-Fi, the name and signal strength of the current Wi-Fi network are shown.
4. In the Wi-Fi control panel, select the network that you want to connect to.
5. If prompted, enter the password and tap **Connect**.

### How to Scan for Available Wi-Fi Networks

1. Go to **Settings > Wireless & Networks > Wi-Fi**.

2. If Wi-Fi is set to **OFF**, tap the **ON/OFF**  switch to turn it on. When

Wi-Fi is on, the **ON/OFF** switch shows **ON** 

3. Tap **Wi-Fi**.

4. In the Wi-Fi control panel, tap the menu  icon. The menu opens.

5. Tap **Scan**. A list of available networks appears.

## How to Remove a Wi-Fi Network Connection

When you remove a Wi-Fi network connection, the network may still appear in the list if you are within signal range. To connect to the network again, tap the network.

1. Go to **Settings > Wireless & Networks > Wi-Fi**.

2. If Wi-Fi is set to **OFF**, tap the **ON/OFF**  switch to turn it on. When

Wi-Fi is on, the **ON/OFF** switch shows **ON** 

3. Tap **Wi-Fi**.

4. In the Wi-Fi control panel, tap the network that you want to remove. The network window opens.

5. Tap **Forget**.

## LTE Models

The following section applies to LTE models only. There are two versions of the SHIELD tablet LTE:

Coverage	Americas Version		Rest of World Version	
LTE Support	FDD-LTE Bands	Band Frequency (MHz)	FDD-LTE Bands	Band Frequency (MHz)
	2	1900	3	1800
	4	1700	7	2600
	5	850	20	800
	7	2600		
	17	700		

3G Support	HSPA+ Bands	Band Frequency (MHz)	HSPA+ Bands	Band Frequency (MHz)
	1	2100	1	2100
	2	1900	2	1900
	4	1700	5	850
	5	850	8	900
EDGE Support	Yes			
GPRS Support	Yes			

## Setting up an lte connection

1. Ensure that you have a Micro-SIM card, provided by your data carrier, in the Micro-SIM card slot on your tablet before powering on the device. Make sure the SIM is valid, as inactivated or prepaid SIMs with no credit left will not work. Make sure the carrier uses bands listed above in your area. To insert the SIM card, lift the slot cover near the stylus holder. The SIM card slot is on the right when the screen is face down. Insert the SIM card, notch first, with contacts facing up. The connector is a push-push type so you have to push until you feel a slight click and the card stay in. If it pops out, you did not push the card in far enough. Your tablet reads the SIM card and attempts to connect to the network. Signal

strength bars  are displayed in the notification bar upon connection to the network. If Wi-Fi is not turned on, you will see what type of data connection is available.

With the modem enabled, you may need to configure an APN for the network; check with your carrier. The table above shows that when you travel, you should have access to cellular networks in most places.

If you insert the Micro-SIM card while the device is powered on, you will need to restart your tablet to enable the LTE connection.

2. You can turn the LTE connection on and off in the [Quick Settings](#). In the Quick Settings, tap  to open the **Cellular Data** settings.

3. If **Cellular data** is set to **OFF**, tap the **ON/OFF** switch  to turn on the LTE connection. When the LTE

connection is on, the **ON/OFF** switch shows **ON** .

4. The **Cellular data** settings show the Data usage, Carrier, Billing cycle, and any data limit warnings associated with your specific data plan. Go to **More Settings** for an in-depth breakdown of data usage during the current and past billing cycles.

## LTE settings

For more features possible with your LTE device go to **Settings > Wireless & networks > More:**

### Tethering & portable hotspot

Tethering allows you to use the Internet connection with other devices by connecting via USB cable.

## VPN

A Virtual Private Network (VPN) provides the ability to securely connect to your workplace network remotely and is a common standard tool used by most Information Technology (IT) departments. A VPN connection provides the security of your workplace firewall and allows you to exchange emails and view sensitive work-related information.

You may need to obtain specific format and settings information from your workplace; such as:

- PPTP (Point-to-Point Tunneling Protocol)
- L2TP (Layer 2 Tunneling Protocol)

## Cellular Networks Settings



1. **Data roaming.** If the Data roaming switch is set to **OFF**, tap the **ON/OFF** switch  to turn it **ON**. When

Data roaming is on, the **ON/OFF** switch shows **ON** .

2. **Preferred network type.** LTE is recommended and enabled by default. 2G and 3G bands are also supported.
3. **Access Point Names.** Typically, the SIM you insert will include APN data for the network it is associated with. You should see at least one APN. Use the "+" sign at the top of the screen to add an APN if needed.
4. **Network operators.** This option will scan for all carriers available in your area and provide a list for you to choose from. If you select a carrier other than your current carrier, you will incur roaming charges for data transferred.
5. **Mobile Plan.**

## How to Use the Stylus

Your tablet includes the NVIDIA DirectStylus™. This stylus enables precise control of handwriting, drawing, and touchscreen games that require pinpoint accuracy.

The stylus has  a chisel tip, similar to the tip of a highlighter pen. For fine lines, touch with the pointed tip. For thick lines, touch with  the full width of the chisel.

**NOTE** Some apps do not support variable line thickness. In those apps, the stylus produces the same line thickness, regardless of which part of the tip you use.

When the tablet is in stylus-only mode, the touchscreen only responds to input from the stylus. Touches from your finger or palm are ignored.

## Stylus Behavior

### How to Enable Access to Stylus-Only Mode

Before you can use stylus-only mode, you must enable access in the settings.

1. Go to **Settings > DirectStylus**.
2. Under Stylus-Only Mode and Lasso Capture, select the **Quick access via navigation bar** check box.

## How to Use Stylus-Only Mode

Before you can use stylus-only mode, you must enable access in the settings. For more information, see [How to Enable Access to Stylus-Only Mode](#).

1. Remove the stylus from its holder.
2. In the Navigation bar, tap the **Stylus-Only Mode** icon 
3. To return to Touch Mode, tap the **Stylus-Only Mode** icon again.



**NOTE** Your NVIDIA device automatically disables stylus-only mode when you return the stylus to its holder. The device also disables stylus-only mode when you press the power button quickly to put the device to sleep. This allows you to continue using the touchscreen even if you left the device in stylus mode but do not have the stylus with you.

## How to Optimize Palm Rejection for Your Writing Style

Your tablet includes palm-rejection technology. This technology ensures that the touch screen responds only to the stylus while you are writing, even if you rest your hand on the screen while you write. When the stylus is not touching the screen, the touchscreen responds normally to your finger.

If your palm is sometimes misidentified when you reposition your hand on the screen, then you can change the DirectStylus pen-to-touch delay to optimize palm rejection for your writing style. Pen-to-touch delay temporarily suppresses non-stylus touches during and after stylus input. The default delay of 0.5 seconds works well for most users.

If you do a lot of stylus interactions with your palm on the screen, select a longer delay. If you do not put your palm on the screen and you switch quickly between stylus and finger inputs, select a shorter delay.

1. Go to **Settings > DirectStylus**.
2. Tap **Set timer to activate finger touch after pen use**.
  - To remove any delay, tap **Disable touch only during pen use**.
  - To add a delay, tap one of the delay options.

## How to Adjust the Stylus for Left-Handed Use

Left-handed users tend to place their palm on the left side of the screen. In left-handed mode, the palm rejection algorithm rejects stray touch inputs from the left side of the screen.

1. Go to **Settings > DirectStylus**.
2. Under **Handedness**, tap **Left-handed** to select the check box. To return to right-handed mode, tap again to clear the check box.

## How to Show or Hide the Draw Cursor

The draw cursor shows when the stylus touches the screen and provides precision visual feedback.

1. Go to **Settings > DirectStylus**.

2. Under **Cursor**, tap **Show draw cursor** to select the check box. To hide the draw cursor, tap again to clear the check box.

## Stylus Apps

### How to Use DirectStylus Launcher for Quick Access to Apps

The DirectStylus Launcher provides quick access to a subset of your apps. When DirectStylus Launcher opens, tap any app icon to open the app.

You may add or remove apps from the DirectStylus launcher at any time.

1. Open **DirectStylus Launcher**.
2. Tap **Edit** option. The selection window opens.
3. Tap the app icons to select or clear the check boxes.
4. Tap **OK** to add selected apps and remove cleared apps.

### How to Open DirectStylus Launcher Automatically When the Stylus Is Removed

1. Go to **Settings > DirectStylus**.
2. Tap **Default action when DirectStylus removed**.
3. Tap **Open DirectStylus Launcher**.
4. Tap **OK**.

### How to Open an App Automatically When the Stylus Is Removed

You can select a single app to open automatically when the stylus is removed.

1. Go to **Settings > DirectStylus**.
2. Tap **Default action when DirectStylus removed**.
3. Tap **Launch App**.
4. Tap the app.
5. Tap **OK**.

### How to Prevent Apps from Opening Automatically When the Stylus Is Removed

Follow these steps to prevent any app from opening when the stylus is removed.

1. Go to **Settings > DirectStylus**.
2. Tap **Default action when DirectStylus removed**.
3. Tap **None**.



## How to Customize Your Device

You can customize what you see, what you hear, and how you interact with your device. Set your personal preferences for notification sounds, screen brightness, wallpaper images, font size, power saving mode, and other settings. Settings can be changed at any time.



The Android operating system provides several options for customizing your device. This section describes the most common options.

For help with the Android OS, please visit Google's support website at <http://support.google.com/android/>.



**NOTE** After you view or change any settings, tap **Back**  to return to the previous screen or tap **Home**  to return to the Home screen.

## How to Open Settings

1. Tap **All Apps** .
2. Tap **Settings** .

**NOTE**  You can also use the Quick Settings. Swipe down from the System bar and then tap **Settings**. For more information, see [Use Quick Settings](#).

## Sounds

### How to Turn Touch Sounds On and Off

Touch sounds provide audio feedback when you use the touchscreen.

1. Go to **Settings > Device > Sound & notification > Other sounds**.
2. Use the **Touch sounds** switch to turn touch sounds on/off.

## Display

### How to Adjust Display Brightness

1. Go to **Settings > Device > Display**.
2. Tap **Brightness level**. The Brightness control panel opens.
3. Swipe the slider to dim or brighten the display.

**NOTE**  To adjust brightness automatically, turn on **Adaptive brightness**. Your device senses the amount of light in the immediate environment and adjusts the display brightness in response.

## How to Change the Wallpaper

The wallpaper is an image or pattern that shows in the background of the Home screen pages.

1. Go to **Settings > Device > Display**.
2. Tap **Wallpaper**. The Wallpaper control panel opens.
3. Select the type of wallpaper that you want.
  - **ES File Explorer**. Select from drawings, photos, or other images on the device.
  - **Live Wallpapers**. Select from animated images.
  - **Photos**. Select from your photos.
  - **Wallpapers**. Select from still images.
4. Tap the image you want.
5. Tap **Set Wallpaper**.

## How to Change the System Font Size

The font-size setting changes your device's system font size. However, apps may define their own font sizes. Fonts displayed in apps may not conform to the font-size setting.

1. Go to **Settings > Device > Display**.
2. Tap **Font Size**. The Font Size control panel opens.
3. Tap a font size. The control panel closes and the device applies the new font size immediately.

## Power Saving

### How to Change the Sleep-Mode Interval

Sleep mode conserves power by turning off the display after a period of inactivity. Sleep mode also activates the screen lock security, if any. For more information, see [Secure Your Device](#).

1. Go to **Settings > Device > Display**.
2. Tap **Sleep**. The Sleep control panel opens.
3. Tap the interval of time that you want the display to remain on when there is no activity. At the end of this interval, your device automatically enters sleep mode.

### How to Manage Processor Performance

1. Go to **Settings > SHIELD Power Control**.

2. Tap **Processor**. The Processor status screen opens. This screen shows the selected power saving mode, the cores allowed by the mode, and whether a frequency limit is enabled.
3. In the **System** section, tap **Processor Mode**. The Processor Mode control panel opens.
4. Tap a processor mode.
  - **Max Performance**. This mode provides maximum processor performance. This option drains the battery faster than the other options.
  - **Optimized**. This mode provides a balance between performance and saving power.
  - **Battery Saving**. This mode conserves power by limiting the number of processor cores and setting a frequency limit.
  - **My Power Mode**. This mode provides the option to create your own power mode. Select the number of cores, core frequency, and frame-rate limit.

### How to Reduce Background App Power Usage

Some apps use power even when your device is not in use. For example, a weather app might download information every 30 minutes even when the app is closed. You can conserve battery power by reducing app activity for apps you do not use often.

1. Go to **Settings > SHIELD Power Control**.
2. Tap the **Apps** tab.
3. In the list of apps, tap **Change** to enable or disable the parameters that affect performance and power consumption.

### How to Organize Your Apps

The Android operating system provides several options for organizing your apps and widgets. This section describes the most common options.

For help with the Android OS, please visit Google's support website at <http://support.google.com/android/>.

### Home Screen

The Home screen is a place to organize apps and to display widgets. To return to the main Home screen at any time, tap

the **Home** icon  in the Navigation bar.

**NOTE**  If the Navigation Menu is not visible, swipe up from the bottom of the screen to open it.

Your NVIDIA device supports multiple Home screen pages. When you add more apps and widgets than can fit on the default Home screen page, additional pages are created automatically.

### **How to Create Home Screen Pages**

Drag an app to the left or the right edge of the screen.

### **How to View Home Screen Pages**

From any Home screen, swipe left or right.

## **Apps and Widgets**

### **How to Add Apps to the Home Screen**

1. Tap **All Apps** .
2. Tap and hold the app icon that you want to move. The Home screen appears behind the app icon.
3. Drag the icon to the page and location where you want to place the app.
4. Release.

### **How to Move Apps Around the Home Screen**

1. Tap and hold the app icon that you want to move. The icon glows briefly and appears larger.
2. Drag the icon to the location where you want to place it. To move the app to another Home screen page, drag the icon to the right or left edge of the screen.
3. Release.

### **How to Add Apps to the Favorites Tray**

The Favorites tray shows on all Home screen pages. If the Favorites tray already shows six apps, remove an app before you attempt to add another.

1. Tap and hold the app icon that you want to move. The icon glows briefly and appears larger.
2. Drag the icon to the Favorites tray.
3. Release.

### **How to Remove Apps from the Favorites Tray**

1. Tap and hold the app icon that you want to move. The icon glows briefly and appears larger.
2. Drag the icon to the Home page.
3. Release.

## Folders

### How to Create Folders to Group Apps Together

1. On the Home screen, tap and hold an app icon.
2. Drag and drop the icon onto another app icon. The folder is created.
3. Tap the folder.
4. Tap the text **Unnamed Folder**.
5. Enter a name.
6. Tap anywhere on the touchscreen to save the new name.

### How to Rename a Folder

1. Tap the folder.
2. Tap the folder's name.
3. Enter the new name.
4. Tap anywhere on the touchscreen to save the new name.

### How to Open Apps That Are in a Folder

1. Tap the folder. The folder opens to show the app icons inside.
2. Tap an app icon to open the app.

## SD Card

You can add storage for apps and content with a microSD card. For more information, see [How to Add Storage with a microSD Card](#).

## How to Manage Notifications

Notifications indicate that you have new text messages, e-mail, calendar events, alarms, and many other events in progress.

### How to Change the Notification Sound

The notification sound provides an audio alert when new notifications arrive.

1. Go to **Settings > Device > Sound & notification**.
2. Tap **Default notification ringtone**. A list of available sounds opens.
  - Tap any sound to hear a preview.

- To silence notifications, swipe to the top of the list and tap **None**.
3. To assign the selected sound, tap **OK**. To keep the previously assigned sound, tap **Cancel**.

## How to View or Hide Notification Details

To view notification details, swipe your finger from the notification area toward the center of the touchscreen. The **Notification Shade** opens.

To expand or collapse the **Notification Shade**, tap and drag the bottom edge of the shade up or down.

To close the **Notification Shade**, swipe from the bottom of the shade up toward the notification area.

## How to Clear a Notification

1. Open the **Notification Shade**.
2. Swipe the notification to the right or left.







**NOTE**  Only the notification is cleared. The e-mail, text, download, or other event associated with the notification is not deleted.





## How to Use Quick Settings

The Quick Settings shade provides one-touch access to important settings. To open the Quick Settings shade, two-finger swipe down from the System bar or double-swipe down. To close Quick Settings, swipe up from the bottom of the shade



or tap **Back**

	<b>Battery.</b> Tap to view the battery-usage history.
	<b>Settings.</b> Tap to open the device settings. For more information about settings, see <a href="#">Customize Your Device</a> .
	<b>Brightness.</b> Use the slider to dim or brighten the touchscreen.
	<b>Wi-Fi.</b> Tap to open the Wi-Fi settings. If your device is connected to Wi-Fi, the network name and signal strength are shown.
	<b>Bluetooth.</b> Tap to toggle Bluetooth <b>ON/OFF</b> . For more information about Bluetooth, see <a href="#">Use Bluetooth Accessories</a> .
	<b>Share.</b> Tap to open Record and Share to share or broadcast your gameplay over the internet. For more information, see <a href="#">Record and Share Your Gameplay</a> .

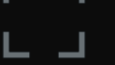
	<b>LTE Signal.</b> Tap to open Cellular data settings.
	<b>Rotation.</b> Tap to switch between Auto-rotate, Portrait, or Landscape orientation.
	<b>SHIELD controller.</b> Tap to open the wireless controller app to connect and manage your controller.
	<b>Cast Screen.</b> Tap to stream media to other devices, such as network-connected TVs.
	<b>Full Screen.</b> Tap to switch between Full Screen and normal display mode. When the device is in Full Screen mode, the Navigation bar and System bar are hidden from the Home screen.

## How to Use the Google Keyboard

The Google Keyboard appears automatically when you touch any text-input field. For example, open Chrome and tap in the Google Search box. The Google Keyboard opens.





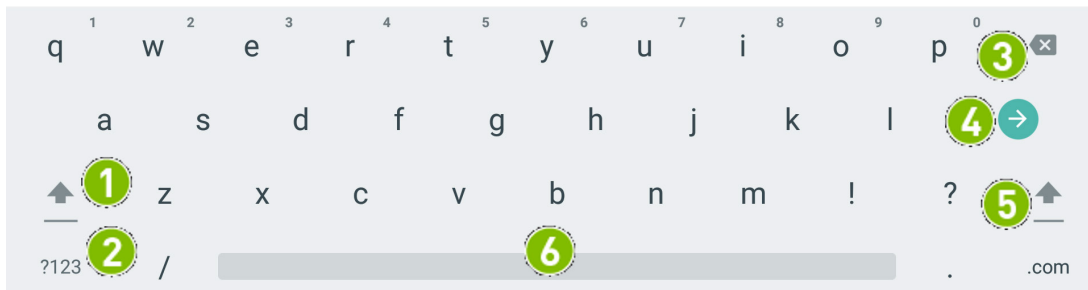

**NOTE**  If an external Bluetooth keyboard is connected, the Google Keyboard does not open.

This section describes common keyboard procedures. The Google Keyboard is part of the Android operating system.

For help with the Android OS, please visit Google's support website at <http://support.google.com/android/>.

### Google Keyboard (Alphabet)



	<b>Shift key.</b> To capitalize one letter, tap once and then tap the letter. To capitalize all letters, double-tap to enter CAPS LOCK mode.
	<b>Numbers and symbols key.</b> Tap once to open the numbers and symbols keyboard.
	<b>Backspace key.</b> Tap to erase the previous character.
	<b>Enter key.</b> The label of this key changes depending on context. You may see <b>Done</b> , <b>Search</b> , <b>Enter</b> , or other labels in various apps and contexts.
	<b>Shift key.</b> Same as  .

6

Spacebar

## Google Keyboard (Numbers and Symbols)

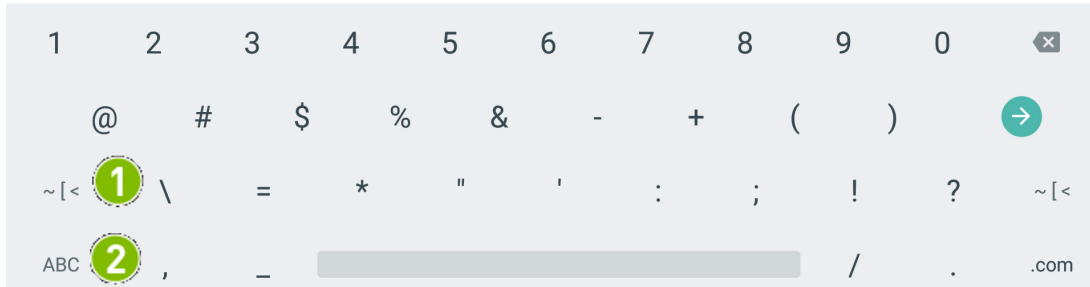

1

**Symbols.** Tap to open additional symbols.

2

**Alphabet.** Tap to return to the alphabet keyboard.

## How to Insert Emoticons or Emoji Characters

**NOTE**  Some text fields do not support keyboard emoticons or Emoji characters. In those cases, the emoticon key does not show on the keyboard.

1. Tap the Emoticon key.

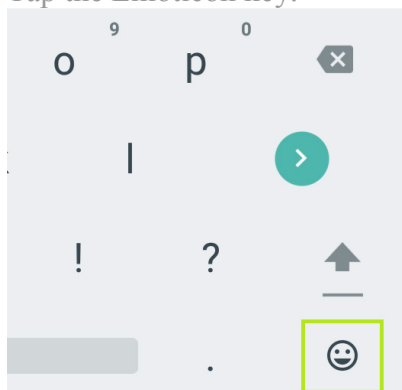

2. Swipe right or left to locate the character that you want.
3. Tap the character.

## How to Enter Letter Accents and Variations

1. Tap and hold a letter. If the letter has accents or other variation, a pop-up box appears and shows the available options.



2. In the pop-up box, tap the character.

## How to Use Gesture Typing

Gesture typing allows you to type by dragging from letter to letter instead of tapping each letter individually. Google Keyboard predicts the word you are typing and shows suggestions. When the word that you want is shown in the floating preview box or in the middle of the suggestion strip, release your finger. To select a different word from the suggestion strip, tap the word.

Turn gesture typing on or off in **Settings >Language & input > Google Keyboard > Gesture Typing > Enable gesture typing..**

**NOTE**  Gesture typing is not available for all languages.

## how to use handwriting recognition

1. Tap any text input field to open the Google Keyboard.
2. Tap the **Keyboard** icon in the bottom right corner 
3. Select **Handwriting Recognition**.
4. Using the Stylus, write on the virtual paper strip outlined below.

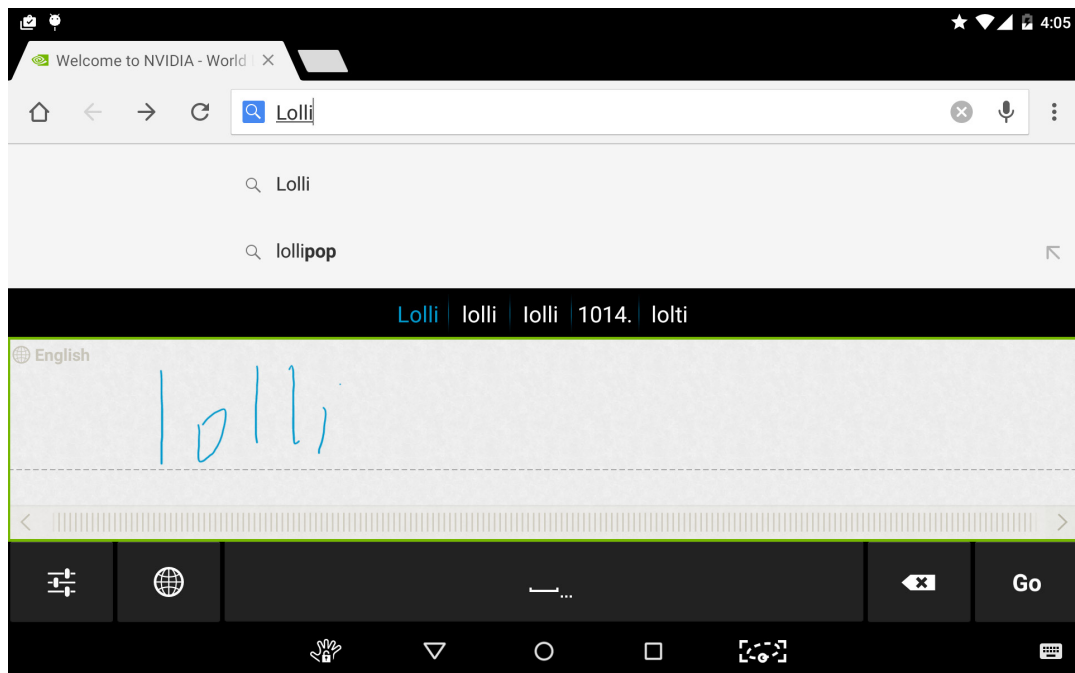

5. Your handwritten text is automatically converted into typeface characters.

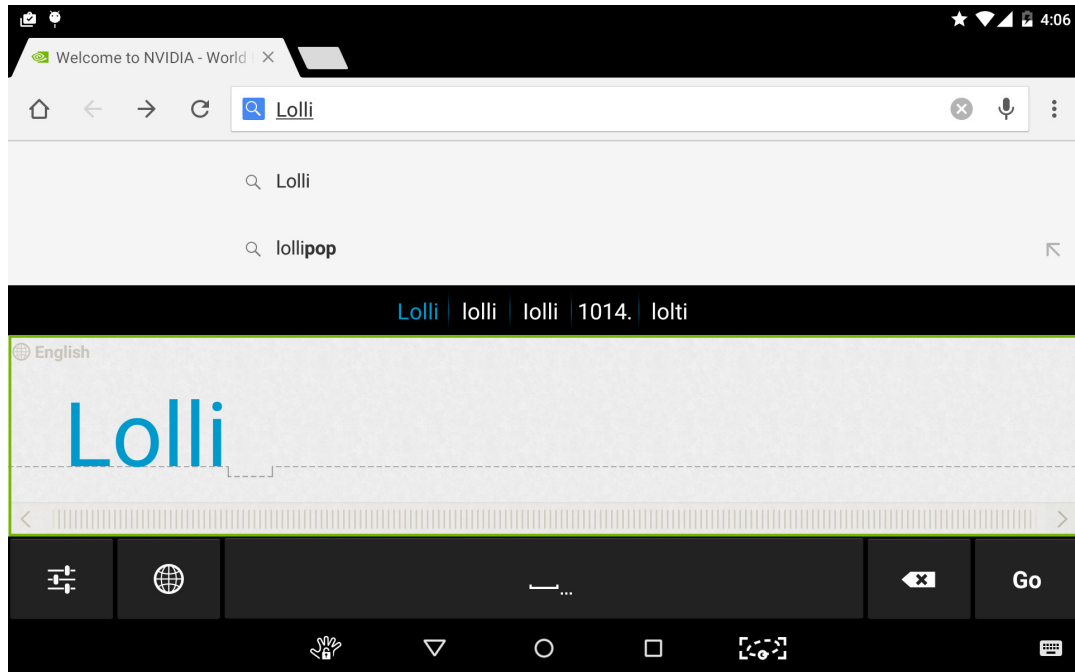

6. At the bottom of the paper strip, drag on the ruler or tap on the left/right arrow buttons to manually scroll left and right.

7. To disable **Handwriting Recognition** mode, tap on the **Keyboard** icon  and select **Google Keyboard**.

## How to Use Voice Typing



You can dictate text into email, notes, and other apps that accept text input. Google Voice Typing is available when the Google Keyboard shows the microphone key. If the microphone key is not visible, voice typing is not available for that text input field.



By default, voice typing is enabled and offensive words are blocked. Your device must be connected to the Internet for voice typing in most languages. However, Android supports offline voice typing for some languages. To customize voice typing, go to **Settings > Language & input > Google voice typing**.

Voice typing is a standard Android feature.

For help with the Android OS, please visit Google's support website at <http://support.google.com/android/>.

## How to Use Voice Typing

1. Tap any text input field to open the Google Keyboard.
2. Tap the **Keyboard** icon in the bottom right corner .
3. Select **Google voice typing**.
4. At the prompt , speak. When you pause, your words are transcribed. Underlined words might have transcription errors. A **Delete** prompt also shows for a brief period of time.

- To delete the transcription, tap **Delete**.
- To view suggestions and replace an underlined word, tap the underlined word.
- To return to the keyboard, tap the prompt  to pause voice typing, and then tap the **Keyboard** icon .

**NOTE**  In English, you can add punctuation by speaking. For example, as you speak, say "comma" or "period" to add the punctuation where you want it.

## How to Allow Offensive Words

By default, Google Voice Typing does not transcribe or suggest some words.

1. Go to **Settings > Personal > Language & Input**.
2. In Keyboard & input methods, tap the **Google voice typing**.
3. Turn off **Block Offensive Words**.

## How to Add Languages

1. Go to **Settings > Personal > Language & Input**.
2. Under Keyboard & input methods, tap **Google voice typing**.
3. Under **Languages**, tap the languages that you want voice typing to recognize and **Save**.

## How to Use Offline Voice Typing

Offline voice typing is available for some languages. Only words that are included in the language dictionary are available for voice typing.





1. Go to **Settings > Personal > Language & Input**.
2. Under Keyboard & input methods, tap the **Google voice typing**.
3. Tap **Offline Speech Recognition**.
4. Tap **All**. The list of supported languages opens.
5. Tap a language.
6. At the prompt, tap **Download**. The device downloads and installs the correct language dictionary.

## How to View Device Status

This guide describes the most common status views. The status views are standard with the Android operating system. For help with the Android OS, please visit Google's support website at <http://support.google.com/android/>.

### System Bar Status Icons

The System bar shows information about wireless connection status, battery level, and whether Bluetooth is on. The System bar shows on Home screen pages.

	<b>Bluetooth.</b> This icon shows when Bluetooth is on, even if your device is not paired with a Bluetooth accessory.
	<b>Alarm.</b> This icon shows when an alarm is set in the default clock app.
	<b>Wi-Fi.</b> This icon shows when your device is connected to a wireless network. The number of bars indicates the Wi-Fi signal strength.
	<b>Battery.</b> This icon shows the battery level.

### How to View Device Status Details

The complete system status shows details such as the serial number and MAC address of your device. Go to **Settings > About Tablet > Status**.

## How to Secure Your Device

Your Nvidia device offers several types of security that are provided by the Android operating system. For help with the Android OS, please visit Google's support website at <http://support.google.com/android/>.

### How to Lock Your Tablet

Lock turns off the display and conserves power.

1. Press the **Power** button.
2. When the display turns off, release the button.

### How to Unlock Your Tablet

1. Press the **Power** button and release. The display turns on.
2. If prompted, provide your screen lock option.

## How to Set a Screen Lock

A screen lock requires you to provide an unlock option before you can access your device or change the screen lock.

1. Go to **Settings > Personal > Security**.
2. Tap **Screen Lock**.
3. Select the lock method that you want to use and follow the prompts on your device.

## Screen Lock Options

### None

This option removes any existing screen lock.

### Swipe



This option places a lock icon on the lock screen.

To unlock the screen, swipe the lock icon in any direction.

### Pattern

This method prompts you to create a pattern. To unlock the screen, swipe your finger in the pattern you created.

### PIN

This method prompts you to create a 4-digit code (PIN).



To unlock the screen, tap your code and tap **Enter**.

### Password

This method prompts you to create a password. Your password can include letters, numbers, and symbols.



To unlock the screen, tap the password box to open the keyboard. Enter your password and swipe up on the lock icon.

## How to Update Your Device

Your device periodically receives updates from NVIDIA and Google. These updates can include performance enhancements, new features, and bug fixes for your apps and the Android operating system.

## How to Install Updates

1. Go to **Settings > System > About SHIELD tablet**.
2. Tap **Status**.

3. Tap **System Updates**.
4. If an update is available, the version number and description are shown. Tap **Install** to update your device. If you do not want to update your device at this time, tap **Back**  or **Home**  to exit the update screen.

# Play Games

## How To Find Games and Gaming News

The SHIELD Hub makes it easy to find games that are optimized for your SHIELD device. Games are categorized by genre, controller support, release date, and other filters so that you can quickly find what you are looking for. Each game entry includes a brief description, rating, high-resolution screenshots and HD videos to help you make your choice.

### How to Open the SHIELD Hub

Tap the **SHIELD Hub** icon 

### How to View Gaming News

Stay up to date with the latest news in e-sports, exclusive interviews, game releases, contests, the game industry, and more.

1. Open the **SHIELD Hub**.
2. Tap **News**.

### How to View Your Installed Android Games

1. Open the **SHIELD Hub**.
2. Tap **My Android Games**. The Android games list opens.
3. To open any game, tap the game icon.

### How to Play PC Games from Your SHIELD Device

The **SHIELD Hub** lets you access and stream your library of PC games on your SHIELD device.



**NOTE** Your PC must meet the GameStream system requirements and have the GeForce Experience app installed. For more information about PC setup and using GameStream, see [GameStream System Requirements](#).

1. Open the **SHIELD Hub**.
2. Tap **My PC Games**. The GameStream quick guide opens.
3. Tap **Get Started** and follow the prompts.

### How to Turn On or Turn Off SHIELD App Notifications

1. Open the **SHIELD Hub**.

2. Tap **Settings** .
3. Check / Uncheck to toggle notifications on and off.

## How to Shop for SHIELD Devices and Accessories

1. Open the **SHIELD Hub**.
2. Tap **Shop**.
3. Tap **SHIELD Portable** or **SHIELD Accessories**. The SHIELD Shop opens.

## How To Find Games and Gaming News

The SHIELD Hub makes it easy to find games that are optimized for your SHIELD device. Games are categorized by genre, controller support, release date, and other filters so that you can quickly find what you are looking for. Each game entry includes a brief description, rating, high-resolution screenshots and HD videos to help you make your choice.

### How to Open the SHIELD Hub

Tap the **SHIELD Hub** icon 

### How to View Gaming News

Stay up to date with the latest news in e-sports, exclusive interviews, game releases, contests, the game industry, and more.

1. Open the **SHIELD Hub**.
2. Tap **News**.

### How to View Your Installed Android Games

1. Open the **SHIELD Hub**.
2. Tap **My Android Games**. The Android games list opens.
3. To open any game, tap the game icon.

### How to Play PC Games from Your SHIELD Device

The **SHIELD Hub** lets you access and stream your library of PC games on your SHIELD device.



**NOTE**  Your PC must meet the GameStream system requirements and have the GeForce Experience app installed. For more information about PC setup and using GameStream, see [GameStream System Requirements](#).

1. Open the **SHIELD Hub**.
2. Tap **My PC Games**. The GameStream quick guide opens.
3. Tap **Get Started** and follow the prompts.

## How to Turn On or Turn Off SHIELD App Notifications

1. Open the **SHIELD Hub**.
2. Tap **Settings** .
3. Check / Uncheck to toggle notifications on and off.

## How to Shop for SHIELD Devices and Accessories

1. Open the **SHIELD Hub**.
2. Tap **Shop**.
3. Tap **SHIELD Portable** or **SHIELD Accessories**. The SHIELD Shop opens.

## How to Connect Your Controller to a SHIELD Device

Your controller is compatible with the SHIELD portable and the SHIELD tablet. It can also be used as a wired controller for a Windows 7 or Windows 8 PC running GeForce Experience. Learn more about wired PC support [here](#). Your controller cannot be used with other Android devices at this time.

### How to Connect Your Controller

The first time you use your SHIELD controller, you must establish a connection with a SHIELD device. This connection is saved for future use.

**NOTE**  If you connect the controller to another SHIELD device, the connection is removed. Follow the steps in this procedure to establish the connection again.

1. Verify that your SHIELD device has Wi-Fi turned on. The device does not have to connect to a network, but Wi-Fi must be turned on.
2. On your SHIELD device, open the SHIELD controller app .

3. On your controller, tap the NVIDIA button. The NVIDIA button flashes to show that the controller is in connection mode. If the NVIDIA button is not flashing, hold the NVIDIA button until it starts flashing, and then release.
4. When the controller is connected, the Quick Guide opens and a controller icon shows in the Quick Settings shade on your SHIELD device. This icon indicates that the controller is on and connected.
5. Optional: To connect an additional controller, repeat these steps on the additional controller.

## How to Reconnect the Controller

Your controller automatically reconnects when the SHIELD device and the controller are turned on and in range.

1. Turn on your SHIELD device.
2. Turn on the controller.



**NOTE** When the controller is connected to a SHIELD tablet and the tablet goes into sleep mode, the controller can wake the tablet for the first 10 minutes. After 10 minutes, the controller goes to sleep. You must then manually turn on the tablet and the controller.

## How to Troubleshoot Connection Problems

1. Verify that the controller has enough charge or connect the controller to a power source other than a computer.
2. Verify that the controller is not connected to a computer. The controller cannot be connected to a SHIELD device while the controller is charging from a computer.
3. Verify that the controller's NVIDIA button is flashing at the same time that the SHIELD device is searching for a controller. On the controller, hold the NVIDIA button until it starts flashing. Open the SHIELD controller app on your SHIELD device to initiate the connection process.
4. Verify that the SHIELD device has Wi-Fi turned on.
5. Verify that only one controller in range is attempting to connect to the SHIELD device. The connection process for one controller must complete before you can connect another controller.
6. Verify that only one SHIELD device in range is attempting to connect to the controller.
7. Verify that the SHIELD device has the latest system update.
8. Verify that the controller has the latest controller update. For more information, see Update Your Controller.
9. If your controller is still not responsive, hard reset the controller by holding the Nvidia button for 15 seconds.

10. If you are still having trouble, please contact [customer support](#).

## Use Your Tablet as a Game Console

Console Mode transforms your SHIELD tablet into a full gaming and entertainment experience on your HDTV. In Console Mode, you can do everything that you would normally do on your device. Your TV provides the display, and you navigate with a keyboard and mouse or with a game controller. Play Android games, browse the web, check your e-mail, and watch your favorite movies.

**NOTE**  When in your device is in Console Mode, the apps, menu, browser, and optimized Android games play back at native 1080p resolution. However, some Android games are not optimized for 1080p.

Console Mode requires the following hardware:

- **Cable.** A Mini-HDMI to HDMI cable.
- **HDTV.** An HDTV with HDMI support.
- **Controller.** A Bluetooth wireless controller or keyboard and mouse. NVIDIA recommends the NVIDIA SHIELD Controller.

## How to Connect Your Device to an HDTV

Console Mode opens automatically when you connect your device to an HDTV.

1. Connect a wireless controller or a Bluetooth keyboard and mouse. For more information, see [NVIDIA SHIELD controller](#) or [Using Bluetooth Accessories](#).
2. Insert the cable's Mini-HDMI connector into the Mini-HDMI port of your device.
3. Insert the cable's HDMI connector into an HDMI port on your HDTV.
4. At the SHIELD Console Mode prompt, select **Enter Console Mode**.



**NOTE** If you experience loss of details in the dark areas and increased color contrast when playing in Console Mode via HDMI, you might have mismatched color range settings on your device and TV. You can correct this issue by changing the setting in **Settings > HDMI > Color Correction preset** from "Native (default)" to "sRGB."

## How to Record and Share Your Gameplay

You can record your gameplay to a video file and share the video through email, YouTube, and other sharing methods.

The video captures everything that you do on your tablet, including browsing incognito or logging into your mobile banking app. Pay attention to what you are doing while you record and do not share any video that shows personal information.

The first time you turn on your tablet, the Notifications shade includes a notification for Record and Share. Tap this notification to view a quick start guide to recording and sharing your gameplay.

For more information about broadcasting your gameplay to the internet, see [Broadcast Your Gameplay to Twitch TV](#).

## How to Record and Share Your Gameplay

1. Open the game that you want to record.
2. Open the Quick Settings shade.
3. Tap **Share**.
4. Tap **Manual Record**.

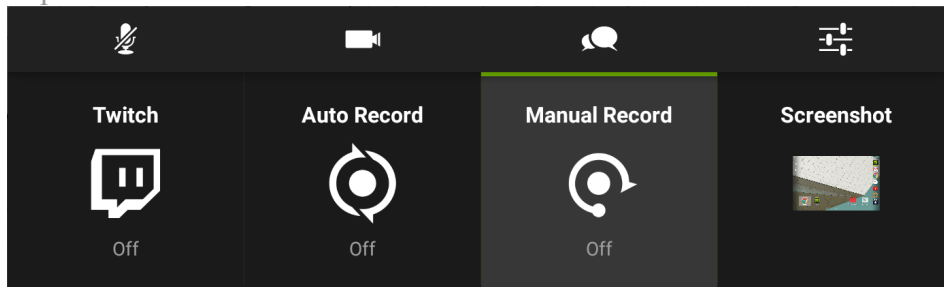

5. Tap **Start**.
6. Play the game.
7. Open the Quick Settings shade.
8. Tap **Share**.
9. Tap **Manual Record**.
10. Tap **Stop and Share**.
11. Select a sharing method.
12. Follow the prompts to complete the share. The recording is also saved to the Gallery.

## How to Record Your Gameplay Without Sharing

1. Open the game that you want to record.
2. Open the Quick Settings shade.
3. Tap **Share**.
4. Tap **Manual Record**.
5. Tap **Start**.
6. Play your game.
7. When you are ready to stop recording, open the Quick Settings shade.
8. Tap **Share**.
9. Tap **Manual Record**.
10. Tap **Stop**. The recording is saved to the Photos.

## How to Set the Video Quality

Video quality settings apply to record and share video and to broadcast video. For more information about broadcasting, see [Broadcast Your Gameplay to Twitch TV](#).

1. Open Quick Settings.
2. Tap **Share**.
3. Tap the Record and Share settings icon .

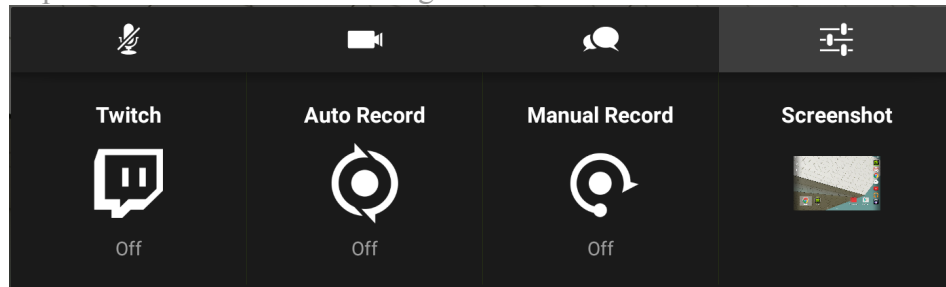

4. Tap the **Previous** and **Next** icons to scroll through the available quality levels. Lower qualities result in smaller file sizes for sharing and broadcasting. Higher qualities result in sharper images and smoother video.
5. When the quality level that you want is showing, tap **Back**  to return to the Record and Share settings.

## How to Find Your Gameplay Videos

The first time that you record and save your gameplay, a Game Recordings album is created in the Gallery.

To view the saved recordings, open the Gallery and then open **Game Recordings**.

## How to Record Your Gameplay Automatically

You can set your tablet to record your gameplay automatically with Auto Record. When Auto Record is turned on, your tablet records your gameplay continuously. You can then save and share the last 1 to 20 minutes of the recorded video. For more information about video length, see [How to Set the Maximum Video Length](#)

## How to Turn On Automatic Recording

1. Open Quick Settings.
2. Tap **Share**.

3. Tap **Auto Record**.

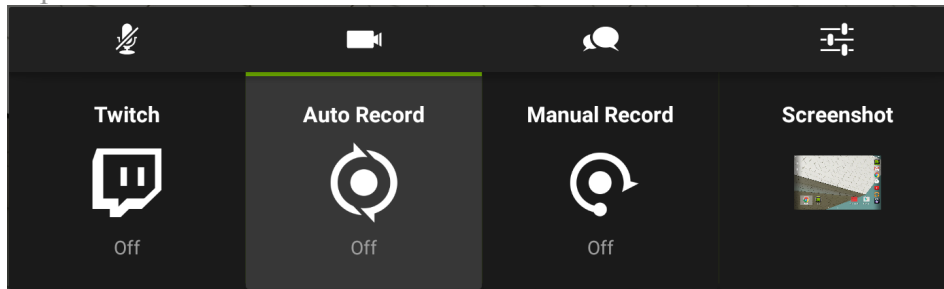

4. Tap **Start**.

### How to Save and Share Automatically Recorded Video

1. Open Quick Settings.
2. Tap **Share**.
3. Tap **Auto Record**.

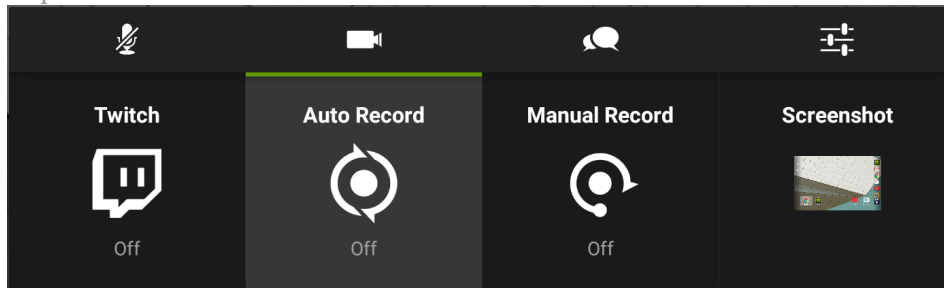

4. Tap **Save and Share**.
5. Select a sharing method.
6. Follow the prompts to complete the share. The recording is also saved to the Gallery.

### How to Stop or Save Automatically Recorded Video Without Sharing

1. Open Quick Settings.
2. Tap **Share**.
3. Tap **Auto Record**.

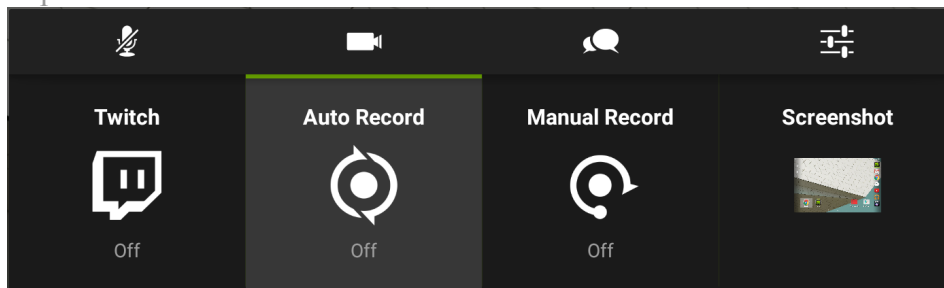

4. To save the video to the Gallery, tap **Save**. To stop recording without saving the video, tap **Stop**.

### How to Set the Maximum Video Length for Automatic Recording

1. Open Quick Settings.
2. Tap **Share**.
3. Tap the Record and Share settings icon .

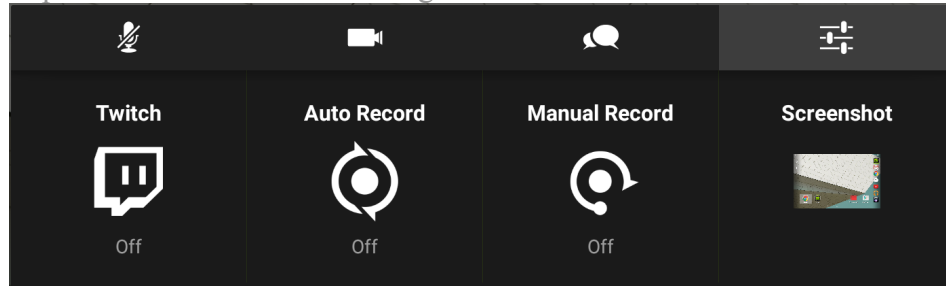

4. Tap **Auto Record**.
5. Tap the **Previous** and **Next** icons to scroll through the available lengths.
6. When the length that you want is showing, tap **Back**  to return to the Record and Share settings.

### How to Mute the Microphone for Gameplay Videos

The microphone captures audio from outside the game, such as your voice or sounds from your environment. Even with the microphone muted, the video includes the sound effects and music in the game unless you have muted the game's audio from within the game settings.

1. Open Quick Settings.
2. Tap **Share**.
3. Tap the **Microphone** icon  to toggle between mute and unmute.

### How to Block Chat from Your Twitch Broadcast

To prevent the Twitch chat stream from showing on your Twitch broadcast, tap the **Block Chat** icon before you select Twitch. When chat is blocked, your viewers cannot see or participate in the chat stream.

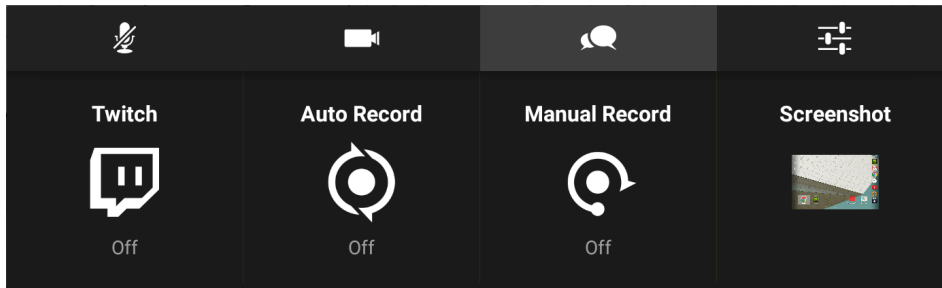



## How to View Recording and Broadcasting Status

When your tablet is recording or broadcasting video, the following status information shows under the System bar.



**NOTE** The status icons show information only. You cannot modify recording or broadcasting settings from the status icons.

- **Broadcast quality.** For example, Low Quality is **360p**, Medium Quality is **480p**, and High Quality is **720p**. Ultra Quality is **1080p**. Ultra Quality is not available for broadcast, but you can record and share Ultra Quality video.
- **Frame rate per second (fps).** For example, Medium and High Quality typically broadcast at about **30 fps**. Low Quality typically broadcasts at **25 fps**. Lower frame rates require less bandwidth.
- **Network speed (Mbps).** Many factors affect the network speed, including the strength of your local Wi-Fi connection and which Twitch server you are connected to. Network speed is shown when you are recording video even if you are not broadcasting.
- **Viewers.** The number next to the viewer icon  shows the number of people who are watching your broadcast.
- **Mute.** If your microphone is muted, a mute icon shows. If the microphone is not muted, no microphone icon shows.
- **Broadcast status.** The recording icon  shows when you are recording but not broadcasting. The broadcasting icon  shows when you are broadcasting live to Twitch.



- **Pause.** If your broadcast is paused, a pause icon shows.

## How to Broadcast Your Gameplay to Twitch TV

You can broadcast your gameplay to Twitch TV for other people to watch as you play. You can also use the front-facing camera to include your face in a picture-in-picture window with your gameplay. You must log into your Twitch account to broadcast from your tablet to Twitch.

For more information about Twitch, please visit the Twitch support page at [help.twitch.tv](http://help.twitch.tv).



## How to Create a Twitch Account

You must have a Twitch account to stream your gameplay to Twitch. You can create an account on the web at [Twitch.tv](http://Twitch.tv) or sign up through the Twitch control panel on your tablet.

1. Open Quick Settings.
2. Tap **Share**.
3. Tap **Twitch**.
4. Tap **Log In**.
5. Tap **Sign up for Twitch**. The browser opens.
6. Follow the prompts to create your Twitch account.

## How to Connect Your Tablet to Twitch

1. Open Quick Settings.
2. Tap **Share**.
3. Tap **Twitch**.
4. Tap **Log In**.
5. Enter your Twitch user name and password.

- To customize Twitch, tap the settings icon  and select **Twitch settings**.
- To broadcast live, tap **Start Broadcasting**.
- To return to your game, tap **Recently Used Apps**  and open the game.

## How to Broadcast Your Gameplay to Twitch

The broadcast shows everything that you do on your tablet, including browsing incognito or logging into your mobile banking app. Do not do anything on the tablet that reveals personal or private information while you are broadcasting.

1. Open the game you want to play.

2. Open Quick Settings.
3. Tap **Share**.
4. Tap **Twitch**.
5. Tap **Broadcast**.

## How to Stop Broadcasting

1. Open Quick Settings.
2. Tap **Share**.
3. Tap **Twitch**.
4. Tap **Stop**.

## How to Share Your Broadcast

The Share option sends the direct link to your Twitch broadcast. Share is only available when you are broadcasting.



1. Start broadcasting.
2. Open Quick Settings.
3. Tap **Share**.
4. Tap **Twitch**.
5. Tap **Share**.
6. Select a sharing method.
7. Follow the prompts to complete the share.

## How to Apply the Recommended Quality and Server Settings

1. Open Quick Settings.
2. Tap **Share**.
3. Tap the Record and Share settings icon .
4. Tap **Twitch**.
5. Tap **Recommend Best Settings**.
6. Tap **OK**. Twitch analyzes your network connection to determine the server and the video quality to recommend. When analysis is complete, the results dialog box opens.
7. To close the dialog box without applying the settings, tap **OK**. To apply the recommended settings, tap **Use**.



## How to Change the Twitch Server

Typically, a server that is closer to your location provides a faster connection speed. However, if you are experiencing server issues, you might want to connect to a different server.

1. Open Quick Settings.
2. Tap **Share**.
3. Tap the Record and Share settings icon .
4. In the Record and Share settings control panel, tap **Twitch**. The Twitch settings control panel opens.
5. Tap the **Previous** and **Next** icons to scroll through the available servers.
6. When server that you want is showing, tap **Back**  to return to the Record and Share settings.

## How to Pause Broadcasting Automatically When You Switch Apps

This setting pauses the broadcast when you are switching apps. The broadcast resumes automatically when you are in an app, even if that app is not your game.

1. Open Quick Settings.
2. Tap **Shield Menu**.
3. At the bottom of the screen, tap the Record and Share settings icon .
4. In the Record and Share settings control panel, tap **Twitch**. The Twitch settings control panel opens.
5. Tap **Pause broadcasting when switching apps**.
6. To return to your game, tap **Recently Used Apps**  or **Back** .



# GameStream

## nvidia gamestream

Experience your library of PC games in the palm of your hands or on your big screen TV. Either with game-speed Wi-Fi with ultra-low latency or a wired Ethernet connection, GAMESTREAM officially supports over 100 of the best PC games, including awesome games like *Batman: Arkham Origins*, *Titanfall*, and *Assassin's Creed IV: Black Flag*.

SHIELD gives you the power to access your GeForce® GTX-powered computer from the comfort of your couch. Play your favorite PC games on a full-size controller with ultra-low latency thanks to SHIELD 's game-speed Wi-Fi and the fast performance of GeForce GTX GPUs. Use a [SHIELD Controller](#) or mouse and keyboard to play almost any game on a big screen TV with Console Mode.

- Enjoy full optimization for game speed WiFi with ultra-low latency, using any of our recommended routers.
- Experience visual performance with 1080p at up to 60 frames per second on SHIELD tablet's 8" HD multi-touch LCD display or take advantage of 1080p streaming to your HDTV.
- Console Mode ready - experience your favorite PC games on the big screen

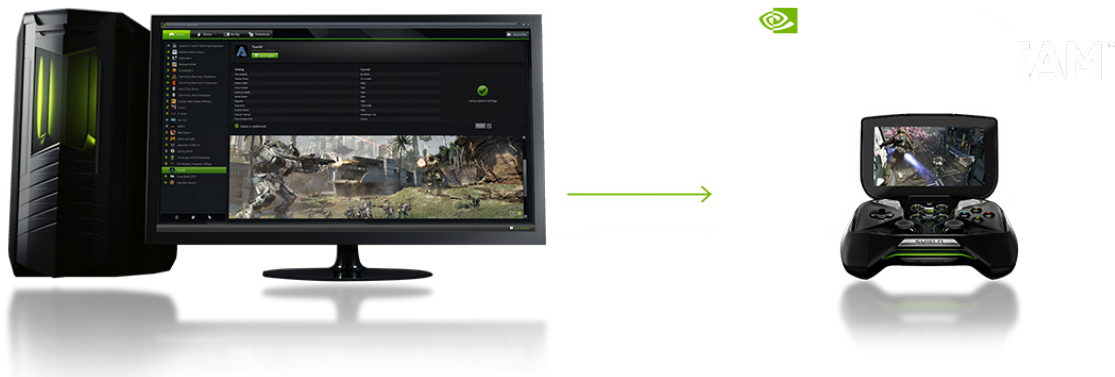

## System Requirements for GAMESTREAM



The basic requirements are a Wi-Fi router and a modern gaming PC with a GeForce GTX 650 or higher desktop GPU.

**NOTE** With the latest software for SHIELD Software Update 71, you can now use a GeForce powered notebook to GameStream your game library to your SHIELD.

The detailed requirements are:

- **GPU:**
  - Desktop: GeForce GTX 650 or higher
  - Notebook: GeForce GTX 800M, GTX 700M, and select (Kepler-based) GTX 600M GPUs

- **CPU:** Intel Core i3-2100 3.1GHz or AMD Athlon II X4 630 2.8GHz or higher
- **System Memory:** 4GB or higher
- **OS:** Windows 8 or Windows 7
- **Software:**
  - Latest GeForce Display Drivers ([www. GeForce.com](http://www. GeForce.com))
  - Latest version of GeForce Experience (Installed with Driver)
  - Latest Steam Client
- **Routers:** 802.11a/g router (minimum). 802.11n dual band router (recommended). SHIELD should be connected at 5GHz to take advantage of full gaming optimizations in GameStream mode.  
Refer to <http://shield.nvidia.com/accessories-hardware/> for a list of recommended dual-band routers.

## PC Games Supported by GameStream

Go to <http://shield.nvidia.com/pc-game-list/> to find the latest list of games that provide the best experience for PC game streaming. New games are added frequently.

## how gamestream works

NVIDIA uses the H.264 encoder built into GeForce GTX 650 or higher desktop GPUs along with an efficient wireless streaming software protocol integrated into GeForce Experience to stream games from the PC to SHIELD over the user's home Wi-Fi network with ultra-low latency. Gamers can then use [SHIELD controller](#) + SHIELD as the controller and display for their favorite PC games that are supported for GameStream, as well as for Steam Big Picture.



In addition to streaming the game, NVIDIA also configures PC games for streaming using GeForce Experience to deliver a seamless out-of-the-box experience. There are three key activities involved here:

- **Generating optimal game settings for streaming games from the PC to SHIELD .** We use our GeForce Experience servers to determine the best quality settings based on the user's CPU and GPU, and target higher frame rates than 'normal' optimal settings to ensure the lowest latency gaming experience. These settings are automatically applied when the PC game is launched so gamers don't have to worry about configuring these settings themselves.
- **Enabling controller support in games.** This avoids gamers having to manually configure controller support in the game – it 'just works' out of the box.
- **Optimizing the game launch process.** This is important so that gamers can get into the game as quickly and seamlessly as possible, without hitting launchers or other 2 foot UI interactions that can be difficult to interface with a controller.

## How to Configure GameStream PC

# how to configure gamestream PC

## Setting Up Your PC

1. Connect both SHIELD and PC to the same WiFi-N router.
  - For best performance, it is recommended that the PC is connected via Ethernet to the router, and the SHIELD is connected to the router on the 5G channel.
2. Install the latest GeForce display driver available at <http://www.geforce.com/drivers>. This will automatically install GeForce Experience as well.
3. Launch GeForce Experience.
4. On the Preferences > GameStream tab in GeForce Experience, specify the location where you want GeForce Experience to scan for games.
5. Scan for games. 
6. On the My Rig tab in GeForce Experience, confirm that your PC meets the hardware requirements for game streaming.
7. Install your favorite SHIELD compatible games and make sure you have the latest version of Steam installed to be able to play games through Steam Big Picture.
8. Log into Steam or Origin and make sure that the games you want to stream have been installed and previously launched once (with any patches/etc applied) from the PC.
9. Press the SHIELD button  on your [SHIELD Controller](#) to launch SHIELD Hub and select the "My PC Games" tab. Find the available PCs on the network from which to stream games to SHIELD .
10. Select your PC to pair with from the list of available PCs. A pin code will pop up on the SHIELD screen. This pin allows for a more secure and unique connection to the particular PC. This also allows you to connect to more than one PC from the same SHIELD .
11. A one-time pairing pop-up will appear on your PC. Enter the pin code from the SHIELD and click on the Connect button in the pop-up.
12. You will now see a list of supported PC games that are available to stream from your PC.

## Using On-Screen Controls

On-screen controls allow users to interact with game dialogs to make GameStream a better experience on SHIELD. To access GameStream on-screen controls, use a two-finger tap or long-press the Start  button.

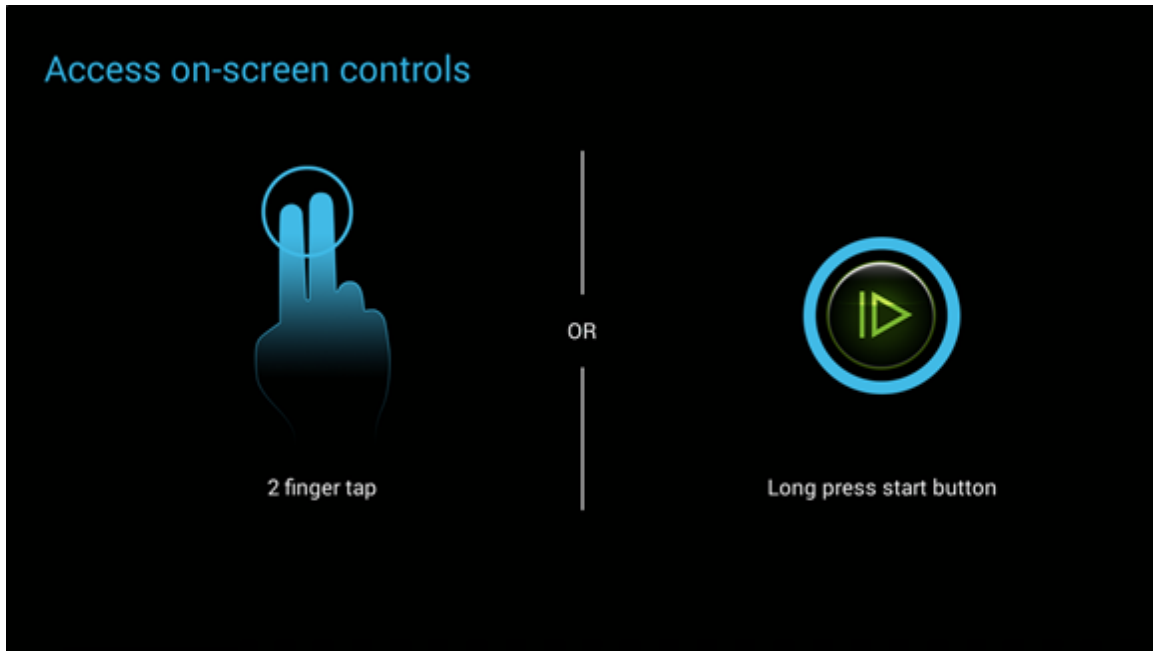

The on-screen controls will bring up a menu screen with four options: Steam, Keyboard, Quit, and Help.

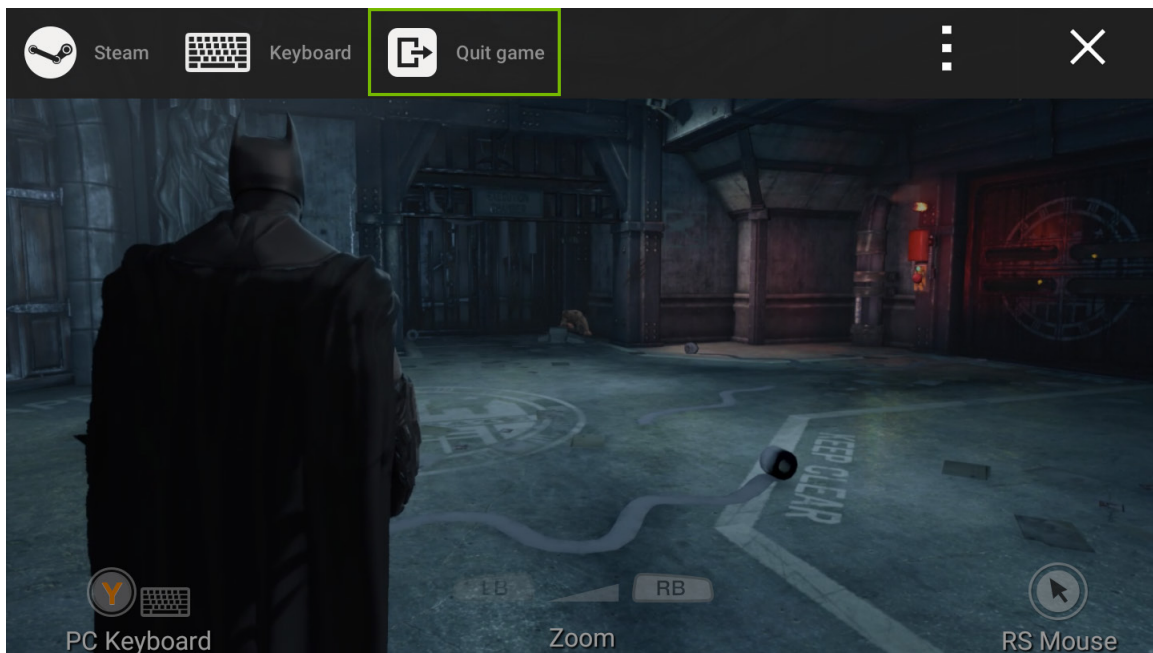



If you need to input information into a dialog, use the Keyboard selection.

Most of the touch navigation options are straightforward. Clicking Help will display the full list of available touch interactions.



## Streaming non-GAMESTREAM ready games

NVIDIA officially supports GameStream for over 100 games, but GeForce Experience allows users to manually add and stream nearly any game. Manage your list of manually added games in GeForce Experience under the GameStream section of the "Preferences" tab in GeForce Experience.

1. Open GeForce Experience and navigate to the "Preferences" tab and select "GameStream" from the menu on the left. You will see the following menu that will allow you to add any application to the SHIELD GameStream section of the SHIELD Hub app on your SHIELD .
2. Drag and drop a shortcut to your favorite game or click on the  sign to search your PC for the .exe of the application you would like to add to the GameStream list on SHIELD .
3. You can then click the  icon to edit the name and box art of the applications in your list.
4. Once you have added applications into the list, they will appear on your SHIELD 's GameStream list and can be launched just like any other app. Note that NVIDIA does not configure optimal settings for manually added games, so you may need to adjust in-game settings manually for the best experience.



**TIP** You can even use this feature to stream your entire PC desktop. To do so, add a shortcut to Windows' Remote Desktop Connection app (c:\windows\system32\mstsc.exe) in GeForce Experience, then select the newly added Remote Desktop tile from SHIELD 's My PC Games tab. From here, you have access to your entire desktop.

### *Tips for Interacting with Unsupported Games*

- SHIELD is a touch screen device that uses mouse emulation for streaming. Any time the user is in a situation where using the mouse would bypass a menu or in-game option that the controller will not operate, simply use the touch screen as the mouse.
- SHIELD has a full virtual keyboard built into the touch screen interface. As with the mouse, if there is a situation that requires a keyboard instead of the controller, use the virtual keyboard by tapping two fingers on the touch screen and tapping the keyboard icon that appears.
- While Streaming a PC game, you can use the Pinch to Zoom and Pan functions to better navigate menus or other in game elements that are hard to see. Simply pinch or expand with two fingers to zoom and use a two finger swipe to pan around while zoomed.

## Remote GAMESTREAM BETA

Remote GameStream is a new feature that will allow you to stream games from your PC to your SHIELD outside of your local WiFi network. To set up remote GameStream with your PC and SHIELD , follow the steps below.

1. Make sure your PC has Network discovery enabled. Go to Control Panel > Network and Sharing Center > Change advanced sharing settings and select 'Turn on network discovery.'

2. Pair your PC and SHIELD normally on a local Wi-Fi connection (or Ethernet) using the instructions in the GameStream section of this guide.



3. Take your SHIELD with you on the go and connect it to a robust Wi-Fi connection. When you open the "MY PC GAMES" menu in SHIELD Hub, launch a game from the list of available games to initiate a connection to your remote PC. Your SHIELD will automatically look for your PC and connect using the current internet connection.

**NOTE** You can find out more information about port forwarding for your specific router at <http://portforward.com/>



**NOTE** NVIDIA recommends Internet bandwidth of 10Mbps from your PC down to SHIELD tablet and 2Mbps from SHIELD tablet up to your PC. Streaming experience may vary depending on the quality of your Internet. For the best experience, connect SHIELD tablet to a 5Ghz router while streaming remotely.



**NOTE** Remote GameStream can be optimized by manually lowering your streaming bitrate for Wi-Fi. Doing this will reduce your image quality but will reduce latency. Adjust the bitrate manually to find the sweet spot for your configuration. You can do this by accessing the Advanced GameStream menu in SHIELD Hub. Please refer to the Advanced GameStream Features section of this guide for more information.

**NOTE**  The following routers from our [recommended router list](#) will need manual port forwarding for Remote GameStream to function properly.

- ASUS RT-AC66U -> ports 7 and 9
- ASUS RT-AC68U -> ports 7 and 9
- ASUS RT-N56U -> ports 7 and 9
- ASUS RT-N66U -> ports 7 and 9
- Netgear R6300 -> port 47989
- Buffalo Airstation Extreme 1750 -> may need all ports forwarded manually
- Buffalo Airstation Extreme 1200 -> may need all ports forwarded manually
- D-Link DIR-5500 -> may need all ports forwarded manually

If you have problems connecting to your PC directly, try manually forwarding all the following ports:

**UDP:** 7, 9, 47999, 47992, 47998, 47989, 48000

**NOTE**  When you pair your SHIELD to your GeForce PC locally, GeForce Experience records your external IP address and uses this to connect the SHIELD to the PC when you are remote. If your external IP address changes (i.e. due to dynamic IP address, etc), SHIELD won't be able to find your PC. You will either need to re-pair locally, or manually enter the new IP address in order to reconnect remotely. Static IP addresses and dynamic DNS can help here.

## Wake on LAN / Remote Log-In

Wake on LAN is a feature that will allow you to wake up your PC on your local network when you want to use GameStream on SHIELD. You no longer need to wake your PC and log-in manually to be able to stream your favorite games. To use Wake on LAN and Remote Log-In:

1. Hit the SHIELD button to open SHIELD Hub and navigate to the "MY PC GAMES" tab to view the games installed on your paired PCs.
2. When you select a game that you want to launch and start streaming, you will be notified that your PC is asleep and will be woken up.
3. Click "Continue" to wake the PC and launch the game. If your PC has a Windows password, you will be taken to the login screen where you can enter your password remotely. Use the two finger menu to bring up the virtual keyboard to enter your password.
4. Once you have entered your password, your PC will launch the selected application and begin streaming.

There are several important setup requirements for Wake on LAN:

1. Your motherboard and router must both support Wake on LAN. Depending on the motherboard, you may need to enable Wake on LAN in your motherboard SBIOS or the Device Manager settings for your Ethernet Adapter.
  - Depending on your PC and OS, you may need to make sure your PC only wakes up from magic packets, otherwise your PC may wake up inadvertently.
  - Go to Device Manager > Network adapters > [Your Ethernet adapter, ex. Intel] -> Power Management and check the option 'Wake on Magic Packet.'
2. Your PC must be connected to your router via Ethernet.
3. Your PC must be powered on and in sleep or hibernate mode. Wake on LAN is not supported for PCs that are shut down.
4. To wake up your PC while outside your Local Area Network, you may need to manually open ports depending on your router. See the Remote GameStream section for more details.

## Advanced GAMESTREAM Features

In SHIELD Hub under "Settings" you can access some of the advanced features available to fine tune your GameStream experience. To access these features, make sure you already have a PC paired. In the advanced settings menu, you can manually adjust streaming bit rates, frame rates and elect not to apply Optimal Settings for each game in your streaming list. This provides more control to the user to fine tune your streaming experience.

1. Open SHIELD Hub and navigate to the settings menus in the lower left hand corner.
2. Once in the settings menu, you can access the GameStream-ready PCs menu.

3. Here you can see all of the different PCs you have paired to your SHIELD and their current status. Select accessory settings .
4. In the accessory settings menu you can select "Quality" to manually change the bitrate at which your stream is delivered both from a Wi-Fi connection and from a wired Ethernet connection. You can also change the target frame rate that the SHIELD will deliver. This provides a lot of flexibility to the power user in how they stream.
5. Also in the accessory settings menu is the "Optimize games" menu where you can manually disable OPS (Optimal Playability Settings) for a particular game. This allows the user to disable the automatic settings we apply to allow you to tailor specific in-game settings for each game. You can also globally disable or enable OPS for a particular PC that you have paired to your SHIELD .
6. The GameStream menu also allows you to manually add a PC using the specific IP address of that particular PC. This can be an address on your local network (LAN) or an external IP (WAN) address. On the GameStream PCs menu you can click the "+" button to manually add a PC. Enter the IP address to search that address for a GeForce PC. This will then add this PC to your GameStream PCs menu.

## Tips and Tricks

- We recommend launching your games at least once on the PC **BEFORE** launching through SHIELD to install all of the prerequisites (VC Redists, DirectX ect..) and set up all DRM features (Games For Windows Live, SocialClub etc...).
- If you do not see your PC on the server list on your SHIELD, or cannot connect to your PC from SHIELD :
  - Verify that both SHIELD and the PC are connected to the same Wi-Fi router
  - Be sure the latest GeForce Experience software is loaded and running on the PC.
  - Verify that your PC meets the system requirements using the My Rig tab in GeForce Experience
  - Try manually adding your PC via IP address (refer to Advanced Settings)
- If you do not see a pairing request pop-up:
  - In GeForce Experience, press the Forget all devices button in the Preferences > GameStream tab
- If any of the above steps do not work, trying rebooting the SHIELD and the PC.

## GAMESTREAM for GeForce Notebooks

NVIDIA GameStream technology is compatible with GeForce GTX 800M, GTX 700M, and select GTX 600M GPUs installed in some of today's best gaming notebooks. GameStream on a notebook works exactly the same as on desktop and requires the same set up and software.

The full list of supported GTX GPUs for notebook is: 880M, 870M, 860M, 850M, 780M, 770M, 765M, 680M, 675MX, 670MX, and 660M.

To try out this new feature, please make sure you have the latest R337 or higher GeForce Drivers and GeForce Experience software available for your notebook.

**NOTE**  If you would like more information about this technology or if you have any issues, please contact your local NVIDIA Technical Marketing or PR representative. Contact information is available at the end of this guide.

## steam big picture

Big Picture shows up as a selection in the list of SHIELD-optimized games. Launching it gives you access to your STEAM games—both supported and unsupported—plus the STEAM Store and all the STEAM community features. Supported games are recommended for the best, optimized streaming experience—the latest list of supported games can be found on <http://shield.nvidia.com/pc-game-list/> starting at launch. Unsupported games may work if they have native controller support, but will not be optimized for streaming and may have other streaming compatibility issues.

## troubleshooting pc game streaming

If you are experiencing issues with streaming games from your PC to SHIELD, try these troubleshooting options:

### General Troubleshooting Issues

#### Make sure your PC meets the minimum requirements for streaming.

The requirements for PC Game streaming are very specific. Make sure your GeForce GTX PC meets these requirements and that you have proper drivers and software. See the list of system requirements or go to the **My Rig** tab in [GeForce Experience](#) to confirm that your PC meets the system requirements.

#### Confirm that the PC and SHIELD are connected to the same network.

Make sure SHIELD and the PC streaming the game are connected to the same router or wireless access point. If your PC is connected using Wi-Fi, make sure it is connected to the same wireless access point as the SHIELD unit. If the PC is using a wired connection, make sure the network cable is directly connected to the same physical router.

Make sure the game you are attempting to play is supported for streaming, installed, and patched.

Not all games have been optimized for PC game streaming to SHIELD. Verify the game you are trying to play is on the list of [supported games](#). It is also recommended that you launch the game at least once on your PC BEFORE launching on SHIELD. Doing this ensures that all of the prerequisites (VC Redirects, DirectX, et al) and the set-up of all DRM features (Games for Windows et al) are completed.

#### Check Windows and wireless router firewall settings.

Make sure that streaming is not being blocked by a firewall; either from the computer or wireless router. You can either temporarily disable the firewall or add an exception to allow the traffic. You can access Windows Firewall settings through the Control Panel on your PC. For information on other software firewalls or firewalls built into your router, refer to those products' manufacturers.

#### Check SHIELD Wi-Fi setting.

Make sure that the Wi-Fi setting on your SHIELD is turned **ON** (go to **Settings -> Wi-Fi**). Check to make sure SHIELD has successfully connected to the network. Try resetting the Wi-Fi option by turning it OFF and then back ON. Try resetting your wireless access point connection by disconnecting and re-connecting.

If you try to stream a game with Wi-Fi off, the following displays.

Select **Wi-Fi** and the Wi-Fi menu displays. Turn the Wi-Fi **ON**.

#### Check the internet connection.

Check whether or not you are able to access the Internet on SHIELD and the PC. Try resetting your wireless access point connection if you cannot connect.

### Specific Troubleshooting Issues

If SHIELD displays **No available GeForce GTX PCs found**, when scanning for available PCs, try the following:

- Does the PC meet the minimum [System Requirements](#)?

- Is the PC on the same network, connected through the same router as the SHIELD device?
- Are your firewall interfering or disabling the connection?
- Is your PC powered on? Are you logged in to your PC?

If any of these checks did not fix the issue, try rebooting both SHIELD and your PC.

- Did you see any pairing request pop-up window on your PC when trying to connect?

If this pop-up window did not display on your PC during the connection process, go to [GeForce Experience](#) and select **Forget devices** from **Preferences > GameStream**.

## bluetooth keyboard and mouse support

There are many Bluetooth keyboards and mice that are available in the marketplace. The SHIELD portable is an Android-powered device and pairs natively with peripherals that are Bluetooth enabled without a required USB dongle.

NVIDIA has tested the following Bluetooth keyboards and mice and found that they are compatible with the SHIELD portable:

- Logitech K810
- Microsoft Wedge Mobile Keyboard
- Motorola Wireless Keyboard
- Logitech Tablet Keyboard
- Anker Ultra Slim Mini Bluetooth Keyboard
- Razer Orochi Mobile PC Gaming Mouse
- Gigabyte GM-M7700B
- Microsoft Sculpt Comfort Mouse
- HP X4000b Bluetooth Mouse

A lap desk can be used to make gaming in front of a big screen TV easier when using a keyboard and mouse. The following lap desks are a few recommended solutions:

- LapGear 45492 Deluxe Computer LapDesk
- LapWorks Original Laptop Desk
- LapWorks Futura Gamers LapDesk
- LapGear 45303 Multi-Purpose Jumbo LapDesk

## using gamestream in console mode

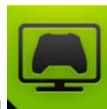

Console mode can be launched using the application icon  or by connecting a Mini-HDMI cable to SHIELD .

On the HDTV, the Console Mode will display.

If the Mini-HDMI cable is disconnected from SHIELD , a message displays to exit Console Mode.

**NOTE**  Each time you enter or exit Console Mode, SHIELD is reset.

## Setup Requirements

- **HDTV**
  - HDTV with HDMI support. Use the Gaming or Sports mode for the HDTV if it supports it to reduce input latency.
- **Bluetooth Controller or Keyboard and Mouse**
  - Bluetooth wireless controller. NVIDIA recommends the Nyko PlayPad Pro.
  - Bluetooth keyboard and mouse. Refer to [Bluetooth Keyboard and Mouse](#) for further details.
- **Cable**
  - Mini-HDMI to HDMI cable
- **Micro USB Ethernet Adapter**
  - Connect a wired Ethernet cable from your router to your SHIELD. NOTE: There are many different types of Micro USB Ethernet adapters available in the marketplace. The adapter must be a male Micro USB connector to a female Ethernet connector.

## Configure GameStream for 1080p

1. Connect an Ethernet cable to your router.
2. Connect the Ethernet cable from your router into a Micro USB Ethernet adapter. Connect the Micro USB end into the Micro USB port on the back of your SHIELD.



A Micro USB Ethernet adapter like the one above can be used, but the SHIELD portable cannot be charged with this type of adapter. To charge the SHIELD portable while using Ethernet, a Micro USB Y-Cable with input for Micro USB power and full-size USB Ethernet will need to be used. Of course, a full-size USB2 to Ethernet adapter will be needed in conjunction with the Y-Cable.



Micro USB Y-Cable



## Standard USB Ethernet Adapter

Connect the cables in the following order (the order is important):

- A. Plug an Ethernet cable from the Router.
- B. Plug the USB Ethernet Adapter into the Micro USB Y-Cable.
- C. Plug the SHIELD AC Adapter into the Micro USB Y-Cable.
- D. Plug the male Micro USB connector on the Y-Cable to SHIELD.

3. Launch Console Mode.

## geforce experience

[GeForce Experience](#) is an application from NVIDIA that optimizes your PC in two key ways.

1. GeForce Experience automatically notifies you of new [NVIDIA drivers](#) and downloads them for you. NVIDIA is constantly working to improve its drivers. New drivers improve game performance, add new features, and fix bugs.
2. GeForce Experience optimizes graphics settings in your games based on your hardware configuration. NVIDIA performs extensive game testing for various combinations of GPUs, CPUs, and monitor resolutions and stores this information in the NVIDIA cloud. GeForce Experience connects to the NVIDIA Cloud and downloads [optimal playable settings \(OPS\)](#) for your games tailored specifically to your PC.

The result is that your PC is always kept up to date and optimized for the latest games. To utilize optimized PC games on your SHIELD device, you will need to have GeForce Experience installed on your PC.

For GeForce GTX 900 Series GPUs, GeForce Experience adds digital super resolution mode, 4K video recording, wired PC controller support for SHIELD wireless controller, and improved ShadowPlay performance of SLI configurations.

For more information on GeForce Experience, go to <http://www.geforce.com/geforce-experience>.



# shield controller

Your NVIDIA® SHIELD™ controller works with your SHIELD using Wi-Fi Direct for exceptional responsiveness and immersion in today's hottest games. It is the first-ever precision controller designed for both Android™ and PC gaming. Use the SHIELD controller when connected to a TV for multi-player games. You can connect up to four SHIELD controllers to your SHIELD device.

The controller includes the following features:

- Console-grade controls
- Ultra-responsive Wi-Fi performance
- Stereo headset jack with chat support
- Microphone for voice search
- Touch pad for easy navigation
- Rechargeable battery and USB charging cable



For detailed information on the SHIELD controller, refer to documentation that comes with the controller.

## Connect SHIELD controller to your SHIELD portable

1. Verify that your SHIELD portable has Wi-Fi turned on. The device does not have to connect to a network, but Wi-Fi must be turned on.

2. Open the SHIELD controller app  on your SHIELD device.

3. Tap the NVIDIA button  on the wireless controller. The NVIDIA button flashes to show that the controller is in connection (pairing) mode. If the NVIDIA button is not flashing, hold the NVIDIA button until it starts flashing, and then release.

4. When the controller is connected, you can press  to open the Quick Guide, Settings, or Help. A controller icon  shows in the status bar on your SHIELD device. This icon indicates that the controller is on and connected. The white portion of the icon indicates the amount of charge left in the controller.

5. **Optional:** You can connect up to four SHIELD controllers to your SHIELD device. Repeat Steps 1 through 4 to connect each additional controller.

## SHIELD controller Overview

The SHIELD controller box includes one SHIELD controller, one USB charging cable, one Support Guide, and one Quick Start Guide.

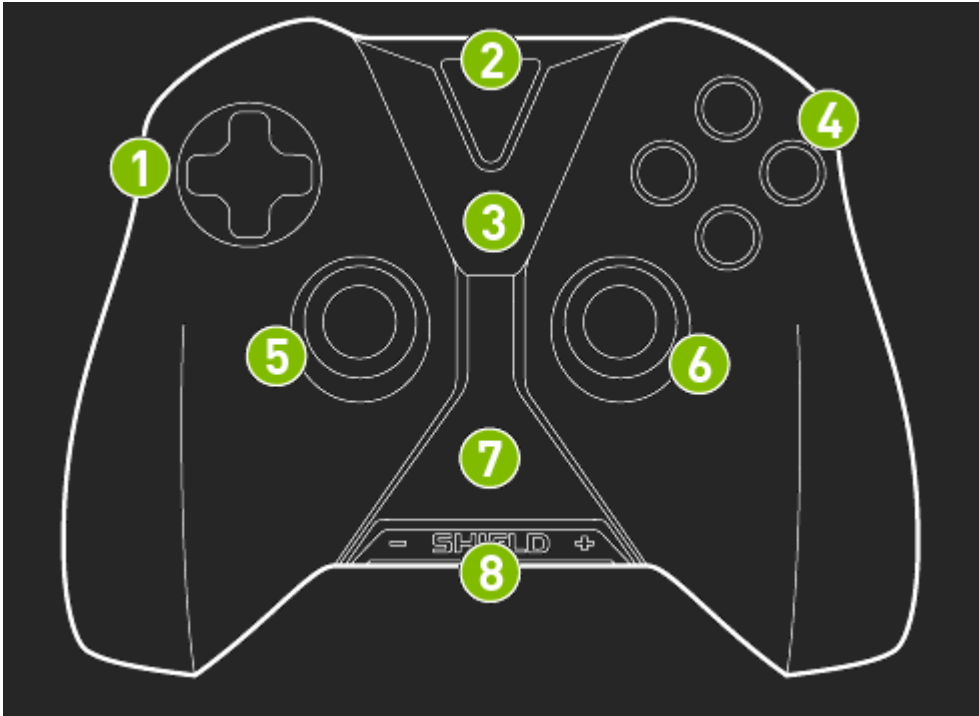

1	D-pad
2	NVIDIA button
3	Android navigation and Start buttons
4	A-B-X-Y buttons
5	Left thumbstick
6	Right thumbstick
7	Touchpad
8	Volume control

## how to turn on the controller

Tap the **NVIDIA** button.

## How to turn off the controller

Hold the **NVIDIA** button for 6 seconds.

The controller automatically turns off when you turn off the SHIELD device the controller is connected to. The controller also automatically turns off after 10 minutes of idle time. The controller stays on during video and music playback on the SHIELD device. This allows the controller to be active to control media playback.

# gamepad mapper

Gamepad Mapper dramatically expands your library of Android games by adding controller support to native touchscreen games, making everything from NBA JAM to Angry Birds playable on the SHIELD portable's console-grade controller.

NVIDIA provides default Gamepad Mapper profiles for hundreds of top Android games, which are automatically downloaded from the cloud so you can just launch your game and play. Use NVIDIA's default profile, or create your own custom profile and share it with the community.

When a Mapper game is launched, a message is displayed stating that Gamepad Mapper is activated.

A full list of Android games supported by Gamepad Mapper can be found at:

<http://shield.nvidia.com/android-game-list/>.

## creating your own gamepad mapper profile

To access Gamepad Mapper, long-press the Start button while in game to display the Gamepad Mapping controls



or long-press the NVIDIA button and access the Gamepad Mapper from the SHIELD Power Menu.



Use the Back button to exit Gamepad Mapper and back to the game. You can also touch the button above the trash can on the Gamepad Mapper screen.



To see a description of each function, click on the individual icon in the image below.





# Extend Your Tablet

## How to Use Bluetooth Accessories

Your NVIDIA device pairs with Bluetooth accessories such as keyboards, speakers, and headphones. You can also pair with other Bluetooth-enabled devices. Bluetooth functionality is a standard Android feature.

For help with the Android OS, please visit Google's support website at <http://support.google.com/android/>.

### Bluetooth Behavior

#### How to Turn Bluetooth On or Off

When Bluetooth is on, the Bluetooth icon shows in the System bar.

1. Swipe down from the System bar. The Quick Settings shade opens.



2. Tap **Bluetooth**

### Bluetooth Accessories

#### How to Pair a Bluetooth Accessory with Your Device

The first time you use a Bluetooth accessory, you must pair the accessory and the device. You can also follow these steps to pair your NVIDIA device with another Bluetooth device such as a smart phone.

**NOTE** The Google Keyboard on the touchscreen is not active when a Bluetooth keyboard is paired with your device.

1. Follow the instructions from your accessory's manufacturer to put the accessory into Pair mode.
2. On your NVIDIA device, go to **Settings > Wireless & Networks**.
3. Tap **Bluetooth**. The Bluetooth control panel opens.
4. If Bluetooth is off, tap the **ON/OFF** switch to turn on Bluetooth.
5. If your NVIDIA device is visible only to paired devices, tap the device name to enable visibility. Your device searches for nearby Bluetooth accessories.
6. When the Bluetooth accessory appears in the list of **Available Devices**, tap the accessory's name to pair it. If the pairing is successful, the accessory now appears on the list of **Paired Devices**.



**NOTE** Some devices require a passkey before pairing. In these cases, your SHIELD device prompts you to verify that the passkey is appearing on your other device. Respond to any security prompt on that device. Then on your SHIELD device, tap **Pair** to complete the pairing or **Cancel** to cancel the pairing.

## How to Disconnect a Bluetooth Accessory from Your Device

Disconnecting the Bluetooth accessory does not permanently cancel the pairing. The accessory remains on the list of Available Devices with a status of Disconnected.

1. Open **Settings**.
2. Tap **Bluetooth**. The Bluetooth control panel opens.
3. In the list of **Paired Devices**, tap the accessory's **Settings** icon . The accessory control panel opens.
4. Tap **Forget**.

## How to Rename Your Bluetooth Accessory in the Paired Devices List

Your Bluetooth accessories appear on the list with names that are assigned by the manufacturer. These names are often a product number or a brand name. You can rename the accessories so that when you look at the list of available or paired devices, you know exactly what your SHIELD device is connected to.

Renaming a Bluetooth accessory only changes the name in the Paired Devices list. Your accessory is not affected.

1. Open **Settings**.
2. Tap **Bluetooth**. The Bluetooth control panel opens.
3. In the list of **Paired Devices**, tap the accessory's **Settings** icon . The accessory control panel opens.
4. Tap the **Name** field.
5. Enter the new name and tap **OK**.

## How to Use Bluetooth Accessories

Your NVIDIA device pairs with Bluetooth accessories such as keyboards, speakers, and headphones. You can also pair with other Bluetooth-enabled devices. Bluetooth functionality is a standard Android feature.

For help with the Android OS, please visit Google's support website at <http://support.google.com/android/>.

## Bluetooth Behavior

### How to Turn Bluetooth On or Off

When Bluetooth is on, the Bluetooth icon shows in the System bar.

1. Swipe down from the System bar. The Quick Settings shade opens.
2. Tap **Bluetooth** 

## Bluetooth Accessories

### How to Pair a Bluetooth Accessory with Your Device

The first time you use a Bluetooth accessory, you must pair the accessory and the device. You can also follow these steps to pair your NVIDIA device with another Bluetooth device such as a smart phone.

**NOTE** The Google Keyboard on the touchscreen is not active when a Bluetooth keyboard is paired with your device.

1. Follow the instructions from your accessory's manufacturer to put the accessory into Pair mode.
2. On your NVIDIA device, go to **Settings > Wireless & Networks**.
3. Tap **Bluetooth**. The Bluetooth control panel opens.
4. If Bluetooth is off, tap the **ON/OFF** switch to turn on Bluetooth.
5. If your NVIDIA device is visible only to paired devices, tap the device name to enable visibility. Your device searches for nearby Bluetooth accessories.
6. When the Bluetooth accessory appears in the list of **Available Devices**, tap the accessory's name to pair it. If the pairing is successful, the accessory now appears on the list of **Paired Devices**.



**NOTE** Some devices require a passkey before pairing. In these cases, your SHIELD device prompts you to verify that the passkey is appearing on your other device. Respond to any security prompt on that device. Then on your SHIELD device, tap **Pair** to complete the pairing or **Cancel** to cancel the pairing.

### How to Disconnect a Bluetooth Accessory from Your Device

Disconnecting the Bluetooth accessory does not permanently cancel the pairing. The accessory remains on the list of Available Devices with a status of Disconnected.

1. Open **Settings**.
2. Tap **Bluetooth**. The Bluetooth control panel opens.
3. In the list of **Paired Devices**, tap the accessory's **Settings** icon . The accessory control panel opens.
4. Tap **Forget**.

### How to Rename Your Bluetooth Accessory in the Paired Devices List

Your Bluetooth accessories appear on the list with names that are assigned by the manufacturer. These names are often a product number or a brand name. You can rename the accessories so that when you look at the list of available or paired devices, you know exactly what your SHIELD device is connected to.

Renaming a Bluetooth accessory only changes the name in the Paired Devices list. Your accessory is not affected.

1. Open **Settings**.

2. Tap **Bluetooth**. The Bluetooth control panel opens.

3. In the list of **Paired Devices**, tap the accessory's **Settings** icon . The accessory control panel opens.

4. Tap the **Name** field.

5. Enter the new name and tap **OK**.

## How to Use Headphones or Headsets

Connect headphones or headsets to the 3.5 mm jack on the edge of the tablet.

Headphones provide audio output only and the built-in microphone is used for audio input. Headsets include a microphone and provide audio output and input. When you use a headset, the internal microphone automatically turns off.

You can also use Bluetooth headphones and headsets with your tablet. For more information, see [How to Use Bluetooth Accessories](#).

## How to Add Storage with a microSD Card

Your device includes a microSD slot so that you can add storage space for photos, music, and videos.

SD cards are available in different classes and capacities. Higher classes indicate faster speeds for performing actions such as displaying photos or saving videos. Higher capacities indicate greater storage space.

**NOTE**  Always unmount the microSD card in the Settings before you physically eject the card from your device.

### Recommended microSD Card Class

NVIDIA recommends using a class 6 or higher microSD card.

### Required microSD Card Formats

For microSD cards up to 32 gigabytes in capacity, SHIELD supports the FAT32 data format. Most microSD cards that are 32-GB or less are already formatted as FAT32.

For microSD cards that are 64-GB or more in capacity, SHIELD supports the NTFS data format. Most microSD cards that are 64-GB or larger come formatted as exFAT and must be reformatted before you can use them with SHIELD. Android does not support the exFAT file system.

**NOTE**  You can reformat microSD cards on your Windows PC or Mac computer.



## How to Insert a microSD Card

1. Locate the microSD card slot on the edge of the tablet, near the volume control.
2. Position the microSD card with the connectors facing the back of the tablet.
3. Gently press the microSD card into the slot. When you feel the card secure itself in the slot, release.



## How to Unmount and Eject a MicroSD Card

Always unmount the microSD card before you remove the microSD card from the device.

1. Tap **All Apps** .
2. Tap **Settings** .
3. Tap **Storage**.
4. Tap **Unmount SD Card**.
5. Press the microSD card deeper into the slot and then release. The microSD card disconnects from the slot.
6. Grasp the edge of the microSD card and remove the microSD card from the device.

## How to Move Content to a MicroSD Card

Some apps do not support microSD card storage. If the app control panel does not have an option to **Move to SD Card**, the app must remain in your device's internal storage.

1. Go to **Settings > Apps**.
2. Tap the app that you want to move. The app control panel opens.
3. Tap **Move to SD Card**.
4. At the prompt, tap **OK** to confirm.

## How to View MicroSD Card Storage

To view the status of internal storage and the microSD card, go to **Settings > Storage**.

## How to Install a Micro-SIM Card

If you have the LTE version of the tablet, you can connect to a cellular network by installing a micro-SIM card and subscribing to a wireless data service.

**NOTE**  On the Wi-Fi version of the tablet, the micro-SIM card slot cover is present but non-functional.

## How to Install a Micro-SIM Card

1. Hold the tablet with the touchscreen facing you.
2. Carefully open the micro-SIM card slot cover. Rotate the cover to the right.
3. Position the micro-SIM card with the gold contacts facing away from you and the notch on the bottom right of the card.

4. Push the micro-SIM card into the micro-SIM card slot until you feel a slight click. When you release, the micro-SIM card stays in the slot.
5. Close the slot cover.

### **How to Remove a Micro-SIM Card**

1. Open the micro-SIM card slot cover.
2. Press the micro-SIM card deeper into the slot and then release. The micro-SIM card disconnects from the slot.
3. Grasp the edge of the micro-SIM card and remove the micro-SIM card from the device.

# How to Use NVIDIA Lasso Capture

NVIDIA® Lasso Capture provides a quick and easy way to take screenshots of all or part of your screen. You can also annotate and share the captures.

Captures are stored in the Photos with your other photos and images. View, edit, and share captures just like you would any other image.

## How to Enable Access to Lasso Capture

1. Go to **Settings > DirectStylus**.
2. Under Stylus Mode and Lasso Capture, select the **Quick access via navigation bar** check box.

## How to Open Lasso Capture

1. Remove the stylus from its holder.
2. In the Navigation bar, tap **Lasso Capture** .

## Captures



### How to Capture a Screenshot of the Whole Screen

1. Remove the stylus from its holder.
2. In the Navigation bar, tap **Lasso Capture** .
3. Tap **Screenshot** .
4. To annotate the capture, tap the pen  and write a note on the captured area.
5. Tap **Save**. The capture is saved to Photos.

### How to Capture a Rectangular Region

1. Remove the stylus from its holder.
2. In the Navigation bar, tap **Lasso Capture** .
3. Tap **Rectangular Region** .
4. Tap and drag the stylus around the area you want to capture.
5. To annotate the capture, tap the pen  and write a note on the captured area.
6. Tap **Save**. The capture is saved to Photos.

## How to Capture a Free-Hand Region

1. Remove the stylus from its holder.
2. In the Navigation bar, tap **Lasso Capture** .
3. Tap and drag the stylus around the area you want to capture.
4. To annotate the capture, tap the pen  and write a note on the captured area.
5. Tap **Save**. The capture is saved to the Gallery.

## How to Share a Capture

You can share the capture without saving it to the gallery.

1. Take a capture. Do not tap **Save**.
2. Tap **Share** .
3. Tap the sharing method that you want to use.
4. Follow the prompts to send the capture.

## How to Save a Capture to PDF

Use ES File Explorer to open the PDF for viewing and annotating.

1. Take a capture. Do not tap **Save**.
2. Tap **Share** .
3. Tap **Convert to PDF**.

## How to Take a Full-Screen Screenshot Without the Stylus

Press and hold the device's **Power** button and **Volume Down** button simultaneously for a few seconds. A snapshot sound indicates that the screen has been captured. The capture is saved to **Photos**.

# How to Use NVIDIA Dabblers

NVIDIA® Dabblers™ is a drawing and painting app that is optimized for use with your NVIDIA DirectStylus.

The first time you open NVIDIA Dabblers, a tutorial shows you how to use all the features of the app. NVIDIA Dabblers also includes help tips that you can show or hide as needed.

## How to Open NVIDIA Dabblers

1. Tap **All Apps** 
2. Tap **NVIDIA Dabblers** 



## Learn the NVIDIA Dabblers Workspace



<b>1</b>	<b>Toolbars.</b> The General Toolbar (left) provides actions such as <b>Load, Share, Save</b> and <b>Print</b> . The Canvas Toolbar (right) provides background settings and several brushes and drawing tools.
<b>2</b>	<b>Workspace.</b> The Workspace displays the paper texture or background image that you have chosen for your project.

## Manage

### How to View the NVIDIA Dabblers Help Tips

1. In the Toolbar, tap **Help** .
2. Tap any icon, brush, or feature to view its description.
3. To hide help tips, tap **Help**  again.
4. Alternatively, you can tap and hold on any UI item to obtain help.

### How to Undo or Redo the Previous Action

In the Toolbar, tap **Undo**  or **Redo** .

### How to Save Your Work

In the Toolbar, tap **Save** . A copy of your work is saved to the Gallery. You can keep working, but the saved image is not updated to reflect the changes. Save your work again before you clear the canvas.

### How to Load Your Work

In the Toolbar, tap **Load** . A dialog box with available canvases from local and cloud storage is shown. Swipe through the canvases and double tap to select a canvas.

### How to Print Your Work

In the Toolbar, tap **Print** . The print menu is shown, which includes options for saving to Google Drive (Gmail account required) and saving as .pdf.

### How to Show or Hide the Toolbar

To show the General Toolbar, tap .

To hide the General Toolbar, tap .

To show the Canvas Toolbar, tap .



To hide the Canvas Toolbar, tap .

## Create Artwork

### NVIDIA Dabblers Painting Styles









In the Toolbar, tap  to select a painting style.

	<b>Sketch.</b> Sketch includes the marker, pencil, and eraser tools.
	<b>Watercolor.</b> Watercolor includes all of the drawing and painting tools except the spatula. Gravity, instant-dry, and water level features are only available in Watercolor.
	<b>Oil.</b> Oil includes all of the drawing and painting tools. The spatula tool is only available in Oil.

### NVIDIA Dabblers Tools



In the Toolbar, tap the tool icon which is directly above  to access the tool selection dialog box. The actual icon displayed by the tool icon depends on the specific tool selected and will be one of the tools shown in the table below.

	<b>Spatula.</b> The spatula replicates the effect of a spatula or chisel on oil painting. Spatula is only available in Oil.
	<b>Thick brush.</b> The thick brush replicates the effect of a wide paint brush. Thick brush is not available in Sketch.
	<b>Thin brush.</b> The thin brush replicates the effect of a detail paint brush. Thin brush is not available in Sketch.
	<b>Eraser.</b> The eraser replicates the effect of a rubber eraser. Keep moving the eraser until you achieve the effect that you want.
	<b>Pencil.</b> The pencil replicates the effect of a graphite pencil.



**Marker.** The marker replicates the effect of a permanent ink pen.

Use the **Pressure sensitivity** slider at the bottom of the dialog to adjust the impact of pressure on the currently selected



brush radius

## How to Adjust Brush Styles



In the Toolbar, use the sliders to adjust the brush fill strength and the relative brush radius . The actual brush radius is controlled by the pressure and angle of the stylus tip on the touchscreen.

## How to Show or Hide the Color Palette





To show or hide the color **Palette**, tap

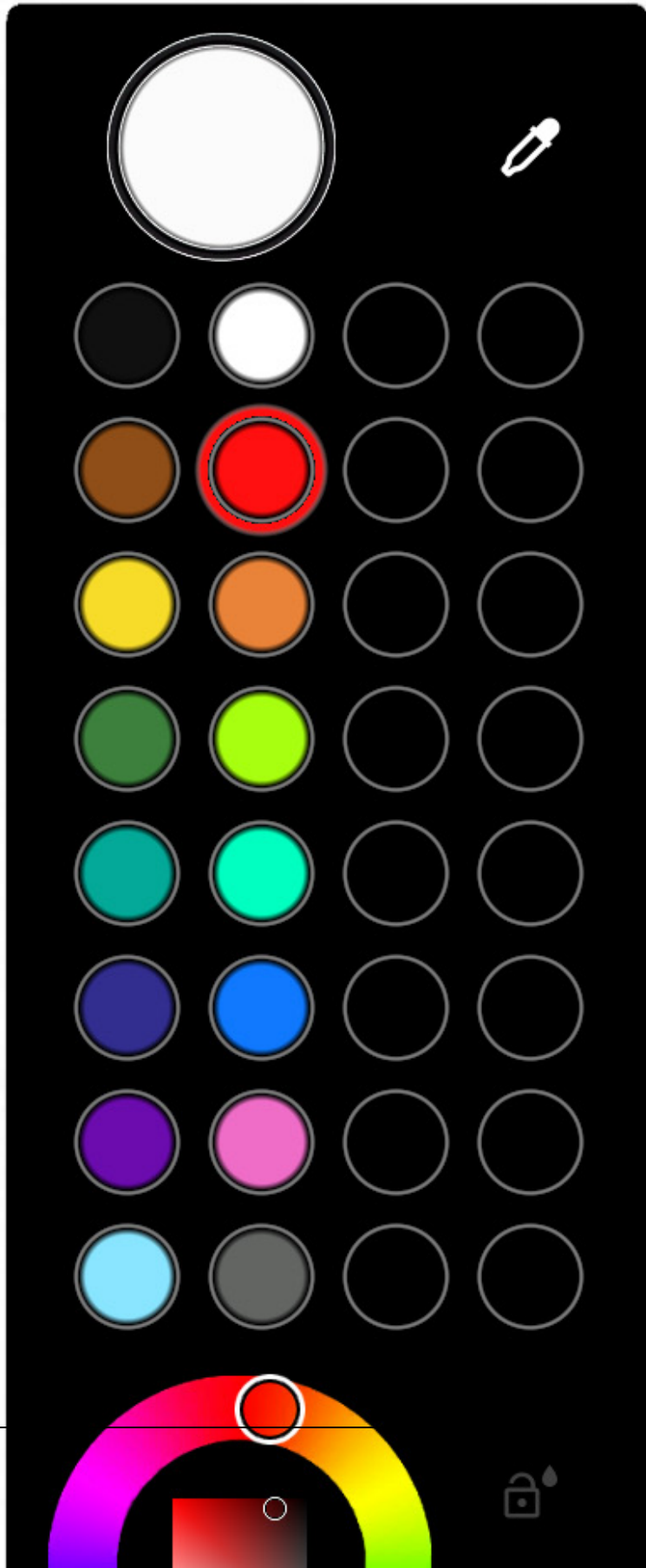

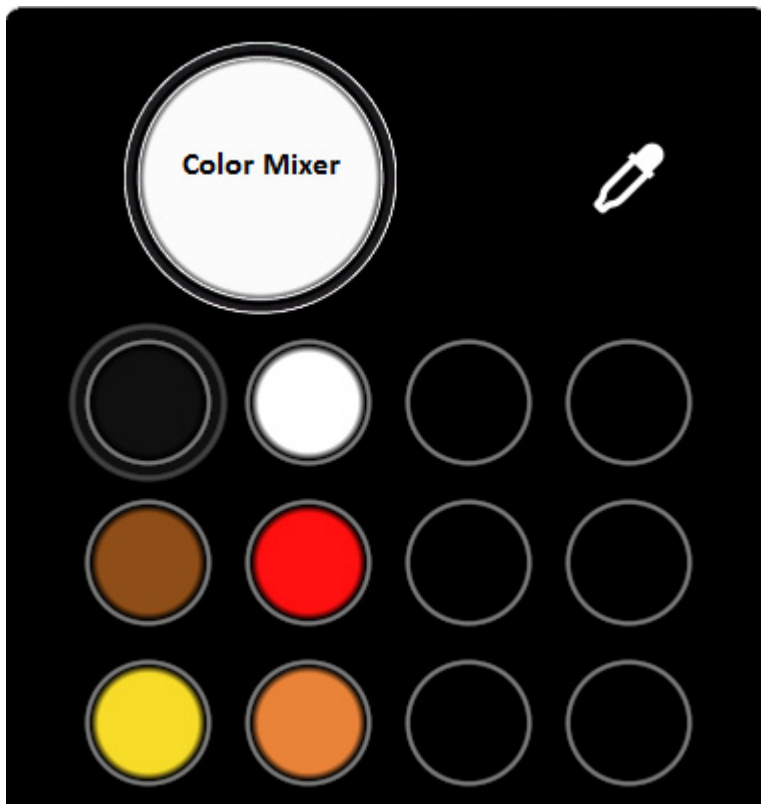

## How to Mix Colors



1. On the **Palette** , tap a color.
2. Touch the Color Mixer and move your finger or stylus in a circle. The new color mixes with the previously selected color. Mix clockwise to add more of the new color or counter-clockwise to retain more of the previous color.
3. Double tap to clear mixer back to white color.

## How to Select RGB Colors

1. On the **Palette** , tap the **RGB** color selector. The **RGB** color slider opens.
2. Tap the **RGB** color that you want.

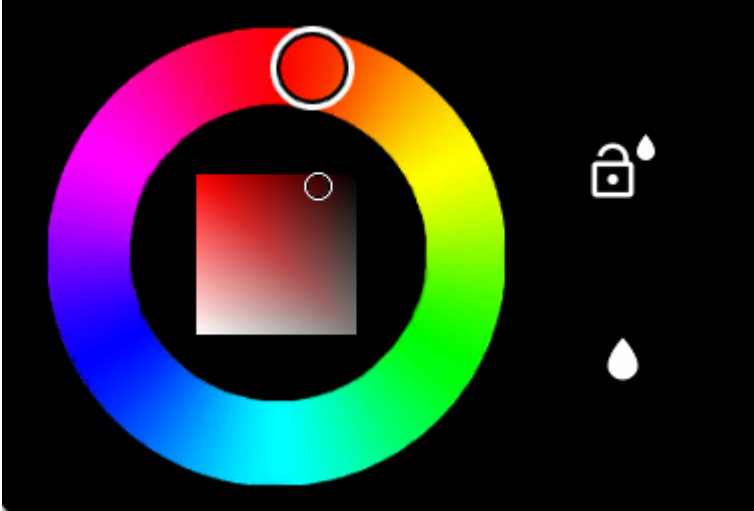

## How to Adjust the Water Level

Dabblr replicates the feel of watercolors by providing adjustable water levels. Water level is only available in Watercolor.

To increase or decrease the wetness of the paint, open the **Palette**



, tap on the droplet  and drag the water level up or down.

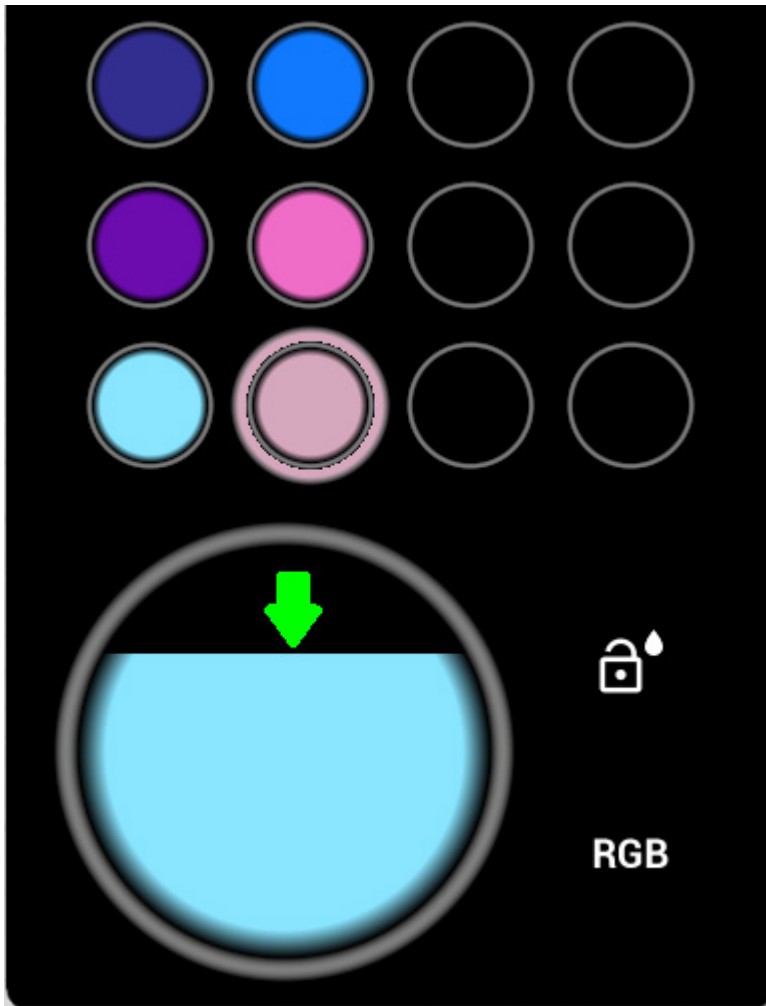

## How to Lock the Water Level

To lock the water level so that the water does not deplete over time, adjust the water level and then tap the lock



## How to Use Shape Recognition

Shape recognition mode detects when you are drawing a circle, square, or other geometric shape and automatically corrects the shape.



In the Toolbar, tap

and **Shape Recognition**

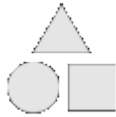

. Tap again to turn off shape recognition.

## How to Use Gravity

Gravity replicates the effect of gravity on watercolor paint. The direction of the pull, or "down," is based on the orientation of your tablet. Gravity is only available in Watercolor.



In the Toolbar, tap  and **Gravity** . Tap again to turn off gravity.

## How to Dry Your Watercolor Instantly

Dabblers replicates the feel of watercolors by allowing the colors to move slowly until the canvas is "dry." Instant-Dry is only available in Watercolor.





In the Toolbar, tap  and **Instant-Dry** .

## How to Add Vector Shapes

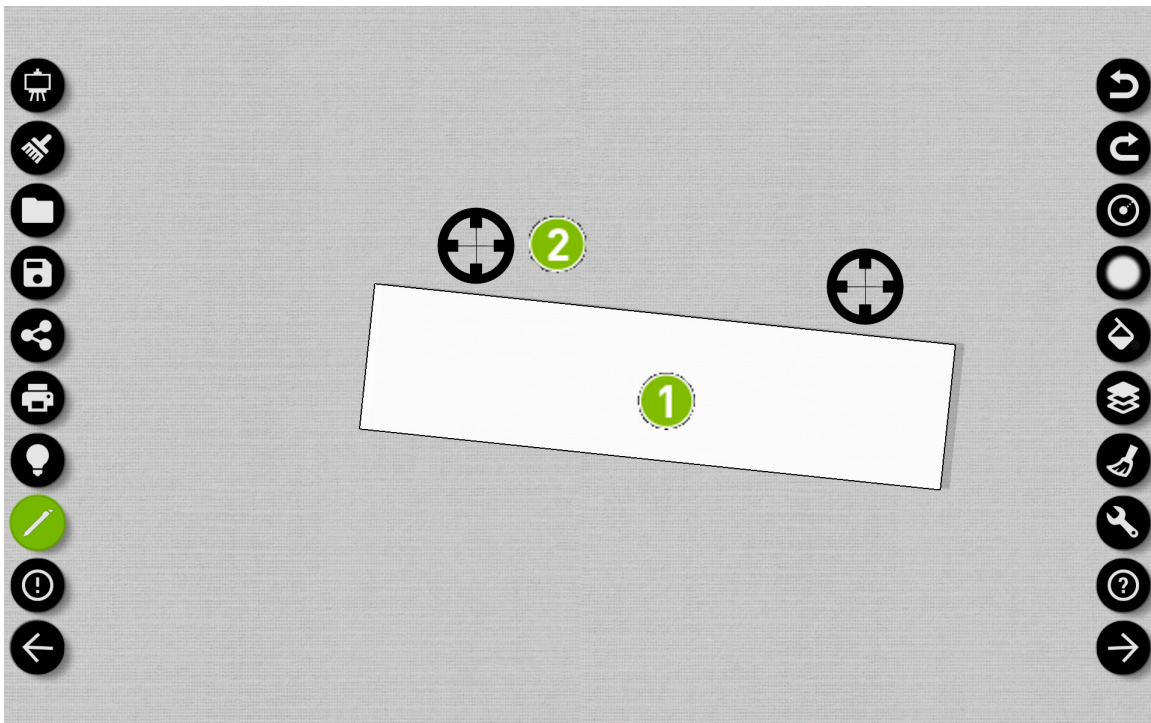

In the Toolbar, tap  and **Vector Shapes** .



	<b>Shape.</b> The vector shape currently in use.
	<b>Toggle / Transform.</b> Tap on a handle to cycle through available vector shapes. Drag a handle to rotate the vector shape about the other handle. Drag both handles to move, scale and rotate the vector shape.

# Layers

## Accessing Layer Operations



To show or hide layer operations, tap **Layers**











Fx



The following table shows the available layer options.

## Layer Tools

	<b>Clear.</b> Clears the layer.
	<b>Camera.</b> Take a picture to be applied as the canvas. Opens the native Camera app.
	<b>Image.</b> Opens <b>Photos</b> to use an existing image as the canvas.
	<b>Paper Selection.</b> Toggles paper selection for background.
	<b>Filter.</b> Swipe through existing filters to be applied to the imported background image.
	<b>Blend.</b> Toggles blending function menu for selected layer.
	<b>Visibility.</b> Toggles visibility of a layer.
	<b>Add.</b> Adds a new layer
	<b>Merge.</b> Merge the selected layer with the next lowest layer.



The slider near the top of the dialog adjusts opacity of the selected layer.

## How to Zoom and Move Canvas



Use a two-finger pinch gesture to zoom the canvas view in and out. A two-finger swipe gesture will move the canvas about the view window.

## Sharing

### Video Recording



1. In the Toolbar, tap **Share** 
2. From the expanded tools, tap **Record** 
3. Select from the following actions:



- To broadcast to Twitch, tap  .
- To **Auto Record**, tap  .
- To **Manual Record**, tap  .
- To take a screenshot, tap **Screenshot**.

## File Sharing

1. In the Toolbar, tap **Share**  .
2. Select from the following actions:

- To share a file in .dab format, tap  .
- To share a file in .jpg format, tap  .

## Global Effects

### How to Dynamically Adjust Lighting

To adjust the light direction on the canvas, tap **Dynamic Lighting**  . A circular slider is shown, which controls the direction of incident light.

### Stylus-Only Mode

To toggle stylus-only mode, tap **Stylus-Only**  . When the stylus-only mode is enabled, finger touches on the canvas are ignored. Only stylus inputs will cause drawing actions. Even when the stylus-mode is enabled, you can still interact with the tools with finger touches.



# SHIELD Legal

## SHIELD LEGAL

### Regulatory

[Health and Safety Information](#)

[SHIELD tablet Compliance](#)

## health and safety information

### important safety information

NVIDIA products are designed to operate safely when installed and used according to the product instructions and general safety practices. The guidelines included in this document explain the potential risks associated with equipment operation and provide important safety practices designed to minimize these risks. By carefully following the information contained in this document you can protect yourself from hazards and create a safer environment.

This product is designed and tested to meet IEC-60950-1, the Standard for Safety of Information Technology Equipment. This also covers the national implementation of IEC-60950-1 based safety standards around the world e.g. UL-60950-1. These standards reduce the risk of injury from the following hazards:

- **Electric shock:** Hazardous voltage levels contained in parts of the product
- **Fire:** Overload, temperature, material flammability
- **Mechanical:** Sharp edges, moving parts, instability
- **Energy:** Circuits with high energy levels (240 volt-amps) or potential as burn hazards
- **Heath:** Accessible parts of the product at high temperatures
- **Chemical:** Chemical fumes and vapors
- **Radiation:** Noise, ionizing, laser, ultrasonic waves

Retain and follow all product safety and operating instructions. Always refer to the documentation supplied with your equipment. Observe all warnings on the product and in the operating instructions.

Read  all safety information below and operating instructions before using the SHIELD tablet to avoid injury.



WARNING: FAILURE TO FOLLOW THESE SAFETY INSTRUCTIONS COULD RESULT IN FIRE, ELECTRIC SHOCK OR OTHER INJURY OR DAMAGE.

ELECTRICAL EQUIPMENT CAN BE HAZARDOUS IF MISUSED. OPERATION OF THIS PRODUCT, OR SIMILAR PRODUCTS, MUST ALWAYS BE SUPERVISED BY AN ADULT. DO NOT ALLOW CHILDREN ACCESS TO THE INTERIOR OF ANY ELECTRICAL PRODUCT AND DO NOT PERMIT THEM TO HANDLE ANY CABLES.

To reduce the risk of bodily injury, electric shock, fire, and damage to the equipment, observe the safety labels included on the equipment.

## symbols on equipment

This symbol in conjunction with any of the following symbols indicates the presence of a potential hazard. The potential for injury exists if warnings are not observed. Consult your documentation for specific details.



This symbol indicates the presence of hazardous energy circuits or electric shock hazards. Refer all servicing to qualified personnel.



WARNING: To reduce the risk of injury from electric shock hazards, do not open this enclosure. Refer all maintenance, upgrades, and servicing to qualified personnel.

## Headset/Earphone volume level notice



WARNING: To prevent possible hearing damage, do not listen at high volume levels for long periods.

## general precautions

To reduce the risk of electric shock, personal injury, or damage to the equipment, observe the following precautions:

- Follow all cautions and instructions marked on the equipment.
- Do not bend, drop, crush, puncture, incinerate, or push objects into openings of the gaming console.
- Do not connect or disconnect any cables or perform maintenance or reconfiguration of this product during an electrical storm.
- Do not use the SHIELD tablet in rain or near sink, or other wet locations. Take care not to spill any food or liquid into the console. In case the SHIELD tablet gets wet, unplug all cables and turn off before cleaning, and allow it to dry thoroughly before turning it on again.
- Do not expose the SHIELD tablet to any gas which is not normally contained in the atmosphere. It may cause mis-operation or defects.
- Never turn on any equipment when there is evidence of fire, water, or structural damage.
- Place the product away from radiators, heat registers, stoves, amplifiers, or other appliances that produce heat.

- Never force a connector into a port. Check for obstructions on the port. If the connector and port don't join with reasonable ease, they probably don't match. Make sure that the connector matches the port and that you have positioned the connector correctly in relation to the port.
- If you use an AC Power Adapter to charge the gaming console, make sure the power adapter is fully assembled before you plug it into a power outlet. Then insert the AC Power Adapter firmly into the power outlet. Do not connect or disconnect the AC Power Adapter with wet hands.
- Operate the AC adapter in a ventilated area.
- When you are using the NVIDIA SHIELD tablet or charging the battery, it is normal for the system and/or AC power adapter to get warm.
- Do not use conductive tools that could bridge live parts.
- Do not make mechanical or electrical modifications to the equipment.
- Never attempt to repair the SHIELD tablet yourself. This device does not contain any user-serviceable parts. Do not attempt to open, disassemble, or remove the battery. You run the risk of electric shock.
- To clean the display, use a soft, lint-free cloth. If necessary, breathe upon the display surface and wipe off immediately and softly. Avoid getting moisture in openings. Don't use window cleaners, household cleaners, aerosol sprays, solvents, alcohol, ammonia, or abrasives to clean the display.
- Operate the SHIELD tablet in a place where the temperature is always between 5 and 30°C (41 to 86°F).
- Store the SHIELD tablet in a place where the temperature is always between 0 and 35°C (32 to 95°F) with relative humidity of 70% or lower. When taking the device from a low temperature condition, allow the device to reach room temperature before turning the power on.
- Use this product only with approved equipment and/or accessories
- If the product sustains damage requiring service, disconnect the product from the AC electrical outlet and refer servicing to an NVIDIA authorized service provider.



**LITHIUM BATTERY WARNING:** THIS GAMING DEVICE CONTAINS A NON-USER-SERVICEABLE LITHIUM-ION BATTERY PACK. THERE IS RISK OF EXPLOSION, FIRE, BURN OR LEAKING WHICH CAN BE CAUSED BY IMPROPER CHARGING, SHORTING OF THE BATTERY PACK, CRASH DAMAGE OR OTHER MISUSE. ALWAYS USE CHARGERS DESIGNED SPECIFICALLY FOR USE WITH THIS GAMING DEVICE. DO NOT ATTEMPT TO DISASSEMBLE, REPLACE, OR OTHERWISE ATTEMPT TO ACCESS THE BATTERY PACK. CONTACT NVIDIA CUSTOMER SUPPORT FOR REPAIR OR REPLACEMENT INFORMATION. RECYCLE THE DEVICE ACCORDING TO LOCAL RULES AND REGULATIONS. CONTACT YOUR LOCAL WASTE DISPOSAL/RECYCLE FACILITY.

## POWER RATING

5-16 V DC, 2 A

# SHIELD Tablet Compliance

The NVIDIA SHIELD tablet is compliant with the regulations that are listed in this section.

Additional regulatory information including FCC and IC IDs can be found in SHIELD TABLET by going to **Apps > Settings > About tablet > Regulatory Information**

## United States

### Federal Communications Commission (FCC)



**FCC ID: VOB-P1761WX (P/N 940-81761-2500-xxx WIFI)**

**FCC ID: VOB-P1761WX CONTAINS FCC ID: VOB-E1729 (P/N 940-81761-2500-xxx LTE)**

This device complies with part 15 of the FCC Rules. Operation is subject to the following two conditions: (1) this device may not cause harmful interference, and (2) this device must accept any interference received, including any interference that may cause undesired operation of the device.

This equipment has been tested and found to comply with the limits for a Class B digital device, pursuant to Part 15 of the FCC Rules. These limits are designed to provide reasonable protection against harmful interference in a residential installation. This equipment generates, uses and can radiate radio frequency energy and, if not installed and used in accordance with the instructions, may cause harmful interference to radio communications. However, there is no guarantee that interference will not occur in a particular installation.

If this equipment does cause harmful interference to radio or television reception, which can be determined by turning the equipment off and on, the user is encouraged to try to correct the interference by one or more of the following measures:

- Reorient or relocate the receiving antenna.
- Increase the separation between the equipment and receiver.
- Connect the equipment into an outlet on a circuit different from that to which the receiver is connected.
- Consult the dealer or an experienced radio/TV technician for help.

**FCC Warning:** The FCC requires that you be notified that any changes or modifications to this device not expressly approved by the manufacturer could void the user's authority to operate the equipment.

**Caution:** Within the 5.15 to 5.25 GHz band (5 GHz radio channels 34 to 48) this device is restricted to indoor operations to reduce any potential for harmful interference to co-channel Mobile Satellite System (MSS) operation

### RF Radiation Exposure Statement:

The SHIELD tablet has been tested and complies with FCC RF radiation exposure limits set forth for an uncontrolled environment when used with the NVIDIA accessories supplied or designated for this product. During testing, the SHIELD tablet was placed in positions that simulate use against the body. The use of any other accessories may not ensure compliance with FCC RF exposure guidelines.

### Underwriters Laboratories (UL)



I.T.E E204896

## California Energy Commission (CEC)



## Canada

### Industry Canada (IC)

IC: 7361A-P1761W (P/N 940-81761-2500-xxx WIFI)

IC: 7361A-P1761W CONTAINS IC: 7361A-E1729 (P/N 940-81761-2500-xxx LTE)

#### CAN ICES-3(B)/NMB-3(B)

This device complies with RSS-210 of the Industry Canada Rules. Operation is subject to the following two conditions: (1) this device may not cause interference, and (2) this device must accept any interference, including interference that may cause undesired operation of the device.

Ce dispositif est conforme à la norme CNR-210 d'Industrie Canada applicable aux appareils radio exempts de licence. Son fonctionnement est sujet aux deux conditions suivantes: (1) le dispositif ne doit pas produire de brouillage préjudiciable, et (2) ce dispositif doit accepter tout brouillage reçu, y compris un brouillage susceptible de provoquer un fonctionnement indésirable.

#### RF Radiation Exposure Statement:

SHIELD tablet has been tested and complies with IC RSS 102 RF radiation exposure limits set forth for an uncontrolled environment when used with the NVIDIA accessories supplied or designated for this product. During testing, the SHIELD tablet was placed in positions that simulate use against the body. The use of any other accessories may not ensure compliance with IC RSS 102 RF exposure guidelines.

#### Déclaration d'exposition aux radiations:

La tablette SHIELD a été testée conformément aux normes d'exposition d'émission RF de la IC RSS 102 pour un environnement non contrôlé lors d'utilisation avec les accessoires fournis ou recommandés par NVIDIA. Pendant les tests, la tablette SHIELD a été positionnée afin de simuler la présence du corps humain. L'utilisation d'accessoires autres que ceux recommandés par NVIDIA ne garantit pas la compatibilité avec les normes d'émission RF de la IC RSS 102.

## Europe

### European Conformity Conformité Européenne (CE)

(P/N 940-81761-2505-xxx)



This device bears the CE mark and class-2 identifier in accordance with Directive 1999/5/CE

This device complies with the following Directives:

- R&TTE Directive for radio equipment

- Low Voltage Directive for electrical safety
- RoHS Directive for hazardous substances

A copy of the Declaration of Conformity to the essential requirements may be obtained directly from NVIDIA GmbH (Flossergasse 2, 81369 Munich, Germany).

## Japan

Voluntary Control Council for Interference (VCCI)



Translation:

This is a Class B product based on the standard of the VCCI Council. If this is used near a radio or television receiver in a domestic environment, it may cause radio interference. Install and use the equipment according to the instruction manual.

## Radio / Telecommunications Certification



R 211-140701

## Li-ion Battery



## Australia/New Zealand

Australian Communications and Media Authority (C-tick)



This product meets the applicable EMC requirements for Class B, I.T.E. equipment and applicable radio equipment requirements.

## Russia/kazakhstan/belarus

EurAsian Customs Union

(P/N 940-81761-2505-xxx)





Complies with the technical limitations of the Customs Union (CU TR)

The device complies with the rules set forth by Federal Agency of Communications and the Ministry of Communications and Mass Media.

Federal Security Service notification has been filed.

## South Korea

Radio Research Agency (RRA)

Korean Agency for Technology and Standards (KATS)



MSIP-CMM-NVA-P1761W

XU100277-14001A

B급 기기  
(가정용 방송 통신기자재)

이 기기는 가정용(B급) 전자파적합기기로서 주로 가정에서 사용하는 것을 목적으로 하며, 모든 지역에서 사용할 수 있습니다.

Translation:

Class B Equipment (For Home Use Broadcasting & Communication Equipment)

This equipment is home use (Class B) electromagnetic wave suitability equipment and to be used mainly at home and it can be used in all areas.

## Bluetooth



## Wi-Fi Alliance



## notices and trademarks

The information provided in this document is believed to be accurate and reliable as of the date provided. However, NVIDIA Corporation ("NVIDIA") does not give any representations or warranties, expressed or implied, as to the accuracy or completeness of such information. NVIDIA shall have no liability for the consequences or use of such information or for any infringement of patents or other rights of third parties that may result from its use. This publication supersedes and replaces all other specifications for the product that may have been previously supplied.

NVIDIA reserves the right to make corrections, modifications, enhancements, improvements, and other changes to this specification, at any time and/or to discontinue any product or service without notice. Customer should obtain the latest relevant specification before placing orders and should verify that such information is current and complete.

NVIDIA products are sold subject to the NVIDIA standard terms and conditions of sale supplied at the time of order acknowledgment, unless otherwise agreed in an individual sales agreement signed by authorized representatives of NVIDIA and customer. NVIDIA hereby expressly objects to applying any customer general terms and conditions with regard to the purchase of the NVIDIA product referenced in this specification.

NVIDIA products are not designed, authorized or warranted to be suitable for use in medical, military, aircraft, space or life support equipment, nor in applications where failure or malfunction of the NVIDIA product can reasonably be expected to result in personal injury, death or property or environmental damage. NVIDIA accepts no liability for inclusion and/or use of NVIDIA products in such equipment or applications and therefore such inclusion and/or use is at customer's own risk.

NVIDIA makes no representation or warranty that products based on these specifications will be suitable for any specified use without further testing or modification. Testing of all parameters of each product is not necessarily performed by NVIDIA. It is customer's sole responsibility to ensure the product is suitable and fit for the application planned by customer and to do the necessary testing for the application in order to avoid a default of the application or the product.

Weaknesses in customer's product designs may affect the quality and reliability of the NVIDIA product and may result in additional or different conditions and/or requirements beyond those contained in this specification. NVIDIA does not accept any liability related to any default, damage, costs or problem which may be based on or attributable to: (i) the use of the NVIDIA product in any manner that is contrary to this specification, or (ii) customer product designs.

No license, either expressed or implied, is granted under any NVIDIA patent right, copyright, or other NVIDIA intellectual property right under this specification. Information published by NVIDIA regarding third-party products or services does not constitute a license from NVIDIA to use such products or services or a warranty or endorsement thereof. Use of such information may require a license from a third party under the patents or other intellectual property rights of the third party, or a license from NVIDIA under the patents or other intellectual property rights of NVIDIA. Reproduction of information in this specification is permissible only if reproduction is approved by NVIDIA in writing, is reproduced without alteration, and is accompanied by all associated conditions, limitations, and notices.

ALL NVIDIA DESIGN SPECIFICATIONS, REFERENCE BOARDS, FILES, DRAWINGS, DIAGNOSTICS, LISTS, AND OTHER DOCUMENTS (TOGETHER AND SEPARATELY, "MATERIALS") ARE BEING PROVIDED "AS IS." NVIDIA MAKES NO WARRANTIES, EXPRESSED, IMPLIED, STATUTORY, OR OTHERWISE WITH RESPECT TO THE MATERIALS, AND EXPRESSLY DISCLAIMS ALL IMPLIED WARRANTIES OF NONINFRINGEMENT, MERCHANTABILITY, AND FITNESS FOR A PARTICULAR PURPOSE. Notwithstanding any damages that customer might incur for any reason whatsoever, NVIDIA's aggregate and cumulative liability towards customer for the products described herein shall be limited in accordance with the NVIDIA terms and conditions of sale for the product.

### HDMI

HDMI, the HDMI logo, and High-Definition Multimedia Interface are trademarks or registered trademarks of HDMI Licensing LLC.

### ARM

ARM, AMBA and ARM Powered are registered trademarks of ARM Limited. Cortex, MPCore and Mali are trademarks of ARM Limited. All other brands or product names are the property of their respective holders. "ARM" is used to represent ARM Holdings plc; its operating company ARM Limited; and the regional subsidiaries ARM Inc.; ARM KK; ARM Korea Limited.; ARM Taiwan Limited; ARM France SAS; ARM Consulting (Shanghai) Co. Ltd.; ARM Germany GmbH; ARM Embedded Technologies Pvt. Ltd.; ARM Norway, AS and ARM Sweden AB.

### OpenCL

OpenCL is a trademark of Apple Inc. used under license to the Khronos Group Inc.

### Trademarks

NVIDIA, the NVIDIA logo, GeForce, and SHIELD are trademarks and/or registered trademarks of NVIDIA Corporation in the U.S. and other countries. Other company and product names may be trademarks of the respective companies with which they are associated.

Google, Android, and Gmail are trademarks and/or registered trademarks of Google Inc.

The Bluetooth® word, mark, and logos are registered trademarks owned by Bluetooth SIG, Inc. and any use of such marks is under license.

Wi-Fi CERTIFIED and Wi-Fi CERTIFIED Miracast are registered marks of the Wi-Fi Alliance.

Steam is a trademark of Valve.

Other trademarks and trade names are those of their respective owners.

**Copyright**

© 2015 NVIDIA Corporation. All rights reserved.